



ARKANSAS

ENERGY & ENVIRONMENT

June 21, 2023

Via email to: philipantici@ffcmail.com & First Class Mail

Philip Antici
HSES Manager
FutureFuel Chemical Company
PO Box 5357
Batesville, AR 72503

Re: Notice of Final Permitting Decision; Permit No. 1085-AOP-R16

Dear Mr. Antici,

After considering the application and other applicable materials as required by APC&EC Rule 8.211 and Ark. Code Ann. § 8-4-101 *et seq.*, this notice of final permitting decision is provided for:

FutureFuel Chemical Company
2800 Gap Road
Batesville, AR 72501

Permit Number: 1085-AOP-R16

Permitting Decision: approval with permit conditions as set forth in final Permit No. 1085-AOP-R16

Accessing the Permitting Decision:

<https://www.adeq.state.ar.us/downloads/WebDatabases/PermitsOnline/Air/1085-AOP-R16.pdf>.

Accessing the Statement of Basis:

<https://www.adeq.state.ar.us/downloads/WebDatabases/PermitsOnline/Air/1085-AOP-R16-SOB.pdf>.

Rule 26.903 of the Rules of the Arkansas Operating Air Permit Program do not require a public notice or public comment period for Administrative Amendments.

Sincerely,

A handwritten signature in blue ink, appearing to read "Dw", with a long horizontal flourish extending to the right.

David Witherow, P.E.
Associate Director, Office of Air Quality, Division of Environmental Quality
5301 Northshore Drive, North Little Rock, AR 72118-5317

Enclosure: Certificate of Service
cc: lynncornelius@ffcmail.com

CERTIFICATE OF SERVICE

I, Natasha Oates, hereby certify that the final permit decision notice has been mailed by first class mail to FutureFuel Chemical Company, PO Box 5357, Batesville, AR, 72503, on this 21st day of June, 2023.

Natasha Oates

Natasha Oates, AA, Office of Air Quality



DIVISION OF ENVIRONMENTAL QUALITY

OPERATING AIR PERMIT

PERMIT NUMBER: 1085-AOP-R16

IS ISSUED TO:

FutureFuel Chemical Company
2800 Gap Road
Batesville, AR 72501
Independence County
AFIN: 32-00036

PURSUANT TO THE REGULATIONS OF THE ARKANSAS OPERATING AIR PERMIT PROGRAM, REGULATION 26: THIS PERMIT AUTHORIZES THE ABOVE REFERENCED PERMITTEE TO INSTALL, OPERATE, AND MAINTAIN THE EQUIPMENT AND EMISSION UNITS DESCRIBED IN THE PERMIT APPLICATION AND ON THE FOLLOWING PAGES. THIS PERMIT IS VALID BETWEEN:

November 29, 2018 AND November 28, 2023

THE PERMITTEE IS SUBJECT TO ALL LIMITS AND CONDITIONS CONTAINED HEREIN.

Signed:

A handwritten signature in blue ink, appearing to read "Dau", is written over a horizontal line.

David Witherow, P.E.
Associate Director, Office of Air Quality
Division of Environmental Quality

June 21, 2023

Date

Table of Contents

SECTION I: FACILITY INFORMATION	5
SECTION II: INTRODUCTION	6
Summary of Permit Activity	6
Process Description	6
Regulations	9
Emission Summary	11
SECTION III: PERMIT HISTORY	18
SECTION IV: SPECIFIC CONDITIONS	27
Organic Chemical Intermediates.....	27
40 CFR 63 Subpart GGG - National Emission Standards for Pharmaceutical Production ..	29
40 CFR Part 63, Subpart MMM, National Emission Standards for Pesticide Active Ingredient Production.....	52
Utilities.....	85
40 CFR Part 60 Subpart Db - Standards of Performance for Industrial-Commercial- Institutional Steam Generating Units.....	89
40 CFR Part 63 Subpart DD - National Emission Standards for Hazardous Air Pollutants from Off-Site Waste and Recovery Operations	90
40 CFR Part 60 Subpart Y - Standards of Performance for Coal Preparation Plants.....	91
40 CFR Part 63 Subpart EEE - National Emission Standards for Hazardous Air Pollutants from Hazardous Waste Combustors	91
40 CFR Part 63 Subpart DDDDD—National Emission Standards for Hazardous Air Pollutants for Major Sources: Industrial, Commercial, and Institutional Boilers and Process Heaters	105
Organic Sulfonation Process.....	111
40 CFR Part 60 Subpart NNN - Manufacturing Industry (SOCMI) Distillation Operations	115
Chemical Waste Destructor	139
40 CFR Part 63 Subpart EEE - National Emission Standards for Hazardous Air Pollutants from Hazardous Waste Combustors	140
Solvent Recovery	156
Wastewater Treatment Facility	158
Isopropyl Benzene Production (DIPB)	160
40 CFR Part 61 Subpart FF - NESHAP for Benzene Waste Operations.....	161
40 CFR Part 61 Subpart V - National Emission Standard for Equipment Leaks (Fugitive Emission Sources).....	162
40 CFR Part 61 Subpart J – National Emission Standard for Equipment Leaks (Fugitive Emission Sources of Benzene	187
40 CFR Part 61 Subpart Y - National Emission Standard for Benzene Storage Vessels ...	187

FutureFuel Chemical Company
 Permit #: 1085-AOP-R16
 AFIN: 32-00036

Storage Tanks and Miscellaneous Sources	188
5N07 Production Facility	191
Aldehyde Processing Section.....	193
40 CFR Part 63 Subpart DDDDD—National Emission Standards for Hazardous Air Pollutants for Major Sources: Industrial, Commercial, and Institutional Boilers and Process Heaters	195
Anode Material Process	201
Emergency Generators.....	203
Plantwide Sources Subject to MON	215
SECTION V: COMPLIANCE PLAN AND SCHEDULE	224
SECTION VI: PLANTWIDE CONDITIONS	225
Acid Rain (Title IV).....	229
Title VI Provisions	230
SECTION VII: INSIGNIFICANT ACTIVITIES.....	234
SECTION VIII: GENERAL PROVISIONS	236
Appendix A – CEMS Requirements	
Appendix B - 40 CFR Part 63 Subpart MMM	
Appendix C – 40 CFR Part 60 Subpart Kb	
Appendix D – 40 CFR Part 60 Subpart Y	
Appendix E – 40 CFR Part 60 Subpart VV	
Appendix F – 40 CFR Part 60 Subpart NNN	
Appendix G – 40 CFR Part 61 Subpart J	
Appendix H – 40 CFR Part 61 Subpart V	
Appendix I – 40 CFR Part 61 Subpart Y	
Appendix J – 40 CFR Part 61 Subpart FF	
Appendix K – 40 CFR Part 63 Subpart DD	
Appendix L – 40 CFR Part 63 Subpart EEE (Phase I and II)	
Appendix M – 40 CFR Part 63 Subpart FFFF	
Appendix N – Notification of Compliance (NOC) – Boilers and Incinerator	
Appendix O – 40 CFR 63 Subpart ZZZZ	
Appendix P – 40 CFR 63 Subpart DDDDD	
Appendix Q – 40 CFR 60 Subpart JJJJ	

FutureFuel Chemical Company
Permit #: 1085-AOP-R16
AFIN: 32-00036

List of Acronyms and Abbreviations

Ark. Code Ann.	Arkansas Code Annotated
AFIN	Arkansas DEQ Facility Identification Number
C.F.R.	Code of Federal Regulations
CO	Carbon Monoxide
COMS	Continuous Opacity Monitoring System
HAP	Hazardous Air Pollutant
Hp	Horsepower
lb/hr	Pound Per Hour
NESHAP	National Emission Standards (for) Hazardous Air Pollutants
MVAC	Motor Vehicle Air Conditioner
No.	Number
NO _x	Nitrogen Oxide
NSPS	New Source Performance Standards
PM	Particulate Matter
PM ₁₀	Particulate Matter Equal To Or Smaller Than Ten Microns
PM _{2.5}	Particulate Matter Equal To Or Smaller Than 2.5 Microns
SNAP	Significant New Alternatives Program (SNAP)
SO ₂	Sulfur Dioxide
SSM	Startup, Shutdown, and Malfunction Plan
Tpy	Tons Per Year
UTM	Universal Transverse Mercator
VOC	Volatile Organic Compound

FutureFuel Chemical Company
Permit #: 1085-AOP-R16
AFIN: 32-00036

SECTION I: FACILITY INFORMATION

PERMITTEE: FutureFuel Chemical Company

AFIN: 32-00036

PERMIT NUMBER: 1085-AOP-R16

FACILITY ADDRESS: 2800 Gap Road
Batesville, AR 72501

MAILING ADDRESS: 2800 Gap Road
Batesville, AR 72501

COUNTY: Independence County

CONTACT NAME: Philip Antici

CONTACT POSITION: HSES Manager

TELEPHONE NUMBER: (870) 698-5563

REVIEWING ENGINEER: Christopher Riley

UTM North South (Y): Zone 15: 3954180.53 m

UTM East West (X): Zone 15: 633409.13 m

SECTION II: INTRODUCTION

Summary of Permit Activity

FutureFuel Chemical Company, located in Batesville, Arkansas, is a supplier of specialty organic chemical intermediates used in the manufacture of color film and photographic paper, paints and coatings, plastics and bottle polymers, medical supplies, prescription medicines, food supplements, household detergents, agricultural products, and biofuel. This application was submitted as a minor modification to Permit No. 1085-AOP-R15:

- Add a natural gas emergency engine (SN-4P-EG-01) to the permit. SN-4P-EG-01 is subject to 40 C.F.R. Part 63, Subpart ZZZZ and 40 C.F.R. Part 60, Subpart JJJJ.

Permitted emission increases are 0.1 tpy SO₂, PM, PM₁₀, VOC, NO_x and Organic Pollutants as well as 0.4 tpy of CO.

Process Description

Organic Chemical Intermediates Section (OCI)

FutureFuel's batch organic chemical intermediates facilities are located in Buildings 5N01, 5N03, and 5N07. These production buildings contain multi-purpose/product equipment which may produce a variety of chemicals. The contained or captured vapors from the equipment in the three batch production buildings are vented through a collection system to the RTO units via a common duct. Volatile organic compounds (VOCs) are destroyed by combustion. Fugitive emissions from organic chemical intermediates are designated as source number OCI-FUG. Two other TOs (SN-5N09-02 and SN-5N09-03) are also present, but in conjunction with a caustic scrubber. Fugitive emissions are designated as source OCI-FUG.

Utilities (US)

There are three coal fired (6M01-01) and two natural gas fired boilers (6M06-01 and 6M07-01) at the facility. The coal fired boilers are balanced draft, coal-fired steam generation boilers that have been fitted with atomizing nozzles to facilitate burning of liquid chemical wastes. Each coal fired boiler system is designed as a 70 million Btu/hr unit and is equipped with its own electrostatic precipitator (ESP) to control particulate emissions. The spent solvent from the 2,000 gallon liquid process tank to be used for the purpose of flushing the chemical distribution piping is routed to either the coal-fired boiler auxiliary waste chemical burners or to the burner of the chemical waste destructor. Emissions from tank venting are collected and routed to the coal-fired boilers (6M01-01). There are also two natural gas fired boilers at the facility. The #4 boiler (6M06-01) burns natural gas at 78 million BTU/hr. The #5 boiler (6M07-01) burns natural gas at 221 million BTU/hr. These natural gas burning sources do not have control devices. Utility fugitive emissions are accounted for in the BLR-FUG source.

Organic Sulfonation (OSP)

FutureFuel Chemical Company
Permit #: 1085-AOP-R16
AFIN: 32-00036

The organic sulfonate facility produces a solid material for use as a household consumer product. The two organic sulfonation facilities include reactors, centrifuges, scrubbers, distillation equipment, raw materials and process tanks. Scrubbers are the primary means for controlling emissions from the production facilities. The low vapor pressures of the contents of the storage tanks minimize the potential for VOC emissions from these emission points, but there are fugitive emissions taken into account from the processes. Equipment from this section is typically notated with 5M in the source name. The 5MNOBS-TNK source is a bubble consisting of four tanks. VOC fugitive emissions are accounted for in NOBS-FUG, while particulate fugitives are accounted for within 5M01-TSP.

Chemical Waste Destructor (CWD)

The chemical waste destructor at FutureFuel Chemical Company is designed to burn a mixture of waste streams resulting from various fine chemical manufacturing facilities at the plant. Some of the waste is mainly organic solvents, but the majority is comprised of aqueous solutions containing some organic and salt compounds. The equipment used to burn the waste includes a burner assembly, oxidizer chamber, weir tank, quench separator tank, high-energy scrubber, vane separator, and a stack. The chemical destructor is a vertically down fired unit. Emissions were calculated for the incinerator (6M03-05) and for fugitive equipment leaks (DEST-FUG). The chemical waste destructor is subject to 40 CFR Part 63, Subpart EEE, *National Emission Standards for Hazardous Air Pollutants from Hazardous Waste Combustors*.

Solvent Recovery (SR)

Solvent Recovery equipment is designed to recover solvents that become contaminated during the manufacturing processes. Individual streams from the chemical manufacturing processes are transferred to storage tanks in the solvent recovery area. These streams are pumped to a pH adjustment system and then to a series of distillation columns. After distillation, the solvents are reused in the manufacturing processes or are sold for other uses. Process emissions from the Solvent Recovery Facility are controlled with Regenerative Thermal Oxidizers (RTOs), 5N09-01 and designated as 4PSR-00. Fugitives from this section are SR-FUG.

Wastewater Treatment Facility (WWT)

The Wastewater Treatment Plant (WWT) treats process wastewater from various areas of the plant, sanitary sewage, and some storm water. The wastewater treatment system is an extended aeration activated sludge design consisting of equalization and neutralization, aeration, and clarification. The excess biomass is aerobically digested and either land applied on-site via a spray irrigation system, dewatered and burned in the coal-fired boilers, or landfilled. A diversion tank is used to reduce organic or hydraulic peaks in the untreated wastewater. Sources in this section include WWT Facilities (7K01-01), a Decant Tank (7M01-02), two pH control tanks (7M01-03 and 7M01-03B), and a WWT chemical tank (7M01-04).

Isopropyl Benzene Section (IB)

FutureFuel Chemical Company
Permit #: 1085-AOP-R16
AFIN: 32-00036

Future Fuel Chemical Companies (FFCC) Isopropyl Benzene Production facilities are located in building 5N03 and in a large distillation complex located east of 5N03. The isopropyl benzene process consists of alkylation of benzene with propylene. A catalyst is used to promote the reaction. 5N03-48 and 5N03-55 are scrubbers associated with the DIPB process and vent to the atmosphere. 5N03-48, is a water scrubber that is located on the vent discharge of an Aluminum Chloride baghouse. 5N03-55 is a water scrubber that receives vapor off of a tank containing an Aluminum Chloride solution. Additional sources in this section are a large tank bubble (10 tanks, 5NDIPB-TNK), a Flare (5N03-54), and Fugitive Emissions from Isopropyl Benzene Process (DIPB-FUG).

5N07 Production Facility (BD)

The 5N07 production facility contains multi-purpose production equipment which may produce a variety of chemicals including biofuel. Biodiesel is the primary product from this facility. The contained or captured vapors from the equipment in this facility are vented through a collection system to the RTO (SN 5N09-01) units via a common duct. Two methanol tanks (T-242 and T-243) are in this area. Emissions from these tanks are accounted for in tank bubble 5N03TK-01. All emissions from Biodiesel Refining and Methanol Recovery, Material Storage, Glycerol Refining, and Fugitive Emissions are part of the 5N07 emission source.

Storage Tanks and Miscellaneous Sources (STMS)

Many different chemicals can be manufactured; therefore many tanks are needed for raw material, intermediate, and product storage. Emissions from storage tanks that vent to the atmosphere and other miscellaneous sources are identified in the STMS section of the permit. With the exception of a fume scrubber TF-5FS on TF-5, there are no specific controls on these tanks other than conservation vents.

Sources in this section include a Diesel Tank (6N01-02), a Gasoline Tank (6N01-03), and several process tanks, 5N03TK-01.

Aldehyde Processing Section (AP)

Raw materials are unloaded into storage tanks T-271, T-272, and TFS-75. TFS-75 vents to the RTO. Raw materials are transferred to the process as needed. Both columns and tanks vent to the RTOs (5N09-01).

The aldehyde process reactors are periodically cleaned and the vent gas is routed to a water scrubber, SV-03. The vent stream from this source discharges to the RTO. The water stream is routed to the wastewater treatment facilities. The reactors are heated with two 5 MMBTU/hr hot oil system, SN 4P05-01 and SN 4P05-03. The hot oil system SN 4P05-01 is designed to burn natural gas, fuel oil, biodiesel, and process vent streams. Hot oil system SN 4P05-03 is designed to burn natural gas and process vent streams.

FutureFuel Chemical Company
 Permit #: 1085-AOP-R16
 AFIN: 32-00036

Products are refined in distillation column SB-02 and extraction column SX-03. The distillation column and the extraction column both vent back to the hot oil system or the RTOs. The refined product is transferred to three lot tanks, VC-PT-01, VC-PT-02, and VC-PT-03. These tanks are equipped with vapor balancing and do not vent to the atmosphere. VC-ST-01 shutdown tank vents to the hot oil system for thermal recovery and is not an emission source itself. Tank WDT-03, a waste tank, is located in the Utilities section and is connected to the coal-fired boiler closed vent system and control device. VC-PT-03, VC-PT-01, and VC-PT-02 are all subject to NSPS Kb.

The emission points for the Aldehyde Processing Section are the hot oil system (4P05-01), hot oil system (4P05-03), equipment fugitives (4PSR-FUG), and the RTO (5N09-01).

Anode Material Process (CP2)

The Anode Material Process (CP2), permitted as CP-2, consists of solids handling equipment, continuous stirred tank reactors, and dryers. Pelletized and granular material will be fed through a metering system into vessels where the material is heated and mixed. The formulated material is then dried and repackaged. All of this equipment is located inside the 5M11 building. Dust from all of the solids handling equipment is vented to a continuous dust control system (CDCS), 5M11-08. The CDCS consists of a baghouse for solid particle separation, a collection hopper, and an induced draft fan. A central vacuum cleaning system (CVC), 5M11-09 will be used to clean spills. All VOC vents will be routed to the RTOs, 5N09-01. Emissions from tanks and equipment containing VOC vent to the thermal oxidizer SN-5N09-01.

Regulations

The following table contains the regulations applicable to this permit.

Regulations
Arkansas Air Pollution Control Code, Regulation 18, effective March 14, 2016
Rules of the Arkansas Plan of Implementation for Air Pollution Control, Rule 19, effective May 6, 2022
Regulations of the Arkansas Operating Air Permit Program, Regulation 26, effective March 14, 2016
40 CFR 52.21- Prevention of Significant Deterioration of Air Quality (PSD).
40 CFR Part 63 Subpart GGG - National Emission Standards Pharmaceuticals Production
40 CFR Part 63 Subpart MMM - National Emission Standards for Hazardous Air Pollutants for Pesticide Active Ingredient Production
40 CFR Part 60 Subpart Kb - Standards of Performance for Volatile Organic Liquid Storage Vessels (Including Petroleum Liquid Storage Vessels) for Which Construction, Reconstruction, or Modification Commenced after July 23, 1984
40 CFR Part 60 Subpart Y- Standards of Performance for Coal Preparation Plants

FutureFuel Chemical Company

Permit #: 1085-AOP-R16

AFIN: 32-00036

Regulations
40 CFR Part 60 Subpart VV - Standards of Performance for Equipment Leaks of VOC in the Synthetic Organic Chemicals Manufacturing Industry
40 CFR Part 60 Subpart NNN - Standards of Performance for Volatile Organic Compound (VOC) Emissions From Synthetic Organic Chemical Manufacturing Industry (SOCMI) Distillation Operations
40 CFR Part 61 Subpart J - National Emission Standards for Equipment Leaks (Fugitive Emission Sources) of Benzene
40 CFR Part 61 Subpart V - National Emission Standards for Equipment Leaks (Fugitive Emission Sources)
40 CFR Part 61 Subpart Y - National Emission Standards for Benzene Emissions from Benzene Storage Vessels
40 CFR Part 61 Subpart FF - National Emission Standard for Benzene Waste Operations
40 CFR Part 63 Subpart DD - National Emission Standards for Hazardous Air Pollutants from Off-Site Waste and Recovery Operations
40 CFR Part 63 Subpart EEE (Phase I and II) - National Emission Standard for Hazardous Air Pollutants from Hazardous Waste Combustors
40 CFR Part 63 Subpart FFFF - National Emission Standard for Hazardous Air Pollutants: Miscellaneous Organic Chemical Manufacturing
40 CFR Part 60 Subpart Db - Standards of Performance for Industrial-Commercial-Institutional Steam Generating Units
40 CFR Part 63 Subpart ZZZZ - National Emissions Standards for Hazardous Air Pollutants for Stationary Reciprocating Internal Combustion Engines
40 CFR Part 63 Subpart DDDDD - National Emission Standards for Hazardous Air Pollutants for Major Sources: Industrial, Commercial, and Institutional Boilers and Process Heaters
40 CFR Part 60 Subpart JJJJ – Standards of Performance for Stationary Spark Ignition Internal Combustion Engines

Emission Summary

EMISSION SUMMARY				
Source Number	Description	Pollutant	Emission Rates	
			lb/hr	tpy
Total Allowable Emissions		PM	56.7	178.7
		PM ₁₀	56.7	178.7
		PM _{2.5}	***note	***note
		SO ₂	1447.0	6144.4
		VOC	318.9	491.3
		CO	309.8	1224.6
		NO _x	246.4	875.4
		Pb	0.9	3.5
HAPs		Inorganics*	273.2	1092.9
		Organic Pollutants**	318.1	491.3
5N09-01	Regenerative Thermal Oxidizer (2 Units)	PM	9.90	17.50
		PM ₁₀	9.90	17.50
		SO ₂	8.40	36.8
		VOC	43.6	191.0
		CO	11.0	25.2
		NO _x	8.7	38.1
		Inorganics*	10.00	43.8
		Organic Pollutants**	43.6	191.00
5N09-02	Thermal Oxidizer and Caustic Scrubber	PM	0.1	0.1
		PM ₁₀	0.1	0.1
		SO ₂	3.0	13.1
		VOC	2.9	12.7
		CO	0.5	2.2
		NO _x	3.0	13.1
		Inorganics*	1.00	4.40
		Organic Pollutants**	2.90	12.70
5N09-03	Thermal Oxidizer and Caustic Scrubber	PM	0.1	0.2
		PM ₁₀	0.1	0.2
		SO ₂	3.0	13.1
		VOC	2.9	12.7
		CO	0.5	2.2
		NO _x	3.0	13.1
		Inorganics*	1.00	4.40
		Organic Pollutants**	2.90	12.70
OCI-FUG	Fugitives	VOC	3.70	15.90
		Organic Pollutants**	3.70	15.90
Utilities				

EMISSION SUMMARY				
Source Number	Description	Pollutant	Emission Rates	
			lb/hr	tpy
6M01	Coal Pile	PM PM ₁₀	0.1 0.1	0.1 0.1
6M01-01	3 Coal Fired Boilers (70 MMBtu/hr each)	PM PM ₁₀ SO ₂ VOC CO NO _x Pb Inorganics* Organic Pollutants**	26.1 26.1 1391.0 0.7 236.3 106 0.8 259.0 0.7	112.8 112.8 5982.9 2.9 1034 488.2 3.4 1031.6 2.9
6M01-01A	Coal Bunker Fabric Filter	PM PM ₁₀	0.2 0.2	0.7 0.7
6M06-01	#4 Boiler (78 MMBtu/hr) Natural Gas	PM PM ₁₀ SO ₂ VOC CO NO _x Organic Pollutants**	0.6 0.6 0.1 0.5 6.6 13.3 0.5	2.6 2.6 0.3 1.9 28.7 58.3 1.9
6M07-01	#5 Boiler (221 MMBtu/hr) Natural Gas	PM PM ₁₀ SO ₂ VOC CO NO _x Organic Pollutants**	1.7 1.7 0.2 1.3 18.6 22.0 1.3	7.4 7.4 0.6 5.4 81.4 96.4 5.4
BLR-FUG	Utilities Area Fugitive Emissions	VOC Organic Pollutants**	0.5 0.50	1.8 1.80
Organic Sulfonation				
5M01-01	Scrubber	VOC Organic Pollutants**	0.1 0.10	0.4 0.40
5M01-02	Scrubber	VOC Organic Pollutants**	0.1 0.10	0.4 0.40
5M01-05	Scrubber	VOC Organic Pollutants**	0.1 0.10	0.4 0.40
5M01-06	Scrubber	VOC Organic Pollutants**	0.5 0.50	1.8 1.80

EMISSION SUMMARY				
Source Number	Description	Pollutant	Emission Rates	
			lb/hr	tpy
5M01-07	Scrubber	VOC	0.1	0.4
		Organic Pollutants**	0.10	0.40
5M01-08	Scrubber	VOC	0.1	0.4
		Organic Pollutants**	0.10	0.40
5M01-09	Scrubber	VOC	0.2	0.9
		Organic Pollutants**	0.20	0.90
5M03-01	Scrubber	VOC	0.1	0.4
		Organic Pollutants**	0.10	0.40
5M03-02	Scrubber	VOC	0.2	0.8
		Organic Pollutants**	0.20	0.80
5M04-01	Scrubber	VOC	0.6	2.3
		Organic Pollutants**	0.60	2.30
5M04-02	Scrubber	VOC	0.2	0.7
		Organic Pollutants**	0.20	0.70
5M04-10	Scrubber	SO ₂	0.1	0.4
5M05-01	Scrubber	VOC	0.1	0.4
		Organic Pollutants**	0.10	0.40
5M05-02	Scrubber	VOC	0.1	0.4
		Organic Pollutants**	0.1	0.4
5M11-01	Scrubber	VOC	0.1	0.4
		Organic Pollutants**	0.10	0.40
5M11-04	Scrubber	VOC	0.1	0.4
		Organic Pollutants**	0.10	0.40
5M11-05	Scrubber	VOC	0.1	0.4
		Organic Pollutants**	0.10	0.40
5M11-06	Scrubber	VOC	0.1	0.4
		Organic Pollutants**	0.10	0.40
5M11-07	Scrubber	VOC	0.1	0.4
		Organic Pollutants**	0.10	0.40
5M11-15	SPS Supersack Load Hopper Dust Control System	PM/PM ₁₀	0.1	0.3
5M13-01	Scrubber	VOC	0.1	0.4
		Organic Pollutants**	0.10	0.40
5M16-01	Supersack Loadout Dust Control System	PM	0.1	0.4
		PM ₁₀	0.1	0.4
5M18-01	Continuous Dust Control System	PM	3.9	17.1
		PM ₁₀	3.9	17.1

EMISSION SUMMARY				
Source Number	Description	Pollutant	Emission Rates	
			lb/hr	tpy
5M18-02	Central Vacuum Cleaning System	PM	3.4	3.7
		PM ₁₀	3.4	3.7
5M18-03	Bin Vacuum Cleaning System	PM	0.3	0.9
		PM ₁₀	0.3	0.9
5MNOBS-TNK	Aggregate Tank (5 tanks)	VOC	0.6	2.6
		Organic Pollutants**	0.6	2.6
NOBS-FUG	Fugitive Emissions from Organic Sulfonation Process	VOC	1.2	5.3
		Organic Pollutants**	1.20	5.30
5M01-TSP	Dust Control Maintenance Fugitives	PM	3.1	0.2
		PM ₁₀	3.1	0.2
Chemical Destructor				
6M03-05	Chemical Waste Destructor (50 MMBtu/hr)	PM	1.5	6.6
		PM ₁₀	1.5	6.6
		SO ₂	20.4	89.0
		VOC	1.0	4.0
		CO	11.2	27.0
		NO _x	33.2	146.0
		Pb	0.1	0.1
		Inorganics*	1.4	6.1
DEST-FUG	Destructor Fugitives	VOC	1.0	3.0
		Organic Pollutants**	1.00	3.00
Solvent Recovery				
4PSR-00	Solvent Recovery Facility	VOC	4.0	17.0
		Organic Pollutants**	4.00	17.00
SR-FUG	Solvent Recovery Fugitive Emissions	VOC	5.0	21.9
		Organic Pollutants**	5.00	21.90
Waste Water Treatment				
7K01-01	WWT Facilities	VOC	28.6	125.3
		Organic Pollutants**	28.60	125.30
7M01-02	Decant Tank	VOC	0.8	3.5
		Organic Pollutants**	0.80	3.50
7M01-03	pH Control Tank	Inorganics*	0.10	0.4
7M01-03-B	pH Control Tank	Inorganics*	0.10	0.10

EMISSION SUMMARY				
Source Number	Description	Pollutant	Emission Rates	
			lb/hr	tpy
7M01-04	WWT Container	VOC Organic Pollutants**	0.1 0.10	0.4 0.4
Isopropyl Benzene				
5NDIPB-TNK	Tank Bubble (10 tanks)	VOC Organic Pollutants** Inorganic Pollutants*	0.2 0.2 0.1	0.6 0.6 0.1
5N03-48	Scrubber	Inorganics*	0.10	0.40
5N03-54	Flare	PM PM ₁₀ SO ₂ VOC CO NO _x Organic Pollutants**	0.1 0.1 0.5 0.9 2.4 0.5 0.9	0.4 0.4 1.9 3.9 9.8 1.9 3.9
5N03-55	Scrubber	Inorganics*	0.10	0.4
DIPB-FUG	Fugitive Emissions from Isopropyl Benzene Process	VOC Organic Pollutants**	0.3 0.30	1.3 1.30
Storage Tanks and Miscellaneous Sources				
6N01-02	Diesel Tank	VOC Organic Pollutants**	0.1 0.10	0.4 0.40
6N01-03	Gas Tank	VOC Organic Pollutants**	200 200	0.77 0.77
5N03TK-01	Process Tanks (36 Tanks)	VOC Organic Pollutants** Inorganic Pollutants*	4.0 4.0 0.3	17.5 17.5 1.2
5N07 Production Facility				
5N07	Biodiesel Production	VOC Organic Pollutants**	2.9 2.90	12.4 12.40
Aldehyde Processing Section				

EMISSION SUMMARY				
Source Number	Description	Pollutant	Emission Rates	
			lb/hr	tpy
4P05-01	Hot Oil System	PM	0.2	0.9
		PM ₁₀	0.2	0.9
		SO ₂	1.1	4.9
		VOC	4.0	6.8
		CO	1.5	6.4
		NO _x	3.2	13.8
		Organic Pollutants**	4.0	6.8
4P05-03	Hot Oil System #2	PM	0.2	0.6
		PM ₁₀	0.2	0.6
		SO ₂	0.1	0.1
		VOC	0.8	3.4
		CO	1.5	6.4
		NO _x	0.9	3.8
		Organic Pollutants**	****	3.4
4PSR-FUG	Aldehyde Processing Fugitives	VOC	0.6	2.5
		Organic Pollutants**	0.60	2.50
Anode Material Process				
5M11-08	Continuous Dust Collection System Baghouse	PM	1.1	4.7
		PM ₁₀	1.1	4.7
5M11-09	Central Vacuum System Baghouse	PM	1.1	0.9
		PM ₁₀	1.1	0.9
CP2-FUG	Anode Material Process VOC/HAP Fugitives	VOC	0.4	1.4
		Organic Pollutants**	0.40	1.4
Emergency Generators				
5N01-WA	Diesel Glycol Pump	PM	0.3	0.1
		PM ₁₀	0.3	0.1
		SO ₂	0.2	0.1
		VOC	0.3	0.1
		CO	0.8	0.1
		NO _x	3.8	0.2
		Organic Pollutants**	0.3	0.1

EMISSION SUMMARY				
Source Number	Description	Pollutant	Emission Rates	
			lb/hr	tpy
7M04-HT-G01	Diesel Waste Disposal Pump	PM	0.6	0.1
		PM ₁₀	0.6	0.1
		SO ₂	0.5	0.1
		VOC	0.6	0.1
		CO	1.7	0.1
		NO _x	8.0	0.4
		Organic Pollutants**	0.6	0.1
7M04-HT-G04	Diesel Waste Disposal Pump	PM	0.6	0.1
		PM ₁₀	0.6	0.1
		SO ₂	0.5	0.1
		VOC	0.6	0.1
		CO	1.7	0.1
		NO _x	8.0	0.4
		Organic Pollutants**	0.6	0.1
6N02-EG	Diesel Generator	PM	0.7	0.1
		PM ₁₀	0.7	0.1
		SO ₂	12.1	0.6
		VOC	1.1	0.1
		CO	8.5	0.4
		NO _x	15.5	0.8
		Organic Pollutants**	1.1	0.1
8M01	Diesel Fire Water Pump	PM	0.5	0.1
		PM ₁₀	0.5	0.1
		SO ₂	5.7	0.3
		VOC	0.5	0.1
		CO	3.8	0.2
		NO _x	16.8	0.8
		Organic Pollutants**	0.5	0.1
4P-EG-01	Emergency Natural Gas Generator	PM	0.1	0.1
		PM ₁₀	0.1	0.1
		SO ₂	0.1	0.1
		VOC	0.1	0.1
		CO	3.2	0.4
		NO _x	0.8	0.1
		Organic Pollutants**	0.1	0.1

*Inorganics are considered to be non-organic Hazardous Air Pollutants

** Organic Pollutants are considered to be VOC, all organic HAPs, and organic Air Contaminates.

***PM_{2.5} limits are source specific, if required. Not all sources have PM_{2.5} limits.

****Limited by PW 12 and 15.

SECTION III: PERMIT HISTORY

- 262-A Permit was issued to Arkansas Eastman in December of 1974 for the installation of a facility to manufacture various specialty and organic intermediate chemicals through batch operations. Three 70 MM Btu/hr coal-fired boilers were installed to provide steam for the processes.
- 262-AR-1 Issued in 1976, this permit recognized suspension of construction plans for the hydroquinone plant, authorized a higher number of reactors for the chemical intermediates plant, acknowledged the use of ESPs for control of boiler emissions, and permitted the chemical destructor at 9 pounds of particulate per hour.
- 487-A Permit was issued in 1978. This permit allowed the facility to add 8 batch reactors and 10 storage tanks. Each of the reactors were vented through a caustic scrubber. The particulate emissions were routed through fabric filters.
- 262-AR-2 This permit, issued in 1978, authorized an expansion of the chemical products and intermediates. Emission control was provided by caustic and water scrubbers. The permit required the facility to develop an ambient air monitoring program in order to evaluate emission concentrations beyond the property line.
- 262-AR-3 Issued on July 25, 1980. This permit approved an expansion in production to allow a greater variety and larger quantity of chemicals. New process equipment included reactors, filters, dryers, distillation columns, and storage tanks. Emission control equipment included scrubbers using sodium hydroxide or water. The permit also allowed the installation of a new coal fired boiler (193 MM Btu/hr). The coal boiler utilized an ESP for particulate control, and the boiler was limited to coal at or below 1 percent sulfur, and a heat content of 12,500 Btu per pound. This permitting action required PSD review.
- PSD-AR-311 Issued by the U.S. Environmental Protection Agency on March 27, 1981. This was a PSD permit which addressed the installation and operation of (coal-fired) Boiler #4 and the associated coal handling system. The permit imposed a coal sulfur limit of 1 percent by weight and an ash content of 20 percent by weight. The permit also specified limits on throughput, opacity, emissions, monitoring, and stack testing for the new boiler.
- 262-AR-4 Permit was issued on September 25, 1981. This permit allowed the installation of additional process equipment and a coal-fired boiler. The permit also authorized cessation of certain continuous monitoring equipment, subsequent to the demonstration that criteria pollutant concentrations were well below the NAAQS.
- 262-AR-5 Permit revision was issued on July 23, 1982. This permit authorized an increase in sulfur content of the coal fueling the coal boilers. The sulfur limit was raised

from 1 to 4 percent. Upon evaluation of emission increases and dispersion modeling, this permitting action did not require PSD review.

- 262-AR-6 Issued on March 21, 1986. This permit authorized the installation and operation of an oxidized cellulose facility. Emission control was provided by a packed column scrubber using sodium hydroxide.
- 744-A Issued on November 5, 1984. This permit was issued to allow the operation of a new isopropylbenzene production process. Emission control included a fabric filter and a water scrubber for the catalyst storage and transfer system. Reaction and refining emissions were routed to a flare.
- 829-A Issued on July 14, 1987. This permit authorized the installation and operation of one 78 MMBtu/hr steam boiler. Nitrogen oxides emissions from this boiler were estimated at above the 40 ton/yr Prevention of Significant Deterioration (PSD) threshold, and the permit application was therefore required to undergo PSD review. The BACT analysis found that emissions controlled by either staged combustion/low excess air burners or flue gas recirculation would not substantially improve ambient air quality and were not economically feasible. No additional controls were therefore required, and standard-register burners were approved for use.
- 981-A Issued on February 20, 1990. This permit was issued to allow the operation of a new polymer production facility. Emissions were controlled by conservation vents on the tanks and 2-stage scrubbers on the centrifuges, reactors, and distillation columns.
- 268-I Permit issued on March 25, 1976 to permit the facility's incinerator.
- 1085-A Issued on January 11, 1991. This permit was issued to modernize some of the older permits and to put all of the company's permits into one package. This permit also required Eastman to install and operate a Regenerative Thermal Oxidizer (RTO) on the batch organic chemicals production facilities in buildings 5N01 and 5N03 for the control of VOC emissions by July, 1992.
- 1085-AR-1 Issued on May 14, 1992. This permit involved the installation of a 221 MMBtu/hr natural gas fired boiler (6M-07-01), which required a PSD permit due to significant nitrogen oxide emissions (98 tons per year).
- 1085-AR-2 Issued on February 9, 1994. This permit was issued to document the burning of wastewater sludge in all three of the coal fired boilers at the facility. Eastman proposed to dewater wastewater treatment plant sludge before atomizing it using compressed air, into the high temperature combustion zone of the boilers.

- 1085-AR-3 Issued on April 18, 1994. The modification involved the addition of a packed-bed water scrubber to source 5N01-45, a 24,000 gallon aboveground storage tank which stores crotonaldehyde. This was an uncontrolled source prior to this minor permit modification. Potential emissions from this source were calculated to be 5.7 tons per year after the controls.
- 1085-AR-4 Issued on October 20, 1994. This permit involved venting several temporary storage tanks to the RTOs. The main purpose for this modification was to control the odor generated from the use of ethyl mercaptan, which is mainly used to odorize natural gas. The following tanks were vented to the RTO: 5N01-11, 5N01-12, 5N01-13, 5N01-14, 5N01-16, 5N01-19, 5N01-20, 5N01-21, 5N01-29, 5N01-30, 5N01-34, 5N01-35, 5N01-36, 5N01-37, 5N01-50, 5N01-51, 5N01-52, 5N01-53, 5N01-60, 5N01-62, 5N03-09, 5N03-10, and 5N03-61.
- 1085-AR-5 Issued on October 18, 1994. This was a minor modification for producing a new polymer in the Polymer Production Facility. Emissions from this modification were controlled by the RTOs, scrubbers, and conservation vents on tanks.
- 1085-AR-6 Issued on June 6, 1995. This modification involved modifying existing solvent recovery equipment used to recover additional solvent and to remove potential odor producing compounds by destroying them in the existing RTOs. The main purpose of this modification was to control the odor generated from the use of ethyl mercaptan. Ethyl mercaptan is mainly used to odorize natural gas. The odor threshold of ethyl mercaptan is 0.4 ppb. To eliminate this odor, the facility proposed that the scrubber atmospheric vents be connected to the RTOs. Additionally, the permittee proposed to modify the existing wastewater treatment system by closing the existing equalization basin, discontinuing the use of the existing diversion basin for processing wastewater, and constructing aboveground tanks for equalization/neutralization and diversion of the wastewater. The system modification included the addition of two 30,000 gallon pump station clearwells, two 750,000 gallon equalization tanks, and one 1,000,000 gallon diversion tank. Also a new lift station, neutralization system, and a floating organic skimmer and decant system was to be provided. The existing diversion basis was to be used to capture noncontact cooling water and storm water runoff should it become contaminated.
- 1085-AR-7 Permit was issued on November 27, 1995. This permit was issued to raise the particulate emission limit on the RTOs.
- 1085-AR-8 Permit was issued on May 8, 1996. This permit covered routing emissions from eleven waste storage tanks to the coal-fired boilers to abate odors within the utilities area of the plant, to burn waste solvent fuel in the boilers at the rates certified under the Boiler and Industrial Furnace regulation (BIF), to increase the rate of rubber and paper pellet fuel burning to 100% of the total heat input of the

coal-fired boilers, and to construct one 20,000 gallon storage tank containing a final polymer product.

- 1085-AR-9 Permit was issued on November 12, 1996. This permit involved increasing potential VOC emission from the Waste Chemical Destructor from 0.5 tpy to 8.8 tpy due to an anticipated future increase in business and a corresponding increase in the amount of wastes that could potentially be generated; and to increase potential inorganic emissions from 16.3 tpy to 43.8 tpy from the two RTOs due to an anticipated increase in chlorinated compounds production.
- 1085-AR-10 Permit was issued on March 11, 1997. This permit involved the construction and operation of a continuous dust collection system and central vacuum cleaning system. Five additional emission points discharging from venturi scrubbers and fabric filters, and an emission point designating fugitive emission from maintenance activities, were created with the startup of this dust collection and vacuum cleaning system. This permit also allowed the organic sulfonation facility to produce alternative products, which required minor changes in the process chemistry to meet new markets. Eight new emission points were created with this modification.
- 1085-AOP-R0 Permit was issued on June 24, 2002. This permit (1085-AOP-R0) was issued in order to satisfy the requirements of Title V of the Clean Air Act. This permit also incorporated the requirements of 40 CFR Part 60, Subpart EEE, National Emission Standards for Hazardous Air Pollutants from Hazardous Waste Combustors, promulgated on September 30, 1999. In addition, the facility was authorized to: burn wood chips in the three coal-fired boilers; install a system of tanks, strippers, dryers, and distillation columns necessary to recover dimethyl sulfoxide from wastewater; incorporate a project to collect and reduce the accumulation of process dust within the organic sulfonate manufacturing area; install a small-scale laboratory for research and development activities; re-route emissions from 23 tanks to the Regenerative Thermal Oxidizer (RTO); replace five waste storage tanks; and to re-route three distillation column vents to the Regenerative Thermal Oxidizer (RTO) control system for the purpose of odor abatement.
- 1085-AOP-R1 Permit was issued on January 20, 2004. This permit was issued in response to a Permit Appeal Resolution (PAR, Docket No. 02-006-P) concerning Air Permit 1085-AOP-R0. Changes based upon the PAR include: the deletion of individual unit pound-per-hour emission limits for Hazardous Air Pollutants (HAPs); the addition of a plantwide condition to clarify types of permit deviations and reporting schedules; the removal of the carbon monoxide (CO) stack testing requirement for the Chemical Waste Destructor (SN-6M03-05); the addition of a mechanism by which the facility may use a correlation study to petition the Department for less frequent (non-MACT) stack testing of NO_x, SO₂, and/or PM at SN-6M03-05; the revision of conditions related to 40 CFR Part 63, Subpart

EEE to reflect the most recent version of the interim rule; a modification of former Plantwide Condition 23 to clarify that a compliance report is required for state-only enforceable terms and conditions; and the incorporation of the requirements of 40 CFR Part 63, Subpart GGG, National Emission Standards for Pharmaceuticals Production.

- 1085-AOP-R2 Permit was issued on June 18, 2004. The permit was modified in order to connect three general-purpose bulk storage tanks to the Regenerative Thermal Oxidizers (RTOs) to meet the deadline of December 23, 2003 for 40 CFR Part 63, Subpart MMM – National Emission Standards for Hazardous Air Pollutants for Pesticide Active Ingredient Production. VOC and HAP emissions were reduced by 2.8 tons/yr as a result of the tank controls. In addition, the requirements of the MACT Subpart MMM were incorporated into the permit as well as changes to the Insignificant Activities list.
- 1085-AOP-R3 Permit was issued on May 20, 2005. Four changes were incorporated into the permit. First, the HCl (inorganic HAP) dispersion modeling demonstration to meet PAER requirements was changed as to allow the submitted modeling in combination with facility records of inorganic HAP emissions to verify that the off-site concentration is protective of public health. Second, a 2,000 gallon liquid process tank was installed. The tank was used for the purpose of flushing the chemical distribution piping at the Chemical Waste Destructor (6M03-05). The spent solvent is then routed to either the coal-fired boiler auxiliary waste chemical burners or to the burner of the chemical waste destructor. Emissions from tank venting will be collected and routed to the coal-fired boilers (6M01-01). Estimated emissions from the tank were less than 0.1 ton/yr VOC or HAP. Third, a bleach scrubber (D75-02) in the Organic Chemical Intermediates section was removed from service. The scrubber, while not actually an atmospheric emission source, removes ethyl mercaptan, an odorous compound generated by an existing batch process. The exiting gases are then routed to the regenerative thermal oxidizers (SN-5N09-01). There is no permitted change to emission estimates at SN-5N09-01. Finally, the facility also requested changes to final Specific Condition CDW 9 to include a compliance option, as CDW 9b, which was not included when the language was originally added to the permit. This option was already provided by 40 CFR Part 63 Subpart EEE. There were no permitted emission changes with this modification.
- 1085-AOP-R4 Issued on August 14, 2006. The facility modified their permit to: use tanks and scrubbers in the Solvent Recovery and Storage Tanks and Miscellaneous Sources areas to produce Biodiesel; to install upgrade equipment to the Regenerative Thermal Oxidizers (RTOs) to increase the destruction removal efficiency (DRE) from 95% to 98%; and to install a replacement air seal inlet and outlet main valves and to add a chamber purge system to prevent leakage and air infiltration around the valves that will increase the DRE, thus reducing emissions of VOC and HAP with no increased usage of natural gas.

- 1085-AOP-R5 Issued on February 15, 2007. The facility requested a minor permit modification to construct a new production line to manufacture wood fuel pellets.
- 1085-AOP-R6 Issued on May 8, 2007. The facility increased biodiesel production capacity and added several new tanks (accounted for within an existing tank bubble, 5N03TK-01) and loading racks which vent to the atmosphere. Controlled emissions from process equipment and storage tanks are routed to scrubbers SV-01 and SV-03 (in the 4PSR-00 emission bubble of the Solvent Recovery Section), and two regenerative thermal oxidizers (SN-5N09-01 of the OCI Section). The loading racks and BD-01 Biodiesel Sales Tank qualify as A-13 Insignificant Activities. The Building 5N07 acrylic resins (5N07-06 and 5N07-FUG) and polymer production (5NPOLY-TNK and POLY-FUG) facility will be retrofitted for biodiesel production. Acrylic resins and polymers will no longer be manufactured. Instead, a new source, the 5N07 Production Facility, which will produce primarily biodiesel, was added.
- 1085-AOP-R7 Issued on December 17, 2007. The permit was modified to allow for the production of Aldehyde products. The emission points for the new Aldehyde Processing Section were the hot oil system (4P05-01), the water scrubber (4P05-02), equipment fugitives (4PSR-FUG), and the RTO (5N09-01).
- 1085-AOP-R8 This revision as issued on June 6, 2008. This permit incorporated the following changes: added 40 CFR 63, Subpart FFFF requirements for several sources at the facility, routed the process equipment going to control devices 4P02-01 and 4P94-02 to the RTOs, route storage tank TF-2, PES # 5N01-44, to the RTOs; Install three new storage tanks, T-271 (30,000 gallons), T-272 (30,000 gallons), and T-273 (40,000 gallons), use an existing storage tank, PT-50, for storage of off-site waste; rename T-212A to VC-PT-03; remove TFB-30 from NSPS Subpart Kb applicability, and redirect the vent from the SB-01 (Source # 4P05-02), located in the Aldehyde Section, to SV-03 (Source # 4P94-02), a water scrubber located in Solvent Recovery.
- 1085-AOP-R9 This permit was issued on September 19, 2013. In this permit the following changes were made:
- Renew the Title V Air Permit
- As part of the renewal permit, the Wood Pellet process was removed from the facility. In addition, rubber is no longer used at the Coal Boilers and the relevant specific conditions have been removed.
- Emergency engines and NESHAP ZZZZ - *National Emission Standards for Hazardous Air Pollutants for Reciprocating Internal Combustion Engines*- conditions were also been added to the permit. These five engines were existing sources. The natural gas fired boilers, 6M06-01 and 6M07-01 emissions were

recalculated using current AP-42 factors for natural gas combustion. Emissions for the coal boilers, 6M01-01, were re-evaluated based upon the maximum coal firing rate on an hourly basis, and an average rate for the annual emissions. Inorganics from this source were revised in accordance with the most recent test event for EEE. Small amounts of lead emissions were also added to the permit. The facility increased production in the Aldehyde processing section from 45 million to 58.5 million pounds per year of vinyl compound products.

- Added tanks T-271 (30,000 gallons), T-272 (30,000 gallons), and T-273 (40,000 gallons)

These tanks are operated at a pressure below 29.7 psia, thus triggering NSPS Kb applicability. Each tank is vapor balanced with incoming railcars and tank trucks at the Aldehyde Processing Section.

- Produce a multi-use anode material within the Organic Sulfonation section

Emissions from this process are 2.3 tpy PM/PM₁₀, 1.4 tpy VOC, and 1.4 tpy Organic HAP. A dormant part of the Organic Sulfonation plant will be retrofitted to process anode material. Existing and new process equipment both are used in the process. The Anode Material Process (CP2), which will be permitted as a separate section, CP-2, consists of solids handling equipment, continuous stirred tank reactors, and dryers. Pelletized and granular materials are fed through a metering system into vessels where the material is heated and mixed. The formulated material is then dried and repackaged. All of this equipment is located inside the 5M11 building. Dust from all of the solids handling equipment is vented to a continuous dust control system (CDCS), 5M11-08. The CDCS consists of a baghouse for solid particle separation, a collection hopper, and an induced draft fan. A central vacuum cleaning system (CVC), 5M11-09 will be used to clean spills. All VOC vents are routed to the RTOs, 5N09-01. A 17,500 gallon solvent tank (CP2-T-004) and a 36,000 gallon residue tank (CP2-T-003) was added. Emissions from tanks and equipment containing VOC's will vent to existing thermal oxidizers SN-5N09-01. Previously, SN-5M11-08 and SN-5M11-09 are permitted as scrubbers (SRE-VE-501 and SER-VE-502) in the OSP section. As a result of this change, the source will be permitted as a baghouse (CP2-C-501 and SER-C-503).

Neither CP2-T-003 or CP2-T-004 are regulated by 40 CFR Subpart Kb (Standards of Performance for Volatile Organic Liquid Storage Vessels) per 40 CFR 60.11b(b). Both tanks contain liquids with vapor pressures less than 15.0 kPa. Both tanks are vented to the RTOs, 5N09-01. As a miscellaneous organic chemical manufacturing process unit (MCPU), this section is subject to 40 CFR Part 63 Subpart FFFF, and was required to comply with these provisions upon startup.

- Install a 2.5 MMBTU thermal oxidizer and caustic scrubber, SN-5N09-2, in the OCI section.

Thermal oxidizer exhaust gases vents to a caustic scrubber suitable for halogen halide and chlorinated hydrocarbon control. The source is subject to 40 CFR 63, Subpart FFFF. Permitted emissions increased by 0.1 tpy particulates, 13.1 tpy SO₂, 12.7 tpy VOC, 2.2 tpy CO, 13.1 tpy NO_x, 4.4 tpy Inorganic HAP, and 12.7 tpy Organic HAP. A small increase of 0.3 tpy of fugitive VOC and Organic HAP emissions from the OCI section was added from the installation of the source.

- To change the scrubbing fluid on SPS-VE-02 (SN-5M04-01 of the Organic Sulfonation Section) from 2,2,4-trimethyl-1-3-pentanediol diisobutyrate (TXIB) to water.

There were no changes to emissions as a result of the scrubber liquid change.

- Add a new storage tank, PSA-TF-01 to the Organic Sulfonation Section

The new tank was added to the 5MNOBS-TNK tank bubble. Emissions are estimated to be less than 40 lb/yr of VOC from this source. Neither tank is subject to NSPS Kb.

1085-AOP-R10 This permit was issued May 14, 2015. With this permit modification, FutureFuel added three odor control scrubbers to reduce odors of trimethylamine and triethylamine emitted by process equipment and added a third scrubber on tank TF- 14. Tank TF-14 is a pressurized tank. The scrubber is located on the pressure relief valve of the tank and is not permitted as a source. The other odor scrubbers are before Thermal Oxidizer SN 5N09-02 and SN-5N09-01. No increases in permitted emissions are made due to these scrubbers. The emissions for the gasoline tank SN 6N01-03 were updated. Hourly rates were increased. The “Organic HAPs” in the permit were changed to “Organic Pollutants” to include organic air contaminants and HAPs which are not VOC. Two insignificant diesel tanks were removed. Opacity observation requirements for 5N09-01 and 5N09-02 were updated. A requirement to submit an application to incorporate the boiler MACT into the permit was added to Plantwide conditions.

1085-AOP-R11 This permit was issued January 1, 2016. The facility submitted an application to add 40 C.F.R. § 63 Subpart DDDDD to the permit. The facility also requested the approval to install a second 500 cfm natural gas fired thermal oxidizer with quench and scrubber (SN-5N09-03). Total facility wide emission changes were as follows: +0.2 tpy PM/PM₁₀, +13.1 tpy SO₂, +13.0 tpy VOC, +2.2 tpy CO, +13.1 tpy NO_x, +4.4 tpy Inorganics, and +12.7 tpy Organic Pollutants.

FutureFuel Chemical Company
Permit #: 1085-AOP-R16
AFIN: 32-00036

1085-AOP-R12 This permit was issued on August 31, 2016. The facility submitted a minor modification application to:

- Remove tanks TF-2, TFV-1, and TFV-3 from the 5N03-TK01 emission bubble.
- Remove tanks TF-6, TF-7, TF-10, and TF-11 from the Insignificant Activities list as they are part of SN 5N03TK-01.
- Correct TFB-2 to TFB-22 in SN 5N03TK-01 emission bubble list.
- Add tanks T-273, TFS-6, and TF-8 to the 5N03TK-01 emission bubble.
- Move tank TF-5FS from the Insignificant Activities List to SN 5N03TK-01, as it will now be subject to NESHAP FFFF (MON MACT).
- There were no permitted changes in emissions with these actions.

1085-AOP-R13 This permit was issued on November 29, 2018. The facility submitted a Title V permit renewal, with modification, to update several emission factors due to new test data. Permitted emission increases were 0.8 tpy of PM and PM₁₀, 7.6 tpy SO₂, 9.07 tpy VOC and organic pollutants, 89.5 tpy CO, 38.2 tpy NO_x, and 1.2 tpy of inorganic pollutants.

1085-AOP-R14 This Permit was issued on February 24, 2020. The facility submitted a Minor Modification to add a second Hot Oil System (SN 4P05-03) to the Aldehyde Processing section of the permit. This will increase the production limits of the Aldehyde section from 58.5 million pounds per year of vinyl compound products to 75 million pounds per year.

Permitted emissions increases are 0.6 tpy of PM and PM₁₀, 0.1 tpy SO₂, 3.4 tpy VOC and Organic Pollutants, 6.4 tpy CO, and 3.8 tpy NO_x

Based on calculations submitted by the facility, this debottlenecking does not constitute a significant increase in emissions for any NSR pollutant.

1085-AOP-R15 – This permit was issued on June 27, 2022. This application was submitted as a minor modification to Permit No. 1085-AOP-R14 to do the following:

- Update the process description for the Aldehyde Processing Section (AP);
- Removing tank 5N01-39 from bubble source 5N03TK-01, this tank is reported under SN-5N09-01;
- Replacing 6N02 Diesel Generator with 6N02-EG (emergency generator)
- Update Plantwide Limits due to the change in generators.

Permitted emissions decreased 0.1 tpy of both PM and PM₁₀, 0.3 tpy VOC, 0.3 tpy Organic Pollutants and 0.6 tpy NO_x. Permitted emissions increased 0.1 tpy SO₂ and CO.

SECTION IV: SPECIFIC CONDITIONS

Organic Chemical Intermediates
5N09-01, 5N09-02, 5N09-03, and OCI-FUG

Source Description

FutureFuel’s batch organic chemical intermediates facilities are located in Buildings 5N01, 5N03, and 5N07. These production buildings contain multi-purpose/product equipment which may produce a variety of chemicals. The contained or captured vapors from the equipment in the three batch production buildings are vented through a collection system to the RTO units via a common duct. Volatile organic compounds (VOCs) are destroyed by combustion. Fugitive emissions from organic chemical intermediates are designated as source number OCI-FUG. Two other TOs (SN-5N09-02 and SN-5N09-03) are also present, but in conjunction with a caustic scrubber.

Some portion of the organic chemical intermediate facility is subject to NSPS Subpart Kb, NESHAP Subpart GGG, MMM, and FFFF.

Specific Conditions

OCI 1 The permittee shall not exceed the emission rates set forth in the following table. Emission rates are based upon the maximum capacity of equipment. [Reg.19.501 *et seq.* and 40 C.F.R. § 52 Subpart E]

SN	Description	Pollutant	lb/hr
5N09-01	Regenerative Thermal Oxidizer (2 Units)	PM ₁₀	9.90
		SO ₂	8.40
		VOC	43.6
		CO	11.0
		NO _x	8.7
5N09-02	Thermal Oxidizer and Caustic Scrubber	PM ₁₀	0.1
		SO ₂	3.0
		VOC	2.9
		CO	0.5
		NO _x	3.0
5N09-03	Thermal Oxidizer and Caustic Scrubber	PM ₁₀	0.1
		SO ₂	3.0
		VOC	2.9
		CO	0.5
		NO _x	3.0
OCI-FUG	Fugitives	VOC	3.7

OCI 2 The permittee shall not exceed the emission rates set forth in the following table. The facility shall show compliance with the facility total ton/yr limits using the procedures

outlined in PW 11 through PW 15. Hourly Plantwide Hazardous Air Pollutant emissions are limited by 15. Additional HAP limitations are included in PW12. [Reg.18.801 and Ark. Code Ann. § 8-4-203 as referenced by Ark. Code Ann. §§ 8-4-304 and 8-4-311]

SN	Description	Pollutant	lb/hr
5N09-01	Regenerative Thermal Oxidizer (2 Units)	PM	9.90
		Inorganics*	10.0
		Organic Pollutants**	***
5N09-02	Thermal Oxidizer and Caustic Scrubber	PM	0.1
		Inorganics*	1.00
		Organic Pollutants**	***
5N09-03	Thermal Oxidizer and Caustic Scrubber	PM	0.1
		Inorganics*	1.00
		Organic Pollutants**	***
OCI-FUG	Fugitives	Organic Pollutants**	***

*Inorganics are considered to be non-organic Hazardous Air Pollutants.

**Organic Pollutants are considered to be VOC, all organic HAPs, and organic Air Contaminates.

*** Limited by Plantwide Condition 12

- OCI 3 The permittee shall perform periodic testing of 5N09-01 (RTO) for SO₂, VOC, CO, and NO_x, using Methods 6C, 25A, 10, and 7E, respectively. The VOC destruction efficiency shall be determined during the Method 25A testing. Testing shall commence no later than 61 months from the date of the previous test. Testing at 5N09-01 shall conform with the requirements of Plantwide Conditions 3 and 4. [Reg.19.702 and 40 C.F.R. § 52 Subpart E]
- OCI 4 The permittee shall commence testing of SN-5N09-02 (TO) and SN-5N09-03 (TO) no later than 61 months from the date of the previous test. The initial test for SN-5N09-02 was performed on August 22, 2013 and August 23, 2013. The halogen emission rate shall be determined using Method 26 or 26A, or 320 and shall be limited to no more than 0.45 kg/hr, contained within Specific Condition MON 10. The VOC destruction efficiency shall be determined using Method 25. Testing at SN-5N09-02 and SN-5N09-03 shall conform with the requirements of Plantwide Conditions 3 and 4. [Reg.19.702 and 40 C.F.R. § 52 Subpart E]
- OCI 5 The permittee shall not exceed 20% opacity as measured by Method 9 at SN-5N09-01, SN-5N09-02 and SN-5N09-03 during normal operations. Method 22 observations shall be performed on a weekly basis if any visible emissions are detected the permittee shall immediately conduct a Method 9 observation to determine if visible emissions are above permitted limits. [Reg.19.503 and 40 C.F.R. § 52 Subpart E]
- OCI 6 If visible emissions in excess of 20% are detected from SN-5N09-01, SN-5N09-02 or SN-5N09-03, then the permittee will conduct corrective action. The results of these observations and corrective action shall be kept on site and made available for

FutureFuel Chemical Company
Permit #: 1085-AOP-R16
AFIN: 32-00036

inspection upon request. Opacity observations at the RTOs shall not be required during times when the RTOs are being “baked out.” [Reg.19.702 and 40 C.F.R. § 52 Subpart E]

OCI 7 The permittee shall continuously monitor and record the temperature in the combustion chamber of the RTOs and TOs during normal operations. [Reg.19.703, 40 C.F.R. § 52 Subpart E, and Ark. Code Ann. § 8-4-203 as referenced by Ark. Code Ann. §§ 8-4-304 and 8-4-311]

OCI 8 The permittee shall maintain the temperature in the combustion chamber of the RTOs and TOs during normal operations as outlined in the most current version of the Facility Operating Plan. [Reg.19.303 and Ark. Code Ann. § 8-4-203 as referenced by Ark. Code Ann. §§ 8-4-304 and 8-4-311]

40 CFR 63 Subpart GGG - National Emission Standards for Pharmaceutical Production

APPLICABILITY

OCI 9 A portion of this facility is subject to 40 CFR § 63 Subpart GGG, National Standards for Pharmaceuticals Production. Applicable requirements include the following conditions. [Reg.19.304 and 40 C.F.R. § 63.1250]:

Affected Source

- a. The permittee is an affected source subject to 40 CFR Part 63, Subpart GGG as defined in 40 CFR §63.1250(a). The source is an existing source with a compliance date of October 21, 2002. [Reg.19.304 and 40 C.F.R. § 63.1250(a)]

General Provisions Requirements

- b. The provisions of Subpart A, specified in Table I of Subpart GGG are the only general provisions that apply to an affected source subject to this subpart. [Reg.19.304 and 40 C.F.R. § 63.1250(c)]

Storage Tank Ownership

- c. The requirements of §63.1250(e), storage tank ownership determination, do not apply until such a time the permittee either installs or activates a tank for use in an applicable Pharmaceutical Manufacturing Process (PMPU). The permittee does not currently have storage tanks subject to this requirement. [Reg.19.304 and 40 C.F.R. § 63.1250(e)]

Compliance Date

- d. The compliance date for the existing affected source is October 21, 2002. [Reg.19.304 and 40 C.F.R. § 63.1250(f)(1)]

Applicability except during periods of startup, shutdown, and malfunction

- e. The permittee shall comply with all applicable requirements of 40 CFR 63, Subpart GGG except that emission limitations shall not apply during periods of startup, shutdown, and malfunction. [Reg.19.304 and 40 C.F.R. § 63.1250(g)]

Consistency with other Regulations

- f. The permittee shall identify in the Notice of Compliance Status report [the report was submitted on March 20, 2003] required by §63.1260(f) the compliance options cited in §63.1250(h)(1) through (6) for those regulations identified that may overlap Subpart GGG. [Reg.19.304 and 40 C.F.R. § 63.1250(h)]
 - i. The permittee will be subject to MACT standards with upcoming compliance dates including the Pesticide Active Ingredient (PAI) MACT, and upon promulgation, the Miscellaneous Organic NESHAP (MON rule). These regulations are not specifically mentioned in the overlap section of the MACT (Subpart GGG). [Reg.19.304 and 40 C.F.R. § 63.1250(h)(1)]
 - ii. The permittee may elect to comply with the monitoring recordkeeping and reporting requirements of either 40 CFR Part 63, Subpart GGG or RCRA Subparts AA, BB, CC for process vents, equipment leaks, and containers/storage tanks covered under both regulations. [Reg.19.304 and 40 C.F.R. § 63.1250(h)(2)]
 - iii. A storage tank with a fixed roof, closed-vent system and control device in accordance with NSPS Kb, must comply with Subpart GGG monitoring, recordkeeping, and reporting requirements for that vessel. Currently the permittee has no tanks in Subpart GGG applicable service. [Reg.19.304 and 40 C.F.R. § 63.1250(h)(3)]
 - iv. Equipment subject to Subpart I of this part may elect to comply with either the provisions of §63.1255 or the provisions of Subpart H of this part for all such equipment. The permittee does not have equipment in Subpart I or Subpart H applicable service. [Reg.19.304 and 40 C.F.R. § 63.1250(h)(4)]
 - v. The permittee does not operate any process subject to the Polyether Polyols MACT. [Reg.19.304 and 40 C.F.R. § 63.1250(h)(6)]

STANDARDS: GENERAL

OCI 10 The permittee shall control HAP emissions to levels specified in this section on and after the compliance dates specified in §63.1250(f) [the compliance date for an existing

source is specified as October 21, 2002]. Initial compliance with the emission limits is demonstrated in accordance with the provisions of §63.1257 [Test Methods and Compliance Procedures], and compliance is demonstrated in accordance with the provisions of §63.1258 [Monitoring Requirements]. [Reg.19.304 and 40 C.F.R. § 63.1252]

Opening of a safety device

- a. The opening of a safety device, as defined in §63.1251, definitions, is allowed at any time conditions require it to do so to avoid unsafe conditions. [Reg.19.304 and 40 C.F.R. § 63.1252(a)]

Closed-vent systems

- b. If the permittee installs a by-pass line that could divert a vent stream away from a control device used to comply with the requirements of §63.1253 [storage tanks], §63.1254 [process vents], and §63.1256 [wastewater provisions], the permittee shall comply with the requirements of §63.1252(b)(1) and (2).

The permittee operates regenerative thermal oxidizers (RTOs), which have emergency dampers meeting the definition of a safety device of §63.1251. By-pass lines do not exist on this closed-vent system and control device. [Reg.19.304 and 40 C.F.R. § 63.1252(b)(1) and (2)]

Heat exchange systems

- c. The permittee shall comply with the requirements in §63.1252(c)(1) of this section for heat exchange system that cool process equipment or materials used in pharmaceutical manufacturing operations except as provided by §63.1252(c)(2). [Reg.19.304 and 40 C.F.R. § 63.1252(c)(1)]

Heat exchangers (HON) requirements

- d. Applicable heat exchange systems shall be treated according to the provisions of §63.104 [HON Heat Exchangers] except that monitoring shall be no less than quarterly. [Reg.19.304 and 40 C.F.R. § 63.1252(c)(1)]

Heat exchangers (cGMP) option

- e. For identifying leaking heat exchange systems of equipment, which meet current good manufacturing practice (cGMP) requirements of 21 CFR Part 211. The permittee may elect to use the physical integrity of the reactor as a surrogate of the heat exchange system leaks around the reactor.

Unit D1-01 meets the criteria of this subpart, cGMP, so the physical integrity of the equipment (pressure vessel) is used as the surrogate indicator of heat exchange system leaks. [Reg.19.304 and 40 C.F.R. § 63.1252(c) and (c)(2)]

Emissions averaging

- f. The permittee may choose to comply with the provisions of §63.1253 [storage tanks] and §63.1254 [process vents] by using emissions averaging requirements specified in §63.1257(g) and (h) except as provided in §63.1252(d)(1). [Reg.19.304 and 40 C.F.R. § 63.1252(d)]

At this time, the permittee does not choose to opt for an emissions averaging compliance method.

Pollution prevention (P2) alternative

- g. The permittee may choose, except as provided in §63.1252(e)(1) of this section, to meet the pollution prevention alternative requirement specified in either §63.1252(e)(2) or (3) of this section, in lieu of the requirements specified in §63.1253 [tanks], §63.1254 [process vents], §63.1255 [LDAR], and §63.1256 [wastewaters]. Compliance shall be demonstrated through the procedures in §63.1257(f). Any Pharmaceutical Manufacturing Process Unit (PMPU) for which the permittee seeks to comply by using the pollution prevention alternative shall begin with the same starting material(s) and end with the same product(s). The permittee shall not comply with the pollution prevention alternative by eliminating any steps of a process by transferring the step offsite and to another manufacturing location. [Reg.19.304 and 40 C.F.R. § 63.1252(e)]

The permittee presently does not choose to opt for the P2 alternative.

Control requirements for certain liquid streams in open systems within a PMPU

- h. The permittee does not operate any liquid streams in open systems as described in §63.1252(f). Therefore, this requirement is not applicable. [Reg.19.304 and 40 C.F.R. § 63.1252(f)]

Control requirements for halogenated vent streams that are controlled by combustion devices

- i. If a combustion device is used to comply with the provisions of §63.1253 [storage tanks], §63.1254 [process vents], or §63.1256(h) [wastewater vent streams] for a halogenated vent stream, then the vent stream shall be ducted to a halogen reduction device such as, but not limited to, a scrubber, before it is discharged to the atmosphere. The halogen reduction device must reduce emissions by amounts specified in either §63.1252(g)(1) or (2) of Subpart GGG.

FutureFuel Chemical Company
Permit #: 1085-AOP-R16
AFIN: 32-00036

The permittee does not manage any halogenated vent streams in its PMPU. Therefore, this requirement is not applicable. If halogenated compounds are to be vented from the PMPU, the permittee shall comply with the requirements of this subpart. [Reg.19.304 and 40 C.F.R. § 63.1252(g)]

Planned routine maintenance for centralized combustion control devices

- j. The permittee does not operate any non-dedicated PMPUs during periods of planned routine maintenance for centralized combustion control devices (CCCD) and is not subject to this citation. [Reg.19.304 and 40 C.F.R. § 63.1252(h)]

STANDARDS: Storage Tanks

- OCI 11 The requirements of §63.1253 do not apply until such a time the permittee either installs or activates a storage tank for use in an applicable Pharmaceuticals Manufacturing Process Unit. [Reg.19.304 and 40 C.F.R. § 63.1253]

STANDARDS: Process Vents - Existing Sources

- OCI 12 The permittee shall comply with the requirements in either §63.1254(a)(1) [process-based emission reduction] and (3) [individual vent emission reduction], or §63.1254(a)(2) [process-based annual mass limit] and (3) [individual vent emission reduction]. Initial compliance with the required emission limits or reductions in §63.1254(a)(1) through (3) are demonstrated in accordance with the initial compliance procedures described in §63.1257(d) [Initial Compliance with Process Vents], and continuous compliance is demonstrated in accordance with the monitoring requirements in [Monitoring]. [Reg.19.304 and 40 C.F.R. § 63.1254(a)]

Process-based emission reduction requirement

- a. If the permittee chooses the compliance option in §63.1254(a)(1), uncontrolled HAP emissions from the sum of all process vents with a process that are not subject to the requirements of §63.1254(a)(3)[individual vent emission reduction requirement] shall be reduced by 93% or greater by weight, as specified in §63.1254(a)(1)(ii) [process-based emission reduction requirement]. Notification of changes in the compliance method shall be reported according to the procedures in §63.1260(h) [notification of process change]. [Reg.19.304 and 40 C.F.R. § 63.1254(a)(1)]

Process-based annual mass limit

- b. If the permittee chooses the compliance option in §63.1254(a)(2), the permittee shall not allow actual HAP emissions from the sum of all process vents within a

process (individual PMPU) not to exceed 900 kg (1894 lbs) in any 365-day period. Actual HAP emissions from the sum of all process vents within processes (all PMPUs) complying with §63.1254(a)(2)(i) are limited to a maximum of 1,800 kg (3,968 lbs) in any 365-day period.

Initial compliance is demonstrated by determining controlled HAP emissions by:

- (1) Computing the uncontrolled emissions from the PMPU and,
- (2) By applying a demonstrated control efficiency to obtain "controlled HAP emissions"

The process is described in the Test Methods and Compliance Procedures section Subpart GGG §63.1257(d)(1)(ii)(A). The permittee has chosen the process-based annual mass limit option for initial compliance. [Reg.19.304 and 40 C.F.R. § 63.1254(a)(2)]

- c. Emissions from vents that are subject to the requirements of §63.1254(a)(3) [individual vent emission reduction] and emissions from vents that are controlled in accordance with the procedures in §63.1254(c)[alternative standards] may be excluded from the sums calculated in §63.1254(a)(2)(i) and (ii).

Emissions from vents subject to 98% HAP control or to less than 20 ppmv and that are meeting the alternative standard requirements do not have to be included in the 900 kg or 1,800 kg actual HAP emissions sums in §63.1254(a)(2)(i) and (ii). [Reg.19.304 and 40 C.F.R. § 63.1254(a)(2)(iii)]

- d. The permittee may switch from compliance with §63.1254(a)(2) [process-based annual mass limit] to compliance with §63.1254(a)(1) [process-based reduction] after at least one year of operation in compliance with the §63.1254(a)(2) [process-based annual mass limit]. Notification of such a change in the compliance method shall be reported according to the procedures in §63.1260(h) [notification of process change]. [Reg.19.304 and 40 C.F.R. § 63.1254(a)(2)(iv)]

Individual vent emission reduction requirements

- e. If uncontrolled HAP emissions from a process vent exceeds 25 tons per year and the flow weighted average flowrate (FRA) is less than or equal to the flowrate index (FRI), the uncontrolled HAP emissions from the vent must be controlled to 98%, unless the vent is "grandfathered", installed on or before April 2, 1997. The permittee's RTOs were installed in 1992 and are "grandfathered" under the language of §63.1254(a)(3)(ii) and (A)(1), which requires a HAP emissions reduction greater than or equal to 93% by weight but less than 98% by weight. [Reg.19.304 and 40 C.F.R. § 63.1254(a)(3)]

STANDARDS: EQUIPMENT LEAKS

- OCI 13 Equipment means each pump, compressor, agitator, pressure relief device, sampling connection system, open-ended valve or line, valve, connector and instrumentation system in OHAP service. In OHAP service means that the equipment either contains or contacts a fluid, liquid or gas that is at least 5% by weight total OHAP. [Reg.19.304 and 40 C.F.R. § 63.1255]

General equipment leak requirements

- a. The provisions of §63.1255(a) apply to pumps, compressors, agitators, pressure relief devices, sampling connection systems, open-ended valves or lines, valves, connectors, instrumentation systems, control devices, and closed-vent systems that are intended to operate in OHAP service 300 hours or more during a calendar year within a source subject to this subpart. [Reg.19.304 and 40 C.F.R. § 63.1255(a)]

LDAR (Leak Detection and Repair) Provision summary

- b. An attached table provides a summary of the equipment leak requirements of Subpart GGG. Because of the complexities of the LDAR requirements, this table should be considered a reference tool only and the regulations should be referenced when developing a detailed plan of compliance. The permittee shall develop a comprehensive LDAR program to fully meet the Subpart GGG equipment leak requirements including developing a list of equipment and identification numbers subject to the requirements and a monitoring schedule. Connectors, except those determined to be unsafe-to-monitor, difficult to monitor, or inaccessible, do not have to be individually identified, but the lines must be identified. Physical tagging of components is not required by 40 CFR Part §63.1255(a)(7) and §63.1255(g)(2)(i)(C). [Reg.19.304 and 40 C.F.R. § 63.1255(a)(1)]

Summary of Equipment Leak Requirements for Subpart GGG ¹						
Equipment Pharma MACT/HON	Design Requirements/ Exemptions	Monitoring Frequency	Method	Leak Limit	Calculations	Recordkeeping Requirements (40 CFR §63.1255(g))
Pumps in Light Liquid Service (63.1255(c))		Quarterly with Instrument (If 10% of pumps or three of the pumps in the group of the process, leak, then monitor monthly) Weekly visual inspection	Method 21 (40 CFR Part 60 Appendix A) Method 21 (40 CFR Part 60 Appendix A) Visual	2,000 ppm 2,000 ppm	Calculate Leakers per 40 CFR Part 63.1255(c)(4) Calculate Leakers	<p>Keep records/statistics on leakers.</p> <p>Develop a list of identification numbers of equipment subject to the requirements of this section. List is to be updated within 15 calendar days of the completion of each monitoring survey. (Connectors need not be identified if all connectors or length of a pipe is designated as a group).</p> <p>Develop and keep a schedule for monitoring connectors and valves subject to the standards for connectors in gas/vapor and light liquid service</p> <p>Develop a list of compressors designated as operating at less than 500 ppm above the background.</p> <p>Develop a list of identification numbers of pressure relief devices in HAP service and/or equipped with rupture discs.</p>
Pressure Relief Devices in Gas/Vapor Service (§63.165)	OHAP Service Exempt if routed to vent header	Monitor after every pressure relief episode		Operated with instrument reading less than 500 ppm above background		
Sampling Connection Systems (63.166)	Must be equipped with closed purge, closed loop, or closed vent system. Shall return fluid to process line	Initially				

FutureFuel Chemical Company

Permit #: 1085-AOP-R16

AFIN: 32-00036

¹ Does not summarize the requirements of 40 CFR Part 63.169, standards for pumps, valves, connectors, and agitators in heavy liquid service, instrumentation systems; and pressure relieve devices in liquid service because these requirement do not apply to FutureFuel

Open-Ended Valves or Lines (§63.1255(d))	Must be equipped with flanges, plugs, or another valve If poses a safety hazard, is designed to open automatically, or if equipped with double block and bleed exempt by 40 CFR Part 63.1255(d)(4)-(6)	Initially				Develop a list of instrumentation systems used to comply with PAI regulations. For dual mechanical seal systems, record design criteria and changes. Keep a list of equipment designated as unsafe, difficult, or inaccessible to monitor, and a copy of plan to monitor these devices. Keep a list of any connectors removed or added to the process and documentation of the integrity of the weld for any removed connectors. Keep dates of visual inspections Keep records of initial pressure tests of compressors and pressure relief valves. Keep a record background and initial reading. Keep design data for closed vent systems
Valves in Gas/Vapor and Light Liquid Service (§63.1255(e))		Initial survey within 1 year of compliance date	Method 21 of 40 CFR Part 60 Appendix A	500 ppm	Calculate Leakers per 40 CFR Part 63.1255(e) (5)	
		>2% of leakers - monthly		500 ppm	Calculate Leakers	
		<2% of leakers - quarterly		500 ppm	Calculate Leakers	
		<1%-once/2 quarters		500 ppm	Calculate Leakers	
		<0.5%-once/4 quarters		500 ppm	Calculate Leakers	
Connectors in Gas/Vapor and in Light Liquid Service (§63.174)		Once within a year of compliance date	Method 21 of 40 CFR Part 60 Appendix A	500 ppm	Calculate Leakers Per 40 CFR Part 63.174(h)(3)(i)	Keep records of components in heavy liquid service, including analysis used to determine heavy liquid status. Maintain records of exempt components
		<0.5%-once/4 quarters			Calculate Leakers	

		<0.25% - every 2 years			Calculate Leakers	
Agitators in Gas/Vapor and Light Liquid Service (§63.1255(c))		Quarterly with instrument Weekly visual inspection	Method 21 of 40 CFR Part 60 Appendix A	10,000 ppm		

The following are key exemptions provided for the Subpart GGG standards for equipment leaks:

- i. Equipment that is intended to operate in OHAP service for less than 300 hours for a calendar year. [Reg.19.304 and 40 C.F.R. § 63.1255(d)(4)(viii)]
- ii. Equipment that is in vacuum service, which is operated at an internal pressure at least 5 kPa (0.725 psia) below ambient pressure, is excluded from the equipment leaks provisions of Subpart GGG. [Reg.19.304 and 40 C.F.R. § 63.1255(a)(8)]
- iii. Lines and equipment not containing process fluids are not subject to the LDAR requirements. Utilities and other non-process lines, such as heating and cooling systems which do not combine their materials with those in the processes they serve, are not considered part of a process and are not subject. [Reg.19.304 and 40 C.F.R. § 63.1255(a)(5)]

Consistency with other regulation

- c. After the compliance date for a process, equipment subject to both §63.1255(a)(2) and either 40 CFR Part 60 and Part 61 will be required to only comply with the provisions of Subpart GGG. [Reg.19.304 and 40 C.F.R. § 63.1255(a)(2)]
- d. The provisions of §63.1(a)(3) of Subpart A do not alter the provisions in §63.1255(a)(2). [Reg.19.304 and 40 C.F.R. § 63.1255(a)(4)]
- e. The permittee shall comply with all applicable portions of §63.1255(b) though (h), including all recordkeeping, reporting, and monitoring requirements necessary for submitting information required in the Notification of Compliance Status report under §63.1260(f). [Reg.19.304 and 40 C.F.R. § 63.1255(b)]

STANDARDS: WASTEWATER

OCI 14 The permittee shall comply with the general wastewater requirements §63.1256(a)(1) through (3), and the maintenance wastewater provisions of §63.1256(a)(4). The

permittee may transfer wastewater to a treatment operation not owned by the permittee in accordance with §63.1256(a)(5). [Reg.19.304 and 40 C.F.R. § 63.1256]

Identification of wastewater that requires control

- a. The permittee shall comply with the requirements in §63.1256(a)(1) (i) [determine characteristics of a wastewater stream] or (ii) [designate wastewater as affect wastewater] to determine whether a wastewater stream is an affected wastewater stream that requires control for soluble and/or partially soluble HAP compounds or to designate the wastewater stream as an affected wastewater stream, respectively. The permittee may use a combination of approaches in §63.1256(a)(1)(i) and (ii) for different affected wastewater generated at the source. [Reg.19.304 and 40 C.F.R. § 63.1256(a)(1)]

Requirements for affected wastewater

- b. The permittee shall comply with the applicable requirements for wastewater tanks, surface impoundments, containers, individual drains, systems, and oil/water separators as specified in §63.1256(b) through (f), except as provided in §63.1256(g)(3) [biological treatment process]. [Reg.19.304 and 40 C.F.R. § 63.1256(a)(2)(i)]
- c. The permittee shall comply with the applicable requirements for control of soluble and partially soluble compounds as specified in §63.1256(g) [performance standard for processes managing wastewater and/or residuals removed from wastewater]. Alternatively, the permittee may elect to comply with the treatment provisions specified in §63.1256(a)(5) [offsite treatment or onsite treatment not owned/operated by the source]. [Reg.19.304 and 40 C.F.R. § 63.1256(a)(2)(ii)]
- d. The permittee shall comply with the applicable monitoring and inspection requirements in §63.1258 [monitoring requirements]. [Reg.19.304 and 40 C.F.R. § 63.1256(a)(2)(iii)]
- e. The permittee shall comply with the applicable recordkeeping and reporting requirements in §63.1259 [recordkeeping] and §63.1260 [reporting]. [Reg.19.304 and 40 C.F.R. § 63.1256(a)(2)(iv)]

Requirements for multi-phase discharge

- f. The permittee shall not discharge a separate phase that can be isolated through gravity separation from the aqueous phase to a waste management or treatment unit, unless the stream is discharged to a treatment unit in compliance with §63.1256(g)(13) [treatment in RCRA unit option]. [Reg.19.304 and 40 C.F.R. § 63.1256(a)(3)]

Maintenance wastewater requirements

- g. The permittee shall comply with the requirements of §63.1256(a)(4)(i) through (iv) for maintenance wastewater containing partially soluble or soluble HAP listed in Tables 2 and 3 of Subpart GGG. Maintenance wastewater is exempt from all other provisions of Subpart GGG. [Reg.19.304 and 40 C.F.R. § 63.1256(a)(4)]

Offsite treatment or onsite treatment not owned or operated by the source

- h. The permittee may elect to transfer affected wastewater streams or a residual removed from such affected wastewater to an onsite treatment operation not owned or operated by the owner or operator of the source generating the wastewater or residual, or to an offsite treatment operation. [Reg.19.304 and 40 C.F.R. § 63.1256(a)(5)]

Wastewater tanks

- i. The permittee shall comply with the requirements of either §63.1256(b)(1) or (2) of Subpart GGG as specified in Table 6 of this subpart for each wastewater tank that receives, manages, or treats affected wastewater or a residual removed from affected wastewater.

The permittee does not have wastewater tanks associated with the present pharmaceutical processes. This condition does not apply until the permittee places tanks into service as wastewater tanks. [Reg.19.304 and 40 C.F.R. § 63.1250(b)]

Surface impoundments

- j. The permittee shall comply with §63.1256(c)(1),(2), and (3) of Subpart GGG for each surface impoundment that receives, manages, or treats affected wastewater or a residual removed from affected wastewater.

The permittee does not treat affected wastewaters or residuals in surface impoundments. This provision does not apply until such a time as the permittee chooses this treatment option. [Reg.19.304 and 40 C.F.R. § 63.1256(c)]

Containers

- k. The permittee shall comply with the requirements of §63.1256(d)(1) through (5) of Subpart GGG for each container that receives, manages, or treats affected wastewater or a residual removed from affected wastewater. [Reg.19.304 and 40 C.F.R. § 63.1256(d)]

Individual drain systems

1. The permittee shall comply with the requirements of §63.1256(e)(1), (2), and (3), or with §63.1256(e)(4), (5), and (6) of Subpart GGG for each individual drain system that receives or manages affected wastewater or a residual from affected wastewater.

The permittee does not have individual drain systems associated with the present pharmaceutical process. This condition does not apply unless the permittee installs individual drain systems meeting the applicability criteria. [Reg.19.304 and 40 C.F.R. § 63.1256(e)]

Oil/water separators

- m. The permittee shall comply with the requirements for oil/water separators that receives, manages, or treats affected wastewater or a residual removed from affected wastewater.

The permittee does not have oil/water separators associated with the pharmaceutical processes. This condition does not apply until such a time as the permittee implements this equipment. [Reg.19.304 and 40 C.F.R. § 63.1256(f)]

Performance standards for treatment processes managing wastewater and/or residuals removed from wastewater

- n. The permittee shall comply with the requirements in §63.1256(g)(1) through (6) of Subpart GGG. Where multiple compliance options are provided, the options may be used in combination for different wastewater and/or for different compounds (e.g. soluble versus partially soluble compounds) in the same wastewater, except where otherwise provided in Subpart GGG. Once affected wastewater or a residual removed from affected wastewater has been treated in accordance with Subpart GGG, it is no longer subject to the requirements of Subpart GGG. [Reg.19.304 and 40 C.F.R. § 63.1256(g)]

Existing source

- i. For a wastewater stream at an existing source that exceeds or is designated to exceed the concentration and load criteria in §63.1256(a)(1)(i)(A), the permittee shall comply with a control option in §63.1256(g)(8) [wastewater containing partially soluble HAP compounds]. For a wastewater stream at an existing source that exceeds the concentration and load criteria in either §63.1256(a)(1)(i)(B) or (C), the permittee shall comply with the control option in §63.1256(g)(8) and a control option in §63.1256(g)(9) [wastewater containing soluble HAP].

As an alternative to the control options in §63.1256(g)(8) and (9), the permittee may comply with a control option in either §63.1256(g)(10) [enhanced bio-treatment], (11) [95% mass reduction for biological treatment processes], or (13) [treatment in a RCRA unit], as applicable.

The permittee has initially chosen §63.1256(g)(13) [RCRA unit option] as the control option. [Reg.19.304 and 40 C.F.R. § 63.1256(g)(1)]

Biological treatment process

- ii. Biological treatment processes in compliance may be either open or closed biological treatment processes as defined in §63.1251. [Reg.19.304 and 40 C.F.R. § 63.1256(g)(3)]

Performance tests and Design evaluation

- iii. If the RCRA option specified in §63.1256(g)(13) or the enhanced biological treatment process for soluble HAP compounds option in §63.1256(g)(10) is selected, neither a design evaluation nor a performance test is required. For any other nonbiological treatment process, and for closed biological treatment processes as defined in §63.1251, the permittee shall conduct either a design evaluation as specified in §63.1257(e)(2)(ii) or performance test as specified in §63.1257(e)(2)(iii). For each open biological treatment process as defined in §63.1251, the permittee shall conduct a performance test as specified in §63.1257(e)(2)(iii)(E) or (F). [Reg.19.304 and 40 C.F.R. § 63.1256(g)(4)]

Control device requirements

- iv. When gases are vented from the treatment process, the permittee shall comply with the applicable control device requirements in §63.1256(h) [control device requirements] and §63.1257(e)(3) [test methods and compliance procedures – control device requirements], and the applicable leak inspection provisions specified in §63.1258(h) [leak inspection provisions for vapor suppression equipment]. This requirement is additional to the requirements for treatment systems specified in §63.1256(g)(8) [wastewater containing partially soluble HAP] and (14) [residuals]. This requirement does not apply to any open biological treatment process that meets the mass removal requirement. [Reg.19.304 and 40 C.F.R. § 63.1256(g)(5)]

Residuals: general

- v. When residuals result from treating affected wastewater, the permittee shall comply with the requirements for residuals specified in §63.1256(g)(14).

The permittee's current selected wastewater treatment process does not generate residuals. This condition does not apply until such time that the permittee selects an applicable treatment option that produces a residual. [Reg.19.304 and 40 C.F.R. § 63.1256(g)(6)]

Treatment using a series of treatment processes

- vi. In all cases where the wastewater provisions of Subpart GGG allow or require the use of a treatment process or control device to comply with emissions limitations, the permittee may use multiple treatment processes or control devices, respectively. For combinations of treatment processes where the wastewater stream is conveyed by hard-piping, the permittee shall comply with either §63.1256(g)(7)(i) [compliance across the combination of all treatment units or control devices in series], or (ii) [compliance across individual units]. For combinations of treatment processes where the wastewater stream is not conveyed by hard-piping, the permittee shall comply with the requirements in §63.1256(g)(7)(ii). For combinations of control devices, the permittee shall comply with the requirements of §63.1256(g)(7)(i) of Subpart GGG.

The permittee shall identify, and keep a record of, the combination of treatment processes, including identification of the first and last treatment process. The permittee shall include this information as part of the treatment process description reported in the Notification of Compliance status report. [Reg.19.304 and 40 C.F.R. § 63.1256(g)(7)]

Treatment in RCRA unit option

- vii. The permittee shall treat the affected wastewater or residual in a unit identified in, and complying with, §63.1256(g)(13)(i), (ii), or (iii) of Subpart GGG. These units are exempt from the design evaluation or performance tests requirements specified in §63.1256(g)(4) [performance tests and design evaluations] and §63.1257(e)(2) [compliance with treatment unit control provisions], and from the monitoring requirements specified in §63.1256(a)(2)(iii) [requirements for affected wastewater], as well as the recordkeeping and reporting requirements associated with monitoring and performance tests.

This is the initial compliance option performance standard the permittee has chosen for the management of affected wastewaters. [Reg.19.304 and 40 C.F.R. § 63.1256(g)(13)]

Residuals

- viii. When residuals are generated, the permittee shall control for air emissions by complying with §63.1256(b) through (f) of Subpart GGG, and by complying with one of the provisions in §63.1256(g)(14)(i) through (iv).

The permittee's current selected wastewater treatment option process does not generate residuals. This condition does not apply until the permittee selects a wastewater treatment option that produces a residual.

[Reg.19.304 and 40 C.F.R. § 63.1256(g)(14)]

Wastewater control devices

- o. For each control device or combination of control devices used to comply with the provisions of §63.1256(b) through (f) and §63.1256(g)(5) [control device requirements], the permittee shall operate and maintain the control device or combination of control devices in accordance with the requirements of §63.1256(h)(1) through (5) of Subpart GGG. [Reg.19.304 and 40 C.F.R. § 63.1256(h)]

TEST METHODS AND COMPLIANCE PROCEDURES: GENERAL

OCI 15 The permittee is subject to the following requirements of 40 CFR §63.1257:

- a. Except as provided in §63.1257(a)(5), the procedures specified in §63.1257(c) [storage tanks], (d) [process vents], (e) [wastewater], and (f) [pollution prevention] of Subpart GGG, are required to demonstrate initial compliance with §63.1253 [tanks], §63.1254 [process vents], §63.1256 [wastewater] and §63.1252(3) [heat exchangers], respectively. The provision in §63.1257(a)(2) through (3) apply to performance tests that are specified in §63.1257(c) [tanks], (d) [process vents], and (e) [wastewater]. The provisions in §63.1257(a)(5) of this section are used to demonstrate initial compliance with the alternative standards specified in §63.1253(d) [tanks] and §63.1254(c) [new source alternative standards]. The provisions in §63.1257(a)(6) [initial compliance with the 20 ppmv limit] are used to comply with the outlet concentration requirements specified in §§63.1253(c) [tanks], §63.1254(a)(2)(i) [process vent process-based annual mass limit] and §63.1254(a)(3)(ii)(B) [individual vent emission reduction], §63.1254(b)(i) [new sources], and §63.1256(h)(2) [control devices]. [Reg.19.304 and 40 C.F.R. § 63.1257(a)]

Test methods

- b. When testing is conducted to measure emissions from an affected source, the test methods specified in §63.1257(b)(1) through (10) shall be used. [Reg.19.304 and 40 C.F.R. § 63.1257(b)]

Initial compliance with storage tanks

- c. Initial compliance with the outlet concentration requirement of §63.1253(d) is demonstrated by fulfilling the requirements of §63.1257(a)(5).

The permittee does not currently operate any storage tank meeting the definition of PMPU storage tank. Therefore, the permittee is not currently subject to the storage tank standards of this subpart. The requirements of §63.1253 [storage tanks] do not apply until such time the permittee either installs or activates a tank for use in an applicable Pharmaceuticals Manufacturing Process Unit. Upon installing or activating a storage tank, which would be subject to this subpart, the permittee must at that time comply with the provisions of §63.1253, as well as the initial compliance provisions in §63.1257(c). [Reg.19.304 and 40 C.F.R. § 63.1257(c)]

Initial compliance with process vent provisions

- d. The permittee shall demonstrate compliance using the procedures described in §63.1257(d)(1) through (4) for the process vent standards in §63.1254 [process vents]. [Reg.19.304 and 40 C.F.R. § 63.1257(d)]

Compliance with wastewater provisions

- e. The wastewaters being treated in a RCRA unit are exempt from the design evaluation or performance tests requirements specified in §63.1256(g)(4) [performance testing and design evaluations] and §63.1257(e)(2), and from the monitoring requirements in §63.1256(a)(2)(iii) [requirements for affected wastewater], as well as the recordkeeping and reporting requirements associated with performance tests. [Reg.19.304 and 40 C.F.R. § 63.1256(g)(13) and §63.1257(e)(2)]

The permittee has chosen the RCRA treatment option specified in §63.1256(g)(13). If the permittee opts for wastewater treatment controls other than allowed by §63.1256(g)(13), the permittee will be subject to the applicable requirements of §63.1257(e) [compliance with wastewater provisions].

MONITORING REQUIREMENTS

OCI 16 The permittee is subject to the following requirements of 40 CFR §63.1258:

- a. The permittee shall provide evidence of continued compliance with the standard as specified. During the initial compliance demonstration, maximum or minimum operating parameter levels, as appropriate, shall be established for emission sources that will indicate the source is in compliance. Test data, calculations, or information from the evaluation of the control device design shall be used to establish the operating parameter level. [Reg.19.304 and 40 C.F.R. § 63.1258(a)]

Monitoring of control devices

- b. Except as provided by §63.1258(b)(1)(i), for each control device, the permittee shall install and operate monitoring devices and operate within the established parameter levels to ensure continued compliance with the standard. Monitoring parameters are specified for control scenarios in Table 4, and in §63.1258(b)(1)(ii) through (ix), of Subpart GGG. [Reg.19.304 and 40 C.F.R. § 63.1258(b)]

Averaging periods

- i. Averaging periods for parametric monitoring levels shall be established according to §63.1258(b)(2)(i) through (iii). [§19.304 of Regulation 19 and 40 CFR §63.[Reg.19.304 and 40 C.F.R. § 63.1258(b)(2)]

Procedures for setting parameter levels for control devices used to control emissions – Large control devices

- ii. For devices controlling greater than 10 tpy of HAP for which a performance test is required the parameter level must be established according to §63.1258(b)(3)(ii)(A) through (C). [Reg.19.304 and 40 C.F.R. § 63.1258(b)(3)(ii)]

Request approval to monitor alternative parameters

- iii. The permittee may request approval to monitor parameters other than those required by §63.1258(b)(1)(ii) through (ix). The request shall be submitted according to the procedures in §63.8(f) [use of an alternative monitoring method] or included in the Precompliance report. [Reg.19.304 and 40 C.F.R. § 63.1258(b)(4)]

Exceedances of operating parameters

- iv. Exceedance of an operating parameter is defined as one of the following: [Reg.19.304 and 40 C.F.R. § 63.1258(b)(6)]

1. If the parameter, averaged over the operating day or block, is below the minimum value established during the initial compliance determination;
2. If the parameter, average over the operating day or block, is above the maximum value established during the initial compliance test;
or
3. Each loss of pilot flame for flares.

Excursions

- v. Excursions are defined as either of the two cases listed in §63.1258(b)(7)(i) or (ii) as follows: [Reg.19.304 and 40 C.F.R. § 63.1258(b)(7)]
 1. When the period of control devices operation is 4 hours or greater in an operating day and monitoring data are insufficient to constitute a valid hour of data as defined in §63.1258(b)(7)(iii), for at least 75 percent of the operating day.
 2. When the period of control device operation is less than 4 hours in an operating day and more than one of the hours during the period of operation does not constitute a valid hour of data due to insufficient monitoring data, or
 3. Monitoring data are insufficient to constitute a valid hour of data, as used in §63.1268(b)(7)(i) and (ii). If measured values are unavailable for any of the required 15-minute periods within the hour.

Violations

- vi. Exceedances of parameters monitored according to §63.1258(b)(1)(ii), (iv) through (ix), and §63.1258(b)(5)(ii)(A) and (B), or excursions as defined by §63.1258(b)(7)(i) through (iii) constitute violations of the operating limit according to §63.1258(b)(8)(i), (ii), and (iv). Exceedances of the temperature limit monitored according to §63.1258(b)(1)(iii) or exceedances of the outlet concentrations monitored according to the provisions of §63.1258(b)(1)(x) constitute violations of the emission limit according to §63.1258(b)(8)(i), (ii), and (iv). Exceedances of the outlet concentration monitored according to §63.1258(b)(5) constitute violations of the emission limit according to the provisions of §63.1258(b)(8)(iii) and (iv) of Subpart GGG. [Reg.19.304 and 40 C.F.R. § 63.1258(b)(8)]

Monitoring for emission limits

- c. Compliance with §63.1254(a)(2) [process-based annual mass limit] shall demonstrate continuous compliance with the 900 and 1,800 kg/yr emission limits by calculating daily 365-day rolling summations of emissions. During periods of planned routine maintenance when emissions are controlled as specified in §63.1252(h), the permittee must calculate controlled emissions assuming the HAP emissions are reduced by 93 percent. If the permittee opts to switch compliance strategy from the 93 percent control requirement to the annual mass emission limit method, as described in §63.1254(a)(1)(i), the rolling summations beginning with the first day after the switch must include emissions from the past 365 days. [Reg.19.304 and 40 C.F.R. § 63.1258(c)]

Monitoring for equipment leaks

- d. If the permittee is complying with the requirements of §63.1255 [LDAR], the monitoring requirements of §63.1255 shall be met. [Reg.19.304 and 40 C.F.R. § 63.1258(d)]

Inspection and monitoring of waste management units and treatment processes

- e. The permittee shall comply with the inspection requirements specified in Table 7 of Subpart GGG for each wastewater tank, surface impoundment, container, individual drain system, and oil-water separator that receives, manages, or treats wastewater, a residual removed from wastewater, a recycled wastewater, or a recycled residual removed from wastewater. [Reg.19.304 and 40 C.F.R. § 63.1258(g)(1)]

Leak inspection provisions for vapor suppression equipment

- f. The permittee shall comply with the requirements of §63.1258(h)(2) through (8), except as provided in §63.1258(h)(9) and (10), for each vapor collection system, closed-vent system, fixed roof, cover, or enclosure required to comply with this section. [Reg.19.304 and 40 C.F.R. § 63.1258(h)]
- g. The permittee shall comply with the requirements of §63.1258(h)(10) in lieu of complying with the requirements of §63.1258(h)(2) through (8). The permittee shall maintain the closed-vent system below atmospheric pressure during normal RTO operation. The system shall be equipped with at least one pressure gauge or other pressure measurement device that can be read from a readily accessible location to verify that negative pressure is being maintained in the closed-vent system when the control devices are operating. [Reg.19.304 and 40 C.F.R. § 63.1258(h)(10)]

RECORDKEEPING REQUIREMENTS

OCI 17 The permittee is subject to the following requirements of 40 CFR §63.1259:

- a. The permittee shall comply with the recordkeeping requirements in Subpart A of Part 63, as specified in Table 1 of Subpart GGG and in §63.1259(a)(1) through (5). [Reg.19.304 and 40 C.F.R. § 63.1259(a)]

Records of equipment operation

- b. The permittee shall keep up-to-date and readily accessible records of equipment operation as specified in §63.1259(b)(1) through (13), which conform to the sources applicability determination and operations. [Reg.19.304 and 40 C.F.R. § 63.1259(b)]

Records of operating scenarios

- c. The permittee shall keep records of each operating scenario, which demonstrates compliance with Subpart GGG. [Reg.19.304 and 40 C.F.R. § 63.1259(c)]

Records of LDAR programs

- d. A requirement to implement a leak detection and repair (LDAR) program under §63.1255, shall require the permittee to implement the recordkeeping requirements of §63.1255 of Subpart GGG. [Reg.19.304 and 40 C.F.R. § 63.1259(d)]

Records of emission averaging

- e. If the permittee elects to comply with the requirements of §63.1252(d), the permittee shall maintain up-to-date records of the information specified in 63.1259(e)(1) through (4). [Reg.19.304 and 40 C.F.R. § 63.1259(e)]

Records of delay of repair

- f. Documentation of a decision to use a delay of repair due to unavailability of parts, as specified in §63.1256(i) [delay of repair – wastewater], shall include a description of the failure, the reason additional time was necessary (including a statement of why replacement parts were not kept onsite and when delivery from the manufacturer is scheduled), and the date when the repair was completed. [Reg.19.304 and 40 C.F.R. § 63.1259(f)]

Record of wastewater stream and residual transfer

- g. If the permittee transfers an affected wastewater stream or residual removed from an affected wastewater stream in accordance with §63.1256(a)(5) [offsite treatment or onsite treatment not owned/operated by the source] shall keep a record of the notice sent to the treatment operator stating that the wastewater

stream or residual contains organic HAP, which are required to be managed and treated in accordance with the provisions of Subpart GGG. [Reg.19.304 and 40 C.F.R. § 63.1259(g)]

Records of extension

- h. The permittee shall keep documentation of a decision to use an extension, as specified in §63.1256(b)(6)(ii) [wastewater tanks-floating roof] or (b)(9) [wastewater tanks – delay of repair], in a readily accessible location. The documentation shall include a description of the failure, documentation that alternate storage capacity is unavailable, and specification of a schedule of actions that will ensure that the control equipment will be repaired and the tank will be emptied as soon as possible. [Reg.19.304 and 40 C.F.R. § 63.1259(h)]

Currently, the permittee does not have wastewater tanks associated with the present pharmaceutical processes. This condition does not apply until the permittee places tanks into service as wastewater tank, upon which action this condition becomes effective.

Records of inspection

- i. The permittee shall keep records of all applicable inspection requirements as specified in §63.1259(i)(1) through (9). [Reg.19.304 and 40 C.F.R. § 63.1259(i)]

OCI 18 The permittee is subject to the following requirements of 40 CFR §63.1260:

- a. The permittee shall comply with the reporting requirements in §63.1260(b) through (l) of Subpart GGG. Applicable reporting requirements of §63.9 [notification requirements] and 63.10 [recordkeeping requirements] are also summarized in Table 1 of Subpart GGG. [Reg.19.304 and 40 C.F.R. § 63.1260(a)]

The Initial Notification report specified in §63.1260(b) was submitted to ADEQ on January 8, 1999. The Precompliance Report specified in §63.1260(e) was submitted to ADEQ on April 19, 2002.

Application for approval of construction or reconstruction

- b. Any application for approval of construction of a new major affected source, the reconstruction of a major affected source, or the reconstruction of a major source such that the source becomes a major affected source subject to the standards shall be prepared in accordance with §63.5(d) [application for approval of construction or reconstruction]. [Reg.19.304 and 40 C.F.R. § 63.1260(c)]

Notification of CMS performance evaluation

- c. Any owner/operator who is required by the Administrator to conduct a performance evaluation for a continuous monitoring system shall notify the Administrator of the date of the performance evaluation as specified in §63.8(e)(2). [Reg.19.304 and 40 C.F.R. § 63.1260(d)]

Notification of Compliance Status Report

- d. The Notification of Compliance Status report required under §63.9 shall be submitted no later than 150 days after the compliance date of October 21, 2002 and shall include information specified in §63.1260(f)(1) through (7). [Reg.19.304 and 40 C.F.R. § 63.1260(f)]

Periodic reports

- e. The permittee shall prepare Periodic Reports in accordance with §63.1260(g)(1) and (2) of Subpart GGG. [Reg.19.304 and 40 C.F.R. § 63.1260(g)]

Notification of process change

- f. Except as specified in §63.1260(h)(2), whenever a process change is made, or a change in any of the information in the Notification of Compliance Status Report, the permittee shall submit the information specified in §63.1260(h)(1)(i) through (iv) with the next Periodic Report required under §63.1260(g). [§19.304 of Regulation 19 and 40 CFR 63.1260(h)(1)]

Reports of startup, shutdown, and malfunction

- g. The permittee shall prepare startup, shutdown, and malfunction (SSM) reports as specified in §63.1260(i)(1) and (2). [Reg.19.304 and 40 C.F.R. § 63.1260(i)]

Reports of LDAR programs

- h. The permittee implementing the LDAR program specified in §63.1255 shall implement the reporting requirements in §63.1255 of Subpart GGG. Copies of all reports shall be retained as records for a period of 5 years, in accordance with the requirements of §63.10(b)(1) [recordkeeping and reporting]. [Reg.19.304 and 40 C.F.R. § 63.1260(j)]

Reports of emission averaging

- i. If the permittee chooses to comply with the requirements of §63.1252(d) [emission averaging provisions], the implementation plan required by §63.1259(e) [records of emission averaging] must be submitted 6-months prior to the compliance date of the standard and the following information in

§63.1260(k)(1) through (6) [reporting of emission averaging]. [Reg.19.304 and 40 C.F.R. § 63.1260(k)]

Notification of performance test and test plan

- j. The permittee shall notify the Administrator of the planned date of a performance test at least 60-days before the test in accordance with §63.7(b) [notification of performance tests]. The permittee shall also submit the test plan required by §63.7(c) [quality assurance program] and the emission profile required by §63.1257(b)(8)(ii) with the notification of the performance test. [Reg.19.304 and 40 C.F.R. § 63.1260(l)]

40 CFR Part 63, Subpart MMM, National Emission Standards for Pesticide Active Ingredient Production

APPLICABILITY

- OCI 19 A portion of this facility is subject to 40 CFR Part 63, Subpart MMM, National Emission Standards for Pesticide Active Ingredient Production. Applicable requirements include the following conditions. [Reg.19.304 and 40 C.F.R. § 63.1360]

Affected Source

- a. The permittee is an affected source subject to 40 CFR Part 63, Subpart MMM as defined in 40 CFR §63.1360(a) [Applicability]. The source is an existing source with a compliance date of December 23, 2003. [Reg.19.304 and 40 C.F.R. § 63.1360(a)]

General Provisions Requirements

- b. The provisions of Subpart A, specified in Table 1 of 40 CFR 63, Subpart MMM are the only general provisions that apply to an affected source subject to this subpart. [Reg.19.304 and 40 C.F.R. § 63.1360(c)]

Applicability of this Subpart except During Periods of Startup, Shutdown, and Malfunction

- c. The permittee shall comply with all applicable requirements of 40 CFR 63, Subpart MMM except that emission limitations shall not apply during periods of startup, shutdown, and malfunction as defined in 40 CFR §63.1361, provided the conditions in 40 CFR §63.1360(e)(1) through (4) are met. [Reg.19.304 and 40 C.F.R. § 63.1360(e)]

Storage Vessel Applicability Determination

- d. The permittee shall follow the procedures in 40 CFR §63.1360(f)(1) through (5) to determine whether a storage vessel is part of the affected PAI source. [Reg.19.304 and 40 C.F.R. § 63.1360(f)]

Designating Production of an Intermediate as a PAI Process Unit

- e. With the exception of 40 CFR §63.1360(d) [Exemptions]: The permittee may elect to designate production of any intermediate that does not meet the definition of integral intermediate as a PAI process unit. Storage vessels containing the intermediate is assigned to the PAI process unit according to the procedures in 40 CFR §63.1360(f) [storage vessel applicability determination]. Any process tank containing the intermediate is part of the process unit used to produce the intermediate. [Reg.19.304 and 40 C.F.R. § 63.1360(g)]

Applicability of Process Units Included in a Process Unit Group

- f. The permittee may elect to develop process unit groups in accordance with 40 CFR §63.1360(h)(1). For PAI process units in these process unit groups, the permittee may comply with the provisions in the overlapping MACT standards as specified in 40 CFR §63.1360(h)(2) through (4), as an alternative means of demonstrating compliance with this subpart. [Reg.19.304 and 40 C.F.R. § 63.1360(h)]

Overlap with other MACT Standards

- g. If the permittee is subject to the provisions of Subpart MMM and also subject to the provisions of any other subpart under 40 CFR Part 63, the permittee may elect, to the extent the subparts are consistent, under which subpart to maintain records and report to EPA. The permittee shall identify in the Notice of Compliance Status (NOCS) report required by 40 CFR §63.1368(f) under which subpart such records shall be maintained. [Reg.19.304 and 40 C.F.R. § 63.1360(i)(1)]

Overlap with RCRA Subparts AA, BB, and/or CC

- OCI 20 The permittee may elect to comply with the monitoring, reporting, and recordkeeping requirements of 40 CFR 63, Subpart MMM or RCRA Subparts AA, BB, and/or CC for devices covered under both regulations. Compliance with the recordkeeping, monitoring, and reporting requirements in 40 CFR Parts 264 and/or 265 shall constitute compliance with the monitoring, reporting and recordkeeping of Subpart MMM. The permittee shall identify in the NOCS report required in §63.1368(f) the authority under which compliance is demonstrated. [Reg.19.304 and 40 C.F.R. § 63.1360(i)(2)]

Overlap with NSPS Kb

- a. The permittee is only required to comply with the provisions of Subpart MMM for Group 1 and Group 2 storage vessels that are also subject to the requirements of 40 CFR 60, Subpart Kb. [Reg.19.304 and 40 C.F.R. § 63.1360(i)(3)]

Overlap with Subpart I

- b. If the permittee has equipment in a process unit subject to 40 CFR 63, Subpart I; the permittee may elect to comply with either Subpart MMM, or 40 CFR 63, Subpart H. The permittee shall identify in the NOCS report required in §63.1368(f) the elected option of compliance. [Reg.19.304 and 40 C.F.R. § 63.1360(i)(4)]

Overlap with RCRA Regulations for Wastewater

- c. If the permittee has affected wastewater streams subject to 40 CFR 260 through 272, compliance shall be based on the more stringent control requirements and the more stringent testing, monitoring, recordkeeping and reporting requirements that overlap between the requirements of Subpart MMM and Parts 260 through 272. The permittee shall keep a record of the information used to determine which requirements are the most stringent and shall submit this information if requested by the Administrator. [Reg.19.304 and 40 C.F.R. § 63.1360(i)(5)]

Overlap with NSPS Subparts III, NNN, and RRR

- OCI 21 If the permittee has any process vent subject to Subpart MMM that is also subject to 40 CFR 60, Subparts III, NNN, or RRR and elects to reduce organic HAP emissions from the process vent by 98% as specified in §63.1362(b)(2)(iii)(A), then the permittee is only required to comply with Subpart MMM. Otherwise the permittee shall comply with Subpart MMM and the provisions of 40 CFR 60 Subparts III, NNN, and RRR as applicable. [Reg.19.304 and 40 C.F.R. § 63.1360(i)(6)]

Meanings of Periods of Time

- a. All terms of Subpart MMM that define a period of time for completion of required tasks (e.g., weekly, monthly, quarterly, annual), unless specified otherwise in §63.1360 [Applicability], or subsection that imposes the requirement, refer to standard calendar periods of time. [Reg.19.304 and 40 C.F.R. § 63.1360(j)]

DEFINITIONS

- OCI 22 Terms used in Subpart MMM are defined in the CAA, in Subpart A of 40 CFR 63, or in §63.1361. If the same term is defined in Subpart A and in §63.1361, it shall have the same meaning given in §63.1361 for the purposes of Subpart MMM. [Reg.19.304 and 40 C.F.R. § 63.1361]

STANDARDS

- OCI 23 The permittee is subject to the following requirements of 40 CFR §63.1362:
- a. Affected sources subject to Subpart MMM shall control HAP emission to the levels specified in §63.1362 [Standards: General] and in §63.1363 [Standards: Equipment Leaks], as summarized in Table 2 of Subpart MMM. [Reg.19.304 and 40 C.F.R. § 63.1362(a)]

Process Vents

- b. Subpart MMM existing sources shall comply with the requirements of §63.1362(b)(2) and (3). New sources shall comply with the requirements of §63.1362(b)(4) and (5). Compliance with §63.1362(b)(2) through (5) shall be demonstrated through the applicable test methods and initial compliance procedures in §63.1365 and the monitoring requirements in §63.1366. [Reg.19.304 and 40 C.F.R. § 63.1362(b)(1)]

Organic HAP Emissions from Existing Sources

- c. Existing effected sources must comply with the requirements in either §63.1362(b)(2)(i), or with §63.1362(b)(2)(ii) through (iv). [Reg.19.304 and 40 C.F.R. § 63.1363(b)(2)]
 - i. The uncontrolled organic HAP (OHAP) emission rate shall not exceed 0.15 Mg/yr from the sum of all process vents within a process. [Reg.19.304 and 40 C.F.R. § 63.1362(b)(2)(i)]

The permittee has chosen to not comply with the option under §63.1362(b)(2)(i) at the present time, but reserves the ability to switch to this option at a later date providing proper notification under §63.1368(f).

- ii. Except as provided in §63.1361(b)(2)(ii)(B): Uncontrolled OHAP emissions from a process vent shall be reduced by 98% by weight or greater if the flow-weighted average flow rate for the vent, as calculated using Equation 1 is less than or equal to the flow rate using Equation 2 as specified in §63.1362(b)(2)(ii). [Reg.19.304 and 40 C.F.R. § 63.1362(b)(2)(ii)(A)]

The requirement under 63.1362(b)(2)(ii)(A) is not applicable at the present time, but the permittee may switch to this option at a later date providing proper notification under §63.1368(f)

- iii. Control devices installed on or before November 10, 1997 on a process vent subject to §63.1362(b)(2)(ii)(A), and reducing inlet emissions of the total organic HAP by greater than 90% by weight, but less than 98% by weight, must be operated to reduce inlet emissions of total organic HAP by 90% weight or greater. [Reg.19.304 and 40 C.F.R. § 63.1362(b)(2)(ii)(B)]

This option does not apply at present to the permittee's operations. The permittee may comply with this option at a later date providing proper notification under §63.1368(f).

- iv. The permittee shall reduce, uncontrolled organic HAP emissions from the sum of all process vents within a process shall be reduced by 90% or greater by weight, excluding process vents that are subject to §63.1362(b)(2)(ii). [Reg.19.304 and 40 C.F.R. § 63.1362(b)(2)(iii)]
- v. As an alternative to §63.1362(b)(2)(ii) and (iii), uncontrolled OHAP emissions from any process vent may be reduced in accordance with and of the provisions in §63.1362(b)(2)(iv)(A) through (D) as listed below. All remaining process vents must be controlled in accordance with §63.1362(b)(2)(ii) and (iii). [Reg.19.304 and 40 C.F.R. § 63.1362(b)(2)(iv)]
 1. To outlet concentrations less than or equal to 20 ppmv; or
 2. By a flare that meets the requirements of §63.11(b); or
 3. By a control device specified in §63.1365(a)(4); or
 4. In accordance with the alternative standard specified in §63.1362(b)(6).

HCL and CL Emissions from Existing Sources

- d. The permittee shall comply with either of the following emission reduction requirements for HCL and CL from existing process vents:
 - i. The uncontrolled HCL and CL emissions, including HCL generated from the combustion of halogenated process vent emissions, from the sum of all process vents within a process shall not exceed 6.8 Mg/yr; or
 - ii. HCL and CL emissions, including HCL generated from combustion of halogenated process vent emissions, from the sum of all process vents

within a process shall be reduced by 94% or greater or to outlet concentrations less than or equal to 20 ppmv.

[Reg.19.304 and 40 C.F.R. § 63.1362(b)(3)]

Alternative Standard – Process Vents

- e. As an alternative to the standards for existing and new process vent emission control requirements, the permittee may route emissions from a process vent to a combustion control device achieving an outlet TOC concentration (calibrated on methane or the predominate HAP) of 20 ppmv or less, and an outlet concentration of HCL and CL of 20 ppmv or less. If routing to a non-combustion control device or series of control devices, the control device(s) must achieve an outlet TOC concentration of 50 ppmv or less, and an outlet concentration of HCL and CL of 50 ppmv or less. Process vents not routed to a control device must be controlled according to §63.1362(b)(2)(ii) through (iv), §63.1362(b)(3)(ii), §63.1362(b)(4)(ii), §63.1362(b)(5)(ii) or (iii) of Subpart MMM. [Reg.19.304 and 40 C.F.R. § 63.1362(b)(6)]

Storage Vessels

- f. The permittee shall either determine the group status of a storage vessel or designate it as a Group 1 storage vessel. Storage vessels designated as Group 1 are not required to have the maximum true vapor pressure of the material stored to be determined. [Reg.19.304 and 40 C.F.R. § 63.1362(c)]

Storage Vessel Standard for Existing Sources

- i. Except as specified in §63.1362(c)(4), (5), and (6), the permittee shall equip each Group 1 storage vessel at an existing affected source with one of the following:
 - 1. A fixed roof and internal floating roof; or
 - 2. An external floating roof; or
 - 3. An external floating roof converted to an internal floating roof; or
 - 4. A closed-vent system meeting the requirements in §63.1363(j) [closed-vent systems] and a control device that meets any of the following conditions:
 - 5. Reduces organic HAP emissions by 95% weight or greater; or
 - 6. Reduces organic HAP emissions to outlet concentrations of 20 ppmv or less; or
 - 7. Is a flare meeting the requirements of §63.11(b); or
 - 8. Is a control device specified in §63.1365(a)(4) [boiler/process heater].

[Reg.19.304 and 40 C.F.R. § 63.1362(c)(2)(i) through (iv)]

Storage Vessel Standard for New Sources

- ii. Presently the permittee is not subject to the new source requirements for storage vessels. The new source provisions do not apply until such time that the permittee installs or modifies a PAI storage vessel to meet the definition of new affected source as defined in §63.1361. Group 1 storage vessels at a new source shall equip the affected storage vessel with any of the controls specified in §63.1362(c)(2)(i) through (iv) listed above. [Reg.19.304 and 40 C.F.R. § 63.1362(c)(3)]

Storage Vessels – Alternative Standard

- iii. As an alternative to the standards for existing and new storage vessel emission control requirements, the permittee may route emissions from a storage vessel to a combustion control device achieving an outlet TOC concentration (calibrated on methane or the predominate HAP) of 20 ppmv or less, and an outlet concentration of HCL and CL of 20 ppmv or less. If routing to a non-combustion control device or series of control devices, the control devices(s) must achieve an outlet TOC concentration of 50 ppmv or less, and an outlet concentration of HCL and CL of 50 ppmv or less. [Reg.19.304 and 40 C.F.R. § 63.1362(c)(4)]

Storage Vessel Planned Routine Maintenance

- iv. The permittee is exempt from the storage vessel existing and new source standards and the alternative standard during periods of planned routine maintenance of the control device that does not exceed 240 hours/yr. The permittee may submit an extension to the Administrator requesting an extension of this time limit to 360 hours/yr. The request must explain why the extension is needed and it must indicate that no material will be added to the storage vessel between the time the 240-hour limit is exceeded and this control device is again operational. The request must be submitted at least 60-days before the 240 hour limit will be exceeded. [Reg.19.304 and 40 C.F.R. § 63.1362(c)(5)]

Storage Vessel – Vapor Balancing Alternative

- v. As an alternative to the storage vessel existing and new source standards, the permittee may implement vapor balancing as specified in §63.1362(c)(6)(i) through (vii). [Reg.19.304 and 40 C.F.R. § 63.1362(c)(6)]

Storage Vessel Compliance Provisions

- vi. Compliance with storage vessel existing and new source standards is demonstrated using the initial compliance procedures in §63.1365(d) [Initial compliance with storage vessel provisions] and the monitoring requirements in §63.1366 [Monitoring and inspection requirements]. Compliance with outlet concentrations in the alternative standard shall be determined by the initial compliance provisions in §63.1365(a)(5) and the continuous emission monitoring requirements in §63.1366(b)(5). [Reg.19.304 and 40 C.F.R. § 63.1362(c)(7)]

WASTEWATER

- OCI 24 The permittee shall comply with the requirements of 40 CFR §63.132 through §63.147, with the differences noted in §63.1362(d)(1) through (16) for the purpose of compliance with Subpart MMM. [Reg.19.304 and 40 C.F.R. § 63.1362(d)]

Definitions

- a. When the term “process wastewater is referred to in §63.132 through §63.147 of Subpart G, the term “wastewater” as defined in §63.1361 shall apply for the purposes of Subpart MMM. [Reg.19.304 and 40 C.F.R. § 63.1362(d)(7)]
- b. When the term “Group 1 wastewater stream” is used in §63.132 through §63.147 of Subpart G, the definition of “Group 1 wastewater stream” in §63.1361 shall apply for both new and existing sources for the purposes of Subpart MMM. [Reg.19.304 and 40 C.F.R. § 63.1362(d)(8)]
- c. When the term “Storage vessel” is used in §63.119 through §63.123 of Subpart G, the definition of “storage vessel” in §63.1361 shall apply for the purposes of Subpart MMM. [Reg.19.304 and 40 C.F.R. § 63.1362(d)(2)(i)]

Statement of Table 8 Non-Applicability

- d. The requirements in §63.132 through §63.147 for compounds listed on Table 8 of Subpart G shall not apply for the purposes of Subpart MMM. [Reg.19.304 and 40 C.F.R. § 63.1362(d)(9)]

EXISTING SOURCE WASTEWATER PROVISIONS – GENERAL

- OCI 25 The permittee shall comply with the requirements of §63.132(a)(1) through (3) no later than the applicable date of Subpart MMM. [Reg.19.304 and 40 C.F.R. § 63.132(a)]

Determination of Group 1 or Group 2 Status for Table 9 Compounds

- a. The permittee shall determine the Group 1 or Group 2 status for Table 9 compounds according to the requirements of §63.132(c). [Reg.19.304 and 40 C.F.R. § 63.132(c)]

Designation of a Group 1 Wastewater Stream

- b. The permittee may elect to designate a wastewater stream a Group 1 wastewater stream in order to comply with the requirements of §63.132(a)(1) or (b)(1) by following the procedures in §63.132(e). [Reg.19.304 and 40 C.F.R. § 63.132(e)]
- c. The permittee shall not discard liquid or solid organic materials with a concentration of greater than 10,000 ppm of Table 9 compounds (as determined by analysis of the stream composition, engineering calculations, or process knowledge, according to the provisions of §63.144(b) of this subpart) from a chemical manufacturing process unit to water or wastewater, unless the receiving stream is managed and treated as a Group 1 wastewater stream. This prohibition does not apply to materials from the activities listed in §63.132(f)(1) through (f)(4) below:
 - i. Equipment leaks;
 - ii. Activities included in maintenance or SSM plans;
 - iii. Spills; or
 - iv. Samples of a size not greater than reasonably necessary for the method of analysis that is used.

[Reg.19.304 and 40 C.F.R. § 63.132(f)]

Off-site Treatment not Owned or Operated by the Source

- d. The permittee may elect to transfer Group 1 wastewater or residuals removed from Group 1 wastewater streams to an off-site treatment operation by complying with the requirements of §63.132(g). [Reg.19.304 and 40 C.F.R. § 63.132(g)]

PROCESS WASTEWATER PROVISIONS – WASTEWATER TANKS

OCI 26 The permittee is subject to the following requirements of 40 CFR §63.133:

- a. The permittee shall comply with either §63.133(a)(1) or (2), as specified in Table 10, for each wastewater tank that receives, manages, or treats a Group 1 wastewater stream or wastewater residual removed from a wastewater stream. [Reg.19.304 and 40 C.F.R. § 63.133(a)]

- b. The maximum true vapor pressures in Table 10 shall be limited to the HAP listed in Table 9 to 40 CFR 63, Subpart G. [Reg.19.304 and 40 C.F.R. § 63.1362(d)(15)]
- c. The permittee shall comply with the requirements of §63.133(a)(2)(i) for fixed-roof tanks. The fixed roof shall meet the requirements of §63.133(b)(1), the control device shall meet the requirements of §63.133(b)(2), and the control device shall meet the requirements of §63.133(b)(3). [Reg.19.304 and 40 C.F.R. § 63.133(b)]
- d. The permittee shall inspect each wastewater tank initially, and semi-annually for improper work practices in accordance with 63.143, with the exception provided in §63.133(e)(2). [Reg.19.304 and 40 C.F.R. § 63.133(f)]
- e. The permittee shall inspect each wastewater tank for control equipment failures as specified in §63.133(g)(1) through (3). [Reg.19.304 and 40 C.F.R. § 63.133(g)]
- f. The permittee shall initiate first efforts to repair control equipment failures or improper work practices within 5 calendar days, and complete the repairs within 45 calendar days. Two extensions of up to 30 additional calendar days each may be utilized provided documentation supporting the decision as identified in §63.133(h) is maintained. [Reg.19.304 and 40 C.F.R. § 63.133(h)]

PROCESS WASTEWATER PROVISIONS – SURFACE IMPOUNDMENTS

OCI 27 The permittee is subject to the following requirements of 40 CFR §63.134:

The permittee shall comply with §63.134(a) through (d) for each surface impoundment that receives, manages, or treats a Group 1 wastewater stream or residual removed from a Group 1 wastewater stream. [Reg.19.304 and 40 C.F.R. § 63.134(a)]

Presently, the permittee does not treat Group 1 wastewaters or residuals in surface impoundments. This specific condition does not apply until such time as the permittee chooses this option.

PROCESS WASTEWATER PROVISIONS – CONTAINERS

OCI 28 The permittee is subject to the following requirements of 40 CFR §63.135:

The permittee shall comply with §63.135(b) through (f) for each container that receives, manages or treats a Group 1 wastewater stream or a residual from a Group 1 wastewater stream. [Reg.19.304 and 40 C.F.R. § 63.135(a)]

PROCESS WASTEWATER – INDIVIDUAL DRAIN SYSTEMS

OCI 29 The permittee is subject to the following requirements of 40 CFR §63.136:

The permittee shall comply with the requirements in §63.136(b) through (d), or with §63.136(e) through (g) for each individual drain system that receives or manages a Group 1 wastewater stream or residual from a Group 1 wastewater stream. [Reg.19.304 and 40 C.F.R. § 63.136(a)]

PROCESS WASTEWATER – OIL/WATER SEPARATORS

OCI 30 The permittee is subject to the following requirements of 40 CFR §63.137:

- a. The permittee shall comply with §63.137(c) and (d) for each oil-water separator that receives, manages, or treats a Group 1 wastewater stream or residual from a Group 1 wastewater stream, and shall maintain and operate a fixed roof and closed-vent system and control device as specified in §63.137(a)(1), and which meets the requirements of §63.137(b). [Reg.19.304 and 40 C.F.R. § 63.137(a)]
- b. As an alternative to §63.137(a)(1), the permittee may elect to comply with the floating roof requirements in §63.137(a)(2), or an equivalent means of emission limitation as specified in §63.137(a)(3). [Reg.19.304 and 40 C.F.R. § 63.137(a)(2) and (3)]
- c. The permittee shall inspect each oil-water separator initially, and semi-annually for improper work practices in accordance with §63.143. [Reg.19.304 and 40 C.F.R. § 63.137(d)]
- d. The permittee shall inspect each wastewater tank for control equipment failures as specified in §63.137(e). [Reg.19.304 and 40 C.F.R. § 63.137(e)]
- e. Except as provided in §63.140, when an improper work practice or control equipment failure is identified, the first attempt at repair shall be made no later than 5 calendar days after identification and repair shall be completed within 45 calendar days. [Reg.19.304 and 40 C.F.R. § 63.137(f)]

PROCESS WASTEWATER PROVISIONS – PERFORMANCE STANDARDS FOR TREATMENT PROCESSES MANAGING GROUP 1 WASTEWATER STREAMS

OCI 31 The permittee is subject to the following requirements of 40 CFR §63.138:

General Requirements

- a. The permittee shall comply with the requirements specified in §63.138(a)(1) through (6). Where multiple compliance options are provided, the options may be used in combination for different wastewater streams and/or different compounds in the same wastewater streams, except where otherwise provided in §63.138. Once a Group 1 stream or residual removed from a Group 1 stream has been treated in accordance with Subpart MMM, it is no longer subject to the requirements of Subpart MMM. [Reg.19.304 and 40 C.F.R. § 63.138(a)]

Existing Source

- i. The permittee is an existing source for the purpose of these requirements. If the wastewater stream is Group 1 for Table 9 compounds, the permittee shall comply with §63.138(b). [Reg.19.304 and 40 C.F.R. § 63.138(a)(1)]

New Source

- ii. If the permittee becomes subject to the new source wastewater standard, the permittee shall comply with §63.138(a)(2) for Group 1 compounds in a Table 9, as determined by the procedures in §63.132. [Reg.19.304 and 40 C.F.R. § 63.138(a)(2)]

Control Options: Group 1 Wastewater Streams for Table 9 Compounds

- b. The permittee shall comply with §63.138(b)(2) [other compliance options] for the control of Table 9 compounds. [Reg.19.304 and 40 C.F.R. § 63.138(b)]

Options:

- i. Operate a design steam stripper meeting the requirements of §63.138(d);
- ii. Percent mass removal option meeting the requirements of §63.138(e);
- iii. Required mass removal option meeting the requirements of §63.138(f);
- iv. 95% required mass removal option for biological treatment processes meeting the requirements of §63.138(g);
- v. Treatment in a RCRA unit option meeting the requirements of §63.138(h); or
- vi. One megagram total source mass flow rate option meeting the requirements of §63.138(i).

[Reg.19.304 and 40 C.F.R. § 63.138(b)(1) and (b)(2)]

Design Evaluations or Performance Tests for Treatment Processes

- c. The permittee shall demonstrate compliance with the elected treatment option by following the requirements of §63.138(j), as applicable to the treatment option

specified, with the exceptions provided in §63.138(j)(3) or §63.138(h).
[Reg.19.304 and 40 C.F.R. § 63.138(j)]

Exemptions from Performance Testing and Design Analysis

- d. The provisions of §63.138(j)(1) [design evaluation – mass balance] and (j)(2) [performance tests] do not apply to steam strippers which meet the requirements of §63.138(d). [Reg.19.304 and 40 C.F.R. § 63.138(j)(3)]
- e. The provisions of §63.138(h) [RCRA unit treatment option] exempt the permittee from the design evaluation and performance test requirements specified in §63.138(a)(3) and §63.138(j), and from the monitoring requirements specified in §63.132(a)(2)(iii) and §63.132(b)(3)(iii), as well as the recordkeeping and reporting requirements associated with monitoring and performance tests. [Reg.19.304 and 40 C.F.R. § 63.138(j) and §63.138(h)]

Residuals

- f. The permittee shall control residuals from Group 1 wastewater streams by complying with §63.133 through §63.137 and by complying with one of the following options:
 - i. Recycle the residual to a production process or sell the residual for the purpose of recycling. Once a residual is returned to the production process, the residual is no longer subject to Subpart MMM;
 - ii. Return the residual to the treatment process;
 - iii. Treat the residual to destroy the total combined mass flow rate of Table 9 compounds by more than 99% or more; or
 - iv. Comply with the requirements for RCRA treatment options specified in §63.138(h).

[Reg.19.304 and 40 C.F.R. § 63.138(k)]

PROCESS WASTEWATER PROVISIONS – CONTROL DEVICES

OCI 32 The permittee is subject to the following requirements of 40 CFR §63.139:

The permittee shall operate and maintain control device or combination of control devices in accordance with §63.138(b) through (f) for control devices used to comply with the requirements of §63.133 through §63.138. [Reg.19.304 and 40 C.F.R. § 63.139(a)]

PROCESS WASTEWATER PROVISIONS – DELAY OF REPAIR

OCI 33 The permittee is subject to the following requirements of 40 CFR §63.140:

The permittee is allowed delays in repair of equipment for which a control equipment failure or a gap, crack, tear, or hole has been identified, provided the permittee complies with the exceptions specified in §63.140(a) through (c). [Reg.19.304 and 40 C.F.R. § 63.140(a) through (c)]

PROCESS WASTEWATER PROVISIONS – INSPECTIONS AND MONITORING OF OPERATIONS

OCI 34 The permittee is subject to the following requirements of 40 CFR §63.143:

- a. The permittee shall comply with the inspection requirements in Table 11 for each wastewater tank, surface impoundment, container, individual drain system, and oil-water separator that receives, manages, or treats a Group 1 wastewater stream, a residual removed from a Group 1 wastewater stream, a recycled Group 1 wastewater stream, or recycled residual removed from a Group 1 wastewater stream. [Reg.19.304 and 40 C.F.R. § 63.143(a)]
- b. The permittee shall comply with the monitoring requirements in Table 12 for each design steam stripper and biological treatment unit used to comply with §63.138. [Reg.19.304 and 40 C.F.R. § 63.143(b)]
- c. If the permittee elects to comply with Item 1 of Table 12, the permittee shall request approval to monitor appropriate parameters that demonstrate proper operation of the biological treatment unit. The request shall be submitted according to the procedures in §63.151(f) and shall include a description of the planned reporting and recordkeeping procedures. The basis for the selected monitoring frequencies and the methods used shall be included in the submittal. [Reg.19.304 and 40 C.F.R. § 63.143(c)]
- d. If the permittee elects to comply with Item 3 of Table 12, the permittee shall request approval to monitor appropriate parameters that demonstrate proper operation of the selected treatment process. The request shall be submitted according to the procedures in §63.151(f) and shall include a description of the planned reporting and recordkeeping procedures. [Reg.19.304 and 40 C.F.R. § 63.143(d)]
- e. For each control device used to comply with the requirements of §63.133 through §63.139, the permittee shall comply with the requirements of §63.139(d), and with the requirements of §63.143(e)(1), (e)(2), or (e)(3), except as provided in §63.143(e)(4) and (5). [Reg.19.304 and 40 C.F.R. § 63.143(e)]

- f. The permittee shall establish a range that indicates proper operation of the treatment process or control device for each parameter monitored in accordance with §63.143(c), (d), or (e). In order to establish the range, the permittee shall comply with the requirements of §63.146(b)(7)(ii)(A) and (b)(8)(ii). [Reg.19.304 and 40 C.F.R. § 63.143(f)]
- g. Monitoring equipment shall be installed, calibrated, and maintained according to the manufacturer's specifications or other written procedures that provide adequate assurance that the equipment would be reasonably expected to monitor accurately. [Reg.19.304 and 40 C.F.R. § 63.143(g)]

PROCESS WASTEWATER PROVISIONS – TEST METHODS AND PROCEDURES FOR DETERMINING APPLICABILITY AND GROUP 1/GROUP 2 DETERMINATION
(Determining which Wastewater Streams Require Control)

OCI 35 The permittee is subject to the following requirements of 40 CFR §63.144:

The permittee shall comply with §63.144(a)(1) [determine Group 1 or Group 2 status] or (a)(2) [designate as Group 1] for each wastewater stream to determine which wastewater streams require control for Table 9 compounds. The permittee may use a combination of the approaches in §63.144(a)(1) or (a)(2) for different wastewater streams generated at the source. [Reg.19.304 and 40 C.F.R. § 63.144(a)]

- a. The permittee may determine the Group 1 and Group 2 status under §63.144(a)(1) and use the procedures in 63.144(b) to establish concentration limits, and 63.144(c) to determine flow rates. [Reg.19.304 and 40 C.F.R. § 63.144(a)(1)]
- b. The permittee may designate as a Group 1 wastewater stream a single wastewater stream or mixture of wastewater streams under §63.144(a)(2). The permittee is not required to determine the concentration of flow rate of each designated Group 1 wastewater stream for the purposes of §63.144. [Reg.19.304 and 40 C.F.R. § 63.144(a)(2)]

PROCESS WASTEWATER PROVISIONS – TEST METHODS AND PROCEDURES TO DETERMINE COMPLIANCE

OCI 36 The permittee is subject to the following requirements of 40 CFR §63.145:

General

§63.145 specifies the procedures for performance tests that are conducted to demonstrate compliance of a treatment process or a control device with the control requirements specified in §63.138. If conducting a design evaluation, the permittee shall comply with the requirements of §63.145(a)(1) and (a)(2). If conducting a performance test, the permittee shall comply with the requirements in §63.145(a) through (i). [Reg.19.304 and 40 C.F.R. § 63.145(a)]

Performance Tests and Design Evaluations for treatment Processes

- a. If the permittee has chosen the design steam stripper option in §63.138(d), or RCRA option in §63.138(h) to comply with §63.138, neither a design evaluation nor a performance test is required. [Reg.19.304 and 40 C.F.R. § 63.145(a)(1)]
- b. If the permittee chooses to use any other non-biological treatment process, the permittee shall conduct either a design evaluation as specified in §63.138(j), or a performance test as required in §63.145. [Reg.19.304 and 40 C.F.R. § 63.145(a)(1)]
- c. If the permittee chooses to use a closed biological treatment process, the permittee shall conduct either a design evaluation according to §63.138(j), or a performance test according to §63.145. If using an open biological treatment system, the permittee shall conduct a performance test according to §63.145. [Reg.19.304 and 40 C.F.R. § 63.145(a)(1)]

PROCESS WASTEWATER PROVISIONS – REPORTING

OCI 37 The permittee is subject to the following requirements of 40 CFR §63.146:

- a. For each waste management unit, treatment process, or control device used to comply with §63.138(b)(1), (c)(1), (d), (e), (f), or (g) for which the permittee seeks to monitor a parameter other than those specified in Tables 11, 12, or 13, the permittee shall submit a request for approval to monitor alternative parameters according to the procedures in §63.8(f) of Subpart A, as referenced in §63.1366(b)(4). [Reg.19.304 and 40 C.F.R. § 63.146(a), 63.8(f), 63.1362(d)(3), and §63.1366(b)(4)]
- b. The permittee shall submit the information specified in §63.146(b)(1) through (b)(9) as part of the Notification of Compliance Status report required by §63.1368(f) of Subpart MMM. [Reg.19.304 and 40 C.F.R. § 63.146(b), §63.1368(f), and §63.1362(d)(4)]
- c. The permittee shall submit as part of the Periodic Report required by §63.1368(g) the results of each inspection required by §63.143(a). Each Periodic

Report shall include the date of the inspection, identification of each waste management unit in which a control equipment failure was detected, description of the failure, and description of the nature of and date the repair was made for each waste management unit that receives, manages, or treats a Group 1 wastewater stream or residual removed from a Group 1 wastewater stream. [Reg.19.304 and 40 C.F.R. § 63.146(c), §63.1362(d)(6) and §63.1368(g)]

- d. The permittee shall submit as part of the Periodic Report required by §63.1368(g) the information specified in §63.146(d)(1) through (3) for the monitoring required by §63.143(b), (c), and (d). [Reg.19.304 and 40 C.F.R. § 63.146(d) and §63.1368(g)]
- e. The permittee shall submit as part of the Periodic Report the information specified in §63.146(e)(1) or (e)(2) for each control device used to comply with §63.133 through §63.139. [Reg.19.304 and 40 C.F.R. § 63.146(e)]
- f. If the permittee utilizes and extension for delay or repair in accordance with §63.133(e)(2) or §63.133(h) the information shall be included in the next Periodic Report. [Reg.19.304 and 40 C.F.R. § 63.146(g)]

PROCESS WASTEWATER PROVISIONS – RECORDKEEPING

OCI 38 The permittee is subject to the following requirements of 40 CFR §63.147:

- a. If the permittee transfers a Group 1 wastewater stream or residual removed from a Group 1 stream in accordance with §63.132(g), the permittee shall keep a record of the notice sent to the treatment operating stating that the wastewater stream or residual contains organic HAP which are required to be managed and treated in accordance with the provisions of this subpart. [Reg.19.304 and 40 C.F.R. § 63.147(a)]
- b. The permittee shall keep in a readily accessible location the records specified in §63.147(b)(1) through (8). [Reg.19.304 and 40 C.F.R. § 63.147(b)]
- c. The permittee shall keep records of the daily average value of each continuously monitored parameter for each operating day as specified in §63.1367, except as provided in §63.147(d)(1) through (3). [Reg.19.304 and 40 C.F.R. § 63.146(d) and §63.1362(d)(5)]
- d. If the permittee obtains approval to use a control device other than the one for which monitoring requirements are specified in §63.143, or to monitor parameters other than those specified in Tables 12 or 13, the Administrator will specify the appropriate recordkeeping requirements. [Reg.19.304 and 40 C.F.R. § 63.147(e)]

- e. If the permittee uses process knowledge to determine the annual average concentration of a wastewater stream as specified in §63.144(b)(3) and/or uses process knowledge to determine the annual average flow rate as specified in §63.144(c), and determines that the wastewater stream is not a Group 1 wastewater stream, the permittee shall keep in a readily accessible location the documentation of how process knowledge was used to determine the annual average concentration and/ or the annual average flow rate of the wastewater stream. [Reg.19.304 and 40 C.F.R. § 63.147(f)]

BAG DUMPS AND PRODUCT DRYERS

OCI 39 The permittee is subject to the following requirements of 40 CFR §63.1362:

- a. The following standards apply to bag dumps and product dryers:
 - i. The permittee shall reduce particulate matter emissions to a concentration not to exceed 0.01 gr/dscf from product dryers that dry PAI or integral intermediate that is a HAP. [Reg.19.304 and 40 C.F.R. § 63.1362(e)(1)]
 - ii. The permittee shall reduce particulate matter emissions to a concentration not to exceed 0.01 gr/dscf from bag dumps that introduce to a PAI process unit a feedstock that is a solid material and a HAP, excluding bag dumps where the feedstock contains HAP only as an impurity. [Reg.19.304 and 40 C.F.R. § 63.1362(e)(2)]
 - iii. The permittee shall control gaseous HAP emissions from product dryers and bag dumps in according to the provisions of the process vent requirements in §63.1362(b). [Reg.19.304 and 40 C.F.R. § 63.1362(e)(3)]

Heat exchange systems

- b. With the exception of the conditions specified in 40 CFR 63, Subpart F, §63.104(a)(1) through (6), the permittee shall monitor each heat exchange system that is used to cool PAI process units that are part of an affected source as defined in §63.1360(a) according to one of the provisions in 40 CFR §63.104(b) or (c) of Subpart F. Whenever a leak is detected, the permittee shall comply with the requirements in 40 CFR 63, Subpart F, §63.104(d). Delay of repair of heat exchange systems for which leaks have been detected is allowed according to §63.104(e) of Subpart F. [Reg.19.304 and 40 C.F.R. § 63.1362(f)]

Pollution Prevention Alternative

- c. Except as provided in §63.1362(g)(1) of Subpart MMM, for a process that has an initial startup prior to November 10, 1997, the permittee may choose to meet the pollution prevention alternative requirement specified in §63.1362(g)(2) or (3) for any PAI process unit, in lieu of the requirements specified in §63.1362(b) [Process vents], (c) [Storage vessels], (d) [Wastewater], and (e) [Bag dumps] and in §63.1363 [Equipment Leaks]. Compliance with the requirements of §63.1363(g)(2) and (3) shall be demonstrated through the procedures in §63.1365(g) and §63.1366(f). [Reg.19.304 and 40 C.F.R. § 63.1362(g)].

Emissions Averaging Provisions

- d. Except as provided in §63.1362(h)(1) through (7), the permittee may choose to comply with the emission standards in §63.1362(b), (c), and (d) of this section by using emissions averaging procedures specified in §63.1365(h) for organic HAP emissions from any storage vessel, process or waste management unit this is part of an affected source subject to Subpart MMM. [§19.304 of Regulation 19 and §40 CFR 63.1362(h)]

Presently, the permittee does not choose to opt for the emissions averaging compliance method.

Opening of a Safety Device

- e. Opening of a safety device, as defined in §63.1361 is allowed at any time conditions require it to avoid unsafe conditions. [Reg.19.304 and 40 C.F.R. § 63.1362(i)]

Closed-vent Systems

- f. Presently, the permittee does not have a closed-vent system containing a bypass line that could divert a vent stream away from a control device used to comply with the requirements of §63.1362(b) [Process vents], (c) [Storage vessels], or (d) [Wastewater]. If any bypass line is installed in the future, the permittee shall comply with the requirements of §63.1362(j)(1) and (2) [Closed-vent systems], and Table 2 of Subpart MMM. [Reg.19.304 and 40 C.F.R. § 63.1362(j)]

The permittee operates regenerative thermal oxidizers (RTOs), which have emergency vent dampers meeting the definition of a safety device as specified in §63.1361. Bypass lines do not exist on the closed-vent system and control device configuration.

Exception for RCRA Treatment Units

- g. The permittee shall be exempt from the initial compliance demonstrations and monitoring provisions in §63.1365 [Test methods and initial compliance] and

§63.1366 [Monitoring and inspections] and the recordkeeping and reporting requirements in §63.1367 [Recordkeeping] and §63.1368 [Reporting] for emissions from process vents, storage vessels, and waste management units that are discharging to the following devices:

- i. A boiler or process heater burning hazardous waste for which the permittee has been issued a final permit under 40 CFR Part 270 and complies with the requirements of 40 CFR Part 266, Subpart H; or
- ii. Has certified compliance with the interim status requirements of 40 CFR Part 266, Subpart H.
- iii. A hazardous waste incinerator for which the permittee has been issued a final permit under 40 CFR Part 270 and complies with the requirements of 40 CFR Part 264, Subpart O, or has certified compliance with the interim status requirements of 40 CFR Part 265, Subpart O. [Reg.19.304 and 40 C.F.R. § 63.1362(l)]

STANDARDS – EQUIPMENT LEAKS

OCI 40 The permittee is subject to the following requirements of 40 CFR §63.1363:

General Equipment Leak Requirement

- a. The following General Equipment Leak requirements apply:
 - i. For the purpose of §63.1363 [Standards: Equipment Leaks], equipment means each pump, compressor, agitator, pressure relief device, sampling connection system, open-ended valve or line, valve, connector, and instrument system in organic HAP service. In organic HAP service means that a piece of equipment contains or contacts a fluid (liquid or gas) that is at least 5 percent by weight of total organic HAP. These provisions also apply to any closed-vent systems and control devices required under §63.1363. [Reg.19.304 and 40 C.F.R. § 63.1363(a)(1) and §63.1361]

Consistency with Other Regulations

- ii. After the compliance date for a process, equipment subject to both §63.1363 [Standards: Equipment Leaks] and either of the following (40 CFR Part 60 and Part 61) will be required to only comply with the provisions of Subpart MMM. [Reg.19.304 and 40 C.F.R. § 63.1363(a)(2)]

- iii. The provisions in §63.1(a)(3) of subpart A of Part 63 do not alter the provisions in §63.1363(a)(2). [Reg.19.304 and 40 C.F.R. § 63.1363(a)4]
- Exemptions
- iv. The following are key exemptions regarding Subpart MMM standards for equipment leaks.
1. Equipment that is in vacuum service is excluded from the requirements of §63.1363. [Reg.19.304 and 40 C.F.R. § 63.1363(a)(8)]
 2. Equipment that operates in organic HAP service for less than 300 hours per calendar year, if it is identified as required in §63.1363(g)(9). [Reg.19.304 and 40 C.F.R. § 63.1363(a)(9)]
 3. Lines and equipment not containing process fluids are not subject to §63.1363. Utilities and other nonprocess lines, such as heating and cooling systems which do not combine their materials with those in the processes they serve, are not part of a process. [Reg.19.304 and 40 C.F.R. § 63.1363(a)(5)]

LDAR Provision Summary

- v. An attached table provides a summary of the Subpart MMM equipment leak requirements. Because of the complexity of the LDAR requirements, this table should be considered a reference tool only and the regulation should be referenced when developing a detailed compliance plan. Moreover, the permittee shall develop a comprehensive LDAR to fully meet the Subpart MMM requirements, including developing a list of equipment and identification numbers subject to the requirements and monitoring schedule. Connectors, except those determined to be unsafe-to-monitor, difficult-to-monitor, or inaccessible, do not have to be individually identified but the associated lines must be identified. Physical tagging of components is not required per 40 CFR §63.1363(a)(7) and §63.1363(g)(2).

PAI MACT Equipment Leak Requirement Summary – Part 1					
Equipment (PAI MACT / HON Cite- 40 CFR Part)	Design Requirements (Exemptions in parentheses)	Monitoring Frequency	Method	Leak Limit	Calculations
Pumps in Light Liquid Service (63.1363(c))	OHAP HAP Service (Dual mechanical seal systems that include a barrier fluid system are exempt per 40 CFR Part 63.1363(c)(5))	Quarterly with Instrument	Method 21 ¹	2,000 ppm	Calculate Leakers per 40 CFR Part 63.1363(c)(4)
		If 10% of pumps or 3 pumps in the process group leak, then monitor monthly			
		Weekly visual inspection	Visual		
Pressure Relief Devices in Gas/Vapor Service (63.165)	OHAP Service (Exempt if routed to vent header)	Monitor after every pressure relief episode		Operated with instrument reading less than 500 ppm above background	
Sampling Connection Systems (63.166)	Must be equipped with closed purge, closed loop, or closed vent system Shall return fluid to process line	Initially			
Open-Ended Valves or Lines (63.1363(d))	Must be equipped with flanges, plugs, or another valve (If poses a safety hazard, is designed to open automatically, or if equipped with double block and bleed exempt by 40 CFR Part 63.1363(d)(4)-(6))	Initially			

¹ Method 21 citation is 40 CFR Part 60 Appendix A.

PAI MACT Equipment Leak Requirement Summary – Part 1					
Equipment (PAI MACT / HON Cite- 40 CFR Part)	Design Requirements (Exemptions in parentheses)	Monitoring Frequency	Method	Leak Limit	Calculations
Valves in Gas/Vapor and Light Liquid Service (63.1363(e))		Once within year of compliance date	Method 21 ²	500 ppm	Calculate Leakers per 40 CFR Part 63.1363(e)(5)
		>2% leakers-monthly		500 ppm	
		<2% leakers-quarterly		500 ppm	
		<1%-once/2 quarters		500 ppm	
		<0.5%-once/4 quarters		500 ppm	
		<0.25%-every 2 years		500 ppm	
Connectors in Gas/Vapor and in Light Liquid Service (63.174)		Once within year of compliance date	Method 21 ²	500 ppm	Calculate Leakers per 40 CFR Part 63.174(h)(3)(i)
		<0.5% - once/4 quarters		500 ppm	
		<0.25-every 2 years		500 ppm	
Agitators in Gas/Vapor and Light Liquid Service (63.1363(c))		Quarterly with instrument	Method 21 ²	10,000 ppm	
		Weekly visual Inspection	Visual		

References to 40 CFR Subpart H

- b. The permittee shall comply with the provisions of 40 CFR 63, Subpart H as specified in §63.1363(b)(1) through (3) of Subpart MMM. When the term “process unit” is used in Subpart H, it shall mean any group of processes for the purpose of Subpart MMM. Groups of processes, as used in Subpart MMM, may be any individual process or combination of processes. [Reg.19.304 and 40 C.F.R. § 63.1363(b)]

Standards for Designated Equipment

- c. The permittee shall comply with all specific equipment leak standards §63.1363(c) through (f), including all documentation and calculations necessary for submitting information required in the Notification of Compliance Status Report (NOCS) under §63.1368(f). [Reg.19.304 and 40 C.F.R. § 63.1363(c) through (f)]
- d. The permittee may comply with recordkeeping requirements of more than one group of processes in a one recordkeeping system if the system identifies with each record the program being implemented. (e.g., quarterly monitoring) for each equipment type. All records shall be maintained in a manner that can be readily accessed at the plant site. This includes accessing the records from a central location by computer at the plant site. [Reg.19.304 and 40 C.F.R. § 63.1363(g)(1)]
- e. The permittee shall record all information required under §63.1363(g)(2) through (10), except as allowed under §63.1363(g)(5). [Reg.19.304 and 40 C.F.R. § 63.1363(g)(2) through (10)]

LDAR Reporting

- f. The permittee shall submit a Notification of Compliance Status report as specified in §63.1363(h)(2) and periodic reports identified in §63.1363(h)(3). [Reg.19.304 and 40 C.F.R. § 63.1363(h)(1) through (3)]

COMPLIANCE DATE

- OCI 41 The permittee is subject to the following requirements of 40 CFR §63.1364:
The existing source compliance date for Subpart MMM is December 23, 2003.
[Reg.19.304 and 40 C.F.R. § 63.1364(a)(1)]

TEST METHODS AND INITIAL COMPLIANCE PROCEDURES

- OCI 42 The permittee is subject to the following requirements of 40 CFR §63.1365:

General

- a. Except as specified in §63.1365(a)(5) [Alternative standard], the procedures specified in (c) [Process vents], (d) [Storage vessels], (e) [Wastewater], (f) [Bag dump/product dryer], and (g) [Pollution prevention alternative] are required to demonstrate initial compliance with 63.1362(b) [Process vents], (c) [Storage vessels], (d) [Wastewater], (f) [Bag dumps], and (g) [Pollution prevention alternative] respectively. Design evaluations that are used to demonstrate compliance with the standards for process vents and storage tanks are subject to

the provisions of §63.1365(a)(1). Performance tests that are specified in §63.1365(c), (d), and (e) are subject to the requirements in §63.1365(a)(2). Initial compliance procedures for flares are subject to §63.1365(a)(3). Alternative standards specified in 63.1362(b)(6) and (c)(4) are subject to the requirements in §63.1365(a)(5). The outlet concentration requirements of §63.1362(b)(2)(iv)(A), §63.1362(b)(3)(ii), §63.1363(b)(4)(ii)(A), §63.1362(b)(5)(ii), and §63.1362(b)(5)(iii) are subject to the requirements of §63.1365(a)(6). [Reg.19.304 and 40 C.F.R. § 63.1365(a)]

Initial Compliance Procedures

- b. The permittee shall demonstrate initial compliance by following the applicable procedures in §63.1365(a)(1) through (7). [Reg.19.304 and 40 C.F.R. § 63.1365(a)]

Test Methods and Conditions

- c. The permittee shall use the appropriate test methods in §63.1365(b)(1) through (9) when testing is used to measure emissions. Compliance tests shall be performed under the conditions specified in §63.1365(b)(10) and (11). [Reg.19.304 and 40 C.F.R. § 63.1365(a)]

Initial Compliance with Process Vents Provisions

- d. The permittee shall demonstrate compliance with the process vent standards in §63.1362(b) using the procedures described in §63.1365(c)(1) through (3). [Reg.19.304 and 40 C.F.R. § 63.1365(c)]

Initial Compliance with Storage Vessel Provisions

- e. The permittee shall demonstrate initial compliance with the storage vessel standards in §63.1362(c)(2) through (4) by meeting the requirements in either §63.1365(d)(1), (2), (3), (4), (5), or (6). The demonstration of compliance for the planned routine maintenance provision in §63.1362(c)(5) is fulfilled by meeting the requirements in §63.1365(d)(7). [Reg.19.304 and 40 C.F.R. § 63.1365(d)]

Initial Compliance with the Wastewater Provisions

- f. The permittee shall demonstrate initial compliance with the wastewater requirements by complying with the applicable provisions of §63.145, except the permittee need not comply with the requirement to determine visible emissions that are specified in §63.145(j)(1), and the references to compounds in Table 8 of Subpart G are not applicable for the purposes of Subpart MMM. When §63.145(i) refers to Method 18 of 40 CFR Part 60, Appendix A-6, the permittee may use any method specified in §63.1362(d)(12) to demonstrate initial compliance with Subpart MMM. [Reg.19.304 and 40 C.F.R. § 63.1365(e)]

Initial Compliance with the Bag Dump and Product Dryer Provisions

- g. Compliance with the particulate matter concentration limits specified in §63.1362(e) [Bag dumps] is demonstrated when the concentration of particulate matter is less than 0.01 gr/dscf, as measured using the method described in §63.1365(b)(7). [Reg.19.304 and 40 C.F.R. § 63.1365(f)]

Initial Compliance with the Pollution Prevention Alternative Standard

- h. If the permittee chooses to comply with the pollution prevention alternative standard, the permittee shall demonstrate initial compliance with §63.1362(g)(2) and (3) for a PAI process unit by preparing the demonstration summary in accordance with §63.1365(g)(1) and by calculating baseline and target annual HAP and VOC factors in accordance with §63.1365(g)(2) and (3). To demonstrate compliance with §63.1362(g)(3), the permittee must also comply with the procedures for add-on control devices that are specified in §63.1365(g)(4). [Reg.19.304 and 40 C.F.R. § 63.1365(g)]

Compliance with Emissions Averaging Provisions

- i. If the permittee chooses to comply with the emissions averaging provisions, the permittee must meet the requirements of §63.1365(h)(1). [Reg.19.304 and 40 C.F.R. § 63.1365(h)]

MONITORING AND INSPECTION REQUIREMENTS

OCI 43 The permittee is subject to the following requirements of 40 CFR §63.1366:

- a. The permittee shall provide evidence of continued compliance with the standard as specified in §63.1366. During the initial compliance demonstration, maximum or minimum operating parameter levels, as appropriate, shall be established for emission sources that will indicate the source is in compliance. Test data, calculations, or information from the evaluation of the control device design shall be used to establish operating parameter level. [Reg.19.304 and 40 C.F.R. § 63.1366(a)]

Monitoring for Control Devices

- b. Except as provided by §63.1366(b)(1)(i), for each control device, the permittee shall install and operate monitoring devices and operate within the established parameter levels to ensure continued compliance with the standard. Monitoring parameters are specified for control scenarios in Table 3, and in §63.1366(b)(1)(ii) through (xii), of Subpart MMM. [Reg.19.304 and 40 C.F.R. § 63.1366(b)(1)]

Averaging Periods

- c. The permittee shall establish averaging periods for parametric monitoring levels according to §63.1366(b)(2)(i) through (iii). [Reg.19.304 and 40 C.F.R. § 63.1366(b)(2)]

Procedures for Setting Parameter Levels for Control Devices used to Control Emissions from Process Vents Process Vents - Small Control Devices

- d. The permittee shall set the parametric monitoring levels for control devices (controlling less than 10 tons/yr of HAP), for which a performance test is not required, by conducting a design evaluation. If a performance test is conducted it shall be established according to the procedures in §63.1366(b)(3)(i). [Reg.19.304 and 40 C.F.R. § 63.1366(b)(3)]

Process Vents – Large Control Devices

- i. The permittee shall establish the parameter monitoring level for large control devices (controlling greater than or equal to 10 tons/yr), for which a performance test is required by Subpart MMM, by following the procedures in §63.1366(b)(3)(ii). [Reg.19.304 and 40 C.F.R. § 63.1366(b)(3)(ii)]

Process Vents – Parameter Levels for Control Devices Controlling Batch Process Vent

- ii. The permittee shall establish parameter monitoring levels for devices controlling batch process vents, alone or in combination with other streams according to §63.1366(b)(3)(iii). [Reg.19.304 and 40 C.F.R. § 63.1366(b)(3)(iii)]

Request for Approval to Monitor Alternative Parameters

- e. The permittee may request approval to monitor parameters other than those required by §63.1366(b)(1)(ii) through (xiii). The request shall be submitted according to the procedures in §63.8(f) of Subpart A or in the Precompliance Report as specified in §63.1368(e). [Reg.19.304 and 40 C.F.R. § 63.1366(b)(4)]

Monitoring for the Alternative Standard

- f. The permittee may monitor for the alternative standards identified in §63.1362(b)(6) and (c)(4) by following the requirements in §63.1366(b)(5). [Reg.19.304 and 40 C.F.R. § 63.1366(b)(5)]

Exceedances of Operating Parameters

- g. An exceedance of an operating parameter is defined as one of the following:

- i. If the parameter level, averaged over the operating day block, is below a minimum value established during the initial compliance demonstration;
- ii. If the parameter level, averaged over the operating day block, is above the maximum value established during the initial compliance demonstration;
- iii. A loss of all pilot flame for a flare during an operating day or block. Multiple losses of pilot flame during an operating day constitutes an exceedance;
- iv. Each operating day or block for which the time interval between replacement of a nonregenerative carbon absorber exceeds the interval established in §63.1366(b)(1)(v); or
- v. Each instance in which procedures to initiate the response to a bag lead detection alarm within 1-hour of the alarm as specified in the corrective action plan.

[Reg.19.304 and 40 C.F.R. § 63.1366(b)(6)]

- h. Monitoring data are insufficient to constitute a valid hour of data, as used in §63.1366(b)(7)(i) and (ii) if measured values are unavailable for any of the required 15-minute periods within the hour. [Reg.19.304 and 40 C.F.R. § 63.1366(b)(7)]

Excursions are defined by either of the two cases listed in §63.1366(b)(7)(i) or (ii) as follows:

- i. When the period of control device operation is 4-hours or greater in an operating day or block and monitoring data are insufficient to constitute a valid hour of data as defined in §63.1366(b)(7)(iii) for at least 75% of the operating hours. [Reg.19.304 and 40 C.F.R. § 63.1266(b)(7)(i)]
- ii. When the period of control device operation is less than 4-hours in an operating day or block and more than 1 of the hours during the period of operation does not constitute a valid hour of data due to insufficient monitoring data. [Reg.19.304 and 40 C.F.R. § 63.1366(b)(7)(ii)]

Violations

- i. Exceedances of parameters monitored according to §63.1366(b)(1)(ii), (iv) through (ix), and §63.1366(b)(5)(i)(A) and (B), or excursions as defined by §63.1258(b)(7)(i) and (ii) constitute violations of the operating limit according to §63.1366(b)(8)(i), (ii), and (iv). Exceedances of the temperature limit monitored according to §63.1366(b)(1)(iii) or exceedances of the outlet concentrations monitored according to the provisions of §63.1366(b)(1)(x) constitute violations of the emission limit according to §63.1366(b)(8)(i), (ii), and (iv). Exceedances of the outlet concentration

monitored according to §63.1366 (b)(5) constitute violations of the emission limit according to the provisions of §63.1366(b)(8)(iii) and (iv) of Subpart MMM. [Reg.19.304 and 40 C.F.R. § 63.1366(b)(8)]

Exceptions to Exceedances, Excursions, and Violations

- i. Except as provided in §63.1366(b)(8)(iv), for episodes occurring more than once per day, exceedances of established parameter limits or excursions will result in no more than one violation per operating day for each monitored item or equipment utilized in the process. [Reg.19.304 and 40 C.F.R. § 63.1366(b)(8)(i)]
- ii. Except as provided in §63.1366(b)(8)(iv), for control devices used for more than one process in the course of an operating day, exceedances or excursions will result in no more than one violation per operating day, per control device, for each process for which the control device is in service. [Reg.19.304 and 40 C.F.R. § 63.1366(b)(8)(ii)]
- iii. Except as provided in §63.1366(b)(8)(iv), exceedances of the 20 ppmv TOC outlet emission limit, or the HCL and chlorine emission limit, averaged over the operating day, will result in no more than one violation per operating day per control device. [Reg.19.304 and 40 C.F.R. § 63.1366(b)(8)(iii)]
- iv. Periods of time when the monitoring measurements exceed the parameter values as well as periods of inadequate monitoring data do not constitute a violation if they occur during a startup, shutdown, or malfunction, and the facility follows its startup, shutdown, and malfunction plan. [Reg.19.304 and 40 C.F.R. § 63.1366(b)(8)(iv)]

Monitoring for Equipment Leaks

- j. The permittee shall comply with the equipment leak monitoring requirements in §63.1363. [Reg.19.304 and 40 C.F.R. § 63.1366(d)]

Emission Monitoring for Heat Exchanger Systems

- k. The permittee shall comply with the heat exchanger monitoring requirements in §63.1362(f) for those heat exchangers subject to Subpart MMM. [[Reg.19.304 and 40 C.F.R. § 63.1366(e)]

Monitoring for the Pollution Prevention Alternative Standard

- l. If the permittee chooses to comply with the pollution prevention alternative standards in §63.1362(g)(2) or (3) the requirements of §63.1366(f) shall be followed. [§19.304 of Regulation 19 and §40 CFR §63.1366(f)]

Monitoring of Emissions Averaging

- m. If the permittee chooses to comply with the emissions averaging requirements in §63.1362(h), the monitoring requirements of §63.1366(b) [Monitoring for control devices] must be followed for all processes, storage tanks, and waste management units included in the emissions average. [Reg.19.304 and 40 C.F.R. § 63.1366(g)]

Leak Inspection Provisions of Vapor Suppression Equipment

- n. The following General Equipment Leak requirements apply:
 - i. The permittee shall comply with the requirements of §63.1366(h)(2) through (8), except as provided in §63.1366(h)(9) and (10), for each vapor collection system, closed-vent system, fixed roof, cover, or enclosure. [Reg.19.304 and 40 C.F.R. § 63.1366(h)(1)]
 - ii. If a closed-vent system subject to §63.1366 [Monitoring and inspection requirements] is also subject to the equipment leak provisions of §63.1363, the permittee shall comply with the provisions of §63.1363 and is exempt from the requirements in §63.1366. [Reg.19.304 and 40 C.F.R. § 63.1366(h)(9)]
 - iii. The permittee is not required to comply with the requirements specified in §63.1366(h)(2) through (8) for any closed-vent system that is operated and maintained under negative pressure. [Reg.19.304 and 40 C.F.R. § 63.1366(h)(10)]

RECORDKEEPING REQUIREMENTS

OCI 44 The permittee is subject to the following requirements of 40 CFR §63.1367:

- a. The permittee shall comply with the recordkeeping requirements in 40 CFR 63, Subpart A as specified in Table 1 of Subpart MMM and in §63.1367(a)(1) through (5). [Reg.19.304 and 40 C.F.R. § 63.1367(a)]

Records of Equipment Operations

- b. The permittee shall keep the records specified in §63.1367(b)(1) through (11) up-to-date and readily accessible, that conforms to the sources applicability determination and operations. [Reg.19.304 and 40 C.F.R. § 63.1367(b)]

Records of Equipment Leak Detection and Repair

- c. The permittee shall implement recordkeeping requirements specified in §63.1363(g) [Recordkeeping] for equipment subject to the equipment leak standards in §63.1363. All records shall be kept for a period of 5-years, in

accordance with the requirements in §63.10(b)(1) of 40 CFR 63, Subpart A.
[Reg.19.304 and 40 C.F.R. § 63.1367(c)]

Records of Emissions Averaging

- d. If the permittee chooses to comply with the emissions averaging requirements of §63.1362(h), up-to-date records of the information in §63.1367(d)(1) through (4) must be kept. [Reg.19.304 and 40 C.F.R. § 63.1367(d)]

Heat Exchanger Records

- e. If the permittee is subject to the heat exchanger system requirements of §63.1362(g), records as specified in §63.104(f)(1)(i) through (iv) of 40 CFR 63, Subpart G must be retained. [Reg.19.304 and 40 C.F.R. § 63.1367(e)]

Records of Inspections

- f. The permittee shall keep records of inspections specified in §63.1367(f)(1) through (6). [Reg.19.304 and 40 C.F.R. § 63.1367(f)]

Records of Primary Use

- g. The permittee shall keep records of each PAI process unit that is used to produce a given material for use as a PAI as well as for other purposes. The permittee shall keep records of total production and the production for use as a PAI on a semiannual or more frequent basis if the use as a PAI is not the primary use. [Reg.19.304 and 40 C.F.R. § 63.1367(g)]

REPORTING REQUIREMENTS

OCI 45 The permittee is subject to the following requirements of 40 CFR §63.1368:

- a. The permittee shall comply with the reporting requirements in §63.1368(b) through (l) of Subpart MMM. Applicable reporting requirements of §63.9 [notification requirements] and §63.10 [recordkeeping requirements] are also summarized in Table 1 of Subpart MMM. [Reg.19.304 and 40 C.F.R. § 63.1368(a)]

Initial Notification

- b. The permittee shall submit the applicable initial notification in accordance with §63.9(b) or (d) of 40 CFR 63, Subpart A, as specified in Table 1 of Subpart MMM. [Reg.19.304 and 40 C.F.R. § 63.1368(b)]

Application for Approval of Construction or Reconstruction

- c. Any application for approval of construction of a new major affected source, the reconstruction of a major affected source, or the reconstruction of a major source such that the source becomes major affected source subject to the standards shall be prepared in accordance with §63.5(d) [Application for approval of construction or reconstruction]. [Reg.19.304 and 40 C.F.R. § 63.13268(c)]

Notification of Continuous Monitoring System Performance Evaluation

- d. If the permittee is required by the Administrator to conduct a performance evaluation for a continuous monitoring system that is used to comply with the alternate standard in §63.1362(b)(6) or (c)(4), the permittee shall notify the Administrator of the date of the performance evaluation as specified in §63.8(e)(2). [Reg.19.304 and 40 C.F.R. § 63.1368(d)]

Precompliance Plan

- e. The permittee shall submit the Precompliance Plan at least 3-months prior to the compliance date of the standard. The Precompliance Plan shall include the information specified in §63.1368(e)(1) through (5). [Reg.19.304 and 40 C.F.R. § 63.1368(e)]

Notice of Compliance Status Report

- f. The permittee shall submit the Notification of Compliance Status report required under §63.9 no later than 150 days after the compliance date and shall include information specified in §63.1360(f)(1) through (9). [Reg.19.304 and 40 C.F.R. § 63.1368(f)]

Periodic Reports

- g. The permittee shall prepare and submit periodic reports specified in §63.1368(g)(1) and (2) to the Administrator. [Reg.19.304 and 40 C.F.R. § 63.1368(g)]

Notification of Process Change

- h. Except as specified in §63.1368(h)(2), whenever a process change is made, or a change in any of the information in the Notification of Compliance Status Report, the permittee shall submit the information specified in §63.1268(h)(1)(i) through (iv) with the next Periodic Report required under §63.1368(g) [Periodic reports]. [Reg.19.304 and 40 C.F.R. § 63.1368(h)]

Reports of Startup, Shutdown, and Malfunction

FutureFuel Chemical Company
Permit #: 1085-AOP-R16
AFIN: 32-00036

- i. The permittee shall prepare startup, shutdown, and malfunction (SSM) reports as specified in §63.1368(i). [Reg.19.304 and 40 C.F.R. § 63.1368(i)]

Reports of Equipment Leaks

- j. The permittee shall implement the reporting requirements specified in §63.1363(h) [LDAR Reporting] for sources subject to the equipment leak standards in §63.1363. Copies of all reports shall be retained for a period of 5 years in accordance with the requirements of §63.10(b)(1) of Subpart A. [Reg.19.304 and 40 C.F.R. § 63.1368(j)]

Reports of Emissions Averaging

- k. If the permittee chooses to comply with the emissions averaging requirements in §63.1362(h), all information specified in §63.1367(d) shall be submitted for all emission points included in the emissions average. Additionally, the report shall include all information specified in §63.1368(g) [Periodic reports] for each emission point included in the emissions average, and all information listed in §63.1368(k)(1)(i) through (iv). [Reg.19.304 and 40 C.F.R. § 63.1368(k)]

Reports of Heat Exchange Systems

- l. The permittee shall submit reports of applicable heat exchange systems as specified in §63.1368(l). [Reg.19.304 and 40 C.F.R. § 63.1368(l)]

Notification of Performance Test and Test Plan

- m. The permittee shall notify the Administrator of the planned date of a performance test at least 60-days before the test in accordance with §63.7(b) [notification of performance tests]. The permittee shall also submit the test plan required by §63.7(c) [quality assurance program] and the emission profile required by §63.1365(b)(8)(ii) with the notification of the performance test. [Reg.19.304 and 40 C.F.R. § 63.1368(m)]

Utilities

6M01, 6M01-01, 6M01-01A, 6M06-01 and 6M07-01

Source Description

There are three coal fired (6M01-01) and two natural gas fired boilers (6M06-01 and 6M07-01) at the facility.

The coal fired boilers are balanced draft, coal-fired steam generation boilers that have been fitted with atomizing nozzles to facilitate burning of liquid chemical wastes. Each coal fired boiler system is designed as a 70 million Btu/hr unit and is equipped with its own electrostatic precipitator (ESP) to control particulate emissions. The three coal fired boilers share a common primary fuel conveying system, a common ash handling system, and a common 200 foot tall stack. The boilers are independently controlled by a Distributed Control System (DCS). All interactions from the operator to the burners are made through this computer system.

The three coal fired boilers were installed in 1975, and are rated for 70 million Btu/hr per unit. Due to size and installation date, these boilers are not subject to any of the NSPS requirements.

The three coal fired boilers are subject to 40 CFR Part 63, Subpart EEE, *National Emission Standards for Hazardous Air Pollutants from Hazardous Waste Combustors*.

The solvent from the 2,000 gallon liquid process tank to be used for the purpose of flushing the chemical distribution piping is routed to either the coal-fired boiler auxiliary waste chemical burners or to the burner of the chemical waste destructor. Emissions from tank venting will be collected and routed to the coal-fired boilers (6M01-01).

There are two natural gas fired boilers at the facility. The #4 boiler (6M06-01) burns natural gas at 78 million BTU/hr. The #5 boiler (6M07-01) burns natural gas at 221 million BTU/hr. Each boiler system consists of a water tube boiler, economizer, superheater and a stack.

The #4 boiler was installed in 1986 and is rated for 78 million Btu/hr. The #5 boiler was installed in 1993 and is rated for 221 million Btu/hr. Due to size and installation date, the #4 boiler is not subject to NSPS requirements. However, the #5 boiler is subject to NSPS Subpart Db, with requirements pertaining to NO_x are applicable. Both the #4 (6M06-01) and #5 (6M07-01) natural gas fired boilers are subject to PSD emissions limitations. Initial testing to confirm PSD emission limits for NO_x were performed on August 2, 1988 for the #4 Boiler and August 6-7, 1992 for the #5 Boiler.

NSPS Kb requirements are identified and addressed in the Plantwide Conditions of this permit for all facility storage vessels, including those used in waste chemical service in the Utilities section. Emissions from utilities waste chemical storage tanks are routed through a closed-vent system to three coal-fired boilers as control devices.

BACT Analysis for Boilers #4 and #5

Boiler #4. This boiler is subject to a PSD emission rate limitation for NO_x which is simply 13.3 lb/hr. BACT for NO_x at the time of permit issuance was considered to be a standard register burner. BACT analysis for this source was performed in Permit No. 829-A.

Boiler #5. This boiler is subject to both PSD and NSPS Subpart Db requirements. The PSD BACT limit for NO_x is 22 lb/hr (0.1 lb/million Btu), which is more stringent than the NSPS emissions standard for NO_x (0.2 lb/million Btu). The BACT analysis was performed in Permit No. 1085-AR-1.

Specific Conditions

US 1. The permittee shall not exceed the emission rates set forth in the following table.
 [Reg.19.501 *et seq.* and 40 C.F.R. § 52 Subpart E]

SN	Description	Pollutant	lb/hr	tpy
6M01	Coal Pile	PM ₁₀	0.1	0.1
6M01-01	3 Coal Fired Boilers (70 MMBtu/hr each)	PM ₁₀	26.1	112.8
		SO ₂	1391	5982.9
		VOC	0.7	2.9
		CO	216.4	947.8
		NO _x	106.0	455.8
		Pb	0.8	3.4
6M01-01A	Coal Bunker Fabric Filter	PM ₁₀	0.2	0.7
6M06-01	#4 Boiler (78 MMBtu/hr) Natural Gas	PM ₁₀	0.6	2.6
		SO ₂	0.1	0.3
		VOC	0.5	1.9
		CO	6.6	28.7
		NO _x	13.3	58.3
6M07-01	#5 Boiler (221 MMBtu/hr) Natural Gas	PM ₁₀	1.7	7.4
		SO ₂	0.2	0.6
		VOC	1.3	5.4
		CO	18.6	81.4
		NO _x	22.0	96.4
BLR-FUG	Utilities Area Fugitive Emissions	VOC	0.5	1.8

US 2. The permittee shall not exceed the emission rates set forth in the following table. The facility shall show compliance with the facility total ton/yr limits using the procedures outlined in PW 11 through PW 15. Hourly Plantwide Hazardous Air Pollutant emissions are limited by PW 15. Additional HAP limitations are included in PW 12. [Reg.18.801 and Ark. Code Ann. § 8-4-203 as referenced by Ark. Code Ann. §§ 8-4-304 and 8-4-311]

SN	Description	Pollutant	lb/hr
6M01	Coal Pile	PM	0.1
6M01-01	3 Coal Fired Boilers (70 MMBtu/hr each)	PM Inorganics* Organic Pollutants**	26.1 259.0 0.7
6M01-01A	Coal Bunker Fabric Filter	PM	0.2
6M06-01	#4 Boiler 78 MMBtu/hr Natural Gas	PM Organic Pollutants**	0.6 0.5
6M07-01	#5 Boiler (221 MMBtu/hr) Natural Gas	PM Organic Pollutants**	1.7 1.3
BLR-FUG	Utilities Area Fugitive Emissions	Organic Pollutants**	0.50

*Inorganics are considered to be non-organic Hazardous Air Pollutants

**Organic Pollutants are considered to be VOC, all organic HAPs, and organic Air Contaminates.

***Limited by Plantwide Condition 12.

US 3. Visible emissions may not exceed the limits specified in the following table of this permit as measured by EPA Reference Method 9, except during periods of startup, shutdown, and malfunction. Compliance with this condition shall be demonstrated through operating the ESP as specified by the manufacturer, and in accordance with the most current version of the Facility Operating Plan. [Reg.18.501 and Ark. Code Ann. § 8-4-203 as referenced by Ark. Code Ann. §§ 8-4-304 and 8-4-311]

SN	Limit	Regulatory Citation
6M01	5%	§18.501
6M01-01	20%	§19.503
6M01-01A	5%	§18.501
6M06-01	5%	§18.501
6M07-01	20%	NSPS Db

US 4. The permittee shall conduct weekly observations of the opacity from all sources in the Utilities section and keep a record of these observations. If the permittee detects visible emissions, the permittee must immediately take action to identify and correct the cause of the visible emissions. After implementing the corrective action, the permittee must document that the source complies with the visible emissions requirements. The permittee shall maintain records of the cause of any visible emissions and the corrective action taken. The permittee must keep these records onsite and make them available to Department

personnel upon request. [Reg.18.801 and Ark. Code Ann. § 8-4-203 as referenced by Ark. Code Ann. §§ 8-4-304 and 8-4-311]

- US 5. Boiler #4 and Boiler #5 shall be limited to NO_x emission rates of 13.3 and 22.0 lb/hr, respectively. [Reg.19.901 et seq. and 40 C.F.R. § 52 Subpart E]
- US 6. The permittee shall maintain the power input to the ESP (6M01-01 - Coal Fired Boilers) as outlined in the most current version of the Facility Operating Plan. [Reg.19.303 and Ark. Code Ann. § 8-4-203 as referenced by Ark. Code Ann. §§ 8-4-304 and 8-4-311]
- US 7. The permittee shall maintain daily records of the power input at the ESP (6M01-01 - Coal Fired Boilers). [Reg.19.705 and 40 C.F.R. § 52 Subpart E]
- US 8. The permittee shall maintain compliance with the VOC, SO₂, NO_x, CO, and inorganic emission limits of 6M01-01 (Coal Fired Boilers) per the methodology outlined in most current version of the Facility Operating Plan. [Reg.19.303 and Ark. Code Ann. § 8-4-203 as referenced by Ark. Code Ann. §§ 8-4-304 and 8-4-311]
- US 9. The permittee shall not combust coal with a sulfur content greater than 3.8% by weight. [Reg.19.705, Ark. Code Ann. § 8-4-203 as referenced by Ark. Code Ann. §§ 8-4-304 and 8-4-311, and 40 C.F.R. § 70.6]
- US 10. The permittee shall perform testing of 6M01-01 (Coal Fired Boilers) every five years for NO_x, using EPA Reference Method 7E. The test should be conducted within 180 days of the 5 year test anniversary. [§19.702 of Regulation 19 and 40 CFR Part 52 Subpart E]
- US 11. The permittee shall record the amount and type of coal, biosludge and liquids fed to the coal fired boilers (6M01-01 - Coal Fired Boilers) during a 30-day period. These records shall be kept on site and made available upon request. [Reg.19.705 and 40 C.F.R. § 52 Subpart E]
- US 12. The permittee shall track natural gas usage in the #4 Boiler (6M06-01) as outlined in the most current version of the Facility Operating Plan. [Reg.19.705, Ark. Code Ann. § 8-4-203 as referenced by Ark. Code Ann. §§ 8-4-304 and 8-4-311, and 40 C.F.R. § 70.6]
- US 13. The permittee shall use a predictive emission monitoring system (PEMS) to monitor NO_x emissions from the #5 Boiler (6M07-01) as outlined in the most current version of the Facility Operating Plan. [Reg.19.705, Ark. Code Ann. § 8-4-203 as referenced by Ark. Code Ann. §§ 8-4-304 and 8-4-311, and 40 C.F.R. § 70.6 and 40 C.F.R. § 60.48b(g)(2)]
- US 14. The permittee shall combust only pipeline quality natural gas in 6M06-01 and 6M07-01. [Reg.19.705, Ark. Code Ann. § 8-4-203 as referenced by Ark. Code Ann. §§ 8-4-304 and 8-4-311, and 40 C.F.R. § 70.6]
- US 15. The permittee shall maintain the pressure drop across the fabric filter at 6M01-01A as outlined in the most current version of the Facility Operating Plan. [Reg.19.705, Ark. Code Ann. § 8-4-203 as referenced by Ark. Code Ann. §§ 8-4-304 and 8-4-311, and 40 C.F.R. § 70.6]
- US 16. The permittee shall keep records on site of the pressure drop across 6M01-01A. [Reg.19.705 and 40 C.F.R. § 52 Subpart E]

FutureFuel Chemical Company
Permit #: 1085-AOP-R16
AFIN: 32-00036

US 17. The permittee shall operate all CEMS at this source in accordance with all applicable conditions of Section III – Notification and Recordkeeping of the Department's Continuous Emission Monitoring Systems Conditions as found in Appendix A of this permit. [Reg.19.703, 40 C.F.R. § 52 Subpart E, and Ark. Code Ann. § 8-4-203 as referenced by Ark. Code Ann. §§ 8-4-304 and 8-4-311]

40 CFR Part 60 Subpart Db - Standards of Performance for Industrial-Commercial-Institutional Steam Generating Units

US 18. The permittee is to comply with the following nitrogen oxides emission limitation (expressed as NO₂) at SN-6M07-01: The NO₂ limitation is 0.20 lb/MMBtu based on a high heat release rate. [Reg.19.304 and 40 C.F.R. § 60.44b(a)(1)(ii)]

US 19. The nitrogen oxide standard at SN-6M07-01 applies at all times including periods of startup, shutdown, or malfunction. [Reg.19.304 and 40 C.F.R. § 60.44b(h)]

US 20. Compliance with the emission limitations at SN-6M07-01 is determined on a 30-day rolling average basis. [Reg.19.304 and 40 C.F.R. § 60.44b(i)-(j)]

US 21. The permittee is limited to opacity at SN-6M07-01 of 20%. This limit shall apply at all times except periods of startup, shutdown, or malfunction. [Reg.19.304 and 40 C.F.R. § 60.46b(a)]

US 22. The permittee shall use a continuous parametric monitoring system (PEMS) at SN-6M07-01 to determine compliance with monitoring nitrogen oxides under §60.48b. [Reg.19.304 and 40 C.F.R. § 60.46b(e)]

US 23. The permittee shall monitor steam generating unit operating conditions at SN-6M07-01 and predict nitrogen oxides emission rates as specified in a plan submitted pursuant to §60.49(c). [Reg.19.304 and 40 C.F.R. § 60.48b(g)(2)]

US 24. The permittee shall comply with all provisions of this citation for monitoring steam generating unit operating conditions at SN-6M07-01 under §60.48b(g)(2). [Reg.19.304 and 40 C.F.R. § 60.49b(c)]

US 25. The permittee shall record and maintain records of amounts of natural gas combusted at SN-6M07-01 each day and calculate the annual capacity factor for the reporting period. The annual capacity factor is determined on a 12-month rolling average basis with a new annual capacity factor calculated at the end of each calendar month. [Reg.19.304 and 40 C.F.R. § 60.49b(d)]

US 26. The permittee shall maintain and record at SN-6M07-01, for each steam generating unit operating day, the information required by §60.49b(g). [Reg.19.304 and 40 C.F.R. § 60.49b(g)]

US 27. The permittee shall submit excess emission reports for any excess emission which occur at SN-6M07-01 during the reporting period. [Reg.19.304 and 40 C.F.R. § 60.49b(h)]

US 28. The reporting period for the reports required at SN-6M07-01 under this subpart is each 6-month period. All reports shall be submitted to the Administrator and shall be postmarked

by the 30th day following the end of the reporting period. [Reg.19.304 and 40 C.F.R. § 60.49b(w)]

40 CFR Part 63 Subpart DD - National Emission Standards for Hazardous Air Pollutants from Off-Site Waste and Recovery Operations

- US 29. The permittee shall comply with any of the requirements specified in 40 CFR §63.683(b)(1) for Off-site Material Management Units within an affected source designation under 40 CFR §60.680(c). [Reg.19.304 and 40 C.F.R. § 63.683(a)]
- US 30. Specific units identified as applicable under this regulation include the following liquid waste storage tanks: WB-01, WB-02, WB-03, WB-04, WB-05, WB-06, WB-07, WB-08, WB-09, WDT-01, WDT-02, and PT-50. These tanks, with the exception of PT-50, are routed through the coal-fired boilers via a closed-vent vapor recovery system. PT-50 is routed to the RTO. [Reg.19.304 and 40 C.F.R. § 63.683(b)(1)]
- US 31. The permittee is exempt from those off-site material management units identified in 40 CFR §63.683(b)(2). [Reg.19.304 and 40 C.F.R. § 63.683(b)(2)]
- US 32. The permittee controls air emissions from off-site material management units in accordance with the applicable standards specified in 40 CFR §63.685 through §63.689. [Reg.19.304 and 40 C.F.R. § 63.683(b)(1)(i)]
- US 33. The permittee shall comply with the requirements of 40 CFR §63.684(a) and any of the treatment processes under 40 CFR §63.684 (b), as applicable, for the treatment of off-site material to remove or destroy HAP for which §63.683(b)(1)(i) references such treatment. [Reg.19.304 and 40 C.F.R. § 63.684(a) and (b)]
- US 34. The permittee shall maintain records of each treatment process in accordance with the requirements in 40 CFR §63.696. [Reg.19.304 and 40 C.F.R. § 63.684(f)]
- US 35. The permittee shall submit and prepare reports for each treatment process in accordance with 40 CFR §63.697(a). [Reg.19.304 and 40 C.F.R. § 63.684(g)]
- US 36. The permittee shall comply with the requirements of §63.685(a) and (b), and control air emissions from tanks for which §63.683(b)(1)(i) references such air emission control. [Reg.19.304 and 40 C.F.R. § 63.685(a) and (b)]
- US 37. The permittee shall comply with the requirements of §63.685(c) when controlling air emissions from tanks using Tank Level 1 controls, unless the permittee has implemented Tank Level 2 controls. [Reg.19.304 and 40 C.F.R. § 63.685(c)]
- US 38. The permittee shall comply with §63.685(d) for controlling air emissions from a tank, which requires the use of Tank Level 2 controls. [Reg.19.304 and 40 C.F.R. § 63.685(d)]
- US 39. The permittee shall comply with the requirements of §63.685(g)(1) through (3) for the control of tank air emissions if venting to a control device. [Reg.19.304 and 40 C.F.R. § 63.685(g)]
- US 40. The permittee shall comply with the requirements of either §63.689(b) or (c), as applicable, for the control of air emissions from transfer systems for which §63.683(b)(1)(i) references such air emission control. [Reg.19.304 and 40 C.F.R. § 63.689(a)]

- US 41. The permittee shall comply with the requirements of §63.691(a) and (b) for the control of equipment leaks for which §63.680(c)(3) references such air emission control. [Reg.19.304 and 40 C.F.R. § 63.691(a)]
- US 42. The permittee shall meet the requirements of 40 CFR §63.693(b)(1) for each closed-vent system. [Reg.19.304 and 40 C.F.R. § 63.693(b)(1)]
- US 43. The permittee shall meet the requirements of 40 CFR §63.693(b)(2) for each control device. [Reg.19.304 and 40 C.F.R. § 63.693(b)(2)]
- US 44. The permittee shall perform testing as specified in 40 CFR §63.694 for all applicable treatment processes and/or control devices used for compliance with applicable standards under this subpart. [Reg.19.304 and 40 C.F.R. § 63.694]
- US 45. The permittee shall comply with the inspection and monitoring requirements of 40 CFR §63.695 for all affected tanks, closed-vent systems, transfer systems, and control devices as applicable. [Reg.19.304 and 40 C.F.R. § 63.695]
- US 46. The permittee shall comply with all applicable recordkeeping requirements in 40 CFR §63.696, including requirements in 40 CFR §63.10, General Provisions that applies as specified in Table 2 of 40 CFR §63, Subpart DD. [Reg.19.304 and 40 C.F.R. § 63.696]

40 CFR Part 60 Subpart Y - Standards of Performance for Coal Preparation Plants

- US 47. The coal processing and conveying equipment, coal storage, and coal transfer equipment shall be limited to 20% opacity. This condition applies to 6M01, storage pile and coal unloading area. [Reg.19.304 and 40 C.F.R. § 60.252(c)]
- US 48. In conducting the initial performance tests required in §60.8, the permittee shall use Method 9 to determine opacity. [Reg.19.304 and 40 C.F.R. § 60.254(b)(2)]

40 CFR Part 63 Subpart EEE - National Emission Standards for Hazardous Air Pollutants from Hazardous Waste Combustors

- US 49. The permittee shall maintain the operating limits as outlined in the Notification of Compliance (NOC) for the coal boilers when combusting hazardous waste. The NOC is required by 40 CFR Part 63, Subpart EEE. [Reg.19.705 and 40 C.F.R. § 52 Subpart E]

Operating Parameters Limitations (OPLs)
Maximum Waste Feed Limitations
Waste Feed Rate (aqueous HAP + organic HAP), lb/hr Chlorine Feed Rate, lb/hr Ash Feed Rate, lb/hr Total Mercury Feed Rate, lb/hr Total Semi-Volatile Metals Feed Rate, lb/hr Total Low-Volatile Metals Feed Rate, lb/hr

Operating Parameters Limitations (OPLs)
Combustion Chamber Limitations
Minimum Combustion Chamber Temperature, °F Minimum Atomization Pressure, psi Maximum Furnace Pressure, psi Maximum Combustion Air Flow Rate, scfm
ESP Limitations
Minimum ESP Power, kW Maximum Inlet Temperature to the ESP, °F
Operating Parameters Limitations (OPLs)
Stack Gas Limitations
Maximum Total Hydrocarbon, ppmv Maximum Percent Oxygen, %

US 50. The permittee shall maintain records operating limits as specified in the NOC. These records shall be maintained on site and available for inspection upon request. [Reg.19.705 and 40 C.F.R. § 52 Subpart E]

US 51. This facility is subject to 40 CFR Part 63, Subpart EEE, National Emission Standards for Hazardous Air Pollutants from Hazardous Waste Combustors when burning hazardous waste. Applicable requirements include, but are not limited to, the following conditions [Reg.19.304 and 40 C.F.R. § 63.1200 of EEE]:

- a. The permittee shall meet the dioxin and furan standards of 40 CFR Part 63, Subpart EEE by complying with the hydrocarbon emission standards of condition US.51(e) of this permit. [Reg.19.304 and 40 C.F.R. § 63.1216(a)(1)]
- b. The permittee shall not discharge or cause combustion gases to be emitted to the atmosphere that contain mercury in excess of 11 µg/dscm, corrected to 7 percent oxygen. [Reg.19.304 and 40 C.F.R. § 63.1216(a)(2)]
- c. The permittee shall not discharge or cause combustion gases to be emitted to the atmosphere that contain lead and cadmium in excess of 180 µg/dscm, combined emissions, corrected to 7 percent oxygen. [Reg.19.304 and 40 C.F.R. § 63.1216(a)(3)]
- d. The permittee shall not discharge or cause combustion gases to be emitted to the atmosphere that contain arsenic, beryllium, and chromium in excess of 380µg/dscm, combined emissions, corrected to 7 percent oxygen. [Reg.19.304 and 40 C.F.R. § 63.1216(a)(4)]

- e. The permittee shall not discharge or cause combustion gases to be emitted to the atmosphere that contain hydrocarbons in excess of 10 parts per million by volume, over an hourly rolling average (monitored continuously with a continuous emissions monitoring system), dry basis, and corrected to 7 percent oxygen, and reported as propane. [Reg.19.304 and 40 C.F.R. § 63.1216 (a)(5)(ii)]
- f. The permittee shall not discharge or cause combustion gases to be emitted to the atmosphere that contain hydrochloric acid and chlorine gas in excess of 440 parts per million by volume, combined emissions, expressed as hydrochloric acid equivalents, dry basis and corrected to 7 percent oxygen or the permittee may comply with the health-based compliance alternatives in lieu of the emission standards for total chlorine provided under §§ 63.1216(a)(6) by complying with the health-based compliance alternatives for total chlorine under the procedures prescribed in 40 CFR 63.1215. [Reg.19.304 and 40 C.F.R. § 63.1216(a)(6)]
- g. The permittee shall not discharge or cause combustion gases to be emitted to the atmosphere that contain particulate matter in excess of 68 mg/dscm corrected to 7 percent oxygen. [Reg.19.304 and 40 C.F.R. § 63.1216(a)(7)]

Destruction and Removal Efficiency (DRE) Standard

- h. The permittee shall maintain a 99.99% destruction and removal efficiency (DRE) for each principal organic hazardous constituent (POHC) designated under paragraph (c)(3) of this section. The DRE shall be calculated using the following equation:
$$\text{DRE} = [1 - (\text{Win} / \text{Wout})] \times 100\%$$

Where:
Win = mass feedrate of one principal organic hazardous constituent (POHC) in a waste feed stream; and
Wout = mass emission rate of the same POHC present in exhaust emissions prior to release to the atmosphere. [Reg.19.304 and 40 C.F.R. § 63.1216(c)]
- i. The permittee must treat the POHCs in the waste feed that are specified under paragraph (c)(3)(ii) of this section to the extent required by paragraphs §63.1216(c)(1) and (c)(2) (i.e. 99.99% as stated in the previous Specific Condition). [Reg.19.304 and 40 C.F.R. § 63.1216(c)(3)(i)]
- j. The permittee shall specify one or more POHCs from the list of hazardous air pollutants established by 42 U.S.C. 7412(b)(1), excluding caprolactum as provided by '63.60, for each waste to be burned. The permittee must base this specification on the degree of difficulty of incineration of the organic constituents in the waste and on their concentration or mass in the waste feed, considering the results of waste analyses or other data and information. [Reg.19.304 and 40 C.F.R. § 63.1216(c)(3)(ii)]
- k. The emission limits provided by paragraphs §63.1203(a) and §63.1203(b) are presented with two significant figures. Although the permittee must perform intermediate calculations using at least three significant figures, the resultant

emission levels may be rounded to two significant figures to document compliance. [Reg.19.304 and 40 C.F.R. § 63.1216(d)]

Compliance Provisions

- l. The permittee shall comply with the emission standards of §63.1219 no later than October 14, 2008, unless the Administrator grants an extension under §63.6(i) or §63.1213. [Reg.19.304 and 40 C.F.R. § 63.1206(a)(1)(ii)]
- m. The permittee shall comply with the emission standards and operating requirements set forth in 40 CFR Part 63, Subpart EEE at all times when hazardous wastes are in the combustion chamber, except as specified in §63.1206(b)(1)(i) and (ii). [Reg.19.304 and 40 C.F.R. § 63.1206(b)(1)]
- n. The permittee shall demonstrate compliance based on performance testing under operating conditions representative of the extreme range of normal conditions. This performance test shall be conducted as required by 40 CFR §63.1206(b)(12). Prior to the completion of the performance test, the permittee shall document compliance with 40 CFR Part 63, Subpart EEE no later than October 14, 2008. This documentation of compliance (DOC) will ensure that operating parameters are established to ensure compliance with this subpart. [Reg.19.304 and 40 C.F.R. § 63.1206(b)(2)]
- o. The permittee may petition the Administrator to grant an extension of compliance with the emission standards of this subpart as provided by §63.6(i) and §63.1213. [Reg.19.304 and 40 C.F.R. § 63.1206(b)(4)]
- p. The permittee shall comply with the requirements of notification, performance testing, and waste-burning restrictions as outlined in §63.1206(b)(5)(i)(A) through (C) if the facility plans to make a change in design, operation, or maintenance that could adversely affect compliance. [Reg.19.304 and 40 C.F.R. § 63.1206(b)(5)(i)]
- q. The permittee shall document any changes not affecting compliance in the facility operating record. Revisions reflecting such changes shall also be made, as necessary, to the performance test plan, Documentation of Compliance, Notification of Compliance, and the start-up, shutdown, and malfunction plan. [Reg.19.304 and 40 C.F.R. § 63.1206(b)(5)(ii)]
- r. The permittee shall demonstrate destruction removal efficiency (DRE) of at least 99.99% during the comprehensive performance test conducted in compliance with the conditions of §63.1207(b)(1) of this subpart. [Reg.19.304 and 40 C.F.R. § 63.1206(b)(7)]
- s. Any particulate matter and opacity standards or any permit or other emissions operating parameter limits or conditions, including any limitation on workplace practices, that are applicable to hazardous waste combustors to ensure compliance with any particulate matter or opacity standard of parts 60, 61, 63, 264, 265, and 266 of this chapter (i.e., any title 40 particulate or opacity standards) do not apply while the permittee conducts particulate matter continuous emissions monitoring system (CEMS) correlation tests. However, compliance with this condition is not

required until such time that the Agency promulgates all performance specifications and operational requirements applicable to PM CEMS. [Reg.19.304 and 40 C.F.R. § 63.1206(b)(8)(i) and (ii)]

- t. For provisions of this section to apply, the permittee must develop a particulate matter CEMS correlation test plan that includes the following information. This test plan may be included as part of the comprehensive performance test plan required under '63.1207(e) and (f):
 - i. Number of test conditions and number of runs for each test condition;
 - ii. Target particulate matter emission level for each test condition;
 - iii. How you plan to modify operations to attain the desired particulate matter emission levels; and
 - iv. Anticipated normal emission levels.

The permittee shall submit the particulate CEMS correlation test plan to the Administrator for approval at least 90 calendar days before the correlation test is scheduled to be conducted. However, compliance with this condition is not required until such time that the Agency promulgates all performance specifications and operational requirements applicable to PM CEMS. [Reg.19.304 and 40 C.F.R. § 63.1206(b)(8)(iii)(A) and (B)]

- u. If the Administrator fails to approve or disapprove the correlation test plan with the time period specified by §63.7(c)(3)(i), the plan is considered approved, unless the Administrator has requested additional information. [Reg.19.304 and 40 C.F.R. § 63.1206(b)(8)(iv)]
- v. The particulate matter and associated operating limits and conditions will not be waived for more than 96 hours, in the aggregate, for a correlation test, including all runs of all test conditions, unless more time is approved by the Administrator. [Reg.19.304 and 40 C.F.R. § 63.1206(b)(8)(v)]
- w. The permittee must return to operating conditions indicative of compliance with the applicable particulate matter and opacity standards as soon as possible after correlation testing is completed. [Reg.19.304 and 40 C.F.R. § 63.1206(b)(8)(vii)]
- x. The permittee must calculate the hazardous waste residence time and include the calculation in the performance test plan under '63.1207(f) and the operating record. The permittee must also provide the hazardous waste residence time in the Documentation of Compliance under '63.1211(c) and the Notification of Compliance under '63.1207(j) and §63.1210(b). [Reg.19.304 and 40 C.F.R. § 63.1206(b)(11)]
- y. The permittee must conduct a minimum of three runs of a performance test required under '63.1207 to document compliance with the emission standards of this subpart. [Reg.19.304 and 40 C.F.R. § 63.1206(b)(12)(i)]
- z. The permittee must document compliance with the emission standards based on the arithmetic average of the emission results of each run, except that the

permittee must document compliance with the destruction and removal efficiency standard for each run of the comprehensive performance test individually.
[Reg.19.304 and 40 C.F.R. § 63.1206(b)(12)(ii)]

General Operating Requirements

- aa. The permittee must operate only under the operating requirements specified in the Notification of Compliance under '63.1207(j) and §63.1210(b), except:
[Reg.19.304 and 40 C.F.R. § 63.1206(c)(1)(i)]
 - i. During performance tests under approved test plans according to '63.1207(e), (f), and (g), [40 CFR '63.1206(c)(1)(i)(A)]
 - ii. Under the conditions of paragraph (b)(1)(i) or (ii) of this section
[Reg.19.304 and 40 C.F.R. § 63.1206(c)(1)(i)(B)]
 - 1. The Notification of Compliance must contain operating requirements including, but not limited to, the operating requirements of this section and §63.1209. [Reg.19.304 and 40 C.F.R. § 63.1206(c)(1)(ii)]
 - 2. Failure to comply with the operating requirements is failure to ensure compliance with the emissions standards of this subpart [Reg.19.304 and 40 C.F.R. § 63.1206(c)(1)(iii)]
 - 3. Operating requirements in the Notification of Compliance are applicable requirements for purposes of parts 70 and 71 of this chapter [Reg.19.304 and 40 C.F.R. § 63.1206(c)(1)(iv)]
 - 4. The operating requirements specified in the Notification of Compliance will be incorporated in the Title V permit. [Reg.19.304 and 40 C.F.R. § 63.1206(c)(1)(v)]
- bb. Except as provided in by paragraph (c)(2)(ii) of this section, the permittee is subject to the startup, shutdown, and malfunction plan requirements of '63.6(e)(3).
[Reg.19.304 and 40 C.F.R. § 63.1206(c)(2)(i)]
 - i. If the permittee elects to comply with §270.235(a)(1)(iii), §270.235(a)(2)(iii), or §270.235(b)(1)(ii) of this chapter to address RCRA concerns, the permittee must comply with the provisions of §63.1206(c)(2)(ii)(A) and (B). [Reg.19.304 and 40 C.F.R. § 63.1206(c)(2)(ii)]
 - ii. The permittee must identify in the plan the projected oxygen correction factor based on normal operations to use during periods of startup and shutdown. [Reg.19.304 and 40 C.F.R. § 63.1206(c)(2)(iii)]
 - iii. The permittee must record the plan in the operating record. [Reg.19.304 and 40 C.F.R. § 63.1206(c)(2)(iv)]

- iv. The permittee must comply with this requirement for operation under the startup, shutdown, and malfunction plan. [Reg.19.304 and 40 C.F.R. § 63.1206(c)(2)(v)]
- cc. Upon the compliance date, the permittee must operate the combustor with a functioning system that immediately and automatically cuts off the hazardous waste feed, except as provided by paragraph (c)(3)(viii) of this section, when the following conditions apply: [Reg.19.304 and 40 C.F.R. § 63.1206(c)(3)(i)]
 - i. When operating parameter limits specified under §63.1209; an emission standard monitored by CEMS; and the allowable combustion chamber pressure; [Reg.19.304 and 40 C.F.R. § 63.1206(c)(3)(i)(A)]
 - ii. When the span value of any CMS detector, except a CEMS, is met or exceeded; [Reg.19.304 and 40 C.F.R. § 63.1206(c)(3)(i)(B)]
 - iii. Upon malfunction of a CMS monitoring an operating parameter limit specified under §63.1209 or an emission level; or [Reg.19.304 and 40 C.F.R. § 63.1206(c)(3)(i)(C)]
 - iv. When any component of the automatic waste feed cutoff system fails. [Reg.19.304 and 40 C.F.R. § 63.1206(c)(3)(i)(D)]
- dd. During an automatic waste feed cutoff (AWFCO) the permittee must continue to duct combustion gases to the air pollution control system while hazardous waste remains in the combustion chamber. [Reg.19.304 and 40 C.F.R. § 63.1206(c)(3)(ii)]
- ee. The permittee must continue to monitor during the cutoff the operating parameters for which limits are established under §63.1209 and the emissions required under that section to be monitored by a CEMS, and the permittee shall not restart the hazardous waste feed until the operating parameters and emission levels are within specified limits. [Reg.19.304 and 40 C.F.R. § 63.1206(c)(3)(iii)]
- ff. If the AWFCO system fails to automatically and immediately cutoff the flow of hazardous waste upon exceedance of a parameter required to be interlocked with the AWFCO system under paragraph (c)(3)(i) of this section, the permittee has failed to comply with the AWFCO requirements of paragraph (c)(3) of this section. [Reg.19.304 and 40 C.F.R. § 63.1206(c)(3)(iv)]
- gg. If, after any AWFCO, there is an exceedance of any emission standard or operating requirement, irrespective of whether the exceedance occurred while hazardous waste remained in the combustion chamber, the permittee shall investigate the cause of the AWFCO, take appropriate corrective measures to minimize future AWFCOs and record the findings and corrective measures in the operating record. [Reg.19.304 and 40 C.F.R. § 63.1206(c)(3)(v)]
- hh. For each set of 10 exceedances of an emissions standard or operating requirement while hazardous waste remains in the combustion chamber during a 60-day block period, the permittee must submit to the Administrator a written report within 5 calendar days of the 10th exceedance documenting the exceedances and the

- results of the investigation and corrective measures taken. [Reg.19.304 and 40 C.F.R. § 63.1206(c)(3)(vi)(A)]
- ii. On a case-by-case basis, the Administrator may require excessive exceedance reporting when fewer than 10 exceedances occur during a 60-day block period. [Reg.19.304 and 40 C.F.R. § 63.1206(c)(3)(vi)(B)]
 - jj. The AWFCO system and associated alarms must be tested at least weekly to verify operability, unless the permittee documents in the operating record that weekly inspections will unduly restrict or upset operations and that less frequent inspection will be adequate. At a minimum, the permittee must conduct operability testing at least monthly. The permittee must document and record in the operating record AWFCO operability test procedures and results. [Reg.19.304 and 40 C.F.R. § 63.1206(c)(3)(vii)]
 - kk. The permittee may ramp down waste feed according to the requirements of §63.1206(c)(3)(viii), except as provided in §63.1206(c)(3)(B). The permittee must document ramp down procedures in the operating and maintenance plan. If the AWFCO is triggered by an exceedance of any of the following operating limits, the permittee may not ramp down the waste feed cutoff: Minimum combustion chamber temperature, maximum hazardous waste feedrate, or any hazardous waste firing system operating limits that may have been established. [Reg.19.304 and 40 C.F.R. § 63.1206(c)(3)(viii)]
 - ll. The permittee is subject to the emergency safety vent (ESV) operating and reporting requirements set forth in this section. [Reg.19.304 and 40 C.F.R. § 63.1206(c)(4)(i through iv)]
 - mm. The permittee is subject to the combustion system leak control system operating and reporting requirements set forth in these sections. [Reg.19.304 and 40 C.F.R. § 63.1206(c)(5)(i)(A) and (ii)]
 - nn. The permittee is subject to the operator training and certification standards set forth in this section. [Reg.19.304 and 40 C.F.R. § 63.1206(c)(6)(i through vii)]
 - oo. The permittee must prepare and at all times operate according to an operation and maintenance plan which complies with the requirements set forth in these sections. [Reg.19.304 and 40 C.F.R. § 63.1206(c)(7)(i)(A-D)]

Performance Testing Requirements

- pp. The permittee must conduct performance testing in accordance with the applicable requirements contained in this section. [Reg.19.304 and 40 C.F.R. § 63.1207(a-m)]
- qq. The permittee must commence the initial comprehensive performance test not later than six months after the compliance date. [Reg.19.304 and 40 C.F.R. § 63.1207(c)(1)]
- rr. The permittee must conduct testing periodically as described in paragraphs (d)(1) through (3) of this section. The date of commencement of the initial

comprehensive performance test is the basis for establishing the deadline to commence the initial confirmatory performance test and the next comprehensive performance test. The permittee may conduct performance testing at any time prior to the required date. The deadline for commencing subsequent confirmatory and comprehensive performance testing is based on the date of commencement of the previous comprehensive performance test. [Reg.19.304 and 40 C.F.R. § 63.1207(d)(1) through (3)]

- i. The permittee must commence comprehensive testing no later than 61 months after the date of commencing the previous comprehensive performance test.
- ii. The permittee must commence confirmatory performance testing no later than 31 months after the date of commencing the previous comprehensive performance test. To ensure that the confirmatory test is conducted approximately midway between comprehensive performance tests, the Administrator will not approve a test plan that schedules testing within 18 months of commencing the previous comprehensive performance test.
- iii. The permittee must complete performance testing within 60 days after the date of commencement, unless the Administrator determines that a time extension is warranted based on documentation in writing of factors beyond the permittee's control that prevent testing from being completed within 60 days.

Applicable Testing Requirements under the Interim Standard

- ss. Waiver of periodic comprehensive performance tests. Except as provided by §63.1207(c)(2), the permittee must conduct only an initial comprehensive performance test under the interim standards (i.e., the standards published in the Federal Register on February 13, 2002). All subsequent comprehensive performance testing requirements are waived under the interim standards. The provisions in the introductory test to paragraph (d) and in paragraph (d)(1) of this section do not apply until EPA promulgates permanent replacement standards pursuant to the Settlement Agreement noticed in the Federal Register on November 16, 2001. [Reg.19.304 and 40 C.F.R. § 63.1207(d)(4)(i)].
- tt. Waiver of periodic confirmatory performance tests. The permittee is not required to conduct a confirmatory test under the interim standards (i.e., the standards published in the Federal Register on February 13, 2002). The confirmatory testing requirements in the introductory text to paragraph (d) and in (d)(2) of §63.1207 are waived until EPA promulgates permanent replacement standards pursuant to the Settlement Agreement noticed in the Federal Register on November 16, 2001. [Reg.19.304 and 40 C.F.R. § 63.1207(d)(4)(ii)].
- uu. The permittee must submit to the Administrator a notification of intent to conduct a comprehensive performance test and CMS performance evaluation and a site specific test plan and CMS performance evaluation plan at least one year before

the performance test and performance evaluation are scheduled to begin.
[Reg.19.304 and 40 C.F.R. § 63.1207(e)(1)(i)]

- vv. The permittee must submit to the Administrator a notification of intent to conduct the comprehensive performance test at least 60 calendar days before the test is scheduled to begin. [Reg.19.304 and 40 C.F.R. § 63.1207(e)(1)(i)(B)]
- ww. The permittee must submit to the Administrator a notification of intent to conduct a confirmatory performance test and CMS performance evaluation and a test plan and CMS performance evaluation plan at least 60 calendar days before the performance test is scheduled to begin. [Reg.19.304 and 40 C.F.R. § 63.1207(e)(1)(ii)]

Test Methods

- xx. The permittee shall use the test methods contained in this section when determining compliance with the emissions standards of this subpart.
[Reg.19.304 and 40 C.F.R. § 63.1208(a-b)]

Monitoring Requirements

- yy. The permittee is subject to the applicable monitoring requirements contained in these sections. [Reg.19.304 and 40 C.F.R. § 63.1209 (a-q)]
- zz. The permittee must either use a carbon monoxide or hydrocarbon CEMS to demonstrate compliance with either the carbon monoxide and hydrocarbon standards under this subpart. The permittee must also use an oxygen CEMS to continuously correct the carbon monoxide and hydrocarbon levels to 7 percent oxygen. [Reg.19.304 and 40 C.F.R. § 63.1209(a)(1)(i)]
- aaa. The permittee must install, calibrate, maintain, and operate a particulate matter CEMS to demonstrate and monitor compliance with the particulate matter standards under this subpart. However, compliance with the requirements in this section to install, calibrate, maintain, and operate the PM CEMS is not required until such time that the Agency promulgates all performance specifications and operational requirements applicable to PM CEMS. [Reg.19.304 and 40 C.F.R. § 63.1209(a)(1)(iii)]
- bbb. The permittee must install, calibrate, maintain, and continuously operate the CEMS in compliance with the quality assurance procedures provided in the appendix to this subpart and Performance Specifications 1 (opacity), 4B (carbon monoxide and oxygen), and 8A (hydrocarbons) in Appendix B, Part 60 of this chapter. [Reg.19.304 and 40 C.F.R. § 63.1209(a)(2)]
- ccc. The permittee must comply with the span requirements of '63.1209(a)(4).
[Reg.19.304 and 40 C.F.R. § 63.1209(a)(4)]
- ddd. The permittee may petition the Administrator to use CEMS for compliance monitoring for other standards in lieu of compliance with the corresponding

- operating parameter limits under this section. [Reg.19.304 and 40 C.F.R. § 63.1209(a)(5)]
- eee. The permittee will begin recording one-minute and hourly rolling average values as necessary to ensure that 60 one-minute values will be available for calculating the initial hourly rolling average before the compliance date. The permittee will continue to use the CEMS to monitor parameters as required in '63.1209(a)(6). [Reg.19.304 and 40 C.F.R. § 63.1209(a)(6)]
 - fff. The permittee will use Continuous Monitoring Systems where necessary to ensure compliance with operating parameters established in the Documentation of Compliance or the Notification of Compliance. [Reg.19.304 and 40 C.F.R. § 63.1209(b)]
 - ggg. Prior to feeding the material, the permittee must obtain an analysis of each feedstream that is sufficient to document compliance with the applicable feedrate limits provided in this section. [Reg.19.304 and 40 C.F.R. § 63.1209(c)(1)]
 - hhh. The permittee must develop and implement a feedstream analysis plan and record it in the operating record. [Reg.19.304 and 40 C.F.R. § 63.1209(c)(2)]
 - iii. The permittee must submit the feedstream analysis plan to the Administrator for review and approval, if requested. [Reg.19.304 and 40 C.F.R. § 63.1209(c)(3)]
 - jjj. To comply with the applicable feedrate limits of this section, the permittee must monitor and record the feedrates as follows: [Reg.19.304 and 40 C.F.R. § 63.1209(c)(4)]
 - i. Determine and record the value of the parameter for each feedstream by sampling and analysis or other method;
 - ii. Determine and record the mass or volume flowrate of each stream by a CMS. If the permittee determines flowrate of a feedstream by volume, the permittee must determine and record the density of the feedstream by sampling and analysis (unless the permittee reports the constituent concentration in units of weight per volume); and
 - iii. Calculate and record the mass feedrate of the parameter per unit time.
 - kkk. The requirements of §63.8(d) (Quality control program) and (e) (Performance evaluation of continuous monitoring systems) apply, except that the permittee must conduct performance evaluations components of the CMS under the frequency and procedures (for example, submittal of performance evaluation test plan for review and approval) applicable to performance tests as provided by §63.1207. [Reg.19.304 and 40 C.F.R. § 63.1209(d)(1)]
 - lll. The permittee shall maintain and operate each CMS as specified in '63.8(c), except for '63.8(c)(3) and §63.8(c)(4)(ii). The permittee shall have the CMS installed, calibrated, and operational on the compliance date. The permittee must sample the regulated parameter without interruption, and evaluate the detector

- response at least once each 15 seconds, and compute and record the average values at least every 60 seconds. [Reg.19.304 and 40 C.F.R. § 63.1209(f)]
- mmm. The permittee shall follow the requirements for the reduction of monitoring data as specified in 40 CFR §63.8(g). [Reg.19.304 and 40 C.F.R. § 63.1209(h)]
- nnn. When one operating parameter is used to ensure compliance with one or more standards, the permittee must use the most stringent limit, determined during the comprehensive performance test, as the limit for that operating parameter. [Reg.19.304 and 40 C.F.R. § 63.1209(i)]
- ooo. To remain in compliance with the destruction and removal efficiency (DRE) standards, the permittee must establish operating limits during the comprehensive performance test (or during a previous DRE test under provisions of §63.1206(b)(7)) for the following parameters, unless the limits are based on manufacturer specifications and comply with those limits at all times that hazardous waste remains in the combustion chamber. [Reg.19.304 and 40 C.F.R. § 63.1209(j)]
- ppp. The permittee must measure the temperature of each combustion chamber at locations that best represents, as practicable, the bulk gas temperature in the combustion zone. The permittee must document the temperature measurement location in the test plan submitted under §63.1207(e), and establish a minimum rolling average limit as the average of the test run values. [Reg.19.304 and 40 C.F.R. § 63.1209(j)(1)(i) and (ii)]
- qqq. As an indicator of gas residence time in the control device, the permittee must establish and comply with a limit on the maximum flue gas flowrate, the maximum production rate, or another parameter that is documented in the site-specific test plan as an appropriate surrogate for gas residence time, as the average of the maximum hourly rolling averages for each run. [Reg.19.304 and 40 C.F.R. § 63.1209(j)(2)(i)]
- rrr. The permittee must establish limits on the maximum pumpable and total (i.e., pumpable and nonpumpable) hazardous waste feedrate for each location where hazardous waste is fed. [Reg.19.304 and 40 C.F.R. § 63.1209(j)(3)(i)]
- sss. The permittee must specify operating parameters and limits to ensure that good operation of each hazardous waste firing system is maintained. [Reg.19.304 and 40 C.F.R. § 63.1209(j)(4)]
- ttt. The permittee must comply with the dioxin and furans emission standard by establishing and complying with the following operating parameter limits. You must base the limits on operations during the comprehensive performance test, unless the limits are based on manufacturer specifications. [Reg.19.304 and 40 C.F.R. § 63.1209(k)]
- uuu. The permittee must establish and comply with a limit on the maximum temperature of the gas at the inlet to the electrostatic precipitator (ESP) on an hourly rolling average. The permittee must establish the hourly rolling average

- limit as the average of the test run averages. [Reg.19.304 and 40 C.F.R. § 63.1209(k)(1)(i)]
- vvv. The permittee must measure the temperature of each combustion chamber at a location that best represents, as practicable, the bulk gas temperature in the combustion zone. The permittee must document the temperature measurement location in the test plan and establish a minimum hourly rolling average limit as the average of the test runs. [Reg.19.304 and 40 C.F.R. § 63.1209(k)(2)(i) and (ii)]
- www. As an indicator of gas residence time in the control device, the permittee must establish and comply with a limit on the maximum flue gas flowrate, the maximum production rate, or another parameter which is an appropriate surrogate for residence time, as the hourly rolling averages for each run. Compliance with this limit is on an hourly rolling average basis. [Reg.19.304 and 40 C.F.R. § 63.1209(k)(3)(i) and (ii),]
- xxx. The permittee must establish limits on the maximum pumpable and total (pumpable and nonpumpable) waste feedrate for each location where waste is fed and establish limits as the average of the maximum hourly rolling averages for each run. Compliance shall be based on an hourly rolling average basis. [Reg.19.304 and 40 C.F.R. § 63.1209(k)(4)(i B iii)]
- yyy. The permittee shall ensure compliance with the mercury emission standard by establishing a maximum mercury feed rate limit. The limit is established as a 12-hour rolling average limit for the total feedrate of mercury in all feedstreams as the average of the test run values, unless mercury feedrate limits are extrapolated from performance test feedrate levels as described under §63.1209(l)(v). [Reg.19.304 and 40 C.F.R. § 63.1209(l)]
- zzz. The permittee must comply with the particulate matter emission standard by establishing and complying with the applicable operating parameter limits found in §63.1209(m) of this subpart. [Reg.19.304 and 40 C.F.R. § 63.1209(m)]
- aaaa. As an indicator of gas residence time in the control device, the permittee must establish and comply with a limit on the maximum flue gas flowrate, the maximum production rate, or another parameter that is documented in the site-specific test plan as an appropriate surrogate for gas residence time, as the average of the maximum hourly rolling averages for each run. [Reg.19.304 and 40 C.F.R. § 63.1209(m)(2)]
- bbbb. The permittee must establish a maximum ash feedrate limit as a 12-hour rolling average based on the average of the test run averages. [Reg.19.304 and 40 C.F.R. § 63.1209(m)(3)]
- cccc. The permittee must comply with the semivolatile metal (cadmium and lead) and low volatile metal (arsenic, beryllium, and chromium) emission standards by establishing and complying with the following operating parameter limits: [Reg.19.304 and 40 C.F.R. § 63.1209(n)]

- i. The permittee must establish a limit on the maximum inlet temperature to the ESP on an hourly rolling average basis as the average of the test run averages. [Reg.19.304 and 40 C.F.R. § 63.1209(n)(1)]
- ii. The permittee must establish a total feed rate limit for semivolatile metals and low volatile metals, with compliance based on 12-hour rolling average limits as the average of the test run averages unless the metal feedrate limits are extrapolated from performance test feedrate levels as described under §63.1209(n)(2)(vii). [Reg.19.304 and 40 C.F.R. § 63.1209(n)(2)(ii)]
- iii. The permittee must establish a separate feedrate limit for low volatile metals in pumpable feedstreams, with compliance based on 12-hour rolling average limits as the average of the test run averages, unless the metal feedrate limits are extrapolated from performance test feedrate levels as described under §63.1209(n)(2)(vii). [Reg.19.304 and 40 C.F.R. § 63.1209(n)(2)(vi)]
- dddd. The permittee must establish a 12-hour rolling average limit for the total feedrate of chlorine in all feedstreams as the average of the test run averages. [Reg.19.304 and 40 C.F.R. § 63.1209(o)(1)(i)]
- eeee. As an indicator of gas residence time in the control device, the permittee must establish a limit on the maximum flue gas flowrate, the maximum production rate, or another parameter documented in the site-specific test plan as an appropriate surrogate for gas residence time, as the average of the maximum hourly rolling averages for each run. This limit must be maintained on an hourly rolling average basis. [Reg.19.304 and 40 C.F.R. § 63.1209(o)(2)(i)]
- ffff. The permittee must perform instantaneous monitoring of pressure and the automatic waste feed cutoff system must be engaged when negative pressure is not adequately maintained. [Reg.19.304 and 40 C.F.R. § 63.1209(p)]
- gggg. The permittee may choose to operate under different modes of operation as described in this section. The permittee must establish operating parameter limits for each mode and must document in the operating record when the permittee changes modes of operation and begins complying with the operating limits for an alternative mode of operation. [Reg.19.304 and 40 C.F.R. § 63.1209(q)]
- hhhh. The permittee may elect to use shorter averaging periods than those specified in this section. [Reg.19.304 and 40 C.F.R. § 63.1209(r)]

Notification Requirements

- iiii. The permittee shall submit all of the applicable notifications prior to the deadlines established in this subpart. [Reg.19.304 and 40 C.F.R. § 63.1210(a)(1)]
- jjjj. The permittee must submit the required notifications outlined in this section to the Administrator in order to request or elect to comply with the alternative requirements contained in this subpart. [Reg.19.304 and 40 C.F.R. § 63.1210(a)(2)]

FutureFuel Chemical Company
Permit #: 1085-AOP-R16
AFIN: 32-00036

kkkk. Upon postmark of the Notification of Compliance, the operating parameter limits identified in the Notification of Compliance, as applicable, shall be complied with, the limits identified in the Document of Compliance or a previous Notification of Compliance are no longer applicable. [Reg.19.304 and 40 C.F.R. § 63.1210(b)(2)]

Recordkeeping and Reporting Requirements

llll. The permittee shall submit the reports required by this subpart to the Administrator prior to the deadlines set forth in this subpart. [Reg.19.304 and 40 C.F.R. § 63.1211]

Procedure for Extending the Compliance Date

mmmm. The permittee may request an extension of the compliance date to install pollution prevention or waste minimization controls provided that the conditions outlined in this section are met. [Reg.19.304 and 40 C.F.R. § 63.1213]

40 CFR Part 63 Subpart DDDDD—National Emission Standards for Hazardous Air Pollutants for Major Sources: Industrial, Commercial, and Institutional Boilers and Process Heaters

US 52. Sources SN-6M06-01 and SN-6M07-01 are subject to the provisions of 40 CFR Part 63, Subpart DDDDD – National Emission Standards for Hazardous Air Pollutants for Major Sources: Industrial, Commercial, and Institutional Boilers and Process Heaters. The applicable provisions of this subpart include, but are not limited to, the items found in Specific Conditions US 53 through US 76. [Reg.19.304 and 40 C.F.R. §§ 63.6585, 63.6590(c), 63.6595(a) and A.C.A. §8-4-203 as referenced by §8-4-304 and §8-4-311]

US 53. The permittee must meet the requirements in paragraphs (a)(1) through (3) of §63.7500, except as provided in paragraphs (b), through (e) of §63.7500. The permittee must meet these requirements at all times the affected unit is operating, except as provided in paragraph (f) of §63.7500. [Reg.19.304 and 40 C.F.R. § 63.7500(a)]

US 54. The permittee must meet each emission limit and work practice standard in Tables 1 through 3, and 11 through 13 to 40 CFR Part 63, Subpart DDDDD that applies to the permittee's boiler or process heater, for each boiler or process heater at the permittee's source, except as provided under §63.7522. The output-based emission limits, in units of pounds per million Btu of steam output, in Tables 1 or 2 to Subpart DDDDD are an alternative applicable only to boilers and process heaters that generate steam. The output-based emission limits, in units of pounds per megawatt-hour, in Tables 1 or 2 to Subpart DDDDD are an alternative applicable only to boilers that generate electricity. If the permittee operates a new boiler or process heater, the permittee can choose to comply with alternative limits as discussed in paragraphs (a)(1)(i) through (a)(1)(iii) of §63.7500, but on or after January 31, 2016, the permittee must comply with the emission limits in Table 1 to Subpart DDDDD.

- a. If the permittee's boiler or process heater commenced construction or reconstruction after June 4, 2010 and before May 20, 2011, the permittee may comply with the emission limits in Table 1 or 11 to Subpart DDDDD until January 31, 2016.
- b. If the permittee's boiler or process heater commenced construction or reconstruction after May 20, 2011 and before December 23, 2011, the permittee may comply with the emission limits in Table 1 or 12 to Subpart DDDDD until January 31, 2016.
- c. If the permittee's boiler or process heater commenced construction or reconstruction after December 23, 2011 and before January 31, 2013, the permittee may comply with the emission limits in Table 1 or 13 to Subpart DDDDD until January 31, 2016.

[Reg.19.304 and 40 C.F.R. § 63.7500(a)(1)(i-iii)]

US 55. At all times, the permittee must operate and maintain any affected source (as defined in §63.7490), including associated air pollution control equipment and monitoring equipment, in a manner consistent with safety and good air pollution control practices for minimizing emissions. Determination of whether such operation and maintenance procedures are being used will be based on information available to the Administrator that may include, but is not limited to, monitoring results, review of operation and maintenance procedures, review of operation and maintenance records, and inspection of the source. [Reg.19.304 and 40 C.F.R. § 63.7500(a)(3)]

US 56. Boilers and process heaters in the units designed to burn gas 1 fuels subcategory are not subject to the emission limits in Tables 1 and 2 or 11 through 13 to Subpart DDDDD, or the operating limits in Table 4 to Subpart DDDDD. [Reg.19.304 and 40 C.F.R. § 63.7500(e)]

US 57. These standards apply at all times the affected unit is operating, except during periods of startup and shutdown during which time the permittee must comply only with Table 3 to Subpart DDDDD. [Reg.19.304 and 40 C.F.R. § 63.7500(f)]

US 58. In response to an action to enforce the standards set forth in §63.7500 the permittee may assert an affirmative defense to a claim for civil penalties for violations of such standards that are caused by malfunction, as defined at §63.2. Appropriate penalties may be assessed if the permittee fail to meet the permittee's burden of proving all of the requirements in the affirmative defense. The affirmative defense shall not be available for claims for injunctive relief. [Reg.19.304 and 40 C.F.R. § 63.7501]

US 59. The permittee must be in compliance with the emission limits, work practice standards, and operating limits in this subpart. These limits apply to the permittee at all times the affected unit is operating except for the periods noted in §63.7500(f). [Reg.19.304 and 40 C.F.R. § 63.7505(a)]

- US 60. For existing affected sources (as defined in §63.7490), the permittee must complete the initial compliance demonstration, as specified in paragraphs (a) through (d) of §63.7510, no later than 180 days after the compliance date that is specified for the permittee's source in §63.7495 and according to the applicable provisions in §63.7(a)(2) as cited in Table 10 to Subpart DDDDD, except as specified in paragraph (j) of §63.7510. The permittee must complete an initial tune-up by following the procedures described in §63.7540(a)(10)(i) through (vi) no later than the compliance date specified in §63.7495, except as specified in paragraph (j) of §63.7510. The permittee must complete the one-time energy assessment specified in Table 3 to Subpart DDDDD no later than the compliance date specified in §63.7495, except as specified in paragraph (j) of §63.7510. [Reg.19.304 and 40 C.F.R. § 63.7510(e)]
- US 61. If the permittee is required to meet an applicable tune-up work practice standard, the permittee must conduct an annual, biennial, or 5-year performance tune-up according to §63.7540(a)(10), (11), or (12), respectively. Each annual tune-up specified in §63.7540(a)(10) must be no more than 13 months after the previous tune-up. Each biennial tune-up specified in §63.7540(a)(11) must be conducted no more than 25 months after the previous tune-up. Each 5-year tune-up specified in §63.7540(a)(12) must be conducted no more than 61 months after the previous tune-up. For a new or reconstructed affected source (as defined in §63.7490), the first annual, biennial, or 5-year tune-up must be no later than 13 months, 25 months, or 61 months, respectively, after the initial startup of the new or reconstructed affected source. [Reg.19.304 and 40 C.F.R. § 63.7515(d)]
- US 62. For affected sources (as defined in §63.7490) that have not operated since the previous compliance demonstration and more than one year has passed since the previous compliance demonstration, the permittee must complete the subsequent compliance demonstration, if subject to the emission limits in Tables 1, 2, or 11 through 13 to Subpart DDDDD, no later than 180 days after the re-start of the affected source and according to the applicable provisions in §63.7(a)(2) as cited in Table 10 to Subpart DDDDD. The permittee must complete a subsequent tune-up by following the procedures described in §63.7540(a)(10)(i) through (vi) and the schedule described in §63.7540(a)(13) for units that are not operating at the time of their scheduled tune-up. [Reg.19.304 and 40 C.F.R. § 63.7515(g)]
- US 63. The permittee must include with the Notification of Compliance Status a signed certification that the energy assessment was completed according to Table 3 to Subpart DDDDD and is an accurate depiction of the permittee's facility at the time of the assessment. [Reg.19.304 and 40 C.F.R. § 63.7530(e)]
- US 64. The permittee must submit the Notification of Compliance Status containing the results of the initial compliance demonstration according to the requirements in §63.7545(e). [Reg.19.304 and 40 C.F.R. § 63.7530(f)]

- US 65. The permittee must demonstrate continuous compliance with each emission limit in Tables 1 and 2 or 11 through 13 to Subpart DDDDD, the work practice standards in Table 3 to Subpart DDDDD, and the operating limits in Table 4 to Subpart DDDDD that applies to the permittee according to the methods specified in Table 8 to Subpart DDDDD and paragraphs (a)(1) through (19) of §63.7540. [Reg.19.304 and 40 C.F.R. § 63.7540(a)]
- US 66. If the unit is not operating on the required date for a tune-up, the tune-up must be conducted within 30 calendar days of startup. [Reg.19.304 and 40 C.F.R. § 63.7540(a)(13)]
- US 67. The permittee must submit to the Administrator all of the notifications in §§63.7(b) and (c), 63.8(e), (f)(4) and (6), and 63.9(b) through (h) that apply to the permittee by the dates specified. [Reg.19.304 and 40 C.F.R. § 63.7545(a)]
- US 68. If the permittee is required to conduct an initial compliance demonstration as specified in §63.7530, the permittee must submit a Notification of Compliance Status according to §63.9(h)(2)(ii). For the initial compliance demonstration for each boiler or process heater, the permittee must submit the Notification of Compliance Status, including all performance test results and fuel analyses, before the close of business on the 60th day following the completion of all performance test and/or other initial compliance demonstrations for all boiler or process heaters at the facility according to §63.10(d)(2). The Notification of Compliance Status report must contain all the information specified in paragraphs (e)(1) through (8), as applicable. If the permittee is not required to conduct an initial compliance demonstration as specified in §63.7530(a), the Notification of Compliance Status must only contain the information specified in paragraphs (e)(1) and (8).
- a. A signed certification that the permittee have met all applicable emission limits and work practice standards.
 - b. If the permittee had a deviation from any emission limit, work practice standard, or operating limit, the permittee must also submit a description of the deviation, the duration of the deviation, and the corrective action taken in the Notification of Compliance Status report.
 - c. In addition to the information required in §63.9(h)(2), the permittee's notification of compliance status must include the following certification(s) of compliance, as applicable, and signed by a responsible official:
 - i. "This facility complies with the required initial tune-up according to the procedures in §63.7540(a)(10)(i) through (vi)."
 - ii. "This facility has had an energy assessment performed according to §63.7530(e)."
- [Reg.19.304 and 40 C.F.R. § 63.7545(e)(6-8)]
- US 69. The permittee must submit each report in Table 9 to Subpart DDDDD that applies to the permittee. [Reg.19.304 and 40 C.F.R. § 63.7550(a)]

US 70. Unless the EPA Administrator has approved a different schedule for submission of reports under §63.10(a), the permittee must submit each report, according to paragraph (h) of §63.7550, by the date in Table 9 to Subpart DDDDD and according to the requirements in paragraphs (b)(1) through (4) of §63.7550. For units that are subject only to a requirement to conduct an annual, biennial, or 5-year tune-up according to §63.7540(a)(10), (11), or (12), respectively, and not subject to emission limits or operating limits, the permittee may submit only an annual, biennial, or 5-year compliance report, as applicable, as specified in paragraphs (b)(1) through (4) of §63.7550, instead of a semi-annual compliance report.

- a. The first compliance report must cover the period beginning on the compliance date that is specified for each boiler or process heater in §63.7495 and ending on July 31 or January 31, whichever date is the first date that occurs at least 180 days (or 1, 2, or 5 years, as applicable, if submitting an annual, biennial, or 5-year compliance report) after the compliance date that is specified for the permittee's source in §63.7495.
- b. The first compliance report must be postmarked or submitted no later than July 31 or January 31, whichever date is the first date following the end of the first calendar half after the compliance date that is specified for each boiler or process heater in §63.7495. The first annual, biennial, or 5-year compliance report must be postmarked or submitted no later than January 31.
- c. Each subsequent compliance report must cover the semiannual reporting period from January 1 through June 30 or the semiannual reporting period from July 1 through December 31. Annual, biennial, and 5-year compliance reports must cover the applicable 1-, 2-, or 5-year periods from January 1 to December 31.
- d. Each subsequent compliance report must be postmarked or submitted no later than July 31 or January 31, whichever date is the first date following the end of the semiannual reporting period. Annual, biennial, and 5-year compliance reports must be postmarked or submitted no later than January 31.

[Reg.19.304 and 40 C.F.R. § 63.7550(b)(1-4)]

US 71. A compliance report must contain the following information depending on how the facility chooses to comply with the limits set in this rule.

- a. If the facility is subject to a the requirements of a tune up they must submit a compliance report with the information in paragraphs (c)(5)(i) through (iv) and (xiv) of §63.7550.

[Reg.19.304 and 40 C.F.R. § 63.7550(c)(1)]

US 72. Company and Facility name and address.

- a. Process unit information, emissions limitations, and operating parameter limitations.
- b. Date of report and beginning and ending dates of the reporting period.
- c. The total operating time during the reporting period.
- d. Include the date of the most recent tune-up for each unit subject to only the requirement to conduct an annual, biennial, or 5-year tune-up according to §63.7540(a)(10), (11), or (12) respectively. Include the date of the most recent

burner inspection if it was not done annually, biennially, or on a 5-year period and was delayed until the next scheduled or unscheduled unit shutdown.

[Reg.19.304 and 40 C.F.R. § 63.7550(c)(5)(i-xiv)]

US 73. The permittee must keep records according to paragraphs (a)(1) and (2) of §63.7555.

- a. A copy of each notification and report that the permittee submitted to comply with this subpart, including all documentation supporting any Initial Notification or Notification of Compliance Status or semiannual compliance report that the permittee submitted, according to the requirements in §63.10(b)(2)(xiv).
- b. Records of performance tests, fuel analyses, or other compliance demonstrations and performance evaluations as required in §63.10(b)(2)(viii).

[Reg.19.304 and 40 C.F.R. § 63.7555(a)(1-2)]

US 74. The permittee's records must be in a form suitable and readily available for expeditious review, according to §63.10(b)(1). [Reg.19.304 and 40 C.F.R. § 63.7560(a)]

US 75. As specified in §63.10(b)(1), the permittee must keep each record for 5 years following the date of each occurrence, measurement, maintenance, corrective action, report, or record. [Reg.19.304 and 40 C.F.R. § 63.7560(b)]

US 76. The permittee must keep each record on site, or they must be accessible from onsite (for example, through a computer network), for at least 2 years after the date of each occurrence, measurement, maintenance, corrective action, report, or record, according to §63.10(b)(1). The permittee can keep the records off site for the remaining 3 years. [Reg.19.304 and 40 C.F.R. § 63.7560(c)]

Organic Sulfonation Process

5M01-01, 5M01-02, 5M01-05, 5M01-06, 5M01-07, 5M01-08 5M01-09, 5M03-01, 5M03-02, 5M04-01, 5M04-02, 5M04-10, 5M05-01, 5M05-02, 5M11-01, 5M11-04, 5M11-05, 5M11-06, 5M11-07, 5M11-15, 5M13-01, 5M16-01, 5M18-01, 5M18-02, 5M18-03, 5MNOBS-TNK, NOBS-FUG, 5M01-TSP

Source Description

The organic sulfonate facility produces a solid material for use as a household consumer product. The two organic sulfonation facilities include reactors, centrifuges, scrubbers, distillation equipment, raw materials and process tanks. Scrubbers are the primary means for controlling emissions from the production facilities. The phenol and solvent storage tanks vent to a scrubber. The low vapor pressures of the contents of the storage tanks minimize the potential for VOC emissions from these emission points.

NSPS subpart NNN (SOCMI Distillation Operations) applies to a scrubber associated with an acetic acid distillation column (5M01-02).

NSPS Subpart VV (SOCMI VOC Equipment Leaks) applies to certain equipment in this process such as pumps, compressors, pressure relief devices, sampling connection systems, and valves.

NSPS Subpart Kb (VOC Storage Vessels) applies to several tanks in the organic sulfonate production area. These requirements are located within the Plantwide Conditions.

Specific Conditions

OSP 1. The permittee shall not exceed the emission rates set forth in the following table. Emission rates are based upon the maximum capacity of equipment. [Reg.19.501 *et seq.* and 40 C.F.R. § 52 Subpart E]

SN	Description	Pollutant	lb/hr
5M01-01	Scrubber	VOC	0.1
5M01-02	Scrubber	VOC	0.1
5M01-05	Scrubber	VOC	0.1
5M01-06	Scrubber	VOC	0.5
5M01-07	Scrubber	VOC	0.1
5M01-08	Scrubber	VOC	0.1
5M01-09	Scrubber	VOC	0.2
5M03-01	Scrubber	VOC	0.1
5M03-02	Scrubber	VOC	0.2

SN	Description	Pollutant	lb/hr
5M04-01	Scrubber	VOC	0.6
5M04-02	Scrubber	VOC	0.2
5M04-10	Scrubber	SO ₂	0.1
5M05-01	Scrubber	VOC	0.1
5M05-02	Filter	PM ₁₀	0.1
5M11-01	Scrubber	VOC	0.1
5M11-04	Scrubber	VOC	0.1
5M11-05	Scrubber	VOC	0.1
5M11-06	Scrubber	VOC	0.1
5M11-07	Scrubber	VOC	0.1
5M11-15	SPS Supersack Load Hopper Dust Control System	PM ₁₀	0.1
5M13-01	Scrubber	VOC	0.1
5M16-01	Supersack Loadout Dust Control System	PM ₁₀	0.1
5M18-01	Continuous Dust Control System	PM ₁₀	3.9
5M18-02	Central Vacuum Cleaning System	PM ₁₀	3.4
5M18-03	Bin Vacuum Cleaning System	PM ₁₀	0.3
5MNOBS-TNK	Aggregate Tank (4 tanks)	VOC	0.6
NOBS-FUG	Fugitive Emissions from Organic Sulfonation Process	VOC	1.2
5M01-TSP	Dust Control Maintenance Fugitives	PM ₁₀	3.1

OSP 2. The permittee shall not exceed the emission rates set forth in the following table. Emission rates are based upon the maximum capacity of equipment. The facility shall show compliance with the facility total ton/yr limits using the procedures outlined in PW 11 through PW 15. Hourly Plantwide Hazardous Air Pollutant emissions are limited by PW 15. Additional HAP limitations are included in PW 12. [Reg.18.801 and Ark. Code Ann. § 8-4-203 as referenced by Ark. Code Ann. §§ 8-4-304 and 8-4-311]

SN	Description	Pollutant	lb/hr
5M01-01	Scrubber	Organic Pollutants**	***
5M01-02	Scrubber	Organic Pollutants**	***
5M01-05	Scrubber	Organic Pollutants**	***
5M01-06	Scrubber	Organic Pollutants**	***
5M01-07	Scrubber	Organic Pollutants**	***
5M01-08	Scrubber	Organic Pollutants**	***
5M01-09	Scrubber	Organic Pollutants**	***
5M03-01	Scrubber	Organic Pollutants**	***
5M03-02	Scrubber	Organic Pollutants**	***
5M04-01	Scrubber	Organic Pollutants**	***
5M04-02	Scrubber	Organic Pollutants**	***
5M05-01	Scrubber	Organic Pollutants**	***
5M05-02	Filter	PM	0.1
5M11-01	Scrubber	Organic Pollutants**	***
5M11-04	Scrubber	Organic Pollutants**	***
5M11-05	Scrubber	Organic Pollutants**	***
5M11-06	Scrubber	Organic Pollutants**	***
5M11-07	Scrubber	Organic Pollutants**	***
5M11-15	SPS Supersack Load Hopper Dust Control System	PM	0.1
5M13-01	Scrubber	Organic Pollutants**	***
5M16-01	Supersack Loadout Dust Control System	PM	0.1
5M18-01	Continuous Dust Control System	PM	3.9
5M18-02	Central Vacuum Cleaning System	PM	3.4

SN	Description	Pollutant	lb/hr
5M18-03	Bin Vacuum Cleaning System	PM	0.3
5MNOBS-TNK	Aggregate Tank (5 tanks)	Organic Pollutants**	***
NOBS-FUG	Fugitive Emissions from Organic Sulfonation Process	Organic Pollutants**	***
5M01-TSP	Dust Control Maintenance Fugitives	PM	3.1

*Inorganics are considered to be non-organic Hazardous Air Pollutants

**Organic Pollutants are considered to be VOC, all organic HAPs, and organic Air Contaminates.

***Limited by Plantwide Condition 12.

OSP 3. The permittee shall not exceed 5% opacity over a three (3) hour period at sources 5M05-02, 5M11-15, 5M16-01, 5M18-01, 5M18-02, and 5M18-03. Compliance with this limit shall be demonstrated as outlined in the most current version of the Facility Operating Plan. [Reg.18.801 and Ark. Code Ann. § 8-4-203 as referenced by Ark. Code Ann. §§ 8-4-304 and 8-4-311]

OSP 4. The permittee shall conduct weekly visual inspections at 5M05-02, 5M11-15, 5M16-01, 5M18-01, 5M18-02, and 5M18-03 for possible emissions using EPA Method 22 and monthly observations of the system using EPA Method 9. The permittee shall record the presence of any excessive visible emissions and the subsequent actions taken to correct the exceedance. [Reg.18.801 and Ark. Code Ann. § 8-4-203 as referenced by Ark. Code Ann. §§ 8-4-304 and 8-4-311]

OSP 5. The permittee shall measure the pressure drop at least daily at 5M05-02, 5M11-15, 5M16-01, 5M18-01, 5M18-02, and 5M18-03 as outlined in the most current version of the Facility Operating Plan. [Reg.19.705, Ark. Code Ann. § 8-4-203 as referenced by Ark. Code Ann. §§ 8-4-304 and 8-4-311, and 40 C.F.R. § 70.6]

OSP 6. The permittee shall keep records on site of the pressure drop at 5M05-02, 5M11-15, 5M16-01, 5M18-01, 5M18-02, and 5M18-03. [Reg.19.705 and 40 C.F.R. § 52 Subpart E]

OSP 7. The permittee shall maintain a daily flowrate on scrubbers in this section in accordance with most current version of the Facility Operating Plan. [Reg.19.303 and Ark. Code Ann. § 8-4-203 as referenced by Ark. Code Ann. §§ 8-4-304 and 8-4-311]

40 CFR Part 60 Subpart NNN - Manufacturing Industry (SOCMI) Distillation Operations

- OSP 8. The permittee shall maintain a TRE index value of greater than 1.0 without the use of VOC emission control device for 5M01-02. The permittee shall document and record all calculations performed to determine the TRE index value of the vent stream per §60.664(d), (e) and (f). [Reg.19.304 and 40 C.F.R. § 60.662(c)]
- OSP 9. The permittee shall keep up-to-date, readily accessible records of:
- a. Any changes in production capacity, feedstock type, or catalyst type, or of any replacement, removal or addition of recovery equipment or a distillation unit,
 - b. Any recalculation of the TRE index value performed pursuant to §60.664(f), and,
 - c. The results of any performance test performed pursuant to the methods and procedures required by §60.664(d). [Reg.19.304 and 40 C.F.R. § 60.665(h)]
- OSP 10. The provisions of this subpart apply to affected sources as defined in paragraph (b) of this section, and is part of process or production unit that produces any of the chemicals listed in §60.667 as a product, co-product, by-product, or intermediate, except as provided in paragraph (c). [Reg.19.304 and 40 C.F.R. § 60.660]
- OSP 11. This source is operated under the exemption allowed by this citation; being, an affected facility with a TRE index value greater than 8.0. This source is exempt from all provisions of this subpart except for §60.662; §60.664(d), (e), and (f); and §60.665(h) and (l). [Reg.19.304 and 40 C.F.R. § 60.660(c)(4)]
- OSP 12. The permittee shall use any of the options listed in §60.662(a), (b), or (c) for an applicable treatment standard, providing proper notification is provided to the Department to document the change in treatment standard. The permittee shall then comply with the requirements of §60.663, §60.664, and §60.665 as applicable to the emission standard chosen. [Reg.19.304 and 40 C.F.R. § 60.662]
- OSP 13. The permittee shall comply with all recordkeeping and reporting requirements in §60.665 as applicable to the treatment standard and control devices used to meet compliance with this subpart. [Reg.19.304 and 40 C.F.R. § 60.665]
- OSP 14. The permittee is exempt from the quarterly reporting requirements contained in §60.7(c) of the General Provisions. [Reg.19.304 and 40 C.F.R. § 60.665(k)]
- OSP 15. The permittee shall submit semiannual reports of the following information: Any recalculation of the TRE index value, as recorded under §60.665(h). [Reg.19.304 and 40 C.F.R. § 60.665]

40 CFR Part 60, Subpart VV - Standards of Performance for Equipment Leaks of VOC in SOCFMI

OSP 16. The equipment, including each valve, pump, pressure relief device, sampling connection system, open-ended valve or line, and flange or other connector in VOC service at the acetic acid recovery area, are affected facilities under the terms of 40 CFR Part 60 Subpart VV – Standards of Performance for Equipment Leaks of VOC in SOCFMI. [Reg.19.304 and 40 C.F.R. § 60.480]

Standards: General

OSP 17. For equipment subject to these standards, the following General Requirements apply:

- a. Each owner or operator subject to the provisions of this subpart shall demonstrate compliance with the requirements of §§ 60.482-1 through 60.482-10 or § 60.480(e) for all equipment within 180 days of initial startup. [Reg.19.304 and 40 C.F.R. § 60.482-1(a)]
- b. Compliance with §§ 60.482-1 to 60.482-10 will be determined by review of records and reports, review of performance test results, and inspection using the methods and procedures specified in § 60.485. [Reg.19.304 and 40 C.F.R. § 60.482-1(b)]
- c. An owner or operator may request a determination of equivalence of a means of emission limitation to the requirements of §§ 60.482-2, 60.482-3, 60.482-5, 60.482-6, 60.482-7, 60.482-8, and 60.482-10 as provided in § 60.484. [Reg.19.304 and 40 C.F.R. § 60.482-1(c)(1)]
- d. If the Administrator makes a determination that a means of emission limitation is at least equivalent to the requirements of §§ 60.482-2, 60.482-3, 60.482-5, 60.482-6, 60.482-7, 60.482-8, or 60.482-10, an owner or operator shall comply with the requirements of that determination. [Reg.19.304 and 40 C.F.R. § 60.482-1(c)(2)]
- e. Equipment that is in vacuum service is excluded from the requirements of §§ 60.482-2 to 60.482-10 if it is identified as required in § 60.486(e)(5). [Reg.19.304 and 40 C.F.R. § 60.482-1(d)]
- f. Equipment that an owner or operator designates as being in VOC service less than 300 hours (hr)/yr is excluded from the requirements of §§ 60.482-2 through 60.482-10 if it is identified as required in § 60.486(e)(6) and it meets any of the conditions specified in paragraphs (e)(1) through (3) of this section. [Reg.19.304 and 40 C.F.R. § 60.482-1(e)(i-iii)]
 - i. The equipment is in VOC service only during startup and shutdown, excluding startup and shutdown between batches of the same campaign for a batch process.
 - ii. The equipment is in VOC service only during process malfunctions or other emergencies.

- iii. The equipment is backup equipment that is in VOC service only when the primary equipment is out of service.
- g. If a dedicated batch process unit operates less than 365 days during a year, an owner or operator may monitor to detect leaks from pumps and valves at the frequency specified in the following table instead of monitoring as specified in §§ 60.482-2, 60.482-7, and 60.483-2:

Operating time (percent of hours during year)	Equivalent monitoring frequency time in use		
	Monthly	Quarterly	Semiannually
0 to <25	Quarterly	Annually	Annually.
25 to <50	Quarterly	Semiannually	Annually.
50 to <75	Bimonthly	Three quarters	Semiannually.
75 to 100	Monthly	Quarterly	Semiannually.

[Reg.19.304 and 40 C.F.R. § 60.482-1(f)(1)]

- h. Pumps and valves that are shared among two or more batch process units that are subject to this subpart may be monitored at the frequencies specified in paragraph (f)(1) of this section, provided the operating time of all such process units is considered. [Reg.19.304 and 40 C.F.R. § 60.482-1(f)(2)]
- i. The monitoring frequencies specified in paragraph (f)(1) of this section are not requirements for monitoring at specific intervals and can be adjusted to accommodate process operations. An owner or operator may monitor at any time during the specified monitoring period (e.g., month, quarter, year), provided the monitoring is conducted at a reasonable interval after completion of the last monitoring campaign. Reasonable intervals are defined in paragraphs (f)(3)(i) through (iv) of this section. [Reg.19.304 and 40 C.F.R. § 60.482-1(f)(3)(i-iv)]
 - i. When monitoring is conducted quarterly, monitoring events must be separated by at least 30 calendar days.
 - ii. When monitoring is conducted semiannually (*i.e.* , once every 2 quarters), monitoring events must be separated by at least 60 calendar days.
 - iii. When monitoring is conducted in 3 quarters per year, monitoring events must be separated by at least 90 calendar days.
 - iv. When monitoring is conducted annually, monitoring events must be separated by at least 120 calendar days.
- j. If the storage vessel is shared with multiple process units, the process unit with the greatest annual amount of stored materials (predominant use) is the process

unit the storage vessel is assigned to. If the storage vessel is shared equally among process units, and one of the process units has equipment subject to subpart VVa of this part, the storage vessel is assigned to that process unit. If the storage vessel is shared equally among process units, none of which have equipment subject to subpart VVa of this part, the storage vessel is assigned to any process unit subject to this subpart. If the predominant use of the storage vessel varies from year to year, then the owner or operator must estimate the predominant use initially and reassess every 3 years. The owner or operator must keep records of the information and supporting calculations that show how predominant use is determined. All equipment on the storage vessel must be monitored when in VOC service. [Reg.19.304 and 40 C.F.R. § 60.482-1(g)]

Standards: Pumps in light liquid service

OSP 18. For pumps in light liquid service, the permittee shall:

- a. Monitor monthly to detect leaks by the methods specified in § 60.485(b), except as provided in § 60.482-1(c) and (f) and paragraphs (d), (e), and (f) of this section. A pump that begins operation in light liquid service after the initial startup date for the process unit must be monitored for the first time within 30 days after the end of its startup period, except for a pump that replaces a leaking pump and except as provided in § 60.482-1(c) and (f) and paragraphs (d), (e), and (f) of this section. [Reg.19.304 and 40 C.F.R. § 60.482-2 (a)(1)]
- b. Check by visual inspection each calendar week for indications of liquids dripping from the pump seal, except as provided in § 60.482-1(f). [Reg.19.304 and 40 C.F.R. § 60.482-2 (a)(2)]
- c. If an instrument reading of 10,000 ppm or greater is measured, a leak is detected. [Reg.19.304 and 40 C.F.R. § 60.482-2(b)(1)]
- d. If there are indications of liquids dripping from the pump seal, the owner or operator shall follow the procedure specified in either paragraph (b)(2)(i) or (ii) of this section. This requirement does not apply to a pump that was monitored after a previous weekly inspection if the instrument reading for that monitoring event was less than 10,000 ppm and the pump was not repaired since that monitoring event. [Reg.19.304 and 40 C.F.R. § 60.482-2(b)(2)(i and ii)]
 - i. Monitor the pump within 5 days as specified in § 60.485(b). If an instrument reading of 10,000 ppm or greater is measured, a leak is detected. The leak shall be repaired using the procedures in paragraph (c) of this section.
 - ii. Designate the visual indications of liquids dripping as a leak, and repair the leak within 15 days of detection by eliminating the visual indications of liquids dripping.
- e. When a leak is detected, it shall be repaired as soon as practicable, but not later than 15 calendar days after it is detected, except as provided in § 60.482-9. [Reg.19.304 and 40 C.F.R. § 60.482-2(c)(1)]

- f. A first attempt at repair shall be made no later than 5 calendar days after each leak is detected. First attempts at repair include, but are not limited to, the practices described in paragraphs (c)(2)(i) and (ii) of this section, where practicable. [Reg.19.304 and 40 C.F.R. § 60.482-2(c)(2)(i and ii)]
- i. Tightening the packing gland nuts;
 - ii. Ensuring that the seal flush is operating at design pressure and temperature.
- g. Each pump equipped with a dual mechanical seal system that includes a barrier fluid system is exempt from the requirements of paragraph (a) of this section, provided the requirements specified in paragraphs (d)(1) through (6) of this section are met. [Reg.19.304 and 40 C.F.R. § 60.482-2(d)(1)-(6)]
- i. Each dual mechanical seal system is—
 - 1. Operated with the barrier fluid at a pressure that is at all times greater than the pump stuffing box pressure; or
 - 2. Equipped with a barrier fluid degassing reservoir that is routed to a process or fuel gas system or connected by a closed vent system to a control device that complies with the requirements of § 60.482-10; or
 - 3. Equipped with a system that purges the barrier fluid into a process stream with zero VOC emissions to the atmosphere.[Reg.19.304 and 40 C.F.R. § 60.482-2(d)(1)(i-iii)]
 - ii. The barrier fluid system is in heavy liquid service or is not in VOC service. [Reg.19.304 and 40 C.F.R. § 60.482-2(d)(2)]
 - iii. Each barrier fluid system is equipped with a sensor that will detect failure of the seal system, the barrier fluid system, or both. [Reg.19.304 and 40 C.F.R. § 60.482-2(d)(3)]
 - iv. Each pump is checked by visual inspection, each calendar week, for indications of liquids dripping from the pump seals. [Reg.19.304 and 40 C.F.R. § 60.482-2(d)(4)(i)]
 - v. If there are indications of liquids dripping from the pump seal at the time of the weekly inspection, the owner or operator shall follow the procedure specified in either paragraph (d)(4)(ii)(A) or (B) of this section. [Reg.19.304 and 40 C.F.R. § 60.482-2(d)(4)(ii)(A&B)]
 - 4. Monitor the pump within 5 days as specified in § 60.485(b) to determine if there is a leak of VOC in the barrier fluid. If an instrument reading of 10,000 ppm or greater is measured, a leak is detected.
 - 5. Designate the visual indications of liquids dripping as a leak.

- vi. Each sensor as described in paragraph (d)(3) of this section is checked daily or is equipped with an audible alarm. [Reg.19.304 and 40 C.F.R. § 60.482-2(d)(5)(i)]
 - vii. The owner or operator determines, based on design considerations and operating experience, a criterion that indicates failure of the seal system, the barrier fluid system, or both. [Reg.19.304 and 40 C.F.R. § 60.482-2(d)(5)(ii)]
 - viii. If the sensor indicates failure of the seal system, the barrier fluid system, or both, based on the criterion established in paragraph (d)(5)(ii) of this section, a leak is detected. [Reg.19.304 and 40 C.F.R. § 60.482-2(d)(5)(iii)]
 - ix. When a leak is detected pursuant to paragraph (d)(4)(ii)(A) of this section, it shall be repaired as specified in paragraph (c) of this section. [Reg.19.304 and 40 C.F.R. § 60.482-2(d)(6)(i)]
 - x. A leak detected pursuant to paragraph (d)(5)(iii) of this section shall be repaired within 15 days of detection by eliminating the conditions that activated the sensor. [Reg.19.304 and 40 C.F.R. § 60.482-2(d)(6)(ii)]
 - xi. A designated leak pursuant to paragraph (d)(4)(ii)(B) of this section shall be repaired within 15 days of detection by eliminating visual indications of liquids dripping. [Reg.19.304 and 40 C.F.R. § 60.482-2(d)(6)(iii)]
- h. Any pump that is designated, as described in § 60.486(e)(1) and (2), for no detectable emissions, as indicated by an instrument reading of less than 500 ppm above background, is exempt from the requirements of paragraphs (a), (c), and (d) of this section if the pump:
- i. Has no externally actuated shaft penetrating the pump housing,
 - ii. Is demonstrated to be operating with no detectable emissions as indicated by an instrument reading of less than 500 ppm above background as measured by the methods specified in § 60.485(c), and
 - iii. Is tested for compliance with paragraph (e)(2) of this section initially upon designation, annually, and at other times requested by the Administrator.
- [Reg.19.304 and 40 C.F.R. § 60.482-2(e)(1-3)]
- i. If any pump is equipped with a closed vent system capable of capturing and transporting any leakage from the seal or seals to a process or to a fuel gas system or to a control device that complies with the requirements of § 60.482-10, it is exempt from paragraphs (a) through (e) of this section. [Reg.19.304 and 40 C.F.R. § 60.482-2(f)]
 - j. Any pump that is designated, as described in § 60.486(f)(1), as an unsafe-to-monitor pump is exempt from the monitoring and inspection requirements of paragraphs (a) and (d)(4) through (6) of this section if:

- i. The owner or operator of the pump demonstrates that the pump is unsafe-to-monitor because monitoring personnel would be exposed to an immediate danger as a consequence of complying with paragraph (a) of this section; and
- ii. The owner or operator of the pump has a written plan that requires monitoring of the pump as frequently as practicable during safe-to-monitor times but not more frequently than the periodic monitoring schedule otherwise applicable, and repair of the equipment according to the procedures in paragraph (c) of this section if a leak is detected.
[Reg.19.304 and 40 C.F.R. § 60.482-2(g)(1&2)]
- k. Any pump that is located within the boundary of an unmanned plant site is exempt from the weekly visual inspection requirement of paragraphs (a)(2) and (d)(4) of this section, and the daily requirements of paragraph (d)(5) of this section, provided that each pump is visually inspected as often as practicable and at least monthly. [Reg.19.304 and 40 C.F.R. § 60.482-2(h)]

Standards: Sampling connection systems

OSP 19. For Sampling connection systems, the following requirements apply:

- a. Each sampling connection system shall be equipped with a closed-purge, closed-loop, or closed-vent system, except as provided in § 60.482-1(c) and paragraph (c) of this section. [Reg.19.304 and 40 C.F.R. § 60.482-5(a)]
- b. Each closed-purge, closed-loop, or closed-vent system as required in paragraph (a) of this section shall comply with the requirements specified in paragraphs (b)(1) through (4) of this section. [Reg.19.304 and 40 C.F.R. § 60.482-5(b)(1-4)]
 - i. Gases displaced during filling of the sample container are not required to be collected or captured.
 - ii. Containers that are part of a closed-purge system must be covered or closed when not being filled or emptied.
 - iii. Gases remaining in the tubing or piping between the closed-purge system valve(s) and sample container valve(s) after the valves are closed and the sample container is disconnected are not required to be collected or captured.
 - iv. Each closed-purge, closed-loop, or closed-vent system shall be designed and operated to meet requirements in either paragraph (b)(4)(i), (ii), (iii), or (iv) of this section.
 - 1. Return the purged process fluid directly to the process line.
 - 2. Collect and recycle the purged process fluid to a process.
 - 3. Capture and transport all the purged process fluid to a control device that complies with the requirements of § 60.482-10.

4. Collect, store, and transport the purged process fluid to any of the following systems or facilities:
 - a. A waste management unit as defined in § 63.111, if the waste management unit is subject to and operated in compliance with the provisions of 40 CFR part 63, subpart G, applicable to Group 1 wastewater streams;
 - b. A treatment, storage, or disposal facility subject to regulation under 40 CFR part 262, 264, 265, or 266;
 - c. A facility permitted, licensed, or registered by a state to manage municipal or industrial solid waste, if the process fluids are not hazardous waste as defined in 40 CFR part 261;
 - d. A waste management unit subject to and operated in compliance with the treatment requirements of § 61.348(a), provided all waste management units that collect, store, or transport the purged process fluid to the treatment unit are subject to and operated in compliance with the management requirements of §§ 61.343 through 61.347; or
 - e. A device used to burn off-specification used oil for energy recovery in accordance with 40 CFR part 279, subpart G, provided the purged process fluid is not hazardous waste as defined in 40 CFR part 261.
- c. In situ sampling systems and sampling systems without purges are exempt from the requirements of paragraphs (a) and (b) of this section. [Reg.19.304 and 40 C.F.R. § 60.482-5(c)]

Standards: Valves in gas/vapor service and in light liquid service

- OSP 20. For Valves in gas/vapor service and in light liquid service, the following apply:
- a. Each valve shall be monitored monthly to detect leaks by the methods specified in § 60.485(b) and shall comply with paragraphs (b) through (e) of this section, except as provided in paragraphs (f), (g), and (h) of this section, § 60.482-1(c) and (f), and §§ 60.483-1 and 60.483-2. [Reg.19.304 and 40 C.F.R. § 60.482-7(a)(1)]
 - b. A valve that begins operation in gas/vapor service or light liquid service after the initial startup date for the process unit must be monitored according to paragraphs (a)(2)(i) or (ii), except for a valve that replaces a leaking valve and except as provided in paragraphs (f), (g), and (h) of this section, § 60.482-1(c), and §§ 60.483-1 and 60.483-2. [Reg.19.304 and 40 C.F.R. § 60.482-7(a)(2)(i and ii)]

- i. Monitor the valve as in paragraph (a)(1) of this section. The valve must be monitored for the first time within 30 days after the end of its startup period to ensure proper installation.
 - ii. If the valves on the process unit are monitored in accordance with § 60.483-1 or § 60.483-2, count the new valve as leaking when calculating the percentage of valves leaking as described in § 60.483-2(b)(5). If less than 2.0 percent of the valves are leaking for that process unit, the valve must be monitored for the first time during the next scheduled monitoring event for existing valves in the process unit or within 90 days, whichever comes first.
- c. If an instrument reading of 10,000 ppm or greater is measured, a leak is detected. [Reg.19.304 and 40 C.F.R. § 60.482-7(b)]
 - d. Any valve for which a leak is not detected for 2 successive months may be monitored the first month of every quarter, beginning with the next quarter, until a leak is detected. As an alternative to monitoring all of the valves in the first month of a quarter, an owner or operator may elect to subdivide the process unit into 2 or 3 subgroups of valves and monitor each subgroup in a different month during the quarter, provided each subgroup is monitored every 3 months. The owner or operator must keep records of the valves assigned to each subgroup. [Reg.19.304 and 40 C.F.R. § 60.482-7(c)(1)(i and ii)]
 - e. If a leak is detected, the valve shall be monitored monthly until a leak is not detected for 2 successive months. [Reg.19.304 and 40 C.F.R. § 60.482-7(c)(2)]
 - f. When a leak is detected, it shall be repaired as soon as practicable, but no later than 15 calendar days after the leak is detected, except as provided in § 60.482-9. [Reg.19.304 and 40 C.F.R. § 60.482-7(d)(1)]
 - g. A first attempt at repair shall be made no later than 5 calendar days after each leak is detected. [Reg.19.304 and 40 C.F.R. § 60.482-7(d)(2)]
 - h. First attempts at repair include, but are not limited to, the following best practices where practicable:
 - i. Tightening of bonnet bolts;
 - ii. Replacement of bonnet bolts;
 - iii. Tightening of packing gland nuts;
 - iv. Injection of lubricant into lubricated packing.
[Reg.19.304 and 40 C.F.R. § 60.482-7(e)(1-4)]
 - i. Any valve that is designated, as described in § 60.486(e)(2), for no detectable emissions, as indicated by an instrument reading of less than 500 ppm above background, is exempt from the requirements of paragraph (a) if the valve:
 - i. Has no external actuating mechanism in contact with the process fluid,

- ii. Is operated with emissions less than 500 ppm above background as determined by the method specified in § 60.485(c), and
- iii. Is tested for compliance with paragraph (f)(2) of this section initially upon designation, annually, and at other times requested by the Administrator.
[Reg.19.304 and 40 C.F.R. § 60.482-7(f)]
- j. Any valve that is designated, as described in § 60.486(f)(1), as an unsafe-to-monitor valve is exempt from the requirements of paragraph (a) if:
 - i. The owner or operator of the valve demonstrates that the valve is unsafe to monitor because monitoring personnel would be exposed to an immediate danger as a consequence of complying with paragraph (a), and
 - ii. The owner or operator of the valve adheres to a written plan that requires monitoring of the valve as frequently as practicable during safe-to-monitor times.
[Reg.19.304 and 40 C.F.R. § 60.482-7(g)(1 and 2)]
- k. Any valve that is designated, as described in § 60.486(f)(2), as a difficult-to-monitor valve is exempt from the requirements of paragraph (a) if:
 - i. The owner or operator of the valve demonstrates that the valve cannot be monitored without elevating the monitoring personnel more than 2 meters above a support surface.
 - ii. The process unit within which the valve is located either becomes an affected facility through § 60.14 or § 60.15 or the owner or operator designates less than 3.0 percent of the total number of valves as difficult-to-monitor, and
 - iii. The owner or operator of the valve follows a written plan that requires monitoring of the valve at least once per calendar year.
[Reg.19.304 and 40 C.F.R. § 60.482-7(g)(1-3)]

Standards: Pumps and valves in heavy liquid service, pressure relief devices in light liquid or heavy liquid service, and connectors

OSP 21. For Pumps and valves in heavy liquid service, pressure relief devices in light liquid or heavy liquid service, and connectors, the following apply:

- a. If evidence of a potential leak is found by visual, audible, olfactory, or any other detection method at pumps and valves in heavy liquid service, pressure relief devices in light liquid or heavy liquid service, and connectors, the owner or operator shall follow either one of the following procedures:
 - i. The owner or operator shall monitor the equipment within 5 days by the method specified in § 60.485(b) and shall comply with the requirements of paragraphs (b) through (d) of this section.

- ii. The owner or operator shall eliminate the visual, audible, olfactory, or other indication of a potential leak within 5 calendar days of detection. [Reg.19.304 and 40 C.F.R. § 60.482-8(a)(1&2)]
- b. If an instrument reading of 10,000 ppm or greater is measured, a leak is detected. [Reg.19.304 and 40 C.F.R. § 60.482-8(b)]
- c. When a leak is detected, it shall be repaired as soon as practicable, but not later than 15 calendar days after it is detected, except as provided in § 60.482-9. [Reg.19.304 and 40 C.F.R. § 60.482-8(c)(1)]
- d. The first attempt at repair shall be made no later than 5 calendar days after each leak is detected. [Reg.19.304 and 40 C.F.R. § 60.482-8(c)(2)]
- e. First attempts at repair include, but are not limited to, the best practices described under §§ 60.482-2(c)(2) and 60.482-7(e). [Reg.19.304 and 40 C.F.R. § 60.482-8(d)]

Standards: Delay of repair

OSP 22. For leaks detected, the following are requirements for delay of repair:

- a. Delay of repair of equipment for which leaks have been detected will be allowed if repair within 15 days is technically infeasible without a process unit shutdown. Repair of this equipment shall occur before the end of the next process unit shutdown. Monitoring to verify repair must occur within 15 days after startup of the process unit. [Reg.19.304 and 40 C.F.R. § 60.482-9(a)]
 - b. Delay of repair of equipment will be allowed for equipment which is isolated from the process and which does not remain in VOC service. [Reg.19.304 and 40 C.F.R. § 60.482-9(b)]
- c. Delay of repair for valves will be allowed if:
 - i. The owner or operator demonstrates that emissions of purged material resulting from immediate repair are greater than the fugitive emissions likely to result from delay of repair, and
 - ii. When repair procedures are effected, the purged material is collected and destroyed or recovered in a control device complying with § 60.482-10. [Reg.19.304 and 40 C.F.R. § 60.482-9(c)(1 and 2)]
- d. Delay of repair for pumps will be allowed if:
 - i. Repair requires the use of a dual mechanical seal system that includes a barrier fluid system, and
 - ii. Repair is completed as soon as practicable, but not later than 6 months after the leak was detected. [Reg.19.304 and 40 C.F.R. § 60.482-9(d)(1 and 2)]
- e. Delay of repair beyond a process unit shutdown will be allowed for a valve, if valve assembly replacement is necessary during the process unit shutdown, valve assembly supplies have been depleted, and valve assembly supplies had been sufficiently stocked

before the supplies were depleted. Delay of repair beyond the next process unit shutdown will not be allowed unless the next process unit shutdown occurs sooner than 6 months after the first process unit shutdown. [Reg.19.304 and 40 C.F.R. § 60.482-9(e)]

- f. When delay of repair is allowed for a leaking pump or valve that remains in service, the pump or valve may be considered to be repaired and no longer subject to delay of repair requirements if two consecutive monthly monitoring instrument readings are below the leak definition. [Reg.19.304 and 40 C.F.R. § 60.482-9(f)]

Standards: Closed vent systems and control devices

OSP 23. The permittee shall comply with the following standards for closed vent systems and control devices subject to this subpart:

- a. Owners or operators of closed vent systems and control devices used to comply with provisions of this subpart shall comply with the provisions of this section. [Reg.19.304 and 40 C.F.R. § 60.482-10(a)]
- b. Vapor recovery systems (for example, condensers and absorbers) shall be designed and operated to recover the VOC emissions vented to them with an efficiency of 95 percent or greater, or to an exit concentration of 20 parts per million by volume, whichever is less stringent. [Reg.19.304 and 40 C.F.R. § 60.482-10(b)]
- c. Enclosed combustion devices shall be designed and operated to reduce the VOC emissions vented to them with an efficiency of 95 percent or greater, or to an exit concentration of 20 parts per million by volume, on a dry basis, corrected to 3 percent oxygen, whichever is less stringent or to provide a minimum residence time of 0.75 seconds at a minimum temperature of 816 °C. [Reg.19.304 and 40 C.F.R. § 60.482-10(c)]
- d. Flares used to comply with this subpart shall comply with the requirements of § 60.18. [Reg.19.304 and 40 C.F.R. § 60.482-10(d)]
- e. Owners or operators of control devices used to comply with the provisions of this subpart shall monitor these control devices to ensure that they are operated and maintained in conformance with their designs. [Reg.19.304 and 40 C.F.R. § 60.482-10(e)]
- f. Except as provided in paragraphs (i) through (k) of this section, each closed vent system shall be inspected according to the procedures and schedule specified in paragraphs (f)(1) and (f)(2) of this section.
 - i. If the vapor collection system or closed vent system is constructed of hard-piping, the owner or operator shall comply with the requirements specified in paragraphs (f)(1)(i) and (f)(1)(ii) of this section:
 - 6. Conduct an initial inspection according to the procedures in § 60.485(b); and
 - 7. Conduct annual visual inspections for visible, audible, or olfactory indications of leaks.
 - ii. If the vapor collection system or closed vent system is constructed of ductwork, the owner or operator shall:

8. Conduct an initial inspection according to the procedures in § 60.485(b); and
9. Conduct annual inspections according to the procedures in § 60.485(b).

[Reg.19.304 and 40 C.F.R. § 60.482-10(f)(1&2)]

- g. Leaks, as indicated by an instrument reading greater than 500 parts per million by volume above background or by visual inspections, shall be repaired as soon as practicable except as provided in paragraph (h) of this section.
 - i. A first attempt at repair shall be made no later than 5 calendar days after the leak is detected.
 - ii. Repair shall be completed no later than 15 calendar days after the leak is detected.

[Reg.19.304 and 40 C.F.R. § 60.482-10(g)(1&2)]

- h. Delay of repair of a closed vent system for which leaks have been detected is allowed if the repair is technically infeasible without a process unit shutdown or if the owner or operator determines that emissions resulting from immediate repair would be greater than the fugitive emissions likely to result from delay of repair. Repair of such equipment shall be complete by the end of the next process unit shutdown. [Reg.19.304 and 40 C.F.R. § 60.482-10(h)]
- i. If a vapor collection system or closed vent system is operated under a vacuum, it is exempt from the inspection requirements of paragraphs (f)(1)(i) and (f)(2) of this section. [Reg.19.304 and 40 C.F.R. § 60.482-10(i)]
- j. Any parts of the closed vent system that are designated, as described in paragraph (l)(1) of this section, as unsafe to inspect are exempt from the inspection requirements of paragraphs (f)(1)(i) and (f)(2) of this section if they comply with the requirements specified in paragraphs (j)(1) and (j)(2) of this section:
 - i. The owner or operator determines that the equipment is unsafe to inspect because inspecting personnel would be exposed to an imminent or potential danger as a consequence of complying with paragraphs (f)(1)(i) or (f)(2) of this section; and
 - ii. The owner or operator has a written plan that requires inspection of the equipment as frequently as practicable during safe-to-inspect times.

[Reg.19.304 and 40 C.F.R. § 60.482-10(j)(1&2)]

- k. Any parts of the closed vent system that are designated, as described in paragraph (l)(2) of this section, as difficult to inspect are exempt from the inspection requirements of paragraphs (f)(1)(i) and (f)(2) of this section if they comply with the requirements specified in paragraphs (k)(1) through (k)(3) of this section:

- i. The owner or operator determines that the equipment cannot be inspected without elevating the inspecting personnel more than 2 meters above a support surface; and
- ii. The process unit within which the closed vent system is located becomes an affected facility through §§ 60.14 or 60.15, or the owner or operator designates less than 3.0 percent of the total number of closed vent system equipment as difficult to inspect; and
- iii. The owner or operator has a written plan that requires inspection of the equipment at least once every 5 years. A closed vent system is exempt from inspection if it is operated under a vacuum.

[Reg.19.304 and 40 C.F.R. § 60.482-10(k)(1-3)]

1. The owner or operator shall record the information specified in paragraphs (l)(1) through (l)(5) of this section.
 - i. Identification of all parts of the closed vent system that are designated as unsafe to inspect, an explanation of why the equipment is unsafe to inspect, and the plan for inspecting the equipment.
 - ii. Identification of all parts of the closed vent system that are designated as difficult to inspect, an explanation of why the equipment is difficult to inspect, and the plan for inspecting the equipment.
 - iii. For each inspection during which a leak is detected, a record of the information specified in § 60.486(c).
 - iv. For each inspection conducted in accordance with § 60.485(b) during which no leaks are detected, a record that the inspection was performed, the date of the inspection, and a statement that no leaks were detected.
 - v. For each visual inspection conducted in accordance with paragraph (f)(1)(ii) of this section during which no leaks are detected, a record that the inspection was performed, the date of the inspection, and a statement that no leaks were detected.

[Reg.19.304 and 40 C.F.R. § 60.482-10(l)(1-5)]

- m. Closed vent systems and control devices used to comply with provisions of this subpart shall be operated at all times when emissions may be vented to them. [Reg.19.304 and 40 C.F.R. § 60.482-10(m)]

Alternative standards for valves—allowable percentage of valves leaking

- OSP 24. The permittee may comply with the following alternative standards for leaking valves:
- a. An owner or operator may elect to comply with an allowable percentage of valves leaking of equal to or less than 2.0 percent. [Reg.19.304 and 40 C.F.R. § 60.483-1(a)]
 - b. The following requirements shall be met if an owner or operator wishes to comply with an allowable percentage of valves leaking:

- i. An owner or operator must notify the Administrator that the owner or operator has elected to comply with the allowable percentage of valves leaking before implementing this alternative standard, as specified in § 60.487(d).
- ii. A performance test as specified in paragraph (c) of this section shall be conducted initially upon designation, annually, and at other times requested by the Administrator.
- iii. If a valve leak is detected, it shall be repaired in accordance with § 60.482-7(d) and (e).

[Reg.19.304 and 40 C.F.R. § 60.483-1(b)(1-3)]

c. Performance tests shall be conducted in the following manner:

- i. All valves in gas/vapor and light liquid service within the affected facility shall be monitored within 1 week by the methods specified in § 60.485(b).
- ii. If an instrument reading of 10,000 ppm or greater is measured, a leak is detected.
- iii. The leak percentage shall be determined by dividing the number of valves for which leaks are detected by the number of valves in gas/vapor and light liquid service within the affected facility.

[Reg.19.304 and 40 C.F.R. § 60.483-1(c)(1-3)]

d. Owners and operators who elect to comply with this alternative standard shall not have an affected facility with a leak percentage greater than 2.0 percent, determined as described in § 60.485(h).

[Reg.19.304 and 40 C.F.R. § 60.483-1(d)]

Alternative standards for valves—skip period leak detection and repair

OSP 25. The following requirements apply as alternative standards for valves—skip period leak detection and repair:

- a. An owner or operator may elect to comply with one of the alternative work practices specified in paragraphs (b)(2) and (3) of this section. [Reg.19.304 and 40 C.F.R. § 60.483-2(a)(1)]
- b. An owner or operator must notify the Administrator before implementing one of the alternative work practices, as specified in § 60.487(d). [Reg.19.304 and 40 C.F.R. § 60.483-2(a)(2)]
- c. An owner or operator shall:
 - i. Comply initially with the requirements for valves in gas/vapor service and valves in light liquid service, as described in § 60.482-7.
 - ii. After 2 consecutive quarterly leak detection periods with the percent of valves leaking equal to or less than 2.0, an owner or operator may begin

- to skip 1 of the quarterly leak detection periods for the valves in gas/vapor and light liquid service.
- iii. After 5 consecutive quarterly leak detection periods with the percent of valves leaking equal to or less than 2.0, an owner or operator may begin to skip 3 of the quarterly leak detection periods for the valves in gas/vapor and light liquid service.
 - iv. If the percent of valves leaking is greater than 2.0, the owner or operator shall comply with the requirements as described in § 60.482-7 but can again elect to use this section.
 - v. The percent of valves leaking shall be determined as described in § 60.485(h).
 - vi. An owner or operator must keep a record of the percent of valves found leaking during each leak detection period.
 - vii. A valve that begins operation in gas/vapor service or light liquid service after the initial startup date for a process unit following one of the alternative standards in this section must be monitored in accordance with § 60.482-7(a)(2)(i) or (ii) before the provisions of this section can be applied to that valve.

[Reg.19.304 and 40 C.F.R. § 60.483-2(b)(1-7)]

Equivalence of means of emission limitation

OSP 26. Each owner or operator subject to the provisions of this subpart may apply to the Administrator for determination of equivalence for any means of emission limitation that achieves a reduction in emissions of VOC at least equivalent to the reduction in emissions of VOC achieved by the controls required in this subpart. The requirements for such a request and determination of equivalence are detailed within (b) through (f) of this section.
[Reg.19.304 and 40 C.F.R. § 60.484(a-f)]

Test methods and procedures

- OSP 27. The permittee shall conduct performance testing in accordance with the provisions of this section.
- a. In conducting the performance tests required in § 60.8, the owner or operator shall use as reference methods and procedures the test methods in appendix A of this part or other methods and procedures as specified in this section, except as provided in § 60.8(b).
[Reg.19.304 and 40 C.F.R. § 60.485(a)]
 - b. The owner or operator shall determine compliance with the standards in §§ 60.482-1 through 60.482-10, 60.483, and 60.484 as follows:
 - i. Method 21 shall be used to determine the presence of leaking sources. The instrument shall be calibrated before use each day of its use by the procedures specified in Method 21. The following calibration gases shall be used:

1. Zero air (less than 10 ppm of hydrocarbon in air); and
2. A mixture of methane or n-hexane and air at a concentration of about, but less than, 10,000 ppm methane or n-hexane.

[Reg.19.304 and 40 C.F.R. § 60.485(b) (1)(i&ii)]

- c. The owner or operator shall determine compliance with the no detectable emission standards in §§ 60.482-2(e), 60.482-3(i), 60.482-4, 60.482-7(f), and 60.482-10(e) as follows:
- i. The requirements of paragraph (b) shall apply.
 - ii. Method 21 shall be used to determine the background level. All potential leak interfaces shall be traversed as close to the interface as possible. The arithmetic difference between the maximum concentration indicated by the instrument and the background level is compared with 500 ppm for determining compliance.

[Reg.19.304 and 40 C.F.R. § 60.485(c)]

- d. The owner or operator shall test each piece of equipment unless he demonstrates that a process unit is not in VOC service, i.e., that the VOC content would never be reasonably expected to exceed 10 percent by weight. For purposes of this demonstration, the following methods and procedures shall be used:
- i. Procedures that conform to the general methods in ASTM E260-73, 91, or 96, E168-67, 77, or 92, E169-63, 77, or 93 (incorporated by reference—see § 60.17) shall be used to determine the percent VOC content in the process fluid that is contained in or contacts a piece of equipment.
 - ii. Organic compounds that are considered by the Administrator to have negligible photochemical reactivity may be excluded from the total quantity of organic compounds in determining the VOC content of the process fluid.
 - iii. Engineering judgment may be used to estimate the VOC content, if a piece of equipment had not been shown previously to be in service. If the Administrator disagrees with the judgment, paragraphs (d) (1) and (2) of this section shall be used to resolve the disagreement.

[Reg.19.304 and 40 C.F.R. § 60.485(d)]

- e. The owner or operator shall demonstrate that a piece of equipment is in light liquid service by showing that all the following conditions apply:
- i. The vapor pressure of one or more of the organic components is greater than 0.3 kPa at 20 °C (1.2 in. H₂ O at 68 °F). Standard reference texts or ASTM D2879-83, 96, or 97 (incorporated by reference—see § 60.17) shall be used to determine the vapor pressures.

- ii. The total concentration of the pure organic components having a vapor pressure greater than 0.3 kPa at 20 °C (1.2 in. H₂ O at 68 °F) is equal to or greater than 20 percent by weight.
- iii. The fluid is a liquid at operating conditions.

[Reg.19.304 and 40 C.F.R. § 60.485(e)]

- f. Samples used in conjunction with paragraphs (d), (e), and (g) of this section shall be representative of the process fluid that is contained in or contacts the equipment or the gas being combusted in the flare. [Reg.19.304 and 40 C.F.R. § 60.485(f)]
- g. The owner or operator shall determine compliance with the standards of flares as follows:
 - i. Method 22 shall be used to determine visible emissions.
 - ii. A thermocouple or any other equivalent device shall be used to monitor the presence of a pilot flame in the flare.
 - iii. The maximum permitted velocity for air assisted flares shall be computed using the following equation:

$$V_{\max} = K_1 + K_2 H_T$$

Where:

V_{\max} = Maximum permitted velocity, m/sec (ft/sec)

H_T = Net heating value of the gas being combusted, MJ/scm (Btu/scf).

K_1 = 8.706 m/sec (metric units)

= 28.56 ft/sec (English units)

K_2 = 0.7084 m⁴/(MJ-sec) (metric units)

= 0.087 ft⁴/(Btu-sec) (English units)

- iv. (4) The net heating value (H_T) of the gas being combusted in a flare shall be computed using the following equation:

$$H_T = K \sum_{i=1}^n C_i H_i$$

Where:

K = Conversion constant, 1.740×10^{-7} (g-mole)(MJ)/(ppm-scm-kcal) (metric units) = 4.674×10^{-6} [(g-mole)(Btu)/(ppm-scf-kcal)] (English units)

C_i = Concentration of sample component “i,” ppm

H_i = Net heat of combustion of sample component “i” at 25 °C and 760 mm Hg (77 °F and 14.7 psi), kcal/g-mole

- v. Method 18 or ASTM D6420-99 (2004) (where the target compound(s) are those listed in Section 1.1 of ASTM D6420-99, and the target concentration is between 150 parts per billion by volume and 100 parts

per million by volume) and ASTM D2504-67, 77 or 88 (Reapproved 1993) (incorporated by reference—see § 60.17) shall be used to determine the concentration of sample component “i.”

- vi. ASTM D2382-76 or 88 or D4809-95 (incorporated by reference—see § 60.17) shall be used to determine the net heat of combustion of component “i” if published values are not available or cannot be calculated.
- vii. Method 2, 2A, 2C, or 2D, as appropriate, shall be used to determine the actual exit velocity of a flare. If needed, the unobstructed (free) cross-sectional area of the flare tip shall be used.

[Reg.19.304 and 40 C.F.R. § 60.485(g)(1-7)]

- h. The owner or operator shall determine compliance with § 60.483-1 or § 60.483-2 as follows:

- i. The percent of valves leaking shall be determined using the following equation:

$$\%V_L = (V_L / V_T) * 100$$

Where:

$\%V_L$ = Percent leaking valves

V_L = Number of valves found leaking

V_T = The sum of the total number of valves monitored

- ii. The total number of valves monitored shall include difficult-to-monitor and unsafe-to-monitor valves only during the monitoring period in which those valves are monitored.
- iii. The number of valves leaking shall include valves for which repair has been delayed.
- iv. Any new valve that is not monitored within 30 days of being placed in service shall be included in the number of valves leaking and the total number of valves monitored for the monitoring period in which the valve is placed in service.
- v. If the process unit has been subdivided in accordance with § 60.482-7(c)(1)(ii), the sum of valves found leaking during a monitoring period includes all subgroups.
- vi. The total number of valves monitored does not include a valve monitored to verify repair.

[Reg.19.304 and 40 C.F.R. § 60.485(h)(1-6)]

Recordkeeping requirements

OSP 28. The permittee shall show compliance with the recordkeeping requirements of this subpart. [Reg.19.304 and 40 C.F.R. § 60.486]

- a. An owner or operator of more than one affected facility subject to the provisions of this subpart may comply with the recordkeeping requirements for these facilities in one recordkeeping system if the system identifies each record by each facility. [Reg.19.304 and 40 C.F.R. § 60.486(a)(2)]
- b. When each leak is detected as specified in §§ 60.482-2, 60.482-3, 60.482-7, 60.482-8, and 60.483-2, the following requirements apply:
 - i. A weatherproof and readily visible identification, marked with the equipment identification number, shall be attached to the leaking equipment.
 - ii. The identification on a valve may be removed after it has been monitored for 2 successive months as specified in § 60.482-7(c) and no leak has been detected during those 2 months.
 - iii. The identification on equipment except on a valve, may be removed after it has been repaired.

[Reg.19.304 and 40 C.F.R. § 60.486(b)(1-3)]

- c. When each leak is detected as specified in §§ 60.482-2, 60.482-3, 60.482-7, 60.482-8, and 60.483-2, the following information shall be recorded in a log and shall be kept for 2 years in a readily accessible location:
 - i. The instrument and operator identification numbers and the equipment identification number.
 - ii. The date the leak was detected and the dates of each attempt to repair the leak.
 - iii. Repair methods applied in each attempt to repair the leak.
 - iv. “Above 10,000” if the maximum instrument reading measured by the methods specified in § 60.485(a) after each repair attempt is equal to or greater than 10,000 ppm.
 - v. “Repair delayed” and the reason for the delay if a leak is not repaired within 15 calendar days after discovery of the leak.
 - vi. The signature of the owner or operator (or designate) whose decision it was that repair could not be effected without a process shutdown.
 - vii. The expected date of successful repair of the leak if a leak is not repaired within 15 days.
 - viii. Dates of process unit shutdowns that occur while the equipment is unrepaired.
 - ix. The date of successful repair of the leak.

[Reg.19.304 and 40 C.F.R. § 60.486(c)(1-9)]

- d. The following information pertaining to the design requirements for closed vent systems and control devices described in § 60.482-10 shall be recorded and kept in a readily accessible location:
- i. Detailed schematics, design specifications, and piping and instrumentation diagrams.
 - ii. The dates and descriptions of any changes in the design specifications.
 - iii. A description of the parameter or parameters monitored, as required in § 60.482-10(e), to ensure that control devices are operated and maintained in conformance with their design and an explanation of why that parameter (or parameters) was selected for the monitoring.
 - iv. Periods when the closed vent systems and control devices required in §§ 60.482-2, 60.482-3, 60.482-4, and 60.482-5 are not operated as designed, including periods when a flare pilot light does not have a flame.
 - v. Dates of startups and shutdowns of the closed vent systems and control devices required in §§ 60.482-2, 60.482-3, 60.482-4, and 60.482-5.

[Reg.19.304 and 40 C.F.R. § 60.486(d)(1-5)]

- e. The following information pertaining to all equipment subject to the requirements in §§ 60.482-1 to 60.482-10 shall be recorded in a log that is kept in a readily accessible location:
- i. A list of identification numbers for equipment subject to the requirements of this subpart.
 - ii. A list of identification numbers for equipment that are designated for no detectable emissions under the provisions of §§ 60.482-2(e), 60.482-3(i) and 60.482-7(f).
 - iii. The designation of equipment as subject to the requirements of § 60.482-2(e), § 60.482-3(i), or § 60.482-7(f) shall be signed by the owner or operator. Alternatively, the owner or operator may establish a mechanism with their permitting authority that satisfies this requirement.
 - iv. A list of equipment identification numbers for pressure relief devices required to comply with § 60.482-4.
 - v. The dates of each compliance test as required in §§ 60.482-2(e), 60.482-3(i), 60.482-4, and 60.482-7(f).
 1. The background level measured during each compliance test.
 2. The maximum instrument reading measured at the equipment during each compliance test.
 - vi. A list of identification numbers for equipment in vacuum service.

- vii. A list of identification numbers for equipment that the owner or operator designates as operating in VOC service less than 300 hr/yr in accordance with § 60.482-1(e), a description of the conditions under which the equipment is in VOC service, and rationale supporting the designation that it is in VOC service less than 300 hr/yr.

[Reg.19.304 and 40 C.F.R. § 60.486(d)(1-7)]

- f. The following information pertaining to all valves subject to the requirements of § 60.482-7(g) and (h) and to all pumps subject to the requirements of § 60.482-2(g) shall be recorded in a log that is kept in a readily accessible location:
 - i. A list of identification numbers for valves and pumps that are designated as unsafe-to-monitor, an explanation for each valve or pump stating why the valve or pump is unsafe-to-monitor, and the plan for monitoring each valve or pump.
 - ii. A list of identification numbers for valves that are designated as difficult-to-monitor, an explanation for each valve stating why the valve is difficult-to-monitor, and the schedule for monitoring each valve.

[Reg.19.304 and 40 C.F.R. § 60.486(f)(1&2)]

- g. The following information shall be recorded for valves complying with § 60.483-2:
 - i. A schedule of monitoring.
 - ii. The percent of valves found leaking during each monitoring period.

[Reg.19.304 and 40 C.F.R. § 60.486(g)(1&2)]

- h. The following information shall be recorded in a log that is kept in a readily accessible location:
 - i. Design criterion required in §§ 60.482-2(d)(5) and 60.482-3(e)(2) and explanation of the design criterion; and
 - ii. Any changes to this criterion and the reasons for the changes.

[Reg.19.304 and 40 C.F.R. § 60.486(h)(1&2)]

- i. The following information shall be recorded in a log that is kept in a readily accessible location for use in determining exemptions as provided in § 60.480(d):
 - i. An analysis demonstrating the design capacity of the affected facility,
 - ii. A statement listing the feed or raw materials and products from the affected facilities and an analysis demonstrating whether these chemicals are heavy liquids or beverage alcohol, and
 - iii. An analysis demonstrating that equipment is not in VOC service.

[Reg.19.304 and 40 C.F.R. § 60.486(i)(1-3)]

- j. Information and data used to demonstrate that a piece of equipment is not in VOC service shall be recorded in a log that is kept in a readily accessible location. [[Reg.19.304 and 40

C.F.R. § 60.486(j)]

- k. The provisions of § 60.7 (b) and (d) do not apply to affected facilities subject to this subpart. [Reg.19.304 and 40 C.F.R. § 60.486(k)]

Reporting requirements

OSP 29. The permittee shall comply with the reporting requirements of this section.
[Reg.19.304 and 40 C.F.R. § 60.487]

- a. Each owner or operator subject to the provisions of this subpart shall submit semiannual reports to the Administrator beginning six months after the initial startup date. [Reg.19.304 and 40 C.F.R. § 60.487(a)]
- b. The initial semiannual report to the Administrator shall include the following information:
 - i. Process unit identification.
 - ii. Number of valves subject to the requirements of § 60.482-7, excluding those valves designated for no detectable emissions under the provisions of § 60.482-7(f).
 - iii. Number of pumps subject to the requirements of § 60.482-2, excluding those pumps designated for no detectable emissions under the provisions of § 60.482-2(e) and those pumps complying with § 60.482-2(f).
 - iv. Number of compressors subject to the requirements of § 60.482-3, excluding those compressors designated for no detectable emissions under the provisions of § 60.482-3(i) and those compressors complying with § 60.482-3(h).

[Reg.19.304 and 40 C.F.R. § 60.487(b)(1-4)]

- c. All semiannual reports to the Administrator shall include the following information, summarized from the information in § 60.486:
 - i. Process unit identification.
 - ii. For each month during the semiannual reporting period,
 - 1. Number of valves for which leaks were detected as described in § 60.482-7(b) or § 60.483-2,
 - 2. Number of valves for which leaks were not repaired as required in § 60.482-7(d)(1),
 - 3. Number of pumps for which leaks were detected as described in § 60.482-2(b), (d)(4)(ii)(A) or (B), or (d)(5)(iii),
 - 4. Number of pumps for which leaks were not repaired as required in § 60.482-2(c)(1) and (d)(6),
 - 5. Number of compressors for which leaks were detected as described in § 60.482-3(f),

6. Number of compressors for which leaks were not repaired as required in § 60.482-3(g)(1), and
 7. The facts that explain each delay of repair and, where appropriate, why a process unit shutdown was technically infeasible.
- iii. Dates of process unit shutdowns which occurred within the semiannual reporting period.
 - iv. Revisions to items reported according to paragraph (b) if changes have occurred since the initial report or subsequent revisions to the initial report.

[Reg.19.304 and 40 C.F.R. § 60.487(c)(1-4)]

- d. An owner or operator electing to comply with the provisions of §§ 60.483-1 or 60.483-2 shall notify the Administrator of the alternative standard selected 90 days before implementing either of the provisions. [Reg.19.304 and 40 C.F.R. § 60.487(d)]
- e. An owner or operator shall report the results of all performance tests in accordance with § 60.8 of the General Provisions. The provisions of § 60.8(d) do not apply to affected facilities subject to the provisions of this subpart except that an owner or operator must notify the Administrator of the schedule for the initial performance tests at least 30 days before the initial performance tests. [Reg.19.304 and 40 C.F.R. § 60.487(e)]
- f. The requirements of paragraphs (a) through (c) of this section remain in force until and unless EPA, in delegating enforcement authority to a State under section 111(c) of the Act, approves reporting requirements or an alternative means of compliance surveillance adopted by such State. In that event, affected sources within the State will be relieved of the obligation to comply with the requirements of paragraphs (a) through (c) of this section, provided that they comply with the requirements established by the State. [Reg.19.304 and 40 C.F.R. § 60.487(f)]

Chemical Waste Destructor **6M03-05 and DEST-FUG**

Source Description

The chemical waste destructor at FutureFuel Chemical Company is designed to burn a mixture of waste streams resulting from various fine chemical manufacturing facilities at the plant. Some of the waste is mainly organic solvents, but the majority is comprised of aqueous solutions containing some organic and salt compounds. The equipment used to burn the waste includes a burner assembly, oxidizer chamber, weir tank, quench separator tank, high-energy scrubber, vane separator, and a stack. The chemical destructor is a vertically downfired unit. Emissions were calculated for the incinerator (6M03-05) and for fugitive equipment leaks (DEST-FUG).

The chemical waste destructor is subject to 40 CFR Part 63, Subpart EEE, *National Emission Standards for Hazardous Air Pollutants from Hazardous Waste Combustors*.

Specific Conditions

- CWD 1. The permittee shall not exceed the emission rates set forth in the following table. Emission rates are based upon the maximum capacity of equipment. [Reg.19.501 *et seq.* and 40 C.F.R. § 52 Subpart E]

SN	Description	Pollutant	lb/hr
6M03-05	Chemical Waste Destructor (50 MMBtu/hr)	PM ₁₀	1.5
		SO ₂	20.4
		VOC	1.0
		CO	11.2
		NO _x	33.2
DEST-FUG	Destructor Fugitives	VOC	1.0

- CWD 2. The permittee shall not exceed the emission rates set forth in the following table. Emission rates are based upon the maximum capacity of equipment. The facility shall show compliance with the facility total ton/yr limits using the procedures outlined in PW 11 through PW 15. Hourly Plantwide Hazardous Air Pollutant emissions are limited by PW 15. Additional HAP limitations are included in PW 12. [Reg.18.801 and Ark. Code Ann. § 8-4-203 as referenced by Ark. Code Ann. §§ 8-4-304 and 8-4-311]

SN	Description	Pollutant	lb/hr
6M03-05	Chemical Waste Destructor (50 MMBtu/hr)	PM	1.5
		Inorganics*	1.4
		Organic Pollutants**	***
DEST-FUG	Destructor Fugitives	Organic Pollutants**	***

*Inorganics are considered to be non-organic Hazardous Air Pollutants
 **Organic Pollutants are considered to be VOC, all organic HAPs, and organic Air Contaminates.
 ***Hourly plantwide Hazardous Air Pollutant emissions are limited by Plantwide Condition 12.

- CWD 3. The permittee shall not exceed 20% opacity as measured by Method 9 at the chemical destructor, except during periods of startup, shutdown, and malfunction. Opacity readings will be conducted on a weekly basis. [§19.503 of Regulation 19 and 40 CFR Part 52, Subpart E]
- CWD 4. The permittee shall measure the VOC emissions at the chemical destructor every five (5) years using Method 25A. The permittee shall also determine the destruction efficiency by measuring the inlet and outlet concentrations of VOC during this test. Based on maximum rates, the destruction efficiency during testing shall be 99.99% or higher. [Reg.18.1002 and Ark. Code Ann. § 8-4-203 as referenced by Ark. Code Ann. §§ 8-4-304 and 8-4-311]
- CWD 5. The permittee shall measure the particulate emissions from the chemical destructor using Method 5, with the PM₁₀ portion using Methods 201 or 201A. The permittee shall measure the NO_x emissions using Method 7E. The permittee shall measure the SO₂ emissions using Method 6C. Testing shall commence no later than 61 months from the date of the previous test. [Reg.19.705 and 40 C.F.R. § 52 Subpart E]
- CWD 6. The permittee shall maintain a daily flowrate on scrubbers in this section in accordance with most current version of the Facility Operating Plan. [Reg.19.303 and Ark. Code Ann. § 8-4-203 as referenced by Ark. Code Ann. §§ 8-4-304 and 8-4-311]
- CWD 7. The permittee shall submit an application for air permit modification, if necessary, based upon the results of the chemical destructor trial burn. The application shall include complete test results, calculations, and emission rates for all criteria and non-criteria pollutants emitted at the chemical destructor. [Reg.19.401]
- CWD 8. The permittee shall operate all CEMS at this source in accordance with all applicable conditions of Section III – Notification and Recordkeeping of the Department’s Continuous Emission Monitoring Systems Conditions as found in Appendix A of this permit. [Reg.19.703, 40 C.F.R. § 52 Subpart E, and Ark. Code Ann. § 8-4-203 as referenced by Ark. Code Ann. §§ 8-4-304 and 8-4-311]

40 CFR Part 63 Subpart EEE - National Emission Standards for Hazardous Air Pollutants from Hazardous Waste Combustors

- CWD 9. The permittee shall maintain the operating limits as outlined in the Notification of Compliance (NOC) for the chemical destructor. The NOC is required by 40 CFR Part 63, Subpart EEE. [Reg.19.705 and 40 C.F.R. § 52 Subpart E]

Operating Parameters Limitations (OPLs)
Maximum Waste Feed Limitations

Operating Parameters Limitations (OPLs)
Waste Feed Rate (aqueous HAP + organic HAP), lb/hr Chlorine Feed Rate, lb/hr Ash Feed Rate, lb/hr Total Mercury Feed Rate, lb/hr Total Semi-Volatile Metals Feed Rate, lb/hr Total Low-Volatile Metals Feed Rate, lb/hr
Combustion Chamber Limitations
Minimum Combustion Chamber Temperature, °F Minimum Atomization Pressure, psi Maximum Combustion Air Flow Rate, scfm
High Energy Scrubber Limitations
Minimum Scrubber Differential Pressure, inches water column Minimum Scrubber Water pH Minimum Scrubber Water Flow Rate (1 st and 2 nd Stages), gpm Minimum Scrubber Water Tank Level, % Minimum Scrubber Blowdown Rate, gpm
Stack Gas Limitations
Maximum Carbon Monoxide Concentration, ppmv @ 7% O ₂ Maximum Total Hydrocarbon, ppmv

CWD 10. The permittee shall maintain records of the chemical destructor operating limits as specified in the NOC. These records shall be maintained on site and available for inspection upon request. [Reg.19.705 and 40 C.F.R. § 52 Subpart E]

CWD 11. This facility is subject to 40 CFR Part 63, Subpart EEE, National Emission Standards for Hazardous Air Pollutants from Hazardous Waste Combustors. Applicable requirements include, but are not limited to, the following conditions. [Reg.19.304 and 40 C.F.R. § 63.1200 of EEE]:

Emission Limits

- a. The permittee shall not discharge or cause combustion gases to be emitted to the atmosphere that contain dioxin and furans in excess of 0.4 ng TEQ/dscm, corrected to 7 percent oxygen. [Reg.19.304 and 40 C.F.R. § 63.1219(a)(1)(A)]

- b. Emissions in excess of 0.40 ng TEQ/dscm corrected to 7 percent oxygen provided that the combustion gas temperature at the inlet to the initial particulate matter control device is 400 °F or lower based on the average of the test run average temperatures. For purposes of compliance, operation of a wet particulate control device is presumed to meet the 400 °F or lower requirement. [Reg.19.304 and 40 C.F.R. § 63.1219(a)(1)(B)]
- c. The permittee shall not discharge or cause combustion gases to be emitted to the atmosphere that contain mercury in excess of 130 µg/dscm, corrected to 7 percent oxygen. [Reg.19.304 and 40 C.F.R. § 63.1219(a)(2)]
- d. The permittee shall not discharge or cause combustion gases to be emitted to the atmosphere that contain lead and cadmium in excess of 230 µg/dscm, combined emissions, corrected to 7 percent oxygen. [Reg.19.304 and 40 C.F.R. § 63.1219(a)(3)]
- e. The permittee shall not discharge or cause combustion gases to be emitted to the atmosphere that contain arsenic, beryllium, and chromium in excess of 92µg/dscm, combined emissions, corrected to 7 percent oxygen. [Reg.19.304 and 40 C.F.R. § 63.1219(a)(4)]
- f. For carbon monoxide and hydrocarbons, either:
 - i. Carbon monoxide in excess of 100 parts per million by volume, over an hourly rolling average (monitored continuously with a continuous emissions monitoring system), dry basis and corrected to 7 percent oxygen. If you elect to comply with this carbon monoxide standard rather than the hydrocarbon standard under paragraph (a)(5)(ii) of this section, you must also document that, during the destruction and removal efficiency (DRE) test runs or their equivalent as provided by § 63.1206(b)(7), hydrocarbons do not exceed 10 parts per million by volume during those runs, over an hourly rolling average (monitored continuously with a continuous emissions monitoring system), dry basis, corrected to 7 percent oxygen, and reported as propane; or
 - ii. Hydrocarbons in excess of 10 parts per million by volume, over an hourly rolling average (monitored continuously with a continuous emissions monitoring system), dry basis, corrected to 7 percent oxygen, and reported as propane; [Reg.19.304 and 40 C.F.R. § 63.1219(a)(5)(i and ii)]
- g. Hydrogen chloride and chlorine gas (total chlorine) in excess of 32 parts per million by volume, combined emissions, expressed as a chloride (Cl⁻) equivalent, dry basis and corrected to 7 percent oxygen. [Reg.19.304 and 40 C.F.R. § 63.1219(a)(6)]
- h. Except as provided by paragraph (e) of this section, particulate matter emissions in excess of 0.013 gr/dscf corrected to 7 percent oxygen. [Reg.19.304 and 40 C.F.R. § 63.1219(a)(7)]
- i. In lieu of complying with the particulate matter standards of this section, you may elect to comply with the following alternative metal emission control requirement.

- i. You must not discharge or cause combustion gases to be emitted into the atmosphere that contain cadmium, lead, and selenium in excess of 230 $\mu\text{gm/dscm}$, combined emissions, corrected to 7 percent oxygen; and,
- ii. You must not discharge or cause combustion gases to be emitted into the atmosphere that contain antimony, arsenic, beryllium, chromium, cobalt, manganese, and nickel in excess of 92 $\mu\text{gm/dscm}$, combined emissions, corrected to 7 percent oxygen.

[Reg.19.304 and 40 C.F.R. § 63.1219(e)(1&2)]

Destruction and Removal Efficiency (DRE) Standard

- j. The permittee shall maintain a 99.99% destruction and removal efficiency (DRE) for each principal organic hazardous constituent (POHC) designated under paragraph (c)(3) of this section. The DRE shall be calculated using the following equation:

$$\text{DRE} = [1 - (\text{Win} / \text{Wout})] \times 100\%$$

Where:

Win = mass feedrate of one principal organic hazardous constituent (POHC) in a waste feed stream; and

Wout = mass emission rate of the same POHC present in exhaust emissions prior to release to the atmosphere. [Reg.19.304 and 40 C.F.R. § 63.1219(c)]

- k. The permittee must treat the POHCs in the waste feed that are specified under paragraph (c)(3)(ii) of this section to the extent required by paragraphs §63.1203(c)(1) and (c)(2) (i.e. 99.99% as stated in the previous Specific Condition). [Reg.19.304 and 40 C.F.R. § 63.1219(c)(3)(i)]
- l. The permittee shall specify one or more POHCs from the list of hazardous air pollutants established by 42 U.S.C. 7412(b)(1), excluding caprolactum as provided by §63.60, for each waste to be burned. The permittee must base this specification on the degree of difficulty of incineration of the organic constituents in the waste and on their concentration or mass in the waste feed, considering the results of waste analyses or other data and information. [Reg.19.304 and 40 C.F.R. § 63.1219(c)(3)(ii)]
- m. The emission limits provided by paragraphs §63.1203(a) and §63.1203(b) are presented with two significant figures. Although the permittee must perform intermediate calculations using at least three significant figures, the resultant emission levels may be rounded to two significant figures to document compliance. [Reg.19.304 and 40 C.F.R. § 63.1219(d)]

Compliance Provisions

- n. The permittee shall comply with the standards of 40 CFR Part 63, Subpart EEE no later than September 30, 2003 unless the Administrator grants an extension under §63.6(i) or §63.1213. [Reg.19.304 and 40 C.F.R. § 63.1206(a)(1)]

- o. The permittee shall comply with the emission standards and operating requirements set forth in 40 CFR Part 63, Subpart EEE at all times when hazardous wastes are in the combustion chamber, except as specified in §63.1206(b)(1)(i) and (ii). [Reg.19.304 and 40 C.F.R. § 63.1206(b)(1)]
- p. The permittee shall demonstrate compliance based on performance testing under operating conditions representative of the extreme range of normal conditions. This performance test shall be conducted as required by 40 CFR §63.1206(b)(12). Prior to the completion of the performance test, the permittee shall document compliance with 40 CFR Part 63, Subpart EEE no later than September 30, 2003. This documentation of compliance (DOC) will ensure that operating parameters are established to ensure compliance with this subpart. [Reg.19.304 and 40 C.F.R. § 63.1206(b)(2)]
- q. The permittee may petition the Administrator to grant an extension of compliance with the emission standards of this subpart as provided by §63.6(i) and §63.1213. [Reg.19.304 and 40 C.F.R. § 63.1206(b)(4)]
- r. The permittee shall comply with the requirements of notification, performance testing, and waste-burning restrictions as outlined in §63.1206(b)(5)(i)(A) through (C) if the facility plans to make a change in design, operation, or maintenance that could adversely affect compliance. [Reg.19.304 and 40 C.F.R. § 63.1206(b)(5)(i)]
- s. The permittee shall document any changes not affecting compliance in the facility operating record. Revisions reflecting such changes shall also be made, as necessary, to the performance test plan, Documentation of Compliance, Notification of Compliance, and the start-up, shutdown, and malfunction plan. [Reg.19.304 and 40 C.F.R. § 63.1206(b)(5)(ii)]
- t. The permittee shall ensure and document compliance with the CO emission standard using a continuous emission monitoring system (CEMS). The permittee shall ensure and document compliance with the hydrocarbon emission standard by complying with the CO emission standard, and by demonstrating that the highest hourly rolling average hydrocarbon level emitted during the comprehensive performance test does not exceed the hydrocarbon emission limit. [Reg.19.304 and 40 C.F.R. § 63.1206(b)(6)]
- u. The permittee shall demonstrate destruction removal efficiency (DRE) of at least 99.99% during the comprehensive performance test conducted in compliance with the conditions of §63.1207(b)(1) of this subpart. [Reg.19.304 and 40 C.F.R. § 63.1206(b)(7)]

- v. Any particulate matter and opacity standards or any permit or other emissions operating parameter limits or conditions, including any limitation on workplace practices, that are applicable to hazardous waste combustors to ensure compliance with any particulate matter or opacity standard of parts 60, 61, 63, 264, 265, and 266 of this chapter (i.e., any title 40 particulate or opacity standards) do not apply while the permittee conducts particulate matter continuous emissions monitoring system (CEMS) correlation tests. However, compliance with this condition is not required until such time that the Agency promulgates all performance specifications and operational requirements applicable to PM CEMS. [Reg.19.304 and 40 C.F.R. § 63.1206(b)(8)(i) and (ii)]
- w. For provisions of this section to apply, the permittee must develop a particulate matter CEMS correlation test plan that includes the following information. This test plan may be included as part of the comprehensive performance test plan required under §63.1207(e) and (f):
 - i. Number of test conditions and number of runs for each test condition;
 - ii. Target particulate matter emission level for each test condition;
 - iii. How you plan to modify operations to attain the desired particulate matter emission levels; and
 - iv. Anticipated normal emission levels.

The permittee shall submit the particulate CEMS correlation test plan to the Administrator for approval at least 90 calendar days before the correlation test is scheduled to be conducted. However, compliance with this condition is not required until such time that the Agency promulgates all performance specifications and operational requirements applicable to PM CEMS. [Reg.19.304 and 40 C.F.R. § 63.1206(b)(8)(iii)(A) and (B)]

- x. If the Administrator fails to approve or disapprove the correlation test plan with the time period specified by §63.7(c)(3)(i), the plan is considered approved, unless the Administrator has requested additional information. [Reg.19.304 and 40 C.F.R. § 63.1206(b)(8)(iv)]
- y. The particulate matter and associated operating limits and conditions will not be waived for more than 96 hours, in the aggregate, for a correlation test, including all runs of all test conditions, unless more time is approved by the Administrator. [Reg.19.304 and 40 C.F.R. § 63.1206(b)(8)(v)]
- z. The permittee must return to operating conditions indicative of compliance with the applicable particulate matter and opacity standards as soon as possible after correlation testing is completed. [Reg.19.304 and 40 C.F.R. § 63.1206(b)(8)(vii)]

- aa. The permittee must calculate the hazardous waste residence time and include the calculation in the performance test plan under §63.1207(f) and the operating record. The permittee must also provide the hazardous waste residence time in the Documentation of Compliance under §63.1211(c) and the Notification of Compliance under §63.1207(j) and §63.1210(b). [Reg.19.304 and 40 C.F.R. § 63.1206(b)(11)]
- bb. The permittee must conduct a minimum of three runs of a performance test required under §63.1207 to document compliance with the emission standards of this subpart. [Reg.19.304 and 40 C.F.R. § 63.1206(b)(12)(i)]
- cc. The permittee must document compliance with the emission standards based on the arithmetic average of the emission results of each run, except that the permittee must document compliance with the destruction and removal efficiency standard for each run of the comprehensive performance test individually. [Reg.19.304 and 40 C.F.R. § 63.1206(b)(12)(ii)]

General Operating Requirements

- dd. The permittee must operate only under the operating requirements specified in the Notification of Compliance under §63.1207(j) and §63.1210(b), except:
[Reg.19.304 and 40 C.F.R. § 63.1206(c)(1)(i)]
 - i. During performance tests under approved test plans according to §63.1207(e), (f), and (g), [Reg.19.304 and 40 C.F.R. § 63.1206(c)(1)(i)(A)]
 - ii. Under the conditions of paragraph (b)(1)(i) or (ii) of this section [Reg.19.304 and 40 C.F.R. § 63.1206(c)(1)(i)(B)]
 - 1. The Notification of Compliance must contain operating requirements including, but not limited to, the operating requirements of this section and §63.1209. [Reg.19.304 and 40 C.F.R. § 63.1206(c)(1)(ii)]
 - 2. Failure to comply with the operating requirements is failure to ensure compliance with the emissions standards of this subpart [Reg.19.304 and 40 C.F.R. § 63.1206(c)(1)(iii)]
 - 3. Operating requirements in the Notification of Compliance are applicable requirements for purposes of parts 70 and 71 of this chapter [Reg.19.304 and 40 C.F.R. § 63.1206(c)(1)(iv)]
 - 4. The operating requirements specified in the Notification of Compliance will be incorporated in the Title V permit. [Reg.19.304 and 40 C.F.R. § 63.1206(c)(1)(v)]
- ee. Except as provided in by paragraph (c)(2)(ii) of this section, the permittee is subject to the startup, shutdown, and malfunction plan requirements of §63.6(e)(3). [Reg.19.304 and 40 C.F.R. § 63.1206(c)(2)(i)]

- i. If the permittee elects to comply with §270.235(a)(1)(iii), §270.235(a)(2)(iii), or §270.235(b)(1)(ii) of this chapter to address RCRA concerns, the permittee must comply with the provisions of §63.1206(c)(2)(ii)(A) and (B). [Reg.19.304 and 40 C.F.R. § 63.1206(c)(2)(ii)]
 - ii. The permittee must identify in the plan the projected oxygen correction factor based on normal operations to use during periods of startup and shutdown. [Reg.19.304 and 40 C.F.R. § 63.1206(c)(2)(iii)]
 - iii. The permittee must record the plan in the operating record. [Reg.19.304 and 40 C.F.R. § 63.1206(c)(2)(iv)]
 - iv. The permittee must comply with this requirement for operation under the startup, shutdown, and malfunction plan. [Reg.19.304 and 40 C.F.R. § 63.1206(c)(2)(v)]
- ff. Upon the compliance date, the permittee must operate the combustor with a functioning system that immediately and automatically cuts off the hazardous waste feed, except as provided by paragraph (c)(3)(viii) of this section, when the following conditions apply: [Reg.19.304 and 40 C.F.R. § 63.1206(c)(3)(i)]
 - i. When operating parameter limits specified under §63.1209; an emission standard monitored by CEMS; and the allowable combustion chamber pressure; [Reg.19.304 and 40 C.F.R. § 63.1206(c)(3)(i)(A)]
 - ii. When the span value of any CMS detector, except a CEMS, is met or exceeded; [Reg.19.304 and 40 C.F.R. § 63.1206(c)(3)(i)(B)]
 - iii. Upon malfunction of a CMS monitoring an operating parameter limit specified under §63.1209 or an emission level; or [Reg.19.304 and 40 C.F.R. § 63.1206(c)(3)(i)(C)]
 - iv. When any component of the automatic waste feed cutoff system fails. [Reg.19.304 and 40 C.F.R. § 63.1206(c)(3)(i)(D)]
- gg. During an automatic waste feed cutoff (AWFCO) the permittee must continue to duct combustion gases to the air pollution control system while hazardous waste remains in the combustion chamber. [Reg.19.304 and 40 C.F.R. § 63.1206(c)(3)(ii)]
- hh. The permittee must continue to monitor during the cutoff the operating parameters for which limits are established under §63.1209 and the emissions required under that section to be monitored by a CEMS, and the permittee shall not restart the hazardous waste feed until the operating parameters and emission levels are within specified limits. [Reg.19.304 and 40 C.F.R. § 63.1206(c)(3)(iii)]
- ii. If the AWFCO system fails to automatically and immediately cutoff the flow of hazardous waste upon exceedance of a parameter required to be interlocked with the AWFCO system under paragraph (c)(3)(i) of this section, the permittee has failed to comply with the AWFCO requirements of paragraph (c)(3) of this section. [Reg.19.304 and 40 C.F.R. § 63.1206(c)(3)(iv)]

- jj. If, after any AWFCO, there is an exceedance of any emission standard or operating requirement, irrespective of whether the exceedance occurred while hazardous waste remained in the combustion chamber, the permittee shall investigate the cause of the AWFCO, take appropriate corrective measures to minimize future AWFCOs and record the findings and corrective measures in the operating record. [Reg.19.304 and 40 C.F.R. § 63.1206(c)(3)(v)]
- kk. For each set of 10 exceedances of an emissions standard or operating requirement while hazardous waste remains in the combustion chamber during a 60-day block period, the permittee must submit to the Administrator a written report within 5 calendar days of the 10th exceedance documenting the exceedances and the results of the investigation and corrective measures taken. [Reg.19.304 and 40 C.F.R. § 63.1206(c)(3)(vi)(A)]
- ll. On a case-by-case basis, the Administrator may require excessive exceedance reporting when fewer than 10 exceedances occur during a 60-day block period. [Reg.19.304 and 40 C.F.R. § 63.1206(c)(3)(vi)(B)]
- mm. The AWFCO system and associated alarms must be tested at least weekly to verify operability, unless the permittee documents in the operating record that weekly inspections will unduly restrict or upset operations and that less frequent inspection will be adequate. At a minimum, the permittee must conduct operability testing at least monthly. The permittee must document and record in the operating record AWFCO operability test procedures and results. [Reg.19.304 and 40 C.F.R. § 63.1206(c)(3)(vii)]
- nn. The permittee may ramp down waste feed according to the requirements of §63.1206(c)(3)(viii), except as provided in §63.1206(c)(3)(B). The permittee must document ramp down procedures in the operating and maintenance plan. If the AWFCO is triggered by an exceedance of any of the following operating limits, the permittee may not ramp down the waste feed cutoff: Minimum combustion chamber temperature, maximum hazardous waste feedrate, or any hazardous waste firing system operating limits that may have been established. [Reg.19.304 and 40 C.F.R. § 63.1206(c)(3)(viii)]
- oo. The permittee is subject to the emergency safety vent (ESV) operating and reporting requirements set forth in this section. [Reg.19.304 and 40 C.F.R. § 63.1206(c)(4)(i through iv)]
- pp. The permittee is subject to the combustion system leak control system operating and reporting requirements set forth in these sections. [Reg.19.304 and 40 C.F.R. § 63.1206(c)(5)(i)(A) and (ii)]
- qq. The permittee is subject to the operator training and certification standards set forth in this section. [Reg.19.304 and 40 C.F.R. § 63.1206(c)(6)(i through vii)]
- rr. The permittee must prepare and at all times operate according to an operation and maintenance plan which complies with the requirements set forth in these sections. [Reg.19.304 and 40 C.F.R. § 63.1206(c)(7)(i)(A-D)]

Performance Testing Requirements

- ss. The permittee must conduct performance testing in accordance with the applicable requirements contained in this section. [Reg.19.304 and 40 C.F.R. § 63.1207(a-m)]
- tt. The permittee must commence the initial comprehensive performance test not later than six months after the compliance date. [Reg.19.304 and 40 C.F.R. § 63.1207(c)(1)]
- uu. The permittee must conduct testing periodically as described in paragraphs (d)(1) through (3) of this section. The date of commencement of the initial comprehensive performance test is the basis for establishing the deadline to commence the initial confirmatory performance test and the next comprehensive performance test. The permittee may conduct performance testing at any time prior to the required date. The deadline for commencing subsequent confirmatory and comprehensive performance testing is based on the date of commencement of the previous comprehensive performance test. [Reg.19.304 and 40 C.F.R. § 63.1207(d)(1) through (3)]
 - i. The permittee must commence comprehensive testing no later than 61 months after the date of commencing the previous comprehensive performance test.
 - ii. The permittee must commence confirmatory performance testing no later than 31 months after the date of commencing the previous comprehensive performance test. To ensure that the confirmatory test is conducted approximately midway between comprehensive performance tests, the Administrator will not approve a test plan that schedules testing within 18 months of commencing the previous comprehensive performance test.
 - iii. The permittee must complete performance testing within 60 days after the date of commencement, unless the Administrator determines that a time extension is warranted based on documentation in writing of factors beyond the permittee's control that prevent testing from being completed within 60 days.

Applicable Testing Requirements under the Interim Standard

- vv. *Waiver of periodic comprehensive performance tests.* Except as provided by §63.1207(c)(2), the permittee must conduct only an initial comprehensive performance test under the interim standards (i.e., the standards published in the Federal Register on February 13, 2002). All subsequent comprehensive performance testing requirements are waived under the interim standards. The provisions in the introductory test to paragraph (d) and in paragraph (d)(1) of this section do not apply until EPA promulgates permanent replacement standards pursuant to the Settlement Agreement noticed in the Federal Register on November 16, 2001. [Reg.19.304 and 40 C.F.R. § 63.1207(d)(4)(i)].

- ww. *Waiver of periodic confirmatory performance tests.* The permittee is not required to conduct a confirmatory test under the interim standards (i.e., the standards published in the Federal Register on February 13, 2002). The confirmatory testing requirements in the introductory text to paragraph (d) and in (d)(2) of §63.1207 are waived until EPA promulgates permanent replacement standards pursuant to the Settlement Agreement noticed in the Federal Register on November 16, 2001. [Reg.19.304 and 40 C.F.R. § 63.1207(d)(4)(ii)].
- xx. The permittee must submit to the Administrator a notification of intent to conduct a comprehensive performance test and CMS performance evaluation and a site specific test plan and CMS performance evaluation plan at least one year before the performance test and performance evaluation are scheduled to begin. [Reg.19.304 and 40 C.F.R. § 63.1207(e)(1)(i)]
- yy. The permittee must submit to the Administrator a notification of intent to conduct the comprehensive performance test at least 60 calendar days before the test is scheduled to begin. [Reg.19.304 and 40 C.F.R. § 63.1207(e)(1)(i)(B)]
- zz. The permittee must submit to the Administrator a notification of intent to conduct a confirmatory performance test and CMS performance evaluation and a test plan and CMS performance evaluation plan at least 60 calendar days before the performance test is scheduled to begin. [Reg.19.304 and 40 C.F.R. § 63.1207(e)(1)(ii)]

Test Methods

- aaa. The permittee shall use the test methods contained in this section when determining compliance with the emissions standards of this subpart. [Reg.19.304 and 40 C.F.R. § 63.1208(a-b)]

Monitoring Requirements

- bbb. The permittee is subject to the applicable monitoring requirements contained in these sections. [Reg.19.304 and 40 C.F.R. § 63.1209 (a-q)]
- ccc. The permittee must either use a carbon monoxide or hydrocarbon CEMS to demonstrate compliance with either the carbon monoxide and hydrocarbon standards under this subpart. The permittee must also use an oxygen CEMS to continuously correct the carbon monoxide and hydrocarbon levels to 7 percent oxygen. [[Reg.19.304 and 40 C.F.R. § 63.1209(a)(1)(i)]
- ddd. The permittee must install, calibrate, maintain, and operate a particulate matter CEMS to demonstrate and monitor compliance with the particulate matter standards under this subpart. However, compliance with the requirements in this section to install, calibrate, maintain, and operate the PM CEMS is not required until such time that the Agency promulgates all performance specifications and operational requirements applicable to PM CEMS. [Reg.19.304 and 40 C.F.R. § 63.1209(a)(1)(iii)]

- eee. The permittee must install, calibrate, maintain, and continuously operate the CEMS in compliance with the quality assurance procedures provided in the appendix to this subpart and Performance Specifications 1 (opacity), 4B (carbon monoxide and oxygen), and 8A (hydrocarbons) in Appendix B, Part 60 of this chapter. [Reg.19.304 and 40 C.F.R. § 63.1209(a)(2)]
- fff. The permittee must comply with the span requirements of §63.1209(a)(3). [Reg.19.304 and 40 C.F.R. § 63.1209(a)(3)]
- ggg. The permittee may petition the Administrator to use CEMS for compliance monitoring for other standards in lieu of compliance with the corresponding operating parameter limits under this section. [Reg.19.304 and 40 C.F.R. § 63.1209(a)(5)]
- hhh. The permittee will begin recording one-minute and hourly rolling average values as necessary to ensure that 60 one-minute values will be available for calculating the initial hourly rolling average before the compliance date. The permittee will continue to use the CEMS to monitor parameters as required in §63.1209(a)(6). [Reg.19.304 and 40 C.F.R. § 63.1209(a)(6)]
- iii. The permittee will use the Comprehensive Performance Test to demonstrate that the THC standard is met to establish operating parameters for DRE. [Reg.19.304 and 40 C.F.R. § 63.1209(a)(7)]
- jjj. The permittee will use Continuous Monitoring Systems where necessary to ensure compliance with operating parameters established in the Documentation of Compliance or the Notification of Compliance. [Reg.19.304 and 40 C.F.R. § 63.1209(b)]
- kkk. Prior to feeding the material, the permittee must obtain an analysis of each feedstream that is sufficient to document compliance with the applicable feedrate limits provided in this section. [Reg.19.304 and 40 C.F.R. § 63.1209(c)(1)]
- lll. The permittee must develop and implement a feedstream analysis plan and record it in the operating record. [Reg.19.304 and 40 C.F.R. § 63.1209(c)(2)]
- mmm. The permittee must submit the feedstream analysis plan to the Administrator for review and approval, if requested. [Reg.19.304 and 40 C.F.R. § 63.1209(c)(3)]
- nnn. To comply with the applicable feedrate limits of this section, the permittee must monitor and record the feedrates as follows: [Reg.19.304 and 40 C.F.R. § 63.1209(c)(4)]
 - i. Determine and record the value of the parameter for each feedstream by sampling and analysis or other method;
 - ii. Determine and record the mass or volume flowrate of each stream by a CMS. If the permittee determines flowrate of a feedstream by volume, the permittee must determine and record the density of the feedstream by sampling and analysis (unless the permittee reports the constituent concentration in units of weight per volume); and

- iii. Calculate and record the mass feedrate of the parameter per unit time.
- ooo. The requirements of §63.8(d) (Quality control program) and (e) (Performance evaluation of continuous monitoring systems) apply, except that the permittee must conduct performance evaluations components of the CMS under the frequency and procedures (for example, submittal of performance evaluation test plan for review and approval) applicable to performance tests as provided by §63.1207. [Reg.19.304 and 40 C.F.R. § 63.1209(d)(1)]
- ppp. The permittee shall maintain and operate each CMS as specified in §63.8(c), except for §63.8(c)(3) and §63.8(c)(4)(ii). The permittee shall have the CMS installed, calibrated, and operational on the compliance date. The permittee must sample the regulated parameter without interruption, and evaluate the detector response at least once each 15 seconds, and compute and record the average values at least every 60 seconds. [Reg.19.304 and 40 C.F.R. § 63.1209(f)]
- qqq. The permittee shall follow the requirements for the reduction of monitoring data as specified in 40 CFR §63.8(g). [Reg.19.304 and 40 C.F.R. § 63.1209(h)]
- rrr. When one operating parameter is used to ensure compliance with one or more standards, the permittee must use the most stringent limit, determined during the comprehensive performance test, as the limit for that operating parameter. [Reg.19.304 and 40 C.F.R. § 63.1209(i)]
- sss. To remain in compliance with the destruction and removal efficiency (DRE) standards, the permittee must establish operating limits during the comprehensive performance test (or during a previous DRE test under provisions of §63.1206(b)(7)) for the following parameters, unless the limits are based on manufacturer specifications and comply with those limits at all times that hazardous waste remains in the combustion chamber. [Reg.19.304 and 40 C.F.R. § 63.1209(j)]
- ttt. The permittee must measure the temperature of each combustion chamber at locations that best represents, as practicable, the bulk gas temperature in the combustion zone. The permittee must document the temperature measurement location in the test plan submitted under §63.1207(e), and establish a minimum rolling average limit as the average of the test run values. [Reg.19.304 and 40 C.F.R. § 63.1209(j)(1)(i) and (ii)]
- uuu. As an indicator of gas residence time in the control device, the permittee must establish and comply with a limit on the maximum flue gas flowrate, the maximum production rate, or another parameter that is documented in the site-specific test plan as an appropriate surrogate for gas residence time, as the average of the maximum hourly rolling averages for each run. [Reg.19.304 and 40 C.F.R. § 63.1209(j)(2)(i)]
- vvv. The permittee must establish limits on the maximum pumpable and total (i.e., pumpable and nonpumpable) hazardous waste feedrate for each location where hazardous waste is fed. [Reg.19.304 and 40 C.F.R. § 63.1209(j)(3)(i)]

- www. The permittee must specify operating parameters and limits to ensure that good operation of each hazardous waste firing system is maintained. [Reg.19.304 and 40 C.F.R. § 63.1209(j)(4)]
- xxx. The permittee must comply with the dioxin and furans emission standard by establishing and complying with the following operating parameter limits. You must base the limits on operations during the comprehensive performance test, unless the limits are based on manufacturer specifications. [Reg.19.304 and 40 C.F.R. § 63.1209(k)]
- yyy. The permittee must measure the temperature of each combustion chamber at a location that best represents, as practicable, the bulk gas temperature in the combustion zone. The permittee must document the temperature measurement location in the test plan and establish a minimum hourly rolling average limit as the average of the test runs. [Reg.19.304 and 40 C.F.R. § 63.1209(k)(2)(i) and (ii)]
- zzz. As an indicator of gas residence time in the control device, the permittee must establish and comply with a limit on the maximum flue gas flowrate, the maximum production rate, or another parameter which is an appropriate surrogate for residence time, as the hourly rolling averages for each run. Compliance with this limit is on an hourly rolling average basis. [Reg.19.304 and 40 C.F.R. § 63.1209(k)(3)(i) and (ii),]
- aaaa. The permittee must establish limits on the maximum pumpable and total (pumpable and nonpumpable) waste feedrate for each location where waste is fed and establish limits as the average of the maximum hourly rolling averages for each run. Compliance shall be based on an hourly rolling average basis. [Reg.19.304 and 40 C.F.R. § 63.1209(k)(4)(i B iii)]
- bbbb. The permittee shall ensure compliance with the mercury emission standard by establishing minimum mercury feed rate limit. The limit is established as a 12-hour rolling average limit for the total feedrate of mercury in all feedstreams as the average of the test run values, unless mercury feedrate limits are extrapolated from performance test feedrate levels, and maintaining the scrubber operating parameters described under §63.1209(l). [Reg.19.304 and 40 C.F.R. § 63.1209(l)]The permittee must comply with the particulate matter emission standard by establishing and complying with the operating parameter limits found in §63.1209(m) of this subpart. [Reg.19.304 and 40 C.F.R. § 63.1209(m)]
- cccc. The permittee must comply with the particulate matter emission standard by establishing and complying with the operating parameter limits found in §63.1209(m) of this subpart. [Reg.19.304 and 40 C.F.R. § 63.1209(m)]
- dddd. The permittee must establish a maximum ash feedrate limit as the average of the test run averages. [Reg.19.304 and 40 C.F.R. § 63.1209(m)(3)]
- eeee. The permittee must comply with the semivolatile metal (cadmium and lead) and low volatile metal (arsenic, beryllium, and chromium) emission standards by establishing and complying with the following operating parameter limits: [Reg.19.304 and 40 C.F.R. § 63.1209(n)]

- i. The permittee must establish feed rate limits for semivolatile metals and low volatile metals, with compliance based on 12-hour rolling average limits as the average of the test run averages. [Reg.19.304 and 40 C.F.R. § 63.1209(n)(2)(i)(A) and (B)]
 - ii. The permittee must establish operating parameter limits on the particulate matter control device as specified by paragraph 63.1209(m)(1). [Reg.19.304 and 40 C.F.R. § 63.1209(n)(3)]
 - iii. The permittee must establish a 12-hour rolling average limit for the feedrate of total chlorine and chloride in all feedstreams as the average of the test run averages. [Reg.19.304 and 40 C.F.R. § 63.1209(n)(4)]
- ffff. The permittee must establish a 12-hour rolling average limit for the total feedrate of chlorine in all feedstreams as the average of the test run averages. [Reg.19.304 and 40 C.F.R. § 63.1209(o)(1)]
- gggg. As an indicator of gas residence time in the control device, the permittee must establish a limit on the maximum flue gas flowrate, the maximum production rate, or another parameter documented in the site-specific test plan as an appropriate surrogate for gas residence time, as the average of the maximum hourly rolling averages for each run. This limit must be maintained on an hourly rolling average basis. [Reg.19.304 and 40 C.F.R. § 63.1209(o)(2)(i)]
- hhhh. The permittee must establish the following parameter limits for the wet scrubber: [Reg.19.304 and 40 C.F.R. § 63.1209(o)(3)]
 - i. Minimum pressure drop. The permittee must establish a limit on minimum pressure drop on an hourly rolling average as the average of the test run averages.
 - ii. Minimum pH. The permittee must establish a limit on minimum pH on an hourly rolling average as the average of the test run averages.
 - iii. Minimum scrubber liquid flow rate. The permittee must establish a minimum scrubber liquid flow rate on an hourly rolling average as the average of the test run averages.

Notification Requirements

- iiii. The permittee shall submit all of the applicable notifications prior to the deadlines established in this subpart. [Reg.19.304 and 40 C.F.R. § 63.1210(a)(1)]
- jjjj. The permittee must submit the required notifications outlined in this section to the Administrator in order to request or elect to comply with the alternative requirements contained in this subpart. [Reg.19.304 and 40 C.F.R. § 63.1210(a)(2)]
- kkkk. Upon postmark of the Notification of Compliance, the operating parameter limits identified in the Notification of Compliance, as applicable, shall be complied with, the limits identified in the Document of Compliance or a previous Notification of Compliance are no longer applicable. [Reg.19.304 and 40 C.F.R. § 63.1210(b)(2)]

FutureFuel Chemical Company
Permit #: 1085-AOP-R16
AFIN: 32-00036

Recordkeeping and Reporting Requirements

- llll. The permittee shall submit the reports required by this subpart to the Administrator prior to the deadlines set forth in this subpart. [Reg.19.304 and 40 C.F.R. § 63.1211]

Procedure for Extending the Compliance Date

- mmmm.The permittee may request an extension of the compliance date to install pollution prevention or waste minimization controls provided that the conditions outlined in this section are met. [Reg.19.304 and 40 C.F.R. § 63.1213]

Solvent Recovery

4PSR-00 and SR-FUG

Source Description

FutureFuel Chemical Company operates dedicated Solvent Recovery equipment to recover solvents that become contaminated during the manufacturing processes. Individual streams from the chemical manufacturing processes are transferred to storage tanks in the solvent recovery area. These streams are pumped to a pH adjustment system and then to a series of distillation columns. After distillation, the solvents are reused in the manufacturing processes or are sold for other uses. Process emissions from the Solvent Recovery Facility are controlled with Regenerative Thermal Oxidizers (RTOs), 5N09-01.

Specific Conditions

- SR 1. The permittee shall not exceed the emission rates set forth in the following table. The permittee shall demonstrate compliance with this condition by SR 3 and SR 6. [Reg.19.501 *et seq.* and 40 C.F.R. § 52 Subpart E]

SN	Description	Pollutant	lb/hr	tpy
4PSR-00	Solvent Recovery Facility	VOC	4.0	17.0
SR-FUG	Solvent Recovery Fugitive Emissions	VOC	5.0	21.9

- SR 2. The permittee shall not exceed the emission rates set forth in the following table. The permittee shall demonstrate compliance with this condition by SR 3 and SR 6. The facility shall show compliance with the facility total ton/yr limits using the procedures outlined in PW11 through PW15. Hourly Plantwide Hazardous Air Pollutant emissions are limited by PW 12. Additional HAP limitations are included in 12. [Reg.18.801 and Ark. Code Ann. § 8-4-203 as referenced by Ark. Code Ann. §§ 8-4-304 and 8-4-311]

SN	Description	Pollutant	lb/hr
4PSR-00	Solvent Recovery Facility	Organic Pollutants**	***
SR-FUG	Solvent Recovery Fugitive Emissions	Organic Pollutants**	***

**Organic Pollutants are considered to be VOC, all organic HAPs, and organic Air Contaminates.

***Limited by Plantwide Condition 12.

- SR 3. The permittee shall not process more than 40 million pounds per year of VOC solvents at the solvent recovery facility. [Reg.19.705, Ark. Code Ann. § 8-4-203 as referenced by Ark. Code Ann. §§ 8-4-304 and 8-4-311, and 40 C.F.R. § 70.6]

FutureFuel Chemical Company
Permit #: 1085-AOP-R16
AFIN: 32-00036

- SR 4. The permittee shall keep monthly records of the amount of solvent throughput at 4PSR-00. These records shall be kept on site and made available upon request. [Reg.19.705 and 40 C.F.R. § 52 Subpart E]
- SR 5. Reserved
- SR 6. The permittee is limited to 250 million gallons of biodiesel refining in the Solvent Recovery area. [Reg.18.1004 and Ark. Code Ann. § 8-4-203 as referenced by Ark. Code Ann. §§ 8-4-304 and 8-4-311]
- SR 7. Emissions from biodiesel production in the Solvent Recovery area shall be recalculated monthly, and shall be based upon a 12-month rolling total. The records shall be updated by the last day of the month following the recorded 12-month period, and shall be kept on site and made available for inspection upon request. [Reg.19.705 and 40 C.F.R. § 52 Subpart E and Reg.18.1004 and Ark. Code Ann. § 8-4-203 as referenced by Ark. Code Ann. §§ 8-4-304 and 8-4-311]

Wastewater Treatment Facility

7K01-01 and 7M01-02

Source Description

The Wastewater Treatment Plant (WWT) at FutureFuel Chemical Company treats process wastewater from various areas of the plant, sanitary sewage, and some storm water. The wastewater treatment system is an extended aeration activated sludge design consisting of equalization and neutralization, aeration, and clarification. The excess biomass is aerobically digested and either land applied on-site via a spray irrigation system or dewatered and burned in the coal-fired boilers. A diversion tank is used to reduce organic or hydraulic peaks in the untreated wastewater.

Specific Conditions

- WWT 1. The permittee shall not exceed the emission rates set forth in the following table. The permittee shall demonstrate compliance with this condition by compliance with WWT 3. [Reg.19.501 *et seq.* and 40 C.F.R. § 52 Subpart E]

PES #	Description	Pollutant	lb/hr
7K01-01	WWT Facilities	VOC	28.6
7M01-02	EQ-C-03 Decant Tank	VOC	0.8
7M01-04	EQ-C-05 WWT Container	VOC	0.1

- WWT 2. The permittee shall not exceed the emission rates set forth in the following table. The permittee shall not exceed the emission rates set forth in the following table. Emission rates are based upon the maximum capacity of equipment. The facility shall show compliance with the facility total ton/yr limits using the procedures outlined in PW 11 through PW 15. Hourly Plantwide Hazardous Air Pollutant emissions are limited by PW 15. Additional HAP limitations are included in PW 12. [Reg.18.801 and Ark. Code Ann. § 8-4-203 as referenced by Ark. Code Ann. §§ 8-4-304 and 8-4-311]

PES #	Description	Pollutant	lb/hr
7K01-01	WWT Facilities	Organic Pollutants**	***
7M01-02	EQ-C-03 Decant Tank	Organic Pollutants**	***
7M01-03	EQ-C-04 pH Control Tank	Inorganics*	0.10
7M01-03-B	EQ-C-04-2 pH Control Tank	Inorganics*	0.10

FutureFuel Chemical Company

Permit #: 1085-AOP-R16

AFIN: 32-00036

PES #	Description	Pollutant	lb/hr
7M01-04	EQ-C-05 WWT Container	Organic HAPs*	***

**Organic Pollutants are considered to be VOC, all organic HAPs, and organic Air Contaminates.

***Limited by Plantwide Condition 12.

- WWT 3. The permittee shall calculate the emissions of VOC from the wastewater basins (7K01-01) using a Department or EPA approved model once per year. Annual emissions shall be based on the most recent twelve consecutive months of operation. [Reg.19.703, 40 C.F.R. § 52 Subpart E, and Ark. Code Ann. § 8-4-203 as referenced by Ark. Code Ann. §§ 8-4-304 and 8-4-311]

Isopropyl Benzene Production (DIPB)
5NDIPB-TNK, 5N03-54, 5N03-48, 5N03-55, and DIPB-FUG

Source Description

The isopropyl benzene process consists of alkylation of benzene with propylene. A catalyst is used to promote the reaction. The intermediate, cumene, reacts with propylene to produce three isopropyl benzene variations. Subsequent to the reaction, the catalyst is removed by washing and decanting. Any benzene or intermediate generated that is not fully converted to product is recycled back into the process. 5N03-48 and 5N03-55 are scrubbers associated with the DIPB process.

NESHAP Subpart V (National Emission Standard for Equipment Leaks (Fugitive Emission Sources)) applies to certain equipment installed after 1/5/81. Therefore, this regulation is applicable.

NESHAP Subpart J (Equipment Leaks of Benzene) applies to certain equipment in benzene service. Affected equipment does exist at the DIPB plant. Therefore, this regulation is applicable. This regulation requires affected facilities to comply with the requirements contained in NESHAP Subpart V (Equipment Leaks of VHAP).

NESHAP Subpart Y (Benzene Storage Vessels) applies to storage tank #T-210. A flare (5N03-54) controls emissions from this tank.

NESHAP Subpart FF (Benzene Waste Operations) applies to benzene waste streams at certain facilities, including chemical manufacturing plants. It is applicable to the DIPB plant. A flare (5N03-54) controls benzene emissions generated by the wastewater collection tank (T-9) and the wastewater steam stripper (D-9).

NESHAP Subpart FFFF applies to this part of the facility. The requirements are incorporated in a separate MON section.

Specific Conditions

IB 1. The permittee shall not exceed the emission rates set forth in the following table. These rates are based on maximum physical capacity of the equipment. [Reg.19.501 *et seq.* and 40 C.F.R. § 52 Subpart E]

PES #	Description	Pollutant	lb/hr
5NDIPB-TNK	Tank Bubble (10 tanks)	VOC	0.2
5N03-54	Flare	PM ₁₀	0.1
		SO ₂	0.5
		VOC	0.9
		CO	2.4
		NO _x	0.5
DIPB-FUG	Fugitive Emissions from Isopropyl Benzene Process	VOC	0.3

IB 2. The permittee shall not exceed the emission rates set forth in the following table. The permittee shall not exceed the emission rates set forth in the following table. Emission rates are based upon the maximum capacity of equipment. The facility shall show compliance with the facility total ton/yr limits using the procedures outlined in PW 11 through PW 15. Hourly Plantwide Hazardous Air Pollutant emissions are limited by PW 15. Additional HAP limitations are included in PW 12. [Reg.18.801 and Ark. Code Ann. § 8-4-203 as referenced by Ark. Code Ann. §§ 8-4-304 and 8-4-311]

PES #	Description	Pollutant	lb/hr
5NDIPB-TNK	Tank Bubble (10 tanks)	Organic Pollutants** Inorganic Pollutants*	*** 0.1
5N03-48	Scrubber	Inorganics*	0.10
5N03-54	Flare	PM Organic Pollutants**	0.1 ***
5N03-55	Scrubber	Inorganics*	0.10
DIPB-FUG	Fugitive Emissions from Isopropyl Benzene Process	Organic Pollutants**	***

*Inorganics are considered to be non-organic Hazardous Air Pollutants

**Organic Pollutants are considered to be VOC, all organic HAPs, and organic Air Contaminates.

***Limited by Plantwide Condition 12.

IB 3. The permittee shall operate and maintain a control system on scrubbers 5N03-55 and 5N03-48 in accordance with most current version of the Facility Operating Plan. [Reg.19.303 and Ark. Code Ann. § 8-4-203 as referenced by Ark. Code Ann. §§ 8-4-304 and 8-4-311]

IB 4. The permittee shall operate a control system which detects the presence of a flame on the flare (5N03-54) and gives an alarm if flame is not detected. The reactor process shall be shut down if the cause of the alarm is not corrected within 30 minutes. [Reg.19.303 and Ark. Code Ann. § 8-4-203 as referenced by Ark. Code Ann. §§ 8-4-304 and 8-4-311]

IB 5. The permittee shall operate and monitor the DIPB off-gas flare (5N03-54) according to the requirements of §60.18(d), (e), and (f). Records shall be kept of all periods of operation during which the flare pilot flame is absent. [Reg.19.304 and 40 C.F.R. § 60.18]

40 CFR Part 61 Subpart FF - NESHAP for Benzene Waste Operations

IB 6. The permittee shall comply with all applicable benzene waste stream reporting requirements at the flare (5N03-54) (which controls benzene emissions generated by the wastewater steam stripper) of all applicable waste stream records as outlined by §61.356(b), and as outlined by §61.357(c). [Reg.19.304 and 40 C.F.R. §§ 61.356(b) and 61.357(c)]

IB 7. Provisions of the Subpart FF - NESHAP for Benzene Waste Operations shall apply to chemical manufacturing plants. [Reg.19.304 and 40 C.F.R. § 61.340(a)]

- IB 8. Subpart FF - NESHAP for Benzene Waste Operations, §61.340(c) identifies wastes exempt from the regulatory requirements. The permittee may claim exemptions under §61.342(c)(2) and §61.342(c)(3) providing documentation is kept to support the exemptions identified. [Reg.19.304 and 40 C.F.R. §§ 61.340(c), 61.342(a), 61.342(c)(2), 61.342(c)(3)]
- IB 9. The permittee may claim exemptions as allowed in §61.342(a)(1) through (4), providing documentation of the benzene waste quantity is calculated as specified for the exemption. [Reg.19.304 and 40 C.F.R. § 61.342(a)(1) through (4)]
- IB 10. The permittee has elected to remove or destroy benzene in the waste using a treatment process or wastewater treatment system which complies with §61.348 (Treatment Processes) [Reg.19.304 and 40 C.F.R. § 61.342(c)(1)(i)]
- IB 11. The permittee shall comply with the standards specified in §61.343 through §61.347, as applicable, for each waste management unit. [Reg.19.304 and 40 C.F.R. § 61.342(c)(1)(ii)]
- IB 12. The permittee may elect to meet one of these additional compliance options identified in the citations noted. Subpart FF does not require prior approval for changing between options. The permittee may choose between compliance options as long as documentation is readily available for inspection to provide evidence of compliance with the applicable treatment standard. [Reg.19.304 and 40 C.F.R. § 61.342(d), (e), and (f)]
- IB 13. Compliance with this subpart will be determined by review of facility records and results from tests and inspections using methods and procedures specified in §61.355. [Reg.19.304 and 40 C.F.R. § 61.342(g)]

40 CFR Part 61 Subpart V - National Emission Standard for Equipment Leaks (Fugitive Emission Sources)

Applicability and designation of sources

- IB 14. The provisions of this subpart apply to each of the following sources that are intended to operate in volatile hazardous air pollutant (VHAP) service: pumps, compressors, pressure relief devices, sampling connection systems, open-ended valves or lines, valves, connectors, surge control vessels, bottoms receivers, and control devices or systems required by this subpart. [Reg.19.304 and 40 C.F.R. § 61.240(a)]
 - a. The provisions of this subpart apply to the sources listed in paragraph (a) after the date of promulgation of a specific subpart in part 61. [Reg.19.304 and 40 C.F.R. § 61.240(b)]
 - b. While the provisions of this subpart are effective, a source to which this subpart applies that is also subject to the provisions of 40 CFR part 60 only will be required to comply with the provisions of this subpart. [Reg.19.304 and 40 C.F.R. § 61.240(c)]
 - c. *Alternative means of compliance* —

- i. *Option to comply with part 65.* Owners or operators may choose to comply with 40 CFR part 65 to satisfy the requirements of §§ 61.242-1 through 61.247 for equipment that is subject to this subpart and that is part of the same process unit. When choosing to comply with 40 CFR part 65, the requirements of §§ 61.245(d) and 61.246(i) and (j) still apply. Other provisions applying to owners or operators who choose to comply with 40 CFR part 65 are provided in 40 CFR 65.1. [Reg.19.304 and 40 C.F.R. § 61.240(d)(1)]
- ii. *Part 65, subpart C or F.* For owners or operators choosing to comply with 40 CFR part 65, each surge control vessel and bottoms receiver subject to this subpart that meets the conditions specified in table 1 or table 2 of this subpart shall meet the requirements for storage vessels in 40 CFR part 65, subpart C; all other equipment subject to this subpart shall meet the requirements in 40 CFR part 65, subpart F. [Reg.19.304 and 40 C.F.R. § 61.240(d)(2)]
- iii. *Part 61, subpart A.* Owners or operators who choose to comply with 40 CFR part 65, subpart C or F, must also comply with §§ 61.01, 61.02, 61.05 through 61.08, 61.10(b) through (d), 61.11, and 61.15 for that equipment. All sections and paragraphs of subpart A of this part that are not mentioned in this paragraph (d)(3) do not apply to owners or operators of equipment subject to this subpart complying with 40 CFR part 65, subpart C or F, except that provisions required to be met prior to implementing 40 CFR part 65 still apply. Owners and operators who choose to comply with 40 CFR part 65, subpart C or F, must comply with 40 CFR part 65, subpart A. [Reg.19.304 and 40 C.F.R. § 61.240(d)(3)]
- iv. *Rules referencing this subpart.* Owners or operators referenced to this subpart from subpart F or J of this part may choose to comply with 40 CFR part 65 for all equipment listed in paragraph (a) of this section. [Reg.19.304 and 40 C.F.R. § 61.240(d)(4)]

General Requirements

IB 15. For equipment subject to these standards, the following General Requirements apply:

- a. Each owner or operator subject to the provisions of this subpart shall demonstrate compliance with the requirements of §§ 61.242-1 to 61.242-11 for each new and existing source as required in 40 CFR 61.05, except as provided in §§ 61.243 and 61.244. [Reg.19.304 and 40 C.F.R. § 61.242-1(a)]
- b. Compliance with this subpart will be determined by review of records, review of performance test results, and inspection using the methods and procedures specified in § 61.245. [Reg.19.304 and 40 C.F.R. § 61.242-1(b)]
- c. An owner or operator may request a determination of alternative means of emission limitation to the requirements of §§ 61.242-2, 61.242-3, 61.242-5, 61.242-6, 61.242-7, 61.242-8, 61.242-9 and 61.242-11 as provided in § 61.244. [Reg.19.304 and 40 C.F.R. § 61.242-1(c)(1)]

- d. If the Administrator makes a determination that a means of emission limitation is at least a permissible alternative to the requirements of § 61.242-2, 61.242-3, 61.242-5, 61.242-6, 61.242-7, 61.242-8, 61.242-9 or 61.242-11, an owner or operator shall comply with the requirements of that determination. [Reg.19.304 and 40 C.F.R. § 61.242-1(c)(2)]
- e. Each piece of equipment to which this subpart applies shall be marked in such a manner that it can be distinguished readily from other pieces of equipment. [Reg.19.304 and 40 C.F.R. § 61.242-1(d)]
- f. Equipment that is in vacuum service is excluded from the requirements of § 61.242-2, to § 61.242-11 if it is identified as required in § 61.246(e)(5). [Reg.19.304 and 40 C.F.R. § 61.242-1(e)]

Standards: Pumps

IB 16. For pumps, the permittee is subject to the following requirements:

- a. Each pump shall be monitored monthly to detect leaks by the methods specified in § 61.245(b), except as provided in § 61.242-1(c) and paragraphs (d), (e), (f) and (g) of this section. [Reg.19.304 and 40 C.F.R. § 61.242-2(a)(1)]
- b. Each pump shall be checked by visual inspection each calendar week for indications of liquids dripping from the pump seal. [Reg.19.304 and 40 C.F.R. § 61.242-2(a)(2)]
- c. If an instrument reading of 10,000 ppm or greater is measured, a leak is detected. [Reg.19.304 and 40 C.F.R. § 61.242-2(b)(1)]
- d. If there are indications of liquids dripping from the pump seal, a leak is detected. [Reg.19.304 and 40 C.F.R. § 61.242-2(b)(2)]
- e. When a leak is detected, it shall be repaired as soon as practicable, but not later than 15 calendar days after it is detected, except as provided in § 61.242-10. [Reg.19.304 and 40 C.F.R. § 61.242-2(c)(1)]
- f. A first attempt at repair shall be made no later than 5 calendar days after each leak is detected. [Reg.19.304 and 40 C.F.R. § 61.242-2(c)(2)]
- g. Each pump equipped with a dual mechanical seal system that includes a barrier fluid system is exempt from the requirements of paragraphs (a) and (b) of this section, provided the following requirements are met:
 - i. Each dual mechanical seal system is:
 - 1. Operated with the barrier fluid at a pressure that is at all times greater than the pump stuffing box pressure; or
 - 2. Equipped with a barrier fluid degassing reservoir that is routed to a process or fuel gas system or connected by a closed-vent system to a control device that complies with the requirements of § 61.242-11; or

3. Equipped with a system that purges the barrier fluid into a process stream with zero VHAP emissions to atmosphere.
- ii. The barrier fluid is not in VHAP service and, if the pump is covered by standards under 40 CFR part 60, is not in VOC service.
- iii. Each barrier fluid system is equipped with a sensor that will detect failure of the seal system, the barrier fluid system, or both.
- iv. Each pump is checked by visual inspection each calendar week for indications of liquids dripping from the pump seal.
 1. If there are indications of liquid dripping from the pump seal at the time of the weekly inspection, the pump shall be monitored as specified in § 61.245 to determine the presence of VOC and VHAP in the barrier fluid.
 2. If the monitor reading (taking into account any background readings) indicates the presence of VHAP, a leak is detected. For the purpose of this paragraph, the monitor may be calibrated with VHAP, or may employ a gas chromatography column to limit the response of the monitor to VHAP, at the option of the owner or operator.
 3. If an instrument reading of 10,000 ppm or greater (total VOC) is measured, a leak is detected.
- v. Each sensor as described in paragraph (d)(3) of this section is checked daily or is equipped with an audible alarm.
- vi. The owner or operator determines, based on design considerations and operating experience, criteria applicable to the presence and frequency of drips and to the sensor that indicates failure of the seal system, the barrier fluid system, or both.
- vii. If indications of liquids dripping from the pump seal exceed the criteria established in paragraph (d)(6)(i) of this section, or if, based on the criteria established in paragraph (d)(6)(i) of this section, the sensor indicates failure of the seal system, the barrier fluid system, or both, a leak is detected.
- viii. When a leak is detected, it shall be repaired as soon as practicable, but no later than 15 calendar days after it is detected, except as provided in § 61.242-10.
- ix. A first attempt at repair shall be made no later than five calendar days after each leak is detected.

[Reg.19.304 and 40 C.F.R. § 61.242-2(d)(1)-(d)(6)]

- h. Any pump that is designated, as described in § 61.246(e)(2), for no detectable emissions, as indicated by an instrument reading of less than 500 ppm above background, is exempt from the requirements of paragraphs (a), (c), and (d) if the pump:
 - i. Has no externally actuated shaft penetrating the pump housing,
 - ii. Is demonstrated to be operating with no detectable emissions, as indicated by an instrument reading of less than 500 ppm above background, as measured by the method specified in § 61.245(c), and
 - iii. Is tested for compliance with paragraph (e)(2) initially upon designation, annually, and at other times requested by the Administrator.

[Reg.19.304 and 40 C.F.R. § 61.242-2(e)(1-3)]

- i. If any pump is equipped with a closed-vent system capable of capturing and transporting any leakage from the seal or seals to a process or fuel gas system or to a control device that complies with the requirements of § 61.242-11, it is exempt from the requirements of paragraphs (a) through (e) of this section. [Reg.19.304 and 40 C.F.R. § 61.242-2(f)]
- j. Any pump that is designated, as described in § 61.246(f)(1), as an unsafe-to-monitor pump is exempt from the monitoring and inspection requirements of paragraphs (a) and (d)(4) through (6) of this section if:
 - i. The owner or operator of the pump demonstrates that the pump is unsafe-to-monitor because monitoring personnel would be exposed to an immediate danger as a consequence of complying with paragraph (a) of this section; and
 - ii. The owner or operator of the pump has a written plan that requires monitoring of the pump as frequently as practicable during safe-to-monitor times but not more frequently than the periodic monitoring schedule otherwise applicable, and repair of the equipment according to the procedures in paragraph (c) of this section if a leak is detected.

[Reg.19.304 and 40 C.F.R. § 61.242-2(g)(1&2)]

- k. Any pump that is located within the boundary of an unmanned plant site is exempt from the weekly visual inspection requirement of paragraphs (a)(2) and (d)(4) of this section, and the daily requirements of paragraph (d)(5) of this section, provided that each pump is visually inspected as often as practicable and at least monthly. [Reg.19.304 and 40 C.F.R. § 61.242-2(h)]

Standards: Compressors

IB 17. For compressors, the following requirements apply:

- a. Each compressor shall be equipped with a seal system that includes a barrier fluid system and that prevents leakage of process fluid to atmosphere, except as provided in § 61.242-1(c) and paragraphs (h) and (i) of this section. [Reg.19.304 and 40 C.F.R. § 61.242-3(a)]
- b. Each compressor seal system as required in paragraph (a) shall be:
 - i. Operated with the barrier fluid at a pressure that is greater than the compressor stuffing box pressure; or
 - ii. Equipped with a barrier fluid system degassing reservoir that is routed to a process or fuel gas system or connected by a closed-vent system to a control device that complies with the requirements of § 61.242-11; or
 - iii. Equipped with a system that purges the barrier fluid into a process stream with zero VHAP emissions to atmosphere.
[Reg.19.304 and 40 C.F.R. § 61.242-3(b)(1-3)]
- c. The barrier fluid shall not be in VHAP service and, if the compressor is covered by standards under 40 CFR part 60, shall not be in VOC service. [Reg.19.304 and 40 C.F.R. § 61.242-3(c)]
- d. Each barrier fluid system as described in paragraphs (a)-(c) of this section shall be equipped with a sensor that will detect failure of the seal system, barrier fluid system, or both. [Reg.19.304 and 40 C.F.R. § 61.242-3(d)]
- e. Each sensor as required in paragraph (d) of this section shall be checked daily or shall be equipped with an audible alarm unless the compressor is located within the boundary of an unmanned plant site. [Reg.19.304 and 40 C.F.R. § 61.242-3(e)(1)]
- f. The owner or operator shall determine, based on design considerations and operating experience, a criterion that indicates failure of the seal system, the barrier fluid system, or both. [Reg.19.304 and 40 C.F.R. § 61.242-3(e)(2)]
- g. If the sensor indicates failure of the seal system, the barrier fluid system, or both based on the criterion determined under paragraph (e)(2) of this section, a leak is detected. [Reg.19.304 and 40 C.F.R. § 61.242-3(f)]
- h. When a leak is detected, it shall be repaired as soon as practicable, but not later than 15 calendar days after it is detected, except as provided in § 61.242-10. [Reg.19.304 and 40 C.F.R. § 61.242-3(g)(1)]
- i. A first attempt at repair shall be made no later than 5 calendar days after each leak is detected. [Reg.19.304 and 40 C.F.R. § 61.242-3(g)(2)]

- j. A compressor is exempt from the requirements of paragraphs (a) and (b) of this section if it is equipped with a closed-vent system to capture and transport leakage from the compressor drive shaft back to a process or fuel gas system or to a control device that complies with the requirements of § 61.242-11, except as provided in paragraph (i) of this section. [Reg.19.304 and 40 C.F.R. § 61.242-3(h)]
- k. Any Compressor that is designated, as described in § 61.246(e)(2), for no detectable emission as indicated by an instrument reading of less than 500 ppm above background is exempt from the requirements of paragraphs (a)-(h) if the compressor:
 - i. Is demonstrated to be operating with no detectable emissions, as indicated by an instrument reading of less than 500 ppm above background, as measured by the method specified in § 61.245(c); and
 - ii. Is tested for compliance with paragraph (i)(1) initially upon designation, annually, and at other times requested by the Administrator.[Reg.19.304 and 40 C.F.R. § 61.242-3(i)(1&2)]

Standards: Pressure relief devices in gas/vapor service

IB 18. The following requirements apply to pressure relief devices in gas/vapor service:

- a. Except during pressure releases, each pressure relief device in gas/vapor service shall be operated with no detectable emissions, as indicated by an instrument reading of less than 500 ppm above background, as measured by the method specified in § 61.245(c). [Reg.19.304 and 40 C.F.R. § 61.242-4(a)]
- b. After each pressure release, the pressure relief device shall be returned to a condition of no detectable emissions, as indicated by an instrument reading of less than 500 ppm above background, as soon as practicable, but no later than 5 calendar days after each pressure release, except as provided in § 61.242-10. [Reg.19.304 and 40 C.F.R. § 61.242-4(b)(1)]
- c. No later than 5 calendar days after the pressure release, the pressure relief device shall be monitored to confirm the condition of no detectable emissions, as indicated by an instrument reading of less than 500 ppm above background, as measured by the method specified in § 61.245(c). [Reg.19.304 and 40 C.F.R. § 61.242-4(b)(2)]
- d. Any pressure relief device that is routed to a process or fuel gas system or equipped with a closed-vent system capable of capturing and transporting leakage from the pressure relief device to a control device as described in § 61.242-11 is exempt from the requirements of paragraphs (a) and (b) of this section. [Reg.19.304 and 40 C.F.R. § 61.242-4(c)]

- e. Any pressure relief device that is equipped with a rupture disk upstream of the pressure relief device is exempt from the requirements of paragraphs (a) and (b) of this section, provided the owner or operator complies with the requirements in paragraph (d)(2) of this section. [Reg.19.304 and 40 C.F.R. § 61.242-4(d)(1)]
- f. After each pressure release, a new rupture disk shall be installed upstream of the pressure relief device as soon as practicable, but no later than 5 calendar days after each pressure release, except as provided in § 61.242-10. [Reg.19.304 and 40 C.F.R. § 61.242-4(d)(2)]

Standards: Sampling connecting systems

IB 19. For Sampling connection systems, the following requirements apply:

- a. Each sampling connection system shall be equipped with a closed-purge, closed-loop, or closed vent system, except as provided in § 61.242-1(c). Gases displaced during filling of the sample container are not required to be collected or captured. [Reg.19.304 and 40 C.F.R. § 61.242-5(a)]
 - b. Each closed-purge, closed-loop, or closed-vent system as required in paragraph (a) of this section shall comply with the requirements specified in paragraphs (b)(1) through (4) of this section.
 - i. Return the purged process fluid directly to the process line.
 - ii. Collect and recycle the purged process fluid to a process.
 - iii. Be designed and operated to capture and transport all the purged process fluid to a control device that complies with the requirements of § 61.242-11; or
 - iv. Collect, store, and transport the purged process fluid to any of the following systems or facilities:
 - 1. A waste management unit as defined in § 63.111, if the waste management unit is subject to and operated in compliance with the provisions of 40 CFR part 63, subpart G, applicable to Group 1 wastewater streams;
 - 2. A treatment, storage, or disposal facility subject to regulation under 40 CFR part 262, 264, 265, or 266;
 - 3. A facility permitted, licensed, or registered by a state to manage municipal or industrial solid waste, if the process fluids are not hazardous waste as defined in 40 CFR part 261;
- [Reg.19.304 and 40 C.F.R. § 61.242-5(b)(1-4)]
- c. In situ sampling systems and sampling systems without purges are exempt from the requirements of paragraphs (a) and (b) of this section. [Reg.19.304 and 40 C.F.R. § 61.242-5(c)]

Standards: Open-ended valves or lines

IB 20. For open-ended valves or lines, the following requirements apply:

- a. Each open-ended valve or line shall be equipped with a cap, blind flange, plug, or a second valve, except as provided in § 61.242-1(c). [Reg.19.304 and 40 C.F.R. § 61.242-6(a)(1)]
- b. The cap, blind flange, plug, or second valve shall seal the open end at all times except during operations requiring process fluid flow through the open-ended valve or line. [Reg.19.304 and 40 C.F.R. § 61.242-6(a)(2)]
- c. Each open-ended valve or line equipped with a second valve shall be operated in a manner such that the valve on the process fluid end is closed before the second valve is closed. [Reg.19.304 and 40 C.F.R. § 61.242-6(b)]
- d. When a double block and bleed system is being used, the bleed valve or line may remain open during operations that require venting the line between the block valves but shall comply with paragraph (a) at all other times. [Reg.19.304 and 40 C.F.R. § 61.242-6(c)]
- e. Open-ended valves or lines in an emergency shutdown system which are designed to open automatically in the event of a process upset are exempt from the requirements of paragraphs (a), (b) and (c) of this section. [Reg.19.304 and 40 C.F.R. § 61.242-6(d)]
- f. Open-ended valves or lines containing materials which would auto-catalytically polymerize or would present an explosion, serious overpressure, or other safety hazard if capped or equipped with a double block and bleed system as specified in paragraphs (a) through (c) of this section are exempt from the requirements of paragraphs (a) through (c) of this section. [Reg.19.304 and 40 C.F.R. § 61.242-6(e)]

Standards: Valves

IB 21. For Valves, the following apply:

- a. Each valve shall be monitored monthly to detect leaks by the method specified in § 61.245(b) and shall comply with paragraphs (b)-(e), except as provided in paragraphs (f), (g), and (h) of this section, § 61.243-1 or § 61.243-2, and § 61.242-1(c). [Reg.19.304 and 40 C.F.R. § 61.242-7(a)]
- b. If an instrument reading of 10,000 ppm or greater is measured, a leak is detected. [Reg.19.304 and 40 C.F.R. § 61.242-7 (b)]
- c. Any valve for which a leak is not detected for 2 successive months may be monitored the first month of every quarter, beginning with the next quarter, until a leak is detected. [Reg.19.304 and 40 C.F.R. § 61.242-7 (c)(1)]
- d. If a leak is detected, the valve shall be monitored monthly until a leak is not detected for 2 successive months. [Reg.19.304 and 40 C.F.R. § 61.242-7 (c)(2)]

- e. When a leak is detected, it shall be repaired as soon as practicable, but no later than 15 calendar days after the leak is detected, except as provided in § 61.242-10. [Reg.19.304 and 40 C.F.R. § 61.242-7 (d)(1)]
- f. A first attempt at repair shall be made no later than 5 calendar days after each leak is detected. [Reg.19.304 and 40 C.F.R. § 61.242-7 (d)(2)]
- g. First attempts at repair include, but are not limited to, the following best practices where practicable:
 - i. Tightening of bonnet bolts;
 - ii. Replacement of bonnet bolts;
 - iii. Tightening of packing gland nuts;
 - iv. Injection of lubricant into lubricated packing.[Reg.19.304 and 40 C.F.R. § 61.242-7 (e)(1-4)]
- h. Any valve that is designated, as described in § 61.246(e)(2), for no detectable emissions, as indicated by an instrument reading of less than 500 ppm above background, is exempt from the requirements of paragraph (a) if the valve:
 - i. Has no external actuating mechanism in contact with the process fluid,
 - ii. Is operated with emissions less than 500 ppm above background, as measured by the method specified in § 61.245(c), and
 - iii. Is tested for compliance with paragraph (f)(2) of this section initially upon designation, annually, and at other times requested by the Administrator.[Reg.19.304 and 40 C.F.R. § 61.242-7 (f)(1-3)]
- i. Any valve that is designated, as described in § 61.246(f)(1), as an unsafe-to-monitor valve is exempt from the requirements of paragraph (a) if:
 - i. The owner or operator of the valve demonstrates that the valve is unsafe to monitor because monitoring personnel would be exposed to an immediate danger as a consequence of complying with paragraph (a), and
 - ii. The owner or operator of the valve adheres to a written plan that requires monitoring of the valve as frequently as practicable during safe-to-monitor times.[Reg.19.304 and 40 C.F.R. § 61.242-7 (g)(1&2)]
- j. Any valve that is designated, as described in § 61.246(f)(2), as a difficult-to-monitor valve is exempt from the requirements of paragraph (a) if:
 - i. The owner or operator of the valve demonstrates that the valve cannot be monitored without elevating the monitoring personnel more than 2 meters above a support surface.

- ii. The process unit within which the valve is located either becomes an affected facility through § 60.14 or § 60.15 or the owner or operator designates less than 3.0 percent of the total number of valves as difficult-to-monitor, and
- iii. The owner or operator of the valve follows a written plan that requires monitoring of the valve at least once per calendar year.

[Reg.19.304 and 40 C.F.R. § 61.242-7 (g)(1-3)]

Standards: Pressure relief services in liquid service and connectors

IB 22. For Pressure relief services in liquid service and connectors the following apply:

- a. If evidence of a potential leak is found by visual, audible, olfactory, or any other detection method at pressure relief devices in liquid service and connectors, the owner or operator shall follow either one of the following procedures, except as provided in § 61.242-1(c):
 - i. The owner or operator shall monitor the equipment within 5 days by the method specified in § 61.245(b) and shall comply with the requirements of paragraphs (b) through (d) of this section.
 - ii. The owner or operator shall eliminate the visual, audible, olfactory, or other indication of a potential leak within 5 calendar days of detection.

[Reg.19.304 and 40 C.F.R. § 61.242-8 (a)(1&2)]

- b. If an instrument reading of 10,000 ppm or greater is measured, a leak is detected. [Reg.19.304 and 40 C.F.R. § 61.242-8 (b)]
- c. When a leak is detected, it shall be repaired as soon as practicable, but not later than 15 calendar days after it is detected, except as provided in § 61.242-10 [Reg.19.304 and 40 C.F.R. § 61.242-8 (c)(1)]
- d. The first attempt at repair shall be made no later than 5 calendar days after each leak is detected. [Reg.19.304 and 40 C.F.R. § 61.242-8 (c)(2)]
- e. First attempts at repair include, but are not limited to, the best practices described under § 61.242-7(e). [40 CFR§61.242-8 (d)]

Standards: Surge control vessels and bottoms receivers

IB 23. Each surge control vessel or bottoms receiver that is not routed back to the process and that meets the conditions specified in table 1 or table 2 of this subpart shall be equipped with a closed-vent system capable of capturing and transporting any leakage from the vessel back to the process or to a control device as described in § 61.242-11, except as provided in § 61.242-1(c); or comply with the requirements of 40 CFR 63.119(b) or (c). [40 CFR§61.242-9]

Standards: Delay of repair

IB 24. For leaks detected, the following are requirements for delay of repair:

- a. Delay of repair of equipment for which leaks have been detected will be allowed if repair within 15 days is technically infeasible without a process unit shutdown. Repair of this equipment shall occur before the end of the next process unit shutdown. [40 CFR§61.242-10 (a)]
- b. Delay of repair of equipment will be allowed for equipment which is isolated from the process and which does not remain in VOC service. [40 CFR§61.242-10 (b)]
- c. Delay of repair for valves will be allowed if:
 - i. The owner or operator demonstrates that emissions of purged material resulting from immediate repair are greater than the fugitive emissions likely to result from delay of repair, and
 - ii. When repair procedures are effected, the purged material is collected and destroyed or recovered in a control device complying with § 61.242-11.

[Reg.19.304 and 40 C.F.R. § 61.242-10 (c)(1 and 2)]

- d. Delay of repair for pumps will be allowed if:
 - i. Repair requires the use of a dual mechanical seal system that includes a barrier fluid system, and
 - ii. Repair is completed as soon as practicable, but not later than 6 months after the leak was detected.

[Reg.19.304 and 40 C.F.R. § 61.242-10 (d)(1 and 2)]

- e. Delay of repair beyond a process unit shutdown will be allowed for a valve if valve assembly replacement is necessary during the process unit shutdown, valve assembly supplies have been depleted, and valve assembly supplies had been sufficiently stocked before the supplies were depleted. Delay of repair beyond the next process unit shutdown will not be allowed unless the next process unit shutdown occurs sooner than 6 months after the first process unit shutdown. [Reg.19.304 and 40 C.F.R. § 61.242-10 (e)]

Standards: Closed vent systems and control devices

IB 25. The permittee shall comply with the following standards for closed vent systems and control devices subject to this subpart:

- a. Owners or operators of closed-vent systems and control devices used to comply with provisions of this subpart shall comply with the provisions of this section, except as provided in §61.242-1(c). [Reg.19.304 and 40 C.F.R. § 61.242-11 (a)]
- b. Vapor recovery systems (for example, condensers and absorbers) shall be designed and operated to recover the VOC emissions vented to them with an efficiency of 95 percent or greater, or to an exit concentration of 20 parts per million by volume, whichever is less stringent. [Reg.19.304 and 40 C.F.R. § 61.242-11 (b)]

- c. Enclosed combustion devices shall be designed and operated to reduce the VHAP emissions vented to them with an efficiency of 95 percent or greater, or to an exit concentration of 20 parts per million by volume, on a dry basis, corrected to 3 percent oxygen, whichever is less stringent, or to provide a minimum residence time of 0.50 seconds at a minimum temperature of 760 °C [Reg.19.304 and 40 C.F.R. § 61.242-11 (c)]
 - d. Flares used to comply with this subpart shall comply with the requirements of § 60.18. [Reg.19.304 and 40 C.F.R. § 61.242-11(d)]
 - e. Owners or operators of control devices used to comply with the provisions of this subpart shall monitor these control devices to ensure that they are operated and maintained in conformance with their designs. [Reg.19.304 and 40 C.F.R. § 61.242-11 (e)]
 - f. Except as provided in paragraphs (i) through (k) of this section, each closed vent system shall be inspected according to the procedures and schedule specified in paragraph (f)(1) or (2) of this section, as applicable.
 - i. If the vapor collection system or closed vent system is constructed of hard-piping, the owner or operator shall comply with the following requirements:
 - 1. Conduct an initial inspection according to the procedures in § 61.245(b); and
 - 2. Conduct annual visual inspections for visible, audible, or olfactory indications of leaks.
 - ii. If the vapor collection system or closed vent system is constructed of ductwork, the owner or operator shall:
 - 1. Conduct an initial inspection according to the procedures in § 61.245(b); and
 - 2. Conduct annual inspections according to the procedures in § 61.245(b).
- [Reg.19.304 and 40 C.F.R. § 61.242-11(f)(1&2)]
- g. Leaks, as indicated by an instrument reading greater than 500 parts per million by volume above background or by visual inspections, shall be repaired as soon as practicable except as provided in paragraph (h) of this section.
 - i. A first attempt at repair shall be made no later than 5 calendar days after the leak is detected.
 - ii. Repair shall be completed no later than 15 calendar days after the leak is detected.

[Reg.19.304 and 40 C.F.R. § 61.242-11(g)(1&2)]

- h. Delay of repair of a closed vent system for which leaks have been detected is allowed if the repair is technically infeasible without a process unit shutdown or if the owner or operator determines that emissions resulting from immediate repair would be greater than the fugitive emissions likely to result from delay of repair. Repair of such equipment shall be complete by the end of the next process unit shutdown. [Reg.19.304 and 40 C.F.R. § 61.242-11(h)]
- i. If a vapor collection system or closed vent system is operated under a vacuum, it is exempt from the inspection requirements of paragraphs (f)(1)(i) and (f)(2) of this section. [Reg.19.304 and 40 C.F.R. § 61.242-11(i)]
- j. Any parts of the closed vent system that are designated, as described in paragraph (l)(1) of this section, as unsafe-to-inspect are exempt from the inspection requirements of paragraphs (f)(1)(i) and (2) of this section if they comply with the following requirements:
 - i. The owner or operator determines that the equipment is unsafe to inspect because inspecting personnel would be exposed to an imminent or potential danger as a consequence of complying with paragraphs (f)(1)(i) or (f)(2) of this section; and
 - ii. The owner or operator has a written plan that requires inspection of the equipment as frequently as practicable during safe-to-inspect times.[Reg.19.304 and 40 C.F.R. § 61.242-11(j)(1&2)]
- k. Any parts of the closed vent system that are designated, as described in paragraph (l)(2) of this section, as difficult-to-inspect are exempt from the inspection requirements of paragraphs (f)(1)(i) and (2) of this section if they comply with the following requirements:
 - i. The owner or operator determines that the equipment cannot be inspected without elevating the inspecting personnel more than 2 meters above a support surface; and
 - ii. The owner or operator has a written plan that requires inspection of the equipment at least once every 5 years. A closed vent system is exempt from inspection if it is operated under a vacuum.[Reg.19.304 and 40 C.F.R. § 61.242-11(k)(1-3)]
- l. The owner or operator shall record the following information:
 - i. Identification of all parts of the closed vent system that are designated as unsafe to inspect, an explanation of why the equipment is unsafe to inspect, and the plan for inspecting the equipment.
 - ii. Identification of all parts of the closed vent system that are designated as difficult to inspect, an explanation of why the equipment is difficult to inspect, and the plan for inspecting the equipment.

- iii. For each inspection during which a leak is detected, a record of the information specified in § 61.246(c).
- iv. For each inspection conducted in accordance with § 61.245(b) during which no leaks are detected, a record that the inspection was performed, the date of the inspection, and a statement that no leaks were detected.
- v. For each visual inspection conducted in accordance with paragraph (f)(1)(ii) of this section during which no leaks are detected, a record that the inspection was performed, the date of the inspection, and a statement that no leaks were detected.

[Reg.19.304 and 40 C.F.R. § 61.242-11(l)(1-5)]

- m. Closed vent systems and control devices used to comply with provisions of this subpart shall be operated at all times when emissions may be vented to them.

[Reg.19.304 and 40 C.F.R. § 61.242-11(m)]

Alternative standards for valves—allowable percentage of valves leaking

IB 26. The permittee may comply with the following alternative standards for leaking valves:

- a. An owner or operator may elect to have all valves within a process unit to comply with an allowable percentage of valves leaking of equal to or less than 2.0 percent. [Reg.19.304 and 40 C.F.R. § 61.243-1 (a)]
- b. The following requirements shall be met if an owner or operator decides to comply with an allowable percentage of valves leaking:
 - i. An owner or operator must notify the Administrator that the owner or operator has elected to have all valves within a process unit to comply with the allowable percentage of valves leaking before implementing this alternative standard, as specified in § 61.247(d).
 - ii. A performance test as specified in paragraph (c) of this section shall be conducted initially upon designation, annually, and at other times requested by the Administrator.
 - iii. If a valve leak is detected, it shall be repaired in accordance with § 61.242-7(d) and (e).

[Reg.19.304 and 40 C.F.R. § 61.243-1(b)(1-3)]

- c. Performance tests shall be conducted in the following manner:
 - i. All valves in VHAP service within the process unit shall be monitored within 1 week by the methods specified in § 61.245(b).
 - ii. If an instrument reading of 10,000 ppm or greater is measured, a leak is detected.
 - iii. The leak percentage shall be determined by dividing the number of valves in VHAP service for which leaks are detected by the number of valves in VHAP service within the process unit.

[Reg.19.304 and 40 C.F.R. § 61.243-1 (c)(1-3)]

- d. Owner or operators who elect to have all valves comply with this alternative standard shall not have a process unit with a leak percentage greater than 2.0 percent. [Reg.19.304 and 40 C.F.R. § 61.243-1 (d)]
- e. If an owner or operator decides no longer to comply with § 61.243-1, the owner or operator must notify the Administrator in writing that the work practice standard described in § 61.242-7(a)-(e) will be followed. [Reg.19.304 and 40 C.F.R. § 61.243-1 (e)]

Alternative standards for valves—skip period leak detection and repair

IB 27. The following requirements apply as alternative standards for valves—skip period leak detection and repair:

- a. An owner or operator may elect to comply with one of the alternative work practices specified in paragraphs (b)(2) and (3) of this section. [Reg.19.304 and 40 C.F.R. § 61.243-2 (a)(1)]
- b. An owner or operator must notify the Administrator before implementing one of the alternative work practices, as specified in § 61.247(d). [Reg.19.304 and 40 C.F.R. § 61.243-2 (a)(2)]
- c. An owner or operator shall:
 - i. An owner or operator shall comply initially with the requirements for valves, as described in § 61.242-7.
 - ii. After 2 consecutive quarterly leak detection periods with the percentage of valves leaking equal to or less than 2.0, an owner or operator may begin to skip one of the quarterly leak detection periods for the valves in VHAP service.
 - iii. After five consecutive quarterly leak detection periods with the percentage of valves leaking equal to or less than 2.0, an owner or operator may begin to skip three of the quarterly leak detection periods for the valves in VHAP service.
 - iv. If the percentage of valves leaking is greater than 2.0, the owner or operator shall comply with the requirements as described in § 61.242-7 but may again elect to use this section.

[Reg.19.304 and 40 C.F.R. § 61.243-2 (b)(1-4)]

Alternative means of emission limitation

IB 28. The permittee shall comply with the following alternative means of emission limitation:

- a. Permission to use an alternative means of emission limitation under section 112(e)(3) of the Clean Air Act shall be governed by the following procedures (b) through (f) of this section. [Reg.19.304 and 40 C.F.R. § 61.244(a)]
- b. Where the standard is an equipment, design, or operational requirement:

- i. Each owner or operator applying for permission shall be responsible for collecting and verifying test data for an alternative means of emission limitation to test data for the equipment, design, and operational requirements.
- ii. The Administrator may condition the permission on requirements that may be necessary to assure operation and maintenance to achieve the same emission reduction as the equipment, design, and operational requirements.

[Reg.19.304 and 40 C.F.R. § 61.244(b)(1&2)]

c. Where the standard is a work practice:

- i. Each owner or operator applying for permission shall be responsible for collecting and verifying test data for an alternative means of emission limitation.
- ii. For each source for which permission is requested, the emission reduction achieved by the required work practices shall be demonstrated for a minimum period of 12 months.
- iii. For each source for which permission is requested, the emission reduction achieved by the alternative means of emission limitation shall be demonstrated.
- iv. Each owner or operator applying for permission shall commit in writing each source to work practices that provide for emission reductions equal to or greater than the emission reductions achieved by the required work practices.
- v. The Administrator will compare the demonstrated emission reduction for the alternative means of emission limitation to the demonstrated emission reduction for the required work practices and will consider the commitment in paragraph (c)(4).
- vi. The Administrator may condition the permission on requirements that may be necessary to assure operation and maintenance to achieve the same emission reduction as the required work practices of this subpart.

[Reg.19.304 and 40 C.F.R. § 61.244(c)(1-6)]

- d. An owner or operator may offer a unique approach to demonstrate the alternative means of emission limitation. [Reg.19.304 and 40 C.F.R. § 61.244(d)]
- e. Manufacturers of equipment used to control equipment leaks of a VHAP may apply to the Administrator for permission for an alternative means of emission limitation that achieves a reduction in emissions of the VHAP achieved by the equipment, design, and operational requirements of this subpart. [Reg.19.304 and 40 C.F.R. § 61.244(e)(1)]

- f. The Administrator will grant permission according to the provisions of paragraphs (b), (c), and (d). [Reg.19.304 and 40 C.F.R. § 61.244(e)(2)]

Test methods and procedures

IB 29. The permittee shall conduct performance testing in accordance with the provisions of this section.

- a. Monitoring, as required in §§ 61.242, 61.243, 61.244, and 61.135, shall comply with the following requirements.
- i. Monitoring shall comply with Method 21 of appendix A of 40 CFR part 60.
 - ii. The detection instrument shall meet the performance criteria of Method 21.
 - iii. The instrument shall be calibrated before use on each day of its use by the procedures specified in Method 21.
 - iv. Calibration gases shall be:
 1. Zero air (less than 10 ppm of hydrocarbon in air); and
 2. A mixture of methane or n-hexane and air at a concentration of about, but less than, 10,000 ppm methane or n-hexane.
 - v. The instrument probe shall be traversed around all potential leak interfaces as close to the interface as possible as described in Method 21.

[Reg.19.304 and 40 C.F.R. § 61.245(b)(1-5)]

- b. When equipment is tested for compliance with or monitored for no detectable emissions, the owner or operator shall comply with the following requirements:
- i. The requirements of paragraphs (b) (1) through (4) shall apply.
 - ii. The background level shall be determined, as set forth in Method 21.
 - iii. The instrument probe shall be traversed around all potential leak interfaces as close to the interface as possible as described in Method 21.
 - iv. The arithmetic difference between the maximum concentration indicated by the instrument and the background level is compared with 500 ppm for determining compliance.

[Reg.19.304 and 40 C.F.R. § 61.245 (c)(1-4)]

- c. Each piece of equipment within a process unit that can conceivably contain equipment in VHAP service is presumed to be in VHAP service unless an owner or operator demonstrates that the piece of equipment is not in VHAP service. For a piece of equipment to be considered not in VHAP service, it must be determined that the percent VHAP content can be reasonably expected never to exceed 10 percent by weight. For purposes of determining the percent VHAP content of the process fluid that is contained in or contacts equipment, procedures that conform to the methods described in ASTM Method D-2267 (incorporated by the reference as specified in § 61.18) shall be used.
- i. An owner or operator may use engineering judgment rather than the procedures in paragraph (d)(1) of this section to demonstrate that the percent VHAP content does not exceed 10 percent by weight, provided that the engineering judgment demonstrates that the VHAP content clearly does not exceed 10 percent by weight. When an owner or operator and the Administrator do not agree on whether a piece of equipment is not in VHAP service, however, the procedures in paragraph (d)(1) of this section shall be used to resolve the disagreement.
 - ii. If an owner or operator determines that a piece of equipment is in VHAP service, the determination can be revised only after following the procedures in paragraph (d)(1) of this section.
 - iii. Samples used in determining the percent VHAP content shall be representative of the process fluid that is contained in or contacts the equipment or the gas being combusted in the flare.

[Reg.19.304 and 40 C.F.R. § 61.245 (d)(1-3)]

- d. The owner or operator shall determine compliance with the standards of flares as follows:
- i. Method 22 shall be used to determine visible emissions.
 - ii. A thermocouple or any other equivalent device shall be used to monitor the presence of a pilot flame in the flare.
 - iii. The net heating value (H_T) of the gas being combusted in a flare shall be computed using the following equation:

$$H_T = K \sum_{i=1}^n C_i H_i$$

Where:

K = conversion constant, 1.740×10^7 (g-mole) (MJ)/(ppm-scm-kcal) (metric units); or 4.674×10^8 ((g-mole) (Btu)/(ppm-scf-kcal)) (English units)

C_i = Concentration of sample component “i” in ppm, as measured by Method 18 of appendix A to 40 CFR part 60 and ASTM D2504-67, 77, or 88 (Reapproved 1993) (incorporated by reference as specified in § 61.18). H_r = Net heating value of the sample, MJ/scm (BTU/scf); where the net enthalpy per mole of offgas is based on combustion at 25 °C and 760 mm Hg (77 °F and 14.7 psi), but the standard temperature for determining the volume corresponding to one mole is 20 °C (68 °F).

- iv. The actual exit velocity of a flare shall be determined by dividing the volumetric flowrate (in units of standard temperature and pressure), as determined by Method 2, 2A, 2C, or 2D, as appropriate, by the unobstructed (free) cross section area of the flare tip.
- v. The maximum permitted velocity for air assisted flares shall be computed using the following equation:

$$V_{\max} = K_1 + K_2 H_r$$

Where:

V_{\max} = Maximum permitted velocity, m/sec (ft/sec)

H_r = Net heating value of the gas being combusted, MJ/scm (Btu/scf).

K_1 = 8.706 m/sec (metric units)

= 28.56 ft/sec (English units)

K_2 = 0.7084 m^{1/2}/(MJ-sec) (metric units)

= 0.087 ft^{1/2}/(Btu-sec) (English units)

[Reg.19.304 and 40 C.F.R. § 61.245 (e)(1-5)]

Recordkeeping requirements

IB 30. The permittee shall show compliance with the recordkeeping requirements of this subpart. [Reg.19.304 and 40 C.F.R. § 61.246(a)(1)]

- a. An owner or operator of more than one process unit subject to the provisions of this subpart may comply with the recordkeeping requirements for these process units in one recordkeeping system if the system identifies each record by each process unit. [Reg.19.304 and 40 C.F.R. § 61.246 (a)(2)]
- b. When each leak is detected as specified in §§ 61.242-2, 61.242-3, 61.242-7, 61.242-8, and 61.135, the following requirements apply:
 - i. A weatherproof and readily visible identification, marked with the equipment identification number, shall be attached to the leaking equipment.
 - ii. The identification on a valve may be removed after it has been monitored for 2 successive months as specified in § 61.242-7(c) and no leak has been detected during those 2 months

- iii. The identification on equipment except on a valve, may be removed after it has been repaired.

[Reg.19.304 and 40 C.F.R. § 61.246 (b)(1-3)]

- c. When each leak is detected as specified in §§ 61.242-2, 61.242-3, 61.242-7, 61.242-8, and 61.135, the following information shall be recorded in a log and shall be kept for 2 years in a readily accessible location:
 - i. The instrument and operator identification numbers and the equipment identification number.
 - ii. The date the leak was detected and the dates of each attempt to repair the leak.
 - iii. Repair methods applied in each attempt to repair the leak.
 - iv. “Above 10,000” if the maximum instrument reading measured by the methods specified in § 61.245(a) after each repair attempt is equal to or greater than 10,000 ppm.
 - v. “Repair delayed” and the reason for the delay if a leak is not repaired within 15 calendar days after discovery of the leak.
 - vi. The signature of the owner or operator (or designate) whose decision it was that repair could not be effected without a process shutdown.
 - vii. The expected date of successful repair of the leak if a leak is not repaired within 15 days.
 - viii. Dates of process unit shutdowns that occur while the equipment is unrepaired.
 - ix. The date of successful repair of the leak.

[Reg.19.304 and 40 C.F.R. § 61.246(c)(1-9)]

- d. The following information pertaining to the design requirements for closed-vent systems and control devices described in § 61.242-11 shall be recorded and kept in a readily accessible location:
 - i. Detailed schematics, design specifications, and piping and instrumentation diagrams.
 - ii. The dates and descriptions of any changes in the design specifications.
 - iii. A description of the parameter or parameters monitored, as required in § 61.242-11(e), to ensure that control devices are operated and maintained in conformance with their design and an explanation of why that parameter (or parameters) was selected for the monitoring.
 - iv. Periods when the closed-vent systems and control devices required in §§ 61.242-2, 61.242-3, 61.242-4, 61.242-5 and 61.242-9 are not operated as designed, including periods when a flare pilot light does not have a flame.

- v. Dates of startups and shutdowns of the closed-vent systems and control devices required in §§ 61.242-2, 61.242-3, 61.242-4, 61.242-5 and 61.242-9.

[Reg.19.304 and 40 C.F.R. § 61.246(d)(1-5)]

- e. The following information pertaining to all equipment to which a standard applies shall be recorded in a log that is kept in a readily accessible location:
 - i. A list of identification numbers for equipment subject to the requirements of this subpart. 2)(i) A list of identification numbers for equipment that the owner or operator elects to designate for no detectable emissions as indicated by an instrument reading of less than 500 ppm above background.
 - ii. The designation of this equipment for no detectable emissions shall be signed by the owner or operator.
 - iii. A list of equipment identification numbers for pressure relief devices required to comply with § 61.242-4(a).
 - iv. The dates of each compliance test required in §§ 61.242-2(e), 61.242-3(i), 61.242-4, 61.242-7(f), and 61.135(g).
 - v. The background level measured during each compliance test.
 - vi. The maximum instrument reading measured at the equipment during each compliance test.
 - vii. A list of identification numbers for equipment in vacuum service.

[Reg.19.304 and 40 C.F.R. § 61.246 (e)(1-5)]

- f. The following information pertaining to all valves subject to the requirements of § 61.242-7(g) and (h) and to all pumps subject to the requirements of § 61.242-2(g) shall be recorded in a log that is kept in a readily accessible location:
 - i. A list of identification numbers for valves and pumps that are designated as unsafe-to-monitor, an explanation for each valve or pump stating why the valve or pump is unsafe-to-monitor, and the plan for monitoring each valve or pump.
 - ii. A list of identification numbers for valves that are designated as difficult-to-monitor, an explanation for each valve stating why the valve is difficult-to-monitor, and the schedule for monitoring each valve.

[Reg.19.304 and 40 C.F.R. § 61.246 (f)(1&2)]

- g. The following information shall be recorded for valves complying with § 61.243-2:
 - i. A schedule of monitoring.
 - ii. The percent of valves found leaking during each monitoring period.

[Reg.19.304 and 40 C.F.R. § 61.246 (g)(1&2)]

- h. The following information shall be recorded in a log that is kept in a readily accessible location:
 - i. Design criterion required in §§ 61.242-2(d)(5), 61.242-3(e)(2), and 61.135(e)(4) and an explanation of the design criterion; and
 - ii. Any changes to this criterion and the reasons for the changes.

[Reg.19.304 and 40 C.F.R. § 61.246 (h)(1&2)]

- i. The following information shall be recorded in a log that is kept in a readily accessible location for use in determining exemptions as provided in the applicability section of this subpart and other specific subparts:
 - i. An analysis demonstrating the design capacity of the affected facility,
 - ii. A statement listing the feed or raw materials and products from the affected facilities and an analysis demonstrating whether these chemicals are heavy liquids or beverage alcohol, and
 - iii. An analysis demonstrating that equipment is not in VHAP service.

[Reg.19.304 and 40 C.F.R. § 61.246 (i)(1-3)]

- j. Information and data used to demonstrate that a piece of equipment is not in VHAP service shall be recorded in a log that is kept in a readily accessible location [40 CFR §§61.246 (j)]

Reporting requirements

IB 31. The permittee shall comply with the reporting requirements of this section. [Reg.19.304 and 40 C.F.R. § 61.247]

- a. An owner or operator of any piece of equipment to which this subpart applies shall
 - i. Submit a statement in writing notifying the Administrator that the requirements of §§ 61.242, 61.245, 61.246, and 61.247 are being implemented.
 - ii. In the case of an existing source or a new source which has an initial startup date preceding the effective date, the statement is to be submitted within 90 days of the effective date, unless a waiver of compliance is granted under § 61.11, along with the information required under § 61.10. If a waiver of compliance is granted, the statement is to be submitted on a date scheduled by the Administrator.
 - iii. In the case of new sources which did not have an initial startup date preceding December 14, 2000, the statement required under paragraph (a)(1) of this section shall be submitted with the application for approval of construction, as described in § 61.07.

- iv. For owners and operators complying with 40 CFR part 65, subpart C or F, the statement required under paragraph (a)(1) of this section shall notify the Administrator that the requirements of 40 CFR part 65, subpart C or F, are being implemented.
- v. The statement is to contain the following information for each source:
 - 1. Equipment identification number and process unit identification.
 - 2. Type of equipment (for example, a pump or pipeline valve).
 - 3. Percent by weight VHAP in the fluid at the equipment.
 - 4. Process fluid state at the equipment (gas/vapor or liquid).
 - 5. Method of compliance with the standard (for example, “monthly leak detection and repair” or “equipped with dual mechanical seals”).

[Reg.19.304 and 40 C.F.R. § 61.247 (a)(1-5)]

- b. A report shall be submitted to the Administrator semiannually starting 6 months after the initial report required in paragraph (a) of this section, that includes the following information:
 - i. Process unit identification.
 - ii. For each month during the semiannual reporting period:
 - 1. Number of valves for which leaks were detected as described in § 61.242-7(b) of § 61.243-2.
 - 2. Number of valves for which leaks were not repaired as required in § 61.242-7(d).
 - 3. Number of pumps for which leaks were detected as described in § 61.242-2 (b) and (d)(6).
 - 4. Number of pumps for which leaks were not repaired as required in § 61.242-2 (c) and (d)(6).
 - 5. Number of compressors for which leaks were detected as described in § 61.242-3(f).
 - 6. Number of compressors for which leaks were not repaired as required in § 61.242-3(g).
 - 7. The facts that explain any delay of repairs and, where appropriate, why a process unit shutdown was technically infeasible.
 - iii. Dates of process unit shutdowns which occurred within the semiannual reporting period.

- iv. Revisions to items reported according to paragraph (a) if changes have occurred since the initial report or subsequent revisions to the initial report. NOTE: Compliance with the requirements of § 61.10(c) is not required for revisions documented under this paragraph.
- v. The results of all performance tests and monitoring to determine compliance with no detectable emissions and with §§ 61.243-1 and 61.243-2 conducted within the semiannual reporting period.

[Reg.19.304 and 40 C.F.R. § 61.247 (b)(1-5)]

- c. In the first report submitted as required in paragraph (a) of this section, the report shall include a reporting schedule stating the months that semiannual reports shall be submitted. Subsequent reports shall be submitted according to that schedule, unless a revised schedule has been submitted in a previous semiannual report.
[Reg.19.304 and 40 C.F.R. § 61.247 (c)]
- d. An owner or operator electing to comply with the provisions of §§ 61.243-1 and 61.243-2 shall notify the Administrator of the alternative standard selected 90 days before implementing either of the provisions. [Reg.19.304 and 40 C.F.R. § 61.247 (d)]
- e. An application for approval of construction or modification, §§ 61.05(a) and 61.07, will not be required if—
 - i. (1) The new source complies with the standard, § 61.242;
 - ii. (2) The new source is not part of the construction of a process unit; and
 - iii. (3) In the next semiannual report required by paragraph (b) of this section, the information in paragraph (a)(5) of this section is reported.

[Reg.19.304 and 40 C.F.R. § 61.247 (e)]

- f. For owners or operators choosing to comply with 40 CFR part 65, subpart C or F, an application for approval of construction or modification, as required under §§ 61.05 and 61.07 will not be required if:
 - i. The new source complies with 40 CFR 65.106 through 65.115 and with 40 CFR part 65, subpart C, for surge control vessels and bottoms receivers;
 - ii. The new source is not part of the construction of a process unit; and
 - iii. In the next semiannual report required by 40 CFR 65.120(b) and 65.48(b), the information in paragraph (a)(5) of this section is reported.

[40 CFR§61.247 (f)(1-3)]

40 CFR Part 61 Subpart J – National Emission Standard for Equipment Leaks (Fugitive Emission Sources of Benzene)

- IB 32. The permittee shall comply with all applicable requirements in 40 CFR Part 61, Subpart J and Subpart V at all applicable sources in the DIPB process. The provisions of this subpart apply to each of the following sources that are intended to operate in benzene service: pumps, compressors, pressure relief devices, sampling connection systems, open-ended lines, valves, flanges, and other connectors, product accumulator vessels, and control devices or systems required by these subparts. [Reg.19.304 and 40 C.F.R. § 61, Subpart J and Subpart V]
- IB 33. NESHAP J – National Emission Standard for Equipment Leaks (Fugitive Emission Sources of Benzene), applies to equipment in benzene service including: pumps, valves, flanges, compressors, pressure relief devices, sampling connections, open-ended valves or lines, other connectors, product accumulation vessels, and control devices or systems required by the subpart. [Reg.19.304 and 40 C.F.R. § 61.110(a)]
- IB 34. Each owner or operator subject to the provisions of this subpart shall comply with the provisions of NESHAP, Subpart V. [Reg.19.304 and 40 C.F.R. § 61.112(a)]
- IB 35. The owner/operator may elect to comply with the provisions of 61.243-1 and 61.243-2. [Reg.19.304 and 40 C.F.R. § 61.112(b)]
- IB 36. The permittee shall comply with all applicable parts of sections §61.240 through §61.247. [Reg.19.304 and 40 C.F.R. § 61.240 through §61.247]

40 CFR Part 61 Subpart Y - National Emission Standard for Benzene Storage Vessels

- IB 37. NESHAP Y – National Emission Standard for Benzene Storage Vessels, defines applicability and designation of sources and defines exemptions. The condition applies to Tank T-210 which is vent to the DIPB flare (5N03-54). [Reg.19.304 and 40 C.F.R. § 61.270]
- IB 38. The storage vessel shall be equipped with a closed vent system and flare control device meeting the specifications of §61.271(d). [Reg.19.304 and 40 C.F.R. § 61.271(c)]
- IB 39. The closed vent system and flare shall meet the requirements as specified for general control devices in 40 CFR §60.18(e) and (f). [Reg.19.304 and 40 C.F.R. § 61.271(d)]
- IB 40. The specifications and requirements of §61.271(c)(1) and (2) do not apply during a control system malfunction. [Reg.19.304 and 40 C.F.R. § 61.271(c)(4)]
- IB 41. Excess emissions shall be reported as specified in §61.275(e). [40 CFR Part §61.275(e)]
- IB 42. The owner/operator shall keep copies of all reports and records required by §61.276(a). [Reg.19.304 and 40 C.F.R. § 61.276(a)]
- IB 43. The permittee shall keep readily assessable records showing the dimensions of the storage vessel and an analysis of the capacity. Each storage vessel with a design capacity of less than 10,000 gallons is subject to no provisions of this subpart other than this requirement. [Reg.19.304 and 40 C.F.R. § 61.276(b)]

Storage Tanks and Miscellaneous Sources
5N03TK-01, 6N01-02, and 6N01-03

Source Description

FutureFuel Chemical Company is a manufacturer of organic chemical intermediates. The primary business opportunities for this facility are producing chemicals that are put into the marketplace quickly. Many different chemicals can be manufactured; therefore many tanks are needed for raw material, intermediate, and product storage. Emissions from storage tanks that vent to the atmosphere and other miscellaneous sources are identified in the STMS section of the permit. With the exception of a fume scrubber TF-5FS on TF-5, there are no specific controls on these tanks other than conservation vents.

Source Number	TANK ID	AREA	Applicable Federal Regulation
5N01-41	TF-7	BULK	
5N03-39	TF-10	BULK	
5N03-45	TF-12	BULK	
5N01-27	TFV-4	BULK	
5N01-23	TFV-5	BULK	
5N01-26	TFV-6	BULK	
5N01-34	TFS-5	BULK	
5N01-37	TFS-10	BULK	
5N03-64	TFS-79	BULK	
5N01-48	WG-1	UTILITIES	
5N01-49	CG-1	UTILITIES	
4P94-12	PR-56A	4P-99	
4P94-13	PR-56B	4P-99	
4Q01-10	T-242	4Q	NSPS Kb
4Q01-11	T-243	4Q	NSPS Kb
4Q01-01	TFB-1	4Q	
4Q01-02	TFB-22	4Q	
4Q01-03	TFB-10	4Q	
4Q01-04	TFB-11	4Q	
4Q01-05	TFB-12	4Q	
4Q01-06	TFB-20	4Q	
4Q01-07	TFB-21	4Q	
4Q01-08	TFB-30	4Q	
4Q01-09	TFB-31	4Q	
5N01-36	TFS-7	BULK	
5N01-38	TFS-9	BULK	
5N03-18	PBV-50	DIPB	

Source Number	TANK ID	AREA	Applicable Federal Regulation
5N01-42	TF-6	BULK	
5N03-50	PA-50	5P-99	
5N03-40	TF-11	BULK	
5N01-32	TFS-1	BULK	
5N01-31	TFS-2	BULK	
5Q99-01	T-273	5Q	
5N01-33	TFS-6	BULK	
5N03-38	TF-8	BULK	
5P94-01	TF-5FS	BULK	NESHAP FFFF (MON MACT)

Specific Conditions

STMS 1. The permittee shall not exceed the emission rates set forth in the following table. These rates are based on maximum physical capacity of the equipment and Specific Condition STMS 3. [Reg.19.501 *et seq.* and 40 C.F.R. § 52 Subpart E]

SN	Description	Pollutant	lb/hr
6N01-02	Diesel Tank	VOC	0.1
6N01-03	Gas Tank	VOC	200
5N03TK-01	Process Tanks (36 Tanks)	VOC	4.0

STMS 2. The permittee shall not exceed the emission rates set forth in the following table. The facility shall show compliance with the facility total ton/yr limits using the procedures outlined in PW 11 through PW 15. Hourly Plantwide Hazardous Air Pollutant emissions are limited by PW 15. Additional HAP limitations are included in PW 12. [Reg.18.801 and Ark. Code Ann. § 8-4-203 as referenced by Ark. Code Ann. §§ 8-4-304 and 8-4-311]

SN	Description	Pollutant	lb/hr
6N01-02	Diesel Tank	Organic Pollutants**	***
6N01-03	Gas Tank	Organic Pollutants**	***
5N03TK-01	Process Tanks (36 Tanks)	Organic Pollutants** Inorganic Pollutants*	*** 0.3

*Inorganics are considered to be non-organic Hazardous Air Pollutants

**Organic Pollutants are considered to be VOC, all organic HAPs, and organic Air Contaminates.

***Limited by Plantwide Condition 12.

FutureFuel Chemical Company

Permit #: 1085-AOP-R16

AFIN: 32-00036

- STMS 3. Emissions from Storage Tanks and Misc. Sources areas shall be recalculated monthly, and shall be based upon a 12-month rolling total. The records shall be updated by the last day of the month following the recorded 12-month period, and shall be kept on site and made available for inspection upon request. [Reg.19.705 and 40 C.F.R. § 52 Subpart E, and Reg.18.1004 and Ark. Code Ann. § 8-4-203 as referenced by Ark. Code Ann. §§ 8-4-304 and 8-4-311]

5N07 Production Facility

Source Description

The 5N07 production facility contains multi-purpose production equipment which may produce a variety of chemicals including biofuel. Biodiesel is the primary product from this facility. The contained or captured vapors from the equipment in this facility are vented through a collection system to the RTO (SN 5N09-01) units via a common duct. VOCs are destroyed by combustion.

Fugitive emissions are estimated based on components, monitoring data, and published emission leak factors. Fugitive emissions are designated as source OCI-FUG.

Biodiesel Washing

The reaction mixture from the Biodiesel production facilities is fed continuously to equipment where methanol, the catalyst and glycerin are removed by washing with water. After most of the water is removed, the washed Biodiesel flows to the Biodiesel Drying equipment. The used water streams flow to Methanol Recovery and Glycerin Recovery equipment.

Biodiesel Drying

Residual water and methanol are removed from the Biodiesel using heat. Vacuum is applied if needed. The dry Biodiesel is cooled and sent to storage.

Biodiesel Storage

Product from the Biodiesel Drying equipment flows to accumulation tanks. When an accumulation tank fills the contents are analyzed prior to transferring to sales tanks. Product from the sales tanks is loaded into tank trucks or railcars for sale.

Methanol Recovery and Storage

Emissions from methanol tank T-242 are accounted for in tank bubble 5N03TK-01. Methanol-containing streams from the Biodiesel reactors and the aqueous stream from the Biodiesel Washing equipment are fed to the Methanol Recovery and Storage equipment. Methanol is separated from the other components (primarily water and glycerin) by distillation. The methanol is stored for recycle to the biodiesel reactors.

Glycerin Recovery and Storage

Glycerin is recovered and refined in the 4P (Solvent Recovery) production area. Glycerin streams from the Biodiesel reactors and the aqueous stream from the Biodiesel Washing equipment are fed to the Glycerin Recovery and Storage equipment. Methanol is separated from the glycerin by distillation and the glycerin is further refined to improve purity.

Specific Conditions

- BD 1. The permittee shall not exceed the emission rates set forth in the following table. The permittee shall demonstrate compliance with this condition by BD 3. [Reg.19.501 *et seq.* and 40 C.F.R. § 52 Subpart E]

PES #	Description	Pollutant	lb/hr
5N07	Biodiesel Production	VOC	2.9

BD 2. The permittee shall not exceed the emission rates set forth in the following table. The permittee shall demonstrate compliance with this condition by BD 3. The facility shall show compliance with the facility total ton/yr limits using the procedures outlined in PW 11 through PW 15. Hourly Plantwide Hazardous Air Pollutant emissions are limited by PW 15. Additional HAP limitations are included in PW 12. [Reg.18.801 and Ark. Code Ann. § 8-4-203 as referenced by Ark. Code Ann. §§ 8-4-304 and 8-4-311]

PES #	Description	Pollutant	lb/hr
5N07	Biodiesel Production	Organic Pollutants**	***

**Organic Pollutants are considered to be VOC, all organic HAPs, and organic Air Contaminates.
 ***Limited by Plantwide Condition 12.

BD 3. The permittee is limited to 250 million gallons of biodiesel production. [Reg.18.1004 and Ark. Code Ann. § 8-4-203 as referenced by Ark. Code Ann. §§ 8-4-304 and 8-4-311]

BD 4. The permittee shall maintain records to demonstrate compliance with the limits in BD 3. Emissions from biodiesel production shall be recalculated monthly, and shall be based upon a 12-month rolling total. The records shall be updated by the last day of the month following the recorded 12-month period, and shall be kept on site and made available for inspection upon request. [Reg.19.705 and 40 C.F.R. § 52 Subpart E and Reg.18.1004 and Ark. Code Ann. § 8-4-203 as referenced by Ark. Code Ann. §§ 8-4-304 and 8-4-311]

Aldehyde Processing Section
4P05-01, 4P05-02, 4P05-03, 4PSR-FUG

Source Description

Raw materials are unloaded into storage tanks T-271, T-272, and TFS-75. TFS-75 vents to the RTO. Raw materials are transferred to the process as needed. Both columns and tanks vent to the RTOs (5N09-01).

The aldehyde process reactors are periodically cleaned and the vent gas is routed to a water scrubber, SV-03. The vent stream from this source discharges to the RTO. The water stream is routed to the wastewater treatment facilities. The reactors are heated with two 5 MMBTU/hr hot oil system, SN 4P05-01 and SN 4P05-03. The hot oil system SN 4P05-01 is designed to burn natural gas, fuel oil, biodiesel, and process vent streams. Hot oil system SN 4P05-03 is designed to burn natural gas and process vent streams.

Products are refined in distillation column SB-02 and extraction column SX-03. The distillation column and the extraction column both vent back to the hot oil system or the RTOs. The refined product is transferred to three lot tanks, VC-PT-01, VC-PT-02, and VC-PT-03. These tanks are equipped with vapor balancing and do not vent to the atmosphere. VC-ST-01 shutdown tank vents to the hot oil system for thermal recovery and is not an emission source itself. Tank WDT-03, a waste tank, is located in the Utilities section and is connected to the coal-fired boiler closed vent system and control device. VC-PT-03, VC-PT-01, and VC-PT-02 are all subject to NSPS Kb.

The emission points for the Aldehyde Processing Section are the hot oil system (4P05-01), hot oil system (4P05-03), equipment fugitives (4PSR-FUG), and the RTO (5N09-01).

Specific Conditions

- AP 1. The permittee shall not exceed the emission rates set forth in the following table. The permittee shall demonstrate compliance with this condition by AP 3. [Reg.19.501 *et seq.* and 40 C.F.R. § 52 Subpart E]

SN #	Source Description	Pollutant	lb/hr
4P05-01	Hot Oil System	PM ₁₀	0.2
		SO ₂	1.1
		VOC	4.0
		CO	1.5
		NO _x	3.2
4P05-03	Hot Oil System #2	PM ₁₀	0.2
		SO ₂	0.1
		VOC	0.8
		CO	1.5
		NO _x	0.9

SN #	Source Description	Pollutant	lb/hr
4PSR-FUG	Aldehyde Processing Fugitives	VOC	0.6

AP 2. The permittee shall not exceed the emission rates set forth in the following table. The permittee shall demonstrate compliance with this condition by AP 3. The facility shall show compliance with the facility total ton/yr limits using the procedures outlined in PW 11 through PW 15. Hourly Plantwide Hazardous Air Pollutant emissions are limited by PW 15. Additional HAP limitations are included in PW 12. [Reg.18.801 and Ark. Code Ann. § 8-4-203 as referenced by Ark. Code Ann. §§ 8-4-304 and 8-4-311]

SN #	Source Description	Pollutant	lb/hr
4P05-01	Hot Oil System	PM Organic Pollutants**	0.2 ***
4P05-03	Hot Oil System #2	PM Organic Pollutants**	0.2 ***
4PSR-FUG	Aldehyde Processing Fugitives	Organic Pollutants**	***

**Organic Pollutants are considered to be VOC, all organic HAPs, and organic Air Contaminates.

***Limited by Plantwide Condition 12.

AP 3. The permittee is limited to no more than 75.0 million pounds per year of vinyl compound products from the Aldehyde Processing Section per 12-month rolling total. [Reg.19.705, Ark. Code Ann. § 8-4-203 as referenced by Ark. Code Ann. §§ 8-4-304 and 8-4-311, and 40 C.F.R. § 70.6]

AP 4. Visible emissions from the Hot Oil System shall not exceed 5% opacity except during periods of fuel oil usage for SN 4P05-01, which the permittee is allowed opacity of 20% opacity. [Reg.18.501 and Ark. Code Ann. § 8-4-203 as referenced by Ark. Code Ann. §§ 8-4-304 and 8-4-311]

AP 5. The permittee shall conduct weekly visual inspections for 4P05-01 and 4P05-03, for all fuels except fuel oil, for possible emissions using EPA Method 22 and monthly observations using EPA Method 9. In the event that fuel oil usage exceeds one week at 4P05-01, the permittee shall perform weekly observations of the Hot Oil system using EPA Method 9. The permittee shall record the presence of any excessive visible emissions and the subsequent actions taken to correct the exceedance. [Reg.18.801 and Ark. Code Ann. § 8-4-203 as referenced by Ark. Code Ann. §§ 8-4-304 and 8-4-311]

AP 6. The permittee shall keep monthly records of the amount of vinyl compounds produced via Aldehyde Processing equipment to demonstrate compliance with the limits in Specific Condition AP 3. These records shall be kept onsite and made available upon request. [Reg.19.705, Ark. Code Ann. § 8-4-203 as referenced by Ark. Code Ann. §§ 8-4-304 and 8-4-311, and 40 C.F.R. § 70.6]

- AP 7. The permittee shall maintain a scrubber liquor flow rate in scrubber SV-03 as outlined in most current version of the Facility Operating Plan. [Reg.19.303 and Ark. Code Ann. § 8-4-203 as referenced by Ark. Code Ann. §§ 8-4-304 and 8-4-311]
- AP 8. The permittee shall keep daily records of the liquor flow rate at scrubber SV-03. These records shall be kept on site and made available upon request. [Reg.19.705 and 40 C.F.R. § 52 Subpart E]
- AP 9. The permittee shall equip and maintain the following tanks with the control equipment specified. [Reg.19.303 and Ark. Code Ann. § 8-4-203 as referenced by Ark. Code Ann. §§ 8-4-304 and 8-4-311]

Tank ID	Tank Size (gallons)	Control Device
TFS-51	42,302	RTO (5N09-01)
TFS-75	42,302	RTO (5N09-01)
TF-14	13,250	Vapor Balancing
TF-8	11,845	Vapor Balancing
VC-PT-01	29,660	Hot Oil System (4P05-01)
VC-PT-02	29,660	Hot Oil System (4P05-01)
VC-PT-03	45,000	Hot Oil System (4P05-01)
T-271	24,000	Vapor Balancing
T-272	24,000	Vapor Balancing

40 CFR Part 63 Subpart DDDDD—National Emission Standards for Hazardous Air Pollutants for Major Sources: Industrial, Commercial, and Institutional Boilers and Process Heaters

- AP 10. Source SN-4P05-01 and 4P05-03 are subject to the provisions of 40 CFR Part 63, Subpart DDDDD – National Emission Standards for Hazardous Air Pollutants for Major Sources: Industrial, Commercial, and Institutional Boilers and Process Heaters. The applicable provisions of this subpart include, but are not limited to, the items found in Specific Conditions AP-11 through AP-37. [Reg.19.304 and 40 C.F.R. §§ 63.7480, 63.7485, and 63.7490(a)]
- AP 11. The permittee must meet the requirements in paragraphs (a)(1) through (3) of §63.7500, except as provided in paragraphs (d) and (e) of §63.7500. The permittee must meet these requirements at all times the affected unit is operating, except as provided in paragraph (f) of §63.7500. [Reg.19.304 and 40 C.F.R. § 63.7500(a)]

- AP 12. The permittee must meet each emission limit and work practice standard in Table 3, and 11 through 13 to 40 CFR Part 63, Subpart DDDDD that applies to the permittee's boiler or process heater, for each boiler or process heater at the permittee's source, except as provided under §63.7522. [Reg.19.304 and 40 C.F.R. § 63.7500(a)(1)]
- AP 13. At all times, the permittee must operate and maintain any affected source (as defined in §63.7490), including associated air pollution control equipment and monitoring equipment, in a manner consistent with safety and good air pollution control practices for minimizing emissions. Determination of whether such operation and maintenance procedures are being used will be based on information available to the Administrator that may include, but is not limited to, monitoring results, review of operation and maintenance procedures, review of operation and maintenance records, and inspection of the source. [Reg.19.304 and 40 C.F.R. § 63.7500(a)(3)]
- AP 14. Boilers and process heaters with a heat input capacity of less than or equal to 5 million Btu per hour in the units designed to burn gas 2 (other) fuels subcategory or units designed to burn light liquid fuels subcategory must complete a tune-up every 5 years as specified in §63.7540. [Reg.19.304 and 40 C.F.R. § 63.7500(d)]
- AP 15. Boilers and process heaters in the units designed to burn gas 1 fuels subcategory with a heat input capacity of less than or equal to 5 million Btu per hour must complete a tune-up every 5 years as specified in §63.7540. Boilers and process heaters in the units designed to burn gas 1 fuels subcategory are not subject to the emission limits in Tables 1 and 2 or 11 through 13 to Subpart DDDDD, or the operating limits in Table 4 to Subpart DDDDD. [Reg.19.304 and 40 C.F.R. § 63.7500(e)]
- AP 16. These standards apply at all times the affected unit is operating, except during periods of startup and shutdown during which time the permittee must comply only with Table 3 to Subpart DDDDD. [Reg.19.304 and 40 C.F.R. § 63.7500(f)]
- AP 17. In response to an action to enforce the standards set forth in §63.7500 the permittee may assert an affirmative defense to a claim for civil penalties for violations of such standards that are caused by malfunction, as defined at §63.2. Appropriate penalties may be assessed if the permittee fail to meet the permittee's burden of proving all of the requirements in the affirmative defense. The affirmative defense shall not be available for claims for injunctive relief. [Reg.19.304 and 40 C.F.R. § 63.7501]
- AP 18. The permittee must be in compliance with the emission limits, work practice standards, and operating limits in this subpart. These limits apply to the permittee at all times the affected unit is operating except for the periods noted in §63.7500(f). [Reg.19.304 and 40 C.F.R. § 63.7505(a)]
- AP 19. For existing affected sources (as defined in §63.7490), the permittee must complete the initial compliance demonstration, as specified in paragraphs (a) through (d) of §63.7510, no later than 180 days after the compliance date that is specified for the permittee's

source in §63.7495 and according to the applicable provisions in §63.7(a)(2) as cited in Table 10 to Subpart DDDDD, except as specified in paragraph (j) of §63.7510. The permittee must complete an initial tune-up by following the procedures described in §63.7540(a)(10)(i) through (vi) no later than the compliance date specified in §63.7495, except as specified in paragraph (j) of §63.7510. The permittee must complete the one-time energy assessment specified in Table 3 to Subpart DDDDD no later than the compliance date specified in §63.7495, except as specified in paragraph (j) of §63.7510. [Reg.19.304 and 40 C.F.R. § 63.7510(e)]

- AP 20. If the permittee is required to meet an applicable tune-up work practice standard, the permittee must conduct an annual, biennial, or 5-year performance tune-up according to §63.7540(a)(10), (11), or (12), respectively. Each annual tune-up specified in §63.7540(a)(10) must be no more than 13 months after the previous tune-up. Each biennial tune-up specified in §63.7540(a)(11) must be conducted no more than 25 months after the previous tune-up. Each 5-year tune-up specified in §63.7540(a)(12) must be conducted no more than 61 months after the previous tune-up. For a new or reconstructed affected source (as defined in §63.7490), the first annual, biennial, or 5-year tune-up must be no later than 13 months, 25 months, or 61 months, respectively, after the initial startup of the new or reconstructed affected source. [Reg.19.304 and 40 C.F.R. § 63.7515(d)]
- AP 21. For affected sources (as defined in §63.7490) that have not operated since the previous compliance demonstration and more than one year has passed since the previous compliance demonstration, the permittee must complete the subsequent compliance demonstration, if subject to the emission limits in Tables 1, 2, or 11 through 13 to Subpart DDDDD, no later than 180 days after the re-start of the affected source and according to the applicable provisions in §63.7(a)(2) as cited in Table 10 to Subpart DDDDD. The permittee must complete a subsequent tune-up by following the procedures described in §63.7540(a)(10)(i) through (vi) and the schedule described in §63.7540(a)(13) for units that are not operating at the time of their scheduled tune-up. [Reg.19.304 and 40 C.F.R. § 63.7515(g)]
- AP 22. If the permittee owns or operates an existing unit with a heat input capacity of less than 10 million Btu per hour or a unit in the unit designed to burn gas 1 subcategory, the permittee must submit a signed statement in the Notification of Compliance Status report that indicates that the permittee conducted a tune-up of the unit. [Reg.19.304 and 40 C.F.R. § 63.7530(d)]
- AP 23. The permittee must include with the Notification of Compliance Status a signed certification that the energy assessment was completed according to Table 3 to Subpart DDDDD and is an accurate depiction of the permittee's facility at the time of the assessment. [Reg.19.304 and 40 C.F.R. § 63.7530(e)]
- AP 24. The permittee must submit the Notification of Compliance Status containing the results of the initial compliance demonstration according to the requirements in §63.7545(e). [Reg.19.304 and 40 C.F.R. § 63.7530(f)]

- AP 25. The permittee must demonstrate continuous compliance with each emission limit in Tables 1 and 2 or 11 through 13 to Subpart DDDDD, the work practice standards in Table 3 to Subpart DDDDD, and the operating limits in Table 4 to Subpart DDDDD that applies to the permittee according to the methods specified in Table 8 to Subpart DDDDD and paragraphs (a)(1) through (19) of §63.7540. [Reg.19.304 and 40 C.F.R. § 63.7540(a)]
- AP 26. If the permittee's boiler or process heater has a continuous oxygen trim system that maintains an optimum air to fuel ratio, or a heat input capacity of less than or equal to 5 million Btu per hour and the unit is in the units designed to burn gas 1; units designed to burn gas 2 (other); or units designed to burn light liquid subcategories, or meets the definition of limited-use boiler or process heater in §63.7575, the permittee must conduct a tune-up of the boiler or process heater every 5 years as specified in paragraphs (a)(10)(i) through (vi) of §63.7540 to demonstrate continuous compliance. The permittee may delay the burner inspection specified in paragraph (a)(10)(i) of §63.7540 until the next scheduled or unscheduled unit shutdown, but the permittee must inspect each burner at least once every 72 months. [Reg.19.304 and 40 C.F.R. § 63.7540(a)(12)]
- AP 27. If the unit is not operating on the required date for a tune-up, the tune-up must be conducted within 30 calendar days of startup. [Reg.19.304 and 40 C.F.R. § 63.7540(a)(13)]
- AP 28. The permittee must submit to the Administrator all of the notifications in §§63.7(b) and (c), 63.8(e), (f)(4) and (6), and 63.9(b) through (h) that apply to the permittee by the dates specified. [Reg.19.304 and 40 C.F.R. § 63.7545(a)]
- AP 29. If the permittee is required to conduct an initial compliance demonstration as specified in §63.7530, the permittee must submit a Notification of Compliance Status according to §63.9(h)(2)(ii). For the initial compliance demonstration for each boiler or process heater, the permittee must submit the Notification of Compliance Status, including all performance test results and fuel analyses, before the close of business on the 60th day following the completion of all performance test and/or other initial compliance demonstrations for all boiler or process heaters at the facility according to §63.10(d)(2). The Notification of Compliance Status report must contain all the information specified in paragraphs (e)(1) through (8), as applicable. If the permittee is not required to conduct an initial compliance demonstration as specified in §63.7530(a), the Notification of Compliance Status must only contain the information specified in paragraphs (e)(1) and (8).
- a. A signed certification that the permittee have met all applicable emission limits and work practice standards.
 - b. If the permittee had a deviation from any emission limit, work practice standard, or operating limit, the permittee must also submit a description of the deviation, the duration of the deviation, and the corrective action taken in the Notification of Compliance Status report.

- c. In addition to the information required in §63.9(h)(2), the permittee's notification of compliance status must include the following certification(s) of compliance, as applicable, and signed by a responsible official:
 - i. "This facility complies with the required initial tune-up according to the procedures in §63.7540(a)(10)(i) through (vi)."
 - ii. "This facility has had an energy assessment performed according to §63.7530(e)."
[Reg.19.304 and 40 C.F.R. § 63.7545(e)(6-8)]

AP 30. The permittee must submit each report in Table 9 to Subpart DDDDD that applies to the permittee. [Reg.19.304 and 40 C.F.R. § 63.7550(a)]

AP 31. Unless the EPA Administrator has approved a different schedule for submission of reports under §63.10(a), the permittee must submit each report, according to paragraph (h) of §63.7550, by the date in Table 9 to Subpart DDDDD and according to the requirements in paragraphs (b)(1) through (4) of §63.7550. For units that are subject only to a requirement to conduct an annual, biennial, or 5-year tune-up according to §63.7540(a)(10), (11), or (12), respectively, and not subject to emission limits or operating limits, the permittee may submit only an annual, biennial, or 5-year compliance report, as applicable, as specified in paragraphs (b)(1) through (4) of §63.7550, instead of a semi-annual compliance report.

- a. The first compliance report must cover the period beginning on the compliance date that is specified for each boiler or process heater in §63.7495 and ending on July 31 or January 31, whichever date is the first date that occurs at least 180 days (or 1, 2, or 5 years, as applicable, if submitting an annual, biennial, or 5-year compliance report) after the compliance date that is specified for the permittee's source in §63.7495.
- b. The first compliance report must be postmarked or submitted no later than July 31 or January 31, whichever date is the first date following the end of the first calendar half after the compliance date that is specified for each boiler or process heater in §63.7495. The first annual, biennial, or 5-year compliance report must be postmarked or submitted no later than January 31.
- c. Each subsequent compliance report must cover the semiannual reporting period from January 1 through June 30 or the semiannual reporting period from July 1 through December 31. Annual, biennial, and 5-year compliance reports must cover the applicable 1-, 2-, or 5-year periods from January 1 to December 31.
- d. Each subsequent compliance report must be postmarked or submitted no later than July 31 or January 31, whichever date is the first date following the end of the semiannual reporting period. Annual, biennial, and 5-year compliance reports must be postmarked or submitted no later than January 31.

[Reg.19.304 and 40 C.F.R. § 63.7550(b)(1-4)]

AP 32. A compliance report must contain the following information depending on how the facility chooses to comply with the limits set in this rule.

- a. If the facility is subject to a the requirements of a tune up they must submit a compliance report with the information in paragraphs (c)(5)(i) through (iv) and (xiv) of §63.7550.

[Reg.19.304 and 40 C.F.R. § 63.7550(c)(1)]

AP 33. Company and Facility name and address.

- a. Process unit information, emissions limitations, and operating parameter limitations.
- b. Date of report and beginning and ending dates of the reporting period.
- c. The total operating time during the reporting period.
- d. Include the date of the most recent tune-up for each unit subject to only the requirement to conduct an annual, biennial, or 5-year tune-up according to §63.7540(a)(10), (11), or (12) respectively. Include the date of the most recent burner inspection if it was not done annually, biennially, or on a 5-year period and was delayed until the next scheduled or unscheduled unit shutdown.

[Reg.19.304 and 40 C.F.R. § 63.7550(c)(5)(i-xiv)]

AP 34. The permittee must keep records according to paragraphs (a)(1) and (2) of §63.7555.

- a. A copy of each notification and report that the permittee submitted to comply with this subpart, including all documentation supporting any Initial Notification or Notification of Compliance Status or semiannual compliance report that the permittee submitted, according to the requirements in §63.10(b)(2)(xiv).
- b. Records of performance tests, fuel analyses, or other compliance demonstrations and performance evaluations as required in §63.10(b)(2)(viii).

[Reg.19.304 and 40 C.F.R. § 63.7555(a)(1-2)]

AP 35. The permittee's records must be in a form suitable and readily available for expeditious review, according to §63.10(b)(1). [Reg.19.304 and 40 C.F.R. § 63.7560(a)]

AP 36. As specified in §63.10(b)(1), the permittee must keep each record for 5 years following the date of each occurrence, measurement, maintenance, corrective action, report, or record. [Reg.19.304 and 40 C.F.R. § 63.7560(b)]

AP 37. The permittee must keep each record on site, or they must be accessible from onsite (for example, through a computer network), for at least 2 years after the date of each occurrence, measurement, maintenance, corrective action, report, or record, according to §63.10(b)(1). The permittee can keep the records off site for the remaining 3 years. [Reg.19.304 and 40 C.F.R. § 63.7560(c)]

Anode Material Process

5M11-08, 5M11-09, and CP2-FUG

Source Description

The Anode Material Process (CP2), permitted as CP-2, consists of solids handling equipment, continuous stirred tank reactors, and dryers. Pelletized and granular material will be fed through a metering system into vessels where the material is heated and mixed. The formulated material is then dried and repackaged. All of this equipment is located inside the 5M11 building. Dust from all of the solids handling equipment is vented to a continuous dust control system (CDCS), 5M11-08. The CDCS consists of a baghouse for solid particle separation, a collection hopper, and an induced draft fan. A central vacuum cleaning system (CVC), 5M11-09 will be used to clean spills. All VOC vents will be routed to the RTOs, 5N09-01. Emissions from tanks and equipment containing VOC vent to the thermal oxidizer SN-5N09-01.

Neither CP2-T-003 or CP2-T-004 tanks are regulated by 40 CFR Subpart Kb (Standards of Performance for Volatile Organic Liquid Storage Vessels) per 40 CFR 60.11b(b). Both tanks contain liquids with vapor pressures less than 15.0 kPa. Both tanks are vented to the RTOs, 5N09-01. As a miscellaneous organic chemical manufacturing process unit (MCPU), this section is subject to 40 CFR Part 63 Subpart FFFF.

Specific Conditions

CP2 1. The permittee shall not exceed the emission rates set forth in the following table. The permittee shall demonstrate compliance with this condition by CP2 3. [Reg.19.501 *et seq.* and 40 C.F.R. § 52 Subpart E]

SN #	Description	Pollutant	lb/hr
5M11-08	Continuous Dust Collection System Baghouse	PM ₁₀	1.1
5M11-09	Central Vacuum System Baghouse	PM ₁₀	1.1
CP2-FUG	Anode Material Process VOC/HAP Fugitives	VOC	0.4

CP2 2. The permittee shall not exceed the emission rates set forth in the following table. The permittee shall demonstrate compliance with this condition by CP2 3. The facility shall show compliance with the facility total ton/yr limits using the procedures outlined in PW 11 through PW 15. Hourly Plantwide Hazardous Air Pollutant emissions are limited by PW 15. Additional HAP limitations are included in PW 12. [Reg.18.801 and Ark. Code Ann. § 8-4-203 as referenced by Ark. Code Ann. §§ 8-4-304 and 8-4-311]

SN #	Description	Pollutant	lb/hr
5M11-08	Continuous Dust Collection System Baghouse	PM	1.1
5M11-09	Central Vacuum System Baghouse	PM	1.1

CP2-FUG	Anode Material Process VOC/HAP Fugitives	Organic Pollutants**	***
---------	------------------------------------------	----------------------	-----

**Organic Pollutants are considered to be VOC, all organic HAPs, and organic Air Contaminates.
 ***Limited by Plantwide Condition 12.

- CP2 3. The permittee shall not produce more than 10.8 million pounds per year of product (anode material) from the CP2 facility by 12 month rolling total. [Reg.19.705, Ark. Code Ann. § 8-4-203 as referenced by Ark. Code Ann. §§ 8-4-304 and 8-4-311, and 40 C.F.R. § 70.6 and Reg.18.1004 and Ark. Code Ann. § 8-4-203 as referenced by Ark. Code Ann. §§ 8-4-304 and 8-4-311]
- CP2 4. The permittee shall keep monthly records of the amount of anode material produced via CP2 equipment to demonstrate compliance with the limits in Specific Conditions CP2 3. The records shall be updated by the last day of the month and shall be kept on site and made available for inspection upon request. [Reg.19.705 and 40 C.F.R. § 52 Subpart E, and Reg.18.1004 and Ark. Code Ann. § 8-4-203 as referenced by Ark. Code Ann. §§ 8-4-304 and 8-4-311]
- CP2 5. Visible emissions from the baghouses at 5M11-08 and 5M11-09 shall not exceed 5% opacity. [Reg.18.501 and Ark. Code Ann. § 8-4-203 as referenced by Ark. Code Ann. §§ 8-4-304 and 8-4-311]
- CP2 6. The permittee shall conduct weekly visual inspections at 5M11-08 and 5M11-09 for possible emissions using EPA Method 22 and monthly observations of the system using EPA Method 9. The permittee shall record the presence of any excessive visible emissions and the subsequent actions taken to correct the exceedance. [Reg.18.801 and Ark. Code Ann. § 8-4-203 as referenced by Ark. Code Ann. §§ 8-4-304 and 8-4-311]
- CP2 7. The permittee shall continuously maintain a minimum pressure drop across the fabric filter at 5M11-08 and 5M11-09 as outlined in the most current version of the Facility Operating Plan. [Reg.19.705, Ark. Code Ann. § 8-4-203 as referenced by Ark. Code Ann. §§ 8-4-304 and 8-4-311, and 40 C.F.R. § 70.6]
- CP2 8. The permittee shall keep records on site of the pressure drop across 5M11-08 and 5M11-09. [Reg.19.705 and 40 C.F.R. § 52 Subpart E]

Emergency Generators

Source Description

The facility has six emergency use generators onsite, two greater than 500 HP and four less than 500 HP. All of these generators except 4P-EG-01 are compression ignition generators and subject to applicable 40 CFR Part 60 Subpart IIII and/or 40 CFR Part 63 Subpart ZZZZ requirements. 4P-EG-01 is a spark ignition generator and is therefore subject to applicable 40 CFR Part 60 Subpart JJJJ and/or 40 CFR Part 63 Subpart ZZZZ requirements.

Engine	Size, BHP	Date of Manufacture	Stroke/Burn
5N01-WA-DIESEL GLYCOL PUMP	110	2002	4S/LB
7M04-HT-G01 DIESEL WASTE DISPOSAL PUMP	234	1995	4S/LB
7M04-HT-G04 DIESEL WASTE DISPOSAL PUMP	234	1995	4S/LB
8M01 DIESEL FIRE WATER PUMP	635	1976	2S/RB
6N02-EG Emergency Generator	1490	2010	4S
4P-EG-01	94	2022	4S/RB

Specific Conditions

EG 1. The permittee shall not exceed the emission rates set forth in the following table. The permittee shall demonstrate compliance with this condition by maintaining emission calculations for each emergency generator. The facility shall show compliance with the facility total ton/yr limits using the procedures outlined in PW 11. [Reg.19.501 *et seq.* and 40 C.F.R. § 52 Subpart E]

SN #	Description	Pollutant	lb/hr
5N01-WA	Diesel Glycol Pump	PM ₁₀	0.3
		SO ₂	0.2
		VOC	0.3
		CO	0.8
		NO _x	3.8
7M04-HT-G01	Diesel Waste Disposal Pump	PM ₁₀	0.6
		SO ₂	0.5
		VOC	0.6
		CO	1.7
		NO _x	8.0

SN #	Description	Pollutant	lb/hr
7M04-HT-G04	Diesel Waste Disposal Pump	PM ₁₀	0.6
		SO ₂	0.5
		VOC	0.6
		CO	1.7
		NO _x	8.0
8M01	Diesel Fire Water Pump	PM ₁₀	0.5
		SO ₂	5.7
		VOC	0.5
		CO	3.8
		NO _x	16.8
6N02-EG	Emergency Diesel Generator	PM ₁₀	0.7
		SO ₂	12.1
		VOC	1.1
		CO	8.5
		NO _x	15.5
4P-EG-01	Emergency Natural Gas Generator	PM ₁₀	0.1
		SO ₂	0.1
		VOC	0.1
		CO	3.2
		NO _x	0.8

EG 2. The permittee shall not exceed the emission rates set forth in the following table. The permittee shall not exceed the emission rates set forth in the following table. Emission rates are based upon the maximum capacity of equipment. The facility shall show compliance with the facility total ton/yr limits using the procedures outlined in PW 11 through PW 15. Hourly Plantwide Hazardous Air Pollutant emissions are limited by PW 15. Additional HAP limitations are included in PW 12. [Reg.18.801 and Ark. Code Ann. § 8-4-203 as referenced by Ark. Code Ann. §§ 8-4-304 and 8-4-311]

SN #	Description	Pollutant	lb/hr
5N01-WA	Diesel Glycol Pump	PM	0.3
		Organic Pollutants**	0.30
7M04-HT-G01	Diesel Waste Disposal Pump	PM	0.6
		Organic Pollutants**	0.60
7M04-HT-G04	Diesel Waste Disposal Pump	PM	0.6
		Organic Pollutants**	0.60
8M01	Diesel Fire Water Pump	PM	0.5
		Organic Pollutants**	0.50
6N02-EG	Emergency Diesel Generator	PM	0.7
		Organic Pollutants**	1.1
4P-EG-01	Emergency Natural Gas Generator	PM	0.1
		Organic Pollutants**	0.10

**Organic Pollutants are considered to be VOC, all organic HAPs, and organic Air Contaminates.

***Limited by Plantwide Condition 12.

- EG 3. Visible emissions from 4P-EG-01 shall not exceed 5% opacity, and all other generators shall not exceed 20% opacity. [Reg.19.503 and 40 C.F.R. § 52 Subpart E]
- EG 4. The permittee shall conduct daily visual inspections using EPA Method 9 once operation of any generator exceeds 24-hours of continuous use. The permittee shall record the presence of any excessive visible emissions and the subsequent actions taken to correct the exceedance. [Reg.18.801 and Ark. Code Ann. § 8-4-203 as referenced by Ark. Code Ann. §§ 8-4-304 and 8-4-311]
- EG 5. The permittee shall not operate the emergency generator SN 6N02-EG in excess of 100 total hours (emergency and non-emergency) or Emergency Generator SN 4P-EG-01 in excess of 250 total hours (emergency and non-emergency) per calendar year in order to demonstrate compliance with the annual emission rate limits. Emergency operation in excess of these hours may be allowable but shall be reported and will be evaluated in accordance with Reg.19.602 and other applicable regulations. [Reg.19.705, Ark. Code Ann. § 8-4-203 as referenced by Ark. Code Ann. §§ 8-4-304 and 8-4-311, and 40 C.F.R. § 70.6]
- EG 6. The permittee shall maintain monthly records to demonstrate compliance with Specific Condition #EG 6. The permittee shall update these records by the fifteenth day of the month following the month to which the records pertain. The calendar year totals and each individual month's data shall be maintained on-site, made available to Division of Environmental Quality personnel upon request, and submitted in accordance with General Provision #7. [Reg.19.705 and 40 C.F.R. § 52 Subpart E]

SN-8M01, Part 63 Subpart ZZZZ Conditions

- EG 7. SN-8M01 is a RICE engine with a site rating of more than 500 brake horsepower (HP) located at a major source of HAP emissions. [Reg.19.304 and 40 C.F.R. § 63.6590(a)]
- EG 8. SN-8M01 is an existing stationary RICE because it was constructed before December 19, 2002. [Reg.19.304 and 40 C.F.R. § 63.6590(a)(1)(i)]
- EG 9. As existing emergency stationary RICE with a site rating of more than 500 brake HP located at a major source of HAP emissions, SN-8M01 RICE does not have to meet the requirements of this subpart and of subpart A of this part, including initial notification requirements. SN-8M01 does not operate and is not contractually obligated to be available for more than 15 hours per calendar year for the purposes specified in §63.6640(f)(2)(ii) and (iii). [Reg.19.304 and 40 C.F.R. § 63.6590(b)(3)(iii)]
- EG 10. As emergency stationary RICE with a site rating of more than 500 brake HP located at a major source of HAP emissions that was installed prior to June 12, 2006, the permittee must operate SN-8M01 according to the conditions described in paragraphs (f)(2)(i) through (iii) of this section. If you do not operate the engine according to the requirements in paragraphs (f)(2)(i) through (iii) of this section, the engine will not be considered an emergency engine under this subpart and will need to meet all requirements for non-emergency engines.
- a. There is no time limit on the use of emergency stationary RICE in emergency situations.

- b. You may operate your emergency stationary RICE for the purpose of maintenance checks and readiness testing, provided that the tests are recommended by the manufacturer, the vendor, or the insurance company associated with the engine. Required testing of such units should be minimized, but there is no time limit on the use of emergency stationary RICE in emergency situations and for routine testing and maintenance.
- c. You may operate your emergency stationary RICE for an additional 50 hours per year in non-emergency situations. The 50 hours per year for non-emergency situations cannot be used for peak shaving or to generate income for a facility to supply power to an electric grid or otherwise supply power as part of a financial arrangement with another entity.

[Reg.19.304 and 40 C.F.R. § 63.6640(f)(2)(i-iii)]

SN-5N01-WA, SN-7M04-HT-G01, SN-7M04-HT-G04, Part 63 Subpart ZZZZ Conditions

- EG 11. 5N01-WA, 7M04-HT-G01, 7M04-HT-G04 are RICE engines with a site rating of less than 500 brake horsepower (HP) located at a major source of HAP emissions.
[Reg.19.304 and 40 C.F.R. § 63.6590(a)]
- EG 12. 5N01-WA, 7M04-HT-G01, 7M04-HT-G04 are existing stationary RICE because they were constructed before June 12, 2006. [Reg.19.304 and 40 C.F.R. § 63.6590(a)(1)(i)(ii)]
- EG 13. The permittee must comply with the applicable emission limitations and operating limitations for 5N01-WA, 7M04-HT-G01, and 7M04-HT-G04 no later than May 3, 2013.
[Reg.19.304 and 40 C.F.R. § 63.6595(a)]
- EG 14. The permittee must comply with the emission limitations and other requirements in Table 2c to this subpart which apply to 5N01-WA, 7M04-HT-G01, and 7M04-HT-G04.
[Reg.19.304 and 40 C.F.R. § 63.6602 and Table 2(c)(1)]
- a. Change oil and filter every 500 hours of operation or annually, whichever comes first;
 - b. Inspect air cleaner every 1,000 hours of operation or annually, whichever comes first;
 - c. Inspect all hoses and belts every 500 hours of operation or annually, whichever comes first, and replace as necessary.
 - d. During periods of startup, you must minimize the engine's time spent at idle and minimize the engine's startup time at startup to a period needed for appropriate and safe loading of the engine, not to exceed 30 minutes, after which time the non-startup emission limitations apply.
- EG 15. The permittee must be in compliance with the emission limitations, operating limitations, and other requirements for this subpart at all times.

At all times the permittee must operate and maintain any affected source, including associated air pollution control equipment and monitoring equipment, in a manner consistent with safety and good air pollution control practices for minimizing emissions. The general duty to minimize emissions does not require any further efforts to reduce emissions if levels required by this standard have been achieved. Determination of whether such operation and maintenance procedures are being used will be based on information available to the Administrator which may include, but is not limited to, monitoring results, review of operation and maintenance procedures, review of operation and maintenance records, and inspection of the source.

[Reg.19.304 and 40 C.F.R. § 63.6605(a)&(b)]

- EG 16. The permittee must operate and maintain the stationary RICE 5N01-WA, 7M04-HT-G01, and 7M04-HT-G04 and their respective after-treatment control device (if any) according to the manufacturer's emission-related written instructions or develop a maintenance plan which must provide to the extent practicable for the maintenance and operation of the engine in a manner consistent with good air pollution control practice for minimizing emissions. [Reg.19.304 and 40 C.F.R. § 63.6625(e)(2)]
- EG 17. The permittee must install a non-resettable hour meter if one is not already installed at 5N01-WA, 7M04-HT-G01, and 7M04-HT-G04. [Reg.19.304 and 40 C.F.R. § 63.6625(f)]
- EG 18. The permittee must minimize the engine's, 5N01-WA, 7M04-HT-G01, and 7M04-HT-G04, time spent at idle during startup and minimize the engine's startup time to a period needed for appropriate and safe loading of the engine, not to exceed 30 minutes, after which time the emission standards applicable to all times other than startup in Table 2c. [Reg.19.304 and 40 C.F.R. § 63.6625(h)]
- EG 19. The permittee must operate 5N01-WA, 7M04-HT-G01, and 7M04-HT-G04 according to the requirements in paragraphs (f)(1)(i) through (iii) of this section. Any operation other than emergency operation, maintenance and testing, and operation in non-emergency situations for 50 hours per year, as described in paragraphs (f)(1)(i) through (iii) of this section, is prohibited. If you do not operate the engine according to the requirements in paragraphs (f)(1)(i) through (iii) of this section, the engine will not be considered an emergency engine under this subpart and will need to meet all requirements for non-emergency engines.
- a. There is no time limit on the use of emergency stationary RICE in emergency situations.

- b. You may operate your emergency stationary RICE for the purpose of maintenance checks and readiness testing, provided that the tests are recommended by Federal, State or local government, the manufacturer, the vendor, or the insurance company associated with the engine. Maintenance checks and readiness testing of such units is limited to 100 hours per year. The owner or operator may petition the Administrator for approval of additional hours to be used for maintenance checks and readiness testing, but a petition is not required if the owner or operator maintains records indicating that Federal, State, or local standards require maintenance and testing of emergency RICE beyond 100 hours per year.
- c. You may operate your emergency stationary RICE up to 50 hours per year in non-emergency situations, but those 50 hours are counted towards the 100 hours per year provided for maintenance and testing. The 50 hours per year for non-emergency situations cannot be used for peak shaving or to generate income for a facility to supply power to an electric grid or otherwise supply power as part of a financial arrangement with another entity; except that owners and operators may operate the emergency engine for a maximum of 15 hours per year as part of a demand response program if the regional transmission organization or equivalent balancing authority and transmission operator has determined there are emergency conditions that could lead to a potential electrical blackout, such as unusually low frequency, equipment overload, capacity or energy deficiency, or unacceptable voltage level. The engine may not be operated for more than 30 minutes prior to the time when the emergency condition is expected to occur, and the engine operation must be terminated immediately after the facility is notified that the emergency condition is no longer imminent. The 15 hours per year of demand response operation are counted as part of the 50 hours of operation per year provided for non-emergency situations. The supply of emergency power to another entity or entities pursuant to financial arrangement is not limited by this paragraph (f)(1)(iii), as long as the power provided by the financial arrangement is limited to emergency power.

[Reg.19.304 and 40 C.F.R. § 63.6640(f)(1)(i-iii)]

EG 20. The permittee must keep records of the maintenance conducted on 5N01-WA, 7M04-HT-G01, and 7M04-HT-G04 in order to demonstrate that you operated and maintained the stationary RICE and after-treatment control device (if any) according to your own maintenance plan. [Reg.19.304 and 40 C.F.R. § 63.6655(e)(2)]

EG 21. The permittee must keep records of the hours of operation of operate 5N01-WA, 7M04-HT-G01, and 7M04-HT-G04 that is recorded through the non-resettable hour meter. The owner or operator must document how many hours are spent for emergency operation, including what classified the operation as emergency and how many hours are spent for non-emergency operation. If the engine is used for the purposes specified in § 63.6640(f)(1)(ii) or (iii), the owner or operator must keep records of the notification of the emergency situation, and the date, start time, and end time of engine operation for these purposes. [Reg.19.304 and 40 C.F.R. § 63.6655(f)(1)]

EG 22. The permittee shall comply with the following for records required by this subpart for 5N01-WA, 7M04-HT-G01, and 7M04-HT-G04:

- a. Records must be in a form suitable and readily available for expeditious review according to § 63.10(b)(1).
- b. Keep each record for 5 years following the date of each occurrence, measurement, maintenance, corrective action, report, or record.
- c. Keep each record readily accessible in hard copy or electronic form for at least 5 years after the date of each occurrence, measurement, maintenance, corrective action, report, or record, according to § 63.10(b)(1). [Reg.19.304 and 40 C.F.R. § 63.6660(a,b,&c)]

SN-6N02 EG, Part 63 Subpart ZZZZ Conditions

EG 23. SN-6N02 EG does not have to meet the requirements of this subpart and of Subpart A (except for initial notification requirements of §63.6645(f) due to it being a new emergency stationary RICE with a site rating of more than 500 brake hp located at a major source of HAP emissions and does not operate or is not contractually obligated to be available for more than 15 hours per calendar year for the purposes specified in §63.6640(f)(2)(ii) and (iii). [Reg.19.304 and 40 C.F.R. § 63.6590(b)(1)(i)]

SN-6N02 EG, Part 60 Subpart IIII Conditions

EG 24. The permittee shall not exceed the limits in the following table for SN-6N02 EG:

Emission Standards in g/KW-hr (g/HP-hr)			
	NMHC+NO _x	CO	PM
6N02-EG	6.4 (4.8)	3.5 (2.6)	0.2 (0.15)

[Reg.19.304 and 40 C.F.R. § 60.4205(b)]

EG 25. The installed engine's (SN-6N02-EG) emission standards were certified by the manufacturer on 06/08/2010. EPA Certificate Number: CEX-STATCI-11-05. [40 CFR § 60.4202(a)(2), 60.4208(a)(b)(h), 60.4211(c)]

EG 26. The permittee must use diesel fuel that meets the requirements of 40 CFR 80.510(b). [Reg 19.304 and 40 CFR § 60.4207(b)]

EG 27. The permittee must operate and maintain SN-6N02 EG to achieve the emission standards as required in Condition EG 24 over the entire life of the engine. [Reg. 19.304 and 40 CFR § 60.4206]

EG 28. SN 6N02-EG must comply with the emission standards specified in this subpart. The permittee must do all of the following, except as permitted under paragraph (g) of this section:

- a. Operate and maintain SN 6N02-EG internal combustion engine and control device according to the manufacturer's emission-related written instructions;
- b. Change only those emission-related settings that are permitted by the manufacturer; and
- c. Meet the emission standards as specified in Condition EG 22.

[Reg 19.304 and 40 CFR § 60.4211(a)]

EG 29. If the permittee does not install, configure, operate, and maintain SN 6N02-EG according to the manufacturer's emission-related written instructions, or you change emission-related settings in a way that is not permitted by the manufacturer the permittee must keep a maintenance plan and records of conducted maintenance and must, to the extent practicable, maintain and operate the engine in a manner consistent with good air pollutin control practice for minimizing emissions. In addition, you must conduct an initial performance test to demonstrate compliance with the applicable emission standards within 1 year of start-up, or within 1 year after an engine and control device is no longer installed, configured, operated and maintained in accordance with the manufacturer's emission-related writtin instructions, or within 1 year after you change emission-related settings in a way that is nt permitted by the manufacturer. You must conduct subsequent performance testing every 8,760 hours of engine operation or 3 years, whichever comes first, thereafter to demonstrate compliance with the applicable emission standards. [Reg 19.304 and 40 CFR § 60.4211(g)]

EG 30 If the permittee does not install, configure, operate, and maintain the engine and control device according to the manufacturer's emission-related instructions, or change the emission-related settings in a way not permitted by the manufacturer, the permittee must conduct performance test according to 40 CFR §60.4212. [Reg 19.304 and 40 CFR § 60.4212]

EG 31 The permittee must operate the emergency stationary ICE according to the requirements in paragraphs (a) through (c) of this section. In order for the engine to be considered an emergency stationary ICE under this subpart, any operation other than emergency operation, maintenance and testing, emergency demand response, and operation in non-emergency situations for 50 hours per year, as described in paragraphs (a) through (c) of this section, is prohibited. If you do not operate the engine according to the requirements in paragraphs (a) through (c) of this section, the engine will not be considered an emergency engine under this subpart and must meet all requirements for non-emergency engines.

- a. There is no limit on the use of emergency stationary ICE in emergency situations.
- b. The permittee may operate your emergency stationary ICE for any combination of the purposes specified in paragraphs (i) of this section for a maximum of 100 hours per calendar year. Any operation for non-emergency situations as allowed by paragraph (c) of this section counts as part of the 100 hours per calendar year allowed by this paragraph (b).
 - i. Emergency stationary ICE may be operated for maintenance checks and readiness testing, provided that the tests are recommended by federal, state or local government, the manufacturer, the vendor, the regional transmission organization or equivalent balancing authority and transmission operator, or the insurance company associated with the engine. The owner or operator may petition the Administrator for approval of additional hours to be used for maintenance checks and readiness testing, but a petition is not required if the owner or operator maintains records indicating that federal, state, or local standards require maintenance and testing of emergency ICE beyond 100 hours per calendar year.
- c. Emergency stationary ICE may be operated for up to 50 hours per calendar year in non-emergency situations. The 50 hours of operation in non-emergency situations are counted as part of the 100 hours per calendar year for maintenance and testing and emergency demand response provided in paragraph (b) of this section. The 50 hours per calendar year for non-emergency situations cannot be used for peak shaving or non-emergency demand response, or to generate income for a facility to an electric grid or otherwise supply power as part of a financial agreement with another entity.

[Reg 19.304 and 40 CFR § 60.4211(f)]

EG 32 If SN 6N02-EG does not meet the standards applicable to non-emergency engines, the permittee must install a non-resettable hour meter prior to startup of SN 6N02-EG. [Reg 19.304 and 40 CFR § 60.4209(a)]

EG 33 If SN 6N02-EG is an emergency stationary internal combustion engine, the permittee is not required to submit an initial notification. Starting with model year 2011, if the emergency engine does not meet the standards applicable to non-emergency engines in the applicable model year, the permittee must keep records of the operation of the engine in emergency and non-emergency service that are recorded through a non-resettable hour meter. The permittee must record the time of operation of the engine and the reason the engine was in operation during that time. [Reg 19.304 and 40 CFR § 60.4214(b)]

SN-4P-EG-01, Part 63 Subpart ZZZZ Conditions

EG 34. SN:4P-EG-01 meets the requirements of Part 63 subpart ZZZZ by complying with the applicable requirements of Part 60 subpart JJJJ. [Reg 19.304 and 40 CFR § 63.6590(c)(4)&(6)]

SN-4P-EG-01, Part 60 Subpart JJJJ Conditions

EG 35. The permittee shall not exceed the limits in the following table for SN: 4P-EG-01 :

Emission Standards in g/KW-hr (g/HP-hr)		
4P-EG-01	NO _x +HC	CO
	13.4 (10)	519 (387)

[Reg. 19.304 and 40 C.F.R. Part 60 Subpart JJJJ Table 1]

EG 36. The engine's (SN: 4P-EG-01) emission standards were certified by the manufacturer and shall comply with emission standards in Table 1 . EPA Certificate Number: NI<HXB06.2NNL-001. [40 CFR § 60.4233(d)]

EG 37. The permittee must operate and maintain SN: 4P-EG-01 to achieve the emission standards as required in Condition EG 35 over the entire life of the engine. [Reg. 19.304 and 40 CFR § 60.4234]

EG 38. The permittee must comply with the emission standards specified in EG 35 and must demonstrate compliance by purchasing a certified engine. [Reg. 19.304 and 40 CFR § 60.4243(b)(1)]

EG 39. The permittee must operate the emergency stationary ICE according to the requirements below. In order for the engine to be considered an emergency stationary ICE under this subpart, any operation other than emergency operation, maintenance and testing, emergency demand response, and operation in non-emergency situations for 50 hours per year, as described in paragraphs (a) through (c) of this section, is prohibited. If you do not operate the engine according to the requirements in paragraphs (a) through (c) of this section, the engine will not be considered an emergency engine under this subpart and must meet all requirements for non-emergency engines.

- a. There is no limit on the use of emergency stationary ICE in emergency situations.
- b. The permittee may operate your emergency stationary ICE for any combination of the purposes specified in paragraphs (i) of this section for a maximum of 100 hours per calendar year. Any operation for non-emergency

situations as allowed by paragraph (c) of this section counts as part of the 100 hours per calendar year allowed by this paragraph (b).

- i. Emergency stationary ICE may be operated for maintenance checks and readiness testing, provided that the tests are recommended by federal, state or local government, the manufacturer, the vendor, the regional transmission organization or equivalent balancing authority and transmission operator, or the insurance company associated with the engine. The owner or operator may petition the Administrator for approval of additional hours to be used for maintenance checks and readiness testing, but a petition is not required if the owner or operator maintains records indicating that federal, state, or local standards require maintenance and testing of emergency ICE beyond 100 hours per calendar year.
- c. Emergency stationary ICE may be operated for up to 50 hours per calendar year in non-emergency situations. The 50 hours of operation in non-emergency situations are counted as part of the 100 hours per calendar year for maintenance and testing and emergency demand response provided in paragraph (b) of this section. The 50 hours per calendar year for non-emergency situations cannot be used for peak shaving or non-emergency demand response, or to generate income for a facility to an electric grid or otherwise supply power as part of a financial agreement with another entity.

[Reg 19.304 and 40 CFR § 60.4243(d)]

EG 40 The permittee may operate their natural gas engine using propane for a maximum of 100 hours per year as an alternative fuel solely during emergency operations, but must keep records of such use. If propane is used for more than 100 hours per year in an engine that is not certified to the emission standards when using propane, the owners and operators are required to conduct a performance test to demonstrate compliance with the emission standards of § 60.4233. [Reg 19.304 and 40 CFR § 60.4243(e)]

EG 41 The permittee of the stationary SI ICE must keep the following records:

- (1) All notifications submitted to comply with this subpart and all documentation supporting any notification.
- (2) Maintenance conducted on the engine.
- (3) Documentation from the manufacturer that the engine is certified to meet the emission standards and information as required in 40 CFR parts 1048 1054 and 1060, as applicable. [Reg 19.304 and 40 CFR § 60.4245(a)]

FutureFuel Chemical Company

Permit #: 1085-AOP-R16

AFIN: 32-00036

EG 42 If SN 4P-EG-01 does not meet the standards applicable to non-emergency engines, the permittee must install a non-resettable hour meter prior to startup of SN 4P-EG-01. [Reg 19.304 and 40 CFR § 60.4245(b)]

Plantwide Sources Subject to MON

Source Description

Miscellaneous organic chemical manufacturing process units (MCPU) that are located at, or are part of, a major source of hazardous air pollutants (HAP) emissions as defined in section 112(a) of the Clean Air Act (CAA). [§63.2435(a)]

An MCPU includes equipment necessary to operate a miscellaneous organic chemical manufacturing process, as defined in §63.2550, that satisfies all of the conditions specified in paragraphs (b)(1) through (3) of this section. An MCPU also includes any assigned storage tanks and transfer racks; equipment in open systems that is used to convey or store water having the same concentration and flow characteristics as wastewater; and components such as pumps, compressors, agitators, pressure relief devices, sampling connection systems, open-ended valves or lines, valves, connectors, and instrumentation systems that are used to manufacture any material or family of materials described in paragraphs (b)(1)(i) through (v) of this section. [§63.2435(b)]

All or part of the following facilities are subject to the MON standards:

- Organic Chemical Intermediates
- Organic Sulfonation Process
- Solvent Recovery
- Isopropyl Benzene Production
- 5N07 Production Facility
- Aldehyde Processing Facility
- Storage Tanks and Miscellaneous Sources
- Anode Material Process

Affected Source Applicability

- MON 1. The permittee is an existing affected source subject to 40 CFR 63, Subpart FFFF as defined in §63.2435(a) through (e), and §63.2440. [Reg.19.304 and 40 C.F.R. §§ 63.2345 and 63.2440]
- MON 2. The CP-2 section contains equipment that are new affected sources subject to 40 CFR 63, Subpart FFFF as defined in §63.2435(a) through (e), and §63.2440(c)(1). [Reg.19.304 and 40 C.F.R. §§ 63.2335 and 63.2440]

Compliance Date

- MON 3. The permittee must comply with the requirements for existing sources in this subpart no later than May 10, 2008. [Reg.19.304 and 40 C.F.R. §§ 63.2440 and 63.2445(b)]
- MON 4. The permittee must comply with the requirements for new affected sources in this subpart no later than upon startup of the affected new source. [Reg.19.304 and 40 C.F.R. §§ 63.2440 and 63.2445(a)(2)]

Notification Requirements

- MON 5. The permittee must meet the notification requirements in §63.2515 according to the dates specified in that section and in subpart A of part 63. [Reg.19.304 and 40 C.F.R. § 63.2445(c)]
- MON 6. If the permittee has a Group 2 emission point that becomes a Group 1 emission point after the compliance date for the affected source, the permittee must comply with the Group 1 requirements beginning on the date the switch occurs. An initial compliance demonstration as specified in this subpart must be conducted within 150 days after the switch occurs. [Reg.19.304 and 40 C.F.R. § 63.2445(d)]
- MON 7. If, after the compliance date for an affected source, hydrogen halide and halogen HAP emissions from process vents in a process increase to more than 1,000 lb/yr, or HAP metals emissions from a process at a new affected source increase to more than 150 lb/yr, the permittee must comply with the applicable emission limits specified in Table 3 to this subpart and the associated compliance requirements beginning on the date the emissions exceed the applicable threshold. An initial compliance demonstration as specified in this subpart must be conducted within 150 days after the switch occurs. [Reg.19.304 and 40 C.F.R. § 63.2445(e)]
- MON 8. If the permittee operates a small control device for process vents or transfer rack emissions that become a large control device, as defined in 63.2550(i), the permittee must comply with monitoring and associated recordkeeping and reporting requirements for large control devices beginning on the date the switch occurs. An initial compliance demonstration as specified in this subpart must be conducted within 150 days after the switch occurs. [Reg.19.304 and 40 C.F.R. § 63.2445(f)]
- MON 9. If after the compliance date of an affected source the permittee starts production of a Subpart FFFF covered process in existing equipment not previously subject to Subpart FFFF, the permittee must meet all Subpart FFFF applicable conditions on the process startup date and must conduct an initial compliance demonstration where applicable within 150 days after startup. [Reg.19.304 and 40 C.F.R. § 63.2445]

General Requirements

- MON 10. The permittee must be in compliance with the emission limits and work practice standards in Tables 1 through 7 to Subpart FFFF at all times, except during periods of startup, shutdown, and malfunction (SSM), and must meet the requirements specified in §§63.2455 through 63.2490 (or the alternative means of compliance in §63.2495, §63.2500, or §63.2505), except as specified in paragraphs (b) through (s) of this section, and must meet the notification, reporting, and recordkeeping requirements specified in §§63.2515, 63.2520, and 63.2525. [Reg.19.304 and 40 C.F.R. § 63.2450(a)].

Requirements for Continuous Process Vents

- MON 11. The permittee must meet each emission limit in Table 1 to Subpart FFFF that applies

to continuous process vents, and must meet each applicable requirement specified in paragraphs (b) through (c) of §63.2455. [Reg.19.304 and 40 C.F.R. § 63.2455(a)]

For each . . .	For which . . .	Then you must . . .
1. Group 1 continuous process vent	a. Not applicable	i. Reduce emissions of total organic HAP by ≥ 98 percent by weight or to an outlet process concentration ≤ 20 ppmv as organic HAP or TOC by venting emissions through a closed-vent system to any combination of control devices (except a flare); or ii. Reduce emissions of total organic HAP by venting emissions through a closed vent system to a flare; or iii. Use a recovery device to maintain the TRE above 1.9 for an existing source or above 5.0 for a new source.
2. Halogenated Group 1 continuous process vent stream	a. You use a combustion control device to control organic HAP emissions	i. Use a halogen reduction device after the combustion device to reduce emissions of hydrogen halide and halogen HAP by ≥ 99 percent by weight, or to ≤ 0.45 kg/hr, or to ≤ 20 ppmv; or ii. Use a halogen reduction device before the combustion device to reduce the halogen atom mass emission rate to ≤ 0.45 kg/hr or to a concentration ≤ 20 ppmv.
3. Group 2 continuous process vent at an existing source	You use a recovery device to maintain the TRE level >1.9 but ≤ 5.0	Comply with the requirements in §63.993 and the requirements referenced therein.
4. Group 2 continuous process vent at a new source	You use a recovery device to maintain the TRE level >5.0 but ≤ 8.0	Comply with the requirements in §63.993 and the requirements referenced therein.

Requirements for Batch Process Vents

MON 12. The permittee must meet each emission limit in Table 2 to this subpart that applies, and must meet each applicable requirement specified in paragraphs (b) and (c) of 63.2460. [Reg.19.304 and 40 C.F.R. § 63.2460(a)]

For each . . .	Then you must . . .	And you must . . .
1. Process with Group 1 batch process vents	a. Reduce collective uncontrolled organic HAP emissions from the sum of all batch process vents within the process by ≥ 98 percent by weight by venting emissions from a sufficient number of the vents through one or more closed-vent systems to any combination of control devices (except a flare); or	Not applicable.
	b. Reduce collective uncontrolled organic HAP emissions from the sum of all batch process vents	Not applicable.

For each . . .	Then you must . . .	And you must . . .
	within the process by ≥ 95 percent by weight by venting emissions from a sufficient number of the vents through one or more closed-vent systems to any combination of recovery devices or a biofilter, except you may elect to comply with the requirements of subpart WW of this part for any process tank; or	
	c. Reduce uncontrolled organic HAP emissions from one or more batch process vents within the process by venting through a closed-vent system to a flare or by venting through one or more closed-vent systems to any combination of control devices (excluding a flare) that reduce organic HAP to an outlet concentration ≤ 20 ppmv as TOC or total organic HAP.	For all other batch process vents within the process, reduce collective organic HAP emissions as specified in item 1.a and/or item 1.b of this table.
2. Halogenated Group 1 batch process vent for which you use a combustion device to control organic HAP emissions	a. Use a halogen reduction device after the combustion control device; or	i. Reduce overall emissions of hydrogen halide and halogen HAP by ≥ 99 percent; or ii. Reduce overall emissions of hydrogen halide and halogen HAP to ≤ 0.45 kg/hr; or iii. Reduce overall emissions of hydrogen halide and halogen HAP to a concentration ≤ 20 ppmv.
	b. Use a halogen reduction device before the combustion control device	Reduce the halogen atom mass emission rate to ≤ 0.45 kg/hr or to a concentration ≤ 20 ppmv.

Requirements for Process Vents that Emit Hydrogen Halide and Halogen HAP or HAP Metals

MON 13. The permittee must meet each emission limit in Table 3 to this subpart that applies and must meet each applicable requirement in paragraphs (b) through (d) of this section.
 [Reg.19.304 and 40 C.F.R. § 63.2465(a)]

For each . . .	You must . . .
1. Process with uncontrolled hydrogen halide and halogen HAP emissions from process vents $\geq 1,000$ lb/yr.	a. Reduce collective hydrogen halide and halogen HAP emissions by ≥ 99 percent by weight or to an outlet concentration ≤ 20 by venting through one or more closed-vent systems to any combination of control devices, or b. Reduce the halogen atom mass emission rate from the sum of all batch process vents and each individual continuous process vent to ≤ 0.45 kb/hr by venting through one or more closed-vent systems to a halogen reduction device.

For each . . .	You must . . .
2. Process at a new source with uncontrolled emissions from process vents ≥ 150 lb/yr of HAP metals	Reduce overall emission of HAP metals by ≥ 97 percent by weight.

Requirements for Storage Tanks

MON 14. The permittee must meet each emission limit in Table 4 to Subpart FFFF that applies to its storage tanks, and must meet each applicable requirement specified in paragraphs (b) through (e) of §63.2470. [Reg.19.304 and 40 C.F.R. § 63.2470(a)]

For each . . .	For which . . .	Then you must . . .
1. Group 1 storage tank	a. The maximum true vapor pressure of total HAP at the storage temperature is ≥ 76.6 kilopascals	i. Reduce total HAP emissions by ≥ 95 percent by weight or to ≤ 20 ppmv of TOC or organic HAP and ≤ 20 ppmv of hydrogen halide and halogen HAP by venting emissions through a closed vent system to any combination of control devices (excluding a flare); or ii. Reduce total organic HAP emissions by venting emissions through a closed vent system to a flare; or iii. Reduce total HAP emissions by venting emissions to a fuel gas system or process in accordance with §63.982(d) and the requirements referenced therein.
	b. The maximum true vapor pressure of total HAP at the storage temperature is < 76.6 kilopascals	i. Comply with the requirements of subpart WW of this part, except as specified in §63.2470; or ii. Reduce total HAP emissions by ≥ 95 percent by weight or to ≤ 20 ppmv of TOC or organic HAP and ≤ 20 ppmv of hydrogen halide and halogen HAP by venting emissions through a closed vent system to any combination of control devices (excluding a flare); or iii. Reduce total organic HAP emissions by venting emissions through a closed vent system to a flare; or iv. Reduce total HAP emissions by venting emissions to a fuel gas system or process in accordance with §63.982(d) and the requirements referenced therein.
2. Halogenated vent stream from a Group 1 storage tank	You use a combustion control device to control organic HAP emissions	Meet one of the emission limit options specified in Item 2.a.i or ii. in Table 1 to this subpart.

Requirements for Transfer Racks

MON 15. The permittee must comply with each emission limit and work practice standard in Table 5 to Subpart FFFF that applies to transfer racks, and must meet each applicable requirement in paragraphs (b) and (c) of §63.2475. [Reg.19.304 and 40 C.F.R. § 63.2475(a)]

For each . . .	You must . . .
1. Group 1 transfer rack	a. Reduce emissions of total organic HAP by ≥ 98 percent by weight or to an outlet concentration ≤ 20 ppmv as organic HAP or TOC by venting emissions through a closed-vent system to any combination of control devices (except a flare); or b. Reduce emissions of total organic HAP by venting emissions through a closed-vent system to a flare; or c. Reduce emissions of total organic HAP by venting emissions to a fuel gas system or process in accordance with §63.982(d) and the requirements referenced therein; or d. Use a vapor balancing system designed and operated to collect organic HAP vapors displaced from tank trucks and railcars during loading and route the collected HAP vapors to the storage tank from which the liquid being loaded originated or to another storage tank connected by a common header.
2. Halogenated Group 1 transfer rack vent stream for which you use a combustion device to control organic HAP emissions	a. Use a halogen reduction device after the combustion device to reduce emissions of hydrogen halide and halogen HAP by ≥ 99 percent by weight, to ≤ 0.45 kg/hr, or to ≤ 20 ppmv; or b. Use a halogen reduction device before the combustion device to reduce the halogen atom mass emission rate to ≤ 0.45 kg/hr or to a concentration ≤ 20 ppmv.

Requirements for Equipment Leaks

MON 16. The permittee must meet each requirement in Table 6 to Subpart FFFF that applies to equipment leaks, except as specified in paragraphs (b) through (d) of §63.2480. [Reg.19.304 and 40 C.F.R. § 63.2480(a)]

For all . . .	And that is part of . . .	You must . . .
1. Equipment that is in organic HAP service	a. Comply with the requirements of subpart UU of this part 63 and the requirements referenced therein, except as specified in §63.2480(b) and (d); or b. Comply with the requirements of subpart H of this part 63 and the requirements referenced therein, except as specified in §63.2480(b) and (d); or c. Comply with the requirements of 40 CFR part 65, subpart F and the requirements referenced therein, except as specified in §63.2480(c) and (d).	
2. Equipment that is in organic HAP service at a new source	a. Any MCPU	i. Comply with the requirements of subpart UU of this part 63 and the requirements referenced therein; or ii. Comply with the requirements of 40 CFR part 65, subpart F.

Requirements for Wastewater and Liquid Streams in Open Systems within an MCPU

MON 17. The permittee must meet each requirement in Table 7 to Subpart FFFF that applies to wastewater streams and liquid streams in open systems within an MCPU, except as specified in paragraphs (b) through (o) of §63.2485. [Reg.19.304 and 40 C.F.R. § 63.2485(a)]

For each . . .	You must . . .
1. Process wastewater stream	Comply with the requirements in §§63.132 through 63.148 and the requirements referenced therein, except as specified in §63.2485.
2. Maintenance wastewater stream	Comply with the requirements in §63.105 and the requirements referenced therein, except as specified in §63.2485.
3. Liquid streams in an open system within an MCPU	Comply with the requirements in §63.149 and the requirements referenced therein, except as specified in §63.2485.

Requirements for Heat Exchange Systems

MON 18. The permittee must comply with each requirement in Table 10 to Subpart FFFF that applies to heat exchange systems, except as specified in paragraphs (b) and (c) of

§63.2490. [Reg.19.304 and 40 C.F.R. § 63.2490(a)]

For each . . .	You must . . .
Heat exchange system, as defined in §63.101	Comply with the requirements of §63.104 and the requirements referenced therein, except as specified in §63.2490.

Compliance with Pollution Prevention Standards

MON 19. The permittee may elect to comply with the pollution prevention alternative requirements specified in paragraphs (a)(1) and (2) of this section in lieu of the emission limitations and work practice standards contained in Tables 1 through 7 to this subpart for any MCPU for which initial startup occurred before April 4, 2002. [Reg.19.304 and 40 C.F.R. § 63.2595(a)]

Emissions Averaging

MON 20. For an existing source, the permittee may elect to comply with the percent reduction emission limitations in Tables 1, 2, 4, 5, and 7 to this subpart by complying with the emissions averaging provisions specified in 63.150, except as specified in paragraphs (b) through (f) of 63.2500. [Reg.19.304 and 40 C.F.R. § 63.2500(a)]

Alternative Standard

MON 21. As an alternative to complying with the emission limits and work practice standards for process vents and storage tanks in Tables 1 through 4 to this subpart and the requirements in §§63.2455 through 63.2470, the permittee may comply with the emission limits in paragraph (a) of this section and demonstrate compliance in accordance with the requirements in paragraph (b) of this section. [Reg.19.304 and 40 C.F.R. § 63.2505]

Notification, Reports, and Records

MON 22. The permittee must submit all of the notifications in §§63.6(h)(4) and (5), 63.7(b) and (c), 63.8(e), (f)(4) and (6), and 63.9(b) through (h) that apply by the dates specified. [Reg.19.304 and 40 C.F.R. § 63.2515(a)]

Reporting Requirements

MON 23. The permittee must submit each report in Table 11 to Subpart FFFF that applies. [Reg.19.304 and 40 C.F.R. § 63.2520(a)]

You must submit a(n)	The report must contain...	You must submit the report . . .
1. Precompliance report	The information specified in §63.2520(c)	At least 6 months prior to the compliance date; or for new sources, with the application for approval of construction or reconstruction.
2. Notification of compliance status report	The information specified in §63.2520(d)	No later than 150 days after the compliance date specified in §63.2445.
3. Compliance report	The information specified in §63.2520(e)	Semiannually according to the requirements in §63.2520(b).

MON 24. Unless the Administrator has approved a different schedule for submission of reports under §63.10(a), the permittee must submit each report by the date in Table 11 to Subpart FFFF and according to paragraphs (b)(1) through (5) of §63.2520. [Reg.19.304 and 40 C.F.R. § 63.2520(b)]

MON 25. The permittee shall follow the reporting requirements of §63.2520(c) through (e). [Reg.19.304 and 40 C.F.R. § 63.2520(c) through (e)]

Recordkeeping Requirements

MON 26. The permittee shall keep the records specified in paragraphs (a) through (k) of section §63.2525. [Reg.19.304 and 40 C.F.R. § 63.2525(a) through (k)]

Compliance Options for Applicability to 40 CFR 63, Subpart FFFF and another Subpart

MON 27. For any equipment, emission stream, or wastewater stream subject to the provisions of both Subpart FFFF and another rule, the permittee may elect to comply only with the provisions as specified in paragraphs (a) through (l) of this section. The permittee also must identify the subject equipment, emission stream, or wastewater stream, and the provisions with which the permittee will comply, in the notification of compliance status report required by §63.2520(d). [Reg.19.304 and 40 C.F.R. § 63.2535]

General Applicability

MON 28. The permittee shall comply with parts of the General Provisions in §§63.1 through 63.15 as referenced in §63.2540. [Reg.19.304 and 40 C.F.R. § 63.2540]

FutureFuel Chemical Company
Permit #: 1085-AOP-R16
AFIN: 32-00036

SECTION V: COMPLIANCE PLAN AND SCHEDULE

FutureFuel Chemical Company will continue to operate in compliance with those identified regulatory provisions. The facility will examine and analyze future regulations that may apply and determine their applicability with any necessary action taken on a timely basis.

SECTION VI: PLANTWIDE CONDITIONS

1. The permittee shall notify the Director in writing within thirty (30) days after commencing construction, completing construction, first placing the equipment and/or facility in operation, and reaching the equipment and/or facility target production rate. [Reg.19.704, 40 C.F.R. § 52 Subpart E, and Ark. Code Ann. § 8-4-203 as referenced by Ark. Code Ann. §§ 8-4-304 and 8-4-311]
2. If the permittee fails to start construction within eighteen months or suspends construction for eighteen months or more, the Director may cancel all or part of this permit. [Reg.19.410(B) and 40 C.F.R. § 52 Subpart E]
3. The permittee must test any equipment scheduled for testing, unless otherwise stated in the Specific Conditions of this permit or by any federally regulated requirements, within the following time frames: (1) new equipment or newly modified equipment within sixty (60) days of achieving the maximum production rate, but no later than 180 days after initial start up of the permitted source or (2) operating equipment according to the time frames set forth by the Department or within 180 days of permit issuance if no date is specified. The permittee must notify the Department of the scheduled date of compliance testing at least fifteen (15) business days in advance of such test. The permittee shall submit the compliance test results to the Department within sixty (60) calendar days after completing the testing. [Reg.19.702 and/or Reg.18.1002 and Ark. Code Ann. § 8-4-203 as referenced by Ark. Code Ann. §§ 8-4-304 and 8-4-311]
4. The permittee must provide:
 - a. Sampling ports adequate for applicable test methods;
 - b. Safe sampling platforms;
 - c. Safe access to sampling platforms; and
 - d. Utilities for sampling and testing equipment.

[Reg.19.702 and/or Reg.18.1002 and Ark. Code Ann. § 8-4-203 as referenced by Ark. Code Ann. §§ 8-4-304 and 8-4-311]
5. The permittee must operate the equipment, control apparatus and emission monitoring equipment within the design limitations. The permittee shall maintain the equipment in good condition at all times. [Reg.19.303 and Ark. Code Ann. § 8-4-203 as referenced by Ark. Code Ann. §§ 8-4-304 and 8-4-311]
6. This permit subsumes and incorporates all previously issued air permits for this facility. [Reg. 26 and Ark. Code Ann. § 8-4-203 as referenced by Ark. Code Ann. §§ 8-4-304 and 8-4-311]

7. In the absence of an averaging period stated within the permit or any enforceable federal requirement (NSPS, NESHAP, etc.), the lb/hr limits stated herein are considered to be based upon a 3-hour averaging period. [Reg.19.705 and 40 C.F.R. § 52 Subpart E and Reg.18.1004 and Ark. Code Ann. § 8-4-203 as referenced by Ark. Code Ann. §§ 8-4-304 and 8-4-311]
8. The permittee shall submit a compliance report with state-only enforceable terms and conditions contained in the permit, including emission limitations, standards, or work practices. This compliance report shall be submitted annually to the Department. All compliance reports required by this permit shall include the following [Reg.18.1004 and Ark. Code Ann. § 8-4-203 as referenced by Ark. Code Ann. §§ 8-4-304 and 8-4-311]:
 - a. The identification of each term or condition of the permit that is the basis of the certification;
 - b. The compliance status;
 - c. Whether compliance was continuous or intermittent;
 - d. The method(s) used for determining the compliance status of the source, currently and over the reporting period established by the monitoring requirements of this permit; and
 - e. Such other facts as the Department may require elsewhere in this permit.

This compliance report may be in the same format as, and may be included with, the annual compliance certification required by Section VI General Condition 21.

9. For purposes of Section VI General Condition 8 of this permit and §§26.701(C)(3)(b) of Regulation #26, "prompt" or "prompt reporting" shall be construed to mean:
 - a. by the next business day, if deviations result in exceedances of applicable emission limitations lasting 30 or more minutes, in the aggregate during a 24-hour period, unless otherwise specified in an applicable permit or regulation (including, but not limited to, NSPS regulations); and
 - b. in the next semi-annual report for all other deviations.

[40 C.F.R. § 70.6(a)(3)(iii)(B), Reg.26.701(C)(3)(b), and Reg.19.601 and Reg.19.602]

10. The permittee may modify point source operating parameters (Facility Operating Plans) if the parameter modifications do not exceed emissions allowable under the permit. Facility Operating Plan modifications must be provided to the Agency seven days in advance of the proposed changes. A shorter time frame may be allowed by the Agency in emergency cases. [Reg.26.802 and § 502(b)(10) of the Clean Air Act]

Plantwide Limits

11. The permittee shall not exceed the following emission rates at the facility during any consecutive 12 month period. [Reg.19.501 *et seq.* and 40 C.F.R. § 52 Subpart E]

Plantwide Limits	
Pollutant	ton/yr
PM ₁₀	178.7
SO ₂	6144.4
VOC	491.3
CO	1224.6
NO _x	875.4
Pb	3.5

12. The permittee shall not exceed the following emission rates at the facility during any consecutive 12 month period. [Reg.18.801 and Ark. Code Ann. § 8-4-203 as referenced by Ark. Code Ann. §§ 8-4-304 and 8-4-311]

Pollutant	ton/yr
Inorganics*	1092.9
Organic Pollutants**	491.3

*Inorganics are considered to be non-organic Hazardous Air Pollutants

**Organic Pollutants are considered to be VOC, all organic HAPs, and organic Air Contaminates.

13. The permittee shall maintain records to demonstrate compliance with the criteria emission limits in 11. The emission records shall be recalculated monthly, and shall be based upon a 12-month rolling total. The records shall be updated by the last day of the month following the recorded 12-month period, and shall be kept on site and made available for inspection upon request. [Reg.19.705 and 40 C.F.R. § 52 Subpart E and Reg.18.1004 and Ark. Code Ann. § 8-4-203 as referenced by Ark. Code Ann. §§ 8-4-304 and 8-4-311]
14. The permittee shall determine the monthly emissions of each non-criteria air pollutant by material balance. This determination shall include each inorganic contaminant and each Hazardous Air Pollutant (HAP), as designated by Section 112 of the Clean Air Act. The material balance shall be recalculated monthly, and shall be based upon a 12-month rolling total. The records shall be updated by the last day of the month following the recorded 12-month period, and shall be kept on site and made available for inspection upon request. [Reg.18.801 and Ark. Code Ann. § 8-4-203 as referenced by Ark. Code Ann. §§ 8-4-304 and 8-4-311]
15. The permittee shall use the emissions determined from 14 to show acceptable impacts in accordance with the Department's Non-Criteria Air Pollutant Control Strategy. Except for inorganic HCl, the permittee shall calculate the site-specific 30-day Presumptively Acceptable Emission Rate (PAER) for each non-criteria pollutant emitted at the facility using the equation presented below. [Reg.18.1004 and Ark. Code Ann. § 8-4-203 as referenced by Ark. Code Ann. §§ 8-4-304 and 8-4-311]

Except for inorganic HCl, this determination shall include each inorganic contaminant and each Hazardous Air Pollutant (HAP), as designated by Section 112 of the Clean Air Act. The permittee shall not emit more than the calculated 30-day PAER during any consecutive 30-day period. The permittee shall maintain on-site records of the emissions rates and the calculated 30-day site-specific PAER (lb/month) for each non-criteria pollutant emitted. These records shall be made available for inspection upon request.

Allowable site-specific PAER (lb/month) = 2.14 x (TLV in mg/m³ from ACGIH) x 720

Any exceedance of the site-specific PAER shall be reported to the Department within 24 hours of such discovery. A full report of the exceedance and subsequent corrective action shall be submitted to the Department within 5 business days.

For inorganic HCl, the permittee shall maintain documentation to confirm the monthly plantwide inorganic HCl emission rates are less than the allowable inorganic limit. These records shall be made available for inspection upon request.

The permittee shall review and update the TLV values used for each compound at least once annually, according to the most recent edition of the ACGIH Threshold Limit Values for Chemical Substances and Physical Agents.

16. This facility is a major stationary source as defined by 40 CFR §52.21. Any physical change or change in the method of operation which results in a significant emission increase, as defined by 40 CFR 52.21, shall require prior approval of a PSD netting exercise or a PSD permit before the event taking place, regardless of the plantwide emission rate. [Reg.19.901 *et seq.* and 40 C.F.R. § 52 Subpart E]

40 CFR Part 60, Subpart Kb Standards of Performance for Volatile Organic Liquid Storage Vessels

17. The permittee shall maintain documentation necessary to determine compliance with the applicability of this subpart for all storage vessels having a capacity of greater than or equal to 75 cubic meters (19,813 gallons). Affected tanks include the following: [Reg.19.304 and 40 C.F.R. § 60.110b]

TF-13 (SN-5N03-43)	PM-50B	FAA-TF-01	
WB-06 (SN-6M-03-08)	TBA-100	FAA-TF-02	
WB-07 (SN-6M-03-09)	T-280 (SN-5N03-51)	FAA-TF-101	VC-PT-03
WB-08 (SN-6M-03-10)	T-265 (SN-5N03-53)	FAA-TF-102	VC-PT-01
WB-09 (SN-6M-03-11)	T-251	PROD-TF-02	VC-PT-02
TFS-60	T-220	PROD-TF-15	T-243
PT-60	T-211A	PROD-TF-302	T-271
PT-68	T-211B	RA-TF-01	T-272
PT-69A	T-241	RA-TF-02	T-273
PT-69B	PA-50 T-270	SPS-TF-04	
PB-51	RA-TF-01	SPS-TF-204	
PB-52	AA-100	T-242	
PM-50A	TBA-75		

18. The permittee shall maintain documentation identifying storage vessels complying with the requirements of 40 CFR §60.112b, including emission controls used, and all documentation to support compliance with the emission control used. [Reg.19.304 and 40 C.F.R. § 60.112b]
19. The permittee shall meet the specifications of this citation for closed vent systems and control devices used for tank emission abatement. [Reg.19.304 and 40 C.F.R. § 60.112b(a)(3)]
20. The permittee shall comply with all applicable testing and procedures as identified in §60.113b. The applicable requirement for a particular storage vessel depends on the control equipment installed to meet the requirements of §60.112b. [Reg.19.304 and 40 C.F.R. § 60.113b]
21. Each closed vent system and control device (other than a flare) is exempt from §60.8 of the General Provisions and shall comply with the requirements specified in this citation. [Reg.19.304 and 40 C.F.R. § 60.113b(c)]
22. Closed vent systems with flares shall comply with the requirements as specified in §60.18(e) and (f). Records shall be kept of all periods of operation during which the flare pilot flame is absent and shall be reported semiannually. [Reg.19.304 and 40 C.F.R. § 60.113b(d)(2) and (3)]
23. The permittee shall keep records and furnish reports as required, depending upon the control equipment installed, to meet the requirements of §60.112b. Copies of operating plans shall be kept for the life of the control equipment. [Reg.19.304 and 40 C.F.R. § 60.115b]
24. The permittee shall keep copies of all records required by Subpart Kb. [Reg.19.304 and 40 C.F.R. § 60.116b]
25. Each storage vessel equipped with a closed vent system and control device meeting the specifications of §60.112b is exempt from the requirements of paragraphs (c) and (d) of §60.116b. [Reg.19.304 and 40 C.F.R. § 60.116b(g)]
26. The permittee shall submit an application to incorporate the provisions of 40 CFR Part 63 Subpart DDDDD by July 31, 2015. [Reg.26.1011 and 40 C.F.R. § 52 Subpart E]

Acid Rain (Title IV)

27. The Director prohibits the permittee to cause any emissions exceeding any allowances the source lawfully holds under Title IV of the Act or the regulations promulgated under the Act. No permit revision is required for increases in emissions allowed by allowances acquired pursuant to the acid rain program, if such increases do not require a permit revision under any other applicable requirement. This permit establishes no limit on the number of allowances held by the permittee. However, the source may not use allowances as a defense for noncompliance with any other applicable requirement of this permit or the Act. The permittee will account for any such allowance according to the procedures established in regulations promulgated

under Title IV of the Act. A copy of the facility's Acid Rain Permit is attached in an appendix to this Title V permit. [Reg.26.701 and 40 C.F.R. § 70.6(a)(4)]

Title VI Provisions

28. The permittee must comply with the standards for labeling of products using ozone-depleting substances. [40 C.F.R. § 82 Subpart E]
 - a. All containers containing a class I or class II substance stored or transported, all products containing a class I substance, and all products directly manufactured with a class I substance must bear the required warning statement if it is being introduced to interstate commerce pursuant to § 82.106.
 - b. The placement of the required warning statement must comply with the requirements pursuant to § 82.108.
 - c. The form of the label bearing the required warning must comply with the requirements pursuant to § 82.110.
 - d. No person may modify, remove, or interfere with the required warning statement except as described in § 82.112.

29. The permittee must comply with the standards for recycling and emissions reduction, except as provided for MVACs in Subpart B. [40 C.F.R. § 82 Subpart F]
 - a. Persons opening appliances for maintenance, service, repair, or disposal must comply with the required practices pursuant to § 82.156.
 - b. Equipment used during the maintenance, service, repair, or disposal of appliances must comply with the standards for recycling and recovery equipment pursuant to § 82.158.
 - c. Persons performing maintenance, service repair, or disposal of appliances must be certified by an approved technician certification program pursuant to § 82.161.
 - d. Persons disposing of small appliances, MVACs, and MVAC like appliances must comply with record keeping requirements pursuant to § 82.166. ("MVAC like appliance" as defined at § 82.152)
 - e. Persons owning commercial or industrial process refrigeration equipment must comply with leak repair requirements pursuant to § 82.156.
 - f. Owners/operators of appliances normally containing 50 or more pounds of refrigerant must keep records of refrigerant purchased and added to such appliances pursuant to § 82.166.

30. If the permittee manufactures, transforms, destroys, imports, or exports a class I or class II substance, the permittee is subject to all requirements as specified in 40 C.F.R. § 82 Subpart A, Production and Consumption Controls.

31. If the permittee performs a service on motor (fleet) vehicles when this service involves ozone depleting substance refrigerant (or regulated substitute substance) in the motor vehicle air conditioner (MVAC), the permittee is subject to all the

applicable requirements as specified in 40 C.F.R. § 82 Subpart B, Servicing of Motor Vehicle Air Conditioners.

The term “motor vehicle” as used in Subpart B does not include a vehicle in which final assembly of the vehicle has not been completed. The term “MVAC” as used in Subpart B does not include the air tight sealed refrigeration system used as refrigerated cargo, or the system used on passenger buses using HCFC 22 refrigerant.

32. The permittee can switch from any ozone depleting substance to any alternative listed in the Significant New Alternatives Program (SNAP) promulgated pursuant to 40 C.F.R. § 82 Subpart G.
33. Compliance with the conditions of this permit shall be deemed compliance with all applicable requirements, as of the date of issuance of Permit 1085-AOP-R9, included and specifically identified below:

Plant Area	Source (SN)	Regulation	Description
Facility	WB-07 (SN-6M-03-09) WB-08 (SN-6M-03-10) WB-09 (SN-6M-03-11) TFS-60 PT-60 PT-68 PT-69A PT-69B TF-13 (SN-5N03-43) WB-06 (SN-6M-03-08) PB-51 PB-52 PM-50A PM-50B TBA-100 RNS-100 (SN-4P94-11) T-280 (SN-5N03-51) T-265 (SN-5N03-53) T-251 T-220 T-211A T-211B T-241 PA-50 T-270 RA-TF-01 AA-100 TBA-75 FAA-TF-01 FAA-TF-02 FAA-TF-101 FAA- TF-102 PROD-TF-02 T-242	40 CFR Part 60 (NSPS) Subpart Kb	Volatile organic liquid storage vessels of greater than 75 cubic meters (19,815 gal) capacity constructed, reconstructed, or modified after 7/23/84.

Plant Area	Source (SN)	Regulation	Description
	PROD-TF-15 PROD-TF-302 RA-TF-01 RA-TF-02 SPS-TF-04 SPS-TF-204 VC-PT-01 VC-PT-02 VC-PT-03 T-243 T-271 T-272 T-273		
		40 CFR Part 63 Subpart DD	National Emission Standards for Hazardous Air Pollutants from Off-Site Waste and Recovery Operations
		40 CFR Part 68	Chemical Accident Prevention: Facility is not subject to production and consumption controls.
		Arkansas Air Pollution Code	Regulation 18
		Regulations of the Arkansas Plan of Implementation for Air Pollution Control	Regulation 19
		Regulations of Arkansas Air Permit Operating Program	Regulation 26
Organic Chemical Intermediate		40 CFR Part 63 Subpart GGG	Pharmaceuticals Production
		40 CFR Part 63 Subpart MMM	Pesticide Active Ingredient MACT
		40 CFR Part 63 Subpart FFFF	Miscellaneous Organic NESHAP
Organic Sulfonation		40 CFR Part 60 Subpart VV	SOCMI VOC Equipment Leaks, 40 CFR 60.489
		40 CFR Part 60 Subpart NNN	SOCMI Distillation Operations, 40 CFR 60.667.
		40 CFR Part 63 Subpart FFFF	Miscellaneous Organic NESHAP
	5M04-02 PROD-VE-01	40 CFR Part 64	Compliance Assurance Monitoring
Isopropyl Benzene		40 CFR 61, Subpart J	Standard for Equipment Leaks (Fugitive Emission Sources) of Benzene. 40 CFR 61, Subpart V
	D-9 T-9	40 CFR Part 61 Subpart FF	Benzene Regulations

Plant Area	Source (SN)	Regulation	Description
		40 CFR Part 63 Subpart FFFF	Miscellaneous Organic NESHAP
Biodiesel	T-210	40 CFR Part 61, Subpart V	Benzene Storage Vessels
		40 CFR Part 63 Subpart FFFF	Miscellaneous Organic NESHAP
Aldehyde Processing		40 CFR Part 63 Subpart FFFF	Miscellaneous Organic NESHAP
Solvent Recovery		40 CFR Part 63 Subpart FFFF	Miscellaneous Organic NESHAP
Storage Tanks & Misc. Sources		40 CFR Part 63 Subpart FFFF	Miscellaneous Organic NESHAP
Utilities	6M01	40 CFR Part 60 Subpart Y	Standards of Performance for Coal Preparation Plants
	6M07-01	40 CFR Part 60 Subpart Db	Gas Boilers and Process Heaters: Industrial-Commercial-Institutional Steam Generators > 100 MMBTU/hr (after 6/19/1984)
	Refrigeration Units	40 CFR Part 82 Subpart F	Protection of Stratospheric Ozone: Subject to leak repair requirements pursuant to §82.156. Subject to recordkeeping pursuant to §82.166. Owners/operators of appliances normally containing 50 or more pounds of refrigerant must keep records of refrigerant purchased and added to such appliances.
	6M01-01	40 CFR Part 63 Subpart EEE	Emission Standards for Hazardous Waste Combustors
Destructor	6M03-05	40 CFR Part 63 Subpart EEE	Emission Standards for Hazardous Waste Combustors
Anode Material Process		40 CFR Part 63 Subpart FFFF	Miscellaneous Organic NESHAP
Emergency Generators		40 CFR Part 63 Subpart ZZZZ	Reciprocating Internal Combustion Engines NESHAP

SECTION VII: INSIGNIFICANT ACTIVITIES

The Division of Environmental Quality deems the following types of activities or emissions as insignificant on the basis of size, emission rate, production rate, or activity in accordance with Group A of the Insignificant Activities list found in Regulation 18 and Regulation 19 Appendix A. Group B insignificant activities may be listed but are not required to be listed in permits. Insignificant activity emission determinations rely upon the information submitted by the permittee in an application dated April 6, 2018. [Reg.26.304 and Ark. Code Ann. § 8-4-203 as referenced by Ark. Code Ann. §§ 8-4-304 and 8-4-311]

Source #	Description	Category
3N01-01	Storage Tank (Storage Tank Process), BD-01	A-13
4P02-02	Quenching (Solvent Recovery Process)	A-13
4P94-03	Storage Tank (Solvent Recovery Process)	A-3
4P94-04	Storage Tank (Solvent Recovery Process)	A-13
5M01-03	Vacuum System (Organic Sulfonation Process)	A-13
5M03-06	Vacuum System (Organic Sulfonation Process)	A-13
5M04-03	Storage Tank (Organic Sulfonation Process)	A-13
5M04-04	Storage Tank (Organic Sulfonation Process)	A-4
5M04-07	Storage Tank (Organic Sulfonation Process)	A-4
5M04-09	Storage Tank (Organic Sulfonation Process)	A-13
5M11-03	Vacuum System (Organic Sulfonation Process)	A-13
5M11-08	Vents (Organic Sulfonation Process)	A-13
5M11-09	Vents (Organic Sulfonation Process)	A-13
5N01-63	Storage Tank (Organic Chemical Intermediate Process)	A-3
5N01-64	Storage Tank (Organic Chemical Intermediate Process)	A-3
5N02-01	Storage Tank (Storage Tank Process)	A-13
5N02-02	Storage Tank (Storage Tank Process)	A-13
5N03-46	Unloading Station (Isopropyl Benzene Process)	A-13
5N03-47	Unloading Station (Isopropyl Benzene Process)	A-13
5N03-63	Storage Tank (Organic Chemical Intermediate Process)	A-3
5P99-01	US-2-VS Odor Absorber	A-13
6M03-15	Storage Tank (Chemical Destruction Process)	A-4
6N01-01	Storage Tank (Storage Tank Process)	A-3
	Caustic Tank (CL-01R)	A-4

FutureFuel Chemical Company

Permit #: 1085-AOP-R16

AFIN: 32-00036

Source #	Description	Category
	Railcar Loading and Unloading Racks	A-13
5P01-01	Storage Tank (Glycerin)	A-13
5P01-02	Storage Tank (Glycerin)	A-13
4Q01-12	Storage Tank (Glycerin)	A-13
4Q01-13	Storage Tank (Glycerin)	A-13

SECTION VIII: GENERAL PROVISIONS

1. Any terms or conditions included in this permit which specify and reference Arkansas Pollution Control & Ecology Commission Regulation 18 or the Arkansas Water and Air Pollution Control Act (Ark. Code Ann. § 8-4-101 *et seq.*) as the sole origin of and authority for the terms or conditions are not required under the Clean Air Act or any of its applicable requirements, and are not federally enforceable under the Clean Air Act. Arkansas Pollution Control & Ecology Commission Regulation 18 was adopted pursuant to the Arkansas Water and Air Pollution Control Act (Ark. Code Ann. § 8-4-101 *et seq.*). Any terms or conditions included in this permit which specify and reference Arkansas Pollution Control & Ecology Commission Regulation 18 or the Arkansas Water and Air Pollution Control Act (Ark. Code Ann. § 8-4-101 *et seq.*) as the origin of and authority for the terms or conditions are enforceable under this Arkansas statute. [40 C.F.R. § 70.6(b)(2)]
2. This permit shall be valid for a period of five (5) years beginning on the date this permit becomes effective and ending five (5) years later. [40 C.F.R. § 70.6(a)(2) and Reg.26.701(B)]
3. The permittee must submit a complete application for permit renewal at least six (6) months before permit expiration. Permit expiration terminates the permittee's right to operate unless the permittee submitted a complete renewal application at least six (6) months before permit expiration. If the permittee submits a complete application, the existing permit will remain in effect until the Division of Environmental Quality takes final action on the renewal application. The Division of Environmental Quality will not necessarily notify the permittee when the permit renewal application is due. [Reg.26.406]
4. Where an applicable requirement of the Clean Air Act, as amended, 42 U.S.C. 7401, *et seq.* (Act) is more stringent than an applicable requirement of regulations promulgated under Title IV of the Act, the permit incorporates both provisions into the permit, and the Director or the Administrator can enforce both provisions. [40 C.F.R. § 70.6(a)(1)(ii) and Reg.26.701(A)(2)]
5. The permittee must maintain the following records of monitoring information as required by this permit.
 - a. The date, place as defined in this permit, and time of sampling or measurements;
 - b. The date(s) analyses performed;
 - c. The company or entity performing the analyses;
 - d. The analytical techniques or methods used;
 - e. The results of such analyses; and
 - f. The operating conditions existing at the time of sampling or measurement.

[40 C.F.R. § 70.6(a)(3)(ii)(A) and Reg.26.701(C)(2)]

6. The permittee must retain the records of all required monitoring data and support information for at least five (5) years from the date of the monitoring sample, measurement, report, or application. Support information includes all calibration and maintenance records and all original strip chart recordings for continuous monitoring instrumentation, and copies of all reports required by this permit. [40 C.F.R. § 70.6(a)(3)(ii)(B) and Reg.26.701(C)(2)(b)]
7. The permittee must submit reports of all required monitoring every six (6) months. If the permit establishes no other reporting period, the reporting period shall end on the last day of the month six months after the issuance of the initial Title V permit and every six months thereafter. The report is due on the first day of the second month after the end of the reporting period. The first report due after issuance of the initial Title V permit shall contain six months of data and each report thereafter shall contain 12 months of data. The report shall contain data for all monitoring requirements in effect during the reporting period. If a monitoring requirement is not in effect for the entire reporting period, only those months of data in which the monitoring requirement was in effect are required to be reported. The report must clearly identify all instances of deviations from permit requirements. A responsible official as defined in Reg.26.2 must certify all required reports. The permittee will send the reports electronically using <https://portal.adeq.state.ar.us> or mail them to the address below:

Division of Environmental Quality
Office of Air Quality
ATTN: Compliance Inspector Supervisor
5301 Northshore Drive
North Little Rock, AR 72118-5317

[40 C.F.R. § 70.6(a)(3)(iii)(A) and Reg.26.701(C)(3)(a)]

8. The permittee shall report to the Division of Environmental Quality all deviations from permit requirements, including those attributable to upset conditions as defined in the permit.
 - a. For all upset conditions (as defined in Reg.19.601), the permittee will make an initial report to the Division of Environmental Quality by the next business day after the discovery of the occurrence. The initial report may be made by telephone and shall include:
 - i. The facility name and location;
 - ii. The process unit or emission source deviating from the permit limit;
 - iii. The permit limit, including the identification of pollutants, from which deviation occurs;
 - iv. The date and time the deviation started;
 - v. The duration of the deviation;

- vi. The emissions during the deviation;
- vii. The probable cause of such deviations;
- viii. Any corrective actions or preventive measures taken or being taken to prevent such deviations in the future; and
- ix. The name of the person submitting the report.

The permittee shall make a full report in writing to the Division of Environmental Quality within five (5) business days of discovery of the occurrence. The report must include, in addition to the information required by the initial report, a schedule of actions taken or planned to eliminate future occurrences and/or to minimize the amount the permit's limits were exceeded and to reduce the length of time the limits were exceeded. The permittee may submit a full report in writing (by facsimile, overnight courier, or other means) by the next business day after discovery of the occurrence, and the report will serve as both the initial report and full report.

- b. For all deviations, the permittee shall report such events in semi-annual reporting and annual certifications required in this permit. This includes all upset conditions reported in 8a above. The semi-annual report must include all the information as required by the initial and full reports required in 8a.

[Reg.19.601, Reg.19.602, Reg.26.701(C)(3)(b), and 40 C.F.R. § 70.6(a)(3)(iii)(B)]

9. If any provision of the permit or the application thereof to any person or circumstance is held invalid, such invalidity will not affect other provisions or applications hereof which can be given effect without the invalid provision or application, and to this end, provisions of this Regulation are declared to be separable and severable. [40 C.F.R. § 70.6(a)(5), Reg.26.701(E), and Ark. Code Ann. § 8-4-203 as referenced by Ark. Code Ann. §§ 8-4-304 and 8-4-311]
10. The permittee must comply with all conditions of this Part 70 permit. Any permit noncompliance with applicable requirements as defined in Regulation 26 constitutes a violation of the Clean Air Act, as amended, 42 U.S.C. § 7401, *et seq.* and is grounds for enforcement action; for permit termination, revocation and reissuance, for permit modification; or for denial of a permit renewal application. [40 C.F.R. § 70.6(a)(6)(i) and Reg.26.701(F)(1)]
11. It shall not be a defense for a permittee in an enforcement action that it would have been necessary to halt or reduce the permitted activity to maintain compliance with the conditions of this permit. [40 C.F.R. § 70.6(a)(6)(ii) and Reg.26.701(F)(2)]
12. The Division of Environmental Quality may modify, revoke, reopen and reissue the permit or terminate the permit for cause. The filing of a request by the permittee for a permit modification, revocation and reissuance, termination, or of a notification of planned changes or anticipated noncompliance does not stay any permit condition. [40 C.F.R. § 70.6(a)(6)(iii) and Reg.26.701(F)(3)]

13. This permit does not convey any property rights of any sort, or any exclusive privilege. [40 C.F.R. § 70.6(a)(6)(iv) and Reg.26.701(F)(4)]
14. The permittee must furnish to the Director, within the time specified by the Director, any information that the Director may request in writing to determine whether cause exists for modifying, revoking and reissuing, or terminating the permit or to determine compliance with the permit. Upon request, the permittee must also furnish to the Director copies of records required by the permit. For information the permittee claims confidentiality, the Division of Environmental Quality may require the permittee to furnish such records directly to the Director along with a claim of confidentiality. [40 C.F.R. § 70.6(a)(6)(v) and Reg.26.701(F)(5)]
15. The permittee must pay all permit fees in accordance with the procedures established in Regulation 9. [40 C.F.R. § 70.6(a)(7) and Reg.26.701(G)]
16. No permit revision shall be required, under any approved economic incentives, marketable permits, emissions trading and other similar programs or processes for changes provided for elsewhere in this permit. [40 C.F.R. § 70.6(a)(8) and Reg.26.701(H)]
17. If the permit allows different operating scenarios, the permittee shall, contemporaneously with making a change from one operating scenario to another, record in a log at the permitted facility a record of the operational scenario. [40 C.F.R. § 70.6(a)(9)(i) and Reg.26.701(I)(1)]
18. The Administrator and citizens may enforce under the Act all terms and conditions in this permit, including any provisions designed to limit a source's potential to emit, unless the Division of Environmental Quality specifically designates terms and conditions of the permit as being federally unenforceable under the Act or under any of its applicable requirements. [40 C.F.R. § 70.6(b) and Reg.26.702(A) and (B)]
19. Any document (including reports) required by this permit pursuant to 40 C.F.R. § 70 must contain a certification by a responsible official as defined in Reg.26.2. [40 C.F.R. § 70.6(c)(1) and Reg.26.703(A)]
20. The permittee must allow an authorized representative of the Division of Environmental Quality, upon presentation of credentials, to perform the following: [40 C.F.R. § 70.6(c)(2) and Reg.26.703(B)]
 - a. Enter upon the permittee's premises where the permitted source is located or emissions related activity is conducted, or where records must be kept under the conditions of this permit;
 - b. Have access to and copy, at reasonable times, any records required under the conditions of this permit;

- c. Inspect at reasonable times any facilities, equipment (including monitoring and air pollution control equipment), practices, or operations regulated or required under this permit; and
 - d. As authorized by the Act, sample or monitor at reasonable times substances or parameters for assuring compliance with this permit or applicable requirements.

- 21. The permittee shall submit a compliance certification with the terms and conditions contained in the permit, including emission limitations, standards, or work practices. The permittee must submit the compliance certification annually. If the permit establishes no other reporting period, the reporting period shall end on the last day of the anniversary month of the initial Title V permit. The report is due on the first day of the second month after the end of the reporting period. The permittee must also submit the compliance certification to the Administrator as well as to the Division of Environmental Quality. All compliance certifications required by this permit must include the following: [40 C.F.R. § 70.6(c)(5) and Reg.26.703(E)(3)]
 - a. The identification of each term or condition of the permit that is the basis of the certification;
 - b. The compliance status;
 - c. Whether compliance was continuous or intermittent;
 - d. The method(s) used for determining the compliance status of the source, currently and over the reporting period established by the monitoring requirements of this permit; and
 - e. Such other facts as the Division of Environmental Quality may require elsewhere in this permit or by § 114(a)(3) and § 504(b) of the Act.

- 22. Nothing in this permit will alter or affect the following: [Reg.26.704(C)]
 - a. The provisions of Section 303 of the Act (emergency orders), including the authority of the Administrator under that section;
 - b. The liability of the permittee for any violation of applicable requirements prior to or at the time of permit issuance;
 - c. The applicable requirements of the acid rain program, consistent with § 408(a) of the Act; or
 - d. The ability of EPA to obtain information from a source pursuant to § 114 of the Act.

- 23. This permit authorizes only those pollutant emitting activities addressed in this permit. [Ark. Code Ann. § 8-4-203 as referenced by Ark. Code Ann. §§ 8-4-304 and 8-4-311]

- 24. The permittee may request in writing and at least 15 days in advance of the deadline, an extension to any testing, compliance or other dates in this permit. No such extensions are authorized until the permittee receives written Division of Environmental Quality approval. The Division of Environmental Quality may grant such a request, at its discretion in the following circumstances:

- a. Such an extension does not violate a federal requirement;
- b. The permittee demonstrates the need for the extension; and
- c. The permittee documents that all reasonable measures have been taken to meet the current deadline and documents reasons it cannot be met.

[Reg.18.314(A), Reg.19.416(A), Reg.26.1013(A), Ark. Code Ann. § 8-4-203 as referenced by Ark. Code Ann. §§ 8-4-304 and 8-4-311, and 40 C.F.R. § 52 Subpart E]

25. The permittee may request in writing and at least 30 days in advance, temporary emissions and/or testing that would otherwise exceed an emission rate, throughput requirement, or other limit in this permit. No such activities are authorized until the permittee receives written Division of Environmental Quality approval. Any such emissions shall be included in the facility's total emissions and reported as such. The Division of Environmental Quality may grant such a request, at its discretion under the following conditions:

- a. Such a request does not violate a federal requirement;
- b. Such a request is temporary in nature;
- c. Such a request will not result in a condition of air pollution;
- d. The request contains such information necessary for the Division of Environmental Quality to evaluate the request, including but not limited to, quantification of such emissions and the date/time such emission will occur;
- e. Such a request will result in increased emissions less than five tons of any individual criteria pollutant, one ton of any single HAP and 2.5 tons of total HAPs; and
- f. The permittee maintains records of the dates and results of such temporary emissions/testing.

[Reg.18.314(B), Reg.19.416(B), Reg.26.1013(B), Ark. Code Ann. § 8-4-203 as referenced by Ark. Code Ann. §§ 8-4-304 and 8-4-311, and 40 C.F.R. § 52 Subpart E]

26. The permittee may request in writing and at least 30 days in advance, an alternative to the specified monitoring in this permit. No such alternatives are authorized until the permittee receives written Division of Environmental Quality approval. The Division of Environmental Quality may grant such a request, at its discretion under the following conditions:

- a. The request does not violate a federal requirement;
- b. The request provides an equivalent or greater degree of actual monitoring to the current requirements; and
- c. Any such request, if approved, is incorporated in the next permit modification application by the permittee.

FutureFuel Chemical Company

Permit #: 1085-AOP-R16

AFIN: 32-00036

[Reg.18.314(C), Reg.19.416(C), Reg.26.1013(C), Ark. Code Ann. § 8-4-203 as referenced by Ark. Code Ann. §§ 8-4-304 and 8-4-311, and 40 C.F.R. § 52 Subpart E]

27. Any credible evidence based on sampling, monitoring, and reporting may be used to determine violations of applicable emission limitations. [Reg.18.1001, Reg.19.701, Ark. Code Ann. § 8-4-203 as referenced by Ark. Code Ann. §§ 8-4-304 and 8-4-311, and 40 C.F.R. § 52 Subpart E]

Appendix A

Arkansas Department of Environmental Quality



CONTINUOUS EMISSION MONITORING SYSTEMS CONDITIONS

Revised September 2013

PREAMBLE

These conditions are intended to outline the requirements for facilities required to operate Continuous Emission Monitoring Systems/Continuous Opacity Monitoring Systems (CEMS/COMS). Generally there are three types of sources required to operate CEMS/COMS:

1. CEMS/COMS required by 40 CFR Part 60 or 63,
2. CEMS required by 40 CFR Part 75,
3. CEMS/COMS required by ADEQ permit for reasons other than Part 60, 63 or 75.

These CEMS/COMS conditions are not intended to supercede Part 60, 63 or 75 requirements.

- Only CEMS/COMS in the third category (those required by ADEQ permit for reasons other than Part 60, 63, or 75) shall comply with SECTION II, MONITORING REQUIREMENTS and SECTION IV, QUALITY ASSURANCE/QUALITY CONTROL.
- All CEMS/COMS shall comply with Section III, NOTIFICATION AND RECORDKEEPING.

SECTION I

DEFINITIONS

Continuous Emission Monitoring System (CEMS) - The total equipment required for the determination of a gas concentration and/or emission rate so as to include sampling, analysis and recording of emission data.

Continuous Opacity Monitoring System (COMS) - The total equipment required for the determination of opacity as to include sampling, analysis and recording of emission data.

Calibration Drift (CD) - The difference in the CEMS output reading from the established reference value after a stated period of operation during which no unscheduled maintenance, repair, or adjustments took place.

Back-up CEMS (Secondary CEMS) - A CEMS with the ability to sample, analyze and record stack pollutant to determine gas concentration and/or emission rate. This CEMS is to serve as a back-up to the primary CEMS to minimize monitor downtime.

Excess Emissions - Any period in which the emissions exceed the permit limits.

Monitor Downtime - Any period during which the CEMS/COMS is unable to sample, analyze and record a minimum of four evenly spaced data points over an hour, except during one daily zero-span check during which two data points per hour are sufficient.

Out-of-Control Period - Begins with the time corresponding to the completion of the fifth, consecutive, daily CD check with a CD in excess of two times the allowable limit, or the time corresponding to the completion of the daily CD check preceding the daily CD check that results in a CD in excess of four times the allowable limit and the time corresponding to the completion of the sampling for the Relative Accuracy Test Audit (RATA), Relative Accuracy Audit (RAA), or Cylinder Gas Audit (CGA) which exceeds the limits outlined in Section IV. Out-of-Control Period ends with the time corresponding to the completion of the CD check following corrective action with the results being within the allowable CD limit or the completion of the sampling of the subsequent successful RATA, RAA, or CGA.

Primary CEMS - The main reporting CEMS with the ability to sample, analyze, and record stack pollutant to determine gas concentration and/or emission rate.

Relative Accuracy (RA) - The absolute mean difference between the gas concentration or emission rate determined by the CEMS and the value determined by the reference method plus the 2.5 percent error confidence coefficient of a series of tests divided by the mean of the reference method tests of the applicable emission limit.

Span Value – The upper limit of a gas concentration measurement range.

SECTION II

MONITORING REQUIREMENTS

** Only CEMS/COMS required by ADEQ permit for reasons other than Part 60, 63 or 75 shall comply with this section.

- A. For new sources, the installation date for the CEMS/COMS shall be no later than thirty (30) days from the date of start-up of the source.
- B. For existing sources, the installation date for the CEMS/COMS shall be no later than sixty (60) days from the issuance of the permit unless the permit requires a specific date.
- C. Within sixty (60) days of installation of a CEMS/COMS, a performance specification test (PST) must be completed. PST's are defined in 40 CFR, Part 60, Appendix B, PS 1-9. The Department may accept alternate PST's for pollutants not covered by Appendix B on a case-by-case basis. Alternate PST's shall be approved, in writing, by the ADEQ CEM Coordinator prior to testing.
- D. Each CEMS/COMS shall have, as a minimum, a daily zero-span check. The zero-span shall be adjusted whenever the 24-hour zero or 24-hour span drift exceeds two times the limits in the applicable performance specification in 40 CFR, Part 60, Appendix B. Before any adjustments are made to either the zero or span drifts measured at the 24-hour interval, the excess zero and span drifts measured must be quantified and recorded.
- E. All CEMS/COMS shall be in continuous operation and shall meet minimum frequency of operation requirements of 95% up-time for each quarter for each pollutant measured. Percent of monitor down-time is calculated by dividing the total minutes the monitor is not in operation by the total time in the calendar quarter and multiplying by one hundred. Failure to maintain operation time shall constitute a violation of the CEMS conditions.
- F. Percent of excess emissions are calculated by dividing the total minutes of excess emissions by the total time the source operated and multiplying by one hundred. Failure to maintain compliance may constitute a violation of the CEMS conditions.
- G. All CEMS measuring emissions shall complete a minimum of one cycle of operation (sampling, analyzing, and data recording) for each successive fifteen minute period unless more cycles are required by the permit. For each CEMS, one-hour averages shall be computed from four or more data points equally spaced over each one hour period unless more data points are required by the permit.
- H. All COMS shall complete a minimum of one cycle of sampling and analyzing for each successive 10-second period and one cycle of data recording for each successive 6-minute period.
- I. When the pollutant from a single affected facility is released through more than one point, a CEMS/COMS shall be installed on each point unless installation of fewer systems is approved, in writing, by the ADEQ

CEM Coordinator. When more than one CEM/COM is used to monitor emissions from one affected facility the owner or operator shall report the results as required from each CEMS/COMS.

SECTION III

NOTIFICATION AND RECORD KEEPING

** All CEMS/COMS shall comply with this section.

- A. When requested to do so by an owner or operator, the ADEQ CEM Coordinator will review plans for installation or modification for the purpose of providing technical advice to the owner or operator.
- B. Each facility which operates a CEMS/COMS shall notify the ADEQ CEM Coordinator of the date for which the demonstration of the CEMS/COMS performance will commence (i.e. PST, RATA, RAA, CGA). Notification shall be received in writing no less than 15 business days prior to testing. Performance test results shall be submitted to the Department within thirty days after completion of testing.
- C. Each facility which operates a CEMS/COMS shall maintain records of the occurrence and duration of start up/shut down, cleaning/soot blowing, process problems, fuel problems, or other malfunction in the operation of the affected facility which causes excess emissions. This includes any malfunction of the air pollution control equipment or any period during which a continuous monitoring device/system is inoperative.
- D. Each facility required to install a CEMS/COMS shall submit an excess emission and monitoring system performance report to the Department (Attention: Air Division, CEM Coordinator) at least quarterly, unless more frequent submittals are warranted to assess the compliance status of the facility. Quarterly reports shall be postmarked no later than the 30th day of the month following the end of each calendar quarter.
- E. All excess emissions shall be reported in terms of the applicable standard. Each report shall be submitted on ADEQ Quarterly Excess Emission Report Forms. Alternate forms may be used with prior written approval from the Department.
- F. Each facility which operates a CEMS/COMS must maintain on site a file of CEMS/COMS data including all raw data, corrected and adjusted, repair logs, calibration checks, adjustments, and test audits. This file must be retained for a period of at least five years, and is required to be maintained in such a condition that it can easily be audited by an inspector.
- G. Quarterly reports shall be used by the Department to determine compliance with the permit.

SECTION IV

QUALITY ASSURANCE/QUALITY CONTROL

** Only CEMS/COMS required by ADEQ permit for reasons other than Part 60, 63 or 75 shall comply with this section.

- A. For each CEMS/COMS a Quality Assurance/Quality Control (QA/QC) plan shall be submitted to the Department (Attn.: Air Division, CEM Coordinator). CEMS quality assurance procedures are defined in 40 CFR, Part 60, Appendix F. This plan shall be submitted within 180 days of the CEMS/COMS installation. A QA/QC plan shall consist of procedure and practices which assures acceptable level of monitor data accuracy, precision, representativeness, and availability.
- B. The submitted QA/QC plan for each CEMS/COMS shall not be considered as accepted until the facility receives a written notification of acceptance from the Department.
- C. Facilities responsible for one, or more, CEMS/COMS used for compliance monitoring shall meet these minimum requirements and are encouraged to develop and implement a more extensive QA/QC program, or to continue such programs where they already exist. Each QA/QC program must include written procedures which should describe in detail, complete, step-by-step procedures and operations for each of the following activities:
 - 1. Calibration of CEMS/COMS
 - a. Daily calibrations (including the approximate time(s) that the daily zero and span drifts will be checked and the time required to perform these checks and return to stable operation)
 - 2. Calibration drift determination and adjustment of CEMS/COMS
 - a. Out-of-control period determination
 - b. Steps of corrective action
 - 3. Preventive maintenance of CEMS/COMS
 - a. CEMS/COMS information
 - 1) Manufacture
 - 2) Model number
 - 3) Serial number
 - b. Scheduled activities (check list)
 - c. Spare part inventory
 - 4. Data recording, calculations, and reporting
 - 5. Accuracy audit procedures including sampling and analysis methods
 - 6. Program of corrective action for malfunctioning CEMS/COMS
- D. A Relative Accuracy Test Audit (RATA), shall be conducted at least once every four calendar quarters. A Relative Accuracy Audit (RAA), or a Cylinder Gas Audit (CGA), may be conducted in the other three

quarters but in no more than three quarters in succession. The RATA should be conducted in accordance with the applicable test procedure in 40 CFR Part 60 Appendix A and calculated in accordance with the applicable performance specification in 40 CFR Part 60 Appendix B. CGA's and RAA's should be conducted and the data calculated in accordance with the procedures outlined on 40 CFR Part 60 Appendix F.

If alternative testing procedures or methods of calculation are to be used in the RATA, RAA or CGA audits prior authorization must be obtained from the ADEQ CEM Coordinator.

E. Criteria for excessive audit inaccuracy.

RATA

All Pollutants except Carbon Monoxide	> 20% Relative Accuracy
Carbon Monoxide	> 10% Relative Accuracy
All Pollutants except Carbon Monoxide	> 10% of the Applicable Standard
Carbon Monoxide	> 5% of the Applicable Standard
Diluent (O ₂ & CO ₂)	> 1.0 % O ₂ or CO ₂
Flow	> 20% Relative Accuracy

CGA

Pollutant	> 15% of average audit value or 5 ppm difference
Diluent (O ₂ & CO ₂)	> 15% of average audit value or 5 ppm difference

RAA

Pollutant	> 15% of the three run average or > 7.5 % of the applicable standard
Diluent (O ₂ & CO ₂)	> 15% of the three run average or > 7.5 % of the applicable standard

- F. If either the zero or span drift results exceed two times the applicable drift specification in 40 CFR, Part 60, Appendix B for five consecutive, daily periods, the CEMS is out-of-control. If either the zero or span drift results exceed four times the applicable drift specification in Appendix B during a calibration drift check, the CEMS is out-of-control. If the CEMS exceeds the audit inaccuracies listed above, the CEMS is out-of-control. If a CEMS is out-of-control, the data from that out-of-control period is not counted towards meeting the minimum data availability as required and described in the applicable subpart. The end of the out-of-control period is the time corresponding to the completion of the successful daily zero or span drift or completion of the successful CGA, RAA or RATA.
- G. A back-up monitor may be placed on an emission source to minimize monitor downtime. This back-up CEMS is subject to the same QA/QC procedure and practices as the primary CEMS. The back-up CEMS shall be certified by a PST. Daily zero-span checks must be performed and recorded in accordance with standard practices. When the primary CEMS goes down, the back-up CEMS may then be engaged to sample, analyze and record the emission source pollutant until repairs are made and the primary unit is placed back in service. Records must be maintained on site when the back-up CEMS is placed in service, these records shall include at a minimum the reason the primary CEMS is out of service, the date and time the primary CEMS was out of service and the date and time the primary CEMS was placed back in service.

Appendix B

Subpart MMM—National Emission Standards for Hazardous Air Pollutants for Pesticide Active Ingredient Production

Contents

[§63.1360 Applicability.](#)

[§63.1361 Definitions.](#)

[§63.1362 Standards.](#)

[§63.1363 Standards for equipment leaks.](#)

[§63.1364 Compliance dates.](#)

[§63.1365 Test methods and initial compliance procedures.](#)

[§63.1366 Monitoring and inspection requirements.](#)

[§63.1367 Recordkeeping requirements.](#)

[§63.1368 Reporting requirements.](#)

[§63.1369 Implementation and enforcement.](#)

[Table 1 to Subpart MMM of Part 63—General Provisions Applicability to Subpart MMM](#)

[Table 2 to Subpart MMM of Part 63—Standards for New and Existing PAI Sources](#)

[Table 3 to Subpart MMM of Part 63—Monitoring Requirements for Control Devices](#)

[Table 4 to Subpart MMM of Part 63—Control Requirements for Items of Equipment That Meet the Criteria of §63.1362\(k\)](#)

SOURCE: 64 FR 33589, June 23, 1999, unless otherwise noted.

[↑ Back to Top](#)

§63.1360 Applicability.

(a) *Definition of affected source.* The affected source subject to this subpart is the facility-wide collection of pesticide active ingredient manufacturing process units (PAI process units) that process, use, or produce HAP, and are located at a plant site that is a major source, as defined in section 112(a) of the CAA. An affected source also includes waste management units, heat exchange systems, and cooling towers that are associated with the PAI process units. Exemptions from an affected source are specified in paragraph (d) of this section.

(b) *New source applicability.* A new affected source subject to this subpart and to which the requirements for new sources apply is defined according to the criteria in paragraph (b)(1) or (2) of this section.

(1) An affected source for which construction or reconstruction commenced after November 10, 1997.

(2) Any dedicated PAI process unit that meets the criteria specified in paragraphs (b)(2)(i) and (ii) of this section.

(i) For which construction, as defined in §63.1361, commenced after November 10, 1997, or reconstruction commenced after September 20, 2002.

(ii) That has the potential to emit 10 tons/yr of any one HAP or 25 tons/yr of combined HAP.

(c) *General provisions.* Table 1 of this subpart specifies the provisions of subpart A of this part that apply to an owner or operator of an affected source subject to this subpart, and clarifies specific provisions in subpart A of this part as necessary for this subpart.

(d) *Exemptions from the requirements of this subpart.* The provisions of this subpart do not apply to:

(1) Research and development facilities;

(2) PAI process units that are subject to subpart F of this part;

(3) Production of ethylene;

(4) Coal tar distillation; and

(5) The following emission points listed:

(i) Storm water from segregated sewers;

(ii) Water from fire-fighting and deluge systems, including testing of such systems;

(iii) Spills;

(iv) Water from safety showers;

(v) Noncontact steam boiler blowdown and condensate;

(vi) Laundry water;

(vii) Vessels storing material that contains no organic HAP or contains organic HAP as impurities only; and

(viii) Equipment, as defined in §63.1363, that is intended to operate in organic HAP service for less than 300 hours during the calendar year.

(e) *Applicability of this subpart.* (1) Each provision set forth in this subpart shall apply at all times except during periods of non-operation of the affected source (or specific portion thereof) resulting in cessation of the emissions to which this subpart applies.

(i) The startup, shutdown, or malfunction precludes the ability of the owner or operator of an affected source to comply with one or more specific emission limitations to which a particular emission point is subject; and

(ii) The owner or operator follows the provisions for periods of startup, shutdown, and malfunction, as specified in §§63.1367(a)(3) and 63.1368(i).

(2) The provisions set forth in §63.1363 shall apply at all times except during periods of nonoperation of the PAI process unit (or specific portion thereof) in which the lines are drained and depressurized resulting in the cessation of the emissions to which §63.1363 applies.

(3) The owner or operator shall not shut down items of equipment that are required or utilized for compliance with the emissions limitations of this subpart during times when emissions (or, where

applicable, wastewater streams or residuals) are being routed to such items of equipment, if the shutdown would contravene emissions limitations of this subpart applicable to such items of equipment.

(4) *General duty.* At all times, the owner or operator must operate and maintain any affected source, including associated air pollution control equipment and monitoring equipment, in a manner consistent with safety and good air pollution control practices for minimizing emissions. The general duty to minimize emissions does not require the owner or operator to make any further efforts to reduce emissions if levels required by the applicable standard have been achieved. Determination of whether a source is operating in compliance with operation and maintenance requirements will be based on information available to the Administrator, which may include, but is not limited to, monitoring results, review of operation and maintenance procedures, review of operation and maintenance records, and inspection of the source.

(f) *Storage vessel applicability determination.* An owner or operator shall follow the procedures specified in paragraphs (f)(1) through (5) of this section to determine whether a storage vessel is part of the affected source to which this subpart applies.

(1) If a storage vessel is already subject to another subpart of 40 CFR part 63 on June 23, 1999, the storage vessel shall belong to the process unit subject to the other subpart.

(2) Unless otherwise excluded under paragraph (f)(1) of this section, the storage vessel is part of a PAI process unit if either the input to the vessel from the PAI process unit is greater than or equal to the input from any other PAI or non-PAI process unit, or the output from the vessel to the PAI process unit is greater than or equal to the output to any other PAI or non-PAI process unit. If the greatest input to and/or output from a shared storage vessel is the same for two or more process units, including one or more PAI process units, the owner or operator must assign the storage vessel to any one of the PAI process units that meet this condition.

(3) Unless otherwise excluded under paragraph (f)(1) of this section, where a storage vessel is located in a tank farm (including a marine tank farm), the applicability of this subpart shall be determined according to the provisions in paragraphs (f)(3)(i) through (iii) of this section.

(i) The storage vessel in the tank farm is not subject to the provisions of this subpart if the greatest input to or output from the storage vessel is for a non-PAI process unit. The input and output shall be determined among only those process units that share the storage vessel and that do not have an intervening storage vessel for that product (or raw material, as appropriate).

(ii) Except for storage vessels in a tank farm excluded in accordance with paragraph (f)(3)(i) of this section, applicability of this subpart shall be determined according to the provisions in paragraphs (f)(3)(ii)(A) through (C) of this section.

(A) Except as specified in paragraph (f)(3)(ii)(C) of this section, this subpart does not apply to the storage vessel in a tank farm if each PAI process unit that receives material from or sends material to the storage vessel has an intervening storage vessel for that material.

(B) Except as specified in paragraph (f)(3)(ii)(C) of this section, a storage vessel in a tank farm shall be assigned to the PAI process unit that receives the greatest amount of material from or sends the greatest amount of material to the storage vessel and does not have an intervening storage vessel. If two or more PAI process units have the same input to or output from the storage vessel in the tank farm, then the storage vessel in the tank farm may be assigned to any one of the PAI process units that meet this condition.

(C) As an alternative to the requirements specified in paragraphs (f)(3)(ii)(A) and (B) of this section, even if an intervening storage vessel is present, an owner or operator may elect to assign a storage vessel in a tank farm to the PAI process unit that sends the most material to or receives the most material

from the storage vessel. If two or more PAI process units have the same input to or output from the storage vessel in the tank farm, then the storage vessel in the tank farm may be assigned to any one of the PAI process units that meet this condition.

(iii) With respect to a process unit, an intervening storage vessel means a storage vessel connected by hard-piping to the process unit and to the storage vessel in the tank farm so that the product or raw material entering or leaving the process flows into (or from) the intervening storage vessel and does not flow directly into (or from) the storage vessel in the tank farm.

(4) If use varies from year to year, then use for the purposes of this subpart for existing sources shall be based on the utilization that occurred during the year preceding June 23, 1999, or if the storage vessel was not in operation during that year, the use shall be based on the expected use in the 5 years after startup. This determination shall be reported as part of an operating permit application or as otherwise specified by the permitting authority.

(5) If the storage vessel begins receiving material from (or sending material to) another process unit, or ceasing to receive material from (or send material to) a PAI process unit, or if there is a significant change in the use of the storage vessel, the owner or operator shall reevaluate the ownership determination for the storage vessel.

(g) *Designating production of an intermediate as a PAI process unit.* Except as specified in paragraph (d) of this section, an owner or operator may elect to designate production of any intermediate that does not meet the definition of integral intermediate as a PAI process unit subject to this subpart. Any storage vessel containing the intermediate is assigned to a PAI process unit according to the procedures in paragraph (f) of this section. Any process tank containing the intermediate is part of the process unit used to produce the intermediate.

(h) *Applicability of process units included in a process unit group.* An owner or operator may elect to develop process unit groups in accordance with paragraph (h)(1) of this section. For the PAI process units in these process unit groups, the owner or operator may comply with the provisions in overlapping MACT standards, as specified in paragraphs (h)(2) through (4) of this section, as an alternative means of demonstrating compliance with the provisions of this subpart.

(1) Develop, revise, and document changes in a process unit group in accordance with the procedures specified in paragraphs (h)(1)(i) through (vi) of this section.

(i) Initially identify a non-dedicated PAI process unit that is operating on December 23, 2003 or a date after December 23, 2003, and identify all processing equipment that is part of this PAI process unit, based on descriptions in operating scenarios.

(ii) Add to the group any other non-dedicated PAI and non-dedicated non-PAI process units expected to be operated in the 5 years after the date specified in paragraph (h)(1)(i) of this section, provided they satisfy the criteria specified in paragraphs (h)(1)(ii)(A) through (C) of this section. Also identify all of the processing equipment used for each process unit based on information from operating scenarios and other applicable documentation.

(A) Each PAI process unit that is added to a group must have some processing equipment that is part of one or more PAI process units that are already in the process unit group.

(B) Each non-PAI process unit that is added to a group must have some processing equipment that is also part of one or more of the PAI process units in the group.

(C) No process unit may be part of more than one process unit group.

(iii) The initial process unit group consists of all of the processing equipment for the process units identified in paragraphs (h)(1)(i) and (ii) of this section.

(iv) If compliance is to be demonstrated in accordance with paragraph (h)(3) of this section, determine the primary product of the process unit group according to the procedures specified in paragraphs (h)(1)(iv)(A) through (C) of this section.

(A) The primary product is the type of product (e.g., PAI, pharmaceutical product, thermoplastic resin, etc.) that is expected to be produced for the greatest operating time in the 5-year period specified in paragraph (h)(1)(i) of this section.

(B) If the process unit group produces multiple products equally based on operating time, then the primary product is the product with the greatest production on a mass basis over the 5-year period specified in paragraph (h)(1)(i) of this section.

(C) The primary product of the group must be redetermined if the owner or operator does not intend to make that product in the future or if it has not been made for 5 years. The results of the redetermination must be recorded as specified in §63.1367(b) and reported in a Periodic report no later than the report covering the period for the end of the 5th year as specified in §63.1368(g)(2). If the primary product changes, the owner or operator must either demonstrate compliance with the applicable subpart as specified in paragraph (h)(3) of this section or demonstrate compliance with the provisions of this subpart MMM.

(v) Add process units developed in the future in accordance with the conditions specified in paragraphs (h)(1)(ii)(A) through (C) of this section.

(vi) Maintain records of changes in the process units in each process unit group as specified in §63.1367(b)(9), and maintain reports as specified in §63.1368(f)(9) and (g)(2)(ix).

(2) If any of the products produced in the process unit group are subject to 40 CFR part 63, subpart GGG (Pharmaceuticals MACT), the owner or operator may elect to comply with the requirements of subpart GGG for the PAI process unit(s) within the process unit group, except for the following:

(i) The emission limit standard for process vents in §63.1362(b)(2)(i) shall apply in place of §63.1254(a)(2);

(ii) When the dates of April 2, 1997 and April 2, 2007 are provided in §63.1254(a)(3)(ii), the dates of November 10, 1997 and November 10, 2007, respectively, shall apply for purposes of this subpart MMM; and

(iii) Requirements in §63.1367(a)(5) regarding application for approval of construction or reconstruction shall apply in place of the provisions in §63.1259(a)(5).

(3) If the primary product of a process unit group is determined to be a type of material that is subject to another subpart of 40 CFR part 63 on June 23, 1999 or startup of the first process unit after formation of the process unit group, whichever is later, the owner or operator may elect to comply with the other subpart for any PAI process unit within the process unit group, subject to the requirement in this paragraph (h)(3). Emissions from PAI Group 1 process vents, as defined in §63.1361, must be reduced in accordance with the control requirements for Group 1 vents as specified in the alternative subpart. The criteria in the alternative subpart for determining which process vents must be controlled do not apply for the purposes of this paragraph (h)(3).

(4) The requirements for new and reconstructed sources in the alternative subpart apply to all PAI process units in the process unit group if, and only if, the affected source under the alternative subpart meets the requirements for construction or reconstruction.

(i) *Overlap with other regulations—(1) Compliance with other MACT standards.* (i) After the compliance dates specified in §63.1364, an affected source subject to the provisions of this subpart that is also subject to the provisions of any other subpart of 40 CFR part 63 may elect, to the extent the subparts are consistent, under which subpart to maintain records and report to EPA. The affected source shall identify in the Notification of Compliance Status report required by §63.1368(f) under which authority such records will be maintained.

(ii) After the compliance dates specified in §63.1364, at an offsite reloading or cleaning facility subject to §63.1362(b)(6), compliance with the emission standards and associated initial compliance monitoring, recordkeeping, and reporting provisions of any other subpart of 40 CFR part 63 constitutes compliance with the provisions of §63.1362(b)(6)(vii)(B) or (C). The owner or operator of the affected storage vessel shall identify in the Notification of Compliance Status report required by §63.1368(f) the subpart of 40 CFR part 63 with which the owner or operator of the offsite reloading or cleaning facility complies.

(2) *Overlap with RCRA subparts AA, BB, and/or CC.* After the compliance dates specified in §63.1364, if any affected source subject to this subpart is also subject to monitoring, recordkeeping, and reporting requirements in 40 CFR part 264, subpart AA, BB, or CC, or is subject to monitoring and recordkeeping requirements in 40 CFR part 265, subpart AA, BB, or CC, and the owner or operator complies with the periodic reporting requirements under 40 CFR part 264, subpart AA, BB, or CC that would apply to the device if the facility had final-permitted status, the owner or operator may elect to comply either with the monitoring, recordkeeping, and reporting requirements of this subpart, or with the monitoring, recordkeeping, and reporting requirements in 40 CFR parts 264 and/or 265, as described in this paragraph, which shall constitute compliance with the monitoring, recordkeeping, and reporting requirements of this subpart. If the owner or operator elects to comply with the monitoring, recordkeeping, and reporting requirements in 40 CFR parts 264 and/or 265, the owner or operator shall report all excursions as required by §63.1368(g). The owner or operator shall identify in the Notification of Compliance Status report required by §63.1368(f) the monitoring, recordkeeping, and reporting authority under which the owner or operator will comply.

(3) *Overlap with NSPS subpart Kb.* After the compliance dates specified in §63.1364, a Group 1 or Group 2 storage vessel that is also subject to the provisions of 40 CFR part 60, subpart Kb, is required to comply only with the provisions of this subpart MMM.

(4) *Overlap with subpart I.* After the compliance dates specified in §63.1364, for all equipment within a process unit that contains equipment subject to subpart I of this part, an owner or operator may elect to comply with either the provisions of this subpart MMM or the provisions of subpart H of this part. The owner or operator shall identify in the Notification of Compliance Status report required by §63.1368(f) the provisions with which the owner or operator elects to comply.

(5) *Overlap with RCRA regulations for wastewater.* After the compliance dates specified in §63.1364, the owner or operator of an affected wastewater stream that is also subject to provisions in 40 CFR parts 260 through 272 shall comply with the more stringent control requirements (e.g., waste management units, numerical treatment standards, etc.) and the more stringent testing, monitoring, recordkeeping, and reporting requirements that overlap between the provisions of this subpart and the provisions of 40 CFR parts 260 through 272. The owner or operator shall keep a record of the information used to determine which requirements were the most stringent and shall submit this information if requested by the Administrator.

(6) *Overlap with NSPS subparts III, NNN, and RRR.* After the compliance dates specified in §63.1364, if an owner or operator of a process vent subject to this subpart MMM that is also subject to the provisions of 40 CFR part 60, subpart III, or subpart NNN, or subpart RRR, elects to reduce organic HAP emissions from the process vent by 98 percent as specified in §63.1362(b)(2)(iii)(A), then the owner or operator is required to comply only with the provisions of this subpart MMM. Otherwise, the owner or operator shall comply with the provisions in both this subpart MMM and the provisions in 40 CFR part 60, subparts III, NNN, and RRR, as applicable.

(j) *Meaning of periods of time.* All terms in this subpart MMM that define a period of time for completion of required tasks (e.g., weekly, monthly, quarterly, annual), unless specified otherwise in the section or subsection that imposes the requirement, refer to the standard calendar periods.

(1) Notwithstanding time periods specified in the subpart MMM for completion of required tasks, such time periods may be changed by mutual agreement between the owner and operator and the Administrator, as specified in subpart A of this part (e.g., a period could begin on the compliance date or another date, rather than on the first day of the standard period). For each time period that is changed by agreement, the revised period shall remain in effect until it is changed. A new request is not necessary for each recurring period.

(2) Where the period specified for compliance is a standard calendar period, if the initial compliance date occurs after the beginning of the period, compliance shall be required according to the schedule specified in paragraph (j)(2)(i) or (ii) of this section, as appropriate.

(i) Compliance shall be required before the end of the standard calendar period within which the compliance deadline occurs, if there remain at least 3 days for tasks that must be performed weekly, at least 2 weeks for tasks that must be performed monthly, at least 1 month for tasks that must be performed each quarter, or at least 3 months for tasks that must be performed annually; or

(ii) In all other cases, compliance shall be required before the end of the first full standard calendar period within which the initial compliance deadline occurs.

(3) In all instances where a provision of this subpart MMM requires completion of a task during each of multiple successive periods, an owner or operator may perform the required task at any time during the specified period, provided the task is conducted at a reasonable interval after completion of the task in the previous period.

(k) *Affirmative defense for violation of emission standards during malfunction.* In response to an action to enforce the standards set forth in this subpart, the owner or operator may assert an affirmative defense to a claim for civil penalties for violations of such standards that are caused by malfunction, as defined at §63.2. Appropriate penalties may be assessed if the owner or operator fails to meet their burden of proving all of the requirements in the affirmative defense. The affirmative defense shall not be available for claims for injunctive relief.

(1) *Assertion of affirmative defense.* To establish the affirmative defense in any action to enforce such a standard, the owner or operator must timely meet the reporting requirements in paragraph (k)(2) of this section, and must prove by a preponderance of evidence that:

(i) The violation:

(A) Was caused by a sudden, infrequent, and unavoidable failure of air pollution control equipment, process equipment, or a process to operate in a normal or usual manner; and

(B) Could not have been prevented through careful planning, proper design or better operation and maintenance practices; and

(C) Did not stem from any activity or event that could have been foreseen and avoided, or planned for; and

(D) Was not part of a recurring pattern indicative of inadequate design, operation, or maintenance; and

(ii) Repairs were made as expeditiously as possible when a violation occurred; and

(iii) The frequency, amount, and duration of the violation (including any bypass) were minimized to the maximum extent practicable; and

(iv) If the violation resulted from a bypass of control equipment or a process, then the bypass was unavoidable to prevent loss of life, personal injury, or severe property damage; and

(v) All possible steps were taken to minimize the impact of the violation on ambient air quality, the environment, and human health; and

(vi) All emissions monitoring and control systems were kept in operation if at all possible, consistent with safety and good air pollution control practices; and

(vii) All of the actions in response to the violation were documented by properly signed, contemporaneous operating logs; and

(viii) At all times, the affected source was operated in a manner consistent with good practices for minimizing emissions; and

(ix) A written root cause analysis has been prepared, the purpose of which is to determine, correct, and eliminate the primary causes of the malfunction and the violation resulting from the malfunction event at issue. The analysis shall also specify, using best monitoring methods and engineering judgment, the amount of any emissions that were the result of the malfunction.

(2) *Report.* The owner or operator seeking to assert an affirmative defense shall submit a written report to the Administrator, with all necessary supporting documentation, that explains how it has met the requirements set forth in paragraph (k)(1) of this section. This affirmative defense report shall be included in the first periodic compliance report, deviation report, or excess emission report otherwise required after the initial occurrence of the violation of the relevant standard (which may be the end of any applicable averaging period). If such compliance, deviation report or excess emission report is due less than 45 days after the initial occurrence of the violation, the affirmative defense report may be included in the second compliance, deviation report or excess emission report due after the initial occurrence of the violation of the relevant standard.

[64 FR 33589, June 23, 1999, as amended at 67 FR 59340, Sept. 20, 2002; 79 FR 17371, Mar. 27, 2014]

 [Back to Top](#)

§63.1361 Definitions.

Terms used in this subpart are defined in the CAA, in subpart A of this part, or in this section. If the same term is defined in subpart A of this part and in this section, it shall have the meaning given in this section for the purposes of this subpart MMM.

Affirmative defense means, in the context of an enforcement proceeding, a response or defense put forward by a defendant, regarding which the defendant has the burden of proof, and the merits of which are independently and objectively evaluated in a judicial or administrative proceeding.

Air pollution control device or control device means equipment installed on a process vent, storage vessel, wastewater treatment exhaust stack, or combination thereof that reduces the mass of HAP emitted to the air. The equipment may consist of an individual device or a series of devices. Examples include incinerators, carbon adsorption units, condensers, flares, boilers, process heaters, and gas absorbers. Process condensers are not considered air pollution control devices or control devices.

Bag dump means equipment into which bags or other containers containing a powdered, granular, or other solid feedstock material are emptied. A bag dump is part of the process.

Batch emission episode means a discrete venting episode that is associated with a single unit operation. A unit operation may have more than one batch emission episode. For example, a batch distillation unit operation may consist of batch emission episodes associated with charging and heating. Charging the vessel with HAP will result in one discrete batch emission episode that will last through the duration of the charge and will have an average flowrate equal to the rate of the charge. Another discrete batch emission episode will result from the expulsion of expanded vapor as the contents of the vessel are heated.

Batch operation means a noncontinuous operation involving intermittent or discontinuous feed into PAI or integral intermediate manufacturing equipment, and, in general, involves the emptying of the equipment after the batch operation ceases and prior to beginning a new operation. Addition of raw material and withdrawal of product do not occur simultaneously in a batch operation. A batch process consists of a series of batch operations.

Bench-scale batch process means a batch process (other than a research and development facility) that is capable of being located on a laboratory bench top. This bench-scale equipment will typically include reagent feed vessels, a small reactor and associated product separator, recovery and holding equipment. These processes are only capable of producing small quantities of product.

Block means a time period equal to, at a maximum, the duration of a single batch.

Car seal means a seal that is placed on a device that is used to change the position of a valve (e.g., from opened to closed) in such a way that the position of the valve cannot be changed without breaking the seal.

Cleaning operation means routine rinsing, washing, or boil-off of equipment in batch operations between batches.

Closed-loop system means an enclosed system that returns process fluid to the process and is not vented to the atmosphere except through a closed-vent system.

Closed-purge system means a system or combination of system and portable containers, to capture purged liquids. Containers must be covered or closed when not being filled or emptied.

Closed-vent system means a system that is not open to the atmosphere and is composed of piping, ductwork, connections, and, if necessary, flow inducing devices that transport gas or vapor from an emission point to a control device.

Combustion device means an individual unit of equipment, such as a flare, incinerator, process heater, or boiler, used for the combustion of organic HAP vapors.

Connector means flanged, screwed, or other joined fittings used to connect two pipe lines or a pipe line and a piece of equipment. A common connector is a flange. Joined fittings welded completely around the circumference of the interface are not considered connectors for the purpose of this regulation. For the purpose of reporting and record keeping, connector means joined fittings that are not inaccessible, ceramic, or ceramic-lined as described in §63.1255(b)(1)(vii) and 63.1255(f)(3).

Construction means the onsite fabrication, erection, or installation of an affected source or dedicated PAI process unit. Addition of new equipment to an affected source does not constitute construction, provided the new equipment is not a dedicated PAI process unit with the potential to emit 10 tons/yr of any one HAP or 25 tons/yr of combined HAP, but it may constitute reconstruction of the affected source or PAI process unit if it satisfies the definition of reconstruction in this section. At an affected source, changing raw materials processed and reconfiguring non-dedicated equipment to create a non-dedicated PAI process unit do not constitute construction.

Consumption means the quantity of all HAP raw materials entering a process in excess of the theoretical amount used as reactant, assuming 100 percent stoichiometric conversion. The raw materials include reactants, solvents, and any other additives. If HAP are generated in the process as well as added as raw material, consumption includes the quantity generated in the process.

Container, as used in the wastewater provisions, means any portable waste management unit that has a capacity greater than or equal to 0.1 m³ in which a material is stored, transported, treated, or otherwise handled. Examples of containers are drums, barrels, tank trucks, barges, dumpsters, tank cars, dump trucks, and ships.

Continuous process means a process where the inputs and outputs flow continuously throughout the duration of the process. Continuous processes typically approach steady state.

Continuous seal means a seal that forms a continuous closure that completely covers the space between the wall of the storage vessel and the edge of the floating roof. A continuous seal may be a vapor-mounted, liquid-mounted, or metallic shoe seal.

Controlled HAP emissions means the quantity of HAP components discharged to the atmosphere from an air pollution control device.

Cover, as used in the wastewater provisions, means a device or system which is placed on or over a waste management unit containing wastewater or residuals so that the entire surface area is enclosed to minimize air emissions. A cover may have openings necessary for operation, inspection, and maintenance of the waste management unit such as access hatches, sampling ports, and gauge wells provided that each opening is closed when not in use. Examples of covers include a fixed roof installed on a wastewater tank, a lid installed on a container, and an air-supported enclosure installed over a waste management unit.

Dedicated PAI process unit means a PAI process unit constructed from equipment that is fixed in place and designed and operated to produce only a single product or co-products. The equipment is not designed to be reconfigured to create different process units, and it is not operated with different raw materials so as to produce different products.

Double block and bleed system means two block valves connected in series with a bleed valve or line that can vent the line between the two block valves.

Duct work means a conveyance system such as those commonly used for heating and ventilation systems. It is often made of sheet metal and often has sections connected by screws or crimping. Hard-piping is not ductwork.

Equipment, for purposes of §63.1363, means each pump, compressor, agitator, pressure relief device, sampling connection system, open-ended valve or line, valve, connector, and instrumentation system in organic hazardous air pollutant service.

External floating roof means a pontoon-type or double-deck type cover that rests on the liquid surface in a storage tank or waste management unit with no fixed roof.

FIFRA means the Federal Insecticide, Fungicide, and Rodenticide Act.

Fill or filling means the introduction of organic HAP into a storage tank or the introduction of a wastewater stream or residual into a waste management unit, but not necessarily to complete capacity.

First attempt at repair means to take action for the purpose of stopping or reducing leakage of organic material to the atmosphere.

Fixed roof means a cover that is mounted on a waste management unit or storage tank in a stationary manner and that does not move with fluctuations in liquid level.

Flame ionization detector (FID) means a device in which the measured change in conductivity of a standard flame (usually hydrogen) due to the insertion of another gas or vapor is used to detect the gas or vapor.

Floating roof means a cover consisting of a double deck, pontoon single deck, internal floating cover or covered floating roof, which rests upon and is supported by the liquid being contained, and is equipped with a continuous seal or seals to close the space between the roof edge and waste management unit or storage vessel wall.

Flow indicator means a device that indicates whether gas flow is, or whether the valve position would allow gas flow to be, present in a line.

Formulation of pesticide products means the mixing, blending, or diluting of a PAI with one or more other PAI or inert ingredients.

Group 1 process vent means any process vent from a process at an existing or new affected source for which the uncontrolled organic HAP emissions from the sum of all process vents are greater than or equal to 0.15 Mg/yr and/or the uncontrolled hydrogen chloride (HCl) and chlorine emissions from the sum of all process vents are greater than or equal to 6.8 Mg/yr.

Group 1 storage vessel means a storage vessel at an existing affected source with a capacity equal to or greater than 75 m³ and storing material with a maximum true vapor pressure greater than or equal to 3.45 kPa, a storage vessel at a new affected source with a capacity equal to or greater than 40 m³ and storing material with a maximum true vapor pressure greater than or equal to 16.5 kPa, or a storage vessel at a new affected source with a capacity greater than or equal to 75 m³ and storing material with a maximum true vapor pressure greater than or equal to 3.45 kPa.

Group 1 wastewater stream means process wastewater at an existing or new source that meets the criteria for Group 1 status in §63.132(c) for compounds in Table 9 of subpart G of this part or a maintenance wastewater stream that contains 5.3 Mg of compounds in Table 9 of subpart G of this part per discharge event.

Group 2 process vent means any process vent that does not meet the definition of a Group 1 process vent.

Group 2 storage vessel means a storage vessel that does not meet the definition of a Group 1 storage vessel.

Group 2 wastewater stream means any wastewater stream that does not meet the definition of a Group 1 wastewater stream.

Group of processes means all of the equipment associated with processes in a building, processing area, or facility-wide. A group of processes may consist of a single process.

Halogenated compounds means organic compounds that contain chlorine atoms.

Halogenated vent stream means a process, storage vessel, or waste management unit vent stream determined to have a concentration of halogenated compounds of greater than 20 ppmv, as determined through process knowledge, test results using Method 18 of 40 CFR part 60, appendix A, or test results using any other test method that has been validated according to the procedures in Method 301 of appendix A of this part.

Hard-piping means piping or tubing that is manufactured and properly installed using good engineering judgment and standards, such as ANSI B31-3.

Impurity means a substance that is produced coincidentally with the product(s), or is present in a raw material. An impurity does not serve a useful purpose in the production or use of the product(s) and is not isolated.

In gas/vapor service means that a piece of equipment in organic HAP service contains a gas or vapor at operating conditions.

In heavy liquid service means that a piece of equipment in organic HAP service is not in gas/vapor service or in light liquid service.

In light liquid service means that a piece of equipment in organic HAP service contains a liquid that meets the following conditions:

- (1) The vapor pressure of one or more of the organic compounds is greater than 0.3 kPa at 20 °C;
- (2) The total concentration of the pure organic compounds constituents having a vapor pressure greater than 0.3 kPa at 20 °C is equal to or greater than 20 percent by weight of the total process stream; and
- (3) The fluid is a liquid at operating conditions.

NOTE: To definition of "In light liquid service: Vapor pressures may be determined by the methods described in 40 CFR 60.485(e)(1).

In liquid service means that a piece of equipment in organic HAP service is not in gas/vapor service.

In organic hazardous air pollutant or in organic HAP service means that a piece of equipment either contains or contacts a fluid (liquid or gas) that is at least 5 percent by weight of total organic HAP as determined according to the provisions of §63.180(d) of subpart H of this part. The provisions of §63.180(d) of subpart H of this part also specify how to determine that a piece of equipment is not in organic HAP service.

In vacuum service means that equipment is operating at an internal pressure which is at least 5 kPa below ambient pressure.

In-situ sampling systems means nonextractive samplers or in-line samplers.

Individual drain system means the stationary system used to convey wastewater streams or residuals to a waste management unit or to discharge or disposal. The term includes: hard piping; all process drains and junction boxes; and associated sewer lines, other junction boxes, manholes, sumps, and lift stations conveying wastewater streams or residuals. A segregated stormwater sewer system, which is a drain and collection system designed and operated for the sole purpose of collecting rainfall-runoff at a facility, and which is segregated from all other individual drain systems, is excluded from this definition.

Instrumentation system means a group of equipment components used to condition and convey a sample of the process fluid to analyzers and instruments for the purpose of determining process operating conditions (e.g., composition, pressure, flow, etc.). Valves and connectors are the predominant type of equipment used in instrumentation systems; however, other types of equipment may also be included in these systems. Only valves nominally 0.5 inches and smaller and connectors nominally 0.75 inches and smaller in diameter are considered instrumentation systems for the purposes of this subpart. Valves greater than nominally 0.5 inches and connectors greater than nominally 0.75 inches associated with instrumentation systems are not considered part of instrumentation systems and must be monitored individually.

Integral intermediate means an intermediate for which 50 percent or more of the annual production is used in on-site production of any PAI(s) and that is not stored before being used in the production of another integral intermediate or the PAI(s). For the purposes of this definition, an intermediate is stored if it is discharged to a storage vessel and at least one of the following conditions is met: the processing equipment that discharges to the storage vessel is shutdown before the processing equipment that withdraws from the storage vessel is started up; during an annual period, the material must be stored in the vessel for at least 30 days before being used to make a PAI; or the processing equipment that discharges to the storage vessel is located in a separate building (or processing area) of the plant than the processing equipment that uses material from the storage vessel as a feedstock, and control equipment is not shared by the two processing areas. Any process unit that produces an intermediate and is subject to subpart F of this part is not an integral intermediate.

Intermediate means an organic compound that is manufactured in a process and that is further processed or modified in one or more additional steps to ultimately produce a PAI.

Internal floating roof means a cover that rests or floats on the liquid surface (but not necessarily in complete contact with it) inside a storage tank or waste management unit that has a permanently affixed roof.

Junction box means a manhole or access point to a wastewater sewer system line or a lift station.

Large control device means a control device that controls process vents, and the total HAP emissions into the control device from all sources are greater than or equal to 10 tons/yr.

Liquid-mounted seal means a foam- or liquid-filled seal mounted in contact with the liquid between the wall of the storage vessel or waste management unit and the floating roof. The seal is mounted continuously around the tank or unit.

Liquids dripping means any visible leakage from the seal including dripping, spraying, misting, clouding, and ice formation. Indications of liquid dripping include puddling or new stains that are indicative of an existing evaporated drip.

Maintenance wastewater means wastewater generated by the draining of process fluid from components in the PAI process unit into an individual drain system prior to or during maintenance activities. Maintenance wastewater can be generated through planned or unplanned shutdowns and during periods not associated with a shutdown. Examples of activities that can generate maintenance wastewaters include descaling of heat exchanger tubing bundles, cleaning of distillation column traps, draining of low legs and high point bleeds, draining of pumps into an individual drain system, and draining of portions of the PAI process unit for repair.

Malfunction means any sudden, infrequent, and not reasonably preventable failure of air pollution control equipment, emissions monitoring equipment, process equipment, or a process to operate in a normal or usual manner which causes, or has the potential to cause, the emission limitations in an applicable standard to be exceeded. Failures that are caused all or in part by poor maintenance or careless operation are not malfunctions.

Maximum true vapor pressure means the equilibrium partial pressure exerted by the total organic HAP in the stored or transferred liquid at the temperature equal to the highest calendar-month average of the liquid storage or transferred temperature for liquids stored or transferred above or below the ambient temperature or at the local maximum monthly average temperature as reported by the National Weather Service for liquids stored or transferred at the ambient temperature, as determined:

(1) In accordance with methods described in Chapter 19.2 of the American Petroleum Institute's Manual of Petroleum Measurement Standards, Evaporative Loss From Floating-Roof Tanks (incorporated by reference as specified in §63.14 in subpart A of this part); or

(2) As obtained from standard reference texts; or

(3) As determined by the American Society for Testing and Materials Method D2879-97, Test Method for Vapor Pressure-Temperature Relationship and Initial Decomposition Temperature of Liquids by Isotenoscope (incorporated by reference as specified in §63.14 of subpart A of this part); or

(4) Any other method approved by the Administrator.

Metallic shoe seal or mechanical shoe seal means metal sheets that are held vertically against the wall of the storage tank by springs, weighted levers, or other mechanisms and connected to the floating roof by braces or other means. A flexible coated fabric (envelope) spans the annular space between the metal sheet and the floating roof.

Non-dedicated PAI process unit means a process unit that is not a dedicated PAI process unit.

Nonrepairable means that it is technically infeasible to repair a piece of equipment from which a leak has been detected without a process shutdown.

Open-ended valve or line means any valve, except pressure relief valves, having one side of the valve seat in contact with process fluid and one side open to atmosphere, either directly or through open piping.

Operating scenario, for the purposes of reporting and recordkeeping, means a description of a PAI process unit, including: identification of each wastewater point of determination (POD) and process vent, their associated emissions episodes and durations, and their associated level of control and control devices, as applicable; calculations and engineering analyses required to demonstrate compliance; and a description of operating and/or testing conditions for any associated control device.

Organic compound, as used in the definitions of intermediate and PAI, means any compound that contains both carbon and hydrogen with or without other elements.

Organic HAP means those HAP listed in section 112(b) of the CAA that are measured according to the procedures of Method 18 or Method 25A, 40 CFR part 60, appendix A.

Pesticide active ingredient or PAI means any material that is an active ingredient within the meaning of FIFRA section 2(a); that is used to produce an insecticide, herbicide, or fungicide end use pesticide product; that consists of one or more organic compounds; and that must be labeled in accordance with 40 CFR part 156 for transfer, sale, or distribution. These materials are typically described by North American Industrial Classification System (NAICS) Codes 325199 and 32532 (i.e., previously known as Standard Industrial Classification System Codes 2869 and 2879). These materials are identified by product classification codes 01, 21, 02, 04, 44, 07, 08, and 16 in block 19 on the 1999 version of EPA form 3540-16, the Pesticides Report for Pesticide-Producing Establishments. The materials represented by these codes are: insecticides; insecticide-fungicides; fungicides; herbicides; herbicide-fungicides; plant regulators; defoliants, desiccants; or multi-use active ingredients.

Pesticide active ingredient manufacturing process unit (PAI process unit) means a process unit that is used to produce a material that is primarily used as a PAI or integral intermediate. A PAI process unit consists of: the process, as defined in this subpart; associated storage vessels, as determined by the procedures in §63.1360(f); equipment identified in §63.1362(k); connected piping and ducts; and components such as pumps, compressors, agitators, pressure relief devices, sampling connection systems, open-ended valves or lines, valves, connectors, and instrumentation systems. A material is primarily used as a PAI or integral intermediate if more than 50 percent of the projected annual production from a process unit in the 3 years after June 23, 1999 or startup, whichever is later, is used as a PAI or integral intermediate; recordkeeping is required if the material is used as a PAI or integral intermediate, but not as the primary use. If the primary use changes to a PAI or integral intermediate, the process unit becomes a PAI process unit unless it is already subject to the HON. If the primary use changes from a PAI or integral intermediate to another use, the process unit remains a PAI process unit. Any process tank containing an integral intermediate is part of the PAI process unit used to produce the integral intermediate. A process unit that produces an intermediate that is not an integral intermediate may be designated as a PAI process unit according to the procedures of §63.1360(g). Formulation of pesticide products is not considered part of a PAI process unit. Quality assurance and quality control laboratories are not considered part of a PAI process unit.

Plant site means all contiguous or adjoining property that is under common control, including properties that are separated only by a road or other public right-of-way. Common control includes properties that are owned, leased, or operated by the same entity, parent entity, subsidiary, or any combination thereof.

Point of determination (POD) means each point where a wastewater stream exits the PAI process unit.

NOTE TO DEFINITION OF "POINT OF DETERMINATION": The regulation allows determination of the characteristics of a wastewater stream: at the point of determination; or downstream of the point of determination if corrections are made for changes in flow rate and annual average concentration of Table 9 compounds as determined in §63.144 of subpart G of this part. Such changes include: losses by air emissions, reduction of annual average concentration or changes in flow rate by mixing with other water or wastewater streams, and reduction in flow rate or annual average concentration by treating or otherwise handling the wastewater stream to remove or destroy HAP.

Pressure release means the emission of materials resulting from the system pressure being greater than the set pressure of the pressure relief device. This release can be one release or a series of releases over a short time period due to a malfunction in the process.

Pressure relief device or valve means a safety device used to prevent operating pressures from exceeding the maximum allowable working pressure of the process equipment. A common pressure relief device is a spring-loaded pressure relief valve. Devices that are actuated either by a pressure of less than or equal to 2.5 pounds per square inch gauge or by a vacuum are not pressure relief devices.

Process means a logical grouping of processing equipment which collectively function to produce a product. For the purpose of this subpart, a PAI process includes all, or a combination of, reaction, recovery, separation, purification, treatment, cleaning, and other activities or unit operations which are used to produce a PAI or integral intermediate. Ancillary activities are not considered a PAI process or any part of a PAI process. Ancillary activities include boilers and incinerators (not used to comply with the provisions of §63.1362), chillers or refrigeration systems, and other equipment and activities that are not directly involved (i.e., they operate within a closed system and materials are not combined with process fluids) in the processing of raw materials or the manufacturing of a PAI. A PAI process and all integral intermediate processes for which 100 percent of the annual production is used in the production of the PAI may be linked together and defined as a single PAI process unit.

Process condenser means a condenser whose primary purpose is to recover material as an integral part of a unit operation. The condenser must cause a vapor-to-liquid phase change for periods during which the temperature of liquid in the process equipment is at or above its boiling or bubble point. Examples of process condensers include distillation condensers, reflux condensers, and condensers used in stripping or flashing operation. In a series of condensers, all condensers up to and including the first condenser with an exit gas temperature below the boiling or bubble point of the liquid in the process equipment are considered to be process condensers. All condensers in line prior to the vacuum source are included in this definition.

Process shutdown means a work practice or operational procedure that stops production from a process or part of a process during which it is technically feasible to clear process material from a process or part of a process consistent with safety constraints and during which repairs can be effected. An unscheduled work practice or operational procedure that stops production from a process or part of a process for less than 24 hours is not a process shutdown. An unscheduled work practice or operational procedure that would stop production from a process or part of a process for a shorter period of time than would be required to clear the process or part of the process of materials and start up the process, and would result in greater emissions than delay of repair of leaking components until the next scheduled process shutdown, is not a process shutdown. The use of spare equipment and technically feasible bypassing of equipment without stopping production are not process shutdowns.

Process tank means a tank that is used within a process to collect material discharged from a feedstock storage vessel or equipment within the process before the material is transferred to other equipment within the process or a product storage vessel. In many process tanks, unit operations such as reactions and blending are conducted. Other process tanks, such as surge control vessels and bottom receivers, however, may not involve unit operations.

Process unit means the equipment assembled and connected by pipes or ducts to process raw materials and to manufacture an intended product.

Process unit group means a group of process units that manufacture PAI and products other than PAI by alternating raw materials or operating conditions, or by reconfiguring process equipment. A process unit group is determined according to the procedures specified in §63.1360(g).

Process vent means a point of emission from processing equipment to the atmosphere or a control device. The vent may be the release point for an emission stream associated with an individual unit operation, or it may be the release point for emission streams from multiple unit operations that have been manifolded together into a common header. Examples of process vents include, but are not limited to, vents on condensers used for product recovery, bottom receivers, surge control vessels, reactors, filters, centrifuges, process tanks, and product dryers. A vent is not considered to be a process vent for a given emission episode if the undiluted and uncontrolled emission stream that is released through the vent contains less than 50 ppmv HAP, as determined through process knowledge that no HAP are present in the emission stream; using an engineering assessment as discussed in §63.1365(c)(2)(ii); from test data collected using Method 18 of 40 CFR part 60, appendix A; or from test data collected using any other test method that has been validated according to the procedures in Method 301 of appendix A of this part. Process vents do not include vents on storage vessels regulated under §63.1362(c), vents on wastewater emission sources regulated under §63.1362(d), or pieces of equipment regulated under §63.1363.

Process wastewater means wastewater which, during manufacturing or processing, comes into direct contact with, or results from, the production or use of any raw material, intermediate product, finished product, by-product, or waste product. Examples include: product tank drawdown or feed tank drawdown; water formed during a chemical reaction or used as a reactant; water used to wash impurities from organic products or reactants; water used to clean process equipment; water used to cool or quench organic vapor streams through direct contact; and condensed steam from jet ejector systems pulling vacuum on vessels containing organics.

Product means the compound(s) or chemical(s) that are produced or manufactured as the intended output of a process unit. Impurities and wastes are not considered products.

Product dryer means equipment that is used to remove moisture or other liquid from granular, powdered, or other solid PAI or integral intermediate products prior to storage, formulation, shipment, or other uses. The product dryer is part of the process.

Product dryer vent means a process vent from a product dryer through which a gas stream containing gaseous pollutants (i.e., organic HAP, HCl, or chlorine), particulate matter, or both are released to the atmosphere or are routed to a control device.

Production-indexed HAP consumption factor (HAP factor) is the result of dividing the annual consumption of total HAP by the annual production rate, per process.

Production-indexed VOC consumption factor (VOC factor) is the result of dividing the annual consumption of total VOC by the annual production rate, per process.

Publicly owned treatment works (POTW) is defined at 40 CFR part 403.3(0).

Reactor means a device or vessel in which one or more chemicals or reactants, other than air, are combined or decomposed in such a way that their molecular structures are altered and one or more new organic compounds are formed.

Reconfiguration means disassembly of processing equipment for a particular non-dedicated process unit and reassembly of that processing equipment in a different sequence, or in combination with other equipment, to create a different non-dedicated process unit.

Reconstruction, as used in §63.1360(b), shall have the meaning given in §63.2, except that “affected or previously unaffected stationary source” shall mean either “affected facility” or “PAI process unit.”

Recovery device, as used in the wastewater provisions, means an individual unit of equipment capable of, and normally used for the purpose of, recovering chemicals for fuel value (i.e., net positive heating value), use, reuse, or for sale for fuel value, use, or reuse. Examples of equipment that may be recovery devices include organic removal devices such as decanters, strippers, or thin-film evaporation units. To be a recovery device, a decanter and any other equipment based on the operating principle of gravity separation must receive only multi-phase liquid streams.

Repaired means that equipment is adjusted, or otherwise altered, to eliminate a leak as defined in the applicable paragraphs of §63.1363.

Research and development facility means any stationary source whose primary purpose is to conduct research and development, where the operations are under the close supervision of technically trained personnel, and is not engaged in the manufacture of products for commercial sale, except in a de minimis manner.

Residual means any liquid or solid material containing Table 9 compounds (as defined in §63.111 of subpart G of this part) that is removed from a wastewater stream by a waste management unit or treatment process that does not destroy organics (nondestructive unit). Examples of residuals from nondestructive wastewater management units include the organic layer and bottom residue removed by a decanter or organic-water separator and the overheads from a steam stripper or air stripper. Examples of materials which are not residuals include: silt; mud; leaves; bottoms from a steam stripper or air stripper; and sludges, ash, or other materials removed from wastewater being treated by destructive devices such as biological treatment units and incinerators.

Safety device means a closure device such as a pressure relief valve, frangible disc, fusible plug, or any other type of device which functions exclusively to prevent physical damage or permanent deformation to a unit or its air emission control equipment by venting gases or vapors directly to the atmosphere during unsafe conditions resulting from an unplanned, accidental, or emergency event. For the purposes of this subpart, a safety device is not used for routine venting of gases or vapors from the vapor headspace underneath a cover such as during filling of the unit or to adjust the pressure in this vapor headspace in response to normal daily diurnal ambient temperature fluctuations. A safety device is designed to remain in a closed position during normal operations and open only when the internal pressure, or another relevant parameter, exceeds the device threshold setting applicable to the air emission control equipment as determined by the owner or operator based on manufacturer recommendations, applicable regulations, fire protection and prevention codes, standard engineering codes and practices, or other requirements for the safe handling of flammable, combustible, explosive, reactive, or hazardous materials.

Sampling connection system means an assembly of equipment within a process unit used during periods of representative operation to take samples of the process fluid. Equipment used to take nonroutine grab samples is not considered a sampling connection system.

Sensor means a device that measures a physical quantity or the change in a physical quantity, such as temperature, pressure, flow rate, pH, or liquid level.

Set pressure means the pressure at which a properly operating pressure relief device begins to open to relieve atypical process system operating pressure.

Sewer line means a lateral, trunk line, branch line, or other conduit including, but not limited to, grates, trenches, etc., used to convey wastewater streams or residuals to a downstream waste management unit.

Shutdown means the cessation of operation of a continuous PAI process unit for any purpose. Shutdown also means the cessation of a batch PAI process unit or any related individual piece of

equipment required or used to comply with this part or for emptying and degassing storage vessels for periodic maintenance, replacement of equipment, repair, or any other purpose not excluded from this definition. Shutdown does not apply to cessation of a batch PAI process unit at the end of a campaign or between batches (e.g., for rinsing or washing equipment), for routine maintenance, or for other routine operations.

Small control device means a control device that controls process vents, and the total HAP emissions into the control device from all sources are less than 10 tons of HAP per year.

Startup means the setting in operation of a continuous PAI process unit for any purpose, the first time a new or reconstructed batch PAI process unit begins production, or, for new equipment added, including equipment used to comply with this subpart, the first time the equipment is put into operation. For batch process units, startup does not apply to the first time the equipment is put into operation at the start of a campaign to produce a product that has been produced in the past, after a shutdown for maintenance, or when the equipment is put into operation as part of a batch within a campaign. As used in §63.1363, startup means the setting in operation of a piece of equipment or a control device that is subject to this subpart.

Storage vessel means a tank or other vessel that is used to store organic liquids that contain one or more HAP and that has been assigned, according to the procedures in §63.1360(f) or (g), to a PAI process unit that is subject to this subpart MMM. The following are not considered storage vessels for the purposes of this subpart:

- (1) Vessels permanently attached to motor vehicles such as trucks, railcars, barges, or ships;
- (2) Pressure vessels designed to operate in excess of 204.9 kilopascals and without emissions to the atmosphere;
- (3) Vessels storing material that contains no organic HAP or contains organic HAP only as impurities;
- (4) Wastewater storage tanks;
- (5) Process tanks; and
- (6) Nonwastewater waste tanks.

Supplemental gases means any nonaffected gaseous streams (streams that are not from process vents, storage vessels, equipment or waste management units) that contain less than 50 ppmv TOC and less than 50 ppmv total HCl and chlorine, as determined through process knowledge, and are combined with an affected vent stream. Supplemental gases are often used to maintain pressures in manifolds or for fire and explosion protection and prevention. Air required to operate combustion device burner(s) is not considered a supplemental gas.

Surface impoundment means a waste management unit which is a natural topographic depression, manmade excavation, or diked area formed primarily of earthen materials (although it may be lined with manmade materials), which is designed to hold an accumulation of liquid wastes or waste containing free liquids. A surface impoundment is used for the purpose of treating, storing, or disposing of wastewater or residuals, and is not an injection well. Examples of surface impoundments are equalization, settling, and aeration pits, ponds, and lagoons.

Total organic compounds (TOC) means those compounds measured according to the procedures of Method 18 or Method 25A, 40 CFR part 60, appendix A.

Treatment process means a specific technique that removes or destroys the organics in a wastewater or residual stream such as a steam stripping unit, thin-film evaporation unit, waste incinerator, biological treatment unit, or any other process applied to wastewater streams or residuals to comply with §63.138 of subpart G of this part. Most treatment processes are conducted in tanks. Treatment processes are a subset of waste management units.

Uncontrolled HAP emissions means a gas stream containing HAP which has exited the process (or process condenser, if any), but which has not yet been introduced into an air pollution control device to reduce the mass of HAP in the stream. If the process vent is not routed to an air pollution control device, uncontrolled emissions are those HAP emissions released to the atmosphere.

Unit operation means those processing steps that occur within distinct equipment that are used, among other things, to prepare reactants, facilitate reactions, separate and purify products, and recycle materials. Equipment used for these purposes includes, but is not limited to, reactors, distillation units, extraction columns, absorbers, decanters, dryers, condensers, and filtration equipment.

Vapor-mounted seal means a continuous seal that completely covers the annular space between the wall of the storage tank or waste management unit and the edge of the floating roof, and is mounted such that there is a vapor space between the stored liquid and the bottom of the seal.

Volatile organic compounds are defined in 40 CFR 51.100.

Waste management unit means the equipment, structure(s), and/or device(s) used to convey, store, treat, or dispose of wastewater streams or residuals. Examples of waste management units include wastewater tanks, surface impoundments, individual drain systems, and biological wastewater treatment units. Examples of equipment that may be waste management units include containers, air flotation units, oil-water separators or organic-water separators, or organic removal devices such as decanters, strippers, or thin-film evaporation units. If such equipment is a recovery device, then it is part of a PAI process unit and is not a waste management unit.

Wastewater means water that meets either of the conditions described in paragraph (1) or (2) of this definition and is discarded from a PAI process unit that is at an affected source:

(1) Is generated from a PAI process or a scrubber used to control emissions from a PAI process and contains either:

(i) An annual average concentration of compounds in Table 9 of subpart G of this part of at least 5 ppmw and has an average flow rate of 0.02 L/min or greater; or

(ii) An annual average concentration of compounds in Table 9 of subpart G of this part of at least 10,000 ppmw at any flow rate;

(2) Is generated from a PAI process unit as a result of maintenance activities and contains at least 5.3 Mg of compounds listed in Table 9 of subpart G of this part per individual discharge event.

Wastewater tank means a stationary waste management unit that is designed to contain an accumulation of wastewater or residuals and is constructed primarily of nonearthen materials (e.g., wood, concrete, steel, plastic) which provide structural support. Wastewater tanks used for flow equalization are included in this definition.

Water seal controls means a seal pot, p-leg trap, or other type of trap filled with water (e.g., flooded sewers that maintain water levels adequate to prevent air flow through the system) that creates a water

barrier between the sewer line and the atmosphere. The water level of the seal must be maintained in the vertical leg of a drain in order to be considered a water seal.

[64 FR 33589, June 23, 1999, as amended at Nov. 21, 2001; 67 FR 59343, Sept. 20, 2002; 71 FR 20460, Apr. 20, 2006; 79 FR 17372, Mar. 27, 2014]

[↑ Back to Top](#)

§63.1362 Standards.

(a) On and after the compliance dates specified in §63.1364, each owner or operator of an affected source subject to the provisions of this subpart shall control HAP emissions to the levels specified in this section and in §63.1363, as summarized in Table 2 of this subpart.

(b) *Process vents.* (1) The owner or operator of an existing source shall comply with the requirements of paragraphs (b)(2) and (3) of this section. The owner or operator of a new source shall comply with the requirements of paragraphs (b)(4) and (5) of this section. Compliance with paragraphs (b)(2) through (b)(5) of this section shall be demonstrated through the applicable test methods and initial compliance procedures in §63.1365 and the monitoring requirements in §63.1366.

(2) *Organic HAP emissions from existing sources.* The owner or operator of an existing affected source must comply with the requirements in either paragraph (b)(2)(i) of this section or with the requirements in paragraphs (b)(2)(ii) through (iv) of this section.

(i) The uncontrolled organic HAP emission rate shall not exceed 0.15 Mg/yr from the sum of all process vents within a process.

(ii) (A) Except as provided in paragraph (b)(2)(ii)(B) of this section, uncontrolled organic HAP emissions from a process vent shall be reduced by 98 percent by weight or greater if the flow-weighted average flowrate for the vent as calculated using Equation 1 of this subpart is less than or equal to the flowrate calculated using Equation 2 of this subpart.

$$FR_a = \frac{\sum_{i=1}^n (D_i)(FR_i)}{\sum_{i=1}^n D_i} \quad (\text{Eq. 1})$$

[View or download PDF](#)

$$FR = 0.02 * (HL) - 1,000 \quad (\text{Eq. 2})$$

[View or download PDF](#)

Where:

FR_a = flow-weighted average flowrate for the vent, scfm

D_i = duration of each emission event, min

FR_i = flowrate of each emission event, scfm

n = number of emission events

FR = flowrate, scfm

HL = annual uncontrolled organic HAP emissions, lb/yr, as defined in §63.1361

(B) If the owner or operator can demonstrate that a control device, installed on or before November 10, 1997 on a process vent otherwise subject to the requirements of paragraph (b)(2)(ii)(A) of this section, reduces inlet emissions of total organic HAP by greater than or equal to 90 percent by weight but less than 98 percent by weight, then the control device must be operated to reduce inlet emissions of total organic HAP by 90 percent by weight or greater.

(iii) Excluding process vents that are subject to the requirements in paragraph (b)(2)(ii) of this section, uncontrolled organic HAP emissions from the sum of all process vents within a process shall be reduced by 90 percent or greater by weight.

(iv) As an alternative to the requirements in paragraphs (b)(2)(ii) and (iii) of this section, uncontrolled organic HAP emissions from any process vent may be reduced in accordance with any of the provisions in paragraphs (b)(2)(iv)(A) through (D) of this section. All remaining process vents within a process must be controlled in accordance with paragraphs (b)(2)(ii) and (iii) of this section.

(A) To outlet concentrations less than or equal to 20 ppmv; or

(B) By a flare that meets the requirements of §63.11(b); or

(C) By a control device specified in §63.1365(a)(4); or

(D) In accordance with the alternative standard specified in paragraph (b)(6) of this section.

(3) *HCl and Cl₂ emissions from existing sources.* For each process, the owner or operator of an existing source shall comply with the requirements of either paragraph (b)(3)(i) or (ii) of this section.

(i) The uncontrolled HCl and Cl₂ emissions, including HCl generated from the combustion of halogenated process vent emissions, from the sum of all process vents within a process shall not exceed 6.8 Mg/yr.

(ii) HCl and Cl₂ emissions, including HCl generated from combustion of halogenated process vent emissions, from the sum of all process vents within a process shall be reduced by 94 percent or greater or to outlet concentrations less than or equal to 20 ppmv.

(4) *Organic HAP emissions from new sources.* For each process, the owner or operator of a new source shall comply with the requirements of either paragraph (b)(4)(i) or (ii) of this section.

(i) The uncontrolled organic HAP emissions shall not exceed 0.15 Mg/yr from the sum of all process vents within a process.

(ii) The uncontrolled organic HAP emissions from the sum of all process vents within a process at a new affected source that are not controlled according to any of the requirements of paragraphs (b)(4)(ii)(A) through (C) or (b)(6) of this section shall be reduced by 98 weight percent or greater.

(A) To outlet concentrations less than or equal to 20 ppmv; or

(B) By a flare that meets the requirements of §63.11(b); or

(C) By a control device specified in §63.1365(a)(4).

(5) *HCl and Cl₂ emissions from new sources.* For each process, the owner or operator of a new source shall comply with the requirements of either paragraph (b)(5)(i), (ii), or (iii) of this section.

(i) The uncontrolled HCl and Cl₂ emissions, including HCl generated from combustion of halogenated process vent emissions, from the sum of all process vents within a process shall not exceed 6.8 Mg/yr.

(ii) If HCl and Cl₂ emissions, including HCl generated from combustion of halogenated process vent emissions, from the sum of all process vents within a process are greater than 6.8 Mg/yr and less than or equal to 191 Mg/yr, these HCl and Cl₂ emissions shall be reduced by 94 percent or to an outlet concentration less than or equal to 20 ppmv.

(iii) If HCl and Cl₂ emissions, including HCl generated from combustion of halogenated process vent emissions, from the sum of all process vents within a process are greater than 191 Mg/yr, these HCl and Cl₂ emissions shall be reduced by 99 percent or greater or to an outlet concentration less than or equal to 20 ppmv.

(6) *Alternative standard.* As an alternative to the provisions in paragraphs (b)(2) through (5) of this section, the owner or operator may route emissions from a process vent to a combustion control device achieving an outlet TOC concentration, as calibrated on methane or the predominant HAP, of 20 ppmv or less, and an outlet concentration of HCl and Cl₂ of 20 ppmv or less. If the owner or operator is routing emissions to a non-combustion control device or series of control devices, the control device(s) must achieve an outlet TOC concentration, as calibrated on methane or the predominant HAP, of 50 ppmv or less, and an outlet concentration of HCl and Cl₂ of 50 ppmv or less. Any process vents within a process that are not routed to such a control device or series of control devices must be controlled in accordance with the provisions of paragraph (b)(2)(ii), (iii), (iv), (b)(3)(ii), (b)(4)(ii), (b)(5)(ii) or (iii) of this section, as applicable.

(c) *Storage vessels.* (1) The owner or operator shall either determine the group status of a storage vessel or designate it as a Group 1 storage vessel. If the owner or operator elects to designate the storage vessel as a Group 1 storage vessel, the owner or operator is not required to determine the maximum true vapor pressure of the material stored in the storage vessel.

(2) *Standard for existing sources.* Except as specified in paragraphs (c)(4), (5), and (6) of this section, the owner or operator of a Group 1 storage vessel at an existing affected source, as defined in §63.1361, shall equip the affected storage vessel with one of the following:

(i) A fixed roof and internal floating roof, or

(ii) An external floating roof, or

(iii) An external floating roof converted to an internal floating roof, or

(iv) A closed vent system meeting the conditions of paragraph (j) of this section and a control device that meets any of the following conditions:

(A) Reduces organic HAP emissions by 95 percent by weight or greater; or

(B) Reduces organic HAP emissions to outlet concentrations of 20 ppmv or less; or

(C) Is a flare that meets the requirements of §63.11(b); or

(D) Is a control device specified in §63.1365(a)(4).

(3) *Standard for new sources.* Except as specified in paragraphs (c)(4), (5), and (6) of this section, the owner or operator of a Group 1 storage vessel at a new source, as defined in §63.1361, shall equip the affected storage vessel in accordance with any one of paragraphs (c)(2)(i) through (iv) of this section.

(4) *Alternative standard.* As an alternative to the provisions in paragraphs (c)(2) and (3) of this section, the owner or operator of an existing or new affected source may route emissions from storage vessels to a combustion control device achieving an outlet TOC concentration, as calibrated on methane or the predominant HAP, of 20 ppmv or less, and an outlet concentration of hydrogen chloride and chlorine of 20 ppmv or less. If the owner or operator is routing emissions to a non-combustion control device or series of control devices, the control device(s) must achieve an outlet TOC concentration, as calibrated on methane or the predominant HAP, of 50 ppmv or less, and an outlet concentration of HCl and Cl₂ of 50 ppmv or less.

(5) *Planned routine maintenance.* The owner or operator is exempt from the specifications in paragraphs (c)(2) through (4) of this section during periods of planned routine maintenance of the control device that do not exceed 240 hr/yr. The owner or operator may submit an application to the Administrator requesting an extension of this time limit to a total of 360 hr/yr. The application must explain why the extension is needed, it must indicate that no material will be added to the storage vessel between the time the 240-hr limit is exceeded and the control device is again operational, and it must be submitted at least 60 days before the 240-hr limit will be exceeded.

(6) *Vapor balancing alternative.* As an alternative to the requirements in paragraphs (c)(2) and (3) of this section, the owner or operator of an existing or new affected source may implement vapor balancing in accordance with paragraphs (c)(6)(i) through (vii) of this section.

(i) The vapor balancing system must be designed and operated to route organic HAP vapors displaced from loading of the storage tank to the railcar or tank truck from which the storage tank is filled.

(ii) Tank trucks and railcars must have a current certification in accordance with the U.S. Department of Transportation pressure test requirements of 49 CFR part 180 for tank trucks and 49 CFR 173.31 for railcars.

(iii) Hazardous air pollutants must only be unloaded from tank trucks or railcars when vapor collection systems are connected to the storage tank's vapor collection system.

(iv) No pressure relief device on the storage tank or on the railcar or tank truck shall open during loading or as a result of diurnal temperature changes (breathing losses).

(v) Pressure relief devices on affected storage tanks must be set to no less than 2.5 psig at all times to prevent breathing losses. The owner or operator shall record the setting as specified in §63.1367(b)(8) and comply with the following requirements for each pressure relief valve:

(A) The pressure relief valve shall be monitored quarterly using the method described in §63.180(b).

(B) An instrument reading of 500 ppmv or greater defines a leak.

(C) When a leak is detected, it shall be repaired as soon as practicable, but no later than 5 days after it is detected, and the owner or operator shall comply with the recordkeeping requirements of §63.1363(g)(4)(i) through (iv).

(vi) Railcars or tank trucks that deliver HAP to an affected storage tank must be reloaded or cleaned at a facility that utilizes one of the following control techniques:

(A) The railcar or tank truck must be connected to a closed vent system with a control device that reduces inlet emissions of HAP by 90 percent by weight or greater; or

(B) A vapor balancing system designed and operated to collect organic HAP vapor displaced from the tank truck or railcar during reloading must be used to route the collected HAP vapor to the storage tank from which the liquid being transferred originated.

(vii) The owner or operator of the facility where the railcar or tank truck is reloaded or cleaned must comply with the following requirements:

(A) Submit to the owner or operator of the affected storage tank and to the Administrator a written certification that the reloading or cleaning facility will meet the requirements of this section. The certifying entity may revoke the written certification by sending a written statement to the owner or operator of the affected storage tank giving at least 90 days notice that the certifying entity is rescinding acceptance of responsibility for compliance with the requirements of this paragraph (c)(6)(vii)(A).

(B) If complying with paragraph (c)(6)(vi)(A) of this section, demonstrate initial compliance in accordance with §63.1365(d), demonstrate continuous compliance in accordance with §63.1366, keep records as specified in §63.1367, and prepare reports as specified in §63.1368.

(C) If complying with paragraph (c)(6)(vi)(B) of this section, keep records of:

(1) The equipment to be used and the procedures to be followed when reloading the railcar or tank truck and displacing vapors to the storage tank from which the liquid originates, and

(2) Each time the vapor balancing system is used to comply with paragraph (c)(6)(vi)(B) of this section.

(7) Compliance with the provisions of paragraphs (c)(2) and (3) of this section is demonstrated using the initial compliance procedures in §63.1365(d) and the monitoring requirements in §63.1366. Compliance with the outlet concentrations in paragraph (c)(4) of this section shall be determined by the initial compliance provisions in §63.1365(a)(5) and the continuous emission monitoring requirements of §63.1366(b)(5).

(d) *Wastewater.* The owner or operator of each affected source shall comply with the requirements of §§63.132 through 63.147, with the differences noted in paragraphs (d)(1) through (16) of this section for the purposes of this subpart.

(1) When the determination of equivalence criteria in §63.102(b) is referred to in §§63.132, 63.133, and 63.137 of subpart G of this part, the provisions in §63.6(g) of subpart A of this part shall apply.

(2) When the storage tank requirements contained in §§63.119 through 63.123 are referred to in §§63.132 through 63.147, §§63.119 through 63.123 are applicable, with the exception of the differences noted in paragraphs (d)(2)(i) through (iv) of this section.

(i) When the term "storage vessel" is used in §§63.119 through 63.123 of subpart G of this part, the definition of the term "storage vessel" in §63.1361 shall apply for the purposes of this subpart.

(ii) When December 31, 1992, is referred to in §63.119 of subpart G of this part, November 10, 1997 shall apply for the purposes of this subpart.

(iii) When April 22, 1994 is referred to in §63.119 of subpart G of this part, June 23, 1999 shall apply for the purposes of this subpart.

(iv) When the phrase “the compliance date specified in §63.100 of subpart F of this part” is referred to in §63.120 of subpart G of this part, the phrase “the compliance date specified in §63.1364” shall apply for the purposes of this subpart.

(3) To request approval to monitor alternative parameters, as referred to in §63.146(a) of subpart G of this part, the owner or operator shall comply with the procedures in §63.8(f) of subpart A of this part, as referred to in §63.1366(b)(4), instead of the procedures in §63.151(f) or (g) of subpart G of this part.

(4) When the Notification of Compliance Status report requirements contained in §63.152(b) of subpart G of this part are referred to in §63.146 of subpart G of this part, the Notification of Compliance Status report requirements in §63.1368(f) shall apply for the purposes of this subpart.

(5) When the recordkeeping requirements contained in §63.152(f) of subpart G of this part are referred to in §63.147(d) of subpart G of this part, the recordkeeping requirements in §63.1367 shall apply for the purposes of this subpart.

(6) When the Periodic report requirements contained in §63.152(c) of subpart G of this part are referred to in §§63.146 and 63.147 of subpart G of this part, the Periodic report requirements contained in §63.1368(g) shall apply for the purposes of this subpart.

(7) When the term “process wastewater” is referred to in §§63.132 through 63.147 of subpart G of this part, the term “wastewater” as defined in §63.1361 shall apply for the purposes of this subpart.

(8) When the term “Group 1 wastewater stream” is used in §§63.132 through 63.147 of subpart G of this part, the definition of the term “Group 1 wastewater stream” in §63.1361 shall apply for both new sources and existing sources for the purposes of this subpart.

(9) The requirements in §§63.132 through 63.147 for compounds listed on Table 8 of subpart G of this part shall not apply for the purposes of this subpart.

(10) When the total load of Table 9 compounds in the sum of all process wastewater from PAI process units at a new affected source is 2,100 Mg/yr (2,300 tons/yr) or more, the owner or operator shall reduce, by removal or destruction, the mass flow rate of all compounds in Table 9 of subpart G of this part in all wastewater (process and maintenance wastewater) by 99 percent or more. Alternatively, the owner or operator may treat the wastewater in a unit identified in and complying with §63.138(h) of subpart G of this part. The removal/destruction efficiency shall be determined by the procedures specified in §63.145(c) of subpart G of this part, for noncombustion processes, or §63.145(d) of subpart G of this part, for combustion processes.

(11) The compliance date for the affected source subject to the provisions of this section is specified in §63.1364.

(12) As an alternative to using Method 18 of 40 CFR part 60, as specified in §§63.139(c)(1)(ii) and 63.145(i)(2), the owner or operator may elect to use Method 25 or Method 25A of 40 CFR part 60, as specified in §63.1365(b).

(13) The requirement to correct outlet concentrations from combustion devices to 3 percent oxygen in §63.139(c)(1)(ii) shall apply only if supplemental gases are combined with affected vent streams, and the procedures in §63.1365(a)(7)(i) apply instead of the procedures in §63.145(i)(6) to determine the percent oxygen correction. If emissions are controlled with a vapor recovery system as specified in §63.139(c)(2), the owner or operator must correct for supplemental gases as specified in §63.1365(a)(7)(ii).

(14) As an alternative to the management and treatment options specified in §63.132(g)(2), any Group 1 wastewater stream (or residual removed from a Group 1 wastewater stream) that contains less than 50 ppmw of HAP listed in Table 2 to subpart GGG of this part may be transferred offsite or to an on-site treatment operation not owned or operated by the owner or operator of the source generating the wastewater (or residual) if the transferee manages and treats the wastewater stream or residual in accordance with paragraphs (d)(14)(i) through (iv) of this section.

(i) Treat the wastewater stream or residual in a biological treatment unit in accordance with §§63.138 and 63.145.

(ii) Cover the waste management units up to the activated sludge unit. Alternatively, covers are not required if the owner or operator demonstrates that less than 5 percent of the total HAP listed in Table 3 to subpart GGG of this part is emitted.

(iii) Inspect covers as specified in §63.1366(h).

(iv) The reference in §63.132(g)(2) to “§63.102(b) of subpart F” does not apply for the purposes of this subpart.

(15) When §63.133 refers to Table 10 to subpart G of this part, the maximum true vapor pressures in the table shall be limited to the HAP listed in Table 9 to subpart G of this part.

(16) When the inspection, recordkeeping, and reporting requirements contained in §63.148 are referred to in §§63.132 through 63.147, the inspection requirements in §63.1366(h), the recordkeeping requirements in §63.1367(f), and the reporting requirements in §63.1368(g)(2)(iii) and (xi) shall apply for the purposes of this subpart.

(e) *Bag dumps and product dryers.* (1) The owner or operator shall reduce particulate matter emissions to a concentration not to exceed 0.01 gr/dscf from product dryers that dry a PAI or integral intermediate that is a HAP.

(2) The owner or operator shall reduce particulate matter emissions to a concentration not to exceed 0.01 gr/dscf from bag dumps that introduce to a PAI process unit a feedstock that is a solid material and a HAP, excluding bag dumps where the feedstock contains HAP only as impurities.

(3) Gaseous HAP emissions from product dryers and bag dumps shall be controlled in accordance with the provisions for process vent emissions in paragraph (b) of this section.

(f) *Heat exchange systems.* Unless one or more of the conditions specified in §63.104(a)(1) through (6) of subpart F of this part are met, an owner or operator shall monitor each heat exchange system that is used to cool process equipment in PAI process units that are part of an affected source as defined in §63.1360(a) according to the provisions in either §63.104(b) or (c) of subpart F of this part. When the term “chemical manufacturing process unit” is used in §63.104(c) of subpart F of this part, the term “PAI process unit” shall apply for the purposes of this subpart. Whenever a leak is detected, the owner or operator shall comply with the requirements in §63.104(d) of subpart F of this part. Delay of repair of heat exchange systems for which leaks have been detected is allowed in accordance with the provisions of §63.104(e) of subpart F of this part.

(g) *Pollution prevention alternative.* Except as provided in paragraph (g)(1) of this section, for a process that has an initial startup before November 10, 1997, an owner or operator may choose to meet the pollution prevention alternative requirement specified in either paragraph (g)(2) or (3) of this section for any PAI process unit, in lieu of the requirements specified in paragraphs (b), (c), (d), and (e) of this

section and in §63.1363. Compliance with the requirements of paragraphs (g)(2) and (3) of this section shall be demonstrated through the procedures in §§63.1365(g) and 63.1366(f).

(1) A HAP must be controlled according to the requirements of paragraphs (b), (c), (d), and (e) of this section and §63.1363 if it is generated in the PAI process unit or an associated control device and it is not part of the production-indexed HAP consumption factor (HAP factor).

(2) The HAP factor shall be reduced by at least 85 percent from a 3-year average baseline beginning no earlier than the 1987 through 1989 calendar years. Alternatively, for a process that has been operating for less than 3 years but more than 1 year, the baseline factor may be calculated for the time period from startup of the process until the present. For any reduction in the HAP factor achieved by reducing a HAP that is also a VOC, an equivalent reduction in the production-indexed VOC consumption factor (VOC factor) is also required (the equivalence is determined on a mass basis, not a percentage basis). For any reduction in the HAP factor that is achieved by reducing a HAP that is not a VOC, the VOC factor may not be increased.

(3) As an alternative to the provisions in paragraph (g)(2) of this section, the owner or operator may combine pollution prevention with emissions control as specified in paragraphs (g)(3)(i) and (ii) of this section.

(i) The HAP factor shall be reduced as specified in paragraph (g)(2) of this section except that a reduction of at least 50 percent shall apply for the purposes of this paragraph.

(ii) The total annual HAP emissions from the PAI process unit shall be reduced by an amount that, when divided by the annual production rate and added to the reduction of the HAP factor yields a value of at least 85 percent of the baseline HAP factor. The total annual VOC emissions from the process unit must be reduced by an amount equivalent to the reduction in HAP emissions for each HAP that is a VOC (the equivalence is determined on a mass basis). For HAP emissions reductions that are achieved by reducing a HAP that is not a VOC, the total annual VOC emissions may not be increased. The reduction in HAP air emissions must be achieved using one of the following control devices:

(A) Combustion control devices such as incinerators, flares, or process heaters.

(B) Control devices such as condensers and carbon adsorbers whose recovered product is destroyed or shipped offsite for destruction.

(C) Any control device that does not ultimately allow for recycling of material back to the PAI process unit.

(D) Any control device for which the owner or operator can demonstrate that the use of the device in controlling HAP emissions will have no effect on the HAP factor for the PAI process unit.

(h) *Emissions averaging provisions.* Except as provided in paragraphs (h)(1) through (7) of this section, the owner or operator of an existing affected facility may choose to comply with the emission standards in paragraphs (b), (c), and (d) of this section by using emissions averaging procedures specified in §63.1365(h) for organic HAP emissions from any storage vessel, process, or waste management unit that is part of an affected source subject to this subpart.

(1) A State may restrict the owner or operator of an existing source to use only the procedures in paragraphs (b), (c), and (d) of this section to comply with the emission standards where State authorities prohibit averaging of HAP emissions.

(2) Group 1 emission points that are controlled as specified in paragraphs (h)(2)(i) through (iii) of this section may not be used to calculate emissions averaging credits, unless the equipment is approved for use in a different manner from that specified in paragraphs (b) through (d) of this section, and a nominal efficiency has been assigned according to the procedures in §63.150(i). The nominal efficiency must exceed the percent reduction required by paragraphs (b) and (c) of this section for process vents and storage vessels, respectively, exceed the percent reduction required in §63.139(c) for control devices used to control emissions vented from waste management units, and exceed the percent reduction required in §63.138(e) or (f) for wastewater treatment processes.

(i) Storage vessels controlled with an internal floating roof meeting the specifications of §63.119(b), an external floating roof meeting the specifications of §63.119(c), or an external floating roof converted to an internal floating meeting the specifications of §63.119(d).

(ii) Emission points controlled with a flare.

(iii) Wastewater streams that are managed in waste management units that are controlled as specified in §§63.133 through 63.137, treated using a steam stripper meeting the specifications of §63.138(d), and emissions from the steam stripper are controlled in a control device that meets the percent reduction requirements specified in §63.139(c).

(3) Process vents and storage vessels controlled with a control device to an outlet concentration of 20 ppmv or 50 ppmv, as specified in paragraph (b)(2)(iv)(A), (b)(3)(ii), (b)(6), (c)(2)(iv)(B), or (c)(4) of this section, and wastewater streams controlled in a treatment unit to an outlet concentration of 50 ppmw, may not be used in any averaging group.

(4) Maintenance wastewater streams, wastewater streams treated in biological treatment units, and Group 2 wastewater streams that are not managed as specified in §§63.133 through 63.137 may not be included in any averaging group.

(5) Processes which have been permanently shut down and storage vessels permanently taken out of HAP service may not be included in any averaging group.

(6) Emission points already controlled on or before November 15, 1990 may not be used to generate emissions averaging credits, unless the level of control has been increased after November 15, 1990. In these cases, credit will be allowed only for the increase in control after November 15, 1990.

(7) Emission points controlled to comply with a State or Federal rule other than this subpart may not be included in an emissions averaging group, unless the level of control has been increased after November 15, 1990, above what is required by the other State or Federal rule. Only the control above what is required by the other State or Federal rule will be credited. However, if an emission point has been used to generate emissions averaging credit in an approved emissions average, and the point is subsequently made subject to a State or Federal rule other than this subpart, the point can continue to generate emissions averaging credit for the purpose of complying with the previously approved average.

(i) *Opening of a safety device.* The owner or operator that opens a safety device, as defined in §63.1361, is not exempt from applicable standards in order to avoid unsafe conditions. If opening a safety device results in the failure to meet any applicable standard, the owner or operator must still comply with the general duty to minimize emissions. If opening a safety device results in a deviation or excess emissions, such events must be reported as specified in §63.1368(i). If the owner or operator attributes the event to a malfunction and intends to assert an affirmative defense, the owner or operator is subject to §63.1360(k).

(j) *Closed-vent systems.* The owner or operator of a closed-vent system that contains bypass lines that could divert a vent stream away from a control device used to comply with the requirements in

paragraphs (b) through (d) of this section shall comply with the requirements of Table 3 of this subpart and paragraph (j)(1) or (2) of this section. Equipment such as low leg drains, high point bleeds, analyzer vents, open-ended valves or lines, rupture disks and pressure relief valves needed for safety purposes are not subject to this paragraph.

(1) Install, calibrate, maintain, and operate a flow indicator that is capable of determining whether vent stream flow is present and taking frequent, periodic readings. Records shall be maintained as specified in §63.1367(f)(1). The flow indicator shall be installed at the entrance to any bypass line that could divert the vent stream away from the control device to the atmosphere; or

(2) Secure the bypass line valve in the closed position with a car-seal or lock-and-key type configuration. Records shall be maintained as specified in §63.1367(f)(2).

(k) *Control requirements for certain liquid streams in open systems within a PAI process unit.* (1) The owner or operator shall comply with the provisions of Table 4 of this subpart, for each item of equipment meeting all the criteria specified in paragraphs (k)(2) through (4) of this section and either paragraph (k)(5)(i) or (ii) of this section.

(2) The item of equipment is of a type identified in Table 4 of this subpart;

(3) The item of equipment is part of a PAI process unit as defined in §63.1361;

(4) The item of equipment is controlled less stringently than in Table 4 of this subpart, and the item of equipment is not otherwise exempt from controls by the provisions of this subpart or subpart A of this part;

(5) The item of equipment:

(i) Is a drain, drain hub, manhole, lift station, trench, pipe, or oil/water separator that conveys water with a total annual average concentration greater than or equal to 10,000 ppm by weight of compounds in Table 9 of subpart G of this part at any flowrate; or a total annual average concentration greater than or equal to 1,000 ppm by weight of compounds in Table 9 of subpart G of this part at an annual average flow rate greater than or equal to 10 liters per minute; or

(ii) Is a tank that receives one or more streams that contain water with a total annual average concentration greater than or equal to 1,000 ppm by weight of compounds in Table 9 of subpart G of this part at an annual average flowrate greater than or equal to 10 liters per minute. The owner or operator of the source shall determine the characteristics of the stream as specified in paragraphs (k)(5)(ii)(A) and (B) of this section.

(A) The characteristics of the stream being received shall be determined at the inlet to the tank.

(B) The characteristics shall be determined according to the procedures in §63.144(b) and (c) of subpart G of this part.

(l) *Exemption for RCRA treatment units.* An owner or operator shall be exempt from the initial compliance demonstrations and monitoring provisions in §§63.1365 and 63.1366 and the associated recordkeeping and reporting requirements in §§63.1367 and 63.1368 for emissions from process vents, storage vessels, and waste management units that are discharged to the following devices:

(1) A boiler or process heater burning hazardous waste for which the owner or operator:

(i) Has been issued a final permit under 40 CFR part 270 and complies with the requirements of 40 CFR part 266, subpart H; or

(ii) Has certified compliance with the interim status requirements of 40 CFR part 266, subpart H.

(2) A hazardous waste incinerator for which the owner or operator has been issued a final permit under 40 CFR part 270 and complies with the requirements of 40 CFR part 264, subpart O, or has certified compliance with the interim status requirements of 40 CFR part 265, subpart O.

[64 FR 33589, June 23, 1999, as amended at 67 FR 59343, Sept. 20, 2002; 68 FR 37358, June 23, 2003; 79 FR 17372, Mar. 27, 2014]

 [Back to Top](#)

§63.1363 Standards for equipment leaks.

(a) *General equipment leak requirements.* (1) The provisions of this section apply to “equipment” as defined in §63.1361. The provisions of this section also apply to any closed-vent systems and control devices required by this section.

(2) *Consistency with other regulations.* After the compliance date for a process, equipment subject to both this section and either of the following will be required to comply only with the provisions of this subpart:

(i) 40 CFR part 60.

(ii) 40 CFR part 61.

(3) [Reserved]

(4) The provisions in §63.1(a)(3) of subpart A of this part do not alter the provisions in paragraph (a)(2) of this section.

(5) Lines and equipment not containing process fluids are not subject to the provisions of this section. Utilities, and other nonprocess lines, such as heating and cooling systems which do not combine their materials with those in the processes they serve, are not considered to be part of a process.

(6) The provisions of this section do not apply to bench-scale processes, regardless of whether the processes are located at the same plant site as a process subject to the provisions of this subpart MMM.

(7) Each piece of equipment to which this section applies shall be identified such that it can be distinguished readily from equipment that is not subject to this section. Identification of the equipment does not require physical tagging of the equipment. For example, the equipment may be identified on a plant site plan, in log entries, or by designation of process boundaries by some form of weatherproof identification. If changes are made to the affected source subject to the leak detection requirements, equipment identification for each type of component shall be updated, if needed, within 15 calendar days of the end of each monitoring period for that component.

(8) Equipment that is in vacuum service is excluded from the requirements of this section.

(9) Equipment that is in organic HAP service, but is in such service less than 300 hours per calendar year, is excluded from the requirements of this section if it is identified as required in paragraph (g)(9) of this section.

(10) When each leak is detected by visual, audible, or olfactory means, or by monitoring as described in §63.180(b) or (c) of subpart H of this part, the following requirements apply:

(i) A weatherproof and readily visible identification, marked with the equipment identification number, shall be attached to the leaking equipment.

(ii) The identification on a valve in light liquid or gas/vapor service may be removed after it has been monitored as specified in paragraph (e)(7)(iii) of this section, and no leak has been detected during the follow-up monitoring. If an owner or operator elects to comply with §63.174(c)(1)(i), the identification on a connector may be removed after it has been monitored as specified in §63.174(c)(1)(i) and no leak is detected during that monitoring.

(iii) The identification on equipment, except as specified in paragraph (a)(10)(ii) of this section, may be removed after it has been repaired.

(b) *References.* The owner or operator shall comply with the provisions of subpart H of this part as specified in paragraphs (b)(1) through (3) of this section and with paragraph (b)(4) of this section for pressure relief devices. When the term "process unit" is used in subpart H of this part, it shall mean any group of processes for the purposes of this subpart. Groups of processes as used in this subpart may be any individual process or combination of processes.

(1) Sections 63.160, 63.161, 63.162, 63.163, 63.167, 63.168, 63.170, 63.173, 63.175, 63.176, 63.181, and 63.182 of subpart H of this part shall not apply for the purposes of this subpart MMM. The owner or operator shall comply with the provisions specified in paragraphs (b)(1)(i) through (viii) of this section.

(i) Sections 63.160 and 63.162 of subpart H of this part shall not apply, instead the owner or operator shall comply with paragraph (a) of this section;

(ii) Section 63.161 of subpart H of this part shall not apply, instead the owner or operator shall comply with §63.1361;

(iii) Sections 63.163 and 63.173 of subpart H of this part shall not apply, instead the owner or operator shall comply with paragraph (c) of this section;

(iv) Section 63.167 of subpart H of this part shall not apply, instead the owner or operator shall comply with paragraph (d) of this section;

(v) Section 63.168 of subpart H of this part shall not apply, instead the owner or operator shall comply with paragraph (e) of this section;

(vi) Section 63.170 of subpart H of this part shall not apply, instead the owner or operator shall comply with §63.1362(b);

(vii) Section 63.181 of subpart H of this part shall not apply, instead the owner or operator shall comply with paragraph (g) of this section; and

(viii) Section 63.182 of subpart H of this part shall not apply, instead the owner or operator shall comply with paragraph (h) of this section.

(2) The owner or operator shall comply with §§63.164, 63.166, 63.169, 63.177, and 63.179 of subpart H of this part in their entirety, except that when these sections reference other sections of subpart H of this part, the owner or operator shall comply with the revised sections as specified in paragraphs (b)(1), (3), and (4) of this section. Section 63.164 of subpart H of this part applies to compressors. Section 63.166 of subpart H of this part applies to sampling connection systems. Section 63.169 of subpart H of this part applies to: pumps, valves, connectors, and agitators in heavy liquid service; instrumentation systems; and pressure relief devices in liquid service. Section 63.177 of subpart H of this subpart applies to general alternative means of emission limitation. Section 63.179 of subpart H of this part applies to alternative means of emission limitation for enclosed-vented process units.

(3) The owner or operator shall comply with §§63.171, 63.172, 63.174, 63.178, and 63.180 of subpart H of this part with the differences specified in paragraphs (b)(3)(i) through (v) of this section.

(i) Section 63.171, Delay of repair, shall apply except §63.171(a) shall not apply. Delay of repair of equipment for which leaks have been detected is allowed if one of the following conditions exist:

(A) The repair is technically infeasible without a process shutdown. Repair of this equipment shall occur by the end of the next scheduled process shutdown.

(B) The owner or operator determines that repair personnel would be exposed to an immediate danger if attempting to repair without a process shutdown. Repair of this equipment shall occur by the end of the next scheduled process shutdown.

(ii) Section 63.172, Closed-vent systems and control devices, shall apply for closed-vent systems used to comply with this section, and for control devices used to comply with this section only, except:

(A) Section 63.172(k) and (l) shall not apply. The owner or operator shall instead comply with paragraph (f) of this section.

(B) Owners or operators may, instead of complying with the provisions of §63.172(f), design a closed-vent system to operate at a pressure below atmospheric pressure. The system shall be equipped with at least one pressure gauge or other pressure measurement device that can be read from a readily accessible location to verify that negative pressure is being maintained in the closed-vent system when the associated control device is operating.

(iii) Section 63.174, Connectors, shall apply except:

(A) Section 63.174(b), (f), (g), and (h) shall not apply. In place of §63.174(b), the owner or operator shall comply with paragraphs (b)(3)(iii)(C) through (G) of this section. In place of §63.174(f), (g), and (h), the owner or operator shall comply with paragraph (f) of this section.

(B) Days that the connectors are not in organic HAP service shall not be considered part of the 3-month period in §63.174(c).

(C) If the percent leaking connectors in a group of processes was greater than or equal to 0.5 percent during the initial monitoring period, monitoring shall be performed once per year until the percent leaking connectors is less than 0.5 percent.

(D) If the percent leaking connectors in the group of processes was less than 0.5 percent, but equal to or greater than 0.25 percent, during the last required monitoring period, monitoring shall be performed once every 4 years. An owner or operator may comply with the requirements of this paragraph by monitoring at least 40 percent of the connectors in the first 2 years and the remainder of the connectors

within the next 2 years. The percent leaking connectors will be calculated for the total of all monitoring performed during the 4-year period.

(E) The owner or operator shall increase the monitoring frequency to once every 2 years for the next monitoring period if leaking connectors comprise at least 0.5 percent but less than 1.0 percent of the connectors monitored within either the 4 years specified in paragraph (b)(3)(iii)(D) of this section, the first 4 years specified in paragraph (b)(3)(iii)(G) of this section, or the entire 8 years specified in paragraph (b)(3)(iii)(G) of this section. At the end of that 2-year monitoring period, the owner or operator shall monitor once per year while the percent leaking connectors is greater than or equal to 0.5 percent; if the percent leaking connectors is less than 0.5 percent, the owner or operator may again elect to monitor in accordance with paragraph (b)(3)(iii)(D) or (G) of this section, as applicable.

(F) If an owner or operator complying with the requirements of paragraph (b)(3)(iii)(D) or (G) of this section for a group of processes determines that 1 percent or greater of the connectors are leaking, the owner or operator shall increase the monitoring frequency to one time per year. The owner or operator may again elect to use the provisions of paragraph (b)(3)(iii)(D) or (G) of this section after a monitoring period in which less than 0.5 percent of the connectors are determined to be leaking.

(G) Monitoring shall be required once every 8 years, if the percent leaking connectors in the group of process units was less than 0.25 percent during the last required monitoring period. An owner or operator shall monitor at least 50 percent of the connectors in the first 4 years and the remainder of the connectors within the next 4 years. If the percent leaking connectors in the first 4 years is equal to or greater than 0.35 percent, the monitoring program shall revert at that time to the appropriate monitoring frequency specified in paragraph (b)(3)(iii)(D), (E), or (F) of this section.

(iv) Section 63.178, shall apply, except as specified in paragraphs (b)(3)(iv)(A) and (B) of this section.

(A) Section 63.178(b), requirements for pressure testing, shall apply to all processes, not just batch processes.

(B) For pumps, the phrase "at the frequencies specified in Table 1 of this subpart" in §63.178(c)(3)(iii) shall mean "quarterly" for the purposes of this subpart.

(v) Section 63.180 of subpart H of this part, Test methods and procedures, shall apply except §63.180(b)(4)(ii)(A) through (C) of subpart H of this part shall not apply. Calibration gases shall be a mixture of methane and air at a concentration of approximately, but less than, 10,000 parts per million methane for agitators, 2,000 parts per million for pumps, and 500 parts per million for all other equipment, except as provided in §63.180(b)(4)(iii) of subpart H of this part.

(4) *Requirements for pressure relief devices.* Except as specified in paragraph (b)(4)(iv) of this section, the owner or operator must comply with the operating and pressure release requirements specified in paragraphs (b)(4)(i) and (ii) of this section for pressure relief devices in organic HAP gas or vapor service. Except as specified in paragraph (b)(4)(iv) of this section, the owner or operator must also comply with the pressure release management requirements specified in paragraph (b)(4)(iii) of this section for all pressure relief devices in organic HAP service.

(i) *Operating requirements.* Except during a pressure release event, operate each pressure relief device in organic HAP gas or vapor service with an instrument reading of less than 500 ppm above background as detected by Method 21 of 40 CFR part 60, appendix A.

(ii) *Pressure release requirements.* For pressure relief devices in organic HAP gas or vapor service, comply with paragraphs (b)(4)(ii)(A) or (B) of this section, as applicable.

(A) If the pressure relief device does not consist of or include a rupture disk, conduct instrument monitoring, as detected by Method 21 of 40 CFR part 60, appendix A, no later than 5 calendar days after the pressure release to verify that the pressure relief device is operating with an instrument reading of less than 500 ppm above background, except as provided in §63.171.

(B) If the pressure relief device consists of or includes a rupture disk, install a replacement disk as soon as practicable after a pressure release, but no later than 5 calendar days after the pressure release, except as provided in §63.171.

(iii) *Pressure release management.* Except as specified in paragraph (b)(4)(iv) of this section, pressure releases to the atmosphere from pressure relief devices in organic HAP service are prohibited, and the owner or operator must comply with the requirements specified in paragraphs (b)(4)(iii)(A) and (B) of this section for all pressure relief devices in organic HAP service.

(A) For each pressure relief device in organic HAP service, the owner or operator must equip each pressure relief device with a device(s) or use a monitoring system that is capable of:

(1) Identifying the pressure release;

(2) Recording the time and duration of each pressure release; and

(3) Notifying operators immediately that a pressure release is occurring. The device or monitoring system may be either specific to the pressure relief device itself or may be associated with the process system or piping, sufficient to indicate a pressure release to the atmosphere. Examples of these types of devices and systems include, but are not limited to, a rupture disk indicator, magnetic sensor, motion detector on the pressure relief valve stem, flow monitor, or pressure monitor.

(B) If any pressure relief device in organic HAP service releases to atmosphere as a result of a pressure release event, the owner or operator must calculate the quantity of organic HAP released during each pressure release event and report this quantity as required in paragraph (h)(3)(v) of this section. Calculations may be based on data from the pressure relief device monitoring alone or in combination with process parameter monitoring data and process knowledge.

(iv) *Pressure relief devices routed to a control device, process, or drain system.* If a pressure relief device in organic HAP service is designed and operated to route all pressure releases through a closed vent system to a control device, process, or drain system, the owner or operator is not required to comply with paragraphs (b)(4)(i), (ii), or (iii) (if applicable) of this section. Both the closed vent system and control device (if applicable) must meet the requirements of §63.172. The drain system (if applicable) must meet the requirements of §63.136.

(c) *Standards for pumps in light liquid service and agitators in gas/vapor service and in light liquid service.* (1) The provisions of this section apply to each pump that is in light liquid service, and to each agitator in gas/vapor service or in light liquid service.

(2)(i) *Monitoring.* Each pump and agitator subject to this section shall be monitored quarterly to detect leaks by the method specified in §63.180(b), except as provided in §§63.177, 63.178, paragraph (f) of this section, and paragraphs (c)(5) through (9) of this section.

(ii) *Leak definition.* The instrument reading, as determined by the method as specified in §63.180(b) of subpart H of this part, that defines a leak is:

(A) For agitators, an instrument reading of 10,000 parts per million or greater.

(B) For pumps, an instrument reading of 2,000 parts per million or greater.

(iii) *Visual inspections.* Each pump and agitator shall be checked by visual inspection each calendar week for indications of liquids dripping from the pump or agitator seal. If there are indications of liquids dripping from the seal at the time of the weekly inspection, the owner or operator shall follow the procedure specified in either paragraph (c)(2)(iii)(A) or (B) of this section prior to the next weekly inspection.

(A) The owner or operator shall monitor the pump or agitator by the method specified in §63.180(b). If the instrument reading indicates a leak as specified in paragraph (c)(2)(ii) of this section, a leak is detected.

(B) The owner or operator shall eliminate the visual indications of liquids dripping.

(3) *Repair provisions.* (i) When a leak is detected pursuant to paragraph (c)(2)(i), (c)(2)(iii)(A), (c)(5)(iv)(A), or (c)(5)(vi)(B) of this section, it shall be repaired as soon as practicable, but not later than 15 calendar days after it is detected, except as provided in paragraph (b)(3)(i) of this section.

(ii) A first attempt at repair shall be made no later than 5 calendar days after the leak is detected. First attempts at repair include, but are not limited to, the following practices where practicable:

(A) Tightening of packing gland nuts.

(B) Ensuring that the seal flush is operating at design pressure and temperature.

(4) *Calculation of percent leakers.* (i) The owner or operator shall decide no later than the end of the first monitoring period what groups of processes will be developed. Once the owner or operator has decided, all subsequent percent calculations shall be made on the same basis.

(ii) If, calculated on a 1-year rolling average, 10 percent or more of the pumps in a group of processes (or 3 pumps in a group of processes with fewer than 30 pumps) leak, the owner or operator shall monitor each pump once per month, until the calculated 1-year rolling average value drops below 10 percent (or three pumps in a group of processes with fewer than 30 pumps).

(iii) The number of pumps in a group of processes shall be the sum of all the pumps in organic HAP service, except that pumps found leaking in a continuous process within 1 quarter after startup of the pump shall not count in the percent leaking pumps calculation for that one monitoring period only.

(iv) Percent leaking pumps shall be determined using Equation 3 of this subpart:

$$\%P_L = \left[\frac{P_L - P_S}{P_T - P_S} \right] \times 100 \quad (\text{Eq. 3})$$

[View or download PDF](#)

Where:

$\%P_L$ = percent leaking pumps

P_L = number of pumps found leaking as determined through quarterly monitoring as required in paragraphs (c)(2)(i) and (ii) of this section.

P_T = total pumps in organic HAP service, including those meeting the criteria in paragraphs (c)(5) and (6) of this section

P_s = number of pumps in a continuous process leaking within 1 quarter of startup during the current monitoring period

(5) *Exemptions.* Each pump or agitator equipped with a dual mechanical seal system that includes a barrier fluid system and meets the requirements specified in paragraphs (c)(5)(i) through (vii) is exempt from the requirements of paragraphs (c)(1) through (c)(4)(iii) of this section, except as specified in paragraphs (c)(5)(iv)(A) and (vii) of this section.

(i) Each dual mechanical seal system is:

(A) Operated with the barrier fluid at a pressure that is at all times greater than the pump/agitator stuffing box pressure; or

(B) Equipped with a barrier fluid degassing reservoir that is connected by a closed-vent system to a control device that complies with the requirements of paragraph (b)(3)(ii) of this section; or

(C) Equipped with a closed-loop system that purges the barrier fluid into a process stream.

(ii) The barrier fluid is not in light liquid service.

(iii) Each barrier fluid system is equipped with a sensor that will detect failure of the seal system, the barrier fluid system, or both.

(iv) Each pump/agitator is checked by visual inspection each calendar week for indications of liquids dripping from the pump/agitator seal. If there are indications of liquids dripping from the pump or agitator seal at the time of the weekly inspection, the owner or operator shall follow the procedures specified in either paragraph (c)(5)(iv)(A) or (B) of this section prior to the next required inspection.

(A) The owner or operator shall monitor the pump or agitator using the method specified in §63.180(b) to determine if there is a leak of organic HAP in the barrier fluid. If the instrument reading indicates a leak, as specified in paragraph (c)(2)(ii) of this section, a leak is detected.

(B) The owner or operator shall eliminate the visual indications of liquids dripping.

(v) Each sensor as described in paragraph (c)(5)(iii) of this section is observed daily or is equipped with an alarm unless the pump is located within the boundary of an unmanned plant site.

(vi)(A) The owner or operator determines, based on design considerations and operating experience, criteria applicable to the presence and frequency of drips and to the sensor that indicate failure of the seal system, the barrier fluid system, or both.

(B) If indications of liquids dripping from the pump/agitator seal exceed the criteria established in paragraph (c)(5)(vi)(A) of this section, or if, based on the criteria established in paragraph (c)(5)(vi)(A) of this section, the sensor indicates failure of the seal system, the barrier fluid system, or both, a leak is detected.

(vii) When a leak is detected pursuant to paragraph (c)(5)(iv)(A) or (vi)(B) of this section, the leak must be repaired as specified in paragraph (c)(3) of this section.

(6) Any pump/agitator that is designed with no externally actuated shaft penetrating the pump/agitator housing is exempt from the requirements of paragraphs (c)(1) through (3) of this section.

(7) Any pump/agitator equipped with a closed-vent system capable of capturing and transporting any leakage from the seal or seals back to the process or to a control device that complies with the requirements of paragraph (b)(3)(ii) of this section is exempt from the requirements of paragraphs (c)(2) through (5) of this section.

(8) Any pump/agitator that is located within the boundary of an unmanned plant site is exempt from the weekly visual inspection requirement of paragraphs (c)(2)(iii) and (c)(5)(iv) of this section, and the daily requirements of paragraph (c)(5)(v) of this section, provided that each pump/agitator is visually inspected as often as practicable and at least monthly.

(9) If more than 90 percent of the pumps in a group of processes meet the criteria in either paragraph (c)(5) or (6) of this section, the group of processes is exempt from the requirements of paragraph (c)(4) of this section.

(d) *Standards: open-ended valves or lines.* (1)(i) Each open-ended valve or line shall be equipped with a cap, blind flange, plug, or a second valve, except as provided in §63.177 of subpart H of this part and paragraphs (d)(4) through (6) of this section.

(ii) The cap, blind flange, plug, or second valve shall seal the open end at all times except during operations requiring process fluid flow through the open-ended valve or line, or during maintenance or repair. The cap, blind flange, plug, or second valve shall be in place within 1 hour of cessation of operations requiring process fluid flow through the open-ended valve or line, or within 1 hour of cessation of maintenance or repair.

(2) Each open-ended valve or line equipped with a second valve shall be operated in a manner such that the valve on the process fluid end is closed before the second valve is closed.

(3) When a double block and bleed system is being used, the bleed valve or line may remain open during operations that require venting the line between the block valves but shall comply with paragraph (d)(1) of this section at all other times.

(4) Open-ended valves or lines in an emergency shutdown system which are designed to open automatically in the event of a process upset are exempt from the requirements of paragraphs (d)(1) through (3) of this section.

(5) Open-ended valves or lines containing materials which would autocatalytically polymerize are exempt from the requirements of paragraphs (d)(1) through (3) of this section.

(6) Open-ended valves or lines containing materials which could cause an explosion, serious overpressure, or other safety hazard if capped or equipped with a double block and bleed system as specified in paragraphs (d)(1) through (3) of this section are exempt from the requirements of paragraphs (d)(1) through (3) of this section.

(e) *Standards: valves in gas/vapor service and in light liquid service.* (1) The provisions of this section apply to valves that are either in gas/vapor service or in light liquid service.

(2) For existing and new affected sources, all valves subject to this section shall be monitored, except as provided in paragraph (f) of this section and in §63.177 of subpart H of this part, by no later than 1 year after the compliance date.

(3) *Monitoring.* The owner or operator of a source subject to this section shall monitor all valves, except as provided in paragraph (f) of this section and in §63.177 of subpart H of this part, at the intervals specified in paragraph (e)(4) of this section and shall comply with all other provisions of this section,

except as provided in paragraph (b)(3)(i) of this section and §§63.178 and 63.179 of subpart H of this part.

(i) The valves shall be monitored to detect leaks by the method specified in §63.180(b) of subpart H of this part.

(ii) An instrument reading of 500 parts per million or greater defines a leak.

(4) *Subsequent monitoring frequencies.* After conducting the initial survey required in paragraph (e)(2) of this section, the owner or operator shall monitor valves for leaks at the intervals specified below:

(i) For a group of processes with 2 percent or greater leaking valves, calculated according to paragraph (e)(6) of this section, the owner or operator shall monitor each valve once per month, except as specified in paragraph (e)(9) of this section.

(ii) For a group of processes with less than 2 percent leaking valves, the owner or operator shall monitor each valve once each quarter, except as provided in paragraphs (e)(4)(iii) through (v) of this section.

(iii) For a group of processes with less than 1 percent leaking valves, the owner or operator may elect to monitor each valve once every 2 quarters.

(iv) For a group of processes with less than 0.5 percent leaking valves, the owner or operator may elect to monitor each valve once every 4 quarters.

(v) For a group of processes with less than 0.25 percent leaking valves, the owner or operator may elect to monitor each valve once every 2 years.

(5) *Calculation of percent leakers.* For a group of processes to which this subpart applies, the owner or operator may choose to subdivide the valves in the applicable group of processes and apply the provisions of paragraph (e)(4) of this section to each subgroup. If the owner or operator elects to subdivide the valves in the applicable group of processes, then the provisions of paragraphs (e)(5)(i) through (viii) of this section apply.

(i) The overall performance of total valves in the applicable group of processes must be less than 2 percent leaking valves, as detected according to paragraphs (e)(3)(i) and (ii) of this section and as calculated according to paragraphs (e)(6)(ii) and (iii) of this section.

(ii) The initial assignment or subsequent reassignment of valves to subgroups shall be governed by the provisions of paragraphs (e)(5)(ii) (A) through (C) of this section.

(A) The owner or operator shall determine which valves are assigned to each subgroup. Valves with less than 1 year of monitoring data or valves not monitored within the last 12 months must be placed initially into the most frequently monitored subgroup until at least 1 year of monitoring data have been obtained.

(B) Any valve or group of valves can be reassigned from a less frequently monitored subgroup to a more frequently monitored subgroup provided that the valves to be reassigned were monitored during the most recent monitoring period for the less frequently monitored subgroup. The monitoring results must be included with the less frequently monitored subgroup's monitoring event and associated next percent leaking valves calculation for that group.

(C) Any valve or group of valves can be reassigned from a more frequently monitored subgroup to a less frequently monitored subgroup provided that the valves to be reassigned have not leaked for the period of the less frequently monitored subgroup (e.g., for the last 12 months, if the valve or group of valves is to be reassigned to a subgroup being monitored annually). Nonrepairable valves may not be reassigned to a less frequently monitored subgroup.

(iii) The owner or operator shall determine every 6 months if the overall performance of total valves in the applicable group of processes is less than 2 percent leaking valves and so indicate the performance in the next Periodic report. If the overall performance of total valves in the applicable group of processes is 2 percent leaking valves or greater, the owner or operator shall revert to the program required in paragraphs (e)(2) through (4) of this section. The overall performance of total valves in the applicable group of processes shall be calculated as a weighted average of the percent leaking valves of each subgroup according to Equation 4 of this subpart:

$$\%V_{LO} = \frac{\sum_{i=1}^n (\%V_{Li} \times V_i)}{\sum_{i=1}^n V_i} \quad (\text{Eq. 4})$$

[View or download PDF](#)

Where:

$\%V_{LO}$ = overall performance of total valves in the applicable group of processes

$\%V_{Li}$ = percent leaking valves in subgroup i, most recent value calculated according to the procedures in paragraphs (e)(6)(ii) and (iii) of this section

V_i = number of valves in subgroup i

n = number of subgroups

(iv) *Records.* In addition to records required by paragraph (g) of this section, the owner or operator shall maintain records specified in paragraphs (e)(5)(iv)(A) through (D) of this section.

(A) Which valves are assigned to each subgroup,

(B) Monitoring results and calculations made for each subgroup for each monitoring period,

(C) Which valves are reassigned and when they were reassigned, and

(D) The results of the semiannual overall performance calculation required in paragraph (e)(5)(iii) of this section.

(v) The owner or operator shall notify the Administrator no later than 30 days prior to the beginning of the next monitoring period of the decision to subgroup valves. The notification shall identify the participating processes and the valves assigned to each subgroup.

(vi) *Semiannual reports.* In addition to the information required by paragraph (h)(3) of this section, the owner or operator shall submit in the Periodic reports the information specified in paragraphs (e)(5)(vi)(A) and (B) of this section.

(A) Valve reassignments occurring during the reporting period, and

(B) Results of the semiannual overall performance calculation required by paragraph (e)(5)(iii) of this section.

(vii) To determine the monitoring frequency for each subgroup, the calculation procedures of paragraph (e)(6)(iii) of this section shall be used.

(viii) Except for the overall performance calculations required by paragraphs (e)(5)(i) and (iii) of this section, each subgroup shall be treated as if it were a process for the purposes of applying the provisions of this section.

(6)(i) The owner or operator shall decide no later than the implementation date of this subpart or upon revision of an operating permit how to group the processes. Once the owner or operator has decided, all subsequent percentage calculations shall be made on the same basis.

(ii) Percent leaking valves for each group of processes or subgroup shall be determined using Equation 5 of this subpart:

$$\%V_L = [V_L/V_T] \times 100 \quad (\text{Eq. 5})$$

[View or download PDF](#)

Where:

$\%V_L$ = percent leaking valves

V_L = number of valves found leaking excluding nonrepairables as provided in paragraph (e)(6)(iv)(A) of this section

V_T = total valves monitored, in a monitoring period excluding valves monitored as required by paragraph (e)(7)(iii) of this section

(iii) When determining monitoring frequency for each group of processes or subgroup subject to monthly, quarterly, or semiannual monitoring frequencies, the percent leaking valves shall be the arithmetic average of the percent leaking valves from the last two monitoring periods. When determining monitoring frequency for each group of processes or subgroup subject to annual or biennial (once every 2 years) monitoring frequencies, the percent leaking valves shall be the arithmetic average of the percent leaking valves from the last three monitoring periods.

(iv)(A) Nonrepairable valves shall be included in the calculation of percent leaking valves the first time the valve is identified as leaking and nonrepairable and as required to comply with paragraph (e)(6)(iv)(B) of this section. Otherwise, a number of nonrepairable valves (identified and included in the percent leaking calculation in a previous period) up to a maximum of 1 percent of the total number of valves in organic HAP service at a process may be excluded from calculation of percent leaking valves for subsequent monitoring periods.

(B) If the number of nonrepairable valves exceeds 1 percent of the total number of valves in organic HAP service at a process, the number of nonrepairable valves exceeding 1 percent of the total number of valves in organic HAP service shall be included in the calculation of percent leaking valves.

(7) *Repair provisions.* (i) When a leak is detected, it shall be repaired as soon as practicable, but no later than 15 calendar days after the leak is detected, except as provided in paragraph (b)(3)(i) of this section.

(ii) A first attempt at repair shall be made no later than 5 calendar days after each leak is detected.

(iii) When a leak is repaired, the valve shall be monitored at least once within the first 3 months after its repair. Days that the valve is not in organic HAP service shall not be considered part of this 3-month period. The monitoring required by this paragraph is in addition to the monitoring required to satisfy the definitions of "repaired" and "first attempt at repair."

(A) The monitoring shall be conducted as specified in §63.180(b) and (c) as appropriate, to determine whether the valve has resumed leaking.

(B) Periodic monitoring required by paragraphs (e)(2) through (4) of this section may be used to satisfy the requirements of paragraph (e)(7)(iii) of this section, if the timing of the monitoring period coincides with the time specified in paragraph (e)(7)(iii) of this section. Alternatively, other monitoring may be performed to satisfy the requirements of paragraph (e)(7)(iii) of this section, regardless of whether the timing of the monitoring period for periodic monitoring coincides with the time specified in paragraph (e)(7)(iii) of this section.

(C) If a leak is detected by monitoring that is conducted pursuant to paragraph (e)(7)(iii) of this section, the owner or operator shall follow the provisions of paragraphs (e)(7)(iii)(C)(1) and (2) of this section to determine whether that valve must be counted as a leaking valve for purposes of paragraph (e)(6) of this section.

(1) If the owner or operator elects to use periodic monitoring required by paragraphs (e)(2) through (4) of this section to satisfy the requirements of paragraph (e)(7)(iii) of this section, then the valve shall be counted as a leaking valve.

(2) If the owner or operator elects to use other monitoring prior to the periodic monitoring required by paragraphs (e)(2) through (4) of this section to satisfy the requirements of paragraph (e)(7)(iii) of this section, then the valve shall be counted as a leaking valve unless it is repaired and shown by periodic monitoring not to be leaking.

(8) First attempts at repair include, but are not limited to, the following practices where practicable:

(i) Tightening of bonnet bolts,

(ii) Replacement of bonnet bolts,

(iii) Tightening of packing gland nuts, and

(iv) Injection of lubricant into lubricated packing.

(9) Any equipment located at a plant site with fewer than 250 valves in organic HAP service in the affected source is exempt from the requirements for monthly monitoring specified in paragraph (e)(4)(i) of this section. Instead, the owner or operator shall monitor each valve in organic HAP service for leaks once each quarter, or comply with paragraph (e)(4)(iii), (iv), or (v) of this section, except as provided in paragraph (f) of this section.

(f) *Unsafe to monitor, difficult-to-monitor, and inaccessible equipment.* (1) Equipment that is designated as unsafe-to-monitor, difficult-to-monitor, or inaccessible is exempt from the requirements as specified in paragraphs (f)(1)(i) through (iv) of this section provided the owner or operator meets the requirements specified in paragraph (f)(2), (3), or (4) of this section, as applicable. All equipment, except connectors that meet the requirements in paragraph (f)(4) of this section, must be assigned to a group of

processes. Ceramic or ceramic-lined connectors are subject to the same requirements as inaccessible connectors.

(i) For pumps and agitators, paragraphs (c)(2), (3), and (4) of this section do not apply.

(ii) For valves, paragraphs (e)(2) through (7) of this section do not apply.

(iii) For connectors, §63.174(b) through (e) and paragraphs (b)(3)(iii)(C) through (G) of this section do not apply.

(iv) For closed-vent systems, §63.172(f)(1), (f)(2), and (g) do not apply.

(2) *Equipment that is unsafe-to-monitor.* (i) Valves, connectors, agitators, and any part of closed-vent systems may be designated as unsafe-to-monitor if the owner or operator determines that monitoring personnel would be exposed to an immediate danger as a consequence of complying with the monitoring requirements identified in paragraphs (f)(1)(i) through (iii) of this section, or the inspection requirements identified in paragraph (f)(1)(iv) of this section.

(ii) The owner or operator of equipment that is designated as unsafe-to-monitor must have a written plan that requires monitoring of the equipment as frequently as practicable during safe-to-monitor times. For valves, connectors, and agitators, monitoring shall not be more frequent than the periodic monitoring schedule otherwise applicable to the group of processes in which the equipment is located. For closed-vent systems, inspections shall not be more frequent than annually.

(3) *Equipment that is difficult-to-monitor.* (i) A valve, agitator, pump, or any part of a closed-vent system may be designated as difficult-to-monitor if the owner or operator determines that the equipment cannot be monitored or inspected without elevating the monitoring personnel more than 2 meters above a support surface or the equipment is not accessible in a safe manner when it is in organic HAP service;

(ii) At a new affected source, an owner or operator may designate no more than 3 percent of valves as difficult-to-monitor.

(iii) The owner or operator of valves, agitators, or pumps designated as difficult-to-monitor must have a written plan that requires monitoring of the equipment at least once per calendar year or on the periodic monitoring schedule otherwise applicable to the group of processes in which the equipment is located, whichever is less frequent. For any part of a closed-vent system designated as difficult-to-monitor, the owner or operator must have a written plan that requires inspection of the closed-vent system at least once every 5 years.

(4) *Inaccessible, ceramic, or ceramic-lined connectors.* (i) A connector may be designated as inaccessible if it is:

(A) Buried;

(B) Insulated in a manner that prevents access to the equipment by a monitor probe;

(C) Obstructed by equipment or piping that prevents access to the equipment by a monitor probe;

(D) Unable to be reached from a wheeled scissor-lift or hydraulic-type scaffold which would allow access to equipment up to 7.6 meters above the ground; or

(E) Not able to be accessed at any time in a safe manner to perform monitoring. Unsafe access includes, but is not limited to, the use of a wheeled scissor-lift on unstable or uneven terrain, the use of a

motorized man-lift basket in areas where an ignition potential exists, or access would require near proximity to hazards such as electrical lines, or would risk damage to equipment.

(F) Would require elevating the monitoring personnel more than 2 meters above a permanent support surface or would require the erection of scaffold.

(ii) At a new affected source, an owner or operator may designate no more than 3 percent of connectors as inaccessible.

(iii) If any inaccessible, ceramic, or ceramic-lined connector is observed by visual, audible, olfactory, or other means to be leaking, the leak shall be repaired as soon as practicable, but no later than 15 calendar days after the leak is detected, except as provided in paragraph (b)(3)(i) of this section.

(iv) Any connector that is inaccessible or that is ceramic or ceramic-lined is exempt from the recordkeeping and reporting requirements of paragraphs (g) and (h) of this section.

(g) *Recordkeeping requirements.* (1) An owner or operator of more than one group of processes subject to the provisions of this section may comply with the recordkeeping requirements for the groups of processes in one recordkeeping system if the system identifies with each record the program being implemented (e.g., quarterly monitoring) for each type of equipment. All records and information required by this section shall be maintained in a manner that can be readily accessed at the plant site. This could include physically locating the records at the plant site or accessing the records from a central location by computer at the plant site.

(2) *General recordkeeping.* Except as provided in paragraph (g)(5) of this section, the following information pertaining to all equipment subject to the requirements in this section shall be recorded:

(i)(A) A list of identification numbers for equipment (except instrumentation systems) subject to the requirements of this section. Connectors, except those subject to paragraph (f) of this section, need not be individually identified if all connectors in a designated area or length of pipe subject to the provisions of this section are identified as a group, and the number of subject connectors is indicated. The list for each type of equipment shall be completed no later than the completion of the initial survey required for that component. The list of identification numbers shall be updated, if needed, to incorporate equipment changes within 15 calendar days of the completion of each monitoring survey for the type of equipment component monitored.

(B) A schedule for monitoring connectors subject to the provisions of §63.174(a) of subpart H of this part and valves subject to the provisions of paragraph (e)(4) of this section.

(C) Physical tagging of the equipment is not required to indicate that it is in organic HAP service. Equipment subject to the provisions of this section may be identified on a plant site plan, in log entries, or by other appropriate methods.

(ii)(A) A list of identification numbers for equipment that the owner or operator elects to equip with a closed-vent system and control device, subject to the provisions of paragraphs (b)(4)(iv) or (c)(7) of this section or §63.164(h).

(B) A list of identification numbers for compressors that the owner or operator elects to designate as operating with an instrument reading of less than 500 parts per million above background, under the provisions of §63.164(i) of subpart H of this part.

(iii)(A) A list of identification numbers for pressure relief devices subject to the provisions in paragraph (b)(4)(i) of this section.

(B) A list of identification numbers for pressure relief devices equipped with rupture disks, subject to the provisions of paragraph (b)(4)(ii)(B) of this section.

(iv) Identification of instrumentation systems subject to the provisions of this section. Individual components in an instrumentation system need not be identified.

(v) The following information shall be recorded for each dual mechanical seal system:

(A) Design criteria required by paragraph (c)(5)(vi)(A) of this section and §63.164(e)(2) of subpart H of this part, and an explanation of the design criteria; and

(B) Any changes to these criteria and the reasons for the changes.

(vi) A list of equipment designated as unsafe-to-monitor or difficult-to-monitor under paragraph (f) of this section and a copy of the plan for monitoring this equipment.

(vii) A list of connectors removed from and added to the process, as described in §63.174(i)(1) of subpart H of this part, and documentation of the integrity of the weld for any removed connectors, as required in §63.174(j) of subpart H of this part. This is not required unless the net credits for removed connectors is expected to be used.

(viii) For batch processes that the owner or operator elects to monitor as provided under §63.178(c) of subpart H of this part, a list of equipment added to batch product processes since the last monitoring period required in §63.178(c)(3)(ii) and (iii) of subpart H of this part. This list must be completed for each type of equipment within 15 calendar days of the completion of the each monitoring survey for the type of equipment monitored.

(3) *Records of visual inspections.* For visual inspections of equipment subject to the provisions of paragraphs (c)(2)(iii) and (c)(5)(iv) of this section, the owner or operator shall document that the inspection was conducted and the date of the inspection. The owner or operator shall maintain records as specified in paragraph (g)(4) of this section for leaking equipment identified in this inspection, except as provided in paragraph (g)(5) of this section. These records shall be retained for 5 years.

(4) *Monitoring records.* When each leak is detected as specified in paragraphs (c) and (e) of this section and §§63.164, 63.169, 63.172, and 63.174 of subpart H of this part, the owner or operator shall record the information specified in paragraphs (g)(4)(i) through (ix) of this section. All records shall be retained for 5 years, in accordance with the requirements of §63.10(b)(1) of subpart A of this part.

(i) The instrument and the equipment identification number and the operator name, initials, or identification number.

(ii) The date the leak was detected and the date of first attempt to repair the leak.

(iii) The date of successful repair of the leak.

(iv) If postrepair monitoring is required, maximum instrument reading measured by Method 21 of 40 CFR part 60, appendix A, after it is successfully repaired or determined to be nonrepairable.

(v) "Repair delayed" and the reason for the delay if a leak is not repaired within 15 calendar days after discovery of the leak.

(A) The owner or operator may develop a written procedure that identifies the conditions that justify a delay of repair. The written procedures must be maintained at the plant site. Reasons for delay of repair may be documented by citing the relevant sections of the written procedure.

(B) If delay of repair was caused by depletion of stocked parts, there must be documentation that the spare parts were sufficiently stocked onsite before depletion and the reason for depletion.

(vi) If repairs were delayed, dates of process shutdowns that occur while the equipment is unrepaired.

(vii)(A) If the alternative in §63.174(c)(1)(ii) of subpart H of this part is not in use for the monitoring period, identification, either by list, location (area or grouping), or tagging of connectors disturbed since the last monitoring period required in §63.174(b) of subpart H of this part, as described in §63.174(c)(1) of subpart H of this part.

(B) The date and results of follow-up monitoring as required in §63.174(c) of subpart H of this part. If identification of disturbed connectors is made by location, then all connectors within the designated location shall be monitored.

(viii) The date and results of the monitoring required in §63.178(c)(3)(i) of subpart H of this part for equipment added to a batch process since the last monitoring period required in §63.178(c)(3)(ii) and (iii) of subpart H of this part. If no leaking equipment is found in this monitoring, the owner or operator shall record that the inspection was performed. Records of the actual monitoring results are not required.

(ix) Copies of the periodic reports as specified in paragraph (h)(3) of this section, if records are not maintained on a computerized data base capable of generating summary reports from the records.

(5) *Records of pressure tests.* The owner or operator who elects to pressure test a process equipment train and supply lines between storage and processing areas to demonstrate compliance with this section is exempt from the requirements of paragraphs (g)(2), (3), (4), and (6) of this section. Instead, the owner or operator shall maintain records of the following information:

(i) The identification of each product, or product code, produced during the calendar year. It is not necessary to identify individual items of equipment in the process equipment train.

(ii) Records demonstrating the proportion of the time during the calendar year the equipment is in use in the process that is subject to the provisions of this subpart. Examples of suitable documentation are records of time in use for individual pieces of equipment or average time in use for the process unit. These records are not required if the owner or operator does not adjust monitoring frequency by the time in use, as provided in §63.178(c)(3)(iii) of subpart H of this part.

(iii) Physical tagging of the equipment to identify that it is in organic HAP service and subject to the provisions of this section is not required. Equipment in a process subject to the provisions of this section may be identified on a plant site plan, in log entries, or by other appropriate methods.

(iv) The dates of each pressure test required in §63.178(b) of subpart H of this part, the test pressure, and the pressure drop observed during the test.

(v) Records of any visible, audible, or olfactory evidence of fluid loss.

(vi) When a process equipment train does not pass two consecutive pressure tests, the following information shall be recorded in a log and kept for 2 years:

(A) The date of each pressure test and the date of each leak repair attempt.

(B) Repair methods applied in each attempt to repair the leak.

(C) The reason for the delay of repair.

(D) The expected date for delivery of the replacement equipment and the actual date of delivery of the replacement equipment.

(E) The date of successful repair.

(6) *Records of compressor and pressure relief device compliance tests.* The dates and results of each compliance test required for compressors subject to the provisions in §63.164(i) and the dates and results of the Method 21 of 40 CFR part 60, appendix A, monitoring following a pressure release for each pressure relief device subject to the provisions in paragraphs (b)(4)(i) and (ii) of this section. The results shall include:

(i) The background level measured during each compliance test.

(ii) The maximum instrument reading measured at each piece of equipment during each compliance test.

(7) *Records for closed-vent systems.* The owner or operator shall maintain records of the information specified in paragraphs (g)(7)(i) through (iii) of this section for closed-vent systems and control devices subject to the provisions of paragraph (b)(3)(ii) of this section. The records specified in paragraph (g)(7)(i) of this section shall be retained for the life of the equipment. The records specified in paragraphs (g)(7)(ii) and (iii) of this section shall be retained for 5 years.

(i) The design specifications and performance demonstrations specified in paragraphs (g)(7)(i)(A) through (D) of this section.

(A) Detailed schematics, design specifications of the control device, and piping and instrumentation diagrams.

(B) The dates and descriptions of any changes in the design specifications.

(C) The flare design (i.e., steam assisted, air assisted, or nonassisted) and the results of the compliance demonstration required by §63.11(b) of subpart A of this part.

(D) A description of the parameter or parameters monitored, as required in paragraph (b)(3)(ii) of this section, to ensure that control devices are operated and maintained in conformance with their design and an explanation of why that parameter (or parameters) was selected for the monitoring.

(ii) Records of operation of closed-vent systems and control devices.

(A) Dates and durations when the closed-vent systems and control devices required in paragraph (c) of this section and §§63.164 through 63.166 of subpart H of this part are not operated as designed as indicated by the monitored parameters, including periods when a flare pilot light system does not have a flame.

(B) Dates and durations during which the monitoring system or monitoring device is inoperative.

(C) Dates and durations of startups and shutdowns of control devices required in paragraph (c) of this section and §§63.164 through 63.166 of subpart H of this part.

(iii) Records of inspections of closed-vent systems subject to the provisions of §63.172 of subpart H of this part.

(A) For each inspection conducted in accordance with the provisions of §63.172(f)(1) or (2) of subpart H of this part during which no leaks were detected, a record that the inspection was performed, the date of the inspection, and a statement that no leaks were detected.

(B) For each inspection conducted in accordance with the provisions of §63.172(f)(1) or (f)(2) of subpart H of this part during which leaks were detected, the information specified in paragraph (g)(4) of this section shall be recorded.

(8) *Records for components in heavy liquid service.* Information, data, and analysis used to determine that a piece of equipment or process is in heavy liquid service shall be recorded. Such a determination shall include an analysis or demonstration that the process fluids do not meet the criteria of "in light liquid or gas/vapor service." Examples of information that could document this include, but are not limited to, records of chemicals purchased for the process, analyses of process stream composition, engineering calculations, or process knowledge.

(9) *Records of exempt components.* Identification, either by list, location (area or group), or other method of equipment in organic HAP service less than 300 hr/yr subject to the provisions of this section.

(10) *Records of alternative means of compliance determination.* Owners and operators choosing to comply with the requirements of §63.179 of subpart H of this part shall maintain the following records:

(i) Identification of the process(es) and the organic HAP they handle.

(ii) A schematic of the process, enclosure, and closed-vent system.

(iii) A description of the system used to create a negative pressure in the enclosure to ensure that all emissions are routed to the control device.

(11) *Records of pressure releases to the atmosphere from pressure relief devices.* For pressure relief devices in organic HAP service subject to paragraph (b)(4)(iii) of this section, keep records of each pressure release to the atmosphere, including the following information:

(i) The source, nature, and cause of the pressure release.

(ii) The date, time, and duration of the pressure release.

(iii) The quantity of total HAP emitted during the pressure release and the calculations used for determining this quantity.

(iv) The actions taken to prevent this pressure release.

(v) The measures adopted to prevent future such pressure releases.

(h) *Reporting Requirements.* (1) Each owner or operator of a source subject to this section shall submit the reports listed in paragraphs (h)(1)(i) and (ii) of this section.

- (i) A Notification of Compliance Status report described in paragraph (h)(2) of this section, and
- (ii) Periodic reports described in paragraph (h)(3) of this section.

(2) *Notification of compliance status report.* Each owner or operator of a source subject to this section shall submit the information specified in paragraphs (h)(2)(i) through (iii) of this section in the Notification of Compliance Status report described in §63.1368(f). For pressure relief devices subject to the requirements of paragraph (b)(4)(iii) of this section, the owner or operator shall submit the information listed in paragraph (h)(2)(iv) of this section in the Notification of Compliance Status within 150 days after the first applicable compliance date for pressure relief device monitoring. Section 63.9(j) of subpart A of this part shall not apply to the Notification of Compliance Status report.

(i) The notification shall provide the information listed in paragraphs (h)(2)(i)(A) through (C) of this section for each group of processes subject to the requirements of paragraphs (b) through (g) of this section.

(A) Identification of the group of processes.

(B) Approximate number of each equipment type (e.g., valves, pumps) in organic HAP service, excluding equipment in vacuum service.

(C) Method of compliance with the standard (for example, “monthly leak detection and repair” or “equipped with dual mechanical seals”).

(ii) The notification shall provide the information listed in paragraphs (h)(2)(ii)(A) and (B) of this section for each process subject to the requirements of paragraph (b)(3)(iv) of this section and §63.178(b) of subpart H of this part.

(A) Products or product codes subject to the provisions of this section, and

(B) Planned schedule for pressure testing when equipment is configured for production of products subject to the provisions of this section.

(iii) The notification shall provide the information listed in paragraphs (h)(2)(iii)(A) and (B) of this section for each process subject to the requirements in §63.179 of subpart H of this part.

(A) Process identification.

(B) A description of the system used to create a negative pressure in the enclosure and the control device used to comply with the requirements of paragraph (b)(3)(ii) of this section.

(iv) For pressure relief devices in organic HAP service, a description of the device or monitoring system to be implemented, including the pressure relief devices and process parameters to be monitored (if applicable), a description of the alarms or other methods by which operators will be notified of a pressure release, and a description of how the owner or operator will determine the information to be recorded under paragraphs (g)(11)(ii) and (iii) of this section (i.e., the duration of the pressure release and the methodology and calculations for determining of the quantity of total HAP emitted during the pressure release).

(3) *Periodic reports.* The owner or operator of a source subject to this section shall submit Periodic reports.

(i) A report containing the information in paragraphs (h)(3)(ii) through (v) of this section shall be submitted semiannually. The first Periodic report shall be submitted no later than 240 days after the date the Notification of Compliance Status report is due and shall cover the 6-month period beginning on the date the Notification of Compliance Status report is due. Each subsequent Periodic report shall cover the 6-month period following the preceding period.

(ii) For equipment complying with the provisions of paragraphs (b) through (g) of this section, the Periodic report shall contain the summary information listed in paragraphs (h)(3)(ii)(A) through (L) of this section for each monitoring period during the 6-month period.

(A) The number of valves for which leaks were detected as described in paragraph (e)(2) of this section, the percent leakers, and the total number of valves monitored;

(B) The number of valves for which leaks were not repaired as required in paragraph (e)(7) of this section, identifying the number of those that are determined nonreparable;

(C) The number of pumps and agitators for which leaks were detected as described in paragraph (c)(2) of this section, the percent leakers, and the total number of pumps and agitators monitored;

(D) The number of pumps and agitators for which leaks were not repaired as required in paragraph (c)(3) of this section;

(E) The number of compressors for which leaks were detected as described in §63.164(f) of subpart H of this part;

(F) The number of compressors for which leaks were not repaired as required in §63.164(g) of subpart H of this part;

(G) The number of connectors for which leaks were detected as described in §63.174(a) of subpart H of this part, the percent of connectors leaking, and the total number of connectors monitored;

(H) The number of connectors for which leaks were not repaired as required in §63.174(d) of subpart H of this part, identifying the number of those that are determined nonreparable;

(I) The facts that explain any delay of repairs and, where appropriate, why a process shutdown was technically infeasible.

(J) The results of all monitoring to show compliance with §§63.164(i) and 63.172(f) conducted within the semiannual reporting period.

(K) If applicable, the initiation of a monthly monitoring program under either paragraph (c)(4)(ii) or paragraph (e)(4)(i)(A) of this section.

(L) If applicable, notification of a change in connector monitoring alternatives as described in §63.174(c)(1) of subpart H of this part.

(iii) For owners or operators electing to meet the requirements of §63.178(b) of subpart H of this part, the Periodic report shall include the information listed in paragraphs (h)(3)(iii) (A) through (E) of this section for each process.

(A) Product process equipment train identification;

(B) The number of pressure tests conducted;

(C) The number of pressure tests where the equipment train failed either the retest or two consecutive pressure tests;

(D) The facts that explain any delay of repairs; and

(E) The results of all monitoring to determine compliance with §63.172(f) of subpart H of this part.

(iv) Any change in the information submitted under paragraph (h)(2) of this section shall be provided in the next Periodic report.

(v) For pressure relief devices in organic HAP service, Periodic Reports must include the information specified in paragraphs (h)(3)(v)(A) through (C) of this section.

(A) For pressure relief devices in organic HAP service subject to paragraph (b)(4) of this section, report confirmation that all monitoring to show compliance was conducted within the reporting period.

(B) For pressure relief devices in organic HAP gas or vapor service subject to paragraph (b)(4)(ii) of this section, report any instrument reading of 500 ppm above background or greater, more than 5 calendar days after the pressure release.

(C) For pressure relief devices in organic HAP service subject to paragraph (b)(4)(iii) of this section, report each pressure release to the atmosphere, including the following information:

(1) The source, nature, and cause of the pressure release.

(2) The date, time, and duration of the pressure release.

(3) The quantity of total HAP emitted during the pressure release and the method used for determining this quantity.

(4) The actions taken to prevent this pressure release.

(5) The measures adopted to prevent future such pressure releases.

[64 FR 33589, June 23, 1999, as amended at 67 FR 59345, Sept. 20, 2002; 79 FR 17372, Mar. 27, 2014]

 [Back to Top](#)

§63.1364 Compliance dates.

(a) *Compliance dates for existing sources.* (1) An owner or operator of an existing affected source must comply with the provisions in this subpart (except §63.1363(b)(4)(iii)) by December 23, 2003. Compliance with the pressure relief device monitoring provisions of §63.1363(b)(4)(iii) shall occur no later than March 27, 2017.

(2) Pursuant to section 112(i)(3)(B) of the CAA, an owner or operator of an existing source may request an extension of up to 1 additional year to comply with the provisions of this subpart if the additional time is needed for the installation of controls.

(i) For purposes of this subpart, a request for an extension shall be submitted no later than 120 days prior to the compliance date specified in paragraph (a)(1) of this section, except as provided in paragraph (a)(2)(ii) of this section. The dates specified in §63.6(i) of subpart A of this part for submittal of requests for extensions shall not apply to sources subject to this subpart.

(ii) An owner or operator may submit a compliance extension request after the date specified in paragraph (a)(1)(i) of this section provided the need for the compliance extension arose after that date and before the otherwise applicable compliance date, and the need arose due to circumstances beyond reasonable control of the owner or operator. This request shall include the data described in §63.6(i)(8)(A), (B), and (D) of subpart A of this part.

(b) *Compliance dates for new and reconstructed sources.* An owner or operator of a new or reconstructed affected source must comply with the provisions of this subpart (except §63.1363(b)(4)(iii)) on June 23, 1999 or upon startup, whichever is later. New or reconstructed affected sources that commenced construction after November 10, 1997, but on or before January 9, 2012, must be in compliance with the pressure relief device monitoring provisions of §63.1363(b)(4)(iii) no later than March 27, 2017. New or reconstructed sources that commenced construction after January 9, 2012, must be in compliance with the pressure relief device monitoring provisions of §63.1363(b)(4)(iii) upon initial startup or by March 27, 2014, whichever is later.

[64 FR 33589, June 23, 1999, as amended at 67 FR 13511, Mar. 22, 2002; 67 FR 38203, June 3, 2002; 79 FR 17374, Mar. 27, 2014]

[↑ Back to Top](#)

§63.1365 Test methods and initial compliance procedures.

(a) *General.* Except as specified in paragraph (a)(4) of this section, the procedures specified in paragraphs (c), (d), (e), (f), and (g) of this section are required to demonstrate initial compliance with §63.1362(b), (c), (d), (f), and (g), respectively. The provisions in paragraph (a)(1) of this section apply to design evaluations that are used to demonstrate compliance with the standards for process vents and storage vessels. The provisions in paragraph (a)(2) of this section apply to performance tests that are specified in paragraphs (c), (d), and (e) of this section. The provisions in paragraph (a)(3) of this section describe initial compliance procedures for flares. The provisions in paragraph (a)(5) of this section are used to demonstrate initial compliance with the alternative standards specified in §63.1362(b)(6) and (c)(4). The provisions in paragraph (a)(6) of this section are used to comply with the outlet concentration requirements specified in §63.1362(b)(2)(iv)(A), (b)(3)(ii), (b)(4)(ii)(A), (b)(5)(ii), and (b)(5)(iii).

(1) *Design evaluation.* To demonstrate that a control device meets the required control efficiency, a design evaluation must address the composition and HAP concentration of the vent stream entering the control device. A design evaluation also must address other vent stream characteristics and control device operating parameters as specified in any one of paragraphs (a)(1)(i) through (vii) of this section, depending on the type of control device that is used. If the vent stream is not the only inlet to the control device, the efficiency demonstration also must consider all other vapors, gases, and liquids, other than fuels, received by the control device.

(i) For an enclosed combustion device used to comply with the provisions of §63.1362(b)(2)(iv), (b)(4)(ii), (c)(2)(iv)(B), or (c)(3) with a minimum residence time of 0.5 seconds and a minimum temperature of 760 °C, the design evaluation must document that these conditions exist.

(ii) For a combustion control device that does not satisfy the criteria in paragraph (a)(1)(i) of this section, the design evaluation must document control efficiency and address the following characteristics, depending on the type of control device:

(A) For a thermal vapor incinerator, the design evaluation must consider the autoignition temperature of the organic HAP, must consider the vent stream flow rate, and must establish the design minimum and average temperature in the combustion zone and the combustion zone residence time.

(B) For a catalytic vapor incinerator, the design evaluation must consider the vent stream flow rate and must establish the design minimum and average temperatures across the catalyst bed inlet and outlet.

(C) For a boiler or process heater, the design evaluation must consider the vent stream flow rate, must establish the design minimum and average flame zone temperatures and combustion zone residence time, and must describe the method and location where the vent stream is introduced into the flame zone.

(iii) For a condenser, the design evaluation must consider the vent stream flow rate, relative humidity, and temperature, and must establish the maximum temperature of the condenser exhaust vent stream and the corresponding outlet organic HAP compound concentration level or emission rate for which the required reduction is achieved.

(iv) For a carbon adsorption system that regenerates the carbon bed directly onsite in the control device such as a fixed-bed adsorber, the design evaluation must consider the vent stream flow rate, relative humidity, and temperature, and must establish the design exhaust vent stream organic compound concentration level, adsorption cycle time, number of carbon beds and their capacities, type and working capacity of activated carbon used for the carbon beds, design total regeneration stream mass or volumetric flow over the period of each complete carbon bed regeneration cycle, design carbon bed temperature after regeneration, design carbon bed regeneration time, and design service life of carbon. For vacuum desorption, the pressure drop must be included.

(v) For a carbon adsorption system that does not regenerate the carbon bed directly onsite in the control device such as a carbon canister, the design evaluation must consider the vent stream mass or volumetric flow rate, relative humidity, and temperature, and must establish the design exhaust vent stream organic compound concentration level, capacity of the carbon bed, type and working capacity of activated carbon used for the carbon bed, and design carbon replacement interval based on the total carbon working capacity of the control device and source operating schedule.

(vi) For a scrubber, the design evaluation must consider the vent stream composition, constituent concentrations, liquid-to-vapor ratio, scrubbing liquid flow rate and concentration, temperature, and the reaction kinetics of the constituents with the scrubbing liquid. The design evaluation must establish the design exhaust vent stream organic compound concentration level and must include the additional information in paragraphs (a)(1)(vi)(A) and (B) of this section for trays and a packed column scrubber.

(A) Type and total number of theoretical and actual trays;

(B) Type and total surface area of packing for entire column, and for individual packed sections if column contains more than one packed section.

(vii) For fabric filters, the design evaluation must include the pressure drop through the device and the net gas-to-cloth ratio (i.e., cubic feet of gas per square feet of cloth).

(2) *Calculation of TOC or total organic HAP concentration.* The TOC concentration or total organic HAP concentration is the sum of the concentrations of the individual components. If compliance is being determined based on TOC, the owner or operator shall compute TOC for each run using Equation 6 of this subpart. If compliance is being determined based on total organic HAP, the owner or operator shall compute total organic HAP using Equation 6 of this subpart, except that only organic HAP compounds

shall be summed; when determining compliance with the wastewater provisions of §63.1362(d), the organic HAP compounds shall consist of the organic HAP compounds in Table 9 of subpart G of this part.

$$CG_T = \frac{1}{m} \sum_{j=1}^m \left(\sum_{i=1}^n CGS_{i,j} \right) \quad (\text{Eq. 6})$$

[View or download PDF](#)

Where:

CG_T = total concentration of TOC or organic HAP in vented gas stream, average of samples, dry basis, ppmv

$CGS_{i,j}$ = concentration of sample components in vented gas stream for sample j , dry basis, ppmv

n = number of compounds in the sample

m = number of samples in the sample run.

(3) *Initial compliance using flares.* When a flare is used to comply with the standards, the owner or operator shall comply with the provisions in §63.11(b) of subpart A of this part.

(i) The initial compliance determination shall consist of a visible emissions determination using Method 22 of 40 CFR part 60, appendix A, as described in §63.11(b)(4) of subpart A of this part, and a determination of net heating value of gas being combusted and exit velocity to comply with the requirements of §63.11(b)(6) through (8) of subpart A of this part. The net heating value and exit velocity shall be based on the results of performance testing under the conditions described in paragraphs (b)(10) and (11) of this section.

(ii) An owner or operator is not required to conduct a performance test to determine percent emission reduction or outlet organic HAP or TOC concentration when a flare is used.

(4) *Exemptions from compliance demonstrations.* An owner or operator using any control device specified in paragraphs (a)(4)(i) through (ii) of this section is exempt from the initial compliance provisions in paragraphs (c), (d), and (e) of this section.

(i) A boiler or process heater with a design heat input capacity of 44 megawatts or greater.

(ii) A boiler or process heater into which the emission stream is introduced with the primary fuel.

(5) *Initial compliance with alternative standard.* Initial compliance with the alternative standards in §63.1362(b)(6) and (c)(4) for combustion devices is demonstrated when the outlet TOC concentration is 20 ppmv or less, and the outlet HCl and chlorine concentration is 20 ppmv or less. Initial compliance with the alternative standards in §63.1362(b)(6) and (c)(4) for noncombustion devices is demonstrated when the outlet TOC concentration is 50 ppmv or less, and the outlet HCl and chlorine concentration is 50 ppmv or less. To demonstrate initial compliance, the owner or operator shall be in compliance with the monitoring provisions in §63.1366(b)(5) on the initial compliance date. The owner or operator shall use Method 18 to determine the predominant organic HAP in the emission stream if the TOC monitor is calibrated on the predominant HAP.

(6) *Initial compliance with the 20 ppmv outlet limit.* Initial compliance with the 20 ppmv TOC or total organic HAP concentration is demonstrated when the outlet TOC or total organic HAP concentration is 20 ppmv or less. Initial compliance with the 20 ppmv HCl and chlorine concentration is demonstrated when the outlet HCl and chlorine concentration is 20 ppmv or less. To demonstrate initial compliance, the

operator shall use applicable test methods described in paragraphs (b)(1) through (9) of this section, and test under conditions described in paragraph (b)(10) or (11) of this section, as applicable. The owner or operator shall comply with the monitoring provisions in §63.1366(b)(1) through (5) on the initial compliance date.

(7) *Outlet concentration correction for supplemental gases.* If supplemental gases are added to a vent stream for which compliance with an outlet concentration standard in §63.1362 or 63.1363 will be demonstrated, the owner or operator must correct the outlet concentration as specified in paragraphs (a)(7)(i) and (ii) of this section.

(i) *Combustion device.* Except as specified in §63.1366(b)(5)(ii)(A), if the vent stream is controlled with a combustion device, the owner or operator must comply with the provisions in paragraphs (a)(7)(i)(A) through (C) of this section.

(A) To comply with a TOC or total organic HAP outlet concentration standard in §63.1362(b)(2)(iv)(A), (b)(4)(ii)(A), (b)(6), (c)(2)(iv)(B), (c)(4), (d)(13), or §63.172, the actual TOC outlet concentration must be corrected to 3 percent oxygen.

(B) If the inlet stream to the combustion device contains any HCl, chlorine, or halogenated compounds, and the owner or operator elects to comply with a total HCl and chlorine outlet concentration standard in §63.1362(b)(3)(ii), (b)(5)(ii), (b)(5)(iii), (b)(6), or (c)(4), the actual total HCl and chlorine outlet concentration must be corrected to 3 percent oxygen.

(C) The integrated sampling and analysis procedures of Method 3B of 40 CFR part 60, appendix A, shall be used to determine the actual oxygen concentration (%O_{2d}). The samples shall be taken during the same time that the TOC, total organic HAP, and total HCl and chlorine samples are taken. The concentration corrected to 3 percent oxygen (C_e) shall be computed using Equation 7 of this subpart:

$$C_e = C_m \left(\frac{17.9}{20.9 - \%O_{2d}} \right) \quad (\text{Eq. 7})$$

[View or download PDF](#)

Where:

C_e = concentration of TOC, total organic HAP, or total HCl and chlorine corrected to 3 percent oxygen, dry basis, ppmv

C_m = total concentration of TOC, total organic HAP, or total HCl and chlorine in the vented gas stream, average of samples, dry basis, ppmv

%O_{2d} = concentration of oxygen measured in vented gas stream, dry basis, percent by volume.

(ii) *Noncombustion devices.* If a control device other than a combustion device, and not in series with a combustion device, is used to comply with a TOC, total organic HAP, or total HCl and chlorine outlet concentration standard, the owner or operator must correct the actual concentration for supplemental gases using Equation 8 of this subpart.

$$C_a = C_m \left(\frac{V_s + V_a}{V_a} \right) \quad (\text{Eq. 8})$$

[View or download PDF](#)

Where:

C_a = corrected outlet TOC, total organic HAP, or total HCl and chlorine concentration, dry basis, ppmv

C_m = actual TOC, total organic HAP, or total HCl and chlorine concentration measured at control device outlet, dry basis, ppmv

V_a = total volumetric flow rate of affected streams vented to the control device

V_s = total volumetric flow rate of supplemental gases.

(b) *Test methods and conditions.* When testing is conducted to measure emissions from an affected source, the test methods specified in paragraphs (b)(1) through (9) of this section shall be used. Compliance and performance tests shall be performed under such conditions as the Administrator specifies to the owner or operator based on representative performance of the affected source for the period being tested and as specified in paragraphs (b)(10) and (11) of this section. Representative conditions exclude periods of startup and shutdown unless specified by the Administrator or an applicable subpart. The owner or operator may not conduct performance tests during periods of malfunction. The owner or operator must record the process information that is necessary to document operating conditions during the test and include in such record an explanation to support that such conditions represent normal operation. Upon request, the owner or operator shall make available to the Administrator such records as may be necessary to determine the conditions of performance tests.

(1) Method 1 or 1A of appendix A of 40 CFR part 60 shall be used for sample and velocity traverses.

(2) Method 2, 2A, 2C, or 2D of appendix A of 40 CFR part 60 shall be used for velocity and volumetric flow rates.

(3) Method 3 of appendix A of 40 CFR part 60 shall be used for gas analysis.

(4) Method 4 of appendix A of 40 CFR part 60 shall be used for stack gas moisture.

(5) Concentration measurements shall be adjusted to negate the dilution effects of introducing nonaffected gaseous streams into the vent streams prior to control or measurement. The following methods are specified for concentration measurements of organic compounds:

(i) Method 18 of appendix A of 40 CFR part 60 may be used to determine HAP concentration in any control device efficiency determination.

(ii) Method 25 of appendix A of 40 CFR part 60 may be used to determine total gaseous nonmethane organic concentration for control efficiency determinations in combustion devices.

(iii) Method 25A of appendix A of 40 CFR part 60 may be used to determine the HAP or TOC concentration for control device efficiency determinations under the conditions specified in Method 25 of appendix A of 40 CFR part 60 for direct measurement of an effluent with a flame ionization detector, or in demonstrating compliance with the 20 ppmv TOC outlet standard. If Method 25A of appendix A of 40 CFR part 60 is used to determine the concentration of TOC for the 20 ppmv standard, the instrument shall be calibrated on methane or the predominant HAP. If calibrating on the predominant HAP, the use of Method 25A of appendix A of 40 CFR part 60 shall comply with paragraphs (b)(5)(i)(A) through (C) of this section.

(A) The organic HAP used as the calibration gas for Method 25A, 40 CFR part 60, appendix A, shall be the single organic HAP representing the largest percent by volume.

(B) The use of Method 25A, 40 CFR part 60, appendix A, is acceptable if the response from the high level calibration gas is at least 20 times the standard deviation of the response from the zero calibration gas when the instrument is zeroed on the most sensitive scale.

(C) The span value of the analyzer must be less than 100 ppmv.

(6) The methods in either paragraph (b)(6)(i) or (ii) of this section shall be used to determine the concentration, in mg/dscm, of total HCl and chlorine. Concentration measurements shall be adjusted to negate the dilution effects of introducing nonaffected gaseous streams into the vent streams prior to control or measurement.

(i) Method 26 or 26A of 40 CFR part 60, appendix A.

(ii) Any other method if the method or data have been validated according to the applicable procedures of Method 301 of appendix A of this part.

(7) Method 5 of appendix A of 40 CFR part 60 shall be used to determine the concentration of particulate matter in exhaust gas streams from bag dumps and product dryers.

(8) Wastewater analysis shall be conducted in accordance with §63.144(b)(5)(i) through (iii) or as specified in paragraph (b)(8)(i) or (ii) of this section.

(i) As an alternative to the methods specified in §63.144(b)(5)(i), an owner or operator may conduct wastewater analyses using Method 1666 or 1671 of 40 CFR part 136, appendix A, and comply with the sampling protocol requirements specified in §63.144(b)(5)(ii). The validation requirements specified in §63.144(b)(5)(iii) do not apply if an owner or operator uses Method 1666 or 1671 of 40 CFR part 136, appendix A.

(ii) As an alternative to the methods specified in §63.144(b)(5)(i), an owner or operator may use procedures specified in Method 8260 or 8270 in "Test Methods for Evaluating Solid Waste, Physical/Chemical Methods," EPA Publication No. SW-846, Third Edition, September 1986, as amended by Update I, November 15, 1992. An owner or operator also may use any more recent, updated version of Method 8260 or 8270 approved by EPA. For the purpose of using Method 8260 or 8270 to comply with this subpart, the owner or operator must maintain a formal quality assurance program consistent with either Section 8 of Method 8260 or Method 8270. This program must include the elements related to measuring the concentrations of volatile compounds that are specified in paragraphs (b)(8)(ii)(A) through (C) of this section.

(A) Documentation of site-specific procedures to minimize the loss of compounds due to volatilization, biodegradation, reaction, or sorption during the sample collection, storage, and preparation steps.

(B) Documentation of specific quality assurance procedures followed during sampling, sample preparation, sample introduction, and analysis.

(C) Measurement of the average accuracy and precision of the specific procedures, including field duplicates and field spiking of the material source before or during sampling with compounds having similar chemical characteristics to the target analytes.

(9) Method 22 of appendix A of 40 CFR part 60 shall be used to determine visible emissions from flares.

(10) *Testing conditions for continuous processes.* Testing of process vents on equipment operating as part of a continuous process shall consist of three one-hour runs. Gas stream volumetric flow rates shall be measured every 15 minutes during each 1-hour run. Organic HAP concentration shall be determined from samples collected in an integrated sample over the duration of each one-hour test run, or from grab samples collected simultaneously with the flow rate measurements (every 15 minutes). If an integrated sample is collected for laboratory analysis, the sampling rate shall be adjusted proportionally to reflect variations in flow rate. For continuous gas streams, the emission rate used to determine compliance shall be the average emission rate of the three test runs.

(11) *Testing conditions for batch processes.* Testing of emissions on equipment where the flow of gaseous emissions is intermittent (batch operations) shall be conducted at absolute peak-case conditions or hypothetical peak-case conditions, as specified in paragraphs (b)(11)(i) and (ii) of this section, respectively. Gas stream volumetric flow rates shall be measured at 15-minute intervals. Organic HAP, TOC, or HCl and chlorine concentration shall be determined from samples collected in an integrated sample over the duration of the test, or from grab samples collected simultaneously with the flow rate measurements (every 15 minutes). If an integrated sample is collected for laboratory analysis, the sampling rate shall be adjusted proportionally to reflect variations in flow rate. In all cases, a site-specific test plan shall be submitted to the Administrator for approval prior to testing in accordance with §63.7(c). The test plan shall include the emissions profile described in paragraph (b)(11)(iii) of this section. The term "HAP mass loading" as used in paragraphs (b)(11)(i) through (iii) of this section refers to the class of HAP, either organic or HCl and chlorine, that the control device is intended to control.

(i) *Absolute peak-case.* If the most challenging conditions for the control device occur under maximum HAP load, the absolute peak-case conditions shall be characterized by the criteria presented in paragraph (b)(11)(i)(A) or (B) of this section. Otherwise, absolute peak-case conditions are defined by the conditions in paragraph (b)(11)(i)(C) of this section.

(A) The period in which the inlet to the control device will contain at least 50 percent of the maximum HAP mass load that may be vented to the control device over any 8-hour period. An emission profile as described in paragraph (b)(11)(iii)(A) of this section shall be used to identify the 8-hour period that includes the maximum projected HAP load.

(B) A 1-hour period of time in which the inlet to the control device will contain the highest hourly HAP mass loading rate that may be vented to the control device. An emission profile as described in paragraph (b)(11)(iii)(A) of this section shall be used to identify the 1-hour period of maximum HAP loading.

(C) The period of time when a condition other than the maximum HAP load is most challenging for the control device. These conditions include, but are not limited to the following:

(1) Periods when the streams contain the highest combined VOC and HAP hourly load, as described by the emission profiles in paragraph (b)(11)(iii) of this section; or

(2) Periods when the streams contain HAP constituents that approach the limits of solubility for scrubbing media; or

(3) Periods when the streams contain HAP constituents that approach the limits of adsorptivity for carbon adsorption systems.

(ii) *Hypothetical peak-case.* Hypothetical peak-case conditions are simulated test conditions that, at a minimum, contain the highest total average hourly HAP load of emissions that would be predicted to be vented to the control device from the emissions profile described in either paragraph (b)(11)(iii)(B) or (C) of this section.

(iii) *Emissions profile.* The owner or operator may choose to perform tests only during those periods of the peak-case episode(s) that the owner or operator selects to control as part of achieving the required emission reduction. Except as specified in paragraph (b)(11)(iii)(D) of this section, the owner or operator shall develop an emission profile for the vent to the control device that describes the characteristics of the vent stream at the inlet to the control device under either absolute or hypothetical peak-case conditions. The emissions profile shall be developed based on the applicable procedures described in paragraphs (b)(11)(iii)(A) through (C) of this section, as required by paragraphs (b)(11)(i) and (ii) of this section.

(A) *Emissions profile by process.* The emissions profile must consider all emission episodes that could contribute to the vent stack for a period of time that is sufficient to include all processes venting to the stack and shall consider production scheduling. The profile shall describe the HAP load to the device that equals the highest sum of emissions from the episodes that can vent to the control device during the period of absolute peak-case conditions specified in paragraph (b)(11)(i)(A), (B), or (C) as appropriate. Emissions per episode shall be calculated using the procedures specified in paragraph (c)(2) of this section. When complying with paragraph (b)(11)(i)(B) of this section, emissions per episode shall be divided by the duration of the episode if the duration of the episode is longer than 1 hour.

(B) *Emission profile by equipment.* The emission profile must consist of emissions that meet or exceed the highest hourly HAP load that would be expected under actual processing conditions. The profile shall describe equipment configurations used to generate the emission events, volatility of materials processed in the equipment, and the rationale used to identify and characterize the emission events. The emissions may be based on using a compound more volatile than compounds actually used in the process(es), and the emissions may be generated from all equipment in the process(es) or only selected equipment.

(C) *Emission profile by capture and control device limitation.* The emission profile shall consider the capture and control system limitations and the highest hourly emissions that can be routed to the control device, based on maximum flow rate and concentrations possible because of limitations on conveyance and control equipment (e.g., fans, LEL alarms and safety bypasses).

(D) *Exemptions.* The owner or operator is not required to develop an emission profile under the circumstances described in paragraph (b)(11)(iii)(D)(1) or (2) of this section.

(1) If all process vents for a process are controlled using a control device or series of control devices that reduce HAP emissions by 98 percent or more, no other emission streams are vented to the control device when it is used to control emissions from the subject process, and the performance test is conducted over the entire batch cycle.

(2) If a control device is used to comply with the outlet concentration limit for process vent emission streams from a single process (but not necessarily all of the process vents from that process), no other emission streams are vented to the control device while it is used to control emissions from the subject process, and the performance test is conducted over the entire batch cycle.

(iv) *Test duration.* Three runs, at a minimum of 1 hour each, are required for performance testing. When complying with a percent reduction standard, each test run may be a maximum of either 24 hours or the duration of the longest batch controlled by the control device, whichever is shorter, and each run must include the same absolute or hypothetical peak-case conditions, as defined in paragraph (b)(11)(i) or (ii) of this section. When complying with an outlet concentration limit, each run must include the same absolute or hypothetical peak-case conditions, as defined in paragraph (b)(11)(i) or (ii) of this section, and the duration of each run may not exceed the duration of the applicable peak-case condition.

(c) *Initial compliance with process vent provisions.* The owner or operator of an affected source shall demonstrate compliance with the process vent standards in §63.1362(b) using the procedures described in paragraphs (c)(1) through (3) of this section.

(1) Compliance with the process vent standards in §63.1362(b) shall be demonstrated in accordance with the provisions specified in paragraphs (c)(1)(i) through (viii) of this section.

(i) Initial compliance with the emission limit cutoffs in §63.1362(b)(2)(i) and (b)(4)(i) is demonstrated when the uncontrolled organic HAP emissions from the sum of all process vents within a process are less than or equal to 0.15 Mg/yr. Uncontrolled HAP emissions shall be determined using the procedures described in paragraph (c)(2) of this section.

(ii) Initial compliance with the emission limit cutoffs in §63.1362(b)(3)(i) and (b)(5)(i) is demonstrated when the uncontrolled HCl and Cl₂ emissions from the sum of all process vents within a process are less than or equal to 6.8 Mg/yr. Initial compliance with the emission limit cutoffs in §63.1362(b)(5)(ii) and (iii) is demonstrated when the uncontrolled HCl and Cl₂ emissions are greater than or equal to 6.8 Mg/yr or greater than or equal to 191 Mg/yr, respectively. Uncontrolled emissions shall be determined using the procedures described in paragraph (c)(2) of this section.

(iii) Initial compliance with the organic HAP percent reduction requirements specified in §63.1362(b)(2)(ii), (iii), and (b)(4)(ii) is demonstrated by determining controlled HAP emissions using the procedures described in paragraph (c)(3) of this section, determining uncontrolled HAP emissions using the procedures described in paragraph (c)(2) of this section, and calculating the applicable percent reduction. As an alternative, if the conditions specified in paragraph (b)(11)(iii)(D)(1) of this section are met, initial compliance may be demonstrated by showing the control device reduces emissions by 98 percent by weight or greater using the procedures specified in paragraph (c)(3) of this section.

(iv) Initial compliance with the HCl and Cl₂ percent reduction requirements specified in §63.1362(b)(3)(ii), (b)(5)(ii), and (b)(5)(iii) is demonstrated by determining controlled emissions of HCl and Cl₂ using the procedures described in paragraph (c)(3) of this section, determining uncontrolled emissions of HCl and Cl₂ using the procedures described in paragraph (c)(2) of this section, and calculating the applicable percent reduction.

(v) Initial compliance with the outlet concentration limits in §63.1362(b)(2)(iv)(A), (b)(3)(ii), (b)(4)(ii)(A), (b)(5)(ii) and (iii) is demonstrated when the outlet TOC or total organic HAP concentration is 20 ppmv or less and the outlet HCl and chlorine concentration is 20 ppmv or less. The owner or operator shall demonstrate compliance by fulfilling the requirements in paragraph (a)(6) of this section. If an owner or operator elects to develop an emissions profile by process as described in paragraph (b)(11)(iii)(A) of this section, uncontrolled emissions shall be determined using the procedures in paragraph (c)(2) of this section.

(vi) Initial compliance with the alternative standard in §63.1362(b)(6) is demonstrated by fulfilling the requirements in paragraph (a)(5) of this section.

(vii) Initial compliance when using a flare is demonstrated by fulfilling the requirements in paragraph (a)(3) of this section.

(viii) No initial compliance demonstration is required for control devices specified in §63.1362(l).

(2) *Uncontrolled emissions.* The owner or operator referred to from paragraphs (c)(1)(i) through (v) of this section shall calculate uncontrolled emissions according to the procedures described in paragraph (c)(2)(i) or (ii) of this section, as appropriate.

(i) *Emission estimation procedures.* The owner or operator shall determine uncontrolled HAP emissions using emission measurements and/or calculations for each batch emission episode according to the engineering evaluation methodology in paragraphs (c)(2)(i)(A) through (H) of this section.

(A) Individual HAP partial pressures in multicomponent systems shall be determined in accordance with the methods specified in paragraphs (c)(2)(i)(A)(1) through (3) of this section. Chemical property data may be obtained from standard references.

(1) If the components are miscible in one another, use Raoult's law to calculate the partial pressures;

(2) If the solution is a dilute aqueous mixture, use Henry's law constants to calculate partial pressures;

(3) If Raoult's law or Henry's law are not appropriate or available, use any of the methods specified in paragraphs (c)(2)(i)(A)(3)(i) through (iii) of this section.

(i) Use experimentally obtained activity coefficients;

(ii) Use models such as the group-contribution models to predict activity coefficients;

(iii) Assume the components of the system behave independently and use the summation of all vapor pressures from the HAP as the total HAP partial pressure;

(B) *Charging or filling.* Emissions from vapor displacement due to transfer of material to a vessel shall be calculated using Equation 9 of this subpart:

$$E = \frac{(V)}{(R)(T)} \times \sum_{i=1}^n (P_i)(MW_i) \quad (\text{Eq. 9})$$

[View or download PDF](#)

Where:

E = mass of HAP emitted

P_i = partial pressure of the individual HAP

V = volume of gas displaced from the vessel

R = ideal gas law constant

T = temperature of the vessel vapor space; absolute

MW_i = molecular weight of the individual HAP

(C) *Purging.* Emissions from purging shall be calculated using Equation 10 of this subpart, except that for purge flow rates greater than 100 scfm, the mole fraction of HAP will be assumed to be 25 percent of the saturated value.

$$E = \sum_{i=1}^n P_i MW_i \times \left(\frac{(V)(t)}{(R)(T)} \right) \times \frac{P_T}{P_T - \sum_{j=1}^m (P_j)} \quad (\text{Eq. 10})$$

[View or download PDF](#)

Where:

E = mass of HAP emitted

V = purge flow rate at the temperature and pressure of the vessel vapor space

R = ideal gas law constant

T = temperature of the vessel vapor space; absolute

P_i = partial pressure of the individual HAP

P_j = partial pressure of individual condensable compounds (including HAP)

P_T = pressure of the vessel vapor space

MW_i = molecular weight of the individual HAP

t = time of purge

n = number of HAP compounds in the emission stream

m = number of condensable compounds (including HAP) in the emission stream.

(D) *Heating*. Emissions caused by heating the contents of a vessel to a temperature less than the boiling point shall be calculated using the procedures in either paragraph (c)(2)(i)(D)(1), (2), or (4) of this section, as appropriate. If the contents of a vessel are heated to the boiling point, emissions while boiling are assumed to be zero if the owner or operator is complying with the provisions in paragraph (d)(2)(i)(C)(3) of this section.

(1) If the final temperature to which the vessel contents are heated is lower than 50 K below the boiling point of the HAP in the vessel, then emissions shall be calculated using Equations 11 through 14 of this subpart.

(i) The mass of HAP emitted per episode shall be calculated using Equation 11 of this subpart:

$$E = \frac{\sum_{i=1}^n (P_i)_{T1}}{Pa_1} + \frac{\sum_{i=1}^n (P_i)_{T2}}{Pa_2} \times \Delta n \times MW_{HAP} \quad (Eq. 11)$$

[View or download PDF](#)

Where:

E = mass of HAP vapor displaced from the vessel being heated

(P_i)_{Tn} = partial pressure of each HAP in the vessel headspace at initial (n = 1) and final (n = 2) temperatures

Pa₁ = initial noncondensable gas pressure in the vessel, as calculated using Equation 13 of this subpart

Pa₂ = final noncondensable gas pressure in the vessel, as calculated using Equation 13 of this subpart

Δn = number of moles of noncondensable gas displaced, as calculated using Equation 12 of this subpart

MW_{HAP} = The average molecular weight of HAP present in the vessel, as calculated using Equation 14 of this subpart:

n = number of HAP compounds in the displaced vapor

(ii) The moles of noncondensable gas displaced shall be calculated using Equation 12 of this subpart:

$$\Delta n = \frac{V}{R} \left[\left(\frac{Pa_1}{T_1} \right) - \left(\frac{Pa_2}{T_2} \right) \right] \quad (\text{Eq. 12})$$

[View or download PDF](#)

Where:

Δn = number of moles of noncondensable gas displaced

V = volume of free space in the vessel

R = ideal gas law constant

Pa_1 = initial noncondensable gas pressure in the vessel, as calculated using Equation 13 of this subpart

Pa_2 = final noncondensable gas pressure in the vessel, as calculated using Equation 13 of this subpart

T_1 = initial temperature of vessel contents, absolute

T_2 = final temperature of vessel contents, absolute

(iii) The initial and final pressure of the noncondensable gas in the vessel shall be calculated according to Equation 13 of this subpart:

$$Pa_n = Pa_{atm} - \sum_{j=1}^m (P_j)_{T_n} \quad (\text{Eq. 13})$$

[View or download PDF](#)

Where:

Pa_n = partial pressure of noncondensable gas in the vessel headspace at initial (n = 1) and final (n = 2) temperatures

P_{atm} = atmospheric pressure

$(P_j)_{T_n}$ = partial pressure of each condensable volatile organic compound (including HAP) in the vessel headspace at the initial temperature (n = 1) and final (n = 2) temperature

(iv) The average molecular weight of HAP in the displaced gas shall be calculated using Equation 14 of this subpart:

$$MW_{HAP} = \frac{\sum_{i=1}^n ((P_i)_{T_1} + (P_i)_{T_2}) MW_i}{\sum_{i=1}^n ((P_i)_{T_1} + (P_i)_{T_2})} \quad (\text{Eq. 14})$$

[View or download PDF](#)

Where:

MW_{HAP} = average molecular weight of HAP in the displaced gas

$(P_i)_{T_n}$ = partial pressure of each HAP in the vessel headspace at the initial (T_1) and final (T_2) temperatures

MW_i = molecular weight of each HAP

n = number of HAP compounds in the emission stream

(2) If the vessel contents are heated to a temperature greater than 50 K below the boiling point, then emissions from the heating of a vessel shall be calculated as the sum of the emissions calculated in accordance with paragraphs (c)(2)(i)(D)(2)(i) and (ii) of this section.

(i) For the interval from the initial temperature to the temperature 50 K below the boiling point, emissions shall be calculated using Equation 11 of this subpart, where T_2 is the temperature 50 K below the boiling point.

(ii) For the interval from the temperature 50 K below the boiling point to the final temperature, emissions shall be calculated as the summation of emissions for each 5 K increment, where the emission for each increment shall be calculated using Equation 11 of this subpart. If the final temperature of the heatup is lower than 5 K below the boiling point, the final temperature for the last increment shall be the final temperature of the heatup, even if the last increment is less than 5 K. If the final temperature of the heatup is higher than 5 K below the boiling point, the final temperature for the last increment shall be the temperature 5 K below the boiling point, even if the last increment is less than 5 K.

(3) While boiling, the vessel must be operated with a properly operated process condenser. An initial demonstration that a process condenser is properly operated is required for vessels that operate process condensers without secondary condensers that are air pollution control devices. The owner or operator must either measure the condenser exhaust gas temperature and show it is less than the boiling point of the substance(s) in the vessel, or perform a material balance around the vessel and condenser to show that at least 99 percent of the material vaporized while boiling is condensed. Uncontrolled emissions are assumed to be zero under these conditions. The initial demonstration shall be conducted for all appropriate operating scenarios and documented in the Notification of Compliance Status report as specified in §63.1368(f).

(4)(i) As an alternative to the procedures described in paragraphs (c)(2)(i)(D)(1) and (2) of this section, emissions caused by heating a vessel to any temperature less than the boiling point may be calculated using Equation 15 of this subpart.

$$E = MW_{HAP} \times \left(N_{avg} \times \ln \left(\frac{P_T - \sum_{i=1}^m (P_{i,1})}{P_T - \sum_{i=1}^m (P_{i,2})} \right) - (n_{HAP,2} - n_{HAP,1}) \right) \quad (Eq. 15)$$

[View or download PDF](#)

Where:

E = mass of HAP vapor displaced from the vessel being heated

N_{avg} = average gas space molar volume during the heating process, as calculated using Equation 16 of this subpart

P_T = total pressure in the vessel

$P_{i,1}$ = partial pressure of the individual HAP compounds at T_1

$P_{i,2}$ = partial pressure of the individual HAP compounds at T_2

MW_{HAP} = average molecular weight of the HAP compounds, as calculated using Equation 14 of this subpart

$n_{HAP,1}$ = number of moles of total HAP in the vessel headspace at T_1

$n_{HAP,2}$ = number of moles of total HAP in the vessel headspace at T_2

m = number of HAP compounds in the emission stream.

(ii) The average gas space molar volume during the heating process is calculated using Equation 16 of this subpart.

$$N_{avg} = \frac{VP_T}{2R} \left(\frac{1}{T_1} + \frac{1}{T_2} \right) \quad (\text{Eq. 16})$$

[View or download PDF](#)

Where:

N_{avg} = average gas space molar volume during the heating process

V = volume of free space in vessel

P_T = total pressure in the vessel

R = ideal gas law constant

T_1 = initial temperature of the vessel contents, absolute

T_2 = final temperature of the vessel contents, absolute

(iii) The difference in the number of moles of total HAP in the vessel headspace between the initial and final temperatures is calculated using Equation 17 of this subpart.

$$(n_{HAP,2} - n_{HAP,1}) = \frac{V}{(R)(T_2)} \sum_{i=1}^m P_{i,2} - \frac{V}{(R)(T_1)} \sum_{i=1}^m P_{i,1} \quad (\text{Eq. 17})$$

[View or download PDF](#)

Where:

$n_{HAP,2}$ = number of moles of total HAP in the vessel headspace at T_2

$n_{HAP,1}$ = number of moles of total HAP in the vessel headspace at T_1

V = volume of free space in vessel

R = ideal gas law constant

T_1 = initial temperature of the vessel contents, absolute

T_2 = final temperature of the vessel contents, absolute

$P_{i,1}$ = partial pressure of the individual HAP compounds at T_1

$P_{i,2}$ = partial pressure of the individual HAP compounds at T_2

n = number of HAP compounds in the emission stream.

(E) *Depressurization*. Emissions from depressurization shall be calculated using the procedures in paragraphs (c)(2)(i)(E)(1) through (5) of this section. Alternatively, the owner or operator may elect to calculate emissions from depressurization using the procedures in paragraph (c)(2)(i)(E)(6) of this section.

(1) The moles of HAP vapor initially in the vessel are calculated using Equation 18 of this subpart:

$$n_{HAP} = \frac{V}{RT} \times \sum_{i=1}^n (P_i) \quad (\text{Eq. 18})$$

[View or download PDF](#)

Where:

n_{HAP} = moles of HAP vapor in the vessel

P_i = partial pressure of each HAP in the vessel vapor space

V = free volume in the vessel being depressurized

R = ideal gas law constant

T = absolute temperature in vessel

n = number of HAP compounds in the emission stream

(2) The initial and final moles of noncondensable gas present in the vessel are calculated using Equations 19 and 20 of this subpart:

$$n_1 = \frac{VP_{nc1}}{RT} \quad (\text{Eq. 19})$$

[View or download PDF](#)

$$n_2 = \frac{VP_{nc2}}{RT} \quad (\text{Eq. 20})$$

[View or download PDF](#)

Where:

n_1 = initial number of moles of noncondensable gas in the vessel

n_2 = final number of moles of noncondensable gas in the vessel

V = free volume in the vessel being depressurized

P_{nc1} = initial partial pressure of the noncondensable gas, as calculated using Equation 21 of this subpart

P_{nc2} = final partial pressure of the noncondensable gas, as calculated using Equation 22 of this subpart

R = ideal gas law constant

T = temperature, absolute

(3) The initial and final partial pressures of the noncondensable gas in the vessel are determined using Equations 21 and 22 of this subpart.

$$P_{nc1} = P_1 - \sum_{j=1}^m (P_j^*) (x_j) \quad (Eq. 21)$$

[View or download PDF](#)

$$P_{nc2} = P_2 - \sum_{j=1}^m (P_j^*) (x_j) \quad (Eq. 22)$$

[View or download PDF](#)

Where:

P_{nc1} = initial partial pressure of the noncondensable gas

P_{nc2} = final partial pressure of the noncondensable gas

P_1 = initial vessel pressure

P_2 = final vessel pressure

P_j^* = vapor pressure of each condensable compound (including HAP) in the emission stream

x_j = mole fraction of each condensable compound (including HAP) in the liquid phase

m = number of condensable compounds (including HAP) in the emission stream.

(4) The moles of HAP emitted during the depressurization are calculated by taking an approximation of the average ratio of moles of HAP to moles of noncondensable and multiplying by the total moles of noncondensables released during the depressurization, using Equation 23 of this subpart:

$$n_{HAP,e} = \left[\frac{\frac{n_{HAP,1}}{n_1} + \frac{n_{HAP,2}}{n_2}}{2} \right] [n_1 - n_2] \quad (Eq. 23)$$

[View or download PDF](#)

Where:

$n_{HAP,e}$ = moles of HAP emitted

$n_{HAP,1}$ = moles of HAP vapor in vessel at the initial pressure, as calculated using Equation 18 of this subpart

$n_{HAP,2}$ = moles of HAP vapor in vessel at the final pressure, as calculated using Equation 18 of this subpart

n_1 = initial number of moles of noncondensable gas in the vessel, as calculated using Equation 19 of this subpart

n_2 = final number of moles of noncondensable gas in the vessel, as calculated using Equation 19 of this subpart.

(5) Use Equation 24 of this subpart to calculate the mass of HAP emitted:

$$E = n_{HAP,e} * MW_{HAP} \quad (\text{Eq. 24})$$

[View or download PDF](#)

Where:

E = mass of HAP emitted

$n_{HAP,e}$ = moles of HAP emitted, as calculated using Equation 23 of this subpart

MW_{HAP} = average molecular weight of the HAP as calculated using Equation 14 of this subpart

(6) As an alternative to the procedures in paragraphs (c)(2)(i)(E)(1) through (5) of this section, emissions from depressurization may be calculated using Equation 25 of this subpart:

$$E = \frac{V}{(R)(T)} \times \ln \left(\frac{P_1 - \sum_{j=1}^m (P_j)}{P_2 - \sum_{j=1}^m (P_j)} \right) \times \sum_{i=1}^n (P_i) (MW_i) \quad (\text{Eq. 25})$$

[View or download PDF](#)

Where:

V = free volume in vessel being depressurized

R = ideal gas law constant

T = temperature of the vessel, absolute

P_1 = initial pressure in the vessel

P_2 = final pressure in the vessel

P_i = partial pressure of the individual HAP compounds

P_j = partial pressure of individual condensable VOC compounds (including HAP)

MW_i = molecular weight of the individual HAP compounds

n = number of HAP compounds in the emission stream

m = number of condensable VOC compounds (including HAP) in the emission stream

(F) *Vacuum systems*. Calculate emissions from vacuum systems using Equation 26 of this subpart:

$$E = \frac{(MW_{HAP})(La)(t)}{MW_{nc}} \left(\frac{\sum_{i=1}^n P_i}{P_T - \sum_{j=1}^m P_j} \right) \quad (Eq. 26)$$

[View or download PDF](#)

Where:

E = mass of HAP emitted

P_T = absolute pressure of receiving vessel or ejector outlet conditions, if there is no receiver

P_i = partial pressure of individual HAP at the receiver temperature or the ejector outlet conditions

P_j = partial pressure of individual condensable compounds (including HAP) at the receiver temperature or the ejector outlet conditions

La = total air leak rate in the system, mass/time

MW_{nc} = molecular weight of noncondensable gas

t = time of vacuum operation

MW_{HAP} = average molecular weight of HAP in the emission stream, as calculated using Equation 14 of this subpart, with HAP partial pressures calculated at the temperature of the receiver or ejector outlet, as appropriate

n = number of HAP components in the emission stream

m = number of condensable compounds (including HAP) in the emission stream.

(G) *Gas evolution*. Emissions from gas evolution shall be calculated using Equation 10 of this subpart with V calculated using Equation 27 of this subpart:

$$V = \frac{(W_g)(R)(T)}{(P_T)(MW_g)} \quad (Eq. 27)$$

[View or download PDF](#)

Where:

V = volumetric flow rate of gas evolution

W_g = mass flow rate of gas evolution

R = ideal gas law constant

T = temperature at the exit, absolute

P_T = vessel pressure

MW_g = molecular weight of the evolved gas

(H) *Air drying*. Use Equation 28 of this subpart to calculate emissions from air drying:

$$E = B \times \left(\frac{PS_1}{100 - PS_1} - \frac{PS_2}{100 - PS_2} \right) \quad (\text{Eq. 28})$$

[View or download PDF](#)

Where:

E = mass of HAP emitted

B = mass of dry solids

PS₁ = HAP in material entering dryer, weight percent

PS₂ = HAP in material exiting dryer, weight percent.

(ii) *Engineering assessments.* The owner or operator shall conduct an engineering assessment to determine uncontrolled HAP emissions for each emission episode that is not due to vapor displacement, purging, heating, depressurization, vacuum systems, gas evolution, or air drying. For a given emission episode caused by any of these seven types of activities, the owner or operator also may request approval to determine uncontrolled HAP emissions based on an engineering assessment. Except as specified in paragraph (c)(2)(ii)(A) of this section, all data, assumptions, and procedures used in the engineering assessment shall be documented in the Precompliance plan in accordance with §63.1367(b). An engineering assessment includes, but is not limited to, the information and procedures described in paragraphs (c)(2)(ii)(A) through (D) of this section.

(A) Test results, provided the tests are representative of current operating practices at the process unit. For process vents without variable emission stream characteristics, an engineering assessment based on the results of a previous test may be submitted in the Notification of Compliance Status report instead of the Precompliance plan. Results from a previous test of process vents with variable emission stream characteristics will be acceptable in place of values estimated using the procedures specified in paragraph (c)(2)(i) of this section if the test data show a greater than 20 percent discrepancy between the test value and the estimated value, and the results of the engineering assessment shall be included in the Notification of Compliance Status report. For other process vents with variable emission stream characteristics, engineering assessments based on the results of a previous test must be submitted in the Precompliance plan. For engineering assessments based on new tests, the owner or operator must comply with the test notification requirements in §63.1368(m), and the results of the engineering assessment may be submitted in the Notification of Compliance Status report rather than the Precompliance plan.

(B) Bench-scale or pilot-scale test data representative of the process under representative operating conditions.

(C) Maximum flow rate, HAP emission rate, concentration, or other relevant parameter specified or implied within a permit limit applicable to the process vent.

(D) Design analysis based on accepted chemical engineering principles, measurable process parameters, or physical or chemical laws or properties. Examples of analytical methods include, but are not limited to:

(1) Use of material balances based on process stoichiometry to estimate maximum organic HAP concentrations;

(2) Estimation of maximum flow rate based on physical equipment design such as pump or blower capacities; and

(3) Estimation of HAP concentrations based on saturation conditions.

(3) *Controlled emissions.* Except for condensers, the owner or operator shall determine controlled emissions using the procedures in either paragraph (c)(3)(i) or (ii) of this section, as applicable. For condensers, controlled emissions shall be calculated using the emission estimation equations described in paragraph (c)(3)(iii) of this section. The owner or operator is not required to calculate controlled emissions from devices described in paragraph (a)(4) of this section or from flares for which compliance is demonstrated in accordance with paragraph (a)(3) of this section. If the owner or operator is complying with an outlet concentration standard and the control device uses supplemental gases, the outlet concentrations shall be corrected in accordance with the procedures described in paragraph (a)(7) of this section.

(i) *Small control devices, except condensers.* Controlled emissions for each process vent that is controlled using a small control device, except for a condenser, shall be determined by using the design evaluation described in paragraph (c)(3)(i)(A) of this section, or by conducting a performance test in accordance with paragraph (c)(3)(ii) of this section.

(A) *Design evaluation.* The design evaluation shall include documentation demonstrating that the control device being used achieves the required control efficiency under absolute or hypothetical peak-case conditions, as determined from the emission profile described in paragraph (b)(11)(iii) of this section. The control efficiency determined from this design evaluation shall be applied to uncontrolled emissions to estimate controlled emissions. The documentation must be conducted in accordance with the provisions in paragraph (a)(1) of this section. The design evaluation shall also include the value(s) and basis for the parameter(s) monitored under §63.1366.

(B) Whenever a small control device becomes a large control device, the owner or operator must comply with the provisions in paragraph (c)(3)(ii) of this section and submit the test report in the next Periodic report.

(ii) *Large control devices, except condensers.* Controlled emissions for each process vent that is controlled using a large control device, except for a condenser, shall be determined by applying the control efficiency of the large control device to the estimated uncontrolled emissions. The control efficiency shall be determined by conducting a performance test on the control device as described in paragraphs (c)(3)(ii)(A) through (C) of this section, or by using the results of a previous performance test as described in paragraph (c)(3)(ii)(D) of this section. If the control device is intended to control only HCl and chlorine, the owner or operator may assume the control efficiency of organic HAP is 0 percent. If the control device is intended to control only organic HAP, the owner or operator may assume the control efficiency for HCl and chlorine is 0 percent.

(A) Performance test measurements shall be conducted at both the inlet and outlet of the control device for TOC, total organic HAP, and total HCl and chlorine, as applicable, using the test methods and procedures described in paragraph (b) of this section. Concentrations shall be calculated from the data obtained through emission testing according to the procedures in paragraph (a)(2) of this section.

(B) Performance testing shall be conducted under absolute or hypothetical peak-case conditions, as defined in paragraphs (b)(11)(i) and (ii) of this section.

(C) The owner or operator may elect to conduct more than one performance test on the control device for the purpose of establishing more than one operating condition at which the control device achieves the required control efficiency.

(D) The owner or operator is not required to conduct a performance test for any control device for which a previous performance test was conducted, provided the test was conducted using the same procedures specified in paragraphs (b)(1) through (11) of this section over conditions typical of the absolute or hypothetical peak-case, as defined in paragraphs (b)(11)(i) and (ii) of this section. The results of the previous performance test shall be used to demonstrate compliance.

(iii) *Condensers*. The owner or operator using a condenser as a control device shall determine controlled emissions for each batch emission episode according to the engineering methodology in paragraphs (c)(3)(iii)(A) through (G) of this section. The owner or operator must establish the maximum outlet gas temperature and calculate the controlled emissions using this temperature in the applicable equation. Individual HAP partial pressures shall be calculated as specified in paragraph (c)(2)(i) of this section.

(A) Emissions from vapor displacement due to transfer of material to a vessel shall be calculated using Equation 9 of this subpart with T set equal to the temperature of the receiver and the HAP partial pressures determined at the temperature of the receiver.

(B) Emissions from purging shall be calculated using Equation 10 of this subpart with T set equal to the temperature of the receiver and the HAP partial pressures determined at the temperature of the receiver.

(C) Emissions from heating shall be calculated using Equation 29 of this subpart. In Equation 29 of this subpart, $\Delta\eta$ is equal to the number of moles of noncondensable displaced from the vessel, as calculated using Equation 12 of this subpart. In Equation 29 of this subpart, the HAP average molecular weight shall be calculated using Equation 14 with the HAP partial pressures determined at the temperature of the receiver.

$$E = \Delta\eta \times \frac{\sum_{i=1}^n P_i}{P_T - \sum_{j=1}^m P_j} \times MW_{HAP} \quad (\text{Eq. 29})$$

[View or download PDF](#)

Where:

E = mass of HAP emitted

$\Delta\eta$ = moles of noncondensable gas displaced

P_T = pressure in the receiver

P_i = partial pressure of the individual HAP at the receiver temperature

P_j = partial pressure of the individual condensable VOC (including HAP) at the receiver temperature

n = number of HAP compounds in the emission stream

MW_{HAP} = the average molecular weight of HAP in vapor exiting the receiver, as calculated using Equation 14 of this subpart

m = number of condensable VOC (including HAP) in the emission stream

(D)(1) Emissions from depressurization shall be calculated using Equation 30 of this subpart.

$$E = (V_{nc1} - V_{nc2}) \times \frac{\sum_{i=1}^n (P_i)}{P_T - \sum_{j=1}^m (P_j)} \times \frac{P_T}{RT} \times MW_{HAP} \quad (\text{Eq. 30})$$

[View or download PDF](#)

Where:

E = mass of HAP vapor emitted

V_{nc1} = initial volume of noncondensable in the vessel, corrected to the final pressure, as calculated using Equation 31 of this subpart

V_{nc2} = final volume of noncondensable in the vessel, as calculated using Equation 32 of this subpart

P_i = partial pressure of each individual HAP at the receiver temperature

P_j = partial pressure of each condensable VOC (including HAP) at the receiver temperature

P_T = receiver pressure

T = temperature of the receiver, absolute

R = ideal gas law constant

MW_{HAP} = the average molecular weight of HAP calculated using Equation 14 of this subpart with partial pressures determined at the receiver temperature

n = number of HAP compounds in the emission stream

m = number of condensable VOC (including HAP) in the emission stream

(2) The initial and final volumes of noncondensable gas present in the vessel, adjusted to the pressure of the receiver, are calculated using Equations 31 and 32 of this subpart.

$$V_{nc1} = \frac{VP_{nc1}}{P_T} \quad (\text{Eq. 31})$$

[View or download PDF](#)

$$V_{nc2} = \frac{VP_{nc2}}{P_T} \quad (\text{Eq. 32})$$

[View or download PDF](#)

Where:

V_{nc1} = initial volume of noncondensable gas in the vessel

V_{nc2} = final volume of noncondensable gas in the vessel

V = free volume in the vessel being depressurized

P_{nc1} = initial partial pressure of the noncondensable gas, as calculated using Equation 33 of this subpart

P_{nc2} = final partial pressure of the noncondensable gas, as calculated using Equation 34 of this subpart

P_r = pressure of the receiver

(3) Initial and final partial pressures of the noncondensable gas in the vessel are determined using Equations 33 and 34 of this subpart.

$$P_{nc1} = P_1 - \sum_{j=1}^m P_j \quad (\text{Eq. 33})$$

[View or download PDF](#)

$$P_{nc2} = P_2 - \sum_{j=1}^m P_j \quad (\text{Eq. 34})$$

[View or download PDF](#)

Where:

P_{nc1} = initial partial pressure of the noncondensable gas in the vessel

P_{nc2} = final partial pressure of the noncondensable gas in the vessel

P_1 = initial vessel pressure

P_2 = final vessel pressure

P_j = partial pressure of each condensable VOC (including HAP) in the vessel

m = number of condensable VOC (including HAP) in the emission stream

(E) Emissions from vacuum systems shall be calculated using Equation 26 of this subpart.

(F) Emissions from gas evolution shall be calculated using Equation 8 with V calculated using Equation 27 of this subpart, T set equal to the receiver temperature, and the HAP partial pressures determined at the receiver temperature. The term for time, t , in Equation 10 of this subpart is not needed for the purposes of this calculation.

(G) Emissions from air drying shall be calculated using Equation 9 of this subpart with V equal to the air flow rate and P_i determined at the receiver temperature.

(d) *Initial compliance with storage vessel provisions.* The owner or operator of an existing or new affected source shall demonstrate initial compliance with the storage vessel standards in §63.1362(c)(2) through (4) by fulfilling the requirements in either paragraph (d)(1), (2), (3), (4), (5), or (6) of this section, as applicable. The owner or operator shall demonstrate initial compliance with the planned routine maintenance provision in §63.1362(c)(5) by fulfilling the requirements in paragraph (d)(7) of this section.

(1) *Percent reduction requirement for control devices.* If the owner or operator equips a Group 1 storage vessel with a closed vent system and control device, the owner or operator shall demonstrate initial compliance with the percent reduction requirement of §63.1362(c)(2)(iv)(A) or (c)(3) either by calculating the efficiency of the control device using performance test data as specified in paragraph

(d)(1)(i) of this section, or by preparing a design evaluation as specified in paragraph (d)(1)(ii) of this section.

(i) *Performance test option.* If the owner or operator elects to demonstrate initial compliance based on performance test data, the efficiency of the control device shall be calculated as specified in paragraphs (d)(1)(i)(A) through (D) of this section.

(A) At the reasonably expected maximum filling rate, Equations 35 and 36 of this subpart shall be used to calculate the mass rate of total organic HAP or TOC at the inlet and outlet of the control device.

$$E_i = K_2 \left(\sum_{j=1}^n C_{ij} M_{ij} \right) Q_i \quad (\text{Eq. 35})$$

[View or download PDF](#)

$$E_o = K_2 \left(\sum_{j=1}^n C_{oj} M_{oj} \right) Q_o \quad (\text{Eq. 36})$$

[View or download PDF](#)

Where:

C_i, C_o = concentration of sample component j of the gas stream at the inlet and outlet of the control device, respectively, dry basis, ppmv

E_i, E_o = mass rate of total organic HAP or TOC at the inlet and outlet of the control device, respectively, dry basis, kg/hr

M_i, M_o = molecular weight of sample component j of the gas stream at the inlet and outlet of the control device, respectively, g/gmole

Q_i, Q_o = flow rate of gas stream at the inlet and outlet of the control device, respectively, dscmm

K_2 = constant, 2.494×10^{-6} (parts per million)⁻¹ (gram-mole per standard cubic meter) (kilogram/gram) (minute/hour), where standard temperature is 20 °C.

(B) The percent reduction in total organic HAP or TOC shall be calculated using Equation 37 of this subpart:

$$R = \frac{E_i - E_o}{E_i} (100) \quad (\text{Eq. 37})$$

[View or download PDF](#)

Where:

R = control efficiency of control device, percent

E_i = mass rate of total organic HAP or TOC at the inlet to the control device as calculated under paragraph (d)(1)(i)(A) of this section, kilograms organic HAP per hour

E_o = mass rate of total organic HAP or TOC at the outlet of the control device, as calculated under paragraph (d)(1)(i)(A) of this section, kilograms organic HAP per hour.

(C) A performance test is not required to be conducted if the control device used to comply with §63.1362(c) (storage tank provisions) is also used to comply with §63.1362(b) (process vent provisions), provided compliance with §63.1362(b) is demonstrated in accordance with paragraph (c) of this section and the demonstrated percent reduction is equal to or greater than 95 percent.

(D) A performance test is not required for any control device for which a previous test was conducted, provided the test was conducted using the same procedures specified in paragraph (b) of this section.

(ii) *Design evaluation option.* If the owner or operator elects to demonstrate initial compliance by conducting a design evaluation, the owner or operator shall prepare documentation in accordance with the design evaluation provisions in paragraph (a)(1) of this section, as applicable. The design evaluation shall demonstrate that the control device being used achieves the required control efficiency when the storage vessel is filled at the reasonably expected maximum filling rate.

(2) *Outlet concentration requirement for control devices.* If the owner or operator equips a Group 1 storage vessel with a closed vent system and control device, the owner or operator shall demonstrate initial compliance with the outlet concentration requirements of §63.1362(c)(2)(iv)(B) or (c)(3) by fulfilling the requirements of paragraph (a)(6) of this section.

(3) *Floating roof.* If the owner or operator equips a Group 1 storage vessel with a floating roof to comply with the provisions in §63.1362(c)(2) or (c)(3), the owner or operator shall demonstrate initial compliance by complying with the procedures described in paragraphs (d)(3)(i) and (ii) of this section.

(i) Comply with §63.119(b), (c), or (d) of subpart G of this part, as applicable, with the differences specified in §63.1362(d)(2)(i) through (iii).

(ii) Comply with the procedures described in §63.120(a), (b), or (c), as applicable, with the differences specified in paragraphs (d)(3)(ii)(A) through (C) of this section.

(A) When the term “storage vessel” is used in §63.120, the definition of the term “storage vessel” in §63.1361 shall apply for the purposes of this subpart.

(B) When the phrase “the compliance date specified in §63.100 of subpart F of this part” is referred to in §63.120, the phrase “the compliance date specified in §63.1364” shall apply for the purposes of this subpart.

(C) When the phrase “the maximum true vapor pressure of the total organic HAP in the stored liquid falls below the values defining Group 1 storage vessels specified in Table 5 or Table 6 of this subpart” is referred to in §63.120(b)(1)(iv), the phrase “the maximum true vapor pressure of the total organic HAP in the stored liquid falls below the values defining Group 1 storage vessels specified in §63.1361” shall apply for the purposes of this subpart.

(4) *Flares.* If the owner or operator controls the emissions from a Group 1 storage vessel with a flare, initial compliance is demonstrated by fulfilling the requirements in paragraph (a)(3) of this section.

(5) *Exemptions from initial compliance.* No initial compliance demonstration is required for control devices specified in paragraph (a)(4) of this section.

(6) *Initial compliance with alternative standard.* If the owner or operator equips a Group 1 storage vessel with a closed-vent system and control device, the owner or operator shall demonstrate initial compliance with the alternative standard in §63.1362(c)(4) by fulfilling the requirements of paragraph (a)(5) of this section.

(7) *Planned routine maintenance.* The owner or operator shall demonstrate initial compliance with the planned routine maintenance provisions of §63.1362(c)(5) by including the anticipated periods of planned routine maintenance for the first reporting period in the Notification of Compliance Status report as specified in §63.1368(f).

(e) *Initial compliance with wastewater provisions.* The owner or operator shall demonstrate initial compliance with the wastewater requirements by complying with the applicable provisions in §63.145, except that the owner or operator need not comply with the requirement to determine visible emissions that is specified in §63.145(j)(1), and references to compounds in Table 8 of subpart G of this part are not applicable for the purposes of this subpart. When §63.145(i) refers to Method 18 of 40 CFR part 60, appendix A-6, the owner or operator may use any method specified in §63.1362(d)(12) to demonstrate initial compliance with this subpart.

(f) *Initial compliance with the bag dump and product dryer provisions.* Compliance with the particulate matter concentration limits specified in §63.1362(e) is demonstrated when the concentration of particulate matter is less than 0.01 gr/dscf, as measured using the method described in paragraph (b)(7) of this section.

(g) *Initial compliance with the pollution prevention alternative standard.* The owner or operator shall demonstrate initial compliance with §63.1362(g)(2) and (3) for a PAI process unit by preparing the demonstration summary in accordance with paragraph (g)(1) of this section and by calculating baseline and target annual HAP and VOC factors in accordance with paragraphs (g)(2) and (3) of this section. To demonstrate initial compliance with §63.1362(g)(3), the owner or operator must also comply with the procedures for add-on control devices that are specified in paragraph (g)(4) of this section.

(1) *Demonstration summary.* The owner or operator shall prepare a pollution prevention demonstration summary that shall contain, at a minimum, the information in paragraphs (g)(1)(i) through (iii) of this section. The demonstration summary shall be included in the Precompliance report as specified in §63.1368(e)(4).

(i) Descriptions of the methodologies and forms used to measure and record consumption of HAP and VOC compounds.

(ii) Descriptions of the methodologies and forms used to measure and record production of the product(s).

(iii) Supporting documentation for the descriptions provided in accordance with paragraphs (g)(1)(i) and (ii) of this section including, but not limited to, operator log sheets and copies of daily, monthly, and annual inventories of materials and products. The owner or operator must show how this documentation will be used to calculate the annual factors required in §63.1366(f)(1).

(2) *Baseline factors.* The baseline HAP and VOC factors shall be calculated by dividing the consumption of total HAP and total VOC by the production rate, per process, for the first 3-year period in which the process was operational, beginning no earlier than the period consisting of the 1987 through 1989 calendar years. Alternatively, for a process that has been operational for less than 3 years, but more than 1 year, the baseline factors shall be established for the time period from startup of the process until the present.

(3) *Target annual factors.* The owner or operator must calculate target annual factors in accordance with either paragraph (g)(3)(i) or (ii) of this section.

(i) To demonstrate initial compliance with §63.1362(g)(2), the target annual HAP factor must be equal to or less than 15 percent of the baseline HAP factor. For each reduction in a HAP that is also a VOC, the target annual VOC factor must be lower than the baseline VOC factor by an equivalent amount on a mass basis. For each reduction in a HAP that is not a VOC, the target annual factor must be equal to or less than the baseline VOC factor.

(ii) To demonstrate initial compliance with §63.1362(g)(3)(i), the target annual HAP and VOC factors must be calculated as specified in paragraph (g)(3)(i) of this section, except that when “15 percent” is referred to in paragraph (g)(3)(i) of this section, “50 percent” shall apply for the purposes of this paragraph.

(4) *Requirements for add-on control devices.* Initial compliance with the requirements for add-on control devices in §63.1362(g)(3)(ii) is demonstrated when the requirements in paragraphs (g)(4)(i) through (iii) of this section are met.

(i) The yearly reductions associated with add-on controls that meet the criteria of §63.1362(g)(3)(ii)(A) through (D), must be equal to or greater than the amounts calculated using Equations 38 and 39 of this subpart:

$$HAP_{reduced} = (HF_{base})(0.85 - R_{p2})(M_{prod}) \quad (Eq. 38)$$

[View or download PDF](#)

$$VOC_{reduced} = (VF_{base} - VF_{p2} - VF_{annual}) \times M_{prod} \quad (Eq. 39)$$

[View or download PDF](#)

Where:

$HAP_{reduced}$ = the annual HAP emissions reduction required by add-on controls, kg/yr

HF_{base} = the baseline HAP factor, kg HAP consumed/kg product

R_{p2} = the fractional reduction in the annual HAP factor achieved using pollution prevention where R_{p2} is ≥ 0.5

$VOC_{reduced}$ = required VOC emission reduction from add-on controls, kg/yr

VF_{base} = baseline VOC factor, kg VOC emitted/kg production

VF_{p2} = reduction in VOC factor achieved by pollution prevention, kg VOC emitted/kg production

VF_{annual} = target annual VOC factor, kg VOC emitted/kg production

M_{prod} = production rate, kg/yr

(ii) Demonstration that the criteria in §63.1362(g)(3)(ii)(A) through (D) are met shall be accomplished through a description of the control device and of the material streams entering and exiting the control device.

(iii) The annual reduction achieved by the add-on control shall be quantified using the methods described in paragraph (c) of this section.

(h) *Compliance with emissions averaging provisions.* An owner or operator shall demonstrate compliance with the emissions averaging provisions of §63.1362(h) by fulfilling the requirements of paragraphs (h)(1) through (6) of this section.

(1) The owner or operator shall develop and submit for approval an Emissions Averaging Plan containing all the information required in §63.1367(d). The Emissions Averaging Plan shall be submitted no later than 18 months prior to the compliance date of the standard. The Administrator shall determine within 120 calendar days whether the Emissions Averaging Plan submitted by sources using emissions averaging presents sufficient information. The Administrator shall either approve the Emissions Averaging Plan, request changes, or request that the owner or operator submit additional information. Once the Administrator receives sufficient information, the Administrator shall approve, disapprove, or request changes to the plan within 120 days. If the Emissions Averaging Plan is disapproved, the owner or operator must still be in compliance with the standard by the compliance date.

(2) For all points included in an emissions average, the owner or operator shall comply with the procedures that are specified in paragraphs (h)(2)(i) through (v) of this section.

(i) Calculate and record monthly debits for all Group 1 emission points that are controlled to a level less stringent than the standard for those emission points. Equations in paragraph (h)(5) of this section shall be used to calculate debits.

(ii) Calculate and record monthly credits for all Group 1 and Group 2 emission points that are overcontrolled to compensate for the debits. Equations in paragraph (h)(6) of this section shall be used to calculate credits. All process vent, storage vessel, and wastewater emission points except those specified in §63.1362(h)(1) through (6) may be included in the credit calculation.

(iii) Demonstrate that annual credits calculated according to paragraph (h)(6) of this section are greater than or equal to debits calculated according to paragraph (h)(5) of this section for the same annual compliance period. The initial demonstration in the Emissions Averaging Plan or operating permit application that credit-generating emission points will be capable of generating sufficient credits to offset the debit-generating emission points shall be made under representative operating conditions. After the compliance date, actual operating data shall be used for all debit and credit calculations.

(iv) Demonstrate that debits calculated for a quarterly (3-month) period according to paragraph (h)(5) of this section are not more than 1.30 times the credits for the same period calculated according to paragraph (h)(6) of this section. Compliance for the quarter shall be determined based on the ratio of credits and debits from that quarter, with 30 percent more debits than credits allowed on a quarterly basis.

(v) Record and report quarterly and annual credits and debits as required in §§63.1367(d) and 63.1368(d).

(3) [Reserved]

(4) During periods of monitoring excursions, credits and debits shall be adjusted as specified in paragraphs (h)(4)(i) through (iii) of this section.

(i) No credits shall be assigned to the credit-generating emission point.

(ii) Maximum debits shall be assigned to the debit-generating emission point.

(iii) The owner or operator may demonstrate to the Administrator that full or partial credits or debits should be assigned using the procedures in §63.150(l) of subpart G of this part.

(5) Debits are generated by the difference between the actual emissions from a Group 1 emission point that is uncontrolled or controlled to a level less stringent than the applicable standard and the emissions allowed for the Group 1 emission point. Debits shall be calculated in accordance with the procedures specified in paragraphs (h)(5)(i) through (iv) of this section.

(i) Source-wide debits shall be calculated using Equation 40 of this subpart.

Debits and all terms of Equation 40 of this subpart are in units of Mg/month

$$Debits = \sum_{i=1}^n [EPV_{iA} - (0.10)(EPV_{iU})] + \sum_{i=1}^n [ES_{iA} - (0.05)(ES_{iU})] + \sum_{i=1}^n [EWW_{iA} - (EWW_{iC})] \quad (Eq. 40)$$

[View or download PDF](#)

Where:

EPV_{iU} = uncontrolled emissions from process i calculated according to the procedures specified in paragraph (h)(5)(ii) of this section

EPV_{iA} = actual emissions from each Group 1 process i that is uncontrolled or is controlled to a level less stringent than the applicable standard. EPV_{iA} is calculated using the procedures in paragraph (h)(5)(ii) of this section

ES_{iU} = uncontrolled emissions from storage vessel i calculated according to the procedures specified in paragraph (h)(5)(iii) of this section

ES_{iA} = actual emissions from each Group 1 storage vessel i that is uncontrolled or is controlled to a level less stringent than the applicable standard. ES_{iA} is calculated using the procedures in paragraph (h)(5)(iii) of this section

EWW_{iC} = emissions from each Group 1 wastewater stream i if the standard had been applied to the uncontrolled emissions. EWW_{iC} is calculated using the procedures in paragraph (h)(5)(iv) of this section

EWW_{iA} = actual emissions from each Group 1 wastewater stream i that is uncontrolled or is controlled to a level less stringent than the applicable standard. EWW_{iA} is calculated using the procedures in paragraph (h)(5)(iv) of this section

n = the number of emission points being included in the emissions average; the value of n is not necessarily the same for process vents, storage tanks, and wastewater

(ii) Emissions from process vents shall be calculated in accordance with the procedures specified in paragraphs (h)(5)(ii)(A) through (C) of this section.

(A) Except as provided in paragraph (h)(5)(ii)(C) of this section, uncontrolled emissions for process vents shall be calculated using the procedures that are specified in paragraph (c)(2) of this section.

(B) Except as provided in paragraph (h)(5)(ii)(C) of this section, actual emissions for process vents shall be calculated using the procedures specified in paragraphs (c)(2) and (c)(3) of this section, as applicable.

(C) As an alternative to the procedures described in paragraphs (h)(5)(ii)(A) and (B) of this section, for continuous processes, uncontrolled and actual emissions may be calculated by the procedures described in §63.150(g)(2) of subpart G of this part. For purposes of complying with this paragraph, a 90 percent reduction shall apply instead of the 98 percent reduction in §63.150(g)(2)(iii) of subpart G of this part, and the term “process condenser” shall apply instead of the term “recovery device” in §63.150(g)(2) for the purposes of this subpart.

(iii) Uncontrolled emissions from storage vessels shall be calculated in accordance with the procedures described in paragraph (d)(1) of this section. Actual emissions from storage vessels shall be calculated using the procedures specified in §63.150(g)(3)(ii), (iii), or (iv) of subpart G of this subpart, as appropriate, except that when §63.150(g)(3)(ii)(B) refers to the procedures in §63.120(d) for determining percent reduction for a control device, §63.1365(d)(2) or (3) shall apply for the purposes of this subpart.

(iv) Emissions from wastewater shall be calculated using the procedures specified in §63.150(g)(5) of subpart G of this part.

(6) Credits are generated by the difference between emissions that are allowed for each Group 1 and Group 2 emission point and the actual emissions from that Group 1 or Group 2 emission point that have been controlled after November 15, 1990 to a level more stringent than what is required in this subpart or any other State or Federal rule or statute. Credits shall be calculated in accordance with the procedures specified in paragraphs (h)(6)(i) through (v) of this section.

(i) Source-wide credits shall be calculated using Equation 41 of this subpart. Credits and all terms in Equation 41 of this subpart are in units of Mg/month, the baseline date is November 15, 1990, the terms consisting of a constant multiplied by the uncontrolled emissions are the emissions from each emission point subject to the standards in §63.1362(b) and (c) that is controlled to a level more stringent than the standard.

$$\begin{aligned} Credits = & D \sum_{i=1}^n [(0.10)(EPV1_{iU}) - EPV1_{iA}] + D \sum_{i=1}^m (EPV2_{iB} - EPV2_{iA}) + D \sum_{i=1}^n [(0.05)(ES1_{iU}) - ES1_{iA}] + \\ & D \sum_{i=1}^m (ES2_{iB} - ES2_{iA}) + D \sum_{i=1}^n (EWW1_{iC} - EWW1_{iA}) + D \sum_{i=1}^m (EWW2_{iB} - EWW2_{iA}) \quad (Eq. 41) \end{aligned}$$

[View or download PDF](#)

Where:

$EPV1_{iU}$ = uncontrolled emissions from each Group 1 process i calculated according to the procedures in paragraph (h)(6)(iii)(A) of this section

$EPV1_{iA}$ = actual emissions from each Group 1 process i that is controlled to a level more stringent than the applicable standard. $EPV1_{iA}$ is calculated according to the procedures in paragraph (h)(6)(iii)(B) of this section

$EPV2_{iB}$ = emissions from each Group 2 process i at the baseline date. $EPV2_{iB}$ is calculated according to the procedures in paragraph (h)(6)(iii)(C) of this section

$EPV2_{iA}$ = actual emissions from each Group 2 process i that is controlled. $EPV2_{iA}$ is calculated according to the procedures in paragraph (h)(6)(iii)(C) of this section

$ES1_{iU}$ = uncontrolled emissions from each Group 1 storage vessel i calculated according to the procedures in paragraph (h)(6)(iv) of this section

$ES1_{iA}$ = actual emissions from each Group 1 storage vessel i that is controlled to a level more stringent than the applicable standard. $ES1_{iA}$ is calculated according to the procedures in paragraph (h)(6)(iv) of this section

$ES2_{iB}$ = emissions from each Group 2 storage vessel i at the baseline date. $ES2_{iB}$ is calculated according to the procedures in paragraph (h)(6)(iv) of this section

$ES2_{iA}$ = actual emissions from each Group 2 storage vessel i that is controlled. $ES2_{iA}$ is calculated according to the procedures in paragraph (h)(6)(iv) of this section

$EWW1_{iC}$ = emissions from each Group 1 wastewater stream i if the standard had been applied to the uncontrolled emissions. $EWW1_{iC}$ is calculated according to the procedures in paragraph (h)(6)(v) of this section

$EWV1_{iA}$ = emissions from each Group 1 wastewater stream i that is controlled to a level more stringent than the applicable standard. $EWV1_{iA}$ is calculated according to the procedures in paragraph (h)(6)(v) of this section

$EWV2_{iB}$ = emissions from each Group 2 wastewater stream i at the baseline date. $EWV2_{iB}$ is calculated according to the procedures in paragraph (h)(6)(v) of this section

$EWV2_{iA}$ = actual emissions from each Group 2 wastewater stream i that is controlled. $EWV2_{iA}$ is calculated according to the procedures in paragraph (h)(6)(v) of this section

n = number of Group 1 emission points that are included in the emissions average. The value of n is not necessarily the same for process vents, storage tanks, and wastewater

m = number of Group 2 emission points included in the emissions average. The value of m is not necessarily the same for process vents, storage tanks, and wastewater

D = discount factor equal to 0.9 for all credit-generating emission points except those controlled by a pollution prevention measure, which will not be discounted

(ii) For an emission point controlled using a pollution prevention measure, the nominal efficiency for calculating credits shall be as determined as described in §63.150(j) of subpart G of this part.

(iii) Emissions from process vents shall be calculated in accordance with the procedures specified in paragraphs (h)(6)(iii)(A) through (C) of this section.

(A) Uncontrolled emissions from Group 1 process vents shall be calculated according to the procedures in paragraph (h)(5)(ii)(A) or (C) of this section.

(B) Actual emissions from Group 1 process vents with a nominal efficiency greater than the applicable standard or a pollution prevention measure that achieves reductions greater than the applicable standard shall be calculated using Equation 42 of this subpart:

$$EPV1_{iA} = EPV1_{iU} \times \left[1 - \frac{N_{eff}}{100} \right] \quad (Eq. 42)$$

[View or download PDF](#)

Where:

$EPV1_{iA}$ = actual emissions from each Group 1 process i that is controlled to a level more stringent than the applicable standard

$EPV1_{iU}$ = uncontrolled emissions from each Group 1 process i

N_{eff} = nominal efficiency of control device or pollution prevention measure, percent

(C) Baseline and actual emissions from Group 2 process vents shall be calculated according to the procedures in §63.150(h)(2)(iii) and (iv) with the following modifications:

(1) The term “90 percent reduction” shall apply instead of the term “98 percent reduction”; and

(2) When the phrase “paragraph (g)(2)” is referred to in §63.150(h)(2)(iii) and (iv), the provisions in paragraph (h)(5)(ii) of this section shall apply for the purposes of this subpart.

(iv) Uncontrolled emissions from storage vessels shall be calculated according to the procedures described in paragraph (d)(1) of this section. Actual and baseline emissions from storage tanks shall be

calculated according to the procedures specified in §63.150(h)(3) of subpart G of this part, except when §63.150(h)(3) refers to §63.150(g)(3)(i), paragraph (d)(1) of this section shall apply for the purposes of this subpart.

(v) Emissions from wastewater shall be calculated using the procedures in §63.150(h)(5) of subpart G of this part.

[64 FR 33589, June 23, 1999, as amended at 67 FR 59347, Sept. 20, 2002; 79 FR 17374, Mar. 27, 2014]

[↑ Back to Top](#)

§63.1366 Monitoring and inspection requirements.

(a) To provide evidence of continued compliance with the standard, the owner or operator of any existing or new affected source shall install, operate, and maintain monitoring devices as specified in this section. During the initial compliance demonstration, maximum or minimum operating parameter levels, or other design and operating characteristics, as appropriate, shall be established for emission sources that will indicate the source is in compliance. Test data, calculations, or information from the evaluation of the control device design, as applicable, shall be used to establish the operating parameter level or characteristic.

(b) *Monitoring for control devices*—(1) *Parameters to monitor.* Except as specified in paragraph (b)(1)(i) of this section, for each control device, the owner or operator shall install and operate monitoring devices and operate within the established parameter levels to ensure continued compliance with the standard. Monitoring parameters are specified for control scenarios in paragraphs (b)(1)(ii) through (xii) of this section, and are summarized in Table 3 of this subpart.

(i) *Periodic verification.* For control devices that control vent streams containing total HAP emissions less than 0.91 Mg/yr, before control, monitoring shall consist of a periodic verification that the device is operating properly. This verification shall include, but not be limited to, a daily or more frequent demonstration that the unit is working as designed and may include the daily measurements of the parameters described in paragraphs (b)(1)(ii) through (xii) of this section. This demonstration shall be included in the Precompliance plan, to be submitted 6 months prior to the compliance date of the standard.

(ii) *Scrubbers.* For affected sources using liquid scrubbers, the owner or operator shall establish a minimum scrubber liquid flow rate or pressure drop as a site-specific operating parameter which must be measured and recorded at least once every 15 minutes during the period in which the scrubber is controlling HAP from an emission stream as required by the standards in §63.1362. If the scrubber uses a caustic solution to remove acid emissions, the pH of the effluent scrubber liquid shall also be monitored once a day. The minimum scrubber liquid flow rate or pressure drop shall be based on the conditions under which the initial compliance demonstration was conducted. Alternatively, for halogen scrubbers, the owner or operator may comply with the requirements specified in §63.994(c).

(A) The monitoring device used to determine the pressure drop shall be certified by the manufacturer to be accurate to within a gage pressure of ± 10 percent of the maximum pressure drop measured.

(B) The monitoring device used for measurement of scrubber liquid flowrate shall be certified by the manufacturer to be accurate to within ± 10 percent of the design scrubber liquid flowrate.

(C) The monitoring device shall be calibrated annually.

(iii) *Condensers*. For each condenser, the owner or operator shall establish the maximum condenser outlet gas temperature as a site-specific operating parameter which must be measured and recorded at least once every 15 minutes during the period in which the condenser is controlling HAP from an emission stream as required by the standards in §63.1362.

(A) The temperature monitoring device must be accurate to within ± 2 percent of the temperature measured in degrees Celsius or ± 2.5 °C, whichever is greater.

(B) The temperature monitoring device must be calibrated annually.

(iv) *Regenerative carbon adsorbers*. For each regenerative carbon adsorber, the owner or operator shall comply with the provisions in paragraphs (b)(1)(iv)(A) through (F) of this section.

(A) Establish the regeneration cycle characteristics specified in paragraphs (b)(1)(iv)(A) (1) through (4) of this section under absolute or hypothetical peak-case conditions, as defined in §63.1365(b)(11)(i) or (ii).

(1) Minimum regeneration frequency (i.e., operating time since last regeneration);

(2) Minimum temperature to which the bed is heated during regeneration;

(3) Maximum temperature to which the bed is cooled, measured within 15 minutes of completing the cooling phase; and

(4) Minimum regeneration stream flow.

(B) Monitor and record the regeneration cycle characteristics specified in paragraphs (b)(1)(iv)(B) (1) through (4) of this section for each regeneration cycle.

(1) Regeneration frequency (i.e., operating time since end of last regeneration);

(2) Temperature to which the bed is heated during regeneration;

(3) Temperature to which the bed is cooled, measured within 15 minutes of the completion of the cooling phase; and

(4) Regeneration stream flow.

(C) Use a temperature monitoring device that is accurate to within ± 2 percent of the temperature measured in degrees Celsius or ± 2.5 °C, whichever is greater.

(D) Use a regeneration stream flow monitoring device capable of recording the total regeneration stream flow to within ± 10 percent of the established value (i.e., accurate to within ± 10 percent of the reading).

(E) Calibrate the temperature and flow monitoring devices annually.

(F) Conduct an annual check for bed poisoning in accordance with manufacturer's specifications.

(v) *Nonregenerative carbon adsorbers*. For each nonregenerative carbon adsorption system such as a carbon canister that does not regenerate the carbon bed directly onsite in the control device, the owner

or operator shall replace the existing carbon bed in the control device with fresh carbon on a regular schedule based on one of the following procedures:

(A) Monitor the TOC concentration level in the exhaust vent stream from the carbon adsorption system on a regular schedule, and replace the existing carbon with fresh carbon immediately when carbon breakthrough is indicated. The monitoring frequency shall be daily or at an interval no greater than 20 percent of the time required to consume the total carbon working capacity under absolute or hypothetical peak-case conditions as defined in §63.1365(b)(11)(i) or (ii), whichever is longer.

(B) Establish the maximum time interval between replacement, and replace the existing carbon before this time interval elapses. The time interval shall be established based on the conditions anticipated under absolute or hypothetical peak-case, as defined in §63.1365(b)(11)(i) or (ii).

(vi) *Flares*. For each flare, the presence of the pilot flame shall be monitored at least once every 15 minutes during the period in which the flare is controlling HAP from an emission stream subject to the standards in §63.1362. The monitoring device shall be calibrated annually.

(vii) *Thermal incinerators*. For each thermal incinerator, the owner or operator shall monitor the temperature of the gases exiting the combustion chamber as the site-specific operating parameter which must be measured and recorded at least once every 15 minutes during the period in which the combustion device is controlling HAP from an emission stream subject to the standards in §63.1362.

(A) The temperature monitoring device must be accurate to within ± 0.75 percent of the temperature measured in degrees Celsius or ± 2.5 °C, whichever is greater.

(B) The monitoring device must be calibrated annually.

(viii) *Catalytic incinerators*. For each catalytic incinerator, the parameter levels that the owner or operator shall establish are the minimum temperature of the gas stream immediately before the catalyst bed and the minimum temperature difference across the catalyst bed. The owner or operator shall monitor the temperature of the gas stream immediately before and after the catalyst bed, and calculate the temperature difference across the catalyst bed, at least once every 15 minutes during the period in which the catalytic incinerator is controlling HAP from an emission stream subject to the standards in §63.1362.

(A) The temperature monitoring devices must be accurate to within ± 0.75 percent of the temperature measured in degrees Celsius or ± 2.5 °C, whichever is greater.

(B) The temperature monitoring devices must be calibrated annually.

(ix) *Process heaters and boilers*. (A) Except as specified in paragraph (b)(1)(ix)(B) of this section, for each boiler or process heater, the owner or operator shall monitor the temperature of the gases exiting the combustion chamber as the site-specific operating parameter which must be monitored and recorded at least every 15 minutes during the period in which the boiler or process heater is controlling HAP from an emission stream subject to the standards in §63.1362.

(1) The temperature monitoring device must be accurate to within ± 0.75 percent of the temperature measured in degrees Celsius or ± 2.5 °C, whichever is greater.

(2) The temperature monitoring device must be calibrated annually.

(B) The owner or operator is exempt from the monitoring requirements specified in paragraph (b)(1)(ix)(A) of this section if either:

(1) All vent streams are introduced with primary fuel; or

(2) The design heat input capacity of the boiler or process heater is 44 megawatts or greater.

(x) *Continuous emission monitor.* As an alternative to the parameters specified in paragraphs (b)(1)(ii) through (ix) of this section, an owner or operator may monitor and record the outlet HAP concentration or both the outlet TOC concentration and outlet total HCl and chlorine concentration at least every 15 minutes during the period in which the control device is controlling HAP from an emission stream subject to the standards in §63.1362. The owner or operator need not monitor the total HCl and chlorine concentration if the owner or operator determines that the emission stream does not contain HCl or chlorine. The owner or operator need not monitor the TOC concentration if the owner or operator determines the emission stream does not contain organic compounds. The HAP or TOC monitor must meet the requirements of Performance Specification 8 or 9 of appendix B of part 60 and must be installed, calibrated, and maintained, according to §63.8 of subpart A of this part. As part of the QA/QC Plan, calibration of the device must include, at a minimum, quarterly cylinder gas audits. If supplemental gases are introduced before the control device, the monitored concentration shall be corrected as specified in §63.1365(a)(7).

(xi) *Fabric filters.* For each fabric filter used to control particulate matter emissions from bag dumps and product dryers subject to §63.1362(e), the owner or operator shall install, calibrate, maintain, and continuously operate a bag leak detection system that meets the requirements in paragraphs (b)(1)(xi)(A) through (G) of this section.

(A) The bag leak detection system sensor must provide output of relative particulate matter emissions.

(B) The bag leak detection system must be equipped with an alarm system that will sound when an increase in particulate matter emissions over a preset level is detected.

(C) For positive pressure fabric filters, a bag leak detector must be installed in each fabric filter compartment or cell. If a negative pressure or induced air filter is used, the bag leak detector must be installed downstream of the fabric filter. Where multiple bag leak detectors are required (for either type of fabric filter), the system instrumentation and alarm may be shared among detectors.

(D) The bag leak detection system shall be installed, operated, calibrated and maintained in a manner consistent with available guidance from the U.S. Environmental Protection Agency or, in the absence of such guidance, the manufacturer's written specifications and instructions.

(E) Calibration of the system shall, at a minimum, consist of establishing the relative baseline output level by adjusting the range and the averaging period of the device and establishing the alarm set points and the alarm delay time.

(F) Following initial adjustment, the owner or operator shall not adjust the sensitivity or range, averaging period, alarm set points, or alarm delay time, except as established in an operation and maintenance plan that is to be submitted with the Precompliance plan. In no event shall the sensitivity be increased more than 100 percent or decreased by more than 50 percent over a 365-day period unless such adjustment follows a complete baghouse inspection which demonstrates the baghouse is in good operating condition.

(G) If the alarm on a bag leak detection system is triggered, the owner or operator shall, within 1 hour of an alarm, initiate the procedures to identify the cause of the alarm and take corrective action as specified in the corrective action plan.

(xii) For each waste management unit, treatment process, or control device used to comply with §63.1362(d), the owner or operator shall comply with the procedures specified in §63.143 of subpart G of this part, except that when the procedures to request approval to monitor alternative parameters according to the procedures in §63.151(f) are referred to in §63.143(d)(3), the procedures in paragraph (b)(4) of this section shall apply for the purposes of this subpart.

(xiii) *Closed-vent system visual inspections.* The owner or operator shall comply with the requirements in either paragraph (b)(1)(xiii)(A) or (B) of this section:

(A) Set the flow indicator at the entrance to any bypass line that could divert the stream away from the control device to the atmosphere to take a reading at least once every 15 minutes; or

(B) If the bypass device valve installed at the inlet to the bypass device is secured in the closed position with a car-seal or lock-and-key type configuration, visually inspect the seal or closure mechanism at least once every month to verify that the valve is maintained in the closed position and the vent stream is not diverted through the bypass line.

(2) *Averaging periods.* Averaging periods for parametric monitoring levels shall be established according to paragraphs (b)(2)(i) through (iii) of this section.

(i) Except as provided in paragraph (b)(2)(iii) of this section, a daily (24-hour) or block average shall be calculated as the average of all values for a monitored parameter level set according to the procedures in (b)(3)(iii) of this section recorded during the operating day or block.

(ii) The operating day or block shall be defined in the Notification of Compliance Status report. The operating day may be from midnight to midnight or another continuous 24-hour period. The operating block may be used as an averaging period only for vents from batch operations, and is limited to a period of time that is, at a maximum, equal to the time from the beginning to end of a series of consecutive batch operations.

(iii) Monitoring values taken during periods in which the control devices are not controlling HAP from an emission stream subject to the standards in §63.1362, as indicated by periods of no flow or periods when only streams that are not subject to the standards in §63.1362 are controlled, shall not be considered in the averages. Where flow to the device could be intermittent, the owner or operator shall install, calibrate and operate a flow indicator at the inlet or outlet of the control device to identify periods of no flow.

(3) *Procedures for setting parameter levels for control devices used to control emissions from process vents.* (i) *Small control devices.* Except as provided in paragraph (b)(1)(i) of this section, for devices controlling less than 10 tons/yr of HAP for which a performance test is not required, the parametric levels shall be set based on the design evaluation required in §63.1365(c)(3)(i)(A). If a performance test is conducted, the monitoring parameter level shall be established according to the procedures in paragraph (b)(3)(ii) of this section.

(ii) *Large control devices.* For devices controlling greater than or equal to 10 tons/yr of HAP for which a performance test is required, the parameter level must be established as follows:

(A) If the operating parameter level to be established is a maximum or minimum, it must be based on the average of the average values from each of the three test runs.

(B) The owner or operator may establish the parametric monitoring level(s) based on the performance test supplemented by engineering assessments and/or manufacturer's recommendations. Performance testing is not required to be conducted over the entire range of expected parameter values.

The rationale for the specific level for each parameter, including any data and calculations used to develop the level(s) and a description of why the level indicates proper operation of the control device shall be provided in the Precompliance plan. Determination of the parametric monitoring level using these procedures is subject to review and approval by the Administrator.

(iii) *Parameter levels for control devices controlling batch process vents.* For devices controlling batch process vents alone or in combination with other streams, the level(s) shall be established in accordance with paragraph (b)(3)(iii)(A) or (B) of this section.

(A) A single level for the batch process(es) shall be calculated from the initial compliance demonstration.

(B) The owner or operator may establish separate levels for each batch emission episode or combination of emission episodes selected to be controlled. If separate monitoring levels are established, the owner or operator must provide a record indicating at what point in the daily schedule or log of processes required to be recorded per the requirements of §63.1367(b)(7), the parameter being monitored changes levels and must record at least one reading of the new parameter level, even if the duration of monitoring for the new parameter level is less than 15 minutes.

(4) *Requesting approval to monitor alternative parameters.* The owner or operator may request approval to monitor parameters other than those required by paragraphs (b)(1)(ii) through (xiii) of this section. The request shall be submitted according to the procedures specified in §63.8(f) of subpart A of this part or in the Precompliance report (as specified in §63.1368(e)).

(5) *Monitoring for the alternative standards.* (i) For control devices that are used to comply with the provisions of §63.1362(b)(6) and (c)(4), the owner or operator shall monitor and record the outlet TOC concentration and the outlet total HCl and chlorine concentration at least once every 15 minutes during the period in which the device is controlling HAP from emission streams subject to the standards in §63.1362. A TOC monitor meeting the requirements of Performance Specification 8 or 9 of appendix B of 40 CFR part 60 shall be installed, calibrated, and maintained, according to §63.8. The owner or operator need not monitor the total HCl and chlorine concentration if the owner or operator determines that the emission stream does not contain HCl or chlorine. The owner or operator need not monitor for TOC concentration if the owner or operator determines that the emission stream does not contain organic compounds.

(ii) If supplemental gases are introduced before the control device, the owner or operator must either correct for supplemental gases as specified in §63.1365(a)(7) or, if using a combustion control device, comply with the requirements of paragraph (b)(5)(ii)(A) of this section. If the owner or operator corrects for supplemental gases as specified in §63.1365(a)(7)(ii) for non-combustion control devices, the flow rates must be evaluated as specified in paragraph (b)(5)(ii)(B) of this section.

(A) *Provisions for combustion devices.* As an alternative to correcting for supplemental gases as specified in §63.1365(a)(7), the owner or operator may monitor residence time and firebox temperature according to the requirements of paragraphs (b)(5)(ii)(A)(1) and (2) of this section. Monitoring of residence time may be accomplished by monitoring flow rate into the combustion chamber.

(1) If complying with the alternative standard instead of achieving a control efficiency of 95 percent or less, the owner or operator must maintain a minimum residence time of 0.5 seconds and a minimum combustion chamber temperature of 760 °C.

(2) If complying with the alternative standard instead of achieving a control efficiency of 98 percent, the owner or operator must maintain a minimum residence time of 0.75 seconds and a minimum combustion chamber temperature of 816 °C.

(B) *Flow rate evaluation for non-combustion devices.* To demonstrate continuous compliance with the requirement to correct for supplemental gases as specified in §63.1365(a)(7)(ii) for non-combustion devices, the owner or operator must evaluate the volumetric flow rate of supplemental gases, V_s , and the volumetric flow rate of all gases, V_a , each time a new operating scenario is implemented based on process knowledge and representative operating data. The procedures used to evaluate the flow rates, and the resulting correction factor used in Equation 8 of this subpart, must be included in the Notification of Compliance Status report and in the next Periodic report submitted after an operating scenario change.

(6) *Exceedances of operating parameters.* An exceedance of an operating parameter is defined as one of the following:

(i) If the parameter level, averaged over the operating day or block, is below a minimum value established during the initial compliance demonstration.

(ii) If the parameter level, averaged over the operating day or block, is above the maximum value established during the initial compliance demonstration.

(iii) A loss of all pilot flames for a flare during an operating day or block. Multiple losses of all pilot flames during an operating day constitutes one exceedance.

(iv) Each operating day or block for which the time interval between replacement of a nonregenerative carbon adsorber exceeds the interval established in paragraph (b)(1)(v) of this section.

(v) Each instance in which procedures to initiate the response to a bag leak detector alarm within 1 hour of the alarm as specified in the corrective action plan.

(7) *Excursions.* Excursions are defined by either of the two cases listed in paragraph (b)(7)(i) or (ii) of this section. An excursion also occurs if the periodic verification for a small control device is not conducted as specified in paragraph (b)(1)(i) of this section.

(i) When the period of control device operation is 4 hours or greater in an operating day or block and monitoring data are insufficient to constitute a valid hour of data, as defined in paragraph (b)(7)(iii) of this section, for at least 75 percent of the operating hours.

(ii) When the period of control device operation is less than 4 hours in an operating day or block and more than 1 of the hours during the period of operation does not constitute a valid hour of data due to insufficient monitoring data.

(iii) Monitoring data are insufficient to constitute a valid hour of data, as used in paragraphs (b)(7)(i) and (ii) of this section, if measured values are unavailable for any of the required 15-minute periods within the hour.

(8) *Violations.* Exceedances of parameters monitored according to the provisions of paragraphs (b)(1)(ii), (b)(1)(iv) through (ix), and (b)(5) of this section, or excursions as defined by paragraphs (b)(7)(i) and (ii) of this section, constitute violations of the operating limit according to paragraphs (b)(8)(i) and (ii) of this section. Exceedances of the temperature limit monitored according to the provisions of paragraph (b)(1)(iii) of this section or exceedances of the outlet concentrations monitored according to the provisions of paragraph (b)(1)(x) of this section constitute violations of the emission limit according to paragraphs (b)(8)(i) and (ii) of this section. Exceedances of the outlet concentrations monitored according to the provisions of paragraph (b)(5) of this section constitute violations of the emission limit according to the provisions of paragraph (b)(8)(iii) of this section.

(i) For episodes occurring more than once per day, exceedances of established parameter limits or excursions will result in no more than one violation per operating day for each monitored item of equipment utilized in the process.

(ii) For control devices used for more than one process in the course of an operating day, exceedances or excursions will result in no more than one violation per operating day, per control device, for each process for which the control device is in service.

(iii) Exceedances of the 20 or 50 ppmv TOC outlet emission limit, averaged over the operating day, will result in no more than one violation per day per control device. Exceedances of the 20 or 50 ppmv HCl and chlorine outlet emission limit, averaged over the operating day, will result in no more than one violation per day per control device.

(c) *Monitoring for uncontrolled emission rates.* The owner or operator shall demonstrate continuous compliance with the emission limit in §63.1362 (b)(2)(i) or (b)(4)(i) by calculating daily a 365-day rolling summation of uncontrolled emissions based on the uncontrolled emissions per emission episode, as calculated using the procedures in §63.1365(c)(2), and records of the number of batches produced. Each day that the summation for a process exceeds 0.15 Mg/yr is considered a violation of the emission limit.

(d) *Monitoring for equipment leaks.* The standard for equipment leaks is based on monitoring. All monitoring requirements for equipment leaks are specified in §63.1363.

(e) *Monitoring for heat exchanger systems.* The standard for heat exchanger systems is based on monitoring. All monitoring requirements for heat exchanger systems are specified in §63.1362(f).

(f) *Monitoring for the pollution prevention alternative standard.* The owner or operator of an affected source that chooses to comply with the requirements of §63.1362(g) (2) or (3) shall calculate annual rolling average values of the HAP and VOC factors in accordance with the procedures specified in paragraph (f)(1) of this section. If complying with §63.1362(g)(3), the owner or operator shall also comply with the monitoring requirements specified in paragraph (b) of this section for the applicable add-on air pollution control device.

(1) *Annual factors.* The annual HAP and VOC factors shall be calculated in accordance with the procedures specified in paragraphs (f)(1) (i) through (iii) of this section.

(i) The consumption of both total HAP and total VOC shall be divided by the production rate, per process, for 12-month periods at the frequency specified in either paragraph (f)(1) (ii) or (iii) of this section, as applicable.

(ii) For continuous processes, the annual factors shall be calculated every 30 days for the 12-month period preceding the 30th day (annual rolling average calculated every 30 days). A process with both batch and continuous operations is considered a continuous process for the purposes of this section.

(iii) For batch processes, the annual factors shall be calculated every 10 batches for the 12-month period preceding the 10th batch (annual rolling average calculated every 10 batches). Additional annual factors shall be calculated every 12 months during the period before the 10th batch if more than 12 months elapse before the 10th batch is produced.

(2) *Violations.* Each rolling average that exceeds the target value established in §63.1365(g)(3) is considered a violation of the emission limit.

(g) *Monitoring for emissions averaging.* The owner or operator of an affected source that chooses to comply with the requirements of §63.1362(h) shall meet all monitoring requirements specified in

paragraph (b) of this section, as applicable, for all processes, storage tanks, and waste management units included in the emissions average.

(h) *Leak inspection provisions for vapor suppression equipment.* (1) Except as provided in paragraphs (h)(9) and (10) of this section, for each vapor collection system, closed-vent system, fixed roof, cover, or enclosure required to comply with this section, the owner or operator shall comply with the requirements of paragraphs (h)(2) through (8) of this section.

(2) Except as provided in paragraphs (h)(6) and (7) of this section, each vapor collection system and closed-vent system shall be inspected according to the procedures and schedule specified in paragraphs (h)(2)(i) and (ii) of this section and each fixed roof, cover, and enclosure shall be inspected according to the procedures and schedule specified in paragraph (h)(2)(iii) of this section.

(i) If the vapor collection system or closed-vent system is constructed of hard-piping, the owner or operator shall:

- (A) Conduct an initial inspection according to the procedures in paragraph (h)(3) of this section, and
- (B) Conduct annual visual inspections for visible, audible, or olfactory indications of leaks.

(ii) If the vapor collection system or closed-vent system is constructed of ductwork, the owner or operator shall:

- (A) Conduct an initial inspection according to the procedures in paragraph (h)(3) of this section,
- (B) Conduct annual inspections according to the procedures in paragraph (h)(3) of this section, and
- (C) Conduct annual visual inspections for visible, audible, or olfactory indications of leaks.

(iii) For each fixed roof, cover, and enclosure, the owner or operator shall:

- (A) Conduct an initial inspection according to the procedures in paragraph (h)(3) of this section, and
- (B) Conduct semiannual visual inspections for visible, audible, or olfactory indications of leaks.

(3) Each vapor collection system, closed-vent system, fixed roof, cover, and enclosure shall be inspected according to the procedures specified in paragraphs (h)(3)(i) through (vi) of this section.

(i) Inspections shall be conducted in accordance with Method 21 of 40 CFR part 60, appendix A.

(ii) *Detection instrument performance criteria.* (A) Except as provided in paragraph (h)(3)(ii)(B) of this section, the detection instrument shall meet the performance criteria of Method 21 of 40 CFR part 60, appendix A, except the instrument response factor criteria in section 3.1.2(a) of Method 21 shall be for the average composition of the process fluid not each individual VOC in the stream. For process streams that contain nitrogen, air, or other inerts which are not organic HAP or VOC, the average stream response factor shall be calculated on an inert-free basis.

(B) If no instrument is available at the plant site that will meet the performance criteria specified in paragraph (h)(3)(ii)(A) of this section, the instrument readings may be adjusted by multiplying by the average response factor of the process fluid, calculated on an inert-free basis as described in paragraph (h)(3)(ii)(A) of this section.

(iii) The detection instrument shall be calibrated before use on each day of its use by the procedures specified in Method 21 of 40 CFR part 60, appendix A.

(iv) Calibration gases shall be as follows:

(A) Zero air (less than 10 parts per million hydrocarbon in air); and

(B) Mixtures of methane in air at a concentration less than 10,000 parts per million. A calibration gas other than methane in air may be used if the instrument does not respond to methane or if the instrument does not meet the performance criteria specified in paragraph (h)(2)(ii)(A) of this section. In such cases, the calibration gas may be a mixture of one or more of the compounds to be measured in air.

(v) An owner or operator may elect to adjust or not adjust instrument readings for background. If an owner or operator elects to not adjust readings for background, all such instrument readings shall be compared directly to the applicable leak definition to determine whether there is a leak. If an owner or operator elects to adjust instrument readings for background, the owner or operator shall measure background concentration using the procedures in §63.180(b) and (c). The owner or operator shall subtract background reading from the maximum concentration indicated by the instrument.

(vi) The arithmetic difference between the maximum concentration indicated by the instrument and the background level shall be compared with 500 parts per million for determining compliance.

(4) Leaks, as indicated by an instrument reading greater than 500 parts per million above background or by visual inspections, shall be repaired as soon as practicable, except as provided in paragraph (h)(5) of this section.

(i) A first attempt at repair shall be made no later than 5 calendar days after the leak is detected.

(ii) Repair shall be completed no later than 15 calendar days after the leak is detected.

(5) Delay of repair of a vapor collection system, closed-vent system, fixed roof, cover, or enclosure for which leaks have been detected is allowed if the repair is technically infeasible without a shutdown, as defined in §63.1361, or if the owner or operator determines that emissions resulting from immediate repair would be greater than the fugitive emissions likely to result from delay of repair. Repair of such equipment shall be complete by the end of the next shutdown.

(6) Any parts of the vapor collection system, closed-vent system, fixed roof, cover, or enclosure that are designated, as described in §63.1367(f)(1), as unsafe-to-inspect are exempt from the inspection requirements of paragraphs (h)(2)(i), (ii), and (iii) of this section if:

(i) The owner or operator determines that the equipment is unsafe-to-inspect because inspecting personnel would be exposed to an imminent or potential danger as a consequence of complying with paragraph (h)(2)(i), (ii), or (iii) of this section; and

(ii) The owner or operator has a written plan that requires inspection of the equipment as frequently as practicable during safe-to-inspect times. Inspection is not required more than once annually.

(7) Any parts of the vapor collection system, closed-vent system, fixed roof, cover, or enclosure that are designated, as described in §63.1367(f)(2), as difficult-to-inspect are exempt from the inspection requirements of paragraphs (h)(2)(i), (ii), and (iii)(A) of this section if:

(i) The owner or operator determines that the equipment cannot be inspected without elevating the inspecting personnel more than 2 meters above a support surface; and

(ii) The owner or operator has a written plan that requires inspection of the equipment at least once every 5 years.

(8) Records shall be maintained as specified in §63.1367(f).

(9) If a closed-vent system subject to this section is also subject to the equipment leak provisions of §63.1363, the owner or operator shall comply with the provisions of §63.1363 and is exempt from the requirements of this section.

(10) For any closed-vent system that is operated and maintained under negative pressure, the owner or operator is not required to comply with the requirements specified in paragraphs (h)(2) through (8) of this section.

[64 FR 33589, June 23, 1999, as amended at 67 FR 59352, Sept. 20, 2002; 68 FR 37358, June 23, 2003; 71 FR 20460, Apr. 20, 2006; 79 FR 17374, Mar. 27, 2014]

 [Back to Top](#)

§63.1367 Recordkeeping requirements.

(a) *Requirements of subpart A of this part.* The owner or operator of an affected source shall comply with the recordkeeping requirements in subpart A of this part as specified in Table 1 of this subpart and in paragraphs (a)(1) through (5) of this section.

(1) *Data retention.* Each owner or operator of an affected source shall keep copies of all records and reports required by this subpart for at least 5 years, as specified in §63.10(b)(1) of subpart A of this part.

(2) *Records of applicability determinations.* The owner or operator of a stationary source that is not subject to this subpart shall keep a record of the applicability determination, as specified in §63.10(b)(3) of subpart A of this part.

(3) *Records of malfunctions.* (i) In the event that an affected unit fails to meet an applicable standard, record the number of failures. For each failure record the date, time, and duration of each failure.

(ii) For each failure to meet an applicable standard, record and retain a list of the affected sources or equipment, an estimate of the quantity of each regulated pollutant emitted over any emission limit, and a description of the method used to estimate the emissions.

(iii) Record actions taken to minimize emissions in accordance with §63.1360(e)(4), and any corrective actions taken to return the affected unit to its normal or usual manner of operation.

(4) *Recordkeeping requirements for sources with continuous monitoring systems.* The owner or operator of an affected source who installs a continuous monitoring system to comply with the alternative standards in §63.1362(b)(6) or (c)(4) shall maintain records specified in §63.10(c)(1) through (14) of subpart A of this part.

(5) *Application for approval of construction or reconstruction.* For new affected sources, each owner or operator shall comply with the provisions regarding construction and reconstruction in §63.5 of subpart A of this part.

(b) *Records of equipment operation.* The owner or operator must keep the records specified in paragraphs (b)(1) through (11) of this section up-to-date and readily accessible.

(1) Each measurement of a control device operating parameter monitored in accordance with §63.1366 and each measurement of a treatment process parameter monitored in accordance with the provisions of §63.1362(d).

(2) For processes subject to §63.1362(g), records of consumption, production, and the rolling average values of the HAP and VOC factors.

(3) For each continuous monitoring system used to comply with the alternative standards in §63.1362(b)(6) and (c)(4), records documenting the completion of calibration checks and maintenance of the continuous monitoring systems.

(4) For processes in compliance with the 0.15 Mg/yr emission limit of §63.1362(b)(2)(i) or (b)(4)(i), daily records of the rolling annual calculations of uncontrolled emissions.

(5) For each bag leak detector used to monitor particulate HAP emissions from a fabric filter, the owner or operator shall maintain records of any bag leak detection alarm, including the date and time, with a brief explanation of the cause of the alarm and the corrective action taken.

(6) The owner or operator of an affected source that complies with the standards for process vents, storage tanks, and wastewater systems shall maintain up-to-date, readily accessible records of the information specified in paragraphs (b)(6)(i) through (vii) of this section to document that HAP emissions or HAP loadings (for wastewater) are below the limits specified in §63.1362:

(i) Except as specified in paragraph (b)(6)(ix) of this section, the initial calculations of uncontrolled and controlled emissions of gaseous organic HAP and HCl per batch for each process.

(ii) The wastewater concentrations and flow rates per POD and process.

(iii) The number of batches per year for each batch process.

(iv) The operating hours per year for continuous processes.

(v) The number of batches and the number of operating hours for processes that contain both batch and continuous operations.

(vi) The number of tank turnovers per year, if used in an emissions average or for determining applicability of a new PAI process unit.

(vii) A description of absolute or hypothetical peak-case operating conditions as determined using the procedures in §63.1365(b)(11).

(viii) Periods of planned routine maintenance as described in §63.1362(c)(5).

(ix) As an alternative to the records in paragraph (b)(6)(i) of this section, a record of the determination that the conditions in §63.1365(b)(11)(iii)(D)(1) or (2) are met.

(7) Daily schedule or log of each operating scenario updated daily or, at a minimum, each time a different operating scenario is put into operation.

(8) If the owner or operator elects to comply with the vapor balancing alternative in §63.1362(c)(6), the owner or operator must keep records of the DOT certification required by §63.1362(c)(6)(ii) and the pressure relief vent setting and leak detection records specified in §63.1362(c)(6)(v).

(9) If the owner or operator elects to develop process unit groups, the owner or operator must keep records of the PAI and non-PAI process units in the process unit group, including records of the operating time for process units used to establish the process unit group. The owner or operator must also keep records of any redetermination of the primary product for the process unit group.

(10) All maintenance performed on the air pollution control equipment.

(11) If the owner or operator elects to comply with §63.1362(c) by installing a floating roof, the owner or operator must keep records of each inspection and seal gap measurement in accordance with §63.123(c) through (e) as applicable.

(c) *Records of equipment leak detection and repair.* The owner or operator of an affected source subject to the equipment leak standards in §63.1363 shall implement the recordkeeping requirements specified in §63.1363(g). All records shall be retained for a period of 5 years, in accordance with the requirements of §63.10(b)(1) of subpart A of this part.

(d) *Records of emissions averaging.* The owner or operator of an affected source that chooses to comply with the requirements of §63.1362(h) shall maintain up-to-date records of the following information:

(1) An Emissions Averaging Plan which shall include in the plan, for all emission points included in each of the emissions averages, the information listed in paragraphs (d)(1)(i) through (v) of this section.

(i) The identification of all emission points in each emissions average.

(ii) The values of all parameters needed for input to the emission debits and credits equations in §63.1365(h).

(iii) The calculations used to obtain the debits and credits.

(iv) The estimated values for all parameters required to be monitored under §63.1366(g) for each emission point included in an average. These parameter values, or as appropriate, limited ranges for parameter values, shall be specified as enforceable operating conditions for the operation of the process, storage vessel, or waste management unit, as appropriate. Changes to the parameters must be reported as required by §63.1368(k).

(v) A statement that the compliance demonstration, monitoring, inspection, recordkeeping and reporting provisions in §63.1365(h), §63.1366(g), and §63.1368(k) that are applicable to each emission point in the emissions average will be implemented beginning on the date of compliance.

(2) The Emissions Averaging Plan shall demonstrate that the emissions from the emission points proposed to be included in the average will not result in greater hazard or, at the option of the operating permit authority, greater risk to human health or the environment than if the emission points were controlled according to the provisions in §63.1362(b) through (d).

(i) This demonstration of hazard or risk equivalency shall be made to the satisfaction of the operating permit authority.

(A) The Administrator may require an owner or operator to use specific methodologies and procedures for making a hazard or risk determination.

(B) The demonstration and approval of hazard or risk equivalency shall be made according to any guidance that the Administrator makes available for use or any other technically sound information or methods.

(ii) An Emissions Averaging Plan that does not demonstrate hazard or risk equivalency to the satisfaction of the Administrator shall not be approved. The Administrator may require such adjustments to the Emissions Averaging Plan as are necessary in order to ensure that the average will not result in greater hazard or risk to human health or the environment than would result if the emission points were controlled according to §63.1362(b) through (d).

(iii) A hazard or risk equivalency demonstration must satisfy the requirements specified in paragraphs (d)(2)(iii) (A) through (C) of this section.

(A) Be a quantitative, comparative chemical hazard or risk assessment;

(B) Account for differences between averaging and nonaveraging options in chemical hazard or risk to human health or the environment; and

(C) Meet any requirements set by the Administrator for such demonstrations.

(3) Records as specified in paragraphs (a) and (b) of this section.

(4) A calculation of the debits and credits as specified in §63.1365(h) for the last quarter and the prior four quarters.

(e) The owner or operator of an affected source subject to the requirements for heat exchanger systems in §63.1362(g) shall retain the records as specified in §63.104(f)(1)(i) through (iv).

(f) *Records of inspections.* The owner or operator shall keep records specified in paragraphs (f)(1) through (6) of this section.

(1) Records identifying all parts of the vapor collection system, closed-vent system, fixed roof, cover, or enclosure that are designated as unsafe to inspect in accordance with §63.1366(h)(6), an explanation of why the equipment is unsafe-to-inspect, and the plan for inspecting the equipment.

(2) Records identifying all parts of the vapor collection system, closed-vent system, fixed roof, cover, or enclosure that are designated as difficult-to-inspect in accordance with §63.1366(h)(7), an explanation of why the equipment is difficult-to-inspect, and the plan for inspecting the equipment.

(3) For each vapor collection system or closed-vent system that contains bypass lines that could divert a vent stream away from the control device and to the atmosphere, the owner or operator shall keep a record of the information specified in either paragraph (f)(3)(i) or (ii) of this section.

(i) Hourly records of whether the flow indicator specified under §63.1362(j)(1) was operating and whether a diversion was detected at any time during the hour, as well as records of the times and durations of all periods when the vent stream is diverted from the control device or the flow indicator is not operating.

(ii) Where a seal mechanism is used to comply with §63.1362(j)(2), hourly records of flow are not required. In such cases, the owner or operator shall record that the monthly visual inspection of the seals or closure mechanisms has been done and shall record the occurrence of all periods when the seal mechanism is broken, the bypass line valve position has changed, or the key for a lock-and-key type lock has been checked out, and records of any car-seal that has broken.

(4) For each inspection conducted in accordance with §63.1366(h)(2) and (3) during which a leak is detected, a record of the information specified in paragraphs (f)(4)(i) through (ix) of this section.

(i) Identification of the leaking equipment.

(ii) The instrument identification numbers and operator name or initials, if the leak was detected using the procedures described in §63.1366(h)(3); or a record of that the leak was detected by sensory observations.

(iii) The date the leak was detected and the date of the first attempt to repair the leak.

(iv) Maximum instrument reading measured by the method specified in §63.1366(h)(4) after the leak is successfully repaired or determined to be nonreparable.

(v) "Repair delayed" and the reason for the delay if a leak is not repaired within 15 calendar days after discovery of the leak.

(vi) The name, initials, or other form of identification of the owner or operator (or designee) whose decision it was that repair could not be effected without a shutdown.

(vii) The expected date of successful repair of the leak if a leak is not repaired within 15 calendar days.

(viii) Dates of shutdowns that occur while the equipment is unrepaired.

(ix) The date of successful repair of the leak.

(5) For each inspection conducted in accordance with §63.1366(h)(3) during which no leaks are detected, a record that the inspection was performed, the date of the inspection, and a statement that no leaks were detected.

(6) For each visual inspection conducted in accordance with §63.1366(h)(2)(i)(B) or (iii)(B) of this section during which no leaks are detected, a record that the inspection was performed, the date of the inspection, and a statement that no leaks were detected.

(g) *Records of primary use.* For a PAI process unit that is used to produce a given material for use as a PAI as well as for other purposes, the owner or operator shall keep records of the total production and the production for use as a PAI on a semiannual or more frequent basis if the use as a PAI is not the primary use.

[64 FR 33589, June 23, 1999, as amended at 67 FR 59353, Sept. 20, 2002; 71 FR 20460, Apr. 20, 2006; 79 FR 17374, Mar. 27, 2014]

 [Back to Top](#)

§63.1368 Reporting requirements.

(a) The owner or operator of an affected source shall comply with the reporting requirements of paragraphs (b) through (l) of this section. The owner or operator shall also comply with applicable paragraphs of §§63.9 and 63.10 of subpart A of this part, as specified in Table 1 of this subpart.

(b) *Initial notification.* The owner or operator shall submit the applicable initial notification in accordance with §63.9(b) or (d) of subpart A of this part.

(c) *Application for approval of construction or reconstruction.* The owner or operator who is subject to §63.5(b)(3) of subpart A of this part shall submit to the Administrator an application for approval of the construction of a new major source, the reconstruction of a major affected source, or the reconstruction of a major affected source subject to the standards. The application shall be prepared in accordance with §63.5(d) of subpart A of this part.

(d) *Notification of continuous monitoring system performance evaluation.* An owner or operator who is required by the Administrator to conduct a performance evaluation for a continuous monitoring system that is used to comply with the alternative standard in §63.1362(b)(6) or (c)(4) shall notify the Administrator of the date of the performance evaluation as specified in §63.8(e)(2) of subpart A of this part.

(e) *Precompliance plan.* The Precompliance plan shall be submitted at least 3 months prior to the compliance date of the standard. For new sources, the Precompliance plan shall be submitted to the Administrator with the application for approval of construction or reconstruction. The Administrator shall have 90 days to approve or disapprove the Precompliance plan. The Precompliance plan shall be considered approved if the Administrator either approves it in writing, or fails to disapprove it in writing within the 90-day time period. The 90-day period shall begin when the Administrator receives the Precompliance plan. If the Precompliance plan is disapproved, the owner or operator must still be in compliance with the standard by the compliance date. To change any of the information submitted in the Precompliance plan or to submit a Precompliance plan for the first time after the compliance date, the owner or operator shall notify the Administrator at least 90 days before the planned change is to be implemented; the change shall be considered approved if the Administrator either approves the change in writing, or fails to disapprove the change in writing within 90 days of receipt of the change. The Precompliance plan shall include the information specified in paragraphs (e)(1) through (5) of this section.

(1) Requests for approval to use alternative monitoring parameters or requests to set monitoring parameters according to §63.1366(b)(4).

(2) Descriptions of the daily or per batch demonstrations to verify that control devices subject to §63.1366(b)(1)(i) are operating as designed.

(3) Data and rationale used to support the parametric monitoring level(s) that are set according to §63.1366(b)(3)(ii)(B).

(4) For owners and operators complying with the requirements of §63.1362(g), the pollution prevention demonstration summary required in §63.1365(g)(1).

(5) Data and rationale used to support an engineering assessment to calculate uncontrolled emissions from process vents as required in §63.1365(c)(2)(ii).

(6) For fabric filters that are monitored with bag leak detectors, an operation and maintenance plan that describes proper operation and maintenance procedures, and a corrective action plan that describes corrective actions to be taken, and the timing of those actions, when the particulate matter concentration exceeds the setpoint and activates the alarm.

(f) *Notification of compliance status report.* The Notification of Compliance Status report required under §63.9(h) shall be submitted no later than 150 calendar days after the compliance date and shall include the information specified in paragraphs (f)(1) through (7) of this section.

(1) The results of any applicability determinations, emission calculations, or analyses used to identify and quantify HAP emissions from the affected source.

(2) The results of emissions profiles, performance tests, engineering analyses, design evaluations, or calculations used to demonstrate compliance. For performance tests, results should include descriptions of sampling and analysis procedures and quality assurance procedures.

(3) Descriptions of monitoring devices, monitoring frequencies, and the values of monitored parameters established during the initial compliance determinations, including data and calculations to support the levels established.

(4) Operating scenarios.

(5) Descriptions of absolute or hypothetical peak-case operating and/or testing conditions for control devices.

(6) Identification of emission points subject to overlapping requirements described in §63.1360(i) and the authority under which the owner or operator will comply, and identification of emission sources discharging to devices described by §63.1362(l).

(7) Anticipated periods of planned routine maintenance during which the owner or operator would not be in compliance with the provisions in §63.1362(c)(1) through (4).

(8) Percentage of total production from a PAI process unit that is anticipated to be produced for use as a PAI in the 3 years after either June 23, 1999 or startup, whichever is later.

(9) Records of the initial process units used to create each process unit group, if applicable.

(g) *Periodic reports.* The owner or operator shall prepare Periodic reports in accordance with paragraphs (g)(1) and (2) of this section and submit them to the Administrator.

(1) *Submittal schedule.* Except as provided in paragraphs (g)(1)(i) and (ii) of this section, the owner or operator shall submit Periodic reports semiannually. The first report shall be submitted no later than 240 days after the date the Notification of Compliance Status report is due and shall cover the 6-month period beginning on the date the Notification of Compliance Status report is due. Each subsequent Periodic report shall cover the 6-month period following the preceding period and shall be submitted no later than 60 days after the end of the applicable period.

(i) The Administrator may determine on a case-by-case basis that more frequent reporting is necessary to accurately assess the compliance status of the affected source.

(ii) Quarterly reports shall be submitted when the monitoring data are used to comply with the alternative standards in §63.1362(b)(6) or (c)(4) and the source experiences excess emissions. Once an affected source reports excess emissions, the affected source shall follow a quarterly reporting format until a request to reduce reporting frequency is approved. If an owner or operator submits a request to reduce the frequency of reporting, the provisions in §63.10(e)(3) (ii) and (iii) of subpart A of this part shall apply, except that the term "excess emissions and continuous monitoring system performance report and/or summary report" shall mean "Periodic report" for the purposes of this section.

(2) *Content of periodic report.* The owner or operator shall include the information in paragraphs (g)(2)(i) through (xii) of this section, as applicable.

(i) Each Periodic report must include the information in §63.10(e)(3)(vi)(A) through (M) of subpart A of this part, as applicable.

(ii) If the total duration of excess emissions, parameter exceedances, or excursions for the reporting period is 1 percent or greater of the total operating time for the reporting period, or the total continuous monitoring system downtime for the reporting period is 5 percent or greater of the total operating time for the reporting period, the Periodic report must include the information in paragraphs (g)(2)(ii)(A) through (D) of this section.

(A) Monitoring data, including 15-minute monitoring values as well as daily average values of monitored parameters, for all operating days when the average values were outside the ranges established in the Notification of Compliance Status report or operating permit.

(B) Duration of excursions, as defined in §63.1366(b)(7).

(C) Operating logs and operating scenarios for all operating days when the values are outside the levels established in the Notification of Compliance Status report or operating permit.

(D) When a continuous monitoring system is used, the information required in §63.10(c)(5) through (13) of subpart A of this part.

(iii) For each vapor collection system or closed vent system with a bypass line subject to §63.1362(j)(1), records required under §63.1366(f) of all periods when the vent stream is diverted from the control device through a bypass line. For each vapor collection system or closed vent system with a bypass line subject to §63.1362(j)(2), records required under §63.1366(f) of all periods in which the seal mechanism is broken, the bypass valve position has changed, or the key to unlock the bypass line valve was checked out.

(iv) The information in paragraphs (g)(2)(iv)(A) through (D) of this section shall be stated in the Periodic report, when applicable.

(A) No excess emissions.

(B) No exceedances of a parameter.

(C) No excursions.

(D) No continuous monitoring system has been inoperative, out of control, repaired, or adjusted.

(v) For each storage vessel subject to control requirements:

(A) Actual periods of planned routine maintenance during the reporting period in which the control device does not meet the specifications of §63.1362(c)(5); and

(B) Anticipated periods of planned routine maintenance for the next reporting period.

(vi) For each PAI process unit that does not meet the definition of primary use, the percentage of the production in the reporting period produced for use as a PAI.

(viii) Updates to the corrective action plan.

(ix) Records of process units added to each process unit group, if applicable.

(x) Records of redetermination of the primary product for a process unit group.

(xi) For each inspection conducted in accordance with §63.1366(h)(2) or (3) during which a leak is detected, the records specified in §63.1367(h)(4) must be included in the next Periodic report.

(xii) If the owner or operator elects to comply with the provisions of §63.1362(c) by installing a floating roof, the owner or operator shall submit the information specified in §63.122(d) through (f) as applicable. References to §63.152 in §63.122 shall not apply for the purposes of this subpart.

(h) *Notification of process change.* (1) Except as specified in paragraph (h)(2) of this section, whenever a process change is made, or any of the information submitted in the Notification of Compliance Status report changes, the owner or operator shall submit the information specified in paragraphs (h)(1)(i) through (iv) of this section with the next Periodic report required under paragraph (g) of this section. For the purposes of this section, a process change means the startup of a new process, as defined in §63.1361.

(i) A brief description of the process change;

(ii) A description of any modifications to standard procedures or quality assurance procedures;

(iii) Revisions to any of the information reported in the original Notification of Compliance Status report under paragraph (f) of this section; and

(iv) Information required by the Notification of Compliance Status report under paragraph (f) of this section for changes involving the addition of processes or equipment.

(2) The owner or operator must submit a report 60 days before the scheduled implementation date of either of the following:

(i) Any change in the activity covered by the Precompliance report.

(ii) A change in the status of a control device from small to large.

(i) *Reports of malfunctions.* If a source fails to meet an applicable standard, report such events in the Periodic Report. Report the number of failures to meet an applicable standard. For each instance, report the date, time, and duration of each failure. For each failure the report must include a list of the affected sources or equipment, an estimate of the quantity of each regulated pollutant emitted over any emission limit, and a description of the method used to estimate the emissions.

(j) *Reports of equipment leaks.* The owner or operator of an affected source subject to the standards in §63.1363, shall implement the reporting requirements specified in §63.1363(h). Copies of all reports shall be retained as records for a period of 5 years, in accordance with the requirements of §63.10(b)(1) of subpart A of this part.

(k) *Reports of emissions averaging.* The owner or operator of an affected source that chooses to comply with the requirements of §63.1362(h) shall submit all information as specified in §63.1367(d) for all emission points included in the emissions average. The owner or operator shall also submit to the Administrator all information specified in paragraph (g) of this section for each emission point included in the emissions average.

(1) The reports shall also include the information listed in paragraphs (k)(1)(i) through (iv) of this section:

(i) Any changes to the processes, storage tanks, or waste management unit included in the average.

(ii) The calculation of the debits and credits for the reporting period.

(iii) Changes to the Emissions Averaging Plan which affect the calculation methodology of uncontrolled or controlled emissions or the hazard or risk equivalency determination.

(iv) Any changes to the parameters monitored according to §63.1366(g).

(2) Every second semiannual or fourth quarterly report, as appropriate, shall include the results according to §63.1367(d)(4) to demonstrate the emissions averaging provisions of §§63.1362(h), 63.1365(h), 63.1366(g), and 63.1367(d) are satisfied.

(l) *Reports of heat exchange systems.* The owner or operator of an affected source subject to the requirements for heat exchange systems in §63.1362(f) shall submit information about any delay of repairs as specified in §63.104(f)(2) of subpart F of this part, except that when the phrase “periodic reports required by §63.152(c) of subpart G of this part” is referred to in §63.104(f)(2) of subpart F of this part, the periodic reports required in paragraph (g) of this section shall apply for the purposes of this subpart.

(m) *Notification of performance test and test Plan.* The owner or operator of an affected source shall notify the Administrator of the planned date of a performance test at least 60 days before the test in accordance with §63.7(b) of subpart A of this part. The owner or operator also must submit the test Plan required by §63.7(c) of subpart A of this part and the emission profile required by §63.1365(b)(11)(iii) with the notification of the performance test.

(n) *Request for extension of compliance.* The owner or operator may submit to the Administrator a request for an extension of compliance in accordance with §63.1364(a)(2).

(o) The owner or operator who submits an operating permit application before the date the Emissions Averaging Plan is due shall submit the information specified in paragraphs (o)(1) through (3) of this section with the operating permit application instead of the Emissions Averaging Plan.

(1) The information specified in §63.1367(d) for emission points included in the emissions average;

(2) The information specified in §63.9(h) of subpart A of this part, as applicable; and

(3) The information specified in paragraph (e) of this section, as applicable.

(p) *Electronic reporting.* Within 60 days after the date of completing each performance test (as defined in §63.2), the owner or operator must submit the results of the performance tests, including any associated fuel analyses, required by this subpart according to the methods specified in paragraphs (p)(1) or (2) of this section.

(1) For data collected using test methods supported by the EPA-provided software, the owner or operator shall submit the results of the performance test to the EPA by direct computer-to-computer electronic transfer via EPA-provided software, unless otherwise approved by the Administrator. Owners or operators, who claim that some of the information being submitted for performance tests is confidential business information (CBI), must submit a complete file using EPA-provided software that includes information claimed to be CBI on a compact disk, flash drive, or other commonly used electronic storage media to the EPA. The electronic media must be clearly marked as CBI and mailed to U.S. EPA/OAPQS/CORE CBI Office, Attention: WebFIRE Administrator, MD C404-02, 4930 Old Page Rd.,

Durham, NC 27703. The same file with the CBI omitted must be submitted to the EPA by direct computer-to-computer electronic transfer via EPA-provided software.

(2) For any performance test conducted using test methods that are not compatible with the EPA-provided software, the owner or operator shall submit the results of the performance test to the Administrator at the appropriate address listed in §60.4.

[64 FR 33589, June 23, 1999, as amended at 66 FR 58396, Nov. 21, 2001; 67 FR 59354, Sept. 20, 2002; 79 FR 17375, Mar. 27, 2014]

[↑ Back to Top](#)

§63.1369 Implementation and enforcement.

(a) This subpart can be implemented and enforced by the U.S. EPA, or a delegated authority such as the applicable State, local, or Tribal agency. If the U.S. EPA Administrator has delegated authority to a State, local, or Tribal agency, then that agency, in addition to the U.S. EPA, has the authority to implement and enforce this subpart. Contact the applicable U.S. EPA Regional Office to find out if implementation and enforcement of this subpart is delegated to a State, local, or Tribal agency.

(b) In delegating implementation and enforcement authority of this subpart to a State, local, or Tribal agency under subpart E of this part, the authorities contained in paragraph (c) of this section are retained by the Administrator of U.S. EPA and cannot be transferred to the State, local, or Tribal agency.

(c) The authorities that cannot be delegated to State, local, or Tribal agencies are as specified in paragraphs (c)(1) through (4) of this section.

(1) Approval of alternatives to the requirements in §§63.1360 and 63.1362 through 63.1364. Where these standards reference another subpart, the cited provisions will be delegated according to the delegation provisions of the referenced subpart. Where these standards reference another subpart and modify the requirements, the requirements shall be modified as described in this subpart. Delegation of the modified requirements will also occur according to the delegation provisions of the referenced subpart.

(2) Approval of major alternatives to test methods for under §63.7(e)(2)(ii) and (f), as defined in §63.90, and as required in this subpart.

(3) Approval of major alternatives to monitoring under §63.8(f), as defined in §63.90, and as required in this subpart.

(4) Approval of major alternatives to recordkeeping and reporting under §63.10(f), as defined in §63.90, and as required in this subpart.

[68 FR 37358, June 23, 2003]

[↑ Back to Top](#)

Table 1 to Subpart MMM of Part 63—General Provisions Applicability to Subpart MMM

Reference to subpart A	Applies to subpart	Explanation
------------------------	--------------------	-------------

	MMM	
§63.1(a)(1)	Yes	Additional terms are defined in §63.1361.
§63.1(a)(2)-(3)	Yes	
§63.1(a)(4)	Yes	Subpart MMM (this table) specifies applicability of each paragraph in subpart A to subpart MMM.
§63.1(a)(5)	N/A	Reserved.
§63.1(a)(6)-(7)	Yes	
§63.1(a)(8)	No	Discusses State programs.
§63.1(a)(9)	N/A	Reserved.
§63.1(a)(10)-(14)	Yes	
§63.1(b)(1)	No	§63.1360 specifies applicability.
§63.1(b)(2)-(3)	Yes	
§63.1(c)(1)	Yes	Subpart MMM (this table) specifies the applicability of each paragraph in subpart A to sources subject to subpart MMM.
§63.1(c)(2)	No	Area sources are not subject to subpart MMM.
§63.1(c)(3)	N/A	Reserved.
§63.1(c)(4)-(5)	Yes	
§63.1(d)	N/A	Reserved.
§63.1(e)	Yes	
§63.2	Yes	Additional terms are defined in §63.1361; when overlap between subparts A and MMM occurs, subpart MMM takes precedence.
§63.3	Yes	Other units used in subpart MMM are defined in that subpart.
§63.4(a)(1)-(3)	Yes	
§63.4(a)(4)	N/A	Reserved.
§63.4(a)(5)-(c)	Yes	
§63.5(a)	Yes	Except the term “affected source” shall apply instead of the terms “source” and “stationary source” in §63.5(a)(1) of subpart A.
§63.5(b)(1)	Yes	
§63.5(b)(2)	N/A	Reserved.
§63.5(b)(3)-(5)	Yes	
§63.5(b)(6)	No	§63.1360(g) specifies requirements for determining applicability of added PAI equipment.

§63.5(c)	N/A	Reserved.
§63.5(d)-(e)	Yes	
§63.5(f)(1)	Yes	Except “affected source” shall apply instead of “source” in §63.5(f)(1) of subpart A.
§63.5(f)(2)	Yes	
§63.6(a)	Yes	
§63.6(b)(1)-(2)	No	§63.1364 specifies compliance dates.
§63.6(b)(3)-(4)	Yes	
§63.6(b)(5)	Yes	
§63.6(b)(6)	N/A	Reserved.
§63.6(b)(7)	Yes	
§63.6(c)(1)-(2)	Yes	Except “affected source” shall apply instead of “source” in §63.6(c)(1)-(2) of subpart A.
§63.6(c)(3)-(4)	N/A	Reserved.
§63.6(c)(5)	Yes	
§63.6(d)	N/A	Reserved.
§63.6(e)(1)(i)	No	See §63.1360(e)(4) for general duty requirement.
§63.6(e)(1)(ii)	No	
§63.6(e)(1)(iii)	Yes	
§63.6(e)(3)	No	
§63.6(f)(1)	No	
§63.6(f)(2)-(3)	Yes	
§63.6(g)	Yes	An alternative standard has been proposed; however, affected sources will have the opportunity to demonstrate other alternatives to the Administrator.
§63.6(h)	No	Subpart MMM does not contain any opacity or visible emissions standards.
§63.6(i)(1)	Yes	
§63.6(i)(2)	Yes	Except “affected source” shall apply instead of “source” in §63.6(i)(2)(i) and (ii) of subpart A.
§63.6(i)(3)-(14)	Yes	
§63.6(i)(15)	N/A	Reserved.

§63.6(i)(16)	Yes	
§63.6(j)	Yes	
§63.7(a)(1)	Yes	
§63.7(a)(2)(i)-(vi)	Yes	§63.1368 specifies that test results must be submitted in the Notification of Compliance Status due 150 days after the compliance date.
§63.7(a)(2)(vii)-(viii)	N/A	Reserved.
§63.7(a)(2)(ix)-(c)	Yes	
§63.7(d)	Yes	Except “affected source” shall apply instead of “source” in §63.7(d) of subpart A.
§63.7(e)(1)	No	See §63.1365(b).
§63.7(e)(2)	Yes	
§63.7(e)(3)	Yes	Except §63.1365 specifies less than 3 runs for certain tests.
§63.7(e)(4)	Yes.	
§63.7(f)	Yes	
§63.7(g)(1)	Yes	Except §63.1368(a) specifies that the results of the performance test be submitted with the Notification of Compliance Status report
§63.7(g)(2)	N/A	Reserved.
§63.7(g)(3)	Yes	
§63.7(h)	Yes	
§63.8(a)(1)-(2)	Yes	
§63.8(a)(3)	N/A	Reserved.
§63.8(a)(4)	Yes	
§63.8(b)(1)	Yes	
§63.8(b)(2)	No	§63.1366 specifies CMS requirements.
§63.8(b)(3)	Yes	
§63.8(c)(1)(i)	No	
§63.8(c)(1)(ii)	Yes	
§63.8(c)(1)(iii)	No	
§63.8(c)(2)-(3)	Yes	
§63.8(c)(4)	No	§63.1366 specifies monitoring frequencies.

§63.8(c)(5)-(8)	No	
§63.8(d)-(f)(3)	Yes	Except the last sentence of §63.8(d)(3), which shall be replaced with “The program of corrective action should be included in the plan required under §63.8(d)(2).” for the purposes of this subpart.
§63.8(f)(4)	Yes	Except §63.1368(b) specifies that requests may also be included in the Precompliance report.
§63.8(f)(5)	Yes	
§63.8(f)(6)	No	Subpart MMM does not require CEM's.
§63.8(g)	No	§63.1366 specifies data reduction procedures.
§63.9(a)-(d)	Yes	
§63.9(e)	No	
§63.9(f)	No	Subpart MMM does not contain opacity and visible emission standards.
§63.9(g)	No	
§63.9(h)(1)	Yes	
§63.9(h)(2)(i)	Yes	Except §63.1368(a)(1) specifies additional information to include in the Notification of Compliance Status report.
§63.9(h)(2)(ii)	No	§63.1368 specifies the Notification of Compliance Status report is to be submitted within 150 days after the compliance date.
§63.9(h)(3)	Yes	
§63.9(h)(4)	N/A	Reserved.
§63.9(h)(5)-(6)	Yes	
63.9(i)	Yes.	
63.9(j)	No	§63.1368(h) specifies procedures for notification of changes.
§63.10(a)-(b)(1)	Yes	
§63.10(b)(2)	No	§63.1367 specifies recordkeeping requirements.
§63.10(b)(3)	Yes	
§63.10(c)(1)-(14)	Yes	
§63.10(c)(15)	No	
§63.10(d)(1)	Yes	
§63.10(d)(2)	Yes	
§63.10(d)(3)	No	Subpart MMM does not include opacity and visible emission standards.

§63.10(d)(4)	Yes	
§63.10(d)(5)	No	See §63.1368(i) for malfunction reporting requirements.
§63.10(e)(1)-(2)(i)	Yes	
§63.10(e)(2)(ii)	No	Subpart MMM does not include opacity monitoring requirements.
§63.10(e)(3)	Yes	
§63.10(e)(4)	No	Subpart MMM does not include opacity monitoring requirements.
§63.10(f)	Yes	
§63.11-§63.15	Yes	

[64 FR 33589, June 23, 1999, as amended at 67 FR 59355, Sept. 20, 2002; 79 FR 17375, Mar. 27, 2014]

[↑ Back to Top](#)

Table 2 to Subpart MMM of Part 63—Standards for New and Existing PAI Sources

Emission source	Applicability	Requirement
Process vents	Existing:	
	Processes having uncontrolled organic HAP emissions ≥ 0.15 Mg/yr	90% for organic HAP per process or to outlet concentration of ≤ 20 ppmv TOC.
	Processes having uncontrolled HCl and chlorine emissions ≥ 6.8 Mg/yr	94% for HCl and chlorine per process or to outlet HCl and chlorine concentration of ≤ 20 ppmv.
	Individual process vents meeting flow and mass emissions criteria that have gaseous organic HAP emissions controlled to less than 90% on or after November 10, 1997	98% gaseous organic HAP control per vent or ≤ 20 ppmv TOC outlet limit.
	New:	
	Processes having uncontrolled organic HAP emissions ≥ 0.15 Mg/yr	98% for organic HAP per process or ≤ 20 ppmv TOC.
	Processes having uncontrolled HCl and chlorine emissions ≥ 6.8 Mg/yr and < 191 Mg/yr	94% for HCl and chlorine per process or to outlet concentration of ≤ 20 ppmv HCl and chlorine.
	Processes having uncontrolled HCl and chlorine emissions ≥ 191 Mg/yr	99% for HCl and chlorine per process or to outlet

		concentration of ≤ 20 ppmv HCl and chlorine.
Storage vessels	Existing: ≥ 75 m ³ capacity and vapor pressure ≥ 3.45 kPa	Install a floating roof, reduce HAP by 95% per vessel, or to outlet concentration of ≤ 20 ppmv TOC.
	New: ≥ 38 m ³ capacity and vapor pressure ≥ 16.5 kPa	Same as for existing sources.
	≥ 75 m ³ capacity and vapor pressure ≥ 3.45 kPa	Same as for existing sources.
Wastewater ^a	Existing: Process wastewater with $\geq 10,000$ ppmw Table 9 compounds at any flowrate or $\geq 1,000$ ppmw Table 9 compounds at ≥ 10 L/min, and maintenance wastewater with HAP load ≥ 5.3 Mg per discharge event	Reduce concentration of total Table 9 compounds to < 50 ppmw (or other options).
	New:	
	Same criteria as for existing sources	Reduce concentration of total Table 9 compounds to < 50 ppmw (or other options).
	Total HAP load in wastewater POD streams $\geq 2,100$ Mg/yr.	99% reduction of Table 9 compounds from all streams.
Equipment leaks	Subpart H	Subpart H with minor changes, including monitoring frequencies consistent with the proposed CAR.
Product dryers and bag dumps	Dryers used to dry PAI that is also a HAP, and bag dumps used to introduce feedstock that is a solid and a HAP	Particulate matter concentration not to exceed 0.01 gr/dscf.
Heat exchange systems	Each heat exchange system used to cool process equipment in PAI manufacturing operations	Monitoring and leak repair program as in HON.

^aTable 9 is listed in the appendix to subpart G of 40 CFR part 63.

[↑ Back to Top](#)

Table 3 to Subpart MMM of Part 63—Monitoring Requirements for Control Devices^a

Control device	Monitoring equipment required	Parameters to be monitored	Frequency
All control devices	1. Flow indicator	1. Presence of flow	Hourly records of

	installed at all bypass lines to the atmosphere and equipped with continuous recorder or	diverted from the control device to the atmosphere or	whether the flow indicator was operating and whether a diversion was detected at any time during each hour.
	2. Valves sealed closed with car-seal or lock-and-key configuration	2. Monthly inspections of sealed valves	Monthly.
Scrubber	Liquid flow rate or pressure drop mounting device. Also a pH monitor if the scrubber is used to control acid emissions.	1. Liquid flow rate into or out of the scrubber or the pressure drop across the scrubber.	1. Every 15 minutes.
		2. pH of effluent scrubber liquid	2. Once a day.
Thermal incinerator	Temperature monitoring device installed in firebox or in ductwork immediately downstream of firebox ^b	Firebox temperature	Every 15 minutes.
Catalytic incinerator	Temperature monitoring device installed in gas stream immediately before and after catalyst bed	Temperature difference across catalyst bed	Every 15 minutes.
Flare	Heat sensing device installed at the pilot light	Presence of a flame at the pilot light	Every 15 minutes.
Boiler or process heater <44 megawatts and vent stream is not mixed with the primary fuel	Temperature monitoring device installed in firebox ^b	Combustion temperature	Every 15 minutes.
Condenser	Temperature monitoring device installed at condenser exit	Condenser exit (product side) temperature	Every 15 minutes.
Carbon adsorber (nonregenerative)	None	Operating time since last replacement	N/A.
Carbon adsorber (regenerative)	Stream flow monitoring device, and	1. Total regeneration stream mass or volumetric flow	1. For each regeneration cycle, record the total regeneration stream

		during carbon bed regeneration cycle(s)	mass or volumetric flow.
	Carbon bed temperature monitoring device	2. Temperature of carbon bed after regeneration	2. For each regeneration cycle, record the maximum carbon bed-temperature.
		3. Temperature of carbon bed within 15 minutes of completing any cooling cycle(s)	3. Within 15 minutes of completing any cooling cycle, record the carbon bed temperature.
		4. Operating time since end of last regeneration	4. Operating time to be based on worst-case conditions.
		5. Check for bed poisoning	5. Yearly.

^aAs an alternative to the monitoring requirements specified in this table, the owner or operator may use a CEM meeting the requirements of Performance Specifications 8 or 9 of appendix B of part 60 to monitor TOC every 15 minutes.

^bMonitor may be installed in the firebox or in the ductwork immediately downstream of the firebox before any substantial heat exchange is encountered.

[↑ Back to Top](#)

Table 4 to Subpart MMM of Part 63—Control Requirements for Items of Equipment That Meet the Criteria of §63.1362(k)

Item of equipment	Control requirement^a
1. Drain or drain hub	(a) Tightly fitting solid cover (TFSC); or (b) TFSC with a vent to either a process, or to a control device meeting the requirements of §63.139(c); or (c) Water seal with submerged discharge or barrier to protect discharge from wind.
2. Manhole ^b	(a) TFSC; or (b) TFSC with a vent to either a process or to a control device meeting the requirements of §63.139(c); or (c) If the item is vented to the atmosphere, use a TFSC with a properly operating water seal at the entrance or exit to the item to restrict ventilation in the collection system. The vent pipe shall be at least 90 cm in length and not exceeding 10.2 cm in nominal inside diameter.
3. Lift station	(a) TFSC; or

	(b) TFSC with a vent to either a process, or to a control device meeting the requirements of §63.139(c); or (c) If the lift station is vented to the atmosphere, use a TFSC with a properly operating water seal at the entrance or exit to the item to restrict ventilation in the collection system. The vent pipe shall be at least 90 cm in length and not exceeding 10.2 cm in nominal inside diameter. The lift station shall be level controlled to minimize changes in the liquid level.
4. Trench	(a) TFSC; or (b) TFSC with a vent to either a process, or to a control device meeting the requirements of §63.139(c); or (c) If the item is vented to the atmosphere, use a TFSC with a properly operating water seal at the entrance or exit to the item to restrict ventilation in the collection system. The vent pipe shall be at least 90 cm in length and not exceeding 10.2 cm in nominal inside diameter.
5. Pipe	Each pipe shall have no visible gaps in joints, seals, or other emission interfaces.
6. Oil/water separator	(a) Equip with a fixed roof and route vapors to a process, or equip with a closed-vent system that routes vapors to a control device meeting the requirements of §63.139(c); or (b) Equip with a floating roof that meets the equipment specifications of §60.693 (a)(1)(i), (a)(1)(ii), (a)(2), (a)(3), and (a)(4).
7. Tank	Maintain a fixed roof and consider vents as process vents. ^c

^aWhere a tightly fitting solid cover is required, it shall be maintained with no visible gaps or openings, except during periods of sampling, inspection, or maintenance.

^bManhole includes sumps and other points of access to a conveyance system.

^cA fixed roof may have openings necessary for proper venting of the tank, such as pressure/vacuum vent, j-pipe vent.

[67 FR 59355, Sept. 20, 2002]

 [Back to Top](#)

Appendix C

Subpart Kb—Standards of Performance for Volatile Organic Liquid Storage Vessels (Including Petroleum Liquid Storage Vessels) for Which Construction, Reconstruction, or Modification Commenced After July 23, 1984

Contents

- §60.110b Applicability and designation of affected facility.
 - §60.111b Definitions.
- §60.112b Standard for volatile organic compounds (VOC).
 - §60.113b Testing and procedures.
 - §60.114b Alternative means of emission limitation.
- §60.115b Reporting and recordkeeping requirements.
 - §60.116b Monitoring of operations.
 - §60.117b Delegation of authority.

SOURCE: 52 FR 11429, Apr. 8, 1987, unless otherwise noted.

§60.110b Applicability and designation of affected facility.

(a) Except as provided in paragraph (b) of this section, the affected facility to which this subpart applies is each storage vessel with a capacity greater than or equal to 75 cubic meters (m³) that is used to store volatile organic liquids (VOL) for which construction, reconstruction, or modification is commenced after July 23, 1984.

(b) This subpart does not apply to storage vessels with a capacity greater than or equal to 151 m³ storing a liquid with a maximum true vapor pressure less than 3.5 kilopascals (kPa) or with a capacity greater than or equal to 75 m³ but less than 151 m³ storing a liquid with a maximum true vapor pressure less than 15.0 kPa.

(c) [Reserved]

(d) This subpart does not apply to the following:

(1) Vessels at coke oven by-product plants.

(2) Pressure vessels designed to operate in excess of 204.9 kPa and without emissions to the atmosphere.

(3) Vessels permanently attached to mobile vehicles such as trucks, railcars, barges, or ships.

(4) Vessels with a design capacity less than or equal to 1,589.874 m³ used for petroleum or condensate stored, processed, or treated prior to custody transfer.

(5) Vessels located at bulk gasoline plants.

(6) Storage vessels located at gasoline service stations.

(7) Vessels used to store beverage alcohol.

(8) Vessels subject to subpart GGGG of 40 CFR part 63.

(e) *Alternative means of compliance*—(1) *Option to comply with part 65.* Owners or operators may choose to comply with 40 CFR part 65, subpart C, to satisfy the requirements of §§60.112b through 60.117b for storage vessels that are subject to this subpart that meet the specifications in paragraphs (e)(1)(i) and (ii) of this section. When choosing to comply with 40 CFR part 65, subpart C, the monitoring requirements of §60.116b(c), (e), (f)(1), and (g) still apply. Other provisions applying to owners or operators who choose to comply with 40 CFR part 65 are provided in 40 CFR 65.1.

(i) A storage vessel with a design capacity greater than or equal to 151 m³ containing a VOL that, as stored, has a maximum true vapor pressure equal to or greater than 5.2 kPa; or

(ii) A storage vessel with a design capacity greater than 75 m³ but less than 151 m³ containing a VOL that, as stored, has a maximum true vapor pressure equal to or greater than 27.6 kPa.

(2) *Part 60, subpart A.* Owners or operators who choose to comply with 40 CFR part 65, subpart C, must also comply with §§60.1, 60.2, 60.5, 60.6, 60.7(a)(1) and (4), 60.14, 60.15, and 60.16 for those storage vessels. All sections and paragraphs of subpart A of this part that are not mentioned in this paragraph (e)(2) do not apply to owners or operators of storage vessels complying with 40 CFR part 65, subpart C, except that provisions required to be met prior to implementing 40 CFR part 65 still apply. Owners and operators who choose to comply with 40 CFR part 65, subpart C, must comply with 40 CFR part 65, subpart A.

(3) *Internal floating roof report.* If an owner or operator installs an internal floating roof and, at initial startup, chooses to comply with 40 CFR part 65, subpart C, a report shall be furnished to the Administrator stating that the control equipment meets the specifications of 40 CFR 65.43. This report shall be an attachment to the notification required by 40 CFR 65.5(b).

(4) *External floating roof report.* If an owner or operator installs an external floating roof and, at initial startup, chooses to comply with 40 CFR part 65, subpart C, a report shall be furnished to the Administrator stating that the control equipment meets the specifications of 40 CFR 65.44. This report shall be an attachment to the notification required by 40 CFR 65.5(b).

[52 FR 11429, Apr. 8, 1987, as amended at 54 FR 32973, Aug. 11, 1989; 65 FR 78275, Dec. 14, 2000; 68 FR 59332, Oct. 15, 2003]

§60.111b Definitions.

Terms used in this subpart are defined in the Act, in subpart A of this part, or in this subpart as follows:

Bulk gasoline plant means any gasoline distribution facility that has a gasoline throughput less than or equal to 75,700 liters per day. Gasoline throughput shall be the maximum calculated design throughput as may be limited by compliance with an enforceable condition under Federal requirement or Federal, State or local law, and discoverable by the Administrator and any other person.

Condensate means hydrocarbon liquid separated from natural gas that condenses due to changes in the temperature or pressure, or both, and remains liquid at standard conditions.

Custody transfer means the transfer of produced petroleum and/or condensate, after processing and/or treatment in the producing operations, from storage vessels or automatic transfer facilities to pipelines or any other forms of transportation.

Fill means the introduction of VOL into a storage vessel but not necessarily to complete capacity.

Gasoline service station means any site where gasoline is dispensed to motor vehicle fuel tanks from stationary storage tanks.

Maximum true vapor pressure means the equilibrium partial pressure exerted by the volatile organic compounds (as defined in 40 CFR 51.100) in the stored VOL at the temperature equal to the highest calendar-month average of the VOL storage temperature for VOL's stored above or below the ambient temperature or at the local maximum monthly average temperature as reported by the National Weather Service for VOL's stored at the ambient temperature, as determined:

(1) In accordance with methods described in American Petroleum institute Bulletin 2517, Evaporation Loss From External Floating Roof Tanks, (incorporated by reference—see §60.17); or

(2) As obtained from standard reference texts; or

(3) As determined by ASTM D2879-83, 96, or 97 (incorporated by reference—see §60.17);

(4) Any other method approved by the Administrator.

Petroleum means the crude oil removed from the earth and the oils derived from tar sands, shale, and coal.

Petroleum liquids means petroleum, condensate, and any finished or intermediate products manufactured in a petroleum refinery.

Process tank means a tank that is used within a process (including a solvent or raw material recovery process) to collect material discharged from a feedstock storage vessel or equipment within the process before the material is transferred to other equipment within the process, to a product or by-product storage vessel, or to a vessel used to store recovered solvent or raw material. In many process tanks, unit operations such as reactions and blending are conducted. Other process tanks, such as surge control vessels and bottoms receivers, however, may not involve unit operations.

Reid vapor pressure means the absolute vapor pressure of volatile crude oil and volatile nonviscous petroleum liquids except liquified petroleum gases, as determined by ASTM D323-82 or 94 (incorporated by reference—see §60.17).

Storage vessel means each tank, reservoir, or container used for the storage of volatile organic liquids but does not include:

(1) Frames, housing, auxiliary supports, or other components that are not directly involved in the containment of liquids or vapors;

(2) Subsurface caverns or porous rock reservoirs; or

(3) Process tanks.

Volatile organic liquid (VOL) means any organic liquid which can emit volatile organic compounds (as defined in 40 CFR 51.100) into the atmosphere.

Waste means any liquid resulting from industrial, commercial, mining or agricultural operations, or from community activities that is discarded or is being accumulated, stored, or physically, chemically, or biologically treated prior to being discarded or recycled.

[52 FR 11429, Apr. 8, 1987, as amended at 54 FR 32973, Aug. 11, 1989; 65 FR 61756, Oct. 17, 2000; 68 FR 59333, Oct. 15, 2003]

§60.112b Standard for volatile organic compounds (VOC).

(a) The owner or operator of each storage vessel either with a design capacity greater than or equal to 151 m³ containing a VOL that, as stored, has a maximum true vapor pressure equal to or greater than 5.2 kPa but less than 76.6 kPa or with a design capacity greater than or equal to 75 m³ but less than 151 m³ containing a VOL that, as stored, has a maximum true vapor pressure equal to or greater than 27.6 kPa but less than 76.6 kPa, shall equip each storage vessel with one of the following:

(1) A fixed roof in combination with an internal floating roof meeting the following specifications:

(i) The internal floating roof shall rest or float on the liquid surface (but not necessarily in complete contact with it) inside a storage vessel that has a fixed roof. The internal floating roof shall be floating on the liquid surface at all times, except during initial fill and during those intervals when the storage vessel is completely emptied or subsequently emptied and refilled. When the roof is resting on the leg supports, the process of filling, emptying, or refilling shall be continuous and shall be accomplished as rapidly as possible.

(ii) Each internal floating roof shall be equipped with one of the following closure devices between the wall of the storage vessel and the edge of the internal floating roof:

(A) A foam- or liquid-filled seal mounted in contact with the liquid (liquid-mounted seal). A liquid-mounted seal means a foam- or liquid-filled seal mounted in contact with the liquid between the wall of the storage vessel and the floating roof continuously around the circumference of the tank.

(B) Two seals mounted one above the other so that each forms a continuous closure that completely covers the space between the wall of the storage vessel and the edge of the internal floating roof. The lower seal may be vapor-mounted, but both must be continuous.

(C) A mechanical shoe seal. A mechanical shoe seal is a metal sheet held vertically against the wall of the storage vessel by springs or weighted levers and is connected by braces to the floating roof. A flexible coated fabric (envelope) spans the annular space between the metal sheet and the floating roof.

(iii) Each opening in a noncontact internal floating roof except for automatic bleeder vents (vacuum breaker vents) and the rim space vents is to provide a projection below the liquid surface.

(iv) Each opening in the internal floating roof except for leg sleeves, automatic bleeder vents, rim space vents, column wells, ladder wells, sample wells, and stub drains is to be equipped with a cover or lid which is to be maintained in a closed position at all times (i.e., no visible gap) except when the device is in actual use. The cover or lid shall be equipped with a gasket. Covers on each access hatch and automatic gauge float well shall be bolted except when they are in use.

(v) Automatic bleeder vents shall be equipped with a gasket and are to be closed at all times when the roof is floating except when the roof is being floated off or is being landed on the roof leg supports.

(vi) Rim space vents shall be equipped with a gasket and are to be set to open only when the internal floating roof is not floating or at the manufacturer's recommended setting.

(vii) Each penetration of the internal floating roof for the purpose of sampling shall be a sample well. The sample well shall have a slit fabric cover that covers at least 90 percent of the opening.

(viii) Each penetration of the internal floating roof that allows for passage of a column supporting the fixed roof shall have a flexible fabric sleeve seal or a gasketed sliding cover.

(ix) Each penetration of the internal floating roof that allows for passage of a ladder shall have a gasketed sliding cover.

(2) An external floating roof. An external floating roof means a pontoon-type or double-deck type cover that rests on the liquid surface in a vessel with no fixed roof. Each external floating roof must meet the following specifications:

(i) Each external floating roof shall be equipped with a closure device between the wall of the storage vessel and the roof edge. The closure device is to consist of two seals, one above the other. The lower seal is referred to as the primary seal, and the upper seal is referred to as the secondary seal.

(A) The primary seal shall be either a mechanical shoe seal or a liquid-mounted seal. Except as provided in §60.113b(b)(4), the seal shall completely cover the annular space between the edge of the floating roof and tank wall.

(B) The secondary seal shall completely cover the annular space between the external floating roof and the wall of the storage vessel in a continuous fashion except as allowed in §60.113b(b)(4).

(ii) Except for automatic bleeder vents and rim space vents, each opening in a noncontact external floating roof shall provide a projection below the liquid surface. Except for automatic bleeder vents, rim space vents, roof drains, and leg sleeves, each opening in the roof is to be equipped with a gasketed cover, seal, or lid that is to be maintained in a closed position at all times (i.e., no visible gap) except when the device is in actual use. Automatic bleeder vents are to be closed at all times when the roof is floating except when the roof is being floated off or is being landed on the roof leg supports. Rim vents are to be set to open when the roof is being floated off the roof legs supports or at the manufacturer's recommended setting. Automatic bleeder vents and rim space vents are to be gasketed. Each emergency roof drain is to be provided with a slotted membrane fabric cover that covers at least 90 percent of the area of the opening.

(iii) The roof shall be floating on the liquid at all times (i.e., off the roof leg supports) except during initial fill until the roof is lifted off leg supports and when the tank is completely emptied and subsequently refilled. The process of filling, emptying, or refilling when the roof is resting on the leg supports shall be continuous and shall be accomplished as rapidly as possible.

(3) A closed vent system and control device meeting the following specifications:

(i) The closed vent system shall be designed to collect all VOC vapors and gases discharged from the storage vessel and operated with no detectable emissions as indicated by an instrument reading of less than 500 ppm above background and visual inspections, as determined in part 60, subpart VV, §60.485(b).

(ii) The control device shall be designed and operated to reduce inlet VOC emissions by 95 percent or greater. If a flare is used as the control device, it shall meet the specifications described in the general control device requirements (§60.18) of the General Provisions.

(4) A system equivalent to those described in paragraphs (a)(1), (a)(2), or (a)(3) of this section as provided in §60.114b of this subpart.

(b) The owner or operator of each storage vessel with a design capacity greater than or equal to 75 m³ which contains a VOL that, as stored, has a maximum true vapor pressure greater than or equal to 76.6 kPa shall equip each storage vessel with one of the following:

(1) A closed vent system and control device as specified in §60.112b(a)(3).

(2) A system equivalent to that described in paragraph (b)(1) as provided in §60.114b of this subpart.

(c) *Site-specific standard for Merck & Co., Inc.'s Stonewall Plant in Elkton, Virginia.* This paragraph applies only to the pharmaceutical manufacturing facility, commonly referred to as the Stonewall Plant, located at Route 340 South, in Elkton, Virginia ("site").

(1) For any storage vessel that otherwise would be subject to the control technology requirements of paragraphs (a) or (b) of this section, the site shall have the option of either complying directly with the requirements of this subpart, or reducing the site-wide total criteria pollutant emissions cap (total emissions cap) in accordance with the procedures set forth in a permit issued pursuant to 40 CFR 52.2454. If the site chooses the option of reducing the total emissions cap in accordance with the procedures set forth in such permit, the requirements of such permit shall apply in lieu of the otherwise applicable requirements of this subpart for such storage vessel.

(2) For any storage vessel at the site not subject to the requirements of 40 CFR 60.112b (a) or (b), the requirements of 40 CFR 60.116b (b) and (c) and the General Provisions (subpart A of this part) shall not apply.

[52 FR 11429, Apr. 8, 1987, as amended at 62 FR 52641, Oct. 8, 1997]

§60.113b Testing and procedures.

The owner or operator of each storage vessel as specified in §60.112b(a) shall meet the requirements of paragraph (a), (b), or (c) of this section. The applicable paragraph for a particular storage vessel depends on the control equipment installed to meet the requirements of §60.112b.

(a) After installing the control equipment required to meet §60.112b(a)(1) (permanently affixed roof and internal floating roof), each owner or operator shall:

(1) Visually inspect the internal floating roof, the primary seal, and the secondary seal (if one is in service), prior to filling the storage vessel with VOL. If there are holes, tears, or other openings in the primary seal, the secondary seal, or the seal fabric or defects in the internal floating roof, or both, the owner or operator shall repair the items before filling the storage vessel.

(2) For Vessels equipped with a liquid-mounted or mechanical shoe primary seal, visually inspect the internal floating roof and the primary seal or the secondary seal (if one is in service) through manholes and roof hatches on the fixed roof at least once every 12 months after initial fill. If the internal

floating roof is not resting on the surface of the VOL inside the storage vessel, or there is liquid accumulated on the roof, or the seal is detached, or there are holes or tears in the seal fabric, the owner or operator shall repair the items or empty and remove the storage vessel from service within 45 days. If a failure that is detected during inspections required in this paragraph cannot be repaired within 45 days and if the vessel cannot be emptied within 45 days, a 30-day extension may be requested from the Administrator in the inspection report required in §60.115b(a)(3). Such a request for an extension must document that alternate storage capacity is unavailable and specify a schedule of actions the company will take that will assure that the control equipment will be repaired or the vessel will be emptied as soon as possible.

(3) For vessels equipped with a double-seal system as specified in §60.112b(a)(1)(ii)(B):

(i) Visually inspect the vessel as specified in paragraph (a)(4) of this section at least every 5 years;
or

(ii) Visually inspect the vessel as specified in paragraph (a)(2) of this section.

(4) Visually inspect the internal floating roof, the primary seal, the secondary seal (if one is in service), gaskets, slotted membranes and sleeve seals (if any) each time the storage vessel is emptied and degassed. If the internal floating roof has defects, the primary seal has holes, tears, or other openings in the seal or the seal fabric, or the secondary seal has holes, tears, or other openings in the seal or the seal fabric, or the gaskets no longer close off the liquid surfaces from the atmosphere, or the slotted membrane has more than 10 percent open area, the owner or operator shall repair the items as necessary so that none of the conditions specified in this paragraph exist before refilling the storage vessel with VOL. In no event shall inspections conducted in accordance with this provision occur at intervals greater than 10 years in the case of vessels conducting the annual visual inspection as specified in paragraphs (a)(2) and (a)(3)(ii) of this section and at intervals no greater than 5 years in the case of vessels specified in paragraph (a)(3)(i) of this section.

(5) Notify the Administrator in writing at least 30 days prior to the filling or refilling of each storage vessel for which an inspection is required by paragraphs (a)(1) and (a)(4) of this section to afford the Administrator the opportunity to have an observer present. If the inspection required by paragraph (a)(4) of this section is not planned and the owner or operator could not have known about the inspection 30 days in advance or refilling the tank, the owner or operator shall notify the Administrator at least 7 days prior to the refilling of the storage vessel. Notification shall be made by telephone immediately followed by written documentation demonstrating why the inspection was unplanned. Alternatively, this notification including the written documentation may be made in writing and sent by express mail so that it is received by the Administrator at least 7 days prior to the refilling.

(b) After installing the control equipment required to meet §60.112b(a)(2) (external floating roof), the owner or operator shall:

(1) Determine the gap areas and maximum gap widths, between the primary seal and the wall of the storage vessel and between the secondary seal and the wall of the storage vessel according to the following frequency.

(i) Measurements of gaps between the tank wall and the primary seal (seal gaps) shall be performed during the hydrostatic testing of the vessel or within 60 days of the initial fill with VOL and at least once every 5 years thereafter.

(ii) Measurements of gaps between the tank wall and the secondary seal shall be performed within 60 days of the initial fill with VOL and at least once per year thereafter.

(iii) If any source ceases to store VOL for a period of 1 year or more, subsequent introduction of VOL into the vessel shall be considered an initial fill for the purposes of paragraphs (b)(1)(i) and (b)(1)(ii) of this section.

(2) Determine gap widths and areas in the primary and secondary seals individually by the following procedures:

(i) Measure seal gaps, if any, at one or more floating roof levels when the roof is floating off the roof leg supports.

(ii) Measure seal gaps around the entire circumference of the tank in each place where a 0.32-cm diameter uniform probe passes freely (without forcing or binding against seal) between the seal and the wall of the storage vessel and measure the circumferential distance of each such location.

(iii) The total surface area of each gap described in paragraph (b)(2)(ii) of this section shall be determined by using probes of various widths to measure accurately the actual distance from the tank wall to the seal and multiplying each such width by its respective circumferential distance.

(3) Add the gap surface area of each gap location for the primary seal and the secondary seal individually and divide the sum for each seal by the nominal diameter of the tank and compare each ratio to the respective standards in paragraph (b)(4) of this section.

(4) Make necessary repairs or empty the storage vessel within 45 days of identification in any inspection for seals not meeting the requirements listed in (b)(4) (i) and (ii) of this section:

(i) The accumulated area of gaps between the tank wall and the mechanical shoe or liquid-mounted primary seal shall not exceed 212 cm² per meter of tank diameter, and the width of any portion of any gap shall not exceed 3.81 cm.

(A) One end of the mechanical shoe is to extend into the stored liquid, and the other end is to extend a minimum vertical distance of 61 cm above the stored liquid surface.

(B) There are to be no holes, tears, or other openings in the shoe, seal fabric, or seal envelope.

(ii) The secondary seal is to meet the following requirements:

(A) The secondary seal is to be installed above the primary seal so that it completely covers the space between the roof edge and the tank wall except as provided in paragraph (b)(2)(iii) of this section.

(B) The accumulated area of gaps between the tank wall and the secondary seal shall not exceed 21.2 cm² per meter of tank diameter, and the width of any portion of any gap shall not exceed 1.27 cm.

(C) There are to be no holes, tears, or other openings in the seal or seal fabric.

(iii) If a failure that is detected during inspections required in paragraph (b)(1) of §60.113b(b) cannot be repaired within 45 days and if the vessel cannot be emptied within 45 days, a 30-day extension may be requested from the Administrator in the inspection report required in §60.115b(b)(4). Such extension request must include a demonstration of unavailability of alternate storage capacity and a specification of a schedule that will assure that the control equipment will be repaired or the vessel will be emptied as soon as possible.

(5) Notify the Administrator 30 days in advance of any gap measurements required by paragraph (b)(1) of this section to afford the Administrator the opportunity to have an observer present.

(6) Visually inspect the external floating roof, the primary seal, secondary seal, and fittings each time the vessel is emptied and degassed.

(i) If the external floating roof has defects, the primary seal has holes, tears, or other openings in the seal or the seal fabric, or the secondary seal has holes, tears, or other openings in the seal or the seal fabric, the owner or operator shall repair the items as necessary so that none of the conditions specified in this paragraph exist before filling or refilling the storage vessel with VOL.

(ii) For all the inspections required by paragraph (b)(6) of this section, the owner or operator shall notify the Administrator in writing at least 30 days prior to the filling or refilling of each storage vessel to afford the Administrator the opportunity to inspect the storage vessel prior to refilling. If the inspection required by paragraph (b)(6) of this section is not planned and the owner or operator could not have known about the inspection 30 days in advance of refilling the tank, the owner or operator shall notify the Administrator at least 7 days prior to the refilling of the storage vessel. Notification shall be made by telephone immediately followed by written documentation demonstrating why the inspection was unplanned. Alternatively, this notification including the written documentation may be made in writing and sent by express mail so that it is received by the Administrator at least 7 days prior to the refilling.

(c) The owner or operator of each source that is equipped with a closed vent system and control device as required in §60.112b (a)(3) or (b)(2) (other than a flare) is exempt from §60.8 of the General Provisions and shall meet the following requirements.

(1) Submit for approval by the Administrator as an attachment to the notification required by §60.7(a)(1) or, if the facility is exempt from §60.7(a)(1), as an attachment to the notification required by §60.7(a)(2), an operating plan containing the information listed below.

(i) Documentation demonstrating that the control device will achieve the required control efficiency during maximum loading conditions. This documentation is to include a description of the gas stream which enters the control device, including flow and VOC content under varying liquid level conditions (dynamic and static) and manufacturer's design specifications for the control device. If the control device or the closed vent capture system receives vapors, gases, or liquids other than fuels from sources that are not designated sources under this subpart, the efficiency demonstration is to include consideration of all vapors, gases, and liquids received by the closed vent capture system and control device. If an enclosed combustion device with a minimum residence time of 0.75 seconds and a minimum temperature of 816 °C is used to meet the 95 percent requirement, documentation that those conditions will exist is sufficient to meet the requirements of this paragraph.

(ii) A description of the parameter or parameters to be monitored to ensure that the control device will be operated in conformance with its design and an explanation of the criteria used for selection of that parameter (or parameters).

(2) Operate the closed vent system and control device and monitor the parameters of the closed vent system and control device in accordance with the operating plan submitted to the Administrator in accordance with paragraph (c)(1) of this section, unless the plan was modified by the Administrator during the review process. In this case, the modified plan applies.

(d) The owner or operator of each source that is equipped with a closed vent system and a flare to meet the requirements in §60.112b (a)(3) or (b)(2) shall meet the requirements as specified in the general control device requirements, §60.18 (e) and (f).

§60.114b Alternative means of emission limitation.

(a) If, in the Administrator's judgment, an alternative means of emission limitation will achieve a reduction in emissions at least equivalent to the reduction in emissions achieved by any requirement in §60.112b, the Administrator will publish in the FEDERAL REGISTER a notice permitting the use of the alternative means for purposes of compliance with that requirement.

(b) Any notice under paragraph (a) of this section will be published only after notice and an opportunity for a hearing.

(c) Any person seeking permission under this section shall submit to the Administrator a written application including:

(1) An actual emissions test that uses a full-sized or scale-model storage vessel that accurately collects and measures all VOC emissions from a given control device and that accurately simulates wind and accounts for other emission variables such as temperature and barometric pressure.

(2) An engineering evaluation that the Administrator determines is an accurate method of determining equivalence.

(d) The Administrator may condition the permission on requirements that may be necessary to ensure operation and maintenance to achieve the same emissions reduction as specified in §60.112b.

§60.115b Reporting and recordkeeping requirements.

The owner or operator of each storage vessel as specified in §60.112b(a) shall keep records and furnish reports as required by paragraphs (a), (b), or (c) of this section depending upon the control equipment installed to meet the requirements of §60.112b. The owner or operator shall keep copies of all reports and records required by this section, except for the record required by (c)(1), for at least 2 years. The record required by (c)(1) will be kept for the life of the control equipment.

(a) After installing control equipment in accordance with §60.112b(a)(1) (fixed roof and internal floating roof), the owner or operator shall meet the following requirements.

(1) Furnish the Administrator with a report that describes the control equipment and certifies that the control equipment meets the specifications of §60.112b(a)(1) and §60.113b(a)(1). This report shall be an attachment to the notification required by §60.7(a)(3).

(2) Keep a record of each inspection performed as required by §60.113b (a)(1), (a)(2), (a)(3), and (a)(4). Each record shall identify the storage vessel on which the inspection was performed and shall contain the date the vessel was inspected and the observed condition of each component of the control equipment (seals, internal floating roof, and fittings).

(3) If any of the conditions described in §60.113b(a)(2) are detected during the annual visual inspection required by §60.113b(a)(2), a report shall be furnished to the Administrator within 30 days of the inspection. Each report shall identify the storage vessel, the nature of the defects, and the date the storage vessel was emptied or the nature of and date the repair was made.

(4) After each inspection required by §60.113b(a)(3) that finds holes or tears in the seal or seal fabric, or defects in the internal floating roof, or other control equipment defects listed in §60.113b(a)(3)(ii), a report shall be furnished to the Administrator within 30 days of the inspection. The

report shall identify the storage vessel and the reason it did not meet the specifications of §61.112b(a)(1) or §60.113b(a)(3) and list each repair made.

(b) After installing control equipment in accordance with §61.112b(a)(2) (external floating roof), the owner or operator shall meet the following requirements.

(1) Furnish the Administrator with a report that describes the control equipment and certifies that the control equipment meets the specifications of §60.112b(a)(2) and §60.113b(b)(2), (b)(3), and (b)(4). This report shall be an attachment to the notification required by §60.7(a)(3).

(2) Within 60 days of performing the seal gap measurements required by §60.113b(b)(1), furnish the Administrator with a report that contains:

(i) The date of measurement.

(ii) The raw data obtained in the measurement.

(iii) The calculations described in §60.113b (b)(2) and (b)(3).

(3) Keep a record of each gap measurement performed as required by §60.113b(b). Each record shall identify the storage vessel in which the measurement was performed and shall contain:

(i) The date of measurement.

(ii) The raw data obtained in the measurement.

(iii) The calculations described in §60.113b (b)(2) and (b)(3).

(4) After each seal gap measurement that detects gaps exceeding the limitations specified by §60.113b(b)(4), submit a report to the Administrator within 30 days of the inspection. The report will identify the vessel and contain the information specified in paragraph (b)(2) of this section and the date the vessel was emptied or the repairs made and date of repair.

(c) After installing control equipment in accordance with §60.112b (a)(3) or (b)(1) (closed vent system and control device other than a flare), the owner or operator shall keep the following records.

(1) A copy of the operating plan.

(2) A record of the measured values of the parameters monitored in accordance with §60.113b(c)(2).

(d) After installing a closed vent system and flare to comply with §60.112b, the owner or operator shall meet the following requirements.

(1) A report containing the measurements required by §60.18(f) (1), (2), (3), (4), (5), and (6) shall be furnished to the Administrator as required by §60.8 of the General Provisions. This report shall be submitted within 6 months of the initial start-up date.

(2) Records shall be kept of all periods of operation during which the flare pilot flame is absent.

(3) Semiannual reports of all periods recorded under §60.115b(d)(2) in which the pilot flame was absent shall be furnished to the Administrator.

§60.116b Monitoring of operations.

(a) The owner or operator shall keep copies of all records required by this section, except for the record required by paragraph (b) of this section, for at least 2 years. The record required by paragraph (b) of this section will be kept for the life of the source.

(b) The owner or operator of each storage vessel as specified in §60.110b(a) shall keep readily accessible records showing the dimension of the storage vessel and an analysis showing the capacity of the storage vessel.

(c) Except as provided in paragraphs (f) and (g) of this section, the owner or operator of each storage vessel either with a design capacity greater than or equal to 151 m³ storing a liquid with a maximum true vapor pressure greater than or equal to 3.5 kPa or with a design capacity greater than or equal to 75 m³ but less than 151 m³ storing a liquid with a maximum true vapor pressure greater than or equal to 15.0 kPa shall maintain a record of the VOL stored, the period of storage, and the maximum true vapor pressure of that VOL during the respective storage period.

(d) Except as provided in paragraph (g) of this section, the owner or operator of each storage vessel either with a design capacity greater than or equal to 151 m³ storing a liquid with a maximum true vapor pressure that is normally less than 5.2 kPa or with a design capacity greater than or equal to 75 m³ but less than 151 m³ storing a liquid with a maximum true vapor pressure that is normally less than 27.6 kPa shall notify the Administrator within 30 days when the maximum true vapor pressure of the liquid exceeds the respective maximum true vapor pressure values for each volume range.

(e) Available data on the storage temperature may be used to determine the maximum true vapor pressure as determined below.

(1) For vessels operated above or below ambient temperatures, the maximum true vapor pressure is calculated based upon the highest expected calendar-month average of the storage temperature. For vessels operated at ambient temperatures, the maximum true vapor pressure is calculated based upon the maximum local monthly average ambient temperature as reported by the National Weather Service.

(2) For crude oil or refined petroleum products the vapor pressure may be obtained by the following:

(i) Available data on the Reid vapor pressure and the maximum expected storage temperature based on the highest expected calendar-month average temperature of the stored product may be used to determine the maximum true vapor pressure from nomographs contained in API Bulletin 2517 (incorporated by reference—see §60.17), unless the Administrator specifically requests that the liquid be sampled, the actual storage temperature determined, and the Reid vapor pressure determined from the sample(s).

(ii) The true vapor pressure of each type of crude oil with a Reid vapor pressure less than 13.8 kPa or with physical properties that preclude determination by the recommended method is to be determined from available data and recorded if the estimated maximum true vapor pressure is greater than 3.5 kPa.

(3) For other liquids, the vapor pressure:

(i) May be obtained from standard reference texts, or

(ii) Determined by ASTM D2879-83, 96, or 97 (incorporated by reference—see §60.17); or

(iii) Measured by an appropriate method approved by the Administrator; or

(iv) Calculated by an appropriate method approved by the Administrator.

(f) The owner or operator of each vessel storing a waste mixture of indeterminate or variable composition shall be subject to the following requirements.

(1) Prior to the initial filling of the vessel, the highest maximum true vapor pressure for the range of anticipated liquid compositions to be stored will be determined using the methods described in paragraph (e) of this section.

(2) For vessels in which the vapor pressure of the anticipated liquid composition is above the cutoff for monitoring but below the cutoff for controls as defined in §60.112b(a), an initial physical test of the vapor pressure is required; and a physical test at least once every 6 months thereafter is required as determined by the following methods:

(i) ASTM D2879-83, 96, or 97 (incorporated by reference—see §60.17); or

(ii) ASTM D323-82 or 94 (incorporated by reference—see §60.17); or

(iii) As measured by an appropriate method as approved by the Administrator.

(g) The owner or operator of each vessel equipped with a closed vent system and control device meeting the specification of §60.112b or with emissions reductions equipment as specified in 40 CFR 65.42(b)(4), (b)(5), (b)(6), or (c) is exempt from the requirements of paragraphs (c) and (d) of this section.

[52 FR 11429, Apr. 8, 1987, as amended at 65 FR 61756, Oct. 17, 2000; 65 FR 78276, Dec. 14, 2000; 68 FR 59333, Oct. 15, 2003]

§60.117b Delegation of authority.

(a) In delegating implementation and enforcement authority to a State under section 111(c) of the Act, the authorities contained in paragraph (b) of this section shall be retained by the Administrator and not transferred to a State.

(b) Authorities which will not be delegated to States: §§60.111b(f)(4), 60.114b, 60.116b(e)(3)(iii), 60.116b(e)(3)(iv), and 60.116b(f)(2)(iii).

[52 FR 11429, Apr. 8, 1987, as amended at 52 FR 22780, June 16, 1987]

Appendix D

Subpart Y—Standards of Performance for Coal Preparation and Processing Plants

Contents

[§60.250 Applicability and designation of affected facility.](#)

[§60.251 Definitions.](#)

[§60.252 Standards for thermal dryers.](#)

[§60.253 Standards for pneumatic coal-cleaning equipment.](#)

[§60.254 Standards for coal processing and conveying equipment, coal storage systems, transfer and loading systems, and open storage piles.](#)

[§60.255 Performance tests and other compliance requirements.](#)

[§60.256 Continuous monitoring requirements.](#)

[§60.257 Test methods and procedures.](#)

[§60.258 Reporting and recordkeeping.](#)

SOURCE: 74 FR 51977, Oct. 8, 2009, unless otherwise noted.

[↑ Back to Top](#)

§60.250 Applicability and designation of affected facility.

(a) The provisions of this subpart apply to affected facilities in coal preparation and processing plants that process more than 181 megagrams (Mg) (200 tons) of coal per day.

(b) The provisions in §§60.251, 60.252(a), 60.253(a), 60.254(a), 60.255(a), and 60.256(a) of this subpart are applicable to any of the following affected facilities that commenced construction, reconstruction or modification after October 27, 1974, and on or before April 28, 2008: Thermal dryers, pneumatic coal-cleaning equipment (air tables), coal processing and conveying equipment (including breakers and crushers), and coal storage systems, transfer and loading systems.

(c) The provisions in §§60.251, 60.252(b)(1) and (c), 60.253(b), 60.254(b), 60.255(b) through (h), 60.256(b) and (c), 60.257, and 60.258 of this subpart are applicable to any of the following affected facilities that commenced construction, reconstruction or modification after April 28, 2008, and on or before May 27, 2009: Thermal dryers, pneumatic coal-cleaning equipment (air tables), coal processing and conveying equipment (including breakers and crushers), and coal storage systems, transfer and loading systems.

(d) The provisions in §§60.251, 60.252(b)(1) through (3), and (c), 60.253(b), 60.254(b) and (c), 60.255(b) through (h), 60.256(b) and (c), 60.257, and 60.258 of this subpart are applicable to any of the following affected facilities that commenced construction, reconstruction or modification after May 27, 2009: Thermal dryers, pneumatic coal-cleaning equipment (air tables), coal processing and conveying equipment (including breakers and crushers), coal storage systems, transfer and loading systems, and open storage piles.

[↑ Back to Top](#)

§60.251 Definitions.

As used in this subpart, all terms not defined herein have the meaning given them in the Clean Air Act (Act) and in subpart A of this part.

(a) *Anthracite* means coal that is classified as anthracite according to the American Society of Testing and Materials in ASTM D388 (incorporated by reference, see §60.17).

(b) *Bag leak detection system* means a system that is capable of continuously monitoring relative particulate matter (dust loadings) in the exhaust of a fabric filter to detect bag leaks and other upset conditions. A bag leak detection system includes, but is not limited to, an instrument that operates on triboelectric, light scattering, light transmittance, or other effect to continuously monitor relative particulate matter loadings.

(c) *Bituminous coal* means solid fossil fuel classified as bituminous coal by ASTM D388 (incorporated by reference—see §60.17).

(d) *Coal* means:

(1) For units constructed, reconstructed, or modified on or before May 27, 2009, all solid fossil fuels classified as anthracite, bituminous, subbituminous, or lignite by ASTM D388 (incorporated by reference—see §60.17).

(2) For units constructed, reconstructed, or modified after May 27, 2009, all solid fossil fuels classified as anthracite, bituminous, subbituminous, or lignite by ASTM D388 (incorporated by reference—see §60.17), and coal refuse.

(e) *Coal preparation and processing plant* means any facility (excluding underground mining operations) which prepares coal by one or more of the following processes: breaking, crushing, screening, wet or dry cleaning, and thermal drying.

(f) *Coal processing and conveying equipment* means any machinery used to reduce the size of coal or to separate coal from refuse, and the equipment used to convey coal to or remove coal and refuse from the machinery. This includes, but is not limited to, breakers, crushers, screens, and conveyor belts. Equipment located at the mine face is not considered to be part of the coal preparation and processing plant.

(g) *Coal refuse* means waste products of coal mining, physical coal cleaning, and coal preparation operations (e.g., culm, gob, etc.) containing coal, matrix material, clay, and other organic and inorganic material.

(h) *Coal storage system* means any facility used to store coal except for open storage piles.

(i) *Design controlled potential PM emissions rate* means the theoretical particulate matter (PM) emissions (Mg) that would result from the operation of a control device at its design emissions rate (grams per dry standard cubic meter (g/dscm)), multiplied by the maximum design flow rate (dry standard cubic meter per minute (dscm/min)), multiplied by 60 (minutes per hour (min/hr)), multiplied by 8,760 (hours per year (hr/yr)), divided by 1,000,000 (megagrams per gram (Mg/g)).

(j) *Indirect thermal dryer* means a thermal dryer that reduces the moisture content of coal through indirect heating of the coal through contact with a heat transfer medium. If the source of heat (the source of combustion or furnace) is subject to another subpart of this part, then the furnace and the associated emissions are not part of the affected facility. However, if the source of heat is not subject to another subpart of this part, then the furnace and the associated emissions are part of the affected facility.

(k) *Lignite* means coal that is classified as lignite A or B according to the American Society of Testing and Materials in ASTM D388 (incorporated by reference, see §60.17).

(l) *Mechanical vent* means any vent that uses a powered mechanical drive (machine) to induce air flow.

(m) *Open storage pile* means any facility, including storage area, that is not enclosed that is used to store coal, including the equipment used in the loading, unloading, and conveying operations of the facility.

(n) *Operating day* means a 24-hour period between 12 midnight and the following midnight during which coal is prepared or processed at any time by the affected facility. It is not necessary that coal be prepared or processed the entire 24-hour period.

(o) *Pneumatic coal-cleaning equipment* means:

(1) For units constructed, reconstructed, or modified on or before May 27, 2009, any facility which classifies bituminous coal by size or separates bituminous coal from refuse by application of air stream(s).

(2) For units constructed, reconstructed, or modified after May 27, 2009, any facility which classifies coal by size or separates coal from refuse by application of air stream(s).

(p) *Potential combustion concentration* means the theoretical emissions (nanograms per joule (ng/J) or pounds per million British thermal units (lb/MMBtu) heat input) that would result from combustion of a fuel in an uncleaned state without emission control systems, as determined using Method 19 of appendix A-7 of this part.

(q) *Subbituminous coal* means coal that is classified as subbituminous A, B, or C according to the American Society of Testing and Materials in ASTM D388 (incorporated by reference, see §60.17).

(r) *Thermal dryer* means:

(1) For units constructed, reconstructed, or modified on or before May 27, 2009, any facility in which the moisture content of bituminous coal is reduced by contact with a heated gas stream which is exhausted to the atmosphere.

(2) For units constructed, reconstructed, or modified after May 27, 2009, any facility in which the moisture content of coal is reduced by either contact with a heated gas stream which is exhausted to the atmosphere or through indirect heating of the coal through contact with a heated heat transfer medium.

(s) *Transfer and loading system* means any facility used to transfer and load coal for shipment.

 [Back to Top](#)

§60.252 Standards for thermal dryers.

(a) On and after the date on which the performance test is conducted or required to be completed under §60.8, whichever date comes first, an owner or operator of a thermal dryer constructed, reconstructed, or modified on or before April 28, 2008, subject to the provisions of this subpart must meet the requirements in paragraphs (a)(1) and (a)(2) of this section.

(1) The owner or operator shall not cause to be discharged into the atmosphere from the thermal dryer any gases which contain PM in excess of 0.070 g/dscm (0.031 grains per dry standard cubic feet (gr/dscf)); and

(2) The owner or operator shall not cause to be discharged into the atmosphere from the thermal dryer any gases which exhibit 20 percent opacity or greater.

(b) Except as provided in paragraph (c) of this section, on and after the date on which the performance test is conducted or required to be completed under §60.8, whichever date comes first, an owner or operator of a thermal dryer constructed, reconstructed, or modified after April 28, 2008, subject to the provisions of this subpart must meet the applicable standards for PM and opacity, as specified in paragraph (b)(1) of this section. In addition, and except as provided in paragraph (c) of this section, on and after the date on which the performance test is conducted or required to be completed under §60.8, whichever date comes first, an owner or operator of a thermal dryer constructed, reconstructed, or modified after May 29, 2009, subject to the provisions of this subpart must also meet the applicable standards for sulfur dioxide (SO₂), and combined nitrogen oxides (NO_x) and carbon monoxide (CO) as specified in paragraphs (b)(2) and (b)(3) of this section.

(1) The owner or operator must meet the requirements for PM emissions in paragraphs (b)(1)(i) through (iii) of this section, as applicable to the affected facility.

(i) For each thermal dryer constructed or reconstructed after April 28, 2008, the owner or operator must meet the requirements of (b)(1)(i)(A) and (b)(1)(i)(B).

(A) The owner or operator must not cause to be discharged into the atmosphere from the thermal dryer any gases that contain PM in excess of 0.023 g/dscm (0.010 grains per dry standard cubic feet (gr/dscf)); and

(B) The owner or operator must not cause to be discharged into the atmosphere from the thermal dryer any gases that exhibit 10 percent opacity or greater.

(ii) For each thermal dryer modified after April 28, 2008, the owner or operator must meet the requirements of paragraphs (b)(1)(ii)(A) and (b)(1)(ii)(B) of this section.

(A) The owner or operator must not cause to be discharged to the atmosphere from the affected facility any gases which contain PM in excess of 0.070 g/dscm (0.031 gr/dscf); and

(B) The owner or operator must not cause to be discharged into the atmosphere from the affected facility any gases which exhibit 20 percent opacity or greater.

(2) Except as provided in paragraph (b)(2)(iii) of this section, for each thermal dryer constructed, reconstructed, or modified after May 27, 2009, the owner or operator must meet the requirements for SO₂ emissions in either paragraph (b)(2)(i) or (b)(2)(ii) of this section.

(i) The owner or operator must not cause to be discharged into the atmosphere from the affected facility any gases that contain SO₂ in excess of 85 ng/J (0.20 lb/MMBtu) heat input; or

(ii) The owner or operator must not cause to be discharged into the atmosphere from the affected facility any gases that either contain SO₂ in excess of 520 ng/J (1.20 lb/MMBtu) heat input or contain SO₂ in excess of 10 percent of the potential combustion concentration (*i.e.*, the facility must achieve at least a 90 percent reduction of the potential combustion concentration and may not exceed a maximum emissions rate of 1.2 lb/MMBtu (520 ng/J)).

(iii) Thermal dryers that receive all of their thermal input from a source other than coal or residual oil, that receive all of their thermal input from a source subject to an SO₂ limit under another subpart of this part, or that use waste heat or residual from the combustion of coal or residual oil as their only thermal input are not subject to the SO₂ limits of this section.

(3) Except as provided in paragraph (b)(3)(iii) of this section, the owner or operator must meet the requirements for combined NO_x and CO emissions in paragraph (b)(3)(i) or (b)(3)(ii) of this section, as applicable to the affected facility.

(i) For each thermal dryer constructed after May 27, 2009, the owner or operator must not cause to be discharged into the atmosphere from the affected facility any gases which contain a combined concentration of NO_x and CO in excess of 280 ng/J (0.65 lb/MMBtu) heat input.

(ii) For each thermal dryer reconstructed or modified after May 27, 2009, the owner or operator must not cause to be discharged into the atmosphere from the affected facility any gases which contain combined concentration of NO_x and CO in excess of 430 ng/J (1.0 lb/MMBtu) heat input.

(iii) Thermal dryers that receive all of their thermal input from a source other than coal or residual oil, that receive all of their thermal input from a source subject to a NO_x limit and/or CO limit under another subpart of this part, or that use waste heat or residual from the combustion of coal or residual oil as their only thermal input, are not subject to the combined NO_x and CO limits of this section.

(c) Thermal dryers receiving all of their thermal input from an affected facility covered under another 40 CFR Part 60 subpart must meet the applicable requirements in that subpart but are not subject to the requirements in this subpart.

 [Back to Top](#)

§60.253 Standards for pneumatic coal-cleaning equipment.

(a) On and after the date on which the performance test is conducted or required to be completed under §60.8, whichever date comes first, an owner or operator of pneumatic coal-cleaning equipment constructed, reconstructed, or modified on or before April 28, 2008, must meet the requirements of paragraphs (a)(1) and (a)(2) of this section.

(1) The owner or operator must not cause to be discharged into the atmosphere from the pneumatic coal-cleaning equipment any gases that contain PM in excess of 0.040 g/dscm (0.017 gr/dscf); and

(2) The owner or operator must not cause to be discharged into the atmosphere from the pneumatic coal-cleaning equipment any gases that exhibit 10 percent opacity or greater.

(b) On and after the date on which the performance test is conducted or required to be completed under §60.8, whichever date comes first, an owner or operator of pneumatic coal-cleaning equipment constructed, reconstructed, or modified after April 28, 2008, must meet the requirements in paragraphs (b)(1) and (b)(2) of this section.

(1) The owner or operator must not cause to be discharged into the atmosphere from the pneumatic coal-cleaning equipment any gases that contain PM in excess or 0.023 g/dscm (0.010 gr/dscf); and

(2) The owner or operator must not cause to be discharged into the atmosphere from the pneumatic coal-cleaning equipment any gases that exhibit greater than 5 percent opacity.

§60.254 Standards for coal processing and conveying equipment, coal storage systems, transfer and loading systems, and open storage piles.

(a) On and after the date on which the performance test is conducted or required to be completed under §60.8, whichever date comes first, an owner or operator shall not cause to be discharged into the atmosphere from any coal processing and conveying equipment, coal storage system, or coal transfer and loading system processing coal constructed, reconstructed, or modified on or before April 28, 2008, gases which exhibit 20 percent opacity or greater.

(b) On and after the date on which the performance test is conducted or required to be completed under §60.8, whichever date comes first, an owner or operator of any coal processing and conveying equipment, coal storage system, or coal transfer and loading system processing coal constructed, reconstructed, or modified after April 28, 2008, must meet the requirements in paragraphs (b)(1) through (3) of this section, as applicable to the affected facility.

(1) Except as provided in paragraph (b)(3) of this section, the owner or operator must not cause to be discharged into the atmosphere from the affected facility any gases which exhibit 10 percent opacity or greater.

(2) The owner or operator must not cause to be discharged into the atmosphere from any mechanical vent on an affected facility gases which contain particulate matter in excess of 0.023 g/dscm (0.010 gr/dscf).

(3) Equipment used in the loading, unloading, and conveying operations of open storage piles are not subject to the opacity limitations of paragraph (b)(1) of this section.

(c) The owner or operator of an open storage pile, which includes the equipment used in the loading, unloading, and conveying operations of the affected facility, constructed, reconstructed, or modified after May 27, 2009, must prepare and operate in accordance with a submitted fugitive coal dust emissions control plan that is appropriate for the site conditions as specified in paragraphs (c)(1) through (6) of this section.

(1) The fugitive coal dust emissions control plan must identify and describe the control measures the owner or operator will use to minimize fugitive coal dust emissions from each open storage pile.

(2) For open coal storage piles, the fugitive coal dust emissions control plan must require that one or more of the following control measures be used to minimize to the greatest extent practicable fugitive coal dust: Locating the source inside a partial enclosure, installing and operating a water spray or fogging system, applying appropriate chemical dust suppression agents on the source (when the provisions of paragraph (c)(6) of this section are met), use of a wind barrier, compaction, or use of a vegetative cover. The owner or operator must select, for inclusion in the fugitive coal dust emissions control plan, the control measure or measures listed in this paragraph that are most appropriate for site conditions. The plan must also explain how the measure or measures selected are applicable and appropriate for site conditions. In addition, the plan must be revised as needed to reflect any changing conditions at the source.

(3) Any owner or operator of an affected facility that is required to have a fugitive coal dust emissions control plan may petition the Administrator to approve, for inclusion in the plan for the affected facility, alternative control measures other than those specified in paragraph (c)(2) of this section as specified in paragraphs (c)(3)(i) through (iv) of this section.

(i) The petition must include a description of the alternative control measures, a copy of the fugitive coal dust emissions control plan for the affected facility that includes the alternative control measures, and information sufficient for EPA to evaluate the demonstrations required by paragraph (c)(3)(ii) of this section.

(ii) The owner or operator must either demonstrate that the fugitive coal dust emissions control plan that includes the alternate control measures will provide equivalent overall environmental protection or demonstrate that it is either economically or technically infeasible for the affected facility to use the control measures specifically identified in paragraph (c)(2).

(iii) While the petition is pending, the owner or operator must comply with the fugitive coal dust emissions control plan including the alternative control measures submitted with the petition. Operation in accordance with the plan submitted with the petition shall be deemed to constitute compliance with the requirement to operate in accordance with a fugitive coal dust emissions control plan that contains one of the control measures specifically identified in paragraph (c)(2) of this section while the petition is pending.

(iv) If the petition is approved by the Administrator, the alternative control measures will be approved for inclusion in the fugitive coal dust emissions control plan for the affected facility. In lieu of amending this subpart, a letter will be sent to the facility describing the specific control measures approved. The facility shall make any such letters and the applicable fugitive coal dust emissions control plan available to the public. If the Administrator determines it is appropriate, the conditions and requirements of the letter can be reviewed and changed at any point.

(4) The owner or operator must submit the fugitive coal dust emissions control plan to the Administrator or delegated authority as specified in paragraphs (c)(4)(i) and (c)(4)(ii) of this section.

(i) The plan must be submitted to the Administrator or delegated authority prior to startup of the new, reconstructed, or modified affected facility, or 30 days after the effective date of this rule, whichever is later.

(ii) The plan must be revised as needed to reflect any changing conditions at the source. Such revisions must be dated and submitted to the Administrator or delegated authority before a source can operate pursuant to these revisions. The Administrator or delegated authority may also object to such revisions as specified in paragraph (c)(5) of this section.

(5) The Administrator or delegated authority may object to the fugitive coal dust emissions control plan as specified in paragraphs (c)(5)(i) and (c)(5)(ii) of this section.

(i) The Administrator or delegated authority may object to any fugitive coal dust emissions control plan that it has determined does not meet the requirements of paragraphs (c)(1) and (c)(2) of this section.

(ii) If an objection is raised, the owner or operator, within 30 days from receipt of the objection, must submit a revised fugitive coal dust emissions control plan to the Administrator or delegated authority. The owner or operator must operate in accordance with the revised fugitive coal dust emissions control plan. The Administrator or delegated authority retain the right, under paragraph (c)(5) of this section, to object to the revised control plan if it determines the plan does not meet the requirements of paragraphs (c)(1) and (c)(2) of this section.

(6) Where appropriate chemical dust suppression agents are selected by the owner or operator as a control measure to minimize fugitive coal dust emissions, (1) only chemical dust suppressants with Occupational Safety and Health Administration (OSHA)-compliant material safety data sheets (MSDS) are to be allowed; (2) the MSDS must be included in the fugitive coal dust emissions control plan; and (3) the owner or operator must consider and document in the fugitive coal dust emissions control plan the site-specific impacts associated with the use of such chemical dust suppressants.

§60.255 Performance tests and other compliance requirements.

(a) An owner or operator of each affected facility that commenced construction, reconstruction, or modification on or before April 28, 2008, must conduct all performance tests required by §60.8 to demonstrate compliance with the applicable emission standards using the methods identified in §60.257.

(b) An owner or operator of each affected facility that commenced construction, reconstruction, or modification after April 28, 2008, must conduct performance tests according to the requirements of §60.8 and the methods identified in §60.257 to demonstrate compliance with the applicable emissions standards in this subpart as specified in paragraphs (b)(1) and (2) of this section.

(1) For each affected facility subject to a PM, SO₂, or combined NO_x and CO emissions standard, an initial performance test must be performed. Thereafter, a new performance test must be conducted according to the requirements in paragraphs (b)(1)(i) through (iii) of this section, as applicable.

(i) If the results of the most recent performance test demonstrate that emissions from the affected facility are greater than 50 percent of the applicable emissions standard, a new performance test must be conducted within 12 calendar months of the date that the previous performance test was required to be completed.

(ii) If the results of the most recent performance test demonstrate that emissions from the affected facility are 50 percent or less of the applicable emissions standard, a new performance test must be conducted within 24 calendar months of the date that the previous performance test was required to be completed.

(iii) An owner or operator of an affected facility that has not operated for the 60 calendar days prior to the due date of a performance test is not required to perform the subsequent performance test until 30 calendar days after the next operating day.

(2) For each affected facility subject to an opacity standard, an initial performance test must be performed. Thereafter, a new performance test must be conducted according to the requirements in paragraphs (b)(2)(i) through (iii) of this section, as applicable, except as provided for in paragraphs (e) and (f) of this section. Performance test and other compliance requirements for coal truck dump operations are specified in paragraph (h) of this section.

(i) If any 6-minute average opacity reading in the most recent performance test exceeds half the applicable opacity limit, a new performance test must be conducted within 90 operating days of the date that the previous performance test was required to be completed.

(ii) If all 6-minute average opacity readings in the most recent performance test are equal to or less than half the applicable opacity limit, a new performance test must be conducted within 12 calendar months of the date that the previous performance test was required to be completed.

(iii) An owner or operator of an affected facility continuously monitoring scrubber parameters as specified in §60.256(b)(2) is exempt from the requirements in paragraphs (b)(2)(i) and (ii) if opacity performance tests are conducted concurrently with (or within a 60-minute period of) PM performance tests.

(c) If any affected coal processing and conveying equipment (e.g., breakers, crushers, screens, conveying systems), coal storage systems, or coal transfer and loading systems that commenced construction, reconstruction, or modification after April 28, 2008, are enclosed in a building, and

emissions from the building do not exceed any of the standards in §60.254 that apply to the affected facility, then the facility shall be deemed to be in compliance with such standards.

(d) An owner or operator of an affected facility (other than a thermal dryer) that commenced construction, reconstruction, or modification after April 28, 2008, is subject to a PM emission standard and uses a control device with a design controlled potential PM emissions rate of 1.0 Mg (1.1 tons) per year or less is exempted from the requirements of paragraphs (b)(1)(i) and (ii) of this section provided that the owner or operator meets all of the conditions specified in paragraphs (d)(1) through (3) of this section. This exemption does not apply to thermal dryers.

(1) PM emissions, as determined by the most recent performance test, are less than or equal to the applicable limit,

(2) The control device manufacturer's recommended maintenance procedures are followed, and

(3) All 6-minute average opacity readings from the most recent performance test are equal to or less than half the applicable opacity limit or the monitoring requirements in paragraphs (e) or (f) of this section are followed.

(e) For an owner or operator of a group of up to five of the same type of affected facilities that commenced construction, reconstruction, or modification after April 28, 2008, that are subject to PM emissions standards and use identical control devices, the Administrator or delegated authority may allow the owner or operator to use a single PM performance test for one of the affected control devices to demonstrate that the group of affected facilities is in compliance with the applicable emissions standards provided that the owner or operator meets all of the conditions specified in paragraphs (e)(1) through (3) of this section.

(1) PM emissions from the most recent performance test for each individual affected facility are 90 percent or less of the applicable PM standard;

(2) The manufacturer's recommended maintenance procedures are followed for each control device; and

(3) A performance test is conducted on each affected facility at least once every 5 calendar years.

(f) As an alternative to meeting the requirements in paragraph (b)(2) of this section, an owner or operator of an affected facility that commenced construction, reconstruction, or modification after April 28, 2008, may elect to comply with the requirements in paragraph (f)(1) or (f)(2) of this section.

(1) Monitor visible emissions from each affected facility according to the requirements in paragraphs (f)(1)(i) through (iii) of this section.

(i) Conduct one daily 15-second observation each operating day for each affected facility (during normal operation) when the coal preparation and processing plant is in operation. Each observation must be recorded as either visible emissions observed or no visible emissions observed. Each observer determining the presence of visible emissions must meet the training requirements specified in §2.3 of Method 22 of appendix A-7 of this part. If visible emissions are observed during any 15-second observation, the owner or operator must adjust the operation of the affected facility and demonstrate within 24 hours that no visible emissions are observed from the affected facility. If visible emissions are observed, a Method 9, of appendix A-4 of this part, performance test must be conducted within 45 operating days.

(ii) Conduct monthly visual observations of all process and control equipment. If any deficiencies are observed, the necessary maintenance must be performed as expeditiously as possible.

(iii) Conduct a performance test using Method 9 of appendix A-4 of this part at least once every 5 calendar years for each affected facility.

(2) Prepare a written site-specific monitoring plan for a digital opacity compliance system for approval by the Administrator or delegated authority. The plan shall require observations of at least one digital image every 15 seconds for 10-minute periods (during normal operation) every operating day. An approvable monitoring plan must include a demonstration that the occurrences of visible emissions are not in excess of 5 percent of the observation period. For reference purposes in preparing the monitoring plan, see OAQPS "Determination of Visible Emission Opacity from Stationary Sources Using Computer-Based Photographic Analysis Systems." This document is available from the U.S. Environmental Protection Agency (U.S. EPA); Office of Air Quality and Planning Standards; Sector Policies and Programs Division; Measurement Group (D243-02), Research Triangle Park, NC 27711. This document is also available on the Technology Transfer Network (TTN) under Emission Measurement Center Preliminary Methods. The monitoring plan approved by the Administrator or delegated authority shall be implemented by the owner or operator.

(g) As an alternative to meeting the requirements in paragraph (b)(2) of this section, an owner or operator of an affected facility that commenced construction, reconstruction, or modification after April 28, 2008, subject to a visible emissions standard under this subpart may install, operate, and maintain a continuous opacity monitoring system (COMS). Each COMS used to comply with provisions of this subpart must be installed, calibrated, maintained, and continuously operated according to the requirements in paragraphs (g)(1) and (2) of this section.

(1) The COMS must meet Performance Specification 1 in 40 CFR part 60, appendix B.

(2) The COMS must comply with the quality assurance requirements in paragraphs (g)(2)(i) through (v) of this section.

(i) The owner or operator must automatically (intrinsic to the opacity monitor) check the zero and upscale (span) calibration drifts at least once daily. For particular COMS, the acceptable range of zero and upscale calibration materials is as defined in the applicable version of Performance Specification 1 in 40 CFR part 60, appendix B.

(ii) The owner or operator must adjust the zero and span whenever the 24-hour zero drift or 24-hour span drift exceeds 4 percent opacity. The COMS must allow for the amount of excess zero and span drift measured at the 24-hour interval checks to be recorded and quantified. The optical surfaces exposed to the effluent gases must be cleaned prior to performing the zero and span drift adjustments, except for systems using automatic zero adjustments. For systems using automatic zero adjustments, the optical surfaces must be cleaned when the cumulative automatic zero compensation exceeds 4 percent opacity.

(iii) The owner or operator must apply a method for producing a simulated zero opacity condition and an upscale (span) opacity condition using a certified neutral density filter or other related technique to produce a known obscuration of the light beam. All procedures applied must provide a system check of the analyzer internal optical surfaces and all electronic circuitry including the lamp and photodetector assembly.

(iv) Except during periods of system breakdowns, repairs, calibration checks, and zero and span adjustments, the COMS must be in continuous operation and must complete a minimum of one cycle of sampling and analyzing for each successive 10-second period and one cycle of data recording for each successive 6-minute period.

(v) The owner or operator must reduce all data from the COMS to 6-minute averages. Six-minute opacity averages must be calculated from 36 or more data points equally spaced over each 6-minute period. Data recorded during periods of system breakdowns, repairs, calibration checks, and zero and span adjustments must not be included in the data averages. An arithmetic or integrated average of all data may be used.

(h) The owner or operator of each affected coal truck dump operation that commenced construction, reconstruction, or modification after April 28, 2008, must meet the requirements specified in paragraphs (h)(1) through (3) of this section.

(1) Conduct an initial performance test using Method 9 of appendix A-4 of this part according to the requirements in paragraphs (h)(1)(i) and(ii).

(i) Opacity readings shall be taken during the duration of three separate truck dump events. Each truck dump event commences when the truck bed begins to elevate and concludes when the truck bed returns to a horizontal position.

(ii) Compliance with the applicable opacity limit is determined by averaging all 15-second opacity readings made during the duration of three separate truck dump events.

(2) Conduct monthly visual observations of all process and control equipment. If any deficiencies are observed, the necessary maintenance must be performed as expeditiously as possible.

(3) Conduct a performance test using Method 9 of appendix A-4 of this part at least once every 5 calendar years for each affected facility.

 [Back to Top](#)

§60.256 Continuous monitoring requirements.

(a) The owner or operator of each affected facility constructed, reconstructed, or modified on or before April 28, 2008, must meet the monitoring requirements specified in paragraphs (a)(1) and (2) of this section, as applicable to the affected facility.

(1) The owner or operator of any thermal dryer shall install, calibrate, maintain, and continuously operate monitoring devices as follows:

(i) A monitoring device for the measurement of the temperature of the gas stream at the exit of the thermal dryer on a continuous basis. The monitoring device is to be certified by the manufacturer to be accurate within ± 1.7 °C (± 3 °F).

(ii) For affected facilities that use wet scrubber emission control equipment:

(A) A monitoring device for the continuous measurement of the pressure loss through the venturi constriction of the control equipment. The monitoring device is to be certified by the manufacturer to be accurate within ± 1 inch water gauge.

(B) A monitoring device for the continuous measurement of the water supply pressure to the control equipment. The monitoring device is to be certified by the manufacturer to be accurate within ± 5 percent of design water supply pressure. The pressure sensor or tap must be located close to the water discharge point. The Administrator shall have discretion to grant requests for approval of alternative monitoring locations.

(2) All monitoring devices under paragraph (a) of this section are to be recalibrated annually in accordance with procedures under §60.13(b).

(b) The owner or operator of each affected facility constructed, reconstructed, or modified after April 28, 2008, that has one or more mechanical vents must install, calibrate, maintain, and continuously operate the monitoring devices specified in paragraphs (b)(1) through (3) of this section, as applicable to the mechanical vent and any control device installed on the vent.

(1) For mechanical vents with fabric filters (baghouses) with design controlled potential PM emissions rates of 25 Mg (28 tons) per year or more, a bag leak detection system according to the requirements in paragraph (c) of this section.

(2) For mechanical vents with wet scrubbers, monitoring devices according to the requirements in paragraphs (b)(2)(i) through (iv) of this section.

(i) A monitoring device for the continuous measurement of the pressure loss through the venturi constriction of the control equipment. The monitoring device is to be certified by the manufacturer to be accurate within ± 1 inch water gauge.

(ii) A monitoring device for the continuous measurement of the water supply flow rate to the control equipment. The monitoring device is to be certified by the manufacturer to be accurate within ± 5 percent of design water supply flow rate.

(iii) A monitoring device for the continuous measurement of the pH of the wet scrubber liquid. The monitoring device is to be certified by the manufacturer to be accurate within ± 5 percent of design pH.

(iv) An average value for each monitoring parameter must be determined during each performance test. Each monitoring parameter must then be maintained within 10 percent of the value established during the most recent performance test on an operating day average basis.

(3) For mechanical vents with control equipment other than wet scrubbers, a monitoring device for the continuous measurement of the reagent injection flow rate to the control equipment, as applicable. The monitoring device is to be certified by the manufacturer to be accurate within ± 5 percent of design injection flow rate. An average reagent injection flow rate value must be determined during each performance test. The reagent injection flow rate must then be maintained within 10 percent of the value established during the most recent performance test on an operating day average basis.

(c) Each bag leak detection system used to comply with provisions of this subpart must be installed, calibrated, maintained, and continuously operated according to the requirements in paragraphs (c)(1) through (3) of this section.

(1) The bag leak detection system must meet the specifications and requirements in paragraphs (c)(1)(i) through (viii) of this section.

(i) The bag leak detection system must be certified by the manufacturer to be capable of detecting PM emissions at concentrations of 1 milligram per dry standard cubic meter (mg/dscm) (0.00044 grains per actual cubic foot (gr/acf)) or less.

(ii) The bag leak detection system sensor must provide output of relative PM loadings. The owner or operator shall continuously record the output from the bag leak detection system using electronic or other means (e.g., using a strip chart recorder or a data logger).

(iii) The bag leak detection system must be equipped with an alarm system that will sound when the system detects an increase in relative particulate loading over the alarm set point established according to paragraph (c)(1)(iv) of this section, and the alarm must be located such that it can be heard by the appropriate plant personnel.

(iv) In the initial adjustment of the bag leak detection system, the owner or operator must establish, at a minimum, the baseline output by adjusting the sensitivity (range) and the averaging period of the device, the alarm set points, and the alarm delay time.

(v) Following initial adjustment, the owner or operator must not adjust the averaging period, alarm set point, or alarm delay time without approval from the Administrator or delegated authority except as provided in paragraph (c)(2)(vi) of this section.

(vi) Once per quarter, the owner or operator may adjust the sensitivity of the bag leak detection system to account for seasonal effects, including temperature and humidity, according to the procedures identified in the site-specific monitoring plan required by paragraph (c)(2) of this section.

(vii) The owner or operator must install the bag leak detection sensor downstream of the fabric filter.

(viii) Where multiple detectors are required, the system's instrumentation and alarm may be shared among detectors.

(2) The owner or operator must develop and submit to the Administrator or delegated authority for approval a site-specific monitoring plan for each bag leak detection system. This plan must be submitted to the Administrator or delegated authority 30 days prior to startup of the affected facility. The owner or operator must operate and maintain the bag leak detection system according to the site-specific monitoring plan at all times. Each monitoring plan must describe the items in paragraphs (c)(2)(i) through (vi) of this section.

(i) Installation of the bag leak detection system;

(ii) Initial and periodic adjustment of the bag leak detection system, including how the alarm set-point will be established;

(iii) Operation of the bag leak detection system, including quality assurance procedures;

(iv) How the bag leak detection system will be maintained, including a routine maintenance schedule and spare parts inventory list;

(v) How the bag leak detection system output will be recorded and stored; and

(vi) Corrective action procedures as specified in paragraph (c)(3) of this section. In approving the site-specific monitoring plan, the Administrator or delegated authority may allow the owner and operator more than 3 hours to alleviate a specific condition that causes an alarm if the owner or operator identifies in the monitoring plan this specific condition as one that could lead to an alarm, adequately explains why it is not feasible to alleviate this condition within 3 hours of the time the alarm occurs, and demonstrates that the requested time will ensure alleviation of this condition as expeditiously as practicable.

(3) For each bag leak detection system, the owner or operator must initiate procedures to determine the cause of every alarm within 1 hour of the alarm. Except as provided in paragraph (c)(2)(vi) of this section, the owner or operator must alleviate the cause of the alarm within 3 hours of the alarm by taking whatever corrective action(s) are necessary. Corrective actions may include, but are not limited to the following:

(i) Inspecting the fabric filter for air leaks, torn or broken bags or filter media, or any other condition that may cause an increase in PM emissions;

(ii) Sealing off defective bags or filter media;

(iii) Replacing defective bags or filter media or otherwise repairing the control device;

(iv) Sealing off a defective fabric filter compartment;

(v) Cleaning the bag leak detection system probe or otherwise repairing the bag leak detection system; or

(vi) Shutting down the process producing the PM emissions.

 [Back to Top](#)

§60.257 Test methods and procedures.

(a) The owner or operator must determine compliance with the applicable opacity standards as specified in paragraphs (a)(1) through (3) of this section.

(1) Method 9 of appendix A-4 of this part and the procedures in §60.11 must be used to determine opacity, with the exceptions specified in paragraphs (a)(1)(i) and (ii).

(i) The duration of the Method 9 of appendix A-4 of this part performance test shall be 1 hour (ten 6-minute averages).

(ii) If, during the initial 30 minutes of the observation of a Method 9 of appendix A-4 of this part performance test, all of the 6-minute average opacity readings are less than or equal to half the applicable opacity limit, then the observation period may be reduced from 1 hour to 30 minutes.

(2) To determine opacity for fugitive coal dust emissions sources, the additional requirements specified in paragraphs (a)(2)(i) through (iii) must be used.

(i) The minimum distance between the observer and the emission source shall be 5.0 meters (16 feet), and the sun shall be oriented in the 140-degree sector of the back.

(ii) The observer shall select a position that minimizes interference from other fugitive coal dust emissions sources and make observations such that the line of vision is approximately perpendicular to the plume and wind direction.

(iii) The observer shall make opacity observations at the point of greatest opacity in that portion of the plume where condensed water vapor is not present. Water vapor is not considered a visible emission.

(3) A visible emissions observer may conduct visible emission observations for up to three fugitive, stack, or vent emission points within a 15-second interval if the following conditions specified in paragraphs (a)(3)(i) through (iii) of this section are met.

(i) No more than three emissions points may be read concurrently.

(ii) All three emissions points must be within a 70 degree viewing sector or angle in front of the observer such that the proper sun position can be maintained for all three points.

(iii) If an opacity reading for any one of the three emissions points is within 5 percent opacity from the applicable standard (excluding readings of zero opacity), then the observer must stop taking readings for the other two points and continue reading just that single point.

(b) The owner or operator must conduct all performance tests required by §60.8 to demonstrate compliance with the applicable emissions standards specified in §60.252 according to the requirements in §60.8 using the applicable test methods and procedures in paragraphs (b)(1) through (8) of this section.

(1) Method 1 or 1A of appendix A-4 of this part shall be used to select sampling port locations and the number of traverse points in each stack or duct. Sampling sites must be located at the outlet of the control device (or at the outlet of the emissions source if no control device is present) prior to any releases to the atmosphere.

(2) Method 2, 2A, 2C, 2D, 2F, or 2G of appendix A-4 of this part shall be used to determine the volumetric flow rate of the stack gas.

(3) Method 3, 3A, or 3B of appendix A-4 of this part shall be used to determine the dry molecular weight of the stack gas. The owner or operator may use ANSI/ASME PTC 19.10-1981, "Flue and Exhaust Gas Analyses (incorporated by reference—see §60.17) as an alternative to Method 3B of appendix A-2 of this part.

(4) Method 4 of appendix A-4 of this part shall be used to determine the moisture content of the stack gas.

(5) Method 5, 5B or 5D of appendix A-4 of this part or Method 17 of appendix A-7 of this part shall be used to determine the PM concentration as follows:

(i) The sampling time and sample volume for each run shall be at least 60 minutes and 0.85 dscm (30 dscf). Sampling shall begin no less than 30 minutes after startup and shall terminate before shutdown procedures begin. A minimum of three valid test runs are needed to comprise a PM performance test.

(ii) Method 5 of appendix A of this part shall be used only to test emissions from affected facilities without wet flue gas desulfurization (FGD) systems.

(iii) Method 5B of appendix A of this part is to be used only after wet FGD systems.

(iv) Method 5D of appendix A-4 of this part shall be used for positive pressure fabric filters and other similar applications (e.g., stub stacks and roof vents).

(v) Method 17 of appendix A-6 of this part may be used at facilities with or without wet scrubber systems provided the stack gas temperature does not exceed a temperature of 160 °C (320 °F). The procedures of sections 8.1 and 11.1 of Method 5B of appendix A-3 of this part may be used in Method 17 of appendix A-6 of this part only if it is used after a wet FGD system. Do not use Method 17 of appendix A-6 of this part after wet FGD systems if the effluent is saturated or laden with water droplets.

(6) Method 6, 6A, or 6C of appendix A-4 of this part shall be used to determine the SO₂ concentration. A minimum of three valid test runs are needed to comprise an SO₂ performance test.

(7) Method 7 or 7E of appendix A-4 of this part shall be used to determine the NO_x concentration. A minimum of three valid test runs are needed to comprise an NO_x performance test.

(8) Method 10 of appendix A-4 of this part shall be used to determine the CO concentration. A minimum of three valid test runs are needed to comprise a CO performance test. CO performance tests are conducted concurrently (or within a 60-minute period) with NO_x performance tests.

[↑ Back to Top](#)

§60.258 Reporting and recordkeeping.

(a) The owner or operator of a coal preparation and processing plant that commenced construction, reconstruction, or modification after April 28, 2008, shall maintain in a logbook (written or electronic) on-site and make it available upon request. The logbook shall record the following:

(1) The manufacturer's recommended maintenance procedures and the date and time of any maintenance and inspection activities and the results of those activities. Any variance from manufacturer recommendation, if any, shall be noted.

(2) The date and time of periodic coal preparation and processing plant visual observations, noting those sources with visible emissions along with corrective actions taken to reduce visible emissions. Results from the actions shall be noted.

(3) The amount and type of coal processed each calendar month.

(4) The amount of chemical stabilizer or water purchased for use in the coal preparation and processing plant.

(5) Monthly certification that the dust suppressant systems were operational when any coal was processed and that manufacturer's recommendations were followed for all control systems. Any variance from the manufacturer's recommendations, if any, shall be noted.

(6) Monthly certification that the fugitive coal dust emissions control plan was implemented as described. Any variance from the plan, if any, shall be noted. A copy of the applicable fugitive coal dust emissions control plan and any letters from the Administrator providing approval of any alternative control measures shall be maintained with the logbook. Any actions, e.g., objections, to the plan and any actions relative to the alternative control measures, e.g., approvals, shall be noted in the logbook as well.

(7) For each bag leak detection system, the owner or operator must keep the records specified in paragraphs (a)(7)(i) through (iii) of this section.

(i) Records of the bag leak detection system output;

(ii) Records of bag leak detection system adjustments, including the date and time of the adjustment, the initial bag leak detection system settings, and the final bag leak detection settings; and

(iii) The date and time of all bag leak detection system alarms, the time that procedures to determine the cause of the alarm were initiated, the cause of the alarm, an explanation of the actions taken, the date and time the cause of the alarm was alleviated, and whether the cause of the alarm was alleviated within 3 hours of the alarm.

(8) A copy of any applicable monitoring plan for a digital opacity compliance system and monthly certification that the plan was implemented as described. Any variance from plan, if any, shall be noted.

(9) During a performance test of a wet scrubber, and each operating day thereafter, the owner or operator shall record the measurements of the scrubber pressure loss, water supply flow rate, and pH of the wet scrubber liquid.

(10) During a performance test of control equipment other than a wet scrubber, and each operating day thereafter, the owner or operator shall record the measurements of the reagent injection flow rate, as applicable.

(b) For the purpose of reports required under section 60.7(c), any owner operator subject to the provisions of this subpart also shall report semiannually periods of excess emissions as follow:

(1) The owner or operator of an affected facility with a wet scrubber shall submit semiannual reports to the Administrator or delegated authority of occurrences when the measurements of the scrubber pressure loss, water supply flow rate, or pH of the wet scrubber liquid vary by more than 10 percent from the average determined during the most recent performance test.

(2) The owner or operator of an affected facility with control equipment other than a wet scrubber shall submit semiannual reports to the Administrator or delegated authority of occurrences when the measurements of the reagent injection flow rate, as applicable, vary by more than 10 percent from the average determined during the most recent performance test.

(3) All 6-minute average opacities that exceed the applicable standard.

(c) The owner or operator of an affected facility shall submit the results of initial performance tests to the Administrator or delegated authority, consistent with the provisions of section 60.8. The owner or operator who elects to comply with the reduced performance testing provisions of sections 60.255(c) or (d) shall include in the performance test report identification of each affected facility that will be subject to the reduced testing. The owner or operator electing to comply with section 60.255(d) shall also include information which demonstrates that the control devices are identical.

(d) After July 1, 2011, within 60 days after the date of completing each performance evaluation conducted to demonstrate compliance with this subpart, the owner or operator of the affected facility must submit the test data to EPA by successfully entering the data electronically into EPA's WebFIRE data base available at <http://cfpub.epa.gov/oarweb/index.cfm?action=fire.main>. For performance tests that cannot be entered into WebFIRE (*i.e.*, Method 9 of appendix A-4 of this part opacity performance tests) the owner or operator of the affected facility must mail a summary copy to United States Environmental Protection Agency; Energy Strategies Group; 109 TW Alexander DR; mail code: D243-01; RTP, NC 27711.

 [Back to Top](#)

Appendix E

Subpart VV—Standards of Performance for Equipment Leaks of VOC in the Synthetic Organic Chemicals Manufacturing Industry for which Construction, Reconstruction, or Modification Commenced After January 5, 1981, and on or Before November 7, 2006

Contents

[§60.480 Applicability and designation of affected facility.](#)
[§60.481 Definitions.](#)
[§60.482-1 Standards: General.](#)
[§60.482-2 Standards: Pumps in light liquid service.](#)
[§60.482-3 Standards: Compressors.](#)
[§60.482-4 Standards: Pressure relief devices in gas/vapor service.](#)
[§60.482-5 Standards: Sampling connection systems.](#)
[§60.482-6 Standards: Open-ended valves or lines.](#)
[§60.482-7 Standards: Valves in gas/vapor service and in light liquid service.](#)
[§60.482-8 Standards: Pumps and valves in heavy liquid service, pressure relief devices in light liquid or heavy liquid service, and connectors.](#)
[§60.482-9 Standards: Delay of repair.](#)
[§60.482-10 Standards: Closed vent systems and control devices.](#)
[§60.483-1 Alternative standards for valves—allowable percentage of valves leaking.](#)
[§60.483-2 Alternative standards for valves—skip period leak detection and repair.](#)
[§60.484 Equivalence of means of emission limitation.](#)
[§60.485 Test methods and procedures.](#)
[§60.486 Recordkeeping requirements.](#)
[§60.487 Reporting requirements.](#)
[§60.488 Reconstruction.](#)
[§60.489 List of chemicals produced by affected facilities.](#)

SOURCE: 48 FR 48335, Oct. 18, 1983, unless otherwise noted.

[↑ Back to Top](#)

§60.480 Applicability and designation of affected facility.

(a)(1) The provisions of this subpart apply to affected facilities in the synthetic organic chemicals manufacturing industry.

(2) The group of all equipment (defined in §60.481) within a process unit is an affected facility.

(b) Any affected facility under paragraph (a) of this section that commences construction, reconstruction, or modification after January 5, 1981, and on or before November 7, 2006, shall be subject to the requirements of this subpart.

(c) Addition or replacement of equipment for the purpose of process improvement which is accomplished without a capital expenditure shall not by itself be considered a modification under this subpart.

(d)(1) If an owner or operator applies for one or more of the exemptions in this paragraph, then the owner or operator shall maintain records as required in §60.486(i).

(2) Any affected facility that has the design capacity to produce less than 1,000 Mg/yr (1,102 ton/yr) of a chemical listed in §60.489 is exempt from §§60.482-1 through 60.482-10.

(3) If an affected facility produces heavy liquid chemicals only from heavy liquid feed or raw materials, then it is exempt from §§60.482-1 through 60.482-10.

(4) Any affected facility that produces beverage alcohol is exempt from §§60.482-1 through 60.482-10.

(5) Any affected facility that has no equipment in volatile organic compounds (VOC) service is exempt from §§60.482-1 through 60.482-10.

(e) *Alternative means of compliance*—(1) *Option to comply with part 65.* (i) Owners or operators may choose to comply with the provisions of 40 CFR part 65, subpart F, to satisfy the requirements of §§60.482 through 60.487 for an affected facility. When choosing to comply with 40 CFR part 65, subpart F, the requirements of §§60.485(d), (e), and (f) and 60.486(i) and (j) still apply. Other provisions applying to an owner or operator who chooses to comply with 40 CFR part 65 are provided in 40 CFR 65.1.

(ii) *Part 60, subpart A.* Owners or operators who choose to comply with 40 CFR part 65, subpart F must also comply with §§60.1, 60.2, 60.5, 60.6, 60.7(a)(1) and (4), 60.14, 60.15, and 60.16 for that equipment. All sections and paragraphs of subpart A of this part that are not mentioned in this paragraph (e)(1)(ii) do not apply to owners and operators of equipment subject to this subpart complying with 40 CFR part 65, subpart F, except that provisions required to be met prior to implementing 40 CFR part 65 still apply. Owners and operators who choose to comply with 40 CFR part 65, subpart F, must comply with 40 CFR part 65, subpart A.

(2) *Subpart VVa.* Owners or operators may choose to comply with the provisions of subpart VVa of this part 60 to satisfy the requirements of this subpart VV for an affected facility.

(f) *Stay of standards.* Owners or operators are not required to comply with the definition of “process unit” in §60.481 and the requirements in §60.482-1(g) of this subpart until the EPA takes final action to require compliance and publishes a document in the FEDERAL REGISTER. While the definition of “process unit” is stayed, owners or operators should use the following definition:

Process unit means components assembled to produce, as intermediate or final products, one or more of the chemicals listed in §60.489 of this part. A process unit can operate independently if supplied with sufficient feed or raw materials and sufficient storage facilities for the product.

[48 FR 48335, Oct. 18, 1983, as amended at 49 FR 22607, May 30, 1984; 65 FR 61762, Oct. 17, 2000; 65 FR 78276, Dec. 14, 2000; 72 FR 64879, Nov. 16, 2007, 73 FR 31379, June 2, 2008; 73 FR 31375, June 2, 2008]

 [Back to Top](#)

§60.481 Definitions.

As used in this subpart, all terms not defined herein shall have the meaning given them in the Act or in subpart A of part 60, and the following terms shall have the specific meanings given them.

Capital expenditure means, in addition to the definition in 40 CFR 60.2, an expenditure for a physical or operational change to an existing facility that:

(a) Exceeds P, the product of the facility's replacement cost, R, and an adjusted annual asset guideline repair allowance, A, as reflected by the following equation: $P = R \times A$, where

(1) The adjusted annual asset guideline repair allowance, A, is the product of the percent of the replacement cost, Y, and the applicable basic annual asset guideline repair allowance, B, divided by 100 as reflected by the following equation:

$$A = Y \times (B \div 100);$$

(2) The percent Y is determined from the following equation: $Y = 1.0 - 0.575 \log X$, where X is 1982 minus the year of construction; and

(3) The applicable basic annual asset guideline repair allowance, B, is selected from the following table consistent with the applicable subpart:

TABLE FOR DETERMINING APPLICABLE VALUE FOR B

Subpart applicable to facility	Value of B to be used in equation
VV	12.5
DDD	12.5
GGG	7.0
KKK	4.5

Closed-loop system means an enclosed system that returns process fluid to the process.

Closed-purge system means a system or combination of systems and portable containers to capture purged liquids. Containers for purged liquids must be covered or closed when not being filled or emptied.

Closed vent system means a system that is not open to the atmosphere and that is composed of hard-piping, ductwork, connections, and, if necessary, flow-inducing devices that transport gas or vapor from a piece or pieces of equipment to a control device or back to a process.

Connector means flanged, screwed, or other joined fittings used to connect two pipe lines or a pipe line and a piece of process equipment or that close an opening in a pipe that could be connected to another pipe. Joined fittings welded completely around the circumference of the interface are not considered connectors for the purpose of this subpart.

Control device means an enclosed combustion device, vapor recovery system, or flare.

Distance piece means an open or enclosed casing through which the piston rod travels, separating the compressor cylinder from the crankcase.

Double block and bleed system means two block valves connected in series with a bleed valve or line that can vent the line between the two block valves.

Duct work means a conveyance system such as those commonly used for heating and ventilation systems. It is often made of sheet metal and often has sections connected by screws or crimping. Hard-piping is not ductwork.

Equipment means each pump, compressor, pressure relief device, sampling connection system, open-ended valve or line, valve, and flange or other connector in VOC service and any devices or systems required by this subpart.

First attempt at repair means to take action for the purpose of stopping or reducing leakage of organic material to the atmosphere using best practices.

Fuel gas means gases that are combusted to derive useful work or heat.

Fuel gas system means the offsite and onsite piping and flow and pressure control system that gathers gaseous stream(s) generated by onsite operations, may blend them with other sources of gas, and transports the gaseous stream for use as fuel gas in combustion devices or in-process combustion equipment, such as furnaces and gas turbines, either singly or in combination.

Hard-piping means pipe or tubing that is manufactured and properly installed using good engineering judgment and standards such as ASME B31.3, Process Piping (available from the American Society of Mechanical Engineers, PO Box 2300, Fairfield, NJ 07007-2300).

In gas/vapor service means that the piece of equipment contains process fluid that is in the gaseous state at operating conditions.

In heavy liquid service means that the piece of equipment is not in gas/vapor service or in light liquid service.

In light liquid service means that the piece of equipment contains a liquid that meets the conditions specified in §60.485(e).

In-situ sampling systems means nonextractive samplers or in-line samplers.

In vacuum service means that equipment is operating at an internal pressure which is at least 5 kilopascals (kPa)(0.7 psia) below ambient pressure.

In VOC service means that the piece of equipment contains or contacts a process fluid that is at least 10 percent VOC by weight. (The provisions of §60.485(d) specify how to determine that a piece of equipment is not in VOC service.)

Liquids dripping means any visible leakage from the seal including spraying, misting, clouding, and ice formation.

Open-ended valve or line means any valve, except safety relief valves, having one side of the valve seat in contact with process fluid and one side open to the atmosphere, either directly or through open piping.

Pressure release means the emission of materials resulting from system pressure being greater than set pressure of the pressure relief device.

Process improvement means routine changes made for safety and occupational health requirements, for energy savings, for better utility, for ease of maintenance and operation, for correction of design deficiencies, for bottleneck removal, for changing product requirements, or for environmental control.

Process unit means the components assembled and connected by pipes or ducts to process raw materials and to produce, as intermediate or final products, one or more of the chemicals listed in

§60.489. A process unit can operate independently if supplied with sufficient feed or raw materials and sufficient storage facilities for the product. For the purpose of this subpart, process unit includes any feed, intermediate and final product storage vessels (except as specified in §60.482-1(g)), product transfer racks, and connected ducts and piping. A process unit includes all equipment as defined in this subpart.

Process unit shutdown means a work practice or operational procedure that stops production from a process unit or part of a process unit during which it is technically feasible to clear process material from a process unit or part of a process unit consistent with safety constraints and during which repairs can be accomplished. The following are not considered process unit shutdowns:

(1) An unscheduled work practice or operational procedure that stops production from a process unit or part of a process unit for less than 24 hours.

(2) An unscheduled work practice or operational procedure that would stop production from a process unit or part of a process unit for a shorter period of time than would be required to clear the process unit or part of the process unit of materials and start up the unit, and would result in greater emissions than delay of repair of leaking components until the next scheduled process unit shutdown.

(3) The use of spare equipment and technically feasible bypassing of equipment without stopping production.

Quarter means a 3-month period; the first quarter concludes on the last day of the last full month during the 180 days following initial startup.

Repaired means that equipment is adjusted, or otherwise altered, in order to eliminate a leak as defined in the applicable sections of this subpart and, except for leaks identified in accordance with §§60.482-2(b)(2)(ii) and (d)(6)(ii) and (iii), 60.482-3(f), and 60.482-10(f)(1)(ii), is re-monitored as specified in §60.485(b) to verify that emissions from the equipment are below the applicable leak definition.

Replacement cost means the capital needed to purchase all the depreciable components in a facility.

Sampling connection system means an assembly of equipment within a process unit used during periods of representative operation to take samples of the process fluid. Equipment used to take nonroutine grab samples is not considered a sampling connection system.

Sensor means a device that measures a physical quantity or the change in a physical quantity such as temperature, pressure, flow rate, pH, or liquid level.

Storage vessel means a tank or other vessel that is used to store organic liquids that are used in the process as raw material feedstocks, produced as intermediates or final products, or generated as wastes. Storage vessel does not include vessels permanently attached to motor vehicles, such as trucks, railcars, barges, or ships.

Synthetic organic chemicals manufacturing industry means the industry that produces, as intermediates or final products, one or more of the chemicals listed in §60.489.

Transfer rack means the collection of loading arms and loading hoses, at a single loading rack, that are used to fill tank trucks and/or railcars with organic liquids.

Volatile organic compounds or VOC means, for the purposes of this subpart, any reactive organic compounds as defined in §60.2 Definitions.

[48 FR 48335, Oct. 18, 1983, as amended at 49 FR 22607, May 30, 1984; 49 FR 26738, June 29, 1984; 60 FR 43258, Aug. 18, 1995; 65 FR 61762, Oct. 17, 2000; 65 FR 78276, Dec. 14, 2000; 72 FR 64879, Nov. 16, 2007]

EFFECTIVE DATE NOTE: At 73 FR 31375, June 2, 2008, in §60.481, the definition of “process unit” was stayed until further notice.

[↑ Back to Top](#)

§60.482-1 Standards: General.

(a) Each owner or operator subject to the provisions of this subpart shall demonstrate compliance with the requirements of §§60.482-1 through 60.482-10 or §60.480(e) for all equipment within 180 days of initial startup.

(b) Compliance with §§60.482-1 to 60.482-10 will be determined by review of records and reports, review of performance test results, and inspection using the methods and procedures specified in §60.485.

(c)(1) An owner or operator may request a determination of equivalence of a means of emission limitation to the requirements of §§60.482-2, 60.482-3, 60.482-5, 60.482-6, 60.482-7, 60.482-8, and 60.482-10 as provided in §60.484.

(2) If the Administrator makes a determination that a means of emission limitation is at least equivalent to the requirements of §60.482-2, §60.482-3, §60.482-5, §60.482-6, §60.482-7, §60.482-8, or §60.482-10, an owner or operator shall comply with the requirements of that determination.

(d) Equipment that is in vacuum service is excluded from the requirements of §§60.482-2 to 60.482-10 if it is identified as required in §60.486(e)(5).

(e) Equipment that an owner or operator designates as being in VOC service less than 300 hours (hr)/yr is excluded from the requirements of §§60.482-2 through 60.482-10 if it is identified as required in §60.486(e)(6) and it meets any of the conditions specified in paragraphs (e)(1) through (3) of this section.

(1) The equipment is in VOC service only during startup and shutdown, excluding startup and shutdown between batches of the same campaign for a batch process.

(2) The equipment is in VOC service only during process malfunctions or other emergencies.

(3) The equipment is backup equipment that is in VOC service only when the primary equipment is out of service.

(f)(1) If a dedicated batch process unit operates less than 365 days during a year, an owner or operator may monitor to detect leaks from pumps and valves at the frequency specified in the following table instead of monitoring as specified in §§60.482-2, 60.482-7, and 60.483-2:

Operating time (percent of hours during year)	Equivalent monitoring frequency time in use		
	Monthly	Quarterly	Semiannually
0 to <25	Quarterly	Annually	Annually.
25 to <50	Quarterly	Semiannually	Annually.

50 to <75	Bimonthly	Three quarters	Semiannually.
75 to 100	Monthly	Quarterly	Semiannually.

(2) Pumps and valves that are shared among two or more batch process units that are subject to this subpart may be monitored at the frequencies specified in paragraph (f)(1) of this section, provided the operating time of all such process units is considered.

(3) The monitoring frequencies specified in paragraph (f)(1) of this section are not requirements for monitoring at specific intervals and can be adjusted to accommodate process operations. An owner or operator may monitor at any time during the specified monitoring period (e.g., month, quarter, year), provided the monitoring is conducted at a reasonable interval after completion of the last monitoring campaign. Reasonable intervals are defined in paragraphs (f)(3)(i) through (iv) of this section.

(i) When monitoring is conducted quarterly, monitoring events must be separated by at least 30 calendar days.

(ii) When monitoring is conducted semiannually (*i.e.*, once every 2 quarters), monitoring events must be separated by at least 60 calendar days.

(iii) When monitoring is conducted in 3 quarters per year, monitoring events must be separated by at least 90 calendar days.

(iv) When monitoring is conducted annually, monitoring events must be separated by at least 120 calendar days.

(g) If the storage vessel is shared with multiple process units, the process unit with the greatest annual amount of stored materials (predominant use) is the process unit the storage vessel is assigned to. If the storage vessel is shared equally among process units, and one of the process units has equipment subject to subpart VVa of this part, the storage vessel is assigned to that process unit. If the storage vessel is shared equally among process units, none of which have equipment subject to subpart VVa of this part, the storage vessel is assigned to any process unit subject to this subpart. If the predominant use of the storage vessel varies from year to year, then the owner or operator must estimate the predominant use initially and reassess every 3 years. The owner or operator must keep records of the information and supporting calculations that show how predominant use is determined. All equipment on the storage vessel must be monitored when in VOC service.

[48 FR 48335, Oct. 18, 1983, as amended at 49 FR 22608, May 30, 1984; 65 FR 78276, Dec. 14, 2000; 72 FR 64880, Nov. 16, 2007]

EFFECTIVE DATE NOTE: At 73 FR 31375, June 2, 2008, in §60.482-1, paragraph (g) was stayed until further notice.

[↑ Back to Top](#)

§60.482-2 Standards: Pumps in light liquid service.

(a)(1) Each pump in light liquid service shall be monitored monthly to detect leaks by the methods specified in §60.485(b), except as provided in §60.482-1(c) and (f) and paragraphs (d), (e), and (f) of this section. A pump that begins operation in light liquid service after the initial startup date for the process unit must be monitored for the first time within 30 days after the end of its startup period, except for a pump that replaces a leaking pump and except as provided in §60.482-1(c) and (f) and paragraphs (d), (e), and (f) of this section.

(2) Each pump in light liquid service shall be checked by visual inspection each calendar week for indications of liquids dripping from the pump seal, except as provided in §60.482-1(f).

(b)(1) If an instrument reading of 10,000 ppm or greater is measured, a leak is detected.

(2) If there are indications of liquids dripping from the pump seal, the owner or operator shall follow the procedure specified in either paragraph (b)(2)(i) or (ii) of this section. This requirement does not apply to a pump that was monitored after a previous weekly inspection if the instrument reading for that monitoring event was less than 10,000 ppm and the pump was not repaired since that monitoring event.

(i) Monitor the pump within 5 days as specified in §60.485(b). If an instrument reading of 10,000 ppm or greater is measured, a leak is detected. The leak shall be repaired using the procedures in paragraph (c) of this section.

(ii) Designate the visual indications of liquids dripping as a leak, and repair the leak within 15 days of detection by eliminating the visual indications of liquids dripping.

(c)(1) When a leak is detected, it shall be repaired as soon as practicable, but not later than 15 calendar days after it is detected, except as provided in §60.482-9.

(2) A first attempt at repair shall be made no later than 5 calendar days after each leak is detected. First attempts at repair include, but are not limited to, the practices described in paragraphs (c)(2)(i) and (ii) of this section, where practicable.

(i) Tightening the packing gland nuts;

(ii) Ensuring that the seal flush is operating at design pressure and temperature.

(d) Each pump equipped with a dual mechanical seal system that includes a barrier fluid system is exempt from the requirements of paragraph (a) of this section, provided the requirements specified in paragraphs (d)(1) through (6) of this section are met.

(1) Each dual mechanical seal system is—

(i) Operated with the barrier fluid at a pressure that is at all times greater than the pump stuffing box pressure; or

(ii) Equipped with a barrier fluid degassing reservoir that is routed to a process or fuel gas system or connected by a closed vent system to a control device that complies with the requirements of §60.482-10; or

(iii) Equipped with a system that purges the barrier fluid into a process stream with zero VOC emissions to the atmosphere.

(2) The barrier fluid system is in heavy liquid service or is not in VOC service.

(3) Each barrier fluid system is equipped with a sensor that will detect failure of the seal system, the barrier fluid system, or both.

(4)(i) Each pump is checked by visual inspection, each calendar week, for indications of liquids dripping from the pump seals.

(ii) If there are indications of liquids dripping from the pump seal at the time of the weekly inspection, the owner or operator shall follow the procedure specified in either paragraph (d)(4)(ii)(A) or (B) of this section.

(A) Monitor the pump within 5 days as specified in §60.485(b) to determine if there is a leak of VOC in the barrier fluid. If an instrument reading of 10,000 ppm or greater is measured, a leak is detected.

(B) Designate the visual indications of liquids dripping as a leak.

(5)(i) Each sensor as described in paragraph (d)(3) of this section is checked daily or is equipped with an audible alarm.

(ii) The owner or operator determines, based on design considerations and operating experience, a criterion that indicates failure of the seal system, the barrier fluid system, or both.

(iii) If the sensor indicates failure of the seal system, the barrier fluid system, or both, based on the criterion established in paragraph (d)(5)(ii) of this section, a leak is detected.

(6)(i) When a leak is detected pursuant to paragraph (d)(4)(ii)(A) of this section, it shall be repaired as specified in paragraph (c) of this section.

(ii) A leak detected pursuant to paragraph (d)(5)(iii) of this section shall be repaired within 15 days of detection by eliminating the conditions that activated the sensor.

(iii) A designated leak pursuant to paragraph (d)(4)(ii)(B) of this section shall be repaired within 15 days of detection by eliminating visual indications of liquids dripping.

(e) Any pump that is designated, as described in §60.486(e)(1) and (2), for no detectable emissions, as indicated by an instrument reading of less than 500 ppm above background, is exempt from the requirements of paragraphs (a), (c), and (d) of this section if the pump:

(1) Has no externally actuated shaft penetrating the pump housing,

(2) Is demonstrated to be operating with no detectable emissions as indicated by an instrument reading of less than 500 ppm above background as measured by the methods specified in §60.485(c), and

(3) Is tested for compliance with paragraph (e)(2) of this section initially upon designation, annually, and at other times requested by the Administrator.

(f) If any pump is equipped with a closed vent system capable of capturing and transporting any leakage from the seal or seals to a process or to a fuel gas system or to a control device that complies with the requirements of §60.482-10, it is exempt from paragraphs (a) through (e) of this section.

(g) Any pump that is designated, as described in §60.486(f)(1), as an unsafe-to-monitor pump is exempt from the monitoring and inspection requirements of paragraphs (a) and (d)(4) through (6) of this section if:

(1) The owner or operator of the pump demonstrates that the pump is unsafe-to-monitor because monitoring personnel would be exposed to an immediate danger as a consequence of complying with paragraph (a) of this section; and

(2) The owner or operator of the pump has a written plan that requires monitoring of the pump as frequently as practicable during safe-to-monitor times but not more frequently than the periodic monitoring schedule otherwise applicable, and repair of the equipment according to the procedures in paragraph (c) of this section if a leak is detected.

(h) Any pump that is located within the boundary of an unmanned plant site is exempt from the weekly visual inspection requirement of paragraphs (a)(2) and (d)(4) of this section, and the daily requirements of paragraph (d)(5) of this section, provided that each pump is visually inspected as often as practicable and at least monthly.

[48 FR 48335, Oct. 18, 1983, as amended at 65 FR 61762, Oct. 17, 2000; 65 FR 78276, Dec. 14, 2000; 72 FR 64880, Nov. 16, 2007]

 [Back to Top](#)

§60.482-3 Standards: Compressors.

(a) Each compressor shall be equipped with a seal system that includes a barrier fluid system and that prevents leakage of VOC to the atmosphere, except as provided in §60.482-1(c) and paragraphs (h), (i), and (j) of this section.

(b) Each compressor seal system as required in paragraph (a) shall be:

(1) Operated with the barrier fluid at a pressure that is greater than the compressor stuffing box pressure; or

(2) Equipped with a barrier fluid system degassing reservoir that is routed to a process or fuel gas system or connected by a closed vent system to a control device that complies with the requirements of §60.482-10; or

(3) Equipped with a system that purges the barrier fluid into a process stream with zero VOC emissions to the atmosphere.

(c) The barrier fluid system shall be in heavy liquid service or shall not be in VOC service.

(d) Each barrier fluid system as described in paragraph (a) shall be equipped with a sensor that will detect failure of the seal system, barrier fluid system, or both.

(e)(1) Each sensor as required in paragraph (d) shall be checked daily or shall be equipped with an audible alarm.

(2) The owner or operator shall determine, based on design considerations and operating experience, a criterion that indicates failure of the seal system, the barrier fluid system, or both.

(f) If the sensor indicates failure of the seal system, the barrier system, or both based on the criterion determined under paragraph (e)(2), a leak is detected.

(g)(1) When a leak is detected, it shall be repaired as soon as practicable, but not later than 15 calendar days after it is detected, except as provided in §60.482-9.

(2) A first attempt at repair shall be made no later than 5 calendar days after each leak is detected.

(h) A compressor is exempt from the requirements of paragraphs (a) and (b) of this section, if it is equipped with a closed vent system to capture and transport leakage from the compressor drive shaft back to a process or fuel gas system or to a control device that complies with the requirements of §60.482-10, except as provided in paragraph (i) of this section.

(i) Any compressor that is designated, as described in §60.486(e) (1) and (2), for no detectable emissions, as indicated by an instrument reading of less than 500 ppm above background, is exempt from the requirements of paragraphs (a)-(h) if the compressor:

(1) Is demonstrated to be operating with no detectable emissions, as indicated by an instrument reading of less than 500 ppm above background, as measured by the methods specified in §60.485(c); and

(2) Is tested for compliance with paragraph (i)(1) of this section initially upon designation, annually, and at other times requested by the Administrator.

(j) Any existing reciprocating compressor in a process unit which becomes an affected facility under provisions of §60.14 or §60.15 is exempt from paragraphs (a) through (e) and (h) of this section, provided the owner or operator demonstrates that recasting the distance piece or replacing the compressor are the only options available to bring the compressor into compliance with the provisions of paragraphs (a) through (e) and (h) of this section.

[48 FR 48335, Oct. 18, 1983, as amended at 65 FR 61762, Oct. 17, 2000; 65 FR 78277, Dec. 14, 2000; 72 FR 64881, Nov. 16, 2007]

[↑ Back to Top](#)

§60.482-4 Standards: Pressure relief devices in gas/vapor service.

(a) Except during pressure releases, each pressure relief device in gas/vapor service shall be operated with no detectable emissions, as indicated by an instrument reading of less than 500 ppm above background, as determined by the methods specified in §60.485(c).

(b)(1) After each pressure release, the pressure relief device shall be returned to a condition of no detectable emissions, as indicated by an instrument reading of less than 500 ppm above background, as soon as practicable, but no later than 5 calendar days after the pressure release, except as provided in §60.482-9.

(2) No later than 5 calendar days after the pressure release, the pressure relief device shall be monitored to confirm the conditions of no detectable emissions, as indicated by an instrument reading of less than 500 ppm above background, by the methods specified in §60.485(c).

(c) Any pressure relief device that is routed to a process or fuel gas system or equipped with a closed vent system capable of capturing and transporting leakage through the pressure relief device to a control device as described in §60.482-10 is exempted from the requirements of paragraphs (a) and (b) of this section.

(d)(1) Any pressure relief device that is equipped with a rupture disk upstream of the pressure relief device is exempt from the requirements of paragraphs (a) and (b) of this section, provided the owner or operator complies with the requirements in paragraph (d)(2) of this section.

(2) After each pressure release, a new rupture disk shall be installed upstream of the pressure relief device as soon as practicable, but no later than 5 calendar days after each pressure release, except as provided in §60.482-9.

[48 FR 48335, Oct. 18, 1983, as amended at 65 FR 61762, Oct. 17, 2000; 65 FR 78277, Dec. 14, 2000]

[↑ Back to Top](#)

§60.482-5 Standards: Sampling connection systems.

(a) Each sampling connection system shall be equipped with a closed-purge, closed-loop, or closed-vent system, except as provided in §60.482-1(c) and paragraph (c) of this section.

(b) Each closed-purge, closed-loop, or closed-vent system as required in paragraph (a) of this section shall comply with the requirements specified in paragraphs (b)(1) through (4) of this section.

(1) Gases displaced during filling of the sample container are not required to be collected or captured.

(2) Containers that are part of a closed-purge system must be covered or closed when not being filled or emptied.

(3) Gases remaining in the tubing or piping between the closed-purge system valve(s) and sample container valve(s) after the valves are closed and the sample container is disconnected are not required to be collected or captured.

(4) Each closed-purge, closed-loop, or closed-vent system shall be designed and operated to meet requirements in either paragraph (b)(4)(i), (ii), (iii), or (iv) of this section.

(i) Return the purged process fluid directly to the process line.

(ii) Collect and recycle the purged process fluid to a process.

(iii) Capture and transport all the purged process fluid to a control device that complies with the requirements of §60.482-10.

(iv) Collect, store, and transport the purged process fluid to any of the following systems or facilities:

(A) A waste management unit as defined in §63.111, if the waste management unit is subject to and operated in compliance with the provisions of 40 CFR part 63, subpart G, applicable to Group 1 wastewater streams;

(B) A treatment, storage, or disposal facility subject to regulation under 40 CFR part 262, 264, 265, or 266;

(C) A facility permitted, licensed, or registered by a state to manage municipal or industrial solid waste, if the process fluids are not hazardous waste as defined in 40 CFR part 261;

(D) A waste management unit subject to and operated in compliance with the treatment requirements of §61.348(a), provided all waste management units that collect, store, or transport the purged process fluid to the treatment unit are subject to and operated in compliance with the management requirements of §§61.343 through 61.347; or

(E) A device used to burn off-specification used oil for energy recovery in accordance with 40 CFR part 279, subpart G, provided the purged process fluid is not hazardous waste as defined in 40 CFR part 261.

(c) In situ sampling systems and sampling systems without purges are exempt from the requirements of paragraphs (a) and (b) of this section.

[60 FR 43258, Aug. 18, 1995, as amended at 65 FR 61762, Oct. 17, 2000; 65 FR 78277, Dec. 14, 2000; 72 FR 64881, Nov. 16, 2007]

[↑ Back to Top](#)

§60.482-6 Standards: Open-ended valves or lines.

(a)(1) Each open-ended valve or line shall be equipped with a cap, blind flange, plug, or a second valve, except as provided in §60.482-1(c) and paragraphs (d) and (e) of this section.

(2) The cap, blind flange, plug, or second valve shall seal the open end at all times except during operations requiring process fluid flow through the open-ended valve or line.

(b) Each open-ended valve or line equipped with a second valve shall be operated in a manner such that the valve on the process fluid end is closed before the second valve is closed.

(c) When a double block-and-bleed system is being used, the bleed valve or line may remain open during operations that require venting the line between the block valves but shall comply with paragraph (a) at all other times.

(d) Open-ended valves or lines in an emergency shutdown system which are designed to open automatically in the event of a process upset are exempt from the requirements of paragraphs (a), (b) and (c) of this section.

(e) Open-ended valves or lines containing materials which would autocatalytically polymerize or would present an explosion, serious overpressure, or other safety hazard if capped or equipped with a double block and bleed system as specified in paragraphs (a) through (c) of this section are exempt from the requirements of paragraphs (a) through (c) of this section.

[48 FR 48335, Oct. 18, 1983, as amended at 49 FR 22607, May 30, 1984; 65 FR 78277, Dec. 14, 2000; 72 FR 64881, Nov. 16, 2007]

[↑ Back to Top](#)

§60.482-7 Standards: Valves in gas/vapor service and in light liquid service.

(a)(1) Each valve shall be monitored monthly to detect leaks by the methods specified in §60.485(b) and shall comply with paragraphs (b) through (e) of this section, except as provided in paragraphs (f), (g), and (h) of this section, §60.482-1(c) and (f), and §§60.483-1 and 60.483-2.

(2) A valve that begins operation in gas/vapor service or light liquid service after the initial startup date for the process unit must be monitored according to paragraphs (a)(2)(i) or (ii), except for a valve that replaces a leaking valve and except as provided in paragraphs (f), (g), and (h) of this section, §60.482-1(c), and §§60.483-1 and 60.483-2.

(i) Monitor the valve as in paragraph (a)(1) of this section. The valve must be monitored for the first time within 30 days after the end of its startup period to ensure proper installation.

(ii) If the valves on the process unit are monitored in accordance with §60.483-1 or §60.483-2, count the new valve as leaking when calculating the percentage of valves leaking as described in §60.483-2(b)(5). If less than 2.0 percent of the valves are leaking for that process unit, the valve must be monitored for the first time during the next scheduled monitoring event for existing valves in the process unit or within 90 days, whichever comes first.

(b) If an instrument reading of 10,000 ppm or greater is measured, a leak is detected.

(c)(1)(i) Any valve for which a leak is not detected for 2 successive months may be monitored the first month of every quarter, beginning with the next quarter, until a leak is detected.

(ii) As an alternative to monitoring all of the valves in the first month of a quarter, an owner or operator may elect to subdivide the process unit into 2 or 3 subgroups of valves and monitor each subgroup in a different month during the quarter, provided each subgroup is monitored every 3 months. The owner or operator must keep records of the valves assigned to each subgroup.

(2) If a leak is detected, the valve shall be monitored monthly until a leak is not detected for 2 successive months.

(d)(1) When a leak is detected, it shall be repaired as soon as practicable, but no later than 15 calendar days after the leak is detected, except as provided in §60.482-9.

(2) A first attempt at repair shall be made no later than 5 calendar days after each leak is detected.

(e) First attempts at repair include, but are not limited to, the following best practices where practicable:

(1) Tightening of bonnet bolts;

(2) Replacement of bonnet bolts;

(3) Tightening of packing gland nuts;

(4) Injection of lubricant into lubricated packing.

(f) Any valve that is designated, as described in §60.486(e)(2), for no detectable emissions, as indicated by an instrument reading of less than 500 ppm above background, is exempt from the requirements of paragraph (a) if the valve:

(1) Has no external actuating mechanism in contact with the process fluid,

(2) Is operated with emissions less than 500 ppm above background as determined by the method specified in §60.485(c), and

(3) Is tested for compliance with paragraph (f)(2) of this section initially upon designation, annually, and at other times requested by the Administrator.

(g) Any valve that is designated, as described in §60.486(f)(1), as an unsafe-to-monitor valve is exempt from the requirements of paragraph (a) if:

(1) The owner or operator of the valve demonstrates that the valve is unsafe to monitor because monitoring personnel would be exposed to an immediate danger as a consequence of complying with paragraph (a), and

(2) The owner or operator of the valve adheres to a written plan that requires monitoring of the valve as frequently as practicable during safe-to-monitor times.

(h) Any valve that is designated, as described in §60.486(f)(2), as a difficult-to-monitor valve is exempt from the requirements of paragraph (a) if:

(1) The owner or operator of the valve demonstrates that the valve cannot be monitored without elevating the monitoring personnel more than 2 meters above a support surface.

(2) The process unit within which the valve is located either becomes an affected facility through §60.14 or §60.15 or the owner or operator designates less than 3.0 percent of the total number of valves as difficult-to-monitor, and

(3) The owner or operator of the valve follows a written plan that requires monitoring of the valve at least once per calendar year.

[48 FR 48335, Oct. 18, 1983, as amended at 49 FR 22608, May 30, 1984; 65 FR 61762, Oct. 17, 2000; 72 FR 64881, Nov. 16, 2007]

 [Back to Top](#)

§60.482-8 Standards: Pumps and valves in heavy liquid service, pressure relief devices in light liquid or heavy liquid service, and connectors.

(a) If evidence of a potential leak is found by visual, audible, olfactory, or any other detection method at pumps and valves in heavy liquid service, pressure relief devices in light liquid or heavy liquid service, and connectors, the owner or operator shall follow either one of the following procedures:

(1) The owner or operator shall monitor the equipment within 5 days by the method specified in §60.485(b) and shall comply with the requirements of paragraphs (b) through (d) of this section.

(2) The owner or operator shall eliminate the visual, audible, olfactory, or other indication of a potential leak within 5 calendar days of detection.

(b) If an instrument reading of 10,000 ppm or greater is measured, a leak is detected.

(c)(1) When a leak is detected, it shall be repaired as soon as practicable, but not later than 15 calendar days after it is detected, except as provided in §60.482-9.

(2) The first attempt at repair shall be made no later than 5 calendar days after each leak is detected.

(d) First attempts at repair include, but are not limited to, the best practices described under §§60.482-2(c)(2) and 60.482-7(e).

[48 CFR 48335, Oct. 18, 1983, as amended at 65 FR 78277, Dec. 14, 2000; 72 FR 64882, Nov. 16, 2007]

 [Back to Top](#)

§60.482-9 Standards: Delay of repair.

(a) Delay of repair of equipment for which leaks have been detected will be allowed if repair within 15 days is technically infeasible without a process unit shutdown. Repair of this equipment shall occur before the end of the next process unit shutdown. Monitoring to verify repair must occur within 15 days after startup of the process unit.

(b) Delay of repair of equipment will be allowed for equipment which is isolated from the process and which does not remain in VOC service.

(c) Delay of repair for valves will be allowed if:

(1) The owner or operator demonstrates that emissions of purged material resulting from immediate repair are greater than the fugitive emissions likely to result from delay of repair, and

(2) When repair procedures are effected, the purged material is collected and destroyed or recovered in a control device complying with §60.482-10.

(d) Delay of repair for pumps will be allowed if:

(1) Repair requires the use of a dual mechanical seal system that includes a barrier fluid system, and

(2) Repair is completed as soon as practicable, but not later than 6 months after the leak was detected.

(e) Delay of repair beyond a process unit shutdown will be allowed for a valve, if valve assembly replacement is necessary during the process unit shutdown, valve assembly supplies have been depleted, and valve assembly supplies had been sufficiently stocked before the supplies were depleted. Delay of repair beyond the next process unit shutdown will not be allowed unless the next process unit shutdown occurs sooner than 6 months after the first process unit shutdown.

(f) When delay of repair is allowed for a leaking pump or valve that remains in service, the pump or valve may be considered to be repaired and no longer subject to delay of repair requirements if two consecutive monthly monitoring instrument readings are below the leak definition.

[48 FR 48335, Oct. 18, 1983, as amended at 65 FR 78277, Dec. 14, 2000; 72 FR 64882, Nov. 16, 2007]

 [Back to Top](#)

§60.482-10 Standards: Closed vent systems and control devices.

(a) Owners or operators of closed vent systems and control devices used to comply with provisions of this subpart shall comply with the provisions of this section.

(b) Vapor recovery systems (for example, condensers and absorbers) shall be designed and operated to recover the VOC emissions vented to them with an efficiency of 95 percent or greater, or to an exit concentration of 20 parts per million by volume, whichever is less stringent.

(c) Enclosed combustion devices shall be designed and operated to reduce the VOC emissions vented to them with an efficiency of 95 percent or greater, or to an exit concentration of 20 parts per

million by volume, on a dry basis, corrected to 3 percent oxygen, whichever is less stringent or to provide a minimum residence time of 0.75 seconds at a minimum temperature of 816 °C.

(d) Flares used to comply with this subpart shall comply with the requirements of §60.18.

(e) Owners or operators of control devices used to comply with the provisions of this subpart shall monitor these control devices to ensure that they are operated and maintained in conformance with their designs.

(f) Except as provided in paragraphs (i) through (k) of this section, each closed vent system shall be inspected according to the procedures and schedule specified in paragraphs (f)(1) and (f)(2) of this section.

(1) If the vapor collection system or closed vent system is constructed of hard-piping, the owner or operator shall comply with the requirements specified in paragraphs (f)(1)(i) and (f)(1)(ii) of this section:

(i) Conduct an initial inspection according to the procedures in §60.485(b); and

(ii) Conduct annual visual inspections for visible, audible, or olfactory indications of leaks.

(2) If the vapor collection system or closed vent system is constructed of ductwork, the owner or operator shall:

(i) Conduct an initial inspection according to the procedures in §60.485(b); and

(ii) Conduct annual inspections according to the procedures in §60.485(b).

(g) Leaks, as indicated by an instrument reading greater than 500 parts per million by volume above background or by visual inspections, shall be repaired as soon as practicable except as provided in paragraph (h) of this section.

(1) A first attempt at repair shall be made no later than 5 calendar days after the leak is detected.

(2) Repair shall be completed no later than 15 calendar days after the leak is detected.

(h) Delay of repair of a closed vent system for which leaks have been detected is allowed if the repair is technically infeasible without a process unit shutdown or if the owner or operator determines that emissions resulting from immediate repair would be greater than the fugitive emissions likely to result from delay of repair. Repair of such equipment shall be complete by the end of the next process unit shutdown.

(i) If a vapor collection system or closed vent system is operated under a vacuum, it is exempt from the inspection requirements of paragraphs (f)(1)(i) and (f)(2) of this section.

(j) Any parts of the closed vent system that are designated, as described in paragraph (l)(1) of this section, as unsafe to inspect are exempt from the inspection requirements of paragraphs (f)(1)(i) and (f)(2) of this section if they comply with the requirements specified in paragraphs (j)(1) and (j)(2) of this section:

(1) The owner or operator determines that the equipment is unsafe to inspect because inspecting personnel would be exposed to an imminent or potential danger as a consequence of complying with paragraphs (f)(1)(i) or (f)(2) of this section; and

(2) The owner or operator has a written plan that requires inspection of the equipment as frequently as practicable during safe-to-inspect times.

(k) Any parts of the closed vent system that are designated, as described in paragraph (l)(2) of this section, as difficult to inspect are exempt from the inspection requirements of paragraphs (f)(1)(i) and (f)(2) of this section if they comply with the requirements specified in paragraphs (k)(1) through (k)(3) of this section:

(1) The owner or operator determines that the equipment cannot be inspected without elevating the inspecting personnel more than 2 meters above a support surface; and

(2) The process unit within which the closed vent system is located becomes an affected facility through §§60.14 or 60.15, or the owner or operator designates less than 3.0 percent of the total number of closed vent system equipment as difficult to inspect; and

(3) The owner or operator has a written plan that requires inspection of the equipment at least once every 5 years. A closed vent system is exempt from inspection if it is operated under a vacuum.

(l) The owner or operator shall record the information specified in paragraphs (l)(1) through (l)(5) of this section.

(1) Identification of all parts of the closed vent system that are designated as unsafe to inspect, an explanation of why the equipment is unsafe to inspect, and the plan for inspecting the equipment.

(2) Identification of all parts of the closed vent system that are designated as difficult to inspect, an explanation of why the equipment is difficult to inspect, and the plan for inspecting the equipment.

(3) For each inspection during which a leak is detected, a record of the information specified in §60.486(c).

(4) For each inspection conducted in accordance with §60.485(b) during which no leaks are detected, a record that the inspection was performed, the date of the inspection, and a statement that no leaks were detected.

(5) For each visual inspection conducted in accordance with paragraph (f)(1)(ii) of this section during which no leaks are detected, a record that the inspection was performed, the date of the inspection, and a statement that no leaks were detected.

(m) Closed vent systems and control devices used to comply with provisions of this subpart shall be operated at all times when emissions may be vented to them.

[48 FR 48335, Oct. 18, 1983, as amended at 51 FR 2702, Jan. 21, 1986; 60 FR 43258, Aug. 18, 1995; 61 FR 29878, June 12, 1996; 65 FR 78277, Dec. 14, 2000]

 [Back to Top](#)

§60.483-1 Alternative standards for valves—allowable percentage of valves leaking.

(a) An owner or operator may elect to comply with an allowable percentage of valves leaking of equal to or less than 2.0 percent.

(b) The following requirements shall be met if an owner or operator wishes to comply with an allowable percentage of valves leaking:

(1) An owner or operator must notify the Administrator that the owner or operator has elected to comply with the allowable percentage of valves leaking before implementing this alternative standard, as specified in §60.487(d).

(2) A performance test as specified in paragraph (c) of this section shall be conducted initially upon designation, annually, and at other times requested by the Administrator.

(3) If a valve leak is detected, it shall be repaired in accordance with §60.482-7(d) and (e).

(c) Performance tests shall be conducted in the following manner:

(1) All valves in gas/vapor and light liquid service within the affected facility shall be monitored within 1 week by the methods specified in §60.485(b).

(2) If an instrument reading of 10,000 ppm or greater is measured, a leak is detected.

(3) The leak percentage shall be determined by dividing the number of valves for which leaks are detected by the number of valves in gas/vapor and light liquid service within the affected facility.

(d) Owners and operators who elect to comply with this alternative standard shall not have an affected facility with a leak percentage greater than 2.0 percent, determined as described in §60.485(h).

[48 FR 48335, Oct. 18, 1983, as amended at 65 FR 61762, Oct. 17, 2000; 65 FR 78278, Dec. 14, 2000; 72 FR 64882, Nov. 16, 2007]

[↑ Back to Top](#)

§60.483-2 Alternative standards for valves—skip period leak detection and repair.

(a)(1) An owner or operator may elect to comply with one of the alternative work practices specified in paragraphs (b)(2) and (3) of this section.

(2) An owner or operator must notify the Administrator before implementing one of the alternative work practices, as specified in §60.487(d).

(b)(1) An owner or operator shall comply initially with the requirements for valves in gas/vapor service and valves in light liquid service, as described in §60.482-7.

(2) After 2 consecutive quarterly leak detection periods with the percent of valves leaking equal to or less than 2.0, an owner or operator may begin to skip 1 of the quarterly leak detection periods for the valves in gas/vapor and light liquid service.

(3) After 5 consecutive quarterly leak detection periods with the percent of valves leaking equal to or less than 2.0, an owner or operator may begin to skip 3 of the quarterly leak detection periods for the valves in gas/vapor and light liquid service.

(4) If the percent of valves leaking is greater than 2.0, the owner or operator shall comply with the requirements as described in §60.482-7 but can again elect to use this section.

(5) The percent of valves leaking shall be determined as described in §60.485(h).

(6) An owner or operator must keep a record of the percent of valves found leaking during each leak detection period.

(7) A valve that begins operation in gas/vapor service or light liquid service after the initial startup date for a process unit following one of the alternative standards in this section must be monitored in accordance with §60.482-7(a)(2)(i) or (ii) before the provisions of this section can be applied to that valve.

[48 FR 48335, Oct. 18, 1983, as amended at 65 FR 61762, Oct. 17, 2000; 65 FR 78278, Dec. 14, 2000; 72 FR 64882, Nov. 16, 2007]

 [Back to Top](#)

§60.484 Equivalence of means of emission limitation.

(a) Each owner or operator subject to the provisions of this subpart may apply to the Administrator for determination of equivalence for any means of emission limitation that achieves a reduction in emissions of VOC at least equivalent to the reduction in emissions of VOC achieved by the controls required in this subpart.

(b) Determination of equivalence to the equipment, design, and operational requirements of this subpart will be evaluated by the following guidelines:

(1) Each owner or operator applying for an equivalence determination shall be responsible for collecting and verifying test data to demonstrate equivalence of means of emission limitation.

(2) The Administrator will compare test data for demonstrating equivalence of the means of emission limitation to test data for the equipment, design, and operational requirements.

(3) The Administrator may condition the approval of equivalence on requirements that may be necessary to assure operation and maintenance to achieve the same emission reduction as the equipment, design, and operational requirements.

(c) Determination of equivalence to the required work practices in this subpart will be evaluated by the following guidelines:

(1) Each owner or operator applying for a determination of equivalence shall be responsible for collecting and verifying test data to demonstrate equivalence of an equivalent means of emission limitation.

(2) For each affected facility for which a determination of equivalence is requested, the emission reduction achieved by the required work practice shall be demonstrated.

(3) For each affected facility, for which a determination of equivalence is requested, the emission reduction achieved by the equivalent means of emission limitation shall be demonstrated.

(4) Each owner or operator applying for a determination of equivalence shall commit in writing to work practice(s) that provide for emission reductions equal to or greater than the emission reductions achieved by the required work practice.

(5) The Administrator will compare the demonstrated emission reduction for the equivalent means of emission limitation to the demonstrated emission reduction for the required work practices and will consider the commitment in paragraph (c)(4).

(6) The Administrator may condition the approval of equivalence on requirements that may be necessary to assure operation and maintenance to achieve the same emission reduction as the required work practice.

(d) An owner or operator may offer a unique approach to demonstrate the equivalence of any equivalent means of emission limitation.

(e)(1) After a request for determination of equivalence is received, the Administrator will publish a notice in the FEDERAL REGISTER and provide the opportunity for public hearing if the Administrator judges that the request may be approved.

(2) After notice and opportunity for public hearing, the Administrator will determine the equivalence of a means of emission limitation and will publish the determination in the FEDERAL REGISTER.

(3) Any equivalent means of emission limitations approved under this section shall constitute a required work practice, equipment, design, or operational standard within the meaning of section 111(h)(1) of the Clean Air Act.

(f)(1) Manufacturers of equipment used to control equipment leaks of VOC may apply to the Administrator for determination of equivalence for any equivalent means of emission limitation that achieves a reduction in emissions of VOC achieved by the equipment, design, and operational requirements of this subpart.

(2) The Administrator will make an equivalence determination according to the provisions of paragraphs (b), (c), (d), and (e) of this section.

[48 FR 48335, Oct. 18, 1983, as amended at 65 FR 61762, Oct. 17, 2000; 72 FR 64882, Nov. 16, 2007]

 [Back to Top](#)

§60.485 Test methods and procedures.

(a) In conducting the performance tests required in §60.8, the owner or operator shall use as reference methods and procedures the test methods in appendix A of this part or other methods and procedures as specified in this section, except as provided in §60.8(b).

(b) The owner or operator shall determine compliance with the standards in §§60.482-1 through 60.482-10, 60.483, and 60.484 as follows:

(1) Method 21 shall be used to determine the presence of leaking sources. The instrument shall be calibrated before use each day of its use by the procedures specified in Method 21. The following calibration gases shall be used:

(i) Zero air (less than 10 ppm of hydrocarbon in air); and

(ii) A mixture of methane or n-hexane and air at a concentration of about, but less than, 10,000 ppm methane or n-hexane.

(c) The owner or operator shall determine compliance with the no detectable emission standards in §§60.482-2(e), 60.482-3(i), 60.482-4, 60.482-7(f), and 60.482-10(e) as follows:

(1) The requirements of paragraph (b) shall apply.

(2) Method 21 shall be used to determine the background level. All potential leak interfaces shall be traversed as close to the interface as possible. The arithmetic difference between the maximum concentration indicated by the instrument and the background level is compared with 500 ppm for determining compliance.

(d) The owner or operator shall test each piece of equipment unless he demonstrates that a process unit is not in VOC service, i.e., that the VOC content would never be reasonably expected to exceed 10 percent by weight. For purposes of this demonstration, the following methods and procedures shall be used:

(1) Procedures that conform to the general methods in ASTM E260-73, 91, or 96, E168-67, 77, or 92, E169-63, 77, or 93 (incorporated by reference—see §60.17) shall be used to determine the percent VOC content in the process fluid that is contained in or contacts a piece of equipment.

(2) Organic compounds that are considered by the Administrator to have negligible photochemical reactivity may be excluded from the total quantity of organic compounds in determining the VOC content of the process fluid.

(3) Engineering judgment may be used to estimate the VOC content, if a piece of equipment had not been shown previously to be in service. If the Administrator disagrees with the judgment, paragraphs (d) (1) and (2) of this section shall be used to resolve the disagreement.

(e) The owner or operator shall demonstrate that a piece of equipment is in light liquid service by showing that all the following conditions apply:

(1) The vapor pressure of one or more of the organic components is greater than 0.3 kPa at 20 °C (1.2 in. H₂O at 68 °F). Standard reference texts or ASTM D2879-83, 96, or 97 (incorporated by reference—see §60.17) shall be used to determine the vapor pressures.

(2) The total concentration of the pure organic components having a vapor pressure greater than 0.3 kPa at 20 °C (1.2 in. H₂O at 68 °F) is equal to or greater than 20 percent by weight.

(3) The fluid is a liquid at operating conditions.

(f) Samples used in conjunction with paragraphs (d), (e), and (g) of this section shall be representative of the process fluid that is contained in or contacts the equipment or the gas being combusted in the flare.

(g) The owner or operator shall determine compliance with the standards of flares as follows:

(1) Method 22 shall be used to determine visible emissions.

(2) A thermocouple or any other equivalent device shall be used to monitor the presence of a pilot flame in the flare.

(3) The maximum permitted velocity for air assisted flares shall be computed using the following equation:

$$V_{\max} = K_1 + K_2 H_T$$

[View or download PDF](#)

Where:

V_{\max} = Maximum permitted velocity, m/sec (ft/sec)

H_T = Net heating value of the gas being combusted, MJ/scm (Btu/scf).

K_1 = 8.706 m/sec (metric units)

= 28.56 ft/sec (English units)

K_2 = 0.7084 m²/(MJ-sec) (metric units)

= 0.087 ft²/(Btu-sec) (English units)

(4) The net heating value (H_T) of the gas being combusted in a flare shall be computed using the following equation:

$$H_T = K \sum_{i=1}^n C_i H_i$$

[View or download PDF](#)

Where:

K = Conversion constant, 1.740×10^{-7} (g-mole)(MJ)/(ppm-scm-kcal) (metric units) = 4.674×10^{-6} [(g-mole)(Btu)/(ppm-scf-kcal)] (English units)

C_i = Concentration of sample component "i," ppm

H_i = Net heat of combustion of sample component "i" at 25 °C and 760 mm Hg (77 °F and 14.7 psi), kcal/g-mole

(5) Method 18 or ASTM D6420-99 (2004) (where the target compound(s) are those listed in Section 1.1 of ASTM D6420-99, and the target concentration is between 150 parts per billion by volume and 100 parts per million by volume) and ASTM D2504-67, 77 or 88 (Reapproved 1993) (incorporated by reference—see §60.17) shall be used to determine the concentration of sample component "i."

(6) ASTM D2382-76 or 88 or D4809-95 (incorporated by reference—see §60.17) shall be used to determine the net heat of combustion of component "i" if published values are not available or cannot be calculated.

(7) Method 2, 2A, 2C, or 2D, as appropriate, shall be used to determine the actual exit velocity of a flare. If needed, the unobstructed (free) cross-sectional area of the flare tip shall be used.

(h) The owner or operator shall determine compliance with §60.483-1 or §60.483-2 as follows:

(1) The percent of valves leaking shall be determined using the following equation:

$$\%V_L = (V_L/V_T) * 100$$

Where:

$\%V_L$ = Percent leaking valves

V_L = Number of valves found leaking

V_T = The sum of the total number of valves monitored

(2) The total number of valves monitored shall include difficult-to-monitor and unsafe-to-monitor valves only during the monitoring period in which those valves are monitored.

(3) The number of valves leaking shall include valves for which repair has been delayed.

(4) Any new valve that is not monitored within 30 days of being placed in service shall be included in the number of valves leaking and the total number of valves monitored for the monitoring period in which the valve is placed in service.

(5) If the process unit has been subdivided in accordance with §60.482-7(c)(1)(ii), the sum of valves found leaking during a monitoring period includes all subgroups.

(6) The total number of valves monitored does not include a valve monitored to verify repair.

[54 FR 6678, Feb. 14, 1989, as amended at 54 FR 27016, June 27, 1989; 65 FR 61763, Oct. 17, 2000; 72 FR 64882, Nov. 16, 2007]

 [Back to Top](#)

§60.486 Recordkeeping requirements.

(a)(1) Each owner or operator subject to the provisions of this subpart shall comply with the recordkeeping requirements of this section.

(2) An owner or operator of more than one affected facility subject to the provisions of this subpart may comply with the recordkeeping requirements for these facilities in one recordkeeping system if the system identifies each record by each facility.

(b) When each leak is detected as specified in §§60.482-2, 60.482-3, 60.482-7, 60.482-8, and 60.483-2, the following requirements apply:

(1) A weatherproof and readily visible identification, marked with the equipment identification number, shall be attached to the leaking equipment.

(2) The identification on a valve may be removed after it has been monitored for 2 successive months as specified in §60.482-7(c) and no leak has been detected during those 2 months.

(3) The identification on equipment except on a valve, may be removed after it has been repaired.

(c) When each leak is detected as specified in §§60.482-2, 60.482-3, 60.482-7, 60.482-8, and 60.483-2, the following information shall be recorded in a log and shall be kept for 2 years in a readily accessible location:

(1) The instrument and operator identification numbers and the equipment identification number.

(2) The date the leak was detected and the dates of each attempt to repair the leak.

(3) Repair methods applied in each attempt to repair the leak.

(4) "Above 10,000" if the maximum instrument reading measured by the methods specified in §60.485(a) after each repair attempt is equal to or greater than 10,000 ppm.

(5) "Repair delayed" and the reason for the delay if a leak is not repaired within 15 calendar days after discovery of the leak.

(6) The signature of the owner or operator (or designate) whose decision it was that repair could not be effected without a process shutdown.

(7) The expected date of successful repair of the leak if a leak is not repaired within 15 days.

(8) Dates of process unit shutdowns that occur while the equipment is unrepaired.

(9) The date of successful repair of the leak.

(d) The following information pertaining to the design requirements for closed vent systems and control devices described in §60.482-10 shall be recorded and kept in a readily accessible location:

(1) Detailed schematics, design specifications, and piping and instrumentation diagrams.

(2) The dates and descriptions of any changes in the design specifications.

(3) A description of the parameter or parameters monitored, as required in §60.482-10(e), to ensure that control devices are operated and maintained in conformance with their design and an explanation of why that parameter (or parameters) was selected for the monitoring.

(4) Periods when the closed vent systems and control devices required in §§60.482-2, 60.482-3, 60.482-4, and 60.482-5 are not operated as designed, including periods when a flare pilot light does not have a flame.

(5) Dates of startups and shutdowns of the closed vent systems and control devices required in §§60.482-2, 60.482-3, 60.482-4, and 60.482-5.

(e) The following information pertaining to all equipment subject to the requirements in §§60.482-1 to 60.482-10 shall be recorded in a log that is kept in a readily accessible location:

(1) A list of identification numbers for equipment subject to the requirements of this subpart.

(2)(i) A list of identification numbers for equipment that are designated for no detectable emissions under the provisions of §§60.482-2(e), 60.482-3(i) and 60.482-7(f).

(ii) The designation of equipment as subject to the requirements of §60.482-2(e), §60.482-3(i), or §60.482-7(f) shall be signed by the owner or operator. Alternatively, the owner or operator may establish a mechanism with their permitting authority that satisfies this requirement.

(3) A list of equipment identification numbers for pressure relief devices required to comply with §60.482-4.

(4)(i) The dates of each compliance test as required in §§60.482-2(e), 60.482-3(i), 60.482-4, and 60.482-7(f).

(ii) The background level measured during each compliance test.

(iii) The maximum instrument reading measured at the equipment during each compliance test.

(5) A list of identification numbers for equipment in vacuum service.

(6) A list of identification numbers for equipment that the owner or operator designates as operating in VOC service less than 300 hr/yr in accordance with §60.482-1(e), a description of the conditions under which the equipment is in VOC service, and rationale supporting the designation that it is in VOC service less than 300 hr/yr.

(f) The following information pertaining to all valves subject to the requirements of §60.482-7(g) and (h) and to all pumps subject to the requirements of §60.482-2(g) shall be recorded in a log that is kept in a readily accessible location:

(1) A list of identification numbers for valves and pumps that are designated as unsafe-to-monitor, an explanation for each valve or pump stating why the valve or pump is unsafe-to-monitor, and the plan for monitoring each valve or pump.

(2) A list of identification numbers for valves that are designated as difficult-to-monitor, an explanation for each valve stating why the valve is difficult-to-monitor, and the schedule for monitoring each valve.

(g) The following information shall be recorded for valves complying with §60.483-2:

(1) A schedule of monitoring.

(2) The percent of valves found leaking during each monitoring period.

(h) The following information shall be recorded in a log that is kept in a readily accessible location:

(1) Design criterion required in §§60.482-2(d)(5) and 60.482-3(e)(2) and explanation of the design criterion; and

(2) Any changes to this criterion and the reasons for the changes.

(i) The following information shall be recorded in a log that is kept in a readily accessible location for use in determining exemptions as provided in §60.480(d):

(1) An analysis demonstrating the design capacity of the affected facility,

(2) A statement listing the feed or raw materials and products from the affected facilities and an analysis demonstrating whether these chemicals are heavy liquids or beverage alcohol, and

(3) An analysis demonstrating that equipment is not in VOC service.

(j) Information and data used to demonstrate that a piece of equipment is not in VOC service shall be recorded in a log that is kept in a readily accessible location.

(k) The provisions of §60.7 (b) and (d) do not apply to affected facilities subject to this subpart.

[↑ Back to Top](#)

§60.487 Reporting requirements.

(a) Each owner or operator subject to the provisions of this subpart shall submit semiannual reports to the Administrator beginning six months after the initial startup date.

(b) The initial semiannual report to the Administrator shall include the following information:

(1) Process unit identification.

(2) Number of valves subject to the requirements of §60.482-7, excluding those valves designated for no detectable emissions under the provisions of §60.482-7(f).

(3) Number of pumps subject to the requirements of §60.482-2, excluding those pumps designated for no detectable emissions under the provisions of §60.482-2(e) and those pumps complying with §60.482-2(f).

(4) Number of compressors subject to the requirements of §60.482-3, excluding those compressors designated for no detectable emissions under the provisions of §60.482-3(i) and those compressors complying with §60.482-3(h).

(c) All semiannual reports to the Administrator shall include the following information, summarized from the information in §60.486:

(1) Process unit identification.

(2) For each month during the semiannual reporting period,

(i) Number of valves for which leaks were detected as described in §60.482-7(b) or §60.483-2,

(ii) Number of valves for which leaks were not repaired as required in §60.482-7(d)(1),

(iii) Number of pumps for which leaks were detected as described in §60.482-2(b), (d)(4)(ii)(A) or (B), or (d)(5)(iii),

(iv) Number of pumps for which leaks were not repaired as required in §60.482-2(c)(1) and (d)(6),

(v) Number of compressors for which leaks were detected as described in §60.482-3(f),

(vi) Number of compressors for which leaks were not repaired as required in §60.482-3(g)(1), and

(vii) The facts that explain each delay of repair and, where appropriate, why a process unit shutdown was technically infeasible.

(3) Dates of process unit shutdowns which occurred within the semiannual reporting period.

(4) Revisions to items reported according to paragraph (b) if changes have occurred since the initial report or subsequent revisions to the initial report.

(d) An owner or operator electing to comply with the provisions of §§60.483-1 or 60.483-2 shall notify the Administrator of the alternative standard selected 90 days before implementing either of the provisions.

(e) An owner or operator shall report the results of all performance tests in accordance with §60.8 of the General Provisions. The provisions of §60.8(d) do not apply to affected facilities subject to the provisions of this subpart except that an owner or operator must notify the Administrator of the schedule for the initial performance tests at least 30 days before the initial performance tests.

(f) The requirements of paragraphs (a) through (c) of this section remain in force until and unless EPA, in delegating enforcement authority to a State under section 111(c) of the Act, approves reporting requirements or an alternative means of compliance surveillance adopted by such State. In that event, affected sources within the State will be relieved of the obligation to comply with the requirements of paragraphs (a) through (c) of this section, provided that they comply with the requirements established by the State.

[48 FR 48335, Oct. 18, 1983, as amended at 49 FR 22608, May 30, 1984; 65 FR 61763, Oct. 17, 2000; 72 FR 64883, Nov. 16, 2007]

[↑ Back to Top](#)

§60.488 Reconstruction.

For the purposes of this subpart:

(a) The cost of the following frequently replaced components of the facility shall not be considered in calculating either the “fixed capital cost of the new components” or the “fixed capital costs that would be required to construct a comparable new facility” under §60.15: pump seals, nuts and bolts, rupture disks, and packings.

(b) Under §60.15, the “fixed capital cost of new components” includes the fixed capital cost of all depreciable components (except components specified in §60.488 (a)) which are or will be replaced pursuant to all continuous programs of component replacement which are commenced within any 2-year period following the applicability date for the appropriate subpart. (See the “Applicability and designation of affected facility” section of the appropriate subpart.) For purposes of this paragraph, “commenced” means that an owner or operator has undertaken a continuous program of component replacement or that an owner or operator has entered into a contractual obligation to undertake and complete, within a reasonable time, a continuous program of component replacement.

[49 FR 22608, May 30, 1984]

[↑ Back to Top](#)

§60.489 List of chemicals produced by affected facilities.

The following chemicals are produced, as intermediates or final products, by process units covered under this subpart. The applicability date for process units producing one or more of these chemicals is January 5, 1981.

CAS No. ^a	Chemical
105-57-7	Acetal.

75-07-0	Acetaldehyde.
107-89-1	Acetaldol.
60-35-5	Acetamide.
103-84-4	Acetanilide.
64-19-7	Acetic acid.
108-24-7	Acetic anhydride.
67-64-1	Acetone.
75-86-5	Acetone cyanohydrin.
75-05-8	Acetonitrile.
98-86-2	Acetophenone.
75-36-5	Acetyl chloride.
74-86-2	Acetylene.
107-02-8	Acrolein.
79-06-1	Acrylamide.
79-10-7	Acrylic acid.
107-13-1	Acrylonitrile.
124-04-9	Adipic acid.
111-69-3	Adiponitrile.
(^b)	Alkyl naphthalenes.
107-18-6	Allyl alcohol.
107-05-1	Allyl chloride.
1321-11-5	Aminobenzoic acid.
111-41-1	Aminoethylethanolamine.
123-30-8	p-Aminophenol.
628-63-7, 123-92-2	Amyl acetates.
71-41-0 ^c	Amyl alcohols.
110-58-7	Amyl amine.
543-59-9	Amyl chloride.
110-66-7 ^c	Amyl mercaptans.
1322-06-1	Amyl phenol.

62-53-3	Aniline.
142-04-1	Aniline hydrochloride.
29191-52-4	Anisidine.
100-66-3	Anisole.
118-92-3	Anthranilic acid.
84-65-1	Anthraquinone.
100-52-7	Benzaldehyde.
55-21-0	Benzamide.
71-43-2	Benzene.
98-48-6	Benzenedisulfonic acid.
98-11-3	Benzenesulfonic acid.
134-81-6	Benzil.
76-93-7	Benzilic acid.
65-85-0	Benzoic acid.
119-53-9	Benzoin.
100-47-0	Benzonitrile.
119-61-9	Benzophenone.
98-07-7	Benzotrichloride.
98-88-4	Benzoyl chloride.
100-51-6	Benzyl alcohol.
100-46-9	Benzylamine.
120-51-4	Benzyl benzoate.
100-44-7	Benzyl chloride.
98-87-3	Benzyl dichloride.
92-52-4	Biphenyl.
80-05-7	Bisphenol A.
10-86-1	Bromobenzene.
27497-51-4	Bromonaphthalene.
106-99-0	Butadiene.
106-98-9	1-butene.

123-86-4	n-butyl acetate.
141-32-2	n-butyl acrylate.
71-36-3	n-butyl alcohol.
78-92-2	s-butyl alcohol.
75-65-0	t-butyl alcohol.
109-73-9	n-butylamine.
13952-84-6	s-butylamine.
75-64-9	t-butylamine.
98-73-7	p-tert-butyl benzoic acid.
107-88-0	1,3-butylene glycol.
123-72-8	n-butyraldehyde.
107-92-6	Butyric acid.
106-31-0	Butyric anhydride.
109-74-0	Butyronitrile.
105-60-2	Caprolactam.
75-1-50	Carbon disulfide.
558-13-4	Carbon tetrabromide.
56-23-5	Carbon tetrachloride.
9004-35-7	Cellulose acetate.
79-11-8	Chloroacetic acid.
108-42-9	m-chloroaniline.
95-51-2	o-chloroaniline.
106-47-8	p-chloroaniline.
35913-09-8	Chlorobenzaldehyde.
108-90-7	Chlorobenzene.
118-91-2, 535-80-8, 74-11-3 ^c	Chlorobenzoic acid.
2136-81-4, 2136-89-2, 5216-25-1 ^c	Chlorobenzotrichloride.
1321-03-5	Chlorobenzoyl chloride.
25497-29-4	Chlorodifluoromethane.
75-45-6	Chlorodifluoroethane.

67-66-3	Chloroform.
25586-43-0	Chloronaphthalene.
88-73-3	o-chloronitrobenzene.
100-00-5	p-chloronitrobenzene.
25167-80-0	Chlorophenols.
126-99-8	Chloroprene.
7790-94-5	Chlorosulfonic acid.
108-41-8	m-chlorotoluene.
95-49-8	o-chlorotoluene.
106-43-4	p-chlorotoluene.
75-72-9	Chlorotrifluoromethane.
108-39-4	m-cresol.
95-48-7	o-cresol.
106-44-5	p-cresol.
1319-77-3	Mixed cresols.
1319-77-3	Cresylic acid.
4170-30-0	Crotonaldehyde.
3724-65-0	Crotonic acid.
98-82-8	Cumene.
80-15-9	Cumene hydroperoxide.
372-09-8	Cyanoacetic acid.
506-77-4	Cyanogen chloride.
108-80-5	Cyanuric acid.
108-77-0	Cyanuric chloride.
110-82-7	Cyclohexane.
108-93-0	Cyclohexanol.
108-94-1	Cyclohexanone.
110-83-8	Cyclohexene.
108-91-8	Cyclohexylamine.
111-78-4	Cyclooctadiene.

112-30-1	Decanol.
123-42-2	Diacetone alcohol.
27576-04-1	Diaminobenzoic acid.
95-76-1, 95-82-9, 554-00-7, 608-27-5, 608-31-1, 626-43-7, 27134-27-6, 57311-92-9 ^c	Dichloroaniline.
541-73-1	m-dichlorobenzene.
95-50-1	o-dichlorobenzene.
106-46-7	p-dichlorobenzene.
75-71-8	Dichlorodifluoromethane.
111-44-4	Dichloroethyl ether.
107-06-2	1,2-dichloroethane (EDC).
96-23-1	Dichlorohydrin.
26952-23-8	Dichloropropene.
101-83-7	Dicyclohexylamine.
109-89-7	Diethylamine.
111-46-6	Diethylene glycol.
112-36-7	Diethylene glycol diethyl ether.
111-96-6	Diethylene glycol dimethyl ether.
112-34-5	Diethylene glycol monobutyl ether.
124-17-4	Diethylene glycol monobutyl ether acetate.
111-90-0	Diethylene glycol monoethyl ether.
112-15-2	Diethylene glycol monoethyl ether acetate.
111-77-3	Diethylene glycol monomethyl ether.
64-67-5	Diethyl sulfate.
75-37-6	Difluoroethane.
25167-70-8	Diisobutylene.
26761-40-0	Diisodecyl phthalate.
27554-26-3	Diisooctyl phthalate.
674-82-8	Diketene.

124-40-3	Dimethylamine.
121-69-7	N,N-dimethylaniline.
115-10-6	N,N-dimethyl ether.
68-12-2	N,N-dimethylformamide.
57-14-7	Dimethylhydrazine.
77-78-1	Dimethyl sulfate.
75-18-3	Dimethyl sulfide.
67-68-5	Dimethyl sulfoxide.
120-61-6	Dimethyl terephthalate.
99-34-3	3,5-dinitrobenzoic acid.
51-28-5	Dinitrophenol.
25321-14-6	Dinitrotoluene.
123-91-1	Dioxane.
646-06-0	Dioxilane.
122-39-4	Diphenylamine.
101-84-8	Diphenyl oxide.
102-08-9	Diphenyl thiourea.
25265-71-8	Dipropylene glycol.
25378-22-7	Dodecene.
28675-17-4	Dodecylaniline.
27193-86-8	Dodecylphenol.
106-89-8	Epichlorohydrin.
64-17-5	Ethanol.
141-43-5 ^c	Ethanolamines.
141-78-6	Ethyl acetate.
141-97-9	Ethyl acetoacetate.
140-88-5	Ethyl acrylate.
75-04-7	Ethylamine.
100-41-4	Ethylbenzene.
74-96-4	Ethyl bromide.

9004-57-3	Ethylcellulose.
75-00-3	Ethyl chloride.
105-39-5	Ethyl chloroacetate.
105-56-6	Ethylcyanoacetate.
74-85-1	Ethylene.
96-49-1	Ethylene carbonate.
107-07-3	Ethylene chlorohydrin.
107-15-3	Ethylenediamine.
106-93-4	Ethylene dibromide.
107-21-1	Ethylene glycol.
111-55-7	Ethylene glycol diacetate.
110-71-4	Ethylene glycol dimethyl ether.
111-76-2	Ethylene glycol monobutyl ether.
112-07-2	Ethylene glycol monobutyl ether acetate.
110-80-5	Ethylene glycol monoethyl ether.
111-15-9	Ethylene glycol monethyl ether acetate.
109-86-4	Ethylene glycol monomethyl ether.
110-49-6	Ethylene glycol monomethyl ether acetate.
122-99-6	Ethylene glycol monophenyl ether.
2807-30-9	Ethylene glycol monopropyl ether.
75-21-8	Ethylene oxide.
60-29-7	Ethyl ether
104-76-7	2-ethylhexanol.
122-51-0	Ethyl orthoformate.
95-92-1	Ethyl oxalate.
41892-71-1	Ethyl sodium oxalacetate.
50-00-0	Formaldehyde.
75-12-7	Formamide.
64-18-6	Formic acid.

110-17-8	Fumaric acid.
98-01-1	Furfural.
56-81-5	Glycerol.
26545-73-7	Glycerol dichlorohydrin.
25791-96-2	Glycerol triether.
56-40-6	Glycine.
107-22-2	Glyoxal.
118-74-1	Hexachlorobenzene.
67-72-1	Hexachloroethane.
36653-82-4	Hexadecyl alcohol.
124-09-4	Hexamethylenediamine.
629-11-8	Hexamethylene glycol.
100-97-0	Hexamethylenetetramine.
74-90-8	Hydrogen cyanide.
123-31-9	Hydroquinone.
99-96-7	p-hydroxybenzoic acid.
26760-64-5	Isoamylene.
78-83-1	Isobutanol.
110-19-0	Isobutyl acetate.
115-11-7	Isobutylene.
78-84-2	Isobutyraldehyde.
79-31-2	Isobutyric acid.
25339-17-7	Isodecanol.
26952-21-6	Isooctyl alcohol.
78-78-4	Isopentane.
78-59-1	Isophorone.
121-91-5	Isophthalic acid.
78-79-5	Isoprene.
67-63-0	Isopropanol.
108-21-4	Isopropyl acetate.

75-31-0	Isopropylamine.
75-29-6	Isopropyl chloride.
25168-06-3	Isopropylphenol.
463-51-4	Ketene.
(^b)	Linear alkyl sulfonate.
123-01-3	Linear alkylbenzene (linear dodecylbenzene).
110-16-7	Maleic acid.
108-31-6	Maleic anhydride.
6915-15-7	Malic acid.
141-79-7	Mesityl oxide.
121-47-1	Metanilic acid.
79-41-4	Methacrylic acid.
563-47-3	Methallyl chloride.
67-56-1	Methanol.
79-20-9	Methyl acetate.
105-45-3	Methyl acetoacetate.
74-89-5	Methylamine.
100-61-8	n-methylaniline.
74-83-9	Methyl bromide.
37365-71-2	Methyl butynol.
74-87-3	Methyl chloride.
108-87-2	Methylcyclohexane.
1331-22-2	Methylcyclohexanone.
75-09-2	Methylene chloride.
101-77-9	Methylene dianiline.
101-68-8	Methylene diphenyl diisocyanate.
78-93-3	Methyl ethyl ketone.
107-31-3	Methyl formate.
108-11-2	Methyl isobutyl carbinol.

108-10-1	Methyl isobutyl ketone.
80-62-6	Methyl methacrylate.
77-75-8	Methylpentynol.
98-83-9	a-methylstyrene.
110-91-8	Morpholine.
85-47-2	a-naphthalene sulfonic acid.
120-18-3	b-naphthalene sulfonic acid.
90-15-3	a-naphthol.
135-19-3	b-naphthol.
75-98-9	Neopentanoic acid.
88-74-4	o-nitroaniline.
100-01-6	p-nitroaniline.
91-23-6	o-nitroanisole.
100-17-4	p-nitroanisole.
98-95-3	Nitrobenzene.
27178-83-2 ^c	Nitrobenzoic acid (o,m, and p).
79-24-3	Nitroethane.
75-52-5	Nitromethane.
88-75-5	2-Nitrophenol.
25322-01-4	Nitropropane.
1321-12-6	Nitrotoluene.
27215-95-8	Nonene.
25154-52-3	Nonylphenol.
27193-28-8	Octylphenol.
123-63-7	Paraldehyde.
115-77-5	Pentaerythritol.
109-66-0	n-pentane.
109-67-1	1-pentene
127-18-4	Perchloroethylene.
594-42-3	Perchloromethyl mercaptan.

94-70-2	o-phenetidine.
156-43-4	p-phenetidine.
108-95-2	Phenol.
98-67-9, 585-38-6, 609-46-1, 1333-39-7 ^c	Phenolsulfonic acids.
91-40-7	Phenyl anthranilic acid.
(^b)	Phenylenediamine.
75-44-5	Phosgene.
85-44-9	Phthalic anhydride.
85-41-6	Phthalimide.
108-99-6	b-picoline.
110-85-0	Piperazine.
9003-29-6, 25036-29-7 ^c	Polybutenes.
25322-68-3	Polyethylene glycol.
25322-69-4	Polypropylene glycol.
123-38-6	Propionaldehyde.
79-09-4	Propionic acid.
71-23-8	n-propyl alcohol.
107-10-8	Propylamine.
540-54-5	Propyl chloride.
115-07-1	Propylene.
127-00-4	Propylene chlorohydrin.
78-87-5	Propylene dichloride.
57-55-6	Propylene glycol.
75-56-9	Propylene oxide.
110-86-1	Pyridine.
106-51-4	Quinone.
108-46-3	Resorcinol.
27138-57-4	Resorcylic acid.
69-72-7	Salicylic acid.
127-09-3	Sodium acetate.

532-32-1	Sodium benzoate.
9004-32-4	Sodium carboxymethyl cellulose.
3926-62-3	Sodium chloroacetate.
141-53-7	Sodium formate.
139-02-6	Sodium phenate.
110-44-1	Sorbic acid.
100-42-5	Styrene.
110-15-6	Succinic acid.
110-61-2	Succinonitrile.
121-57-3	Sulfanilic acid.
126-33-0	Sulfolane.
1401-55-4	Tannic acid.
100-21-0	Terephthalic acid.
79-34-5 ^c	Tetrachloroethanes.
117-08-8	Tetrachlorophthalic anhydride.
78-00-2	Tetraethyl lead.
119-64-2	Tetrahydronaphthalene.
85-43-8	Tetrahydrophthalic anhydride.
75-74-1	Tetramethyl lead.
110-60-1	Tetramethylenediamine.
110-18-9	Tetramethylethylenediamine.
108-88-3	Toluene.
95-80-7	Toluene-2,4-diamine.
584-84-9	Toluene-2,4-diisocyanate.
26471-62-5	Toluene diisocyanates (mixture).
1333-07-9	Toluenesulfonamide.
104-15-4 ^c	Toluenesulfonic acids.
98-59-9	Toluenesulfonyl chloride.
26915-12-8	Toluidines.
87-61-6, 108-70-3, 120-82-1 ^c	Trichlorobenzenes.

71-55-6	1,1,1-trichloroethane.
79-00-5	1,1,2-trichloroethane.
79-01-6	Trichloroethylene.
75-69-4	Trichlorofluoromethane.
96-18-4	1,2,3-trichloropropane.
76-13-1	1,1,2-trichloro-1,2,2-trifluoroethane.
121-44-8	Triethylamine.
112-27-6	Triethylene glycol.
112-49-2	Triethylene glycol dimethyl ether.
7756-94-7	Triisobutylene.
75-50-3	Trimethylamine.
57-13-6	Urea.
108-05-4	Vinyl acetate.
75-01-4	Vinyl chloride.
75-35-4	Vinylidene chloride.
25013-15-4	Vinyl toluene.
1330-20-7	Xylenes (mixed).
95-47-6	o-xylene.
106-42-3	p-xylene.
1300-71-6	Xylenol.
1300-73-8	Xylidine.

^aCAS numbers refer to the Chemical Abstracts Registry numbers assigned to specific chemicals, isomers, or mixtures of chemicals. Some isomers or mixtures that are covered by the standards do not have CAS numbers assigned to them. The standards apply to all of the chemicals listed, whether CAS numbers have been assigned or not.

^bNo CAS number(s) have been assigned to this chemical, its isomers, or mixtures containing these chemicals.

^cCAS numbers for some of the isomers are listed; the standards apply to all of the isomers and mixtures, even if CAS numbers have not been assigned.

Appendix F

Subpart NNN—Standards of Performance for Volatile Organic Compound (VOC) Emissions From Synthetic Organic Chemical Manufacturing Industry (SOCMI) Distillation Operations

Contents

[§60.660 Applicability and designation of affected facility.](#)

[§60.661 Definitions.](#)

[§60.662 Standards.](#)

[§60.663 Monitoring of emissions and operations.](#)

[§60.664 Test methods and procedures.](#)

[§60.665 Reporting and recordkeeping requirements.](#)

[§60.666 Reconstruction.](#)

[§60.667 Chemicals affected by subpart NNN.](#)

[§60.668 Delegation of authority.](#)

SOURCE: 55 FR 26942, June 29, 1990, unless otherwise noted.

[↑ Back to Top](#)

§60.660 Applicability and designation of affected facility.

(a) The provisions of this subpart apply to each affected facility designated in paragraph (b) of this section that is part of a process unit that produces any of the chemicals listed in §60.667 as a product, co-product, by-product, or intermediate, except as provided in paragraph (c).

(b) The affected facility is any of the following for which construction, modification, or reconstruction commenced after December 30, 1983:

(1) Each distillation unit not discharging its vent stream into a recovery system.

(2) Each combination of a distillation unit and the recovery system into which its vent stream is discharged.

(3) Each combination of two or more distillation units and the common recovery system into which their vent streams are discharged.

(c) Exemptions from the provisions of paragraph (a) of this section are as follows:

(1) Any distillation unit operating as part of a process unit which produces coal tar or beverage alcohols, or which uses, contains, and produces no VOC is not an affected facility.

(2) Any distillation unit that is subject to the provisions of subpart DDD is not an affected facility.

(3) Any distillation unit that is designed and operated as a batch operation is not an affected facility.

(4) Each affected facility that has a total resource effectiveness (TRE) index value greater than 8.0 is exempt from all provisions of this subpart except for §§60.662; 60.664 (e), (f), and (g); and 60.665 (h) and (l).

(5) Each affected facility in a process unit with a total design capacity for all chemicals produced within that unit of less than one gigagram per year is exempt from all provisions of this subpart except for the recordkeeping and reporting requirements in paragraphs (j), (l)(6), and (n) of §60.665.

(6) Each affected facility operated with a vent stream flow rate less than 0.008 scm/min is exempt from all provisions of this subpart except for the test method and procedure and the recordkeeping and reporting requirements in §60.664(g) and paragraphs (i), (l)(5), and (o) of §60.665.

(d) *Alternative means of compliance*—(1) *Option to comply with part 65.* Owners or operators of process vents that are subject to this subpart may choose to comply with the provisions of 40 CFR part 65, subpart D, to satisfy the requirements of §§60.662 through 60.665 and 60.668. The provisions of 40 CFR part 65 also satisfy the criteria of paragraphs (c)(4) and (6) of this section. Other provisions applying to an owner or operator who chooses to comply with 40 CFR part 65 are provided in 40 CFR 65.1.

(2) *Part 60, subpart A.* Owners or operators who choose to comply with 40 CFR part 65, subpart D, must also comply with §§60.1, 60.2, 60.5, 60.6, 60.7(a)(1) and (4), 60.14, 60.15, and 60.16 for those process vents. All sections and paragraphs of subpart A of this part that are not mentioned in this paragraph (d)(2) do not apply to owners or operators of process vents complying with 40 CFR part 65, subpart D, except that provisions required to be met prior to implementing 40 CFR part 65 still apply. Owners and operators who choose to comply with 40 CFR part 65, subpart D, must comply with 40 CFR part 65, subpart A.

(3) *Compliance date.* Owners or operators who choose to comply with 40 CFR part 65, subpart D, at initial startup shall comply with paragraphs (d)(1) and (2) of this section for each vent stream on and after the date on which the initial performance test is completed, but not later than 60 days after achieving the maximum production rate at which the affected facility will be operated, or 180 days after the initial startup, whichever date comes first.

(4) *Initial startup notification.* Each owner or operator subject to the provisions of this subpart that chooses to comply with 40 CFR part 65, subpart D, at initial startup shall notify the Administrator of the specific provisions of 40 CFR 65.63(a)(1), (2), or (3), with which the owner or operator has elected to comply. Notification shall be submitted with the notifications of initial startup required by 40 CFR 65.5(b).

[NOTE: The intent of these standards is to minimize the emissions of VOC through the application of best demonstrated technology (BDT). The numerical emission limits in these standards are expressed in terms of total organic compounds (TOC), measured as TOC less methane and ethane. This emission limit reflects the performance of BDT.]

[55 FR 26942, June 29, 2000, as amended at 65 FR 78279, Dec. 14, 2000; 79 FR 11251, Feb. 27, 2014]

 [Back to Top](#)

§60.661 Definitions.

As used in this subpart, all terms not defined here shall have the meaning given them in the Act and in subpart A of part 60, and the following terms shall have the specific meanings given them.

Batch distillation operation means a noncontinuous distillation operation in which a discrete quantity or batch of liquid feed is charged into a distillation unit and distilled at one time. After the initial charging of the liquid feed, no additional liquid is added during the distillation operation.

Boiler means any enclosed combustion device that extracts useful energy in the form of steam.

By compound means by individual stream components, not carbon equivalents.

Continuous recorder means a data recording device recording an instantaneous data value at least once every 15 minutes.

Distillation operation means an operation separating one or more feed stream(s) into two or more exit stream(s), each exit stream having component concentrations different from those in the feed stream(s). The separation is achieved by the redistribution of the components between the liquid and vapor-phase as they approach equilibrium within the distillation unit.

Distillation unit means a device or vessel in which distillation operations occur, including all associated internals (such as trays or packing) and accessories (such as reboiler, condenser, vacuum pump, steam jet, etc.), plus any associated recovery system.

Flame zone means the portion of the combustion chamber in a boiler occupied by the flame envelope.

Flow indicator means a device which indicates whether gas flow is present in a vent stream.

Halogenated vent stream means any vent stream determined to have a total concentration (by volume) of compounds containing halogens of 20 ppmv (by compound) or greater.

Incinerator means any enclosed combustion device that is used for destroying organic compounds and does not extract energy in the form of steam or process heat.

Process heater means a device that transfers heat liberated by burning fuel to fluids contained in tubes, including all fluids except water that is heated to produce steam.

Process unit means equipment assembled and connected by pipes or ducts to produce, as intermediates or final products, one or more of the chemicals in §60.667. A process unit can operate independently if supplied with sufficient fuel or raw materials and sufficient product storage facilities.

Product means any compound or chemical listed in §60.667 that is produced for sale as a final product as that chemical, or for use in the production of other chemicals or compounds. By-products, co-products, and intermediates are considered to be products.

Recovery device means an individual unit of equipment, such as an absorber, carbon adsorber, or condenser, capable of and used for the purpose of recovering chemicals for use, reuse, or sale.

Recovery system means an individual recovery device or series of such devices applied to the same vent stream.

Total organic compounds (TOC) means those compounds measured according to the procedures in §60.664(b)(4). For the purposes of measuring molar composition as required in §60.664(d)(2)(i); hourly emissions rate as required in §60.664(d)(5) and §60.664(e); and TOC concentration as required in §60.665(b)(4) and §60.665(g)(4), those compounds which the Administrator has determined do not contribute appreciably to the formation of ozone are to be excluded. The compounds to be excluded are identified in Environmental Protection Agency's statements on ozone abatement policy for State Implementation Plans (SIP) revisions (42 FR 35314; 44 FR 32042; 45 FR 32424; 45 FR 48942).

TRE index value means a measure of the supplemental total resource requirement per unit reduction of TOC associated with an individual distillation vent stream, based on vent stream flow rate, emission rate of TOC net heating value, and corrosion properties (whether or not the vent stream is halogenated), as quantified by the equation given under §60.664(e).

Vent stream means any gas stream discharged directly from a distillation facility to the atmosphere or indirectly to the atmosphere after diversion through other process equipment. The vent stream excludes relief valve discharges and equipment leaks including, but not limited to, pumps, compressors, and valves.

[↑ Back to Top](#)

§60.662 Standards.

Each owner or operator of any affected facility shall comply with paragraph (a), (b), or (c) of this section for each vent stream on and after the date on which the initial performance test required by §60.8 and §60.664 is completed, but not later than 60 days after achieving the maximum production rate at which the affected facility will be operated, or 180 days after the initial start-up, whichever date comes first. Each owner or operator shall either:

(a) Reduce emissions of TOC (less methane and ethane) by 98 weight-percent, or to a TOC (less methane and ethane) concentration of 20 ppmv, on a dry basis corrected to 3 percent oxygen, whichever is less stringent. If a boiler or process heater is used to comply with this paragraph, then the vent stream shall be introduced into the flame zone of the boiler or process heater; or

(b) Combust the emissions in a flare that meets the requirements of §60.18; or

(c) Maintain a TRE index value greater than 1.0 without use of VOC emission control devices.

[↑ Back to Top](#)

§60.663 Monitoring of emissions and operations.

(a) The owner or operator of an affected facility that uses an incinerator to seek to comply with the TOC emission limit specified under §60.662(a) shall install, calibrate, maintain, and operate according to manufacturer's specifications the following equipment:

(1) A temperature monitoring device equipped with a continuous recorder and having an accuracy of ± 1 percent of the temperature being monitored expressed in degrees Celsius or ± 0.5 °C, whichever is greater.

(i) Where an incinerator other than a catalytic incinerator is used, a temperature monitoring device shall be installed in the firebox.

(ii) Where a catalytic incinerator is used, temperature monitoring devices shall be installed in the gas stream immediately before and after the catalyst bed.

(2) A flow indicator that provides a record of vent stream flow to the incinerator at least once every hour for each affected facility. The flow indicator shall be installed in the vent stream from each affected facility at a point closest to the inlet of each incinerator and before being joined with any other vent stream.

(b) The owner or operator of an affected facility that uses a flare to seek to comply with §60.662(b) shall install, calibrate, maintain and operate according to manufacturer's specifications the following equipment:

(1) A heat sensing device, such as an ultra-violet beam sensor or thermocouple, at the pilot light to indicate the continuous presence of a flame.

(2) A flow indicator that provides a record of vent stream flow to the flare at least once every hour for each affected facility. The flow indicator shall be installed in the vent stream from each affected facility at a point closest to the flare and before being joined with any other vent stream.

(c) The owner or operator of an affected facility that uses a boiler or process heater to seek to comply with §60.662(a) shall install, calibrate, maintain and operate according to the manufacturer's specifications the following equipment:

(1) A flow indicator that provides a record of vent stream flow to the boiler or process heater at least once every hour for each affected facility. The flow indicator shall be installed in the vent stream from each distillation unit within an affected facility at a point closest to the inlet of each boiler or process heater and before being joined with any other vent stream.

(2) A temperature monitoring device in the firebox equipped with a continuous recorder and having an accuracy of ± 1 percent of the temperature being measured expressed in degrees Celsius or ± 0.5 °C, whichever is greater, for boilers or process heaters of less than 44 MW (150 million Btu/hr) heat input design capacity.

(d) Monitor and record the periods of operation of the boiler or process heater if the design heat input capacity of the boiler or process heater is 44 MW (150 million Btu/hr) or greater. The records must be readily available for inspection.

(e) The owner or operator of an affected facility that seeks to comply with the TRE index value limit specified under §60.662(c) shall install, calibrate, maintain, and operate according to manufacturer's specifications the following equipment, unless alternative monitoring procedures or requirements are approved for that facility by the Administrator:

(1) Where an absorber is the final recovery device in the recovery system:

(i) A scrubbing liquid temperature monitoring device having an accuracy of ± 1 percent of the temperature being monitored expressed in degrees Celsius or ± 0.5 °C, whichever is greater, and a specific gravity monitoring device having an accuracy of ± 0.02 specific gravity units, each equipped with a continuous recorder, or

(ii) An organic monitoring device used to indicate the concentration level of organic compounds exiting the recovery device based on a detection principle such as infrared, photoionization, or thermal conductivity, each equipped with a continuous recorder.

(2) Where a condenser is the final recovery device in the recovery system:

(i) A condenser exit (product side) temperature monitoring device equipped with a continuous recorder and having an accuracy of ± 1 percent of the temperature being monitored expressed in degrees Celsius or ± 0.5 °C, whichever is greater, or

(ii) An organic monitoring device used to monitor organic compounds exiting the recovery device based on a detection principle such as infra-red, photoionization, or thermal conductivity, each equipped with a continuous recorder.

(3) Where a carbon adsorber is the final recovery device unit in the recovery system:

(i) An integrating steam flow monitoring device having an accuracy of ± 10 percent, and a carbon bed temperature monitoring device having an accuracy of ± 1 percent of the temperature being monitored expressed in degrees Celsius or ± 0.5 °C, whichever is greater, both equipped with a continuous recorder, or

(ii) An organic monitoring device used to indicate the concentration level of organic compounds exiting the recovery device based on a detection principle such as infra-red, photoionization, or thermal conductivity, each equipped with a continuous recorder.

(f) An owner or operator of an affected facility seeking to demonstrate compliance with the standards specified under §60.662 with control devices other than incinerator, boiler, process heater, or flare; or recovery device other than an absorber, condenser, or carbon adsorber shall provide to the Administrator information describing the operation of the control device or recovery device and the process parameter(s) which would indicate proper operation and maintenance of the device. The Administrator may request further information and will specify appropriate monitoring procedures or requirements.

[55 FR 26942, June 29, 1990, as amended at 65 FR 61774, Oct. 17, 2000]

[↑ Back to Top](#)

§60.664 Test methods and procedures.

(a) For the purpose of demonstrating compliance with §60.662, all affected facilities shall be run at full operating conditions and flow rates during any performance test.

(b) The following methods in appendix A to this part, except as provided under §60.8(b), shall be used as reference methods to determine compliance with the emission limit or percent reduction efficiency specified under §60.662(a).

(1) Method 1 or 1A, as appropriate, for selection of the sampling sites. The control device inlet sampling site for determination of vent stream molar composition or TOC (less methane and ethane) reduction efficiency shall be prior to the inlet of the control device and after the recovery system.

(2) Method 2, 2A, 2C, or 2D, as appropriate, for determination of the gas volumetric flow rates.

(3) The emission rate correction factor, integrated sampling and analysis procedure of Method 3 shall be used to determine the oxygen concentration (%O_{2d}) for the purposes of determining compliance with the 20 ppmv limit. The sampling site shall be the same as that of the TOC samples, and the samples shall be taken during the same time that the TOC samples are taken.

The TOC concentration corrected to 3 percent O₂ (C_c) shall be computed using the following equation:

$$C_c = C_{TOC} \frac{17.9}{20.9 - \%O_{2d}}$$

[View or download PDF](#)

where:

C_c = Concentration of TOC corrected to 3 percent O_2 , dry basis, ppm by volume.

C_{TOC} = Concentration of TOC (minus methane and ethane), dry basis, ppm by volume.

$\%O_{2d}$ = Concentration of O_2 , dry basis, percent by volume.

(4) Method 18 to determine the concentration of TOC in the control device outlet and the concentration of TOC in the inlet when the reduction efficiency of the control device is to be determined.

(i) The sampling time for each run shall be 1 hour in which either an integrated sample or four grab samples shall be taken. If grab sampling is used then the samples shall be taken at 15-minute intervals.

(ii) The emission reduction (R) of TOC (minus methane and ethane) shall be determined using the following equation:

$$R = \frac{E_i - E_o}{E_i} \times 100$$

[View or download PDF](#)

where:

R = Emission reduction, percent by weight.

E_i = Mass rate of TOC entering the control device, kg/hr (lb/hr).

E_o = Mass rate of TOC discharged to the atmosphere, kg/hr (lb/hr).

(iii) The mass rates of TOC (E_i , E_o) shall be computed using the following equations:

$$E_i = K_2 \left(\sum_{j=1}^n C_{ij} M_{ij} \right) Q_i$$

$$E_o = K_2 \left(\sum_{j=1}^n C_{oj} M_{oj} \right) Q_o$$

[View or download PDF](#)

where:

C_{ij} , C_{oj} = Concentration of sample component "j" of the gas stream at the inlet and outlet of the control device, respectively, dry basis, ppm by volume.

M_{ij} , M_{oj} = Molecular weight of sample component "j" of the gas stream at the inlet and outlet of the control device, respectively, g/g-mole (lb/lb-mole).

Q_i , Q_o = Flow rate of gas stream at the inlet and outlet of the control device, respectively, dscm/min (dscf/min).

$K_2 = 2.494 \times 10^{-6}$ (1/ppm)(g-mole/scm) (kg/g) (min/hr) (metric units), where standard temperature for (g-mole/scm) is 20 °C.

$= 1.557 \times 10^{-7}$ (1/ppm) (lb-mole/scf) (min/hr) (English units), where standard temperature for (lb-mole/scf) is 68 °F.

(iv) The TOC concentration (C_{TOC}) is the sum of the individual components and shall be computed for each run using the following equation:

$$C_{TOC} = \sum_{j=1}^n C_j$$

[View or download PDF](#)

where:

C_{TOC} = Concentration of TOC (minus methane and ethane), dry basis, ppm by volume.

C_j = Concentration of sample components "j", dry basis, ppm by volume.

n = Number of components in the sample.

(c) When a boiler or process heater with a design heat input capacity of 44 MW (150 million Btu/hour) or greater is used to seek to comply with §60.662(a), the requirement for an initial performance test is waived, in accordance with §60.8(b). However, the Administrator reserves the option to require testing at such other times as may be required, as provided for in section 114 of the Act.

(d) When a flare is used to seek to comply with §60.662(b), the flare shall comply with the requirements of §60.18.

(e) The following test methods in appendix A to this part, except as provided under §60.8(b), shall be used for determining the net heating value of the gas combusted to determine compliance under §60.662(b) and for determining the process vent stream TRE index value to determine compliance under §60.662(c).

(1)(i) Method 1 or 1A, as appropriate, for selection of the sampling site. The sampling site for the vent stream flow rate and molar composition determination prescribed in §60.664(e)(2) and (3) shall be, except for the situations outlined in paragraph (e)(1)(ii) of this section, prior to the inlet of any control device, prior to any post-distillation dilution of the stream with air, and prior to any post-distillation introduction of halogenated compounds into the process vent stream. No transverse site selection method is needed for vents smaller than 10 centimeters (4 inches) in diameter.

(ii) If any gas stream other than the distillation vent stream from the affected facility is normally conducted through the final recovery device.

(A) The sampling site for vent stream flow rate and molar composition shall be prior to the final recovery device and prior to the point at which the nondistillation stream is introduced.

(B) The efficiency of the final recovery device is determined by measuring the TOC concentration using Method 18 at the inlet to the final recovery device after the introduction of any nondistillation vent stream and at the outlet of the final recovery device.

(C) This efficiency is applied to the TOC concentration measured prior to the final recovery device and prior to the introduction of the nondistillation stream to determine the concentration of TOC in the distillation vent stream from the final recovery device. This concentration of TOC is then used to perform the calculations outlined in §60.664(e)(4) and (5).

(2) The molar composition of the process vent stream shall be determined as follows:

(i) Method 18 to measure the concentration of TOC including those containing halogens.

(ii) ASTM D1946-77 or 90 (Reapproved 1994) (incorporation by reference as specified in §60.17 of this part) to measure the concentration of carbon monoxide and hydrogen.

(iii) Method 4 to measure the content of water vapor.

(3) The volumetric flow rate shall be determined using Method 2, 2A, 2C, or 2D, as appropriate.

(4) The net heating value of the vent stream shall be calculated using the following equation:

$$H_T = K_1 \left(\sum_{j=1}^n C_j H_j \right)$$

[View or download PDF](#)

where:

H_T = Net heating value of the sample, MJ/scm (Btu/scf), where the net enthalpy per mole of vent stream is based on combustion at 25 °C and 760 mm Hg (77 °F and 30 in. Hg), but the standard temperature for determining the volume corresponding to one mole is 20 °C (68 °F).

K_1 = 1.74×10^{-7} (1/ppm) (g-mole/scm) (MJ/kcal) (metric units), where standard temperature for (g-mole/scm) is 20 °C.
 = 1.03×10^{-11} (1/ppm) (lb-mole/scf) (Btu/kcal) (English units) where standard temperature for (lb-mole/scf) is 68 °F.

C_j = Concentration on a wet basis of compound j in ppm, as measured for organics by Method 18 and measured for hydrogen and carbon monoxide by ASTM D1946-77 or 90 (Reapproved 1994) (incorporation by reference as specified in §60.17 of this part) as indicated in §60.664(e)(2).

H_j = Net heat of combustion of compound j, kcal/(g-mole) [kcal/(lb-mole)], based on combustion at 25 °C and 760 mm Hg (77 °F and 30 in. Hg).

The heats of combustion of vent stream components would be required to be determined using ASTM D2382-76 (incorporation by reference as specified in §60.17 of this part) if published values are not available or cannot be calculated.

(5) The emission rate of TOC in the vent stream shall be calculated using the following equation:

$$E_{TOC} = K_2 \left[\sum_{j=1}^n C_j M_j \right] Q_v$$

[View or download PDF](#)

where:

E_{TOC} = Measured emission rate of TOC, kg/hr (lb/hr).

$K_2 = 2.494 \times 10^{-6}$ (1/ppm) (g-mole/scm) (kg/g) (min/hr) (metric units), where standard temperature for (g-mole/scm) is 20 °C.

$= 1.557 \times 10^{-7}$ (1/ppm) (lb-mole/scf) (min/hr) (English units), where standard temperature for (lb-mole/scf) is 68 °F.

C_j = Concentration on a wet basis of compound j in ppm, as measured by Method 18 as indicated in §60.664(e)(2).

M_j = Molecular weight of sample j, g/g-mole (lb/lb-mole).

Q_s = Vent stream flow rate, scm/min (scf/min), at a temperature of 20 °C (68 °F).

(6) The total process vent stream concentration (by volume) of compounds containing halogens (ppmv, by compound) shall be summed from the individual concentrations of compounds containing halogens which were measured by Method 18.

(f) For purposes of complying with §60.662(c) the owner or operator of a facility affected by this subpart shall calculate the TRE index value of the vent stream using the equation for incineration in paragraph (e)(1) of this section for halogenated vent streams. The owner or operator of an affected facility with a nonhalogenated vent stream shall determine the TRE index value by calculating values using both the incinerator equation in (e)(1) and the flare equation in (e)(2) of this section and selecting the lower of the two values.

(1) The equation for calculating the TRE index value of a vent stream controlled by an incinerator is as follows:

$$TRE = \frac{1}{E_{TOC}} \left[a + b(Q_s) + c(Q_s)^{0.88} + d(Q_s)(H_T) + e(Q_s)^{0.88}(H_T)^{0.88} + f(Y_s)^{0.5} \right]$$

[View or download PDF](#)

(i) Where for a vent stream flow rate that is greater than or equal to 14.2 scm/min (501 scf/min) at a standard temperature of 20 °C (68 °F):

TRE = TRE index value.

Q_s = Vent stream flow rate, scm/min (scf/min), at a temperature of 20 °C (68 °F).

H_T = Vent stream net heating value, MJ/scm (Btu/scf), where the net enthalpy per mole of vent stream is based on combustion at 25 °C and 760 mm Hg (68 °F and 30 in. Hg), but the standard temperature for determining the volume corresponding to one mole is 20 °C (68 °F) as in the definition of Q_s .

$Y_s = Q_s$ for all vent stream categories listed in table 1 except for Category E vent streams where $Y_s = Q_s H_T / 3.6$.

E_{TOC} = Hourly emissions of TOC, kg/hr (lb/hr).

a, b, c, d, e, and f are coefficients.

The set of coefficients that apply to a vent stream can be obtained from table 1.

TABLE 1. DISTILLATION NSPS TRE COEFFICIENTS FOR VENT STREAMS

CONTROLLED BY AN INCINERATOR

DESIGN CATEGORY A1. FOR HALOGENATED PROCESS VENT STREAMS, IF $0 \leq$ NET HEATING VALUE (MJ/scm) \leq 3.5 OR IF $0 \leq$ NET HEATING VALUE (Btu/scf) \leq 94:

Q_g = Vent Stream Flow rate scm/min (scf/min)	a	b	c	d	e	f
$14.2 \leq Q_g \leq 18.8$ (501 $\leq Q_g \leq$ 664)	18.84466 (41.54494)	0.26742 (0.016696)	-0.20044 (-0.019194)	0 (0)	0 (0)	0.01025 (0.003803)
$18.8 < Q_g \leq 699$ (664 $< Q_g \leq$ 24,700)	19.66658 (43.35694)	0.26742 (0.016696)	-0.25332 (-0.024258)	0 (0)	0 (0)	0.01025 (0.003803)
$699 < Q_g \leq 1400$ (24,700 $< Q_g \leq$ 49,000)	39.19213 (86.40297)	0.29062 (0.018145)	-0.25332 (-0.024258)	0 (0)	0 (0)	0.01449 (0.005376)
$1400 < Q_g \leq 2100$ (49,000 $< Q_g \leq$ 74,000)	58.71768 (129.4490)	0.30511 (0.019050)	-0.25332 (-0.024258)	0 (0)	0 (0)	0.01775 (0.006585)
$2100 < Q_g \leq 2800$ (74,000 $< Q_g \leq$ 99,000)	78.24323 (172.4950)	0.31582 (0.019718)	-0.25332 (-0.024258)	0 (0)	0 (0)	0.02049 (0.007602)
$2800 < Q_g \leq 3500$ (99,000 $< Q_g \leq$ 120,000)	97.76879 (215.5411)	0.32439 (0.020253)	-0.25332 (-0.024258)	0 (0)	0 (0)	0.02291 (0.008500)

[View or download PDF](#)

DESIGN CATEGORY A2. FOR HALOGENATED PROCESS VENT STREAMS, IF NET HEATING VALUE $<$ 3.5 (MJ/scm) OR IF NET HEATING VALUE $<$ 94 (Btu/scf):

Q_g = Vent Stream Flow rate scm/min(sc f/min)	a	b	c	d	e	f
$14.2 \leq Q_g \leq 18.8$ (501 $\leq Q_g \leq$ 664)	18.84466 (41.54494)	0.26742 (0.016696)	-0.20044 (-0.019194)	0 (0)	0 (0)	0.01025 (0.003803)
$18.8 < Q_g \leq 699$ (664 $< Q_g \leq$ 24,700)	19.66658 (43.35694)	0.26742 (0.016696)	-0.25332 (-0.024258)	0 (0)	0 (0)	0.01025 (0.003803)
$699 < Q_g \leq 1400$ (24,700 $< Q_g \leq$ 49,000)	39.19213 (86.40297)	0.29062 (0.018145)	-0.25332 (-0.024258)	0 (0)	0 (0)	0.01449 (0.005376)
$1400 < Q_g \leq 2100$ (49,000 $< Q_g \leq$ 74,000)	58.71768 (129.4490)	0.30511 (0.019050)	-0.25332 (-0.024258)	0 (0)	0 (0)	0.01775 (0.006585)
$2100 < Q_g \leq 2800$ (74,000 $< Q_g \leq$ 99,000)	78.24323 (172.4950)	0.31582 (0.019718)	-0.25332 (-0.024258)	0 (0)	0 (0)	0.02049 (0.007602)
$2800 < Q_g \leq 3500$ (99,000 $< Q_g \leq$ 120,000)	97.76879 (215.5411)	0.32439 (0.020253)	-0.25332 (-0.024258)	0 (0)	0 (0)	0.02291 (0.008500)

DESIGN CATEGORY B. FOR NONHALOGENATED PROCESS VENT STREAMS, IF $0 \leq$ NET HEATING VALUE (MJ/scm) \leq 0.48 OR IF $0 \leq$ NET HEATING VALUE (Btu/scf) \leq 13:

Q_g = Vent Stream Flow rate scm/min(sc f/min)	a	b	c	d	e	f
$14.2 \leq Q_g \leq 1340$ (501 $\leq Q_g \leq$ 47,300)	8.54245 (18.83268)	0.10555 (0.0085901)	0.09030 (0.008647)	-0.17109 (-0.00039762)	0 (0)	0.01025 (0.003803)
$1340 < Q_g \leq 2690$ (47,300 $< Q_g \leq$ 95,000)	16.94386 (37.35443)	0.11470 (0.0071814)	0.09030 (0.008647)	-0.17109 (-0.00039762)	0 (0)	0.01449 (0.005376)
$2690 < Q_g \leq 4040$ (95,000 $< Q_g \leq$ 143,000)	25.34528 (55.87620)	0.12042 (0.0075185)	0.09030 (0.008647)	-0.17109 (-0.00039762)	0 (0)	0.01775 (0.006585)

[View or download PDF](#)

DESIGN CATEGORY C. FOR NONHALOGENATED PROCESS VENT STREAMS, IF $0.48 < \text{NET HEATING VALUE (MJ/scm)} \leq 1.9$
OR IF $13 < \text{NET HEATING VALUE (Btu/scf)} \leq 51$:

Q_s = Vent Stream Flow rate scm/min(scf/min)	a	b	c	d	e	f
$14.2 \leq Q_s \leq 1340$	9.25233	0.06105	0.31937	-0.16181	0	0.01025
$(501 \leq Q_s \leq 47,300)$	(20.39769)	(0.003812)	(0.030582)	(-0.00037605)	(0)	(0.003803)
$1340 < Q_s \leq 2690$	18.36363	0.06635	0.31937	-0.16181	0	0.01449
$(47,300 < Q_s \leq 95,000)$	(40.48446)	(0.004143)	(0.030582)	(-0.00037605)	(0)	(0.005376)
$2690 < Q_s \leq 4040$	27.47492	0.06965	0.31937	-0.16181	0	0.01775
$(95,000 < Q_s \leq 143,000)$	(60.57121)	(0.004349)	(0.030582)	(-0.00037605)	(0)	(0.006585)

DESIGN CATEGORY D. FOR NONHALOGENATED PROCESS VENT STREAMS, IF $1.9 < \text{NET HEATING VALUE (MJ/scm)} \leq 3.6$
OR IF $51 < \text{NET HEATING VALUE (Btu/scf)} \leq 97$:

Q_s = Vent Stream Flow rate scm/min(scf/min)	a	b	c	d	e	f
$14.2 \leq Q_s \leq 1180$	6.67868	0.06943	0.02582	0	0	0.01025
$(501 \leq Q_s \leq 41,700)$	(14.72382)	(0.004335)	(0.002472)	(0)	(0)	(0.003803)
$1180 < Q_s \leq 2370$	13.21633	0.07546	0.02582	0	0	0.01449
$(41,700 < Q_s \leq 83,700)$	(29.13672)	(0.004711)	(0.002472)	(0)	(0)	(0.005376)
$2370 < Q_s \leq 3550$	19.75398	0.07922	0.02582	0	0	0.01775
$(83,700 < Q_s \leq 125,000)$	(43.54962)	(0.004946)	(0.002472)	(0)	(0)	(0.006585)

[View or download PDF](#)

DESIGN CATEGORY E. FOR NONHALOGENATED PROCESS VENT STREAMS, IF NET HEATING VALUE > 3.6 MJ/scm
OR IF NET HEATING VALUE > 97 (Btu/scf):

Q_s = Vent Stream Flow rate scm/min(scf/min)	a	b	c	d	e	f
$14.2 \leq Y_s \leq 1180$	6.67868	0	0	-0.00707	0.02220	0.01025
$(501 \leq Y_s \leq 41,700)$	(14.72382)	(0)	(0)	(-0.0000164)	(0.0001174)	(0.003803)
$1180 < Y_s \leq 2370$	13.21633	0	0	-0.00707	0.02412	0.01449
$(41,700 < Y_s \leq 83,700)$	(29.13672)	(0)	(0)	(-0.0000164)	(0.0001276)	(0.005376)
$2370 < Y_s \leq 3550$	19.75398	0	0	-0.00707	0.02533	0.01775
$(83,700 < Y_s \leq 125,000)$	(43.54962)	(0)	(0)	(-0.0000164)	(0.0001340)	(0.006585)

[View or download PDF](#)

(ii) Where for a vent stream flow rate that is less than 14.2 scm/min (501 scf/min) at a standard temperature of 20 °C (68 °F):

TRE = TRE index value.

$Q_s = 14.2$ scm/min (501 scf/min).

$H_T = (\text{FLOW}) (HVAL)/Q_s$.

Where the following inputs are used:

FLOW = Vent stream flow rate, scm/min (scf/min), at a temperature of 20 °C (68 °F).

HVAL = Vent stream net heating value, MJ/scm (Btu/scf), where the net enthalpy per mole of vent stream is based on combustion at 25 °C and 760 mm Hg (68 °F and 30 in. Hg), but the standard temperature for determining the volume corresponding to one mole is 20 °C (68 °F) as in the definition of Q_s.

Y_s = Q_s for all vent stream categories listed in table 1 except for Category E vent streams where Y_s = Q_sH_r/3.6.

E_{TOC} = Hourly emissions of TOC, kg/hr (lb/hr).

a, b, c, d, e, and f are coefficients

The set of coefficients that apply to a vent stream can be obtained from table 1.

(2) The equation for calculating the TRE index value of a vent stream controlled by a flare is as follows:

$$TRE = \frac{1}{E_{TOC}} \left[a(Q_s) + b(Q_s)^{0.8} + c(Q_s)(H_r) + d(E_{TOC}) + e \right]$$

[View or download PDF](#)

where:

TRE = TRE index value.

E_{TOC} = Hourly emissions of TOC, kg/hr (lb/hr).

Q_s = Vent stream flow rate, scm/min (scf/min), at a standard temperature of 20 °C (68 °F).

H_r = Vent stream net heating value, MJ/scm (Btu/scf), where the net enthalpy per mole of vent stream is based on combustion at 25 °C and 760 mm Hg (68 °F and 30 in. Hg), but the standard temperature for determining the volume corresponding to one mole is 20 °C (68 °F) as in the definition of Q_s.

a, b, c, d, and e are coefficients.

The set of coefficients that apply to a vent stream shall be obtained from table 2.

TABLE 2—DISTILLATION NSPS TRE COEFFICIENTS FOR VENT STREAMS CONTROLLED BY A FLARE

	a	b	c	d	e
H _r 11.2 MJ/scm	2.25	0.288	-0.193	-0.0051	2.08
(H _r 301 Btu/scf)	(0.140)	(0.0367)	(-0.000448)	(-0.0051)	(4.59)
H _r 11.2 MJ/scm	0.309	0.0619	-0.0043	-0.0034	2.08
(H _r 301 Btu/scf)	(0.0193)	(0.00788)	(-0.0000010)	(-0.0034)	(4.59)

(g) Each owner or operator of an affected facility seeking to comply with §60.660(c)(4) or §60.662(c) shall recalculate the TRE index value for that affected facility whenever process changes are made. Examples of process changes include changes in production capacity, feedstock type, or catalyst type, or whenever there is replacement, removal, or addition of recovery equipment. The TRE index value shall be recalculated based on test data, or on best engineering estimates of the effects of the change to the recovery system.

(1) Where the recalculated TRE index value is less than or equal to 1.0, the owner or operator shall notify the Administrator within 1 week of the recalculation and shall conduct a performance test according to the methods and procedures required by §60.664 in order to determine compliance with §60.662(a). Performance tests must be conducted as soon as possible after the process change but no later than 180 days from the time of the process change.

(2) Where the initial TRE index value is greater than 8.0 and the recalculated TRE index value is less than or equal to 8.0 but greater than 1.0, the owner or operator shall conduct a performance test in accordance with §§60.8 and 60.664 and shall comply with §§60.663, 60.664 and 60.665. Performance tests must be conducted as soon as possible after the process change but no later than 180 days from the time of the process change.

(h) Any owner or operator subject to the provisions of this subpart seeking to demonstrate compliance with §60.660(c)(6) shall use Method 2, 2A, 2C, or 2D as appropriate, for determination of volumetric flow rate.

[55 FR 26942, June 29, 1990, as amended at 65 FR 61774, Oct. 17, 2000]

[↑ Back to Top](#)

§60.665 Reporting and recordkeeping requirements.

(a) Each owner or operator subject to §60.662 shall notify the Administrator of the specific provisions of §60.662 (§60.662 (a), (b), or (c)) with which the owner or operator has elected to comply. Notification shall be submitted with the notification of initial start-up required by §60.7(a)(3). If an owner or operator elects at a later date to use an alternative provision of §60.662 with which he or she will comply, then the Administrator shall be notified by the owner or operator 90 days before implementing a change and, upon implementing the change, a performance test shall be performed as specified by §60.664 within 180 days.

(b) Each owner or operator subject to the provisions of this subpart shall keep an up-to-date, readily accessible record of the following data measured during each performance test, and also include the following data in the report of the initial performance test required under §60.8. Where a boiler or process heater with a design heat input capacity of 44 MW (150 million Btu/hour) or greater is used to comply with §60.662(a), a report containing performance test data need not be submitted, but a report containing the information in §60.665(b)(2)(i) is required. The same data specified in this section shall be submitted in the reports of all subsequently required performance tests where either the emission control efficiency of a control device, outlet concentration of TOC, or the TRE index value of a vent stream from a recovery system is determined.

(1) Where an owner or operator subject to the provisions of this subpart seeks to demonstrate compliance with §60.662(a) through use of either a thermal or catalytic incinerator:

(i) The average firebox temperature of the incinerator (or the average temperature upstream and downstream of the catalyst bed for a catalytic incinerator), measured at least every 15 minutes and averaged over the same time period of the performance testing, and

(ii) The percent reduction of TOC determined as specified in §60.664(b) achieved by the incinerator, or the concentration of TOC (ppmv, by compound) determined as specified in §60.664(b) at the outlet of the control device on a dry basis corrected to 3 percent oxygen.

(2) Where an owner or operator subject to the provisions of this subpart seeks to demonstrate compliance with §60.662(a) through use of a boiler or process heater:

(i) A description of the location at which the vent stream is introduced into the boiler or process heater, and

(ii) The average combustion temperature of the boiler or process heater with a design heat input capacity of less than 44 MW (150 million Btu/hr) measured at least every 15 minutes and averaged over the same time period of the performance testing.

(3) Where an owner or operator subject to the provisions of this subpart seeks to demonstrate compliance with §60.662(b) through use of a smokeless flare, flare design (i.e., steam-assisted, air-assisted or nonassisted), all visible emission readings, heat content determinations, flow rate measurements, and exit velocity determinations made during the performance test, continuous records of the flare pilot flame monitoring, and records of all periods of operations during which the pilot flame is absent.

(4) Where an owner or operator subject to the provisions of this subpart seeks to demonstrate compliance with §60.662(c):

(i) Where an absorber is the final recovery device in the recovery system, the exit specific gravity (or alternative parameter which is a measure of the degree of absorbing liquid saturation, if approved by the Administrator), and average exit temperature, of the absorbing liquid measured at least every 15 minutes and averaged over the same time period of the performance testing (both measured while the vent stream is normally routed and constituted), or

(ii) Where a condenser is the final recovery device in the recovery system, the average exit (product side) temperature measured at least every 15 minutes and averaged over the same time period of the performance testing while the vent stream is routed and constituted normally, or

(iii) Where a carbon adsorber is the final recovery device in the recovery system, the total steam mass flow measured at least every 15 minutes and averaged over the same time period of the performance test (full carbon bed cycle), temperature of the carbon bed after regeneration (and within 15 minutes of completion of any cooling cycle(s)), and duration of the carbon bed steaming cycle (all measured while the vent stream is routed and constituted normally), or

(iv) As an alternative to §60.665(b)(4) ((i), (ii) or (iii)), the concentration level or reading indicated by the organics monitoring device at the outlet of the absorber, condenser, or carbon adsorber, measured at least every 15 minutes and averaged over the same time period of the performance testing while the vent stream is normally routed and constituted.

(v) All measurements and calculations performed to determine the TRE index value of the vent stream.

(c) Each owner or operator subject to the provisions of this subpart shall keep up-to-date, readily accessible continuous records of the equipment operating parameters specified to be monitored under §60.663 (a) and (c) as well as up-to-date, readily accessible records of periods of operation during which the parameter boundaries established during the most recent performance test are exceeded. The Administrator may at any time require a report of these data. Where a combustion device is used to comply with §60.662(a), periods of operation during which the parameter boundaries established during the most recent performance tests are exceeded are defined as follows:

(1) For thermal incinerators, all 3-hour periods of operation during which the average combustion temperature was more than 28 °C (50 °F) below the average combustion temperature during the most recent performance test at which compliance with §60.662(a) was determined.

(2) For catalytic incinerators, all 3-hour periods of operation during which the average temperature of the vent stream immediately before the catalyst bed is more than 28 °C (50 °F) below the average temperature of the vent stream during the most recent performance test at which compliance with §60.662(a) was determined. The owner or operator also shall record all 3-hour periods of operation during which the average temperature difference across the catalyst bed is less than 80 percent of the average temperature difference of the device during the most recent performance test at which compliance with §60.662(a) was determined.

(3) All 3-hour periods of operation during which the average combustion temperature was more than 28 °C (50 °F) below the average combustion temperature during the most recent performance test at which compliance with §60.662(a) was determined for boilers or process heaters with a design heat input capacity of less than 44 MW (150 million Btu/hr).

(4) For boilers or process heaters, whenever there is a change in the location at which the vent stream is introduced into the flame zone as required under §60.662(a).

(d) Each owner or operator subject to the provisions of this subpart shall keep up to date, readily accessible continuous records of the flow indication specified under §60.663(a)(2), §60.663(b)(2) and §60.663(c)(1), as well as up-to-date, readily accessible records of all periods when the vent stream is diverted from the control device or has no flow rate.

(e) Each owner or operator subject to the provisions of this subpart who uses a boiler or process heater with a design heat input capacity of 44 MW (150 million Btu/hour) or greater to comply with §60.662(a) shall keep an up-to-date, readily accessible record of all periods of operation of the boiler or process heater. (Examples of such records could include records of steam use, fuel use, or monitoring data collected pursuant to other State or Federal regulatory requirements.)

(f) Each owner or operator subject to the provisions of this subpart shall keep up-to-date, readily accessible continuous records of the flare pilot flame monitoring specified under §60.663(b), as well as up-to-date, readily accessible records of all periods of operations in which the pilot flame is absent.

(g) Each owner or operator subject to the provisions of this subpart shall keep up-to-date, readily accessible continuous records of the equipment operating parameters specified to be monitored under §60.663(e), as well as up-to-date, readily accessible records of periods of operation during which the parameter boundaries established during the most recent performance test are exceeded. The Administrator may at any time require a report of these data. Where an owner or operator seeks to comply with §60.662(c), periods of operation during which the parameter boundaries established during the most recent performance tests are exceeded are defined as follows:

(1) Where an absorber is the final recovery device in a recovery system, and where an organic compound monitoring device is not used:

(i) All 3-hour periods of operation during which the average absorbing liquid temperature was more than 11 °C (20 °F) above the average absorbing liquid temperature during the most recent performance test, or

(ii) All 3-hour periods of operation during which the average absorbing liquid specific gravity was more than 0.1 unit above, or more than 0.1 unit below, the average absorbing liquid specific gravity during the most recent performance test (unless monitoring of an alternative parameter, which is a measure of the degree of absorbing liquid saturation, is approved by the Administrator, in which case he will define appropriate parameter boundaries and periods of operation during which they are exceeded).

(2) Where a condenser is the final recovery device in a system, and where an organic compound monitoring device is not used, all 3-hour periods of operation during which the average exit (product side)

condenser operating temperature was more than 6 °C (11 °F) above the average exit (product side) operating temperature during the most recent performance test.

(3) Where a carbon adsorber is the final recovery device in a system, and where an organic compound monitoring device is not used:

(i) All carbon bed regeneration cycles during which the total mass steam flow was more than 10 percent below the total mass steam flow during the most recent performance test, or

(ii) All carbon bed regeneration cycles during which the temperature of the carbon bed after regeneration (and after completion of any cooling cycle(s)) was more than 10 percent greater than the carbon bed temperature (in degrees Celsius) during the most recent performance test.

(4) Where an absorber, condenser, or carbon adsorber is the final recovery device in the recovery system and where an organic compound monitoring device is used, all 3-hour periods of operation during which the average organic compound concentration level or reading of organic compounds in the exhaust gases is more than 20 percent greater than the exhaust gas organic compound concentration level or reading measured by the monitoring device during the most recent performance test.

(h) Each owner or operator of an affected facility subject to the provisions of this subpart and seeking to demonstrate compliance with §60.662(c) shall keep up-to-date, readily accessible records of:

(1) Any changes in production capacity, feedstock type, or catalyst type, or of any replacement, removal or addition of recovery equipment or a distillation unit;

(2) Any recalculation of the TRE index value performed pursuant to §60.664(g); and

(3) The results of any performance test performed pursuant to the methods and procedures required by §60.664(e).

(i) Each owner or operator of an affected facility that seeks to comply with the requirements of this subpart by complying with the flow rate cutoff in §60.660(c)(6) shall keep up-to-date, readily accessible records to indicate that the vent stream flow rate is less than 0.008 scm/min (0.3 scf/min) and of any change in equipment or process operation that increases the operating vent stream flow rate, including a measurement of the new vent stream flow rate.

(j) Each owner or operator of an affected facility that seeks to comply with the requirements of this subpart by complying with the design production capacity provision in §60.660(c)(5) shall keep up-to-date, readily accessible records of any change in equipment or process operation that increases the design production capacity of the process unit in which the affected facility is located.

(k) Each owner and operator subject to the provisions of this subpart is exempt from the quarterly reporting requirements contained in §60.7(c) of the General Provisions.

(l) Each owner or operator that seeks to comply with the requirements of this subpart by complying with the requirements of §60.660 (c)(4), (c)(5), or (c)(6) or §60.662 shall submit to the Administrator semiannual reports of the following recorded information. The initial report shall be submitted within 6 months after the initial start-up date.

(1) Exceedances of monitored parameters recorded under §60.665 (c) and (g).

(2) All periods recorded under §60.665(d) when the vent stream is diverted from the control device or has no flow rate.

(3) All periods recorded under §60.665(e) when the boiler or process heater was not operating.

(4) All periods recorded under §60.665(f) in which the pilot flame of the flare was absent.

(5) Any change in equipment or process operation that increases the operating vent stream flow rate above the low flow exemption level in §60.660(c)(6), including a measurement of the new vent stream flow rate, as recorded under §60.665(i). These must be reported as soon as possible after the change and no later than 180 days after the change. These reports may be submitted either in conjunction with semiannual reports or as a single separate report. A performance test must be completed with the same time period to verify the recalculated flow value and to obtain the vent stream characteristics of heating value and E_{TOC} . The performance test is subject to the requirements of §60.8 of the General Provisions. Unless the facility qualifies for an exemption under the low capacity exemption status in §60.660(c)(5), the facility must begin compliance with the requirements set forth in §60.662.

(6) Any change in equipment or process operation, as recorded under paragraph (j) of this section, that increases the design production capacity above the low capacity exemption level in §60.660(c)(5) and the new capacity resulting from the change for the distillation process unit containing the affected facility. These must be reported as soon as possible after the change and no later than 180 days after the change. These reports may be submitted either in conjunction with semiannual reports or as a single separate report. A performance test must be completed within the same time period to obtain the vent stream flow rate, heating value, and E_{TOC} . The performance test is subject to the requirements of §60.8. The facility must begin compliance with the requirements set forth in §60.660(d) or §60.662. If the facility chooses to comply with §60.662, the facility may qualify for an exemption in §60.660(c)(4) or (6).

(7) Any recalculation of the TRE index value, as recorded under §60.665(h).

(m) The requirements of §60.665(l) remain in force until and unless EPA, in delegating enforcement authority to a State under section 111(c) of the Act, approves reporting requirements or an alternative means of compliance surveillance adopted by such State. In that event, affected sources within the State will be relieved of the obligation to comply with §60.665(l), provided that they comply with the requirements established by the State.

(n) Each owner or operator that seeks to demonstrate compliance with §60.660(c)(5) must submit to the Administrator an initial report detailing the design production capacity of the process unit.

(o) Each owner or operator that seeks to demonstrate compliance with §60.660(c)(6) must submit to the Administrator an initial report including a flow rate measurement using the test methods specified in §60.664.

(p) The Administrator will specify appropriate reporting and recordkeeping requirements where the owner or operator of an affected facility complies with the standards specified under §60.662 other than as provided under §60.663(a), (b), (c) and (d).

[55 FR 26922, June 29, 1990; 55 FR 36932, Sept. 7, 1990, as amended at 60 FR 58237, Nov. 27, 1995; 65 FR 61778, Oct. 17, 2000; 65 FR 78279, Dec. 14, 2000; 79 FR 11251, Feb. 27, 2014]

 [Back to Top](#)

§60.666 Reconstruction.

For purposes of this subpart “fixed capital cost of the new components,” as used in §60.15, includes the fixed capital cost of all depreciable components which are or will be replaced pursuant to all continuous programs of component replacement which are commenced within any 2-year period

following December 30, 1983. For purposes of this paragraph, “commenced” means that an owner or operator has undertaken a continuous program of component replacement or that an owner or operator has entered into a contractual obligation to undertake and complete, within a reasonable time, a continuous program of component replacement.

[↑ Back to Top](#)

§60.667 Chemicals affected by subpart NNN.

Chemical name	CAS No.*
Acetaldehyde	75-07-0
Acetaldol	107-89-1
Acetic acid	64-19-7
Acetic anhydride	108-24-7
Acetone	67-64-1
Acetone cyanohydrin	75-86-5
Acetylene	74-86-2
Acrylic acid	79-10-7
Acrylonitrile	107-13-1
Adipic acid	124-04-9
Adiponitrile	111-69-3
Alcohols, C-11 or lower, mixtures	
Alcohols, C-12 or higher, mixtures	
Allyl chloride	107-05-1
Amylene	513-35-9
Amylenes, mixed	
Aniline	62-53-3
Benzene	71-43-2
Benzenesulfonic acid	98-11-3
Benzenesulfonic acid C ₁₀₋₁₆ -alkyl derivatives, sodium salts	68081-81-2
Benzoic acid, tech	65-85-0
Benzyl chloride	100-44-7
Biphenyl	92-52-4
Bisphenol A	80-05-7

Brometone	76-08-4
1,3-Butadiene	106-99-0
Butadiene and butene fractions	
n-Butane	106-97-8
1,4-Butanediol	110-63-4
Butanes, mixed	
1-Butene	106-98-9
2-Butene	25167-67-3
Butenes, mixed	
n-Butyl acetate	123-86-4
Butyl acrylate	141-32-2
n-Butyl alcohol	71-36-3
sec-Butyl alcohol	78-92-2
tert-Butyl alcohol	75-65-0
Butylbenzyl phthalate	85-68-7
Butylene glycol	107-88-0
tert-Butyl hydroperoxide	75-91-2
2-Butyne-1,4-diol	110-65-6
Butyraldehyde	123-72-8
Butyric anhydride	106-31-0
Caprolactam	105-60-2
Carbon disulfide	75-15-0
Carbon tetrabromide	558-13-4
Carbon tetrachloride	56-23-5
Chlorobenzene	108-90-7
2-Chloro-4-(ethylamino)-6-(isopropylamino)-s-triazine	1912-24-9
Chloroform	67-66-3
p-Chloronitrobenzene	100-00-5
Chloroprene	126-99-8
Citric acid	77-92-9

Crotonaldehyde	4170-30-0
Crotonic acid	3724-65-0
Cumene	98-82-8
Cumene hydroperoxide	80-15-9
Cyanuric chloride	108-77-0
Cyclohexane	110-82-7
Cyclohexane, oxidized	68512-15-2
Cyclohexanol	108-93-0
Cyclohexanone	108-94-1
Cyclohexanone oxime	100-64-1
Cyclohexene	110-83-8
1,3-Cyclopentadiene	542-92-7
Cyclopropane	75-19-4
Diacetone alcohol	123-42-2
Dibutanized aromatic concentrate	
1,4-Dichlorobutene	110-57-6
3,4-Dichloro-1-butene	64037-54-3
Dichlorodifluoromethane	75-71-8
Dichlorodimethylsilane	75-78-5
Dichlorofluoromethane	75-43-4
-Dichlorohydrin	96-23-1
Diethanolamine	111-42-2
Diethylbenzene	25340-17-4
Diethylene glycol	111-46-6
Di-n-heptyl-n-nonyl undecyl phthalate	85-68-7
Di-isodecyl phthalate	26761-40-0
Diisononyl phthalate	28553-12-0
Dimethylamine	124-40-3
Dimethyl terephthalate	120-61-6
2,4-Dinitrotoluene	121-14-2

2,4-(and 2,6)-dinitrotoluene	121-14-2
	606-20-2
Dioctyl phthalate	117-81-7
Dodecene	25378-22-7
Dodecylbenzene, non linear	
Dodecylbenzenesulfonic acid	27176-87-0
Dodecylbenzenesulfonic acid, sodium salt	25155-30-0
Epichlorohydrin	106-89-8
Ethanol	64-17-5
Ethanolamine	141-43-5
Ethyl acetate	141-78-6
Ethyl acrylate	140-88-5
Ethylbenzene	100-41-4
Ethyl chloride	75-00-3
Ethyl cyanide	107-12-0
Ethylene	74-85-1
Ethylene dibromide	106-93-4
Ethylene dichloride	107-06-2
Ethylene glycol	107-21-1
Ethylene glycol monobutyl	111-76-2
Ethylene glycol monoethyl ether	110-80-5
Ethylene glycol monoethyl ether acetate	111-15-9
Ethylene glycol monomethyl ether	109-86-4
Ethylene oxide	75-21-8
2-Ethylhexanal	26266-68-2
2-Ethylhexyl alcohol	104-76-7
(2-Ethylhexyl) amine	104-75-6
Ethylmethylbenzene	25550-14-5
6-Ethyl-1,2,3,4-tetrahydro 9,10-anthracenedione	15547-17-8
Formaldehyde	50-00-0

Glycerol	56-81-5
n-Heptane	142-82-5
Heptenes (mixed)	
Hexadecyl chloride	
Hexamethylene diamine	124-09-4
Hexamethylene diamine adipate	3323-53-3
Hexamethylenetetramine	100-97-0
Hexane	110-54-3
2-Hexenedinitrile	13042-02-9
3-Hexenedinitrile	1119-85-3
Hydrogen cyanide	74-90-8
Isobutane	75-28-5
Isobutanol	78-83-1
Isobutylene	115-11-7
Isobutyraldehyde	78-84-2
Isodecyl alcohol	25339-17-7
Isooctyl alcohol	26952-21-6
Isopentane	78-78-4
Isophthalic acid	121-91-5
Isoprene	78-79-5
Isopropanol	67-63-0
Ketene	463-51-4
Linear alcohols, ethoxylated, mixed	
Linear alcohols, ethoxylated, and sulfated, sodium salt, mixed	
Linear alcohols, sulfated, sodium salt, mixed	
Linear alkylbenzene	123-01-3
Magnesium acetate	142-72-3
Maleic anhydride	108-31-6
Melamine	108-78-1
Mesityl oxide	141-79-7

Methacrylonitrile	126-98-7
Methanol	67-56-1
Methylamine	74-89-5
ar-Methylbenzenediamine	25376-45-8
Methyl chloride	74-87-3
Methylene chloride	75-09-2
Methyl ethyl ketone	78-93-3
Methyl iodide	74-88-4
Methyl isobutyl ketone	108-10-1
Methyl methacrylate	80-62-6
2-Methylpentane	107-83-5
1-Methyl-2-pyrrolidone	872-50-4
Methyl tert-butyl ether	
Naphthalene	91-20-3
Nitrobenzene	98-95-3
1-Nonene	27215-95-8
Nonyl alcohol	143-08-8
Nonylphenol	25154-52-3
Nonylphenol, ethoxylated	9016-45-9
Octene	25377-83-7
Oil-soluble petroleum sulfonate, calcium salt	
Oil-soluble petroleum sulfonate, sodium salt	
Pentaerythritol	115-77-5
n-Pentane	109-66-0
3-Pentenenitrile	4635-87-4
Pentenes, mixed	109-67-1
Perchloroethylene	127-18-4
Phenol	108-95-2
1-Phenylethyl hydroperoxide	3071-32-7
Phenylpropane	103-65-1

Phosgene	75-44-5
Phthalic anhydride	85-44-9
Propane	74-98-6
Propionaldehyde	123-38-6
Propionic acid	79-09-4
Propyl alcohol	71-23-8
Propylene	115-07-1
Propylene chlorohydrin	78-89-7
Propylene glycol	57-55-6
Propylene oxide	75-56-9
Sodium cyanide	143-33-9
Sorbitol	50-70-4
Styrene	100-42-5
Terephthalic acid	100-21-0
1,1,2,2-Tetrachloroethane	79-34-5
Tetraethyl lead	78-00-2
Tetrahydrofuran	109-99-9
Tetra (methyl-ethyl) lead	
Tetramethyl lead	75-74-1
Toluene	108-88-3
Toluene-2,4-diamine	95-80-7
Toluene-2,4-(and, 2,6)-diisocyanate (80/20 mixture)	26471-62-5
Tribromomethane	75-25-2
1,1,1-Trichloroethane	71-55-6
1,1,2-Trichloroethane	79-00-5
Trichloroethylene	79-01-6
Trichlorofluoromethane	75-69-4
1,1,2-Trichloro-1,2,2-trifluoroethane	76-13-1
Triethanolamine	102-71-6
Triethylene glycol	112-27-6

Vinyl acetate	108-05-4
Vinyl chloride	75-01-4
Vinylidene chloride	75-35-4
m-Xylene	108-38-3
o-Xylene	95-47-6
p-Xylene	106-42-3
Xylenes (mixed)	1330-20-7
m-Xylenol	576-26-1

*CAS numbers refer to the Chemical Abstracts Registry numbers assigned to specific chemicals, isomers, or mixtures of chemicals. Some isomers or mixtures that are covered by the standards do not have CAS numbers assigned to them. The standards apply to all of the chemicals listed, whether CAS numbers have been assigned or not.

[55 FR 26942, June 29, 1990, as amended at 60 FR 58237, 58238, Nov. 27, 1995]

 [Back to Top](#)

§60.668 Delegation of authority.

(a) In delegating implementation and enforcement authority to a State under §111(c) of the Act, the authorities contained in paragraph (b) of this section shall be retained by the Administrator and not transferred to a State.

(b) Authorities which will not be delegated to States: §60.663(e).

 [Back to Top](#)

Appendix G

Subpart J—National Emission Standard for Equipment Leaks (Fugitive Emission Sources) of Benzene

Contents

[§61.110 Applicability and designation of sources.](#)

[§61.111 Definitions.](#)

[§61.112 Standards.](#)

SOURCE: 49 FR 23513, June 6, 1984, unless otherwise noted.

[↑ Back to Top](#)

§61.110 Applicability and designation of sources.

(a) The provisions of this subpart apply to each of the following sources that are intended to operate in benzene service: pumps, compressors, pressure relief devices, sampling connection systems, open-ended valves or lines, valves, connectors, surge control vessels, bottoms receivers, and control devices or systems required by this subpart.

(b) The provisions of this subpart do not apply to sources located in coke by-product plants.

(c)(1) If an owner or operator applies for one of the exemptions in this paragraph, then the owner or operator shall maintain records as required in §61.246(i).

(2) Any equipment in benzene service that is located at a plant site designed to produce or use less than 1,000 megagrams (1,102 tons) of benzene per year is exempt from the requirements of §61.112.

(3) Any process unit (defined in §61.241) that has no equipment in benzene service is exempt from the requirements of §61.112.

(d) While the provisions of this subpart are effective, a source to which this subpart applies that is also subject to the provisions of 40 CFR part 60 only will be required to comply with the provisions of this subpart.

[49 FR 23513, June 6, 1984, as amended at 65 FR 62156, Oct. 17, 2000; 65 FR 78280, Dec. 14, 2000]

[↑ Back to Top](#)

§61.111 Definitions.

As used in this subpart, all terms not defined herein shall have the meaning given them in the Act, in subpart A of part 61, or in subpart V of part 61, and the following terms shall have the specific meanings given them:

In benzene service means that a piece of equipment either contains or contacts a fluid (Liquid or gas) that is at least 10 percent benzene by weight as determined according to the provisions of §61.245(d). The provisions of §61.245(d) also specify how to determine that a piece of equipment is not in benzene service.

Semiannual means a 6-month period; the first semiannual period concludes on the last day of the last month during the 180 days following initial startup for new sources; and the first semiannual period concludes on the last day of the last full month during the 180 days after June 6, 1984 for existing sources.

 [Back to Top](#)

§61.112 Standards.

(a) Each owner or operator subject to the provisions of this subpart shall comply with the requirements of subpart V of this part.

(b) An owner or operator may elect to comply with the requirements of §§61.243-1 and 61.243-2.

(c) An owner or operator may apply to the Administrator for a determination of an alternative means of emission limitation that achieves a reduction in emissions of benzene at least equivalent to the reduction in emissions of benzene achieved by the controls required in this subpart. In doing so, the owner or operator shall comply with requirements of §61.244.

 [Back to Top](#)

Appendix H

Subpart V—National Emission Standard for Equipment Leaks (Fugitive Emission Sources)

Contents

[§61.240 Applicability and designation of sources.](#)
[§61.241 Definitions.](#)
[§61.242-1 Standards: General.](#)
[§61.242-2 Standards: Pumps.](#)
[§61.242-3 Standards: Compressors.](#)
[§61.242-4 Standards: Pressure relief devices in gas/vapor service.](#)
[§61.242-5 Standards: Sampling connecting systems.](#)
[§61.242-6 Standards: Open-ended valves or lines.](#)
[§61.242-7 Standards: Valves.](#)
[§61.242-8 Standards: Pressure relief services in liquid service and connectors.](#)
[§61.242-9 Standards: Surge control vessels and bottoms receivers.](#)
[§61.242-10 Standards: Delay of repair.](#)
[§61.242-11 Standards: Closed-vent systems and control devices.](#)
[§61.243-1 Alternative standards for valves in VHAP service—allowable percentage of valves leaking.](#)
[§61.243-2 Alternative standards for valves in VHAP service—skip period leak detection and repair.](#)
[§61.244 Alternative means of emission limitation.](#)
[§61.245 Test methods and procedures.](#)
[§61.246 Recordkeeping requirements.](#)
[§61.247 Reporting requirements.](#)
[Table 1 to Subpart V of Part 61—Surge Control Vessels and Bottoms Receivers at Existing Sources](#)
[Table 2 to Subpart V of Part 61—Surge Control Vessels and Bottoms Receivers at New Sources](#)

SOURCE: 49 FR 23513, June 6, 1984, unless otherwise noted.

[↑ Back to Top](#)

§61.240 Applicability and designation of sources.

(a) The provisions of this subpart apply to each of the following sources that are intended to operate in volatile hazardous air pollutant (VHAP) service: pumps, compressors, pressure relief devices, sampling connection systems, open-ended valves or lines, valves, connectors, surge control vessels, bottoms receivers, and control devices or systems required by this subpart.

(b) The provisions of this subpart apply to the sources listed in paragraph (a) after the date of promulgation of a specific subpart in part 61.

(c) While the provisions of this subpart are effective, a source to which this subpart applies that is also subject to the provisions of 40 CFR part 60 only will be required to comply with the provisions of this subpart.

(d) *Alternative means of compliance*—(1) *Option to comply with part 65.* Owners or operators may choose to comply with 40 CFR part 65 to satisfy the requirements of §§61.242-1 through 61.247 for equipment that is subject to this subpart and that is part of the same process unit. When choosing to comply with 40 CFR part 65, the requirements of §§61.245(d) and 61.246(i) and (j) still apply. Other

provisions applying to owners or operators who choose to comply with 40 CFR part 65 are provided in 40 CFR 65.1.

(2) *Part 65, subpart C or F.* For owners or operators choosing to comply with 40 CFR part 65, each surge control vessel and bottoms receiver subject to this subpart that meets the conditions specified in table 1 or table 2 of this subpart shall meet the requirements for storage vessels in 40 CFR part 65, subpart C; all other equipment subject to this subpart shall meet the requirements in 40 CFR part 65, subpart F.

(3) *Part 61, subpart A.* Owners or operators who choose to comply with 40 CFR part 65, subpart C or F, must also comply with §§61.01, 61.02, 61.05 through 61.08, 61.10(b) through (d), 61.11, and 61.15 for that equipment. All sections and paragraphs of subpart A of this part that are not mentioned in this paragraph (d)(3) do not apply to owners or operators of equipment subject to this subpart complying with 40 CFR part 65, subpart C or F, except that provisions required to be met prior to implementing 40 CFR part 65 still apply. Owners and operators who choose to comply with 40 CFR part 65, subpart C or F, must comply with 40 CFR part 65, subpart A.

(4) *Rules referencing this subpart.* Owners or operators referenced to this subpart from subpart F or J of this part may choose to comply with 40 CFR part 65 for all equipment listed in paragraph (a) of this section.

[49 FR 23513, June 6, 1984, as amended at 65 FR 78280, Dec. 14, 2000]

[↑ Back to Top](#)

§61.241 Definitions.

As used in this subpart, all terms not defined herein shall have the meaning given them in the Act, in subpart A of part 61, or in specific subparts of part 61; and the following terms shall have specific meaning given them:

Bottoms receiver means a tank that collects distillation bottoms before the stream is sent for storage or for further downstream processing.

Closed-vent system means a system that is not open to atmosphere and that is composed of hard-piping, ductwork, connections, and, if necessary, flow-inducing devices that transport gas or vapor from a piece or pieces of equipment to a control device or back to a process.

Connector means flanged, screwed, welded, or other joined fittings used to connect two pipe lines or a pipe line and a piece of equipment. For the purpose of reporting and recordkeeping, connector means flanged fittings that are not covered by insulation or other materials that prevent location of the fittings.

Control device means an enclosed combustion device, vapor recovery system, or flare.

Double block and bleed system means two block valves connected in series with a bleed valve or line that can vent the line between the two block valves.

Duct work means a conveyance system such as those commonly used for heating and ventilation systems. It is often made of sheet metal and often has sections connected by screws or crimping. Hard-piping is not ductwork.

Equipment means each pump, compressor, pressure relief device, sampling connection system, open-ended valve or line, valve, connector, surge control vessel, bottoms receiver in VHAP service, and any control devices or systems required by this subpart.

First attempt at repair means to take rapid action for the purpose of stopping or reducing leakage of organic material to atmosphere using best practices.

In gas/vapor service means that a piece of equipment contains process fluid that is in the gaseous state at operating conditions.

Fuel gas means gases that are combusted to derive useful work or heat.

Fuel gas system means the offsite and onsite piping and flow and pressure control system that gathers gaseous stream(s) generated by onsite operations, may blend them with other sources of gas, and transports the gaseous stream for use as fuel gas in combustion devices or in-process combustion equipment, such as furnaces and gas turbines, either singly or in combination.

Hard-piping means pipe or tubing that is manufactured and properly installed using good engineering judgement and standards such as ASME B31.3, Process Piping (available from the American Society of Mechanical Engineers, PO Box 2900, Fairfield, NJ 07007-2900).

In liquid service means that a piece of equipment is not in gas/vapor service.

In-situ sampling systems means nonextractive samplers or in-line samplers.

In vacuum service means that equipment is operating at an internal pressure which is at least 5 kilopascals (kPa) (0.7 psia) below ambient pressure.

In VHAP service means that a piece of equipment either contains or contacts a fluid (liquid or gas) that is at least 10 percent by weight a volatile hazardous air pollutant (VHAP) as determined according to the provisions of §61.245(d). The provisions of §61.245(d) also specify how to determine that a piece of equipment is not in VHAP service.

In VOC service means, for the purposes of this subpart, that (a) the piece of equipment contains or contacts a process fluid that is at least 10 percent VOC by weight (see 40 CFR 60.2 for the definition of volatile organic compound or VOC and 40 CFR 60.485(d) to determine whether a piece of equipment is not in VOC service) and (b) the piece of equipment is not in heavy liquid service as defined in 40 CFR 60.481.

Maximum true vapor pressure means the equilibrium partial pressure exerted by the total VHAP in the stored or transferred liquid at the temperature equal to the highest calendar-month average of the liquid storage or transfer temperature for liquids stored or transferred above or below the ambient temperature or at the local maximum monthly average temperature as reported by the National Weather Service for liquids stored or transferred at the ambient temperature, as determined:

(1) In accordance with methods described in American Petroleum Institute Publication 2517, Evaporative Loss From External Floating-Roof Tanks (incorporated by reference as specified in §61.18); or

(2) As obtained from standard reference texts; or

(3) As determined by the American Society for Testing and Materials Method D2879-83, Standard Test Method for Vapor Pressure-Temperature Relationship and Initial Decomposition Temperature of Liquids by Isoteniscope (incorporated by reference as specified in §61.18); or

(4) Any other method approved by the Administrator.

Open-ended valve or line means any valve, except pressure relief valves, having one side of the valve seat in contact with process fluid and one side open to atmosphere, either directly or through open piping.

Pressure release means the emission of materials resulting from the system pressure being greater than the set pressure of the pressure relief device.

Process unit means equipment assembled to produce a VHAP or its derivatives as intermediates or final products, or equipment assembled to use a VHAP in the production of a product. A process unit can operate independently if supplied with sufficient feed or raw materials and sufficient product storage facilities.

Process unit shutdown means a work practice or operational procedure that stops production from a process unit or part of a process unit. An unscheduled work practice or operational procedure that stops production from a process unit or part of a process unit for less than 24 hours is not a process unit shutdown. The use of spare equipment and technically feasible bypassing of equipment without stopping production are not process unit shutdowns.

Repaired means that equipment is adjusted, or otherwise altered, to eliminate a leak.

Sampling connection system means an assembly of equipment within a process unit used during periods of representative operation to take samples of the process fluid. Equipment used to take non-routine grab samples is not considered a sampling connection system.

Semiannual means a 6-month period; the first semiannual period concludes on the last day of the last month during the 180 days following initial startup for new sources; and the first semiannual period concludes on the last day of the last full month during the 180 days after the effective date of a specific subpart that references this subpart for existing sources.

Sensor means a device that measures a physical quantity or the change in a physical quantity, such as temperature, pressure, flow rate, pH, or liquid level.

Stuffing box pressure means the fluid (liquid or gas) pressure inside the casing or housing of a piece of equipment, on the process side of the inboard seal.

Surge control vessel means feed drums, recycle drums, and intermediate vessels. Surge control vessels are used within a process unit when in-process storage, mixing, or management of flow rates of volumes is needed on a recurring or ongoing basis to assist in production of a product.

Volatile hazardous air pollutant or *VHAP* means a substance regulated under this part for which a standard for equipment leaks of the substance has been proposed and promulgated. Benzene is a VHAP. Vinyl chloride is a VHAP.

[49 FR 23513, June 6, 1984; 49 FR 38946, Oct. 2, 1984, as amended at 51 FR 34915, Sept. 30, 1986; 54 FR 38076, Sept. 14, 1989; 65 FR 62158, Oct. 17, 2000; 65 FR 78280, Dec. 14, 2000]

§61.242-1 Standards: General.

(a) Each owner or operator subject to the provisions of this subpart shall demonstrate compliance with the requirements of §§61.242-1 to 61.242-11 for each new and existing source as required in 40 CFR 61.05, except as provided in §§61.243 and 61.244.

(b) Compliance with this subpart will be determined by review of records, review of performance test results, and inspection using the methods and procedures specified in §61.245.

(c)(1) An owner or operator may request a determination of alternative means of emission limitation to the requirements of §§61.242-2, 61.242-3, 61.242-5, 61.242-6, 61.242-7, 61.242-8, 61.242-9 and 61.242-11 as provided in §61.244.

(2) If the Administrator makes a determination that a means of emission limitation is at least a permissible alternative to the requirements of §61.242-2, 61.242-3, 61.242-5, 61.242-6, 61.242-7, 61.242-8, 61.242-9 or 61.242-11, an owner or operator shall comply with the requirements of that determination.

(d) Each piece of equipment to which this subpart applies shall be marked in such a manner that it can be distinguished readily from other pieces of equipment.

(e) Equipment that is in vacuum service is excluded from the requirements of §61.242-2, to §61.242-11 if it is identified as required in §61.246(e)(5).

[49 FR 23513, June 6, 1984; 49 FR 38946, Oct. 2, 1984]

 [Back to Top](#)

§61.242-2 Standards: Pumps.

(a)(1) Each pump shall be monitored monthly to detect leaks by the methods specified in §61.245(b), except as provided in §61.242-1(c) and paragraphs (d), (e), (f) and (g) of this section.

(2) Each pump shall be checked by visual inspection each calendar week for indications of liquids dripping from the pump seal.

(b)(1) If an instrument reading of 10,000 ppm or greater is measured, a leak is detected.

(2) If there are indications of liquids dripping from the pump seal, a leak is detected.

(c)(1) When a leak is detected, it shall be repaired as soon as practicable, but not later than 15 calendar days after it is detected, except as provided in §61.242-10.

(2) A first attempt at repair shall be made no later than 5 calendar days after each leak is detected.

(d) Each pump equipped with a dual mechanical seal system that includes a barrier fluid system is exempt from the requirements of paragraphs (a) and (b) of this section, provided the following requirements are met:

(1) Each dual mechanical seal system is:

(i) Operated with the barrier fluid at a pressure that is at all times greater than the pump stuffing box pressure; or

(ii) Equipped with a barrier fluid degassing reservoir that is routed to a process or fuel gas system or connected by a closed-vent system to a control device that complies with the requirements of §61.242-11; or

(iii) Equipped with a system that purges the barrier fluid into a process stream with zero VHAP emissions to atmosphere.

(2) The barrier fluid is not in VHAP service and, if the pump is covered by standards under 40 CFR part 60, is not in VOC service.

(3) Each barrier fluid system is equipped with a sensor that will detect failure of the seal system, the barrier fluid system, or both.

(4) Each pump is checked by visual inspection each calendar week for indications of liquids dripping from the pump seal.

(i) If there are indications of liquid dripping from the pump seal at the time of the weekly inspection, the pump shall be monitored as specified in §61.245 to determine the presence of VOC and VHAP in the barrier fluid.

(ii) If the monitor reading (taking into account any background readings) indicates the presence of VHAP, a leak is detected. For the purpose of this paragraph, the monitor may be calibrated with VHAP, or may employ a gas chromatography column to limit the response of the monitor to VHAP, at the option of the owner or operator.

(iii) If an instrument reading of 10,000 ppm or greater (total VOC) is measured, a leak is detected.

(5) Each sensor as described in paragraph (d)(3) of this section is checked daily or is equipped with an audible alarm.

(6)(i) The owner or operator determines, based on design considerations and operating experience, criteria applicable to the presence and frequency of drips and to the sensor that indicates failure of the seal system, the barrier fluid system, or both.

(ii) If indications of liquids dripping from the pump seal exceed the criteria established in paragraph (d)(6)(i) of this section, or if, based on the criteria established in paragraph (d)(6)(i) of this section, the sensor indicates failure of the seal system, the barrier fluid system, or both, a leak is detected.

(iii) When a leak is detected, it shall be repaired as soon as practicable, but no later than 15 calendar days after it is detected, except as provided in §61.242-10.

(iv) A first attempt at repair shall be made no later than five calendar days after each leak is detected.

(e) Any pump that is designated, as described in §61.246(e)(2), for no detectable emissions, as indicated by an instrument reading of less than 500 ppm above background, is exempt from the requirements of paragraphs (a), (c), and (d) if the pump:

(1) Has no externally actuated shaft penetrating the pump housing,

(2) Is demonstrated to be operating with no detectable emissions, as indicated by an instrument reading of less than 500 ppm above background, as measured by the method specified in §61.245(c), and

(3) Is tested for compliance with paragraph (e)(2) initially upon designation, annually, and at other times requested by the Administrator.

(f) If any pump is equipped with a closed-vent system capable of capturing and transporting any leakage from the seal or seals to a process or fuel gas system or to a control device that complies with the requirements of §61.242-11, it is exempt from the requirements of paragraphs (a) through (e) of this section.

(g) Any pump that is designated, as described in §61.246(f)(1), as an unsafe-to-monitor pump is exempt from the monitoring and inspection requirements of paragraphs (a) and (d)(4) through (6) of this section if:

(1) The owner or operator of the pump demonstrates that the pump is unsafe-to-monitor because monitoring personnel would be exposed to an immediate danger as a consequence of complying with paragraph (a) of this section; and

(2) The owner or operator of the pump has a written plan that requires monitoring of the pump as frequently as practicable during safe-to-monitor times but not more frequently than the periodic monitoring schedule otherwise applicable, and repair of the equipment according to the procedures in paragraph (c) of this section if a leak is detected.

(h) Any pump that is located within the boundary of an unmanned plant site is exempt from the weekly visual inspection requirement of paragraphs (a)(2) and (d)(4) of this section, and the daily requirements of paragraph (d)(5) of this section, provided that each pump is visually inspected as often as practicable and at least monthly.

[49 FR 23513, June 6, 1984, as amended at 49 FR 38946, Oct. 2, 1984; 55 FR 28349, July 10, 1990; 65 FR 78281, Dec. 14, 2000]

 [Back to Top](#)

§61.242-3 Standards: Compressors.

(a) Each compressor shall be equipped with a seal system that includes a barrier fluid system and that prevents leakage of process fluid to atmosphere, except as provided in §61.242-1(c) and paragraphs (h) and (i) of this section.

(b) Each compressor seal system as required in paragraph (a) shall be:

(1) Operated with the barrier fluid at a pressure that is greater than the compressor stuffing box pressure; or

(2) Equipped with a barrier fluid system degassing reservoir that is routed to a process or fuel gas system or connected by a closed-vent system to a control device that complies with the requirements of §61.242-11; or

(3) Equipped with a system that purges the barrier fluid into a process stream with zero VHAP emissions to atmosphere.

(c) The barrier fluid shall not be in VHAP service and, if the compressor is covered by standards under 40 CFR part 60, shall not be in VOC service.

(d) Each barrier fluid system as described in paragraphs (a)-(c) of this section shall be equipped with a sensor that will detect failure of the seal system, barrier fluid system, or both.

(e)(1) Each sensor as required in paragraph (d) of this section shall be checked daily or shall be equipped with an audible alarm unless the compressor is located within the boundary of an unmanned plant site.

(2) The owner or operator shall determine, based on design considerations and operating experience, a criterion that indicates failure of the seal system, the barrier fluid system, or both.

(f) If the sensor indicates failure of the seal system, the barrier fluid system, or both based on the criterion determined under paragraph (e)(2) of this section, a leak is detected.

(g)(1) When a leak is detected, it shall be repaired as soon as practicable, but not later than 15 calendar days after it is detected, except as provided in §61.242-10.

(2) A first attempt at repair shall be made no later than 5 calendar days after each leak is detected.

(h) A compressor is exempt from the requirements of paragraphs (a) and (b) of this section if it is equipped with a closed-vent system to capture and transport leakage from the compressor drive shaft back to a process or fuel gas system or to a control device that complies with the requirements of §61.242-11, except as provided in paragraph (i) of this section.

(i) Any Compressor that is designated, as described in §61.246(e)(2), for no detectable emission as indicated by an instrument reading of less than 500 ppm above background is exempt from the requirements of paragraphs (a)-(h) if the compressor:

(1) Is demonstrated to be operating with no detectable emissions, as indicated by an instrument reading of less than 500 ppm above background, as measured by the method specified in §61.245(c); and

(2) Is tested for compliance with paragraph (i)(1) initially upon designation, annually, and at other times requested by the Administrator.

[49 FR 23513, June 6, 1984; 49 FR 38946, Oct. 2, 1984, as amended at 65 FR 78281, Dec. 14, 2000]

[↑ Back to Top](#)

§61.242-4 Standards: Pressure relief devices in gas/vapor service.

(a) Except during pressure releases, each pressure relief device in gas/vapor service shall be operated with no detectable emissions, as indicated by an instrument reading of less than 500 ppm above background, as measured by the method specified in §61.245(c).

(b)(1) After each pressure release, the pressure relief device shall be returned to a condition of no detectable emissions, as indicated by an instrument reading of less than 500 ppm above background, as soon as practicable, but no later than 5 calendar days after each pressure release, except as provided in §61.242-10.

(2) No later than 5 calendar days after the pressure release, the pressure relief device shall be monitored to confirm the condition of no detectable emissions, as indicated by an instrument reading of less than 500 ppm above background, as measured by the method specified in §61.245(c).

(c) Any pressure relief device that is routed to a process or fuel gas system or equipped with a closed-vent system capable of capturing and transporting leakage from the pressure relief device to a control device as described in §61.242-11 is exempt from the requirements of paragraphs (a) and (b) of this section.

(d)(1) Any pressure relief device that is equipped with a rupture disk upstream of the pressure relief device is exempt from the requirements of paragraphs (a) and (b) of this section, provided the owner or operator complies with the requirements in paragraph (d)(2) of this section.

(2) After each pressure release, a new rupture disk shall be installed upstream of the pressure relief device as soon as practicable, but no later than 5 calendar days after each pressure release, except as provided in §61.242-10.

[49 FR 23513, June 6, 1984; 49 FR 38946, Oct. 2, 1984, as amended at 65 FR 78281, Dec. 14, 2000]

 [Back to Top](#)

§61.242-5 Standards: Sampling connecting systems.

(a) Each sampling connection system shall be equipped with a closed-purge, closed-loop, or closed vent system, except as provided in §61.242-1(c). Gases displaced during filling of the sample container are not required to be collected or captured.

(b) Each closed-purge, closed-loop, or closed vent system as required in paragraph (a) of this section shall comply with the requirements specified in paragraphs (b)(1) through (4) of this section:

(1) Return the purged process fluid directly to the process line; or

(2) Collect and recycle the purged process fluid; or

(3) Be designed and operated to capture and transport all the purged process fluid to a control device that complies with the requirements of §61.242-11; or

(4) Collect, store, and transport the purged process fluid to any of the following systems or facilities:

(i) A waste management unit as defined in 40 CFR 63.111 if the waste management unit is subject to and operated in compliance with the provisions of 40 CFR part 63, subpart G, applicable to Group 1 wastewater streams; or

(ii) A treatment, storage, or disposal facility subject to regulation under 40 CFR part 262, 264, 265, or 266; or

(iii) A facility permitted, licensed, or registered by a State to manage municipal or industrial solid waste, if the process fluids are not hazardous waste as defined in 40 CFR part 261.

(c) In-situ sampling systems and sampling systems without purges are exempt from the requirements of paragraphs (a) and (b) of this section.

[65 FR 78281, Dec. 14, 2000]

 [Back to Top](#)

§61.242-6 Standards: Open-ended valves or lines.

(a)(1) Each open-ended valve or line shall be equipped with a cap, blind flange, plug, or a second valve, except as provided in §61.242-1(c).

(2) The cap, blind flange, plug, or second valve shall seal the open end at all times except during operations requiring process fluid flow through the open-ended valve or line.

(b) Each open-ended valve or line equipped with a second valve shall be operated in a manner such that the valve on the process fluid end is closed before the second valve is closed.

(c) When a double block and bleed system is being used, the bleed valve or line may remain open during operations that require venting the line between the block valves but shall comply with paragraph (a) at all other times.

(d) Open-ended valves or lines in an emergency shutdown system which are designed to open automatically in the event of a process upset are exempt from the requirements of paragraphs (a), (b) and (c) of this section.

(e) Open-ended valves or lines containing materials which would autocatalytically polymerize or would present an explosion, serious overpressure, or other safety hazard if capped or equipped with a double block and bleed system as specified in paragraphs (a) through (c) of this section are exempt from the requirements of paragraphs (a) through (c) of this section.

[49 FR 23513, June 6, 1984, as amended at 65 FR 78282, Dec. 14, 2000]

 [Back to Top](#)

§61.242-7 Standards: Valves.

(a) Each valve shall be monitored monthly to detect leaks by the method specified in §61.245(b) and shall comply with paragraphs (b)-(e), except as provided in paragraphs (f), (g), and (h) of this section, §61.243-1 or §61.243-2, and §61.242-1(c).

(b) If an instrument reading of 10,000 ppm or greater is measured, a leak is detected.

(c)(1) Any valve for which a leak is not detected for 2 successive months may be monitored the first month of every quarter, beginning with the next quarter, until a leak is detected.

(2) If a leak is detected, the valve shall be monitored monthly until a leak is not detected for 2 successive months.

(d)(1) When a leak is detected, it shall be repaired as soon as practicable, but no later than 15 calendar days after the leak is detected, except as provided in §61.242-10.

(2) A first attempt at repair shall be made no later than 5 calendar days after each leak is detected.

(e) First attempts at repair include, but are not limited to, the following best practices where practicable:

(1) Tightening of bonnet bolts;

- (2) Replacement of bonnet bolts;
- (3) Tightening of packing gland nuts; and
- (4) Injection of lubricant into lubricated packing.

(f) Any valve that is designated, as described in §61.246(e)(2), for no detectable emissions, as indicated by an instrument reading of less than 500 ppm above background, is exempt from the requirements of paragraph (a) if the valve:

(1) Has no external actuating mechanism in contact with the process fluid;

(2) Is operated with emissions less than 500 ppm above background, as measured by the method specified in §61.245(c); and

(3) Is tested for compliance with paragraph (f)(2) initially upon designation, annually, and at other times requested by the Administrator.

(g) Any valve that is designated, as described in §61.246(f)(1), as an unsafe-to-monitor valve is exempt from the requirements of paragraph (a) if:

(1) The owner or operator of the valve demonstrates that the valve is unsafe to monitor because monitoring personnel would be exposed to an immediate danger as a consequence of complying with paragraph (a); and

(2) The owner or operator of the valve has a written plan that requires monitoring of the valve as frequent as practicable during safe-to-monitor times.

(h) Any valve that is designated, as described in §61.246(f)(2), as a difficult-to-monitor valve is exempt from the requirements of paragraph (a) if:

(1) The owner or operator of the valve demonstrates that the valve cannot be monitored without elevating the monitoring personnel more than 2 meters above a support surface;

(2) The process unit within which the valve is located is an existing process unit; and

(3) The owner or operator of the valve follows a written plan that requires monitoring of the valve at least once per calendar year.

 [Back to Top](#)

§61.242-8 Standards: Pressure relief services in liquid service and connectors.

(a) If evidence of a potential leak is found by visual, audible, olfactory, or any other detection method at pressure relief devices in liquid service and connectors, the owner or operator shall follow either one of the following procedures, except as provided in §61.242-1(c):

(1) The owner or operator shall monitor the equipment within 5 days by the method specified in §61.245(b) and shall comply with the requirements of paragraphs (b) through (d) of this section.

(2) The owner or operator shall eliminate the visual, audible, olfactory, or other indication of a potential leak.

(b) If an instrument reading of 10,000 ppm or greater is measured, a leak is detected.

(c)(1) When a leak is detected, it shall be repaired as soon as practicable, but not later than 15 calendar days after it is detected, except as provided in §61.242-10.

(2) The first attempt at repair shall be made no later than 5 calendar days after each leak is detected.

(d) First attempts at repair include, but are not limited to, the best practices described under §61.242-7(e).

[49 FR 23513, June 6, 1984; 49 FR 38946, Oct. 2, 1984, as amended at 65 FR 78282, Dec. 14, 2000]

 [Back to Top](#)

§61.242-9 Standards: Surge control vessels and bottoms receivers.

Each surge control vessel or bottoms receiver that is not routed back to the process and that meets the conditions specified in table 1 or table 2 of this subpart shall be equipped with a closed-vent system capable of capturing and transporting any leakage from the vessel back to the process or to a control device as described in §61.242-11, except as provided in §61.242-1(c); or comply with the requirements of 40 CFR 63.119(b) or (c).

[65 FR 78282, Dec. 14, 2000]

 [Back to Top](#)

§61.242-10 Standards: Delay of repair.

(a) Delay of repair of equipment for which leaks have been detected will be allowed if repair within 15 days is technically infeasible without a process unit shutdown. Repair of this equipment shall occur before the end of the next process unit shutdown.

(b) Delay of repair of equipment for which leaks have been detected will be allowed for equipment that is isolated from the process and that does not remain in VHAP service.

(c) Delay of repair for valves will be allowed if:

(1) The owner or operator demonstrates that emissions of purged material resulting from immediate repair are greater than the fugitive emissions likely to result from delay of repair, and

(2) When repair procedures are effected, the purged material is collected and destroyed or recovered in a control device complying with §61.242-11.

(d) Delay of repair for pumps will be allowed if:

(1) Repair requires the use of a dual mechanical seal system that includes a barrier fluid system, and

(2) Repair is completed as soon as practicable, but not later than 6 months after the leak was detected.

(e) Delay of repair beyond a process unit shutdown will be allowed for a valve if valve assembly replacement is necessary during the process unit shutdown, valve assembly supplies have been depleted, and valve assembly supplies had been sufficiently stocked before the supplies were depleted. Delay of repair beyond the next process unit shutdown will not be allowed unless the next process unit shutdown occurs sooner than 6 months after the first process unit shutdown.

[49 FR 23513, June 6, 1984, as amended at 65 FR 78282, Dec. 14, 2000]

[↑ Back to Top](#)

§61.242-11 Standards: Closed-vent systems and control devices.

(a) Owners or operators of closed-vent systems and control devices used to comply with provisions of this subpart shall comply with the provisions of this section, except as provided in §61.242-1(c).

(b) Vapor recovery systems (for example, condensers and absorbers) shall be designed and operated to recover the organic vapors vented to them with an efficiency of 95 percent or greater, or to an exit concentration of 20 parts per million by volume, whichever is less stringent.

(c) Enclosed combustion devices shall be designed and operated to reduce the VHAP emissions vented to them with an efficiency of 95 percent or greater, or to an exit concentration of 20 parts per million by volume, on a dry basis, corrected to 3 percent oxygen, whichever is less stringent, or to provide a minimum residence time of 0.50 seconds at a minimum temperature of 760 °C.

(d) Flares shall used to comply with this subpart shall comply with the requirements of §60.18.

(e) Owners or operators of control devices that are used to comply with the provisions of this subpart shall monitor these control devices to ensure that they are operated and maintained in conformance with their design.

(f) Except as provided in paragraphs (i) through (k) of this section, each closed vent system shall be inspected according to the procedures and schedule specified in paragraph (f)(1) or (2) of this section, as applicable.

(1) If the vapor collection system or closed vent system is constructed of hard-piping, the owner or operator shall comply with the following requirements:

(i) Conduct an initial inspection according to the procedures in §61.245(b); and

(ii) Conduct annual visual inspections for visible, audible, or olfactory indications of leaks.

(2) If the vapor collection system or closed vent system is constructed of ductwork, the owner or operator shall:

(i) Conduct an initial inspection according to the procedures in §61.245(b); and

(ii) Conduct annual inspections according to the procedures in §61.245(b).

(g) Leaks, as indicated by an instrument reading greater than 500 parts per million by volume above background or by visual inspections, shall be repaired as soon as practicable except as provided in paragraph (h) of this section.

(1) A first attempt at repair shall be made no later than 5 calendar days after the leak is detected.

(2) Repair shall be completed no later than 15 calendar days after the leak is detected.

(h) Delay of repair of a closed vent system for which leaks have been detected is allowed if the repair is technically infeasible without a process unit shutdown, or if the owner or operator determines that emissions resulting from immediate repair would be greater than the fugitive emissions likely to result from delay of repair. Repair of such equipment shall be complete by the end of the next process unit shutdown.

(i) If a vapor collection system or closed vent system is operated under a vacuum, it is exempt from the inspection requirements of paragraphs (f)(1)(i) and (2) of this section.

(j) Any parts of the closed vent system that are designated, as described in paragraph (l)(1) of this section, as unsafe-to-inspect are exempt from the inspection requirements of paragraphs (f)(1)(i) and (2) of this section if they comply with the following requirements:

(1) The owner or operator determines that the equipment is unsafe-to-inspect because inspecting personnel would be exposed to an imminent or potential danger as a consequence of complying with paragraph (f)(1)(i) or (2) of this section; and

(2) The owner or operator has a written plan that requires inspection of the equipment as frequently as practicable during safe-to-inspect times.

(k) Any parts of the closed vent system that are designated, as described in paragraph (l)(2) of this section, as difficult-to-inspect are exempt from the inspection requirements of paragraphs (f)(1)(i) and (2) of this section if they comply with the following requirements:

(1) The owner or operator determines that the equipment cannot be inspected without elevating the inspecting personnel more than 2 meters above a support surface; and

(2) The owner or operator has a written plan that requires inspection of the equipment at least once every 5 years. A closed vent system is exempt from inspection if it is operated under a vacuum.

(l) The owner or operator shall record the following information:

(1) Identification of all parts of the closed vent system that are designated as unsafe-to-inspect, an explanation of why the equipment is unsafe-to-inspect, and the plan for inspecting the equipment.

(2) Identification of all parts of the closed vent system that are designated as difficult-to-inspect, an explanation of why the equipment is difficult-to-inspect, and the plan for inspecting the equipment.

(3) For each inspection during which a leak is detected, a record of the information specified in §61.246(c).

(4) For each inspection conducted in accordance with §61.245(b) during which no leaks are detected, a record that the inspection was performed, the date of the inspection, and a statement that no leaks were detected.

(5) For each visual inspection conducted in accordance with paragraph (f)(1)(ii) of this section during which no leaks are detected, a record that the inspection was performed, the date of the inspection, and a statement that no leaks were detected.

(m) Closed vent systems and control devices used to comply with provisions of this subpart shall be operated at all times when emissions may be vented to them.

[49 FR 23513, June 6, 1984; 49 FR 38946, Oct. 2, 1984, as amended at 51 FR 2702, Jan. 21, 1986; 65 FR 62158, Oct. 17, 2000; 65 FR 78282, Dec. 14, 2000]

[↑ Back to Top](#)

§61.243-1 Alternative standards for valves in VHAP service—allowable percentage of valves leaking.

(a) An owner or operator may elect to have all valves within a process unit to comply with an allowable percentage of valves leaking of equal to or less than 2.0 percent.

(b) The following requirements shall be met if an owner or operator decides to comply with an allowable percentage of valves leaking:

(1) An owner or operator must notify the Administrator that the owner or operator has elected to have all valves within a process unit to comply with the allowable percentage of valves leaking before implementing this alternative standard, as specified in §61.247(d).

(2) A performance test as specified in paragraph (c) of this section shall be conducted initially upon designation, annually, and at other times requested by the Administrator.

(3) If a valve leak is detected, it shall be repaired in accordance with §61.242-7(d) and (e).

(c) Performance tests shall be conducted in the following manner:

(1) All valves in VHAP service within the process unit shall be monitored within 1 week by the methods specified in §61.245(b).

(2) If an instrument reading of 10,000 ppm or greater is measured, a leak is detected.

(3) The leak percentage shall be determined by dividing the number of valves in VHAP service for which leaks are detected by the number of valves in VHAP service within the process unit.

(d) Owner or operators who elect to have all valves comply with this alternative standard shall not have a process unit with a leak percentage greater than 2.0 percent.

(e) If an owner or operator decides no longer to comply with §61.243-1, the owner or operator must notify the Administrator in writing that the work practice standard described in §61.242-7(a)-(e) will be followed.

[↑ Back to Top](#)

§61.243-2 Alternative standards for valves in VHAP service—skip period leak detection and repair.

(a)(1) An owner or operator may elect for all valves within a process unit to comply with one of the alternative work practices specified in paragraphs (b)(2) and (3) of this section.

(2) An owner or operator must notify the Administrator before implementing one of the alternative work practices, as specified in §61.247(d).

(b)(1) An owner or operator shall comply initially with the requirements for valves, as described in §61.242-7.

(2) After 2 consecutive quarterly leak detection periods with the percentage of valves leaking equal to or less than 2.0, an owner or operator may begin to skip one of the quarterly leak detection periods for the valves in VHAP service.

(3) After five consecutive quarterly leak detection periods with the percentage of valves leaking equal to or less than 2.0, an owner or operator may begin to skip three of the quarterly leak detection periods for the valves in VHAP service.

(4) If the percentage of valves leaking is greater than 2.0, the owner or operator shall comply with the requirements as described in §61.242-7 but may again elect to use this section.

[49 FR 23513, June 6, 1984, as amended at 65 FR 62158, Oct. 17, 2000]

 [Back to Top](#)

§61.244 Alternative means of emission limitation.

(a) Permission to use an alternative means of emission limitation under section 112(e)(3) of the Clean Air Act shall be governed by the following procedures:

(b) Where the standard is an equipment, design, or operational requirement:

(1) Each owner or operator applying for permission shall be responsible for collecting and verifying test data for an alternative means of emission limitation to test data for the equipment, design, and operational requirements.

(2) The Administrator may condition the permission on requirements that may be necessary to assure operation and maintenance to achieve the same emission reduction as the equipment, design, and operational requirements.

(c) Where the standard is a work practice:

(1) Each owner or operator applying for permission shall be responsible for collecting and verifying test data for an alternative means of emission limitation.

(2) For each source for which permission is requested, the emission reduction achieved by the required work practices shall be demonstrated for a minimum period of 12 months.

(3) For each source for which permission is requested, the emission reduction achieved by the alternative means of emission limitation shall be demonstrated.

(4) Each owner or operator applying for permission shall commit in writing each source to work practices that provide for emission reductions equal to or greater than the emission reductions achieved by the required work practices.

(5) The Administrator will compare the demonstrated emission reduction for the alternative means of emission limitation to the demonstrated emission reduction for the required work practices and will consider the commitment in paragraph (c)(4).

(6) The Administrator may condition the permission on requirements that may be necessary to assure operation and maintenance to achieve the same emission reduction as the required work practices of this subpart.

(d) An owner or operator may offer a unique approach to demonstrate the alternative means of emission limitation.

(e)(1) Manufacturers of equipment used to control equipment leaks of a VHAP may apply to the Administrator for permission for an alternative means of emission limitation that achieves a reduction in emissions of the VHAP achieved by the equipment, design, and operational requirements of this subpart.

(2) The Administrator will grant permission according to the provisions of paragraphs (b), (c), and (d).

[49 FR 23513, June 6, 1984, as amended at 65 FR 62158, Oct. 17, 2000]

 [Back to Top](#)

§61.245 Test methods and procedures.

(a) Each owner or operator subject to the provisions of this subpart shall comply with the test methods and procedures requirements provided in this section.

(b) Monitoring, as required in §§61.242, 61.243, 61.244, and 61.135, shall comply with the following requirements:

(1) Monitoring shall comply with Method 21 of appendix A of 40 CFR part 60.

(2) The detection instrument shall meet the performance criteria of Method 21.

(3) The instrument shall be calibrated before use on each day of its use by the procedures specified in Method 21.

(4) Calibration gases shall be:

(i) Zero air (less than 10 ppm of hydrocarbon in air); and

(ii) A mixture of methane or n-hexane and air at a concentration of approximately, but less than, 10,000 ppm methane or n-hexane.

(5) The instrument probe shall be traversed around all potential leak interfaces as close to the interface as possible as described in Method 21.

(c) When equipment is tested for compliance with or monitored for no detectable emissions, the owner or operator shall comply with the following requirements:

(1) The requirements of paragraphs (b) (1) through (4) shall apply.

(2) The background level shall be determined, as set forth in Method 21.

(3) The instrument probe shall be traversed around all potential leak interfaces as close to the interface as possible as described in Method 21.

(4) The arithmetic difference between the maximum concentration indicated by the instrument and the background level is compared with 500 ppm for determining compliance.

(d)(1) Each piece of equipment within a process unit that can conceivably contain equipment in VHAP service is presumed to be in VHAP service unless an owner or operator demonstrates that the piece of equipment is not in VHAP service. For a piece of equipment to be considered not in VHAP service, it must be determined that the percent VHAP content can be reasonably expected never to exceed 10 percent by weight. For purposes of determining the percent VHAP content of the process fluid that is contained in or contacts equipment, procedures that conform to the methods described in ASTM Method D-2267 (incorporated by the reference as specified in §61.18) shall be used.

(2)(i) An owner or operator may use engineering judgment rather than the procedures in paragraph (d)(1) of this section to demonstrate that the percent VHAP content does not exceed 10 percent by weight, provided that the engineering judgment demonstrates that the VHAP content clearly does not exceed 10 percent by weight. When an owner or operator and the Administrator do not agree on whether a piece of equipment is not in VHAP service, however, the procedures in paragraph (d)(1) of this section shall be used to resolve the disagreement.

(ii) If an owner or operator determines that a piece of equipment is in VHAP service, the determination can be revised only after following the procedures in paragraph (d)(1) of this section.

(3) Samples used in determining the percent VHAP content shall be representative of the process fluid that is contained in or contacts the equipment or the gas being combusted in the flare.

(e)(1) Method 22 of appendix A of 40 CFR part 60 shall be used to determine compliance of flares with the visible emission provisions of this subpart.

(2) The presence of a flare pilot flame shall be monitored using a thermocouple or any other equivalent device to detect the presence of a flame.

(3) The net heating value of the gas being combusted in a flare shall be calculated using the following equation:

$$H_T = K \left(\sum_{i=1}^n C_i H_i \right)$$

[View or download PDF](#)

Where:

H_T = Net heating value of the sample, MJ/scm (BTU/scf); where the net enthalpy per mole of offgas is based on combustion at 25 °C and 760 mm Hg (77 °F and 14.7 psi), but the standard temperature for determining the volume corresponding to one mole is 20 °C (68 °F).

K = conversion constant, 1.740×10^7 (g-mole) (MJ)/(ppm-scm-kcal) (metric units); or 4.674×10^6 ((g-mole) (Btu)/(ppm-scf-kcal)) (English units)

C_i = Concentration of sample component "i" in ppm, as measured by Method 18 of appendix A to 40 CFR part 60 and ASTM D2504-67, 77, or 88 (Reapproved 1993) (incorporated by reference as specified in §61.18).

H_i = net heat of combustion of sample component "i" at 25 °C and 760 mm Hg (77 °F and 14.7 psi), kcal/g-mole. The heats of combustion may be determined using ASTM D2382-76 or 88 or D4809-95 (incorporated by reference as specified in §61.18) if published values are not available or cannot be calculated.

(4) The actual exit velocity of a flare shall be determined by dividing the volumetric flowrate (in units of standard temperature and pressure), as determined by Method 2, 2A, 2C, or 2D, as appropriate, by the unobstructed (free) cross section area of the flare tip.

(5) The maximum permitted velocity, V_{max} , for air-assisted flares shall be determined by the following equation:

$$V_{max} = K_1 + K_2 H_T$$

[View or download PDF](#)

Where:

V_{max} = Maximum permitted velocity, m/sec (ft/sec).

H_T = Net heating value of the gas being combusted, as determined in paragraph (e)(3) of this section, MJ/scm (Btu/scf).

K_1 = 8.706 m/sec (metric units)
= 28.56 ft/sec (English units)

K_2 = 0.7084 m⁴/(MJ-sec) (metric units)
= 0.087 ft⁴/(Btu-sec) (English units)

[49 FR 23513, June 6, 1984, as amended at 49 FR 38946, Oct. 2, 1984; 49 FR 43647, Oct. 31, 1984; 53 FR 36972, Sept. 23, 1988; 54 FR 38077, Sept. 14, 1989; 65 FR 62158, Oct. 17, 2000]

[↑ Back to Top](#)

§61.246 Recordkeeping requirements.

(a)(1) Each owner or operator subject to the provisions of this subpart shall comply with the recordkeeping requirements of this section.

(2) An owner or operator of more than one process unit subject to the provisions of this subpart may comply with the recordkeeping requirements for these process units in one recordkeeping system if the system identifies each record by each process unit.

(b) When each leak is detected as specified in §§61.242-2, 61.242-3, 61.242-7, 61.242-8, and 61.135, the following requirements apply:

(1) A weatherproof and readily visible identification, marked with the equipment identification number, shall be attached to the leaking equipment.

(2) The identification on a valve may be removed after it has been monitored for 2 successive months as specified in §61.242-7(c) and no leak has been detected during those 2 months.

(3) The identification on equipment, except on a valve, may be removed after it has been repaired.

(c) When each leak is detected as specified in §§61.242-2, 61.242-3, 61.242-7, 61.242-8, and 61.135, the following information shall be recorded in a log and shall be kept for 2 years in a readily accessible location:

(1) The instrument and operator identification numbers and the equipment identification number.

(2) The date the leak was detected and the dates of each attempt to repair the leak.

(3) Repair methods applied in each attempt to repair the leak.

(4) "Above 10,000" if the maximum instrument reading measured by the methods specified in §61.245(a) after each repair attempt is equal to or greater than 10,000 ppm.

(5) "Repair delayed" and the reason for the delay if a leak is not repaired within 15 calendar days after discovery of the leak.

(6) The signature of the owner or operator (or designate) whose decision it was that repair could not be effected without a process shutdown.

(7) The expected date of successful repair of the leak if a leak is not repaired within 15 calendar days.

(8) Dates of process unit shutdowns that occur while the equipment is unrepaired.

(9) The date of successful repair of the leak.

(d) The following information pertaining to the design requirements for closed-vent systems and control devices described in §61.242-11 shall be recorded and kept in a readily accessible location:

(1) Detailed schematics, design specifications, and piping and instrumentation diagrams.

(2) The dates and descriptions of any changes in the design specifications.

(3) A description of the parameter or parameters monitored, as required in §61.242-11(e), to ensure that control devices are operated and maintained in conformance with their design and an explanation of why that parameter (or parameters) was selected for the monitoring.

(4) Periods when the closed-vent systems and control devices required in §§61.242-2, 61.242-3, 61.242-4, 61.242-5 and 61.242-9 are not operated as designed, including periods when a flare pilot light does not have a flame.

(5) Dates of startups and shutdowns of the closed-vent systems and control devices required in §§61.242-2, 61.242-3, 61.242-4, 61.242-5 and 61.242-9.

(e) The following information pertaining to all equipment to which a standard applies shall be recorded in a log that is kept in a readily accessible location:

(1) A list of identification numbers for equipment (except welded fittings) subject to the requirements of this subpart.

(2)(i) A list of identification numbers for equipment that the owner or operator elects to designate for no detectable emissions as indicated by an instrument reading of less than 500 ppm above background.

(ii) The designation of this equipment for no detectable emissions shall be signed by the owner or operator.

(3) A list of equipment identification numbers for pressure relief devices required to comply with §61.242-4(a).

(4)(i) The dates of each compliance test required in §§61.242-2(e), 61.242-3(i), 61.242-4, 61.242-7(f), and 61.135(g).

(ii) The background level measured during each compliance test.

(iii) The maximum instrument reading measured at the equipment during each compliance test.

(5) A list of identification numbers for equipment in vacuum service.

(f) The following information pertaining to all valves subject to the requirements of §61.242-7(g) and (h) and to all pumps subject to the requirements of §61.242-2(g) shall be recorded in a log that is kept in a readily accessible location:

(1) A list of identification numbers for valves and pumps that are designated as unsafe to monitor, an explanation for each valve or pump stating why the valve or pump is unsafe to monitor, and the plan for monitoring each valve or pump.

(2) A list of identification numbers for valves that are designated as difficult to monitor, an explanation for each valve stating why the valve is difficult to monitor, and the planned schedule for monitoring each valve.

(g) The following information shall be recorded for valves complying with §61.243-2:

(1) A schedule of monitoring.

(2) The percent of valves found leaking during each monitoring period.

(h) The following information shall be recorded in a log that is kept in a readily accessible location:

(1) Design criterion required in §§61.242-2(d)(5), 61.242-3(e)(2), and 61.135(e)(4) and an explanation of the design criterion; and

(2) Any changes to this criterion and the reasons for the changes.

(i) The following information shall be recorded in a log that is kept in a readily accessible location for use in determining exemptions as provided in the applicability section of this subpart and other specific subparts:

(1) An analysis demonstrating the design capacity of the process unit, and

(2) An analysis demonstrating that equipment is not in VHAP service.

(j) Information and data used to demonstrate that a piece of equipment is not in VHAP service shall be recorded in a log that is kept in a readily accessible location.

[↑ Back to Top](#)

§61.247 Reporting requirements.

(a)(1) An owner or operator of any piece of equipment to which this subpart applies shall submit a statement in writing notifying the Administrator that the requirements of §§61.242, 61.245, 61.246, and 61.247 are being implemented.

(2) In the case of an existing source or a new source which has an initial startup date preceding the effective date, the statement is to be submitted within 90 days of the effective date, unless a waiver of compliance is granted under §61.11, along with the information required under §61.10. If a waiver of compliance is granted, the statement is to be submitted on a date scheduled by the Administrator.

(3) In the case of new sources which did not have an initial startup date preceding December 14, 2000, the statement required under paragraph (a)(1) of this section shall be submitted with the application for approval of construction, as described in §61.07.

(4) For owners and operators complying with 40 CFR part 65, subpart C or F, the statement required under paragraph (a)(1) of this section shall notify the Administrator that the requirements of 40 CFR part 65, subpart C or F, are being implemented.

(5) The statement is to contain the following information for each source:

(i) Equipment identification number and process unit identification.

(ii) Type of equipment (for example, a pump or pipeline valve).

(iii) Percent by weight VHAP in the fluid at the equipment.

(iv) Process fluid state at the equipment (gas/vapor or liquid).

(v) Method of compliance with the standard (for example, “monthly leak detection and repair” or “equipped with dual mechanical seals”).

(b) A report shall be submitted to the Administrator semiannually starting 6 months after the initial report required in paragraph (a) of this section, that includes the following information:

(1) Process unit identification.

(2) For each month during the semiannual reporting period,

(i) Number of valves for which leaks were detected as described in §61.242-7(b) of §61.243-2.

(ii) Number of valves for which leaks were not repaired as required in §61.242-7(d).

(iii) Number of pumps for which leaks were detected as described in §61.242-2 (b) and (d)(6).

(iv) Number of pumps for which leaks were not repaired as required in §61.242-2 (c) and (d)(6).

(v) Number of compressors for which leaks were detected as described in §61.242-3(f).

(vi) Number of compressors for which leaks were not repaired as required in §61.242-3(g).

(vii) The facts that explain any delay of repairs and, where appropriate, why a process unit shutdown was technically infeasible.

(3) Dates of process unit shutdowns which occurred within the semiannual reporting period.

(4) Revisions to items reported according to paragraph (a) if changes have occurred since the initial report or subsequent revisions to the initial report.

NOTE: Compliance with the requirements of §61.10(c) is not required for revisions documented under this paragraph.

(5) The results of all performance tests and monitoring to determine compliance with no detectable emissions and with §§61.243-1 and 61.243-2 conducted within the semiannual reporting period.

(c) In the first report submitted as required in paragraph (a) of this section, the report shall include a reporting schedule stating the months that semiannual reports shall be submitted. Subsequent reports shall be submitted according to that schedule, unless a revised schedule has been submitted in a previous semiannual report.

(d) An owner or operator electing to comply with the provisions of §§61.243-1 and 61.243-2 shall notify the Administrator of the alternative standard selected 90 days before implementing either of the provisions.

(e) An application for approval of construction or modification, §§61.05(a) and 61.07, will not be required if—

(1) The new source complies with the standard, §61.242;

(2) The new source is not part of the construction of a process unit; and

(3) In the next semiannual report required by paragraph (b) of this section, the information in paragraph (a)(5) of this section is reported.

(f) For owners or operators choosing to comply with 40 CFR part 65, subpart C or F, an application for approval of construction or modification, as required under §§61.05 and 61.07 will not be required if:

(1) The new source complies with 40 CFR 65.106 through 65.115 and with 40 CFR part 65, subpart C, for surge control vessels and bottoms receivers;

(2) The new source is not part of the construction of a process unit; and

(3) In the next semiannual report required by 40 CFR 65.120(b) and 65.48(b), the information in paragraph (a)(5) of this section is reported.

[49 FR 23513, June 6, 1984, as amended at 49 FR 38947, Oct. 2, 1984; 54 FR 38077, Sept. 14, 1989; 65 FR 78283, Dec. 14, 2000]

 [Back to Top](#)

Table 1 to Subpart V of Part 61—Surge Control Vessels and Bottoms Receivers at Existing Sources

Vessel capacity (cubic meters)	Vapor pressure¹ (kilopascals)
$75 \leq \text{capacity} < 151$	≥ 13.1
$151 \leq \text{capacity}$	≥ 5.2

¹Maximum true vapor pressure as defined in §61.241.

[65 FR 78283, Dec. 14, 2000]

[↑ Back to Top](#)

Table 2 to Subpart V of Part 61—Surge Control Vessels and Bottoms Receivers at New Sources

Vessel capacity (cubic meters)	Vapor pressure¹ (kilopascals)
$38 \leq \text{capacity} < 151$	≥ 13.1
$151 \leq \text{capacity}$	≥ 0.7

¹Maximum true vapor pressure as defined in §61.241.

[65 FR 78283, Dec. 14, 2000]

[↑ Back to Top](#)

Appendix I

Subpart Y—National Emission Standard for Benzene Emissions From Benzene Storage Vessels

Contents

- §61.270 Applicability and designation of sources.
 - §61.271 Emission standard.
 - §61.272 Compliance provisions.
 - §61.273 Alternative means of emission limitation.
 - §61.274 Initial report.
 - §61.275 Periodic report.
 - §61.276 Recordkeeping.
 - §61.277 Delegation of authority.
-

SOURCE: 54 FR 38077, Sept. 14, 1989, unless otherwise noted.

[↑ Back to Top](#)

§61.270 Applicability and designation of sources.

(a) The source to which this subpart applies is each storage vessel that is storing benzene having a specific gravity within the range of specific gravities specified in ASTM D836-84 for Industrial Grade Benzene, ASTM D835-85 for Refined Benzene-485, ASTM D2359-85a or 93 for Refined Benzene-535, and ASTM D4734-87 or 96 for Refined Benzene-545. These specifications are incorporated by reference as specified in §61.18. See §61.18 for acceptable versions of these methods.

(b) Except for paragraph (b) in §61.276, storage vessels with a design storage capacity less than 38 cubic meters (10,000 gallons) are exempt from the provisions of this subpart.

(c) This subpart does not apply to storage vessels used for storing benzene at coke by-product facilities.

(d) This subpart does not apply to vessels permanently attached to motor vehicles such as trucks, rail cars, barges, or ships.

(e) This subpart does not apply to pressure vessels designed to operate in excess of 204.9 kPa (29.72 psia) and without emissions to the atmosphere.

(f) A designated source subject to the provisions of this subpart that is also subject to applicable provisions of 40 CFR part 60 subparts K, Ka, and Kb shall be required to comply only with the subpart that contains the most stringent requirements for that source.

(g) *Alternative means of compliance—(1) Option to comply with part 65.* Owners or operators may choose to comply with 40 CFR part 65, subpart C, to satisfy the requirements of §§61.271 through 61.277, except for §§61.271(d)(2) and 61.274(a) for storage vessels that are subject to this subpart. Other provisions applying to owners or operators who choose to comply with 40 CFR part 65 are provided in 40 CFR 65.1.

(2) *Part 61, subpart A.* Owners or operators who choose to comply with 40 CFR part 65, subpart C, must also comply with §§61.01, 61.02, 61.05 through 61.08, 61.10(b) through (d), 61.11, and 61.15 for those storage vessels. All sections and paragraphs of subpart A of this part that are not mentioned in this paragraph (g)(2) do not apply for storage vessels complying with 40 CFR part 65, subpart C, except that

provisions required to be met prior to implementing 40 CFR part 65 still apply. Owners and operators who choose to comply with 40 CFR part 65, subpart C, must comply with 40 CFR part 65, subpart A.

[54 FR 38077, Sept. 14, 1989, as amended at 65 FR 62159, Oct. 17, 2000; 65 FR 78283, Dec. 14, 2000]

[↑ Back to Top](#)

§61.271 Emission standard.

The owner or operator of each storage vessel with a design storage capacity greater than or equal to 38 cubic meters (10,000 gallons) to which this subpart applies shall comply with the requirements in paragraph (d) of this section and with the requirements either in paragraph (a), (b), or (c) of this section, or equivalent as provided in §61.273.

(a) The storage vessel shall be equipped with a fixed roof and an internal floating roof.

(1) An internal floating roof means a cover that rests on the liquid surface (but not necessarily in complete contact with it) inside a storage vessel that has a permanently affixed roof. The internal floating roof shall be floating on the liquid surface at all times, except during initial fill and during those intervals when the storage vessel is completely emptied or subsequently emptied and refilled. When the roof is resting on the leg supports, the process of filling, emptying, or refilling shall be continuous and shall be accomplished as rapidly as possible.

(2) Each internal floating roof shall be equipped with one of the closure devices listed in paragraphs (a)(2) (i), (ii), or (iii) of this section between the wall of the storage vessel and the edge of the internal floating roof. This requirement does not apply to each existing storage vessel for which construction of an internal floating roof equipped with a continuous seal commenced on or before July 28, 1988. A continuous seal means a seal that forms a continuous closure that completely covers the space between the wall of the storage vessel and the edge of the internal floating roof.

(i) A foam- or liquid-filled seal mounted in contact with the liquid (liquid-mounted seal). A liquid-mounted seal means a foam- or liquid-filled seal mounted in contact with the liquid between the wall of the storage vessel and the floating roof continuously around the circumference of the vessel.

(ii) Two seals mounted one above the other so that each forms a continuous closure that completely covers the space between the wall of the storage vessel and the edge of the internal floating roof. The lower seal may be vapor-mounted, but both must be continuous.

(iii) A metallic shoe seal. A metallic shoe seal (also referred to as a mechanical shoe seal) is, but is not limited to, a metal sheet held vertically against the wall of the storage vessel by springs or weighted levers and is connected by braces to the floating roof. A flexible coated fabric (envelope) spans the annular space between the metal sheet and the floating roof.

(3) Automatic bleeder vents are to be closed at all times when the roof is floating, except when the roof is being floated off or is being landed on the roof leg supports.

(4) Each opening in a noncontact internal floating roof except for automatic bleeder vents (vacuum breaker vents) and the rim space vents is to provide a projection below the liquid surface.

(5) Each internal floating roof shall meet the specifications listed below. If an existing storage vessel had an internal floating roof with a continuous seal as of July 28, 1988, the requirements listed below do not have to be met until the first time after September 14, 1989, the vessel is emptied and degassed or September 14, 1999, whichever occurs first,

(i) Each opening in the internal floating roof except for leg sleeves, automatic bleeder vents, rim space vents, column wells, ladder wells, sample wells, and stub drains is to be equipped with a cover or lid. The cover or lid shall be equipped with a gasket. Covers on each access hatch and automatic gauge float well shall be bolted.

(ii) Each penetration of the internal floating roof for the purposes of sampling shall be a sample well. Each sample well shall have a slit fabric cover that covers at least 90 percent of the opening.

(iii) Each automatic bleeder vent shall be gasketed.

(iv) Rim space vents shall be equipped with a gasket.

(v) Each penetration of the internal floating roof that allows for passage of a ladder shall have a gasketed sliding cover.

(vi) Each penetration of the internal floating roof that allows for passage of a column supporting the fixed roof shall have a flexible fabric sleeve seal or a gasketed sliding cover.

(6) Each cover or lid on any opening in the internal floating roof shall be closed (i.e., no visible gaps), except when a device is in actual use. Covers on each access hatch and each automatic gauge float well which are equipped with bolts shall be bolted when they are not in use. Rim space vents are to be set to open only when the internal floating roof is not floating or at the manufacturer's recommended setting.

(b) The storage vessel shall have an external floating roof.

(1) An external floating roof means a pontoon-type or double-deck-type cover that rests on the liquid surface in a vessel with no fixed roof.

(2) Each external floating roof shall be equipped with a closure device between the wall of the storage vessel and the roof edge. Except as provided in paragraph (b)(5) of this section, the closure device is to consist of two seals, one above the other. The lower seal is referred to as the primary seal and the upper seal is referred to as the secondary seal.

(i) The primary seal shall be either a metallic shoe seal or a liquid-mounted seal. A liquid-mounted seal means a foam- or liquid-filled seal mounted in contact with the liquid between the wall of the storage vessel and the floating roof continuously around the circumference of the vessel. A metallic shoe seal (which can also be referred to as a mechanical shoe seal) is, but is not limited to, a metal sheet held vertically against the wall of the storage vessel by springs or weighted levers and is connected by braces to the floating roof. A flexible coated fabric (envelope) spans the annular space between the metal sheet and the floating roof. Except as provided in §61.272(b)(4), the primary seal shall completely cover the annular space between the edge of the floating roof and the vessel wall.

(ii) The secondary seal shall completely cover the annular space between the external floating roof and the wall of the storage vessel in a continuous fashion except as allowed in §61.272(b)(4).

(3) Except for automatic bleeder vents and rim space vents, each opening in the noncontact external floating roof shall provide a projection below the liquid surface. Except for automatic bleeder vents, rim space vents, roof drains, and leg sleeves, each opening in the roof is to be equipped with a gasketed cover, seal or lid which is to be maintained in a closed position at all times (i.e., no visible gap) except when the device is in actual use. Automatic bleeder vents are to be closed at all times when the roof is floating, except when the roof is being floated off or is being landed on the roof leg supports. Rim vents are to be set to open when the roof is being floated off the roof leg supports or at the manufacturer's

recommended setting. Automatic bleeder vents and rim space vents are to be gasketed. Each emergency roof drain is to be provided with a slotted membrane fabric cover that covers at least 90 percent of the area of the opening.

(4) The roof shall be floating on the liquid at all times (i.e., off the roof leg supports) except during initial fill until the roof is lifted off leg supports and when the vessel is completely emptied and subsequently refilled. The process of emptying and refilling when the roof is resting on the leg supports shall be continuous and shall be accomplished as rapidly as possible.

(5) The requirement for a secondary seal does not apply to each existing storage vessel that was equipped with a liquid-mounted primary seal as of July 28, 1988, until after the first time after September 14, 1989, when the vessel is emptied and degassed or 10 years from September 14, 1989, whichever occurs first.

(c) The storage vessel shall be equipped with a closed vent system and a control device.

(1) The closed vent system shall be designed to collect all benzene vapors and gases discharged from the storage vessel and operated with no detectable emissions, as indicated by an instrument reading of less than 500 ppm above background and visual inspections, as determined in §61.242-11 (subpart V).

(2) The control device shall be designed and operated to reduce inlet benzene emissions by 95 percent or greater. If a flare is used as the control device, it shall meet the specifications described in the general control device requirements of 40 CFR 60.18.

(3) The specifications and requirements listed in paragraphs (c)(1) and (c)(2) of this section for closed vent systems and control devices do not apply during periods of routine maintenance. During periods of routine maintenance, the benzene level in the storage vessel(s) serviced by the control device subject to the provisions of §61.271(c) may be lowered but not raised. Periods of routine maintenance shall not exceed 72 hours as outlined in the maintenance plan required by §61.272(c)(1)(iii).

(4) The specifications and requirements listed in paragraphs (c)(1) and (c)(2) of this section for closed vents and control devices do not apply during a control system malfunction. A control system malfunction means any sudden and unavoidable failure of air pollution control equipment. A failure caused entirely or in part by design deficiencies, poor maintenance, careless operation, or other preventable upset condition or equipment breakdown is not considered a malfunction.

(d) The owner or operator of each affected storage vessel shall meet the requirements of paragraph (a), (b), or (c) of this section or §61.270(g) as follows:

(1) The owner or operator of each existing benzene storage vessel shall meet the requirements of paragraph (a), (b), or (c) of this section no later than 90 days after September 14, 1989, with the exceptions noted in paragraphs (a)(5) and (b)(5), unless a waiver of compliance has been approved by the Administrator in accordance with §61.11.

(2) The owner or operator of each benzene storage vessel upon which construction commenced after September 14, 1989 shall meet the requirements of paragraph (a), (b), or (c) of this section or §61.270(g) prior to filling (i.e., roof is lifted off leg supports) the storage vessel with benzene.

(3) The owner or operator of each benzene storage vessel upon which construction commenced on or after July 28, 1988, and before September 14, 1989, shall meet the requirements of paragraph (a), (b), or (c) of this section on September 14, 1989.

[↑ Back to Top](#)

§61.272 Compliance provisions.

(a) For each vessel complying with §61.271(a) (fixed roof and internal floating roof) each owner or operator shall:

(1) After installing the control equipment required to comply with §61.271(a), visually inspect the internal floating roof, the primary seal, and the secondary seal (if one is in service), prior to filling the storage vessel with benzene. If there are holes, tears or other openings in the primary seal, the secondary seal, or the seal fabric, or defects in the internal floating roof, the owner or operator shall repair the items before filling the storage vessel.

(2) Visually inspect the internal floating roof and the primary seal or the secondary seal (if one is in service) through manholes and roof hatches on the fixed roof at least once every 12 months after initial fill, or at least once every 12 months after September 14, 1989, except as provided in paragraph (a)(4)(i) of this section. If the internal floating roof is not resting on the surface of the benzene liquid inside the storage vessel, or there is liquid on the roof, or the seal is detached, or there are holes or tears in the seal fabric, the owner or operator shall repair the items or empty and remove the storage vessel from service within 45 days. If a failure that is detected during inspections required in this paragraph cannot be repaired within 45 days and if the vessel cannot be emptied within 45 days, an extension of up to 30 additional days may be requested from the Administrator in the inspection report required in §61.275(a). Such a request for an extension must document that alternate storage capacity is unavailable and specify a schedule of actions the company will take that will ensure that the control equipment will be repaired or the vessel will be emptied as soon as possible.

(3) Visually inspect the internal floating roof, the primary seal, the secondary seal (if one is in service), gaskets, slotted membranes and sleeve seals (if any) each time the storage vessel is emptied and degassed. In no event shall inspections conducted in accordance with this provision occur at intervals greater than 10 years in the case of vessels conducting the annual visual inspections as specified in paragraph (a)(2) of this section and at intervals greater than 5 years in the case of vessels specified in paragraph (a)(4)(i) of this section.

(i) For all the inspections required by paragraphs (a)(1) and (a)(3) of this section, the owner or operator shall notify the Administrator in writing at least 30 days prior to the refilling of each storage vessel to afford the Administrator the opportunity to have an observer present. If the inspection required by paragraph (a)(3) of this section is not planned and the owner or operator could not have known about the inspection 30 days in advance of refilling the vessel, the owner or operator shall notify the Administrator at least 7 days prior to the refilling of the storage vessel. Notification shall be made by telephone immediately followed by written documentation demonstrating why the inspection was unplanned. Alternatively, the notification including the written documentation may be made in writing and sent by express mail so that it is received by the Administrator at least 7 days prior to refilling.

(ii) If the internal floating roof has defects, the primary seal has holes, tears, or other openings in the seal or the seal fabric, or the secondary seal has holes, tears, or other openings in the seal or the seal fabric, or the gaskets no longer close off the liquid surfaces from the atmosphere, or the slotted membrane has more than 10 percent open area, the owner or operator shall repair the items as necessary so that none of the conditions specified in this paragraph exist before refilling the storage vessel with benzene.

(4) For vessels equipped with a double-seal system as specified in §61.271(a)(2)(ii):

(i) Visually inspect the vessel as specified in paragraph (a)(3) of this section at least every 5 years;
or

(ii) Visually inspect the vessel annually as specified in paragraph (a)(2) of this section, and at least every 10 years as specified in paragraph (a)(3) of this section.

(b) For each vessel complying with §61.271(b) (external floating roof) the owner or operator shall:

(1) Determine the gap areas and maximum gap widths between the primary seal and the wall of the storage vessel, and the secondary seal and the wall of the storage vessel according to the following frequency.

(i) For an external floating roof vessel equipped with primary and secondary seals, measurements of gaps between the vessel wall and the primary seal (seal gaps) shall be performed during the hydrostatic testing of the vessel or within 90 days of the initial fill with benzene or within 90 days of September 14, 1989, whichever occurs last, and at least once every 5 years thereafter, except as provided in paragraph (b)(1)(ii) of this section.

(ii) For an external floating roof vessel equipped with a liquid-mounted primary seal and without a secondary seal as provided for in §61.271(b)(5), measurement of gaps between the vessel wall and the primary seal (seal gaps) shall be performed within 90 days of September 14, 1989, and at least once per year thereafter. When a secondary seal is installed over the primary seal, measurement of primary seal gaps shall be performed within 90 days of installation and at least once every 5 years thereafter.

(iii) For an external floating roof vessel equipped with primary and secondary seals, measurements of gaps between the vessel wall and the secondary seal shall be performed within 90 days of the initial fill with benzene, within 90 days of installation of the secondary seal, or within 90 days after September 14, 1989, whichever occurs last, and at least once per year thereafter.

(iv) If any source ceases to store benzene for a period of 1 year or more, subsequent introduction of benzene into the vessel shall be considered an initial fill for the purposes of paragraphs (b)(1)(i), (b)(1)(ii), and (b)(1)(iii) of this section.

(2) Determine gap widths and areas in the primary and secondary seals individually by the following procedures:

(i) Measure seal gaps, if any, at one or more floating roof levels when the roof is floating off the roof leg supports.

(ii) Measure seal gaps around the entire circumference of the vessel in each place where a 0.32 centimeter (cm) (1/8 in) diameter uniform probe passes freely (without forcing or binding against the seal) between the seal and the wall of the storage vessel and measure the circumferential distance of each such location.

(iii) The total surface area of each gap described in paragraph (b)(2)(ii) of this section shall be determined by using probes of various widths to measure accurately the actual distance from the vessel wall to the seal and multiplying each such width by its respective circumferential distance.

(3) Add the gap surface area of each gap location for the primary seal and the secondary seal individually. Divide the sum for each seal by the nominal diameter of the vessel and compare each ratio to the respective standards in §61.272(b)(4) and §61.272(b)(5).

(4) Repair conditions that do not meet requirements listed in paragraph (b)(4) (i) and (ii) within 45 days of identification in any inspection or empty and remove the storage vessel from service within 45 days.

(i) The accumulated area of gaps between the vessel wall and the metallic shoe seal or the liquid-mounted primary seal shall not exceed 212 cm² per meter of vessel diameter (10.0 in² per foot of vessel diameter) and the width of any portion of any gap shall not exceed 3.81 cm (1½ in).

(A) One end of the metallic shoe is to extend into the stored liquid and the other end is to extend a minimum vertical distance of 61 cm (24 in) above the stored liquid surface.

(B) There are to be no holes, tears, or other openings in the shoe, seal fabric, or seal envelope.

(ii) The secondary seal is to meet the following requirements:

(A) The secondary seal is to be installed above the primary seal so that it completely covers the space between the roof edge and the vessel wall except as provided in paragraph (b)(4)(ii)(B) of this section.

(B) The accumulated area of gaps between the vessel wall and the secondary seal shall not exceed 21.2 cm² per meter of vessel diameter (1.0 in² per foot of vessel diameter) or the width of any portion of any gap shall not exceed 1.27 cm (½ in). These seal gap requirements may be exceeded during the measurement of primary seal gaps as required by paragraph (b)(1)(i) or (b)(1)(ii) of this section.

(C) There are to be no holes, tears, or other openings in the seal or seal fabric.

(iii) If a failure that is detected during inspections required in this paragraph cannot be repaired within 45 days and if the vessel cannot be emptied within 45 days, an extension of up to 30 additional days may be requested from the Administrator in the inspection report required in §61.275(d). Such extension request must include a demonstration of unavailability of alternate storage capacity and a specification of a schedule that will assure that the control equipment will be repaired or the vessel will be emptied as soon as possible.

(5) The owner or operator shall notify the Administrator 30 days in advance of any gap measurements required by paragraph (b)(1) of this section to afford the Administrator the opportunity to have an observer present.

(6) Visually inspect the external floating roof, the primary seal, secondary seal, and fittings each time the vessel is emptied and degassed.

(i) If the external floating roof has defects, the primary seal has holes, tears, or other openings in the seal or the seal fabric, or the secondary seal has holes, tears, or other openings in the seal or the seal fabric, the owner or operator shall repair the items as necessary so that none of the conditions specified in this paragraph exist before filling or refilling the storage vessel with benzene.

(ii) For all the inspections required by paragraph (b)(6) of this section, the owner or operator shall notify the Administrator in writing at least 30 days prior to filling or refilling of each storage vessel to afford the Administrator the opportunity to inspect the storage vessel prior to refilling. If the inspection required by paragraph (b)(6) of this section is not planned and the owner or operator could not have known about the inspection 30 days in advance of refilling the vessel, the owner or operator shall notify the Administrator at least 7 days prior to refilling of the storage vessel. Notification shall be made by telephone immediately followed by written documentation demonstrating why the inspection was

unplanned. Alternatively, this notification including the written documentation may be made in writing and sent by express mail so that it is received by the Administrator at least 7 days prior to the refilling.

(c) The owner or operator of each source that is equipped with a closed vent system and control device as required in §60.271(c), other than a flare, shall meet the following requirements.

(1) Within 90 days after initial fill or after September 14, 1989, whichever comes last, submit for approval by the Administrator, an operating plan containing the information listed below.

(i) Documentation demonstrating that the control device being used achieves the required control efficiency during reasonably expected maximum loading conditions. This documentation is to include a description of the gas stream which enters the control device, including flow and benzene content under varying liquid level conditions (dynamic and static) and manufacturer's design specifications for the control device. If the control device or the closed vent capture system receives vapors, gases or liquids, other than fuels, from sources that are not designated sources under this subpart, the efficiency demonstration is to include consideration of all vapors, gases and liquids received by the closed vent capture system and control device. If an enclosed combustion device with a minimum residence time of 0.75 seconds and a minimum temperature of 816 °C (1,500 °F) is used to meet the 95 percent requirement, documentation that those conditions exist is sufficient to meet the requirements of this paragraph.

(ii) A description of the parameter or parameters to be monitored to ensure that the control device is operated and maintained in conformance with its design and an explanation of the criteria used for selection of that parameter (or parameters).

(iii) A maintenance plan for the system including the type of maintenance necessary, planned frequency of maintenance, and lengths of maintenance periods for those operations that would require the closed vent system or the control device to be out of compliance with §61.271(c). The maintenance plan shall require that the system be out of compliance with §61.271(c) for no more than 72 hours per year.

(2) Operate, monitor the parameters, and maintain the closed vent system and control device in accordance with the operating plan submitted to the Administrator in accordance with paragraph (c)(1) of this section, unless the plan was modified by the Administrator during the approval process. In this case, the modified plan applies.

(d) The owner or operator of each source that is equipped with a closed vent system and a flare to meet the requirements in §61.271(c) shall meet the requirements as specified in the general control device requirements in 40 CFR 60.18 (e) and (f).

[54 FR 38077, Sept. 14, 1989, as amended at 65 FR 62159, Oct. 17, 2000]

[↑ Back to Top](#)

§61.273 Alternative means of emission limitation.

(a) Upon written application from any person, the Administrator may approve the use of alternative means of emission limitation which have been demonstrated to his satisfaction to achieve a reduction in benzene emissions at least equivalent to the reduction in emissions achieved by any requirement in §61.271 (a), (b), or (c) of this subpart.

(b) Determination of equivalence to the reduction in emissions achieved by the requirements of §61.271 (a), (b), or (c) will be evaluated using the following information to be included in the written application to the Administrator:

(1) Actual emissions tests that use full-size or scale-model storage vessels that accurately collect and measure all benzene emissions from a given control device, and that accurately simulate wind and account for other emission variables such as temperature and barometric pressure.

(2) An engineering evaluation that the Administrator determines is an accurate method of determining equivalence.

(c) The Administrator may condition approval of equivalency on requirements that may be necessary to ensure operation and maintenance to achieve the same emission reduction as the requirements of §61.271 (a), (b), or (c).

(d) If, in the Administrator's judgment, an application for equivalence may be approvable, the Administrator will publish a notice of preliminary determination in the FEDERAL REGISTER and provide the opportunity for public hearing. After notice and opportunity for public hearing, the Administrator will determine the equivalence of the alternative means of emission limitation and will publish the final determination in the FEDERAL REGISTER.

[↑ Back to Top](#)

§61.274 Initial report.

(a) The owner or operator of each storage vessel to which this subpart applies and which has a design capacity greater than or equal to 38 cubic meters (10,000 gallons) shall submit an initial report describing the controls which will be applied to meet the equipment requirements of §61.271 or §61.270(g). For an existing storage vessel or a new storage vessel for which construction and operation commenced prior to September 14, 1989, this report shall be submitted within 90 days of September 14, 1989 and can be combined with the report required by §61.10. For a new storage vessel for which construction or operation commenced on or after September 14, 1989, the report shall be combined with the report required by §61.07 or 40 CFR 65.5(b). In the case where the owner or operator seeks to comply with §61.271(c), with a control device other than a flare, this information may consist of the information required by §61.272(c)(1).

(b) The owner or operator of each storage vessel seeking to comply with §61.271(c) with a flare, shall submit a report containing the measurements required by 40 CFR 60.18(f) (1), (2), (3), (4), (5), and (6). For the owner or operator of an existing storage vessel not seeking to obtain a waiver or a new storage vessel for which construction and operation commenced prior to September 14, 1989, this report shall be combined with the report required by paragraph (a) of this section. For the owner or operator of an existing storage vessel seeking to obtain a waiver, the reporting date will be established in the response to the waiver request. For the owner or operator of a new storage vessel for which construction or operation commenced after September 14, 1989, the report shall be submitted within 90 days of the date the vessel is initially filled (or partially filled) with benzene.

[54 FR 38077, Sept. 14, 1989, as amended at 65 FR 78284, Dec. 14, 2000]

[↑ Back to Top](#)

§61.275 Periodic report.

(a) The owner or operator of each storage vessel to which this subpart applies after installing control equipment in accordance with §61.271(a) (fixed roof and internal floating roof) shall submit a report describing the results of each inspection conducted in accordance with §61.272(a). For vessels for which annual inspections are required under §61.272(a)(2), the first report is to be submitted no more than 12 months after the initial report submitted in accordance with §61.274, and each report is to be submitted within 60 days of each annual inspection.

(1) Each report shall include the date of the inspection of each storage vessel and identify each storage vessel in which:

(i) The internal floating roof is not resting on the surface of the benzene liquid inside the storage vessel, or there is liquid on the roof, or the seal is detached from the internal floating roof, or there are holes, tears or other openings in the seal or seal fabric; or

(ii) There are visible gaps between the seal and the wall of the storage vessel.

(2) Where an annual report identifies any condition in paragraph (a)(1) of this section the annual report shall describe the nature of the defect, the date the storage vessel was emptied, and the nature of and date the repair was made, except as provided in paragraph (a)(3) of this section.

(3) If an extension is requested in an annual periodic report in accordance with §61.272(a)(2), a supplemental periodic report shall be submitted within 15 days of repair. The supplemental periodic report shall identify the vessel and describe the date the storage vessel was emptied and the nature of and date the repair was made.

(b) The owner or operator of each storage vessel to which this subpart applies after installing control equipment in accordance with §61.271(a) (fixed roof and internal floating roof) shall submit a report describing the results of each inspection conducted in accordance with §61.272(a) (3) or (4).

(1) The report is to be submitted within 60 days of conducting each inspection required by §61.272(a) (3) or (4).

(2) Each report shall identify each storage vessel in which the owner or operator finds that the internal floating roof has defects, the primary seal has holes, tears, or other openings in the seal or the seal fabric, or the secondary seal (if one has been installed) has holes, tears, or other openings in the seal or the seal fabric, or the gaskets no longer close off the liquid surfaces from the atmosphere, or the slotted membrane has more than 10 percent open area. The report shall also describe the nature of the defect, the date the storage vessel was emptied, and the nature of and date the repair was made.

(c) Any owner or operator of an existing storage vessel which had an internal floating roof with a continuous seal as of July 28, 1988, and which seeks to comply with the requirements of §61.271(a)(5) during the first time after September 14, 1989, when the vessel is emptied and degassed but no later than 10 years from September 14, 1989, shall notify the Administrator 30 days prior to the completion of the installation of such controls and the date of refilling of the vessel so the Administrator has an opportunity to have an observer present to inspect the storage vessel before it is refilled. This report can be combined with the one required by §61.275(b).

(d) The owner or operator of each storage vessel to which this subpart applies after installing control equipment in accordance with §61.271(b) (external floating roof) shall submit a report describing the results of each seal gap measurement made in accordance with §61.272(b). The first report is to be submitted no more than 12 months after the initial report submitted in accordance with §61.274(a), and each annual periodic report is to be submitted within 60 days of each annual inspection.

(1) Each report shall include the date of the measurement, the raw data obtained in the measurement, and the calculations described in §61.272(b) (2) and (3), and shall identify each storage vessel which does not meet the gap specifications of §61.272(b). Where an annual report identifies any vessel not meeting the seal gap specifications of §61.272(b) the report shall describe the date the storage vessel was emptied, the measures used to correct the condition and the date the storage vessel was brought into compliance.

(2) If an extension is requested in an annual periodic report in accordance with §61.272(b)(4)(iii), a supplemental periodic report shall be submitted within 15 days of repair. The supplemental periodic report shall identify the vessel and describe the date the vessel was emptied and the nature of and date the repair was made.

(e) Excess emission report.

(1) The owner or operator of each source seeking to comply with §61.271(c) (vessels equipped with closed vent systems with control devices) shall submit a quarterly report informing the Administrator of each occurrence that results in excess emissions. Excess emissions are emissions that occur at any time when compliance with the specifications and requirements of §61.271(c) are not achieved, as evidenced by the parameters being measured in accordance with §61.272(c)(1)(ii) if a control device other than a flare is used, or by the measurements required in §61.272(d) and the general control device requirements in 40 CFR 60.18(f) (1) and (2) if a flare is used.

(2) The owner or operator shall submit the following information as a minimum in the report required by (e)(1) of this section:

(i) Identify the stack and other emission points where the excess emissions occurred;

(ii) A statement of whether or not the owner or operator believes a control system malfunction has occurred.

(3) If the owner or operator states that a control system malfunction has occurred, the following information as a minimum is also to be included in the report required under paragraph (e)(1) of this section:

(i) Time and duration of the control system malfunction as determined by continuous monitoring data (if any), or the inspections or monitoring done in accordance with the operating plan required by §61.272(c).

(ii) Cause of excess emissions.

[↑ Back to Top](#)

§61.276 Recordkeeping.

(a) Each owner or operator with a storage vessel subject to this subpart shall keep copies of all the reports and records required by this subpart for at least 2 years, except as specified in paragraphs (b) and (c)(1) of this section.

(b) Each owner or operator with a storage vessel, including any vessel which has a design storage capacity less than 38 cubic meters (10,000 gallons), shall keep readily accessible records showing the dimensions of the storage vessel and an analysis showing the capacity of the storage vessel. This record shall be kept as long as the storage vessel is in operation. Each storage vessel with a design capacity of

less than 38 cubic meters (10,000 gallons) is subject to no provisions of this subpart other than those required by this paragraph.

(c) The following information pertaining to closed vent system and control devices shall be kept in a readily accessible location.

(1) A copy of the operating plan. This record shall be kept as long as the closed vent system and control device is in use.

(2) A record of the measured values of the parameters monitored in accordance with §61.272(c)(1)(ii) and §61.272(c)(2).

(3) A record of the maintenance performed in accordance with §61.272(c)(1)(iii) of the operating plan, including the following:

(i) The duration of each time the closed vent system and control device does not meet the specifications of §61.271(c) due to maintenance, including the following:

(A) The first time of day and date the requirements of 61.271(c) were not met at the beginning of maintenance.

(B) The first time of day and date the requirements of §61.271(c) were met at the conclusion of maintenance.

(C) A continuous record of the liquid level in each storage vessel that the closed vent system and control device receive vapors from during the interval between the times specified by (c)(3)(i)(A) and (c)(3)(i)(B). Pumping records (simultaneous input and output) may be substituted for records of the liquid level.

[↑ Back to Top](#)

§61.277 Delegation of authority.

(a) In delegating implementation and enforcement authority to a State under section 112(d) of the Act, the authorities contained in paragraph (b) of this section shall be retained by the Administrator and not transferred to a State.

(b) Authorities which will not be delegated to States: §61.273.

[↑ Back to Top](#)

Appendix J

Subpart FF—National Emission Standard for Benzene Waste Operations

Contents

- [§61.340 Applicability.](#)
- [§61.341 Definitions.](#)
- [§61.342 Standards: General.](#)
- [§61.343 Standards: Tanks.](#)
- [§61.344 Standards: Surface impoundments.](#)
- [§61.345 Standards: Containers.](#)
- [§61.346 Standards: Individual drain systems.](#)
- [§61.347 Standards: Oil-water separators.](#)
- [§61.348 Standards: Treatment processes.](#)
- [§61.349 Standards: Closed-vent systems and control devices.](#)
- [§61.350 Standards: Delay of repair.](#)
- [§61.351 Alternative standards for tanks.](#)
- [§61.352 Alternative standards for oil-water separators.](#)
- [§61.353 Alternative means of emission limitation.](#)
- [§61.354 Monitoring of operations.](#)
- [§61.355 Test methods, procedures, and compliance provisions.](#)
- [§61.356 Recordkeeping requirements.](#)
- [§61.357 Reporting requirements.](#)
- [§61.358 Delegation of authority.](#)
- [§61.359 \[Reserved\]](#)
- [Appendix A to Part 61](#)
- [Appendix B to Part 61—Test Methods](#)
- [Appendix C to Part 61—Quality Assurance Procedures](#)
- [Appendix D to Part 61—Methods for Estimating Radionuclide Emissions](#)
- [Appendix E to Part 61—Compliance Procedures Methods for Determining Compliance With Subpart I](#)

SOURCE: 55 FR 8346, Mar. 7, 1990, unless otherwise noted.

[↑ Back to Top](#)

§61.340 Applicability.

(a) The provisions of this subpart apply to owners and operators of chemical manufacturing plants, coke by-product recovery plants, and petroleum refineries.

(b) The provisions of this subpart apply to owners and operators of hazardous waste treatment, storage, and disposal facilities that treat, store, or dispose of hazardous waste generated by any facility listed in paragraph (a) of this section. The waste streams at hazardous waste treatment, storage, and disposal facilities subject to the provisions of this subpart are the benzene-containing hazardous waste from any facility listed in paragraph (a) of this section. A hazardous waste treatment, storage, and disposal facility is a facility that must obtain a hazardous waste management permit under subtitle C of the Solid Waste Disposal Act.

(c) At each facility identified in paragraph (a) or (b) of this section, the following waste is exempt from the requirements of this subpart:

(1) Waste in the form of gases or vapors that is emitted from process fluids:

(2) Waste that is contained in a segregated stormwater sewer system.

(d) At each facility identified in paragraph (a) or (b) of this section, any gaseous stream from a waste management unit, treatment process, or wastewater treatment system routed to a fuel gas system, as defined in §61.341, is exempt from this subpart. No testing, monitoring, recordkeeping, or reporting is required under this subpart for any gaseous stream from a waste management unit, treatment process, or wastewater treatment unit routed to a fuel gas system.

[55 FR 8346, Mar. 7, 1990, as amended at 55 FR 37231, Sept. 10, 1990; 58 FR 3095, Jan. 7, 1993; 67 FR 68531, Nov. 12, 2002]

[↑ Back to Top](#)

§61.341 Definitions.

Benzene concentration means the fraction by weight of benzene in a waste as determined in accordance with the procedures specified in §61.355 of this subpart.

Car-seal means a seal that is placed on a device that is used to change the position of a valve (e.g., from opened to closed) in such a way that the position of the valve cannot be changed without breaking the seal.

Chemical manufacturing plant means any facility engaged in the production of chemicals by chemical, thermal, physical, or biological processes for use as a product, co-product, by-product, or intermediate including but not limited to industrial organic chemicals, organic pesticide products, pharmaceutical preparations, paint and allied products, fertilizers, and agricultural chemicals. Examples of chemical manufacturing plants include facilities at which process units are operated to produce one or more of the following chemicals: benzenesulfonic acid, benzene, chlorobenzene, cumene, cyclohexane, ethylene, ethylbenzene, hydroquinone, linear alkylbenzene, nitrobenzene, resorcinol, sulfolane, or styrene.

Closed-vent system means a system that is not open to the atmosphere and is composed of piping, ductwork, connections, and, if necessary, flow inducing devices that transport gas or vapor from an emission source to a control device.

Coke by-product recovery plant means any facility designed and operated for the separation and recovery of coal tar derivatives (by-products) evolved from coal during the coking process of a coke oven battery.

Container means any portable waste management unit in which a material is stored, transported, treated, or otherwise handled. Examples of containers are drums, barrels, tank trucks, barges, dumpsters, tank cars, dump trucks, and ships.

Control device means an enclosed combustion device, vapor recovery system, or flare.

Cover means a device or system which is placed on or over a waste placed in a waste management unit so that the entire waste surface area is enclosed and sealed to minimize air emissions. A cover may have openings necessary for operation, inspection, and maintenance of the waste management unit such as access hatches, sampling ports, and gauge wells provided that each opening is closed and sealed when not in use. Example of covers include a fixed roof installed on a tank, a lid installed on a container, and an air-supported enclosure installed over a waste management unit.

External floating roof means a pontoon-type or double-deck type cover with certain rim sealing mechanisms that rests on the liquid surface in a waste management unit with no fixed roof.

Facility means all process units and product tanks that generate waste within a stationary source, and all waste management units that are used for waste treatment, storage, or disposal within a stationary source.

Fixed roof means a cover that is mounted on a waste management unit in a stationary manner and that does not move with fluctuations in liquid level.

Floating roof means a cover with certain rim sealing mechanisms consisting of a double deck, pontoon single deck, internal floating cover or covered floating roof, which rests upon and is supported by the liquid being contained, and is equipped with a closure seal or seals to close the space between the roof edge and unit wall.

Flow indicator means a device which indicates whether gas flow is present in a line or vent system.

Fuel gas system means the offsite and onsite piping and control system that gathers gaseous streams generated by facility operations, may blend them with sources of gas, if available, and transports the blended gaseous fuel at suitable pressures for use as fuel in heaters, furnaces, boilers, incinerators, gas turbines, and other combustion devices located within or outside the facility. The fuel is piped directly to each individual combustion device, and the system typically operates at pressures over atmospheric.

Individual drain system means the system used to convey waste from a process unit, product storage tank, or waste management unit to a waste management unit. The term includes all process drains and common junction boxes, together with their associated sewer lines and other junction boxes, down to the receiving waste management unit.

Internal floating roof means a cover that rests or floats on the liquid surface inside a waste management unit that has a fixed roof.

Liquid-mounted seal means a foam or liquid-filled primary seal mounted in contact with the liquid between the waste management unit wall and the floating roof continuously around the circumference.

Loading means the introduction of waste into a waste management unit but not necessarily to complete capacity (also referred to as filling).

Maximum organic vapor pressure means the equilibrium partial pressure exerted by the waste at the temperature equal to the highest calendar-month average of the waste storage temperature for waste stored above or below the ambient temperature or at the local maximum monthly average temperature as reported by the National Weather Service for waste stored at the ambient temperature, as determined:

- (1) In accordance with §60.17(c); or
- (2) As obtained from standard reference texts; or
- (3) In accordance with §60.17(a)(37); or
- (4) Any other method approved by the Administrator.

No detectable emissions means less than 500 parts per million by volume (ppmv) above background levels, as measured by a detection instrument reading in accordance with the procedures specified in §61.355(h) of this subpart.

Oil-water separator means a waste management unit, generally a tank or surface impoundment, used to separate oil from water. An oil-water separator consists of not only the separation unit but also the forebay and other separator basins, skimmers, weirs, grit chambers, sludge hoppers, and bar screens that are located directly after the individual drain system and prior to additional treatment units such as an air flotation unit, clarifier, or biological treatment unit. Examples of an oil-water separator include an API separator, parallel-plate interceptor, and corrugated-plate interceptor with the associated ancillary equipment.

Petroleum refinery means any facility engaged in producing gasoline, kerosene, distillate fuel oils, residual fuel oils, lubricants, or other products through the distillation of petroleum, or through the redistillation, cracking, or reforming of unfinished petroleum derivatives.

Petroleum means the crude oil removed from the earth and the oils derived from tar sands, shale, and coal.

Point of waste generation means the location where the waste stream exits the process unit component or storage tank prior to handling or treatment in an operation that is not an integral part of the production process, or in the case of waste management units that generate new wastes after treatment, the location where the waste stream exits the waste management unit component.

Process unit means equipment assembled and connected by pipes or ducts to produce intermediate or final products. A process unit can be operated independently if supplied with sufficient fuel or raw materials and sufficient product storage facilities.

Process unit turnaround means the shutting down of the operations of a process unit, the purging of the contents of the process unit, the maintenance or repair work, followed by restarting of the process.

Process unit turnaround waste means a waste that is generated as a result of a process unit turnaround.

Process wastewater means water which comes in contact with benzene during manufacturing or processing operations conducted within a process unit. Process wastewater is not organic wastes, process fluids, product tank drawdown, cooling tower blowdown, steam trap condensate, or landfill leachate.

Process wastewater stream means a waste stream that contains only process wastewater.

Product tank means a stationary unit that is designed to contain an accumulation of materials that are fed to or produced by a process unit, and is constructed primarily of non-earthen materials (e.g., wood, concrete, steel, plastic) which provide structural support.

Product tank drawdown means any material or mixture of materials discharged from a product tank for the purpose of removing water or other contaminants from the product tank.

Safety device means a closure device such as a pressure relief valve, frangible disc, fusible plug, or any other type of device which functions exclusively to prevent physical damage or permanent deformation to a unit or its air emission control equipment by venting gases or vapors directly to the atmosphere during unsafe conditions resulting from an unplanned, accidental, or emergency event. For the purpose of this subpart, a safety device is not used for routine venting of gases or vapors from the vapor headspace underneath a cover such as during filling of the unit or to adjust the pressure in this vapor headspace in response to normal daily diurnal ambient temperature fluctuations. A safety device is designed to remain in a closed position during normal operations and open only when the internal pressure, or another relevant parameter, exceeds the device threshold setting applicable to the air

emission control equipment as determined by the owner or operator based on manufacturer recommendations, applicable regulations, fire protection and prevention codes, standard engineering codes and practices, or other requirements for the safe handling of flammable, ignitable, explosive, reactive, or hazardous materials.

Segregated stormwater sewer system means a drain and collection system designed and operated for the sole purpose of collecting rainfall runoff at a facility, and which is segregated from all other individual drain systems.

Sewer line means a lateral, trunk line, branch line, or other enclosed conduit used to convey waste to a downstream waste management unit.

Slop oil means the floating oil and solids that accumulate on the surface of an oil-water separator.

Sour water stream means a stream that:

(1) Contains ammonia or sulfur compounds (usually hydrogen sulfide) at concentrations of 10 ppm by weight or more;

(2) Is generated from separation of water from a feed stock, intermediate, or product that contained ammonia or sulfur compounds; and

(3) Requires treatment to remove the ammonia or sulfur compounds.

Sour water stripper means a unit that:

(1) Is designed and operated to remove ammonia or sulfur compounds (usually hydrogen sulfide) from sour water streams;

(2) Has the sour water streams transferred to the stripper through hard piping or other enclosed system; and

(3) Is operated in such a manner that the offgases are sent to a sulfur recovery unit, processing unit, incinerator, flare, or other combustion device.

Surface impoundment means a waste management unit which is a natural topographic depression, man-made excavation, or diked area formed primarily of earthen materials (although it may be lined with man-made materials), which is designed to hold an accumulation of liquid wastes or waste containing free liquids, and which is not an injection well. Examples of surface impoundments are holding, storage, settling, and aeration pits, ponds, and lagoons.

Tank means a stationary waste management unit that is designed to contain an accumulation of waste and is constructed primarily of nonearthen materials (e.g., wood, concrete, steel, plastic) which provide structural support.

Treatment process means a stream stripping unit, thin-film evaporation unit, waste incinerator, or any other process used to comply with §61.348 of this subpart.

Vapor-mounted seal means a foam-filled primary seal mounted continuously around the perimeter of a waste management unit so there is an annular vapor space underneath the seal. The annular vapor space is bounded by the bottom of the primary seal, the unit wall, the liquid surface, and the floating roof.

Waste means any material resulting from industrial, commercial, mining or agricultural operations, or from community activities that is discarded or is being accumulated, stored, or physically, chemically, thermally, or biologically treated prior to being discarded, recycled, or discharged.

Waste management unit means a piece of equipment, structure, or transport mechanism used in handling, storage, treatment, or disposal of waste. Examples of a waste management unit include a tank, surface impoundment, container, oil-water separator, individual drain system, steam stripping unit, thin-film evaporation unit, waste incinerator, and landfill.

Waste stream means the waste generated by a particular process unit, product tank, or waste management unit. The characteristics of the waste stream (e.g., flow rate, benzene concentration, water content) are determined at the point of waste generation. Examples of a waste stream include process wastewater, product tank drawdown, sludge and slop oil removed from waste management units, and landfill leachate.

Wastewater treatment system means any component, piece of equipment, or installation that receives, manages, or treats process wastewater, product tank drawdown, or landfill leachate prior to direct or indirect discharge in accordance with the National Pollutant Discharge Elimination System permit regulations under 40 CFR part 122. These systems typically include individual drain systems, oil-water separators, air flotation units, equalization tanks, and biological treatment units.

Water seal controls means a seal pot, p-leg trap, or other type of trap filled with water (e.g., flooded sewers that maintain water levels adequate to prevent air flow through the system) that creates a water barrier between the sewer line and the atmosphere. The water level of the seal must be maintained in the vertical leg of a drain in order to be considered a water seal.

[55 FR 8346, Mar. 7, 1990; 55 FR 12444, Apr. 3, 1990, as amended at 58 FR 3095, Jan. 7, 1993; 67 FR 68531, Nov. 12, 2002]

 [Back to Top](#)

§61.342 Standards: General.

(a) An owner or operator of a facility at which the total annual benzene quantity from facility waste is less than 10 megagrams per year (Mg/yr) (11 ton/yr) shall be exempt from the requirements of paragraphs (b) and (c) of this section. The total annual benzene quantity from facility waste is the sum of the annual benzene quantity for each waste stream at the facility that has a flow-weighted annual average water content greater than 10 percent or that is mixed with water, or other wastes, at any time and the mixture has an annual average water content greater than 10 percent. The benzene quantity in a waste stream is to be counted only once without multiple counting if other waste streams are mixed with or generated from the original waste stream. Other specific requirements for calculating the total annual benzene waste quantity are as follows:

(1) Wastes that are exempted from control under §§61.342(c)(2) and 61.342(c)(3) are included in the calculation of the total annual benzene quantity if they have an annual average water content greater than 10 percent, or if they are mixed with water or other wastes at any time and the mixture has an annual average water content greater than 10 percent.

(2) The benzene in a material subject to this subpart that is sold is included in the calculation of the total annual benzene quantity if the material has an annual average water content greater than 10 percent.

(3) Benzene in wastes generated by remediation activities conducted at the facility, such as the excavation of contaminated soil, pumping and treatment of groundwater, and the recovery of product from soil or groundwater, are not included in the calculation of total annual benzene quantity for that facility. If the facility's total annual benzene quantity is 10 Mg/yr (11 ton/yr) or more, wastes generated by remediation activities are subject to the requirements of paragraphs (c) through (h) of this section. If the facility is managing remediation waste generated offsite, the benzene in this waste shall be included in the calculation of total annual benzene quantity in facility waste, if the waste streams have an annual average water content greater than 10 percent, or if they are mixed with water or other wastes at any time and the mixture has an annual average water content greater than 10 percent.

(4) The total annual benzene quantity is determined based upon the quantity of benzene in the waste before any waste treatment occurs to remove the benzene except as specified in §61.355(c)(1)(i) (A) through (C).

(b) Each owner or operator of a facility at which the total annual benzene quantity from facility waste is equal to or greater than 10 Mg/yr (11 ton/yr) as determined in paragraph (a) of this section shall be in compliance with the requirements of paragraphs (c) through (h) of this section no later than 90 days following the effective date, unless a waiver of compliance has been obtained under §61.11, or by the initial startup for a new source with an initial startup after the effective date.

(1) The owner or operator of an existing source unable to comply with the rule within the required time may request a waiver of compliance under §61.10.

(2) As part of the waiver application, the owner or operator shall submit to the Administrator a plan under §61.10(b)(3) that is an enforceable commitment to obtain environmental benefits to mitigate the benzene emissions that result from extending the compliance date. The plan shall include the following information:

(i) A description of the method of compliance, including the control approach, schedule for installing controls, and quantity of the benzene emissions that result from extending the compliance date;

(ii) If the control approach involves a compliance strategy designed to obtain integrated compliance with multiple regulatory requirements, a description of the other regulations involved and their effective dates; and

(iii) A description of the actions to be taken at the facility to obtain mitigating environmental benefits, including how the benefits will be obtained, the schedule for these actions, and an estimate of the quantifiable benefits that directly result from these actions.

(c) Each owner or operator of a facility at which the total annual benzene quantity from facility waste is equal to or greater than 10 Mg/yr (11 ton/yr) as determined in paragraph (a) of this section shall manage and treat the facility waste as follows:

(1) For each waste stream that contains benzene, including (but not limited to) organic waste streams that contain less than 10 percent water and aqueous waste streams, even if the wastes are not discharged to an individual drain system, the owner or operator shall:

(i) Remove or destroy the benzene contained in the waste using a treatment process or wastewater treatment system that complies with the standards specified in §61.348 of this subpart.

(ii) Comply with the standards specified in §§61.343 through 61.347 of this subpart for each waste management unit that receives or manages the waste stream prior to and during treatment of the waste stream in accordance with paragraph (c)(1)(i) of this section.

(iii) Each waste management unit used to manage or treat waste streams that will be recycled to a process shall comply with the standards specified in §§61.343 through 61.347. Once the waste stream is recycled to a process, including to a tank used for the storage of production process feed, product, or product intermediates, unless this tank is used primarily for the storage of wastes, the material is no longer subject to paragraph (c) of this section.

(2) A waste stream is exempt from paragraph (c)(1) of this section provided that the owner or operator demonstrates initially and, thereafter, at least once per year that the flow-weighted annual average benzene concentration for the waste stream is less than 10 ppmw as determined by the procedures specified in §61.355(c)(2) or §61.355(c)(3).

(3) A waste stream is exempt from paragraph (c)(1) of this section provided that the owner or operator demonstrates initially and, thereafter, at least once per year that the conditions specified in either paragraph (c)(3)(i) or (c)(3)(ii) of this section are met.

(i) The waste stream is process wastewater that has a flow rate less than 0.02 liters per minute (0.005 gallons per minute) or an annual wastewater quantity of less than 10 Mg/yr (11 ton/yr); or

(ii) All of the following conditions are met:

(A) The owner or operator does not choose to exempt process wastewater under paragraph (c)(3)(i) of this section,

(B) The total annual benzene quantity in all waste streams chosen for exemption in paragraph (c)(3)(ii) of this section does not exceed 2.0 Mg/yr (2.2 ton/yr) as determined in the procedures in §61.355(j), and

(C) The total annual benzene quantity in a waste stream chosen for exemption, including process unit turnaround waste, is determined for the year in which the waste is generated.

(d) As an alternative to the requirements specified in paragraphs (c) and (e) of this section, an owner or operator of a facility at which the total annual benzene quantity from facility waste is equal to or greater than 10 Mg/yr (11 ton/yr) as determined in paragraph (a) of this section may elect to manage and treat the facility waste as follows:

(1) The owner or operator shall manage and treat facility waste other than process wastewater in accordance with the requirements of paragraph (c)(1) of this section.

(2) The owner or operator shall manage and treat process wastewater in accordance with the following requirements:

(i) Process wastewater shall be treated to achieve a total annual benzene quantity from facility process wastewater less than 1 Mg/yr (1.1 ton/yr). Total annual benzene from facility process wastewater shall be determined by adding together the annual benzene quantity at the point of waste generation for each untreated process wastewater stream plus the annual benzene quantity exiting the treatment process for each process wastewater stream treated in accordance with the requirements of paragraph (c)(1)(i) of this section.

(ii) Each treated process wastewater stream identified in paragraph (d)(2)(i) of this section shall be managed and treated in accordance with paragraph (c)(1) of this section.

(iii) Each untreated process wastewater stream identified in paragraph (d)(2)(i) of this section is exempt from the requirements of paragraph (c)(1) of this section.

(e) As an alternative to the requirements specified in paragraphs (c) and (d) of this section, an owner or operator of a facility at which the total annual benzene quantity from facility waste is equal to or greater than 10 Mg/yr (11 ton/yr) as determined in paragraph (a) of this section may elect to manage and treat the facility waste as follows:

(1) The owner or operator shall manage and treat facility waste with a flow-weighted annual average water content of less than 10 percent in accordance with the requirements of paragraph (c)(1) of this section; and

(2) The owner or operator shall manage and treat facility waste (including remediation and process unit turnaround waste) with a flow-weighted annual average water content of 10 percent or greater, on a volume basis as total water, and each waste stream that is mixed with water or wastes at any time such that the resulting mixture has an annual water content greater than 10 percent, in accordance with the following:

(i) The benzene quantity for the wastes described in paragraph (e)(2) of this section must be equal to or less than 6.0 Mg/yr (6.6 ton/yr), as determined in §61.355(k). Wastes as described in paragraph (e)(2) of this section that are transferred offsite shall be included in the determination of benzene quantity as provided in §61.355(k). The provisions of paragraph (f) of this section shall not apply to any owner or operator who elects to comply with the provisions of paragraph (e) of this section.

(ii) The determination of benzene quantity for each waste stream defined in paragraph (e)(2) of this section shall be made in accordance with §61.355(k).

(f) Rather than treating the waste onsite, an owner or operator may elect to comply with paragraph (c)(1)(i) of this section by transferring the waste offsite to another facility where the waste is treated in accordance with the requirements of paragraph (c)(1)(i) of this section. The owner or operator transferring the waste shall:

(1) Comply with the standards specified in §§61.343 through 61.347 of this subpart for each waste management unit that receives or manages the waste prior to shipment of the waste offsite.

(2) Include with each offsite waste shipment a notice stating that the waste contains benzene which is required to be managed and treated in accordance with the provisions of this subpart.

(g) Compliance with this subpart will be determined by review of facility records and results from tests and inspections using methods and procedures specified in §61.355 of this subpart.

(h) Permission to use an alternative means of compliance to meet the requirements of §§61.342 through 61.352 of this subpart may be granted by the Administrator as provided in §61.353 of this subpart.

[55 FR 8346, Mar. 7, 1990, as amended at 58 FR 3095, Jan. 7, 1993; 65 FR 62159, 62160, Oct. 17, 2000]

 [Back to Top](#)

§61.343 Standards: Tanks.

(a) Except as provided in paragraph (b) of this section and in §61.351, the owner or operator must meet the standards in paragraph (a)(1) or (2) of this section for each tank in which the waste stream is placed in accordance with §61.342 (c)(1)(ii). The standards in this section apply to the treatment and storage of the waste stream in a tank, including dewatering.

(1) The owner or operator shall install, operate, and maintain a fixed-roof and closed-vent system that routes all organic vapors vented from the tank to a control device.

(i) The fixed-roof shall meet the following requirements:

(A) The cover and all openings (e.g., access hatches, sampling ports, and gauge wells) shall be designed to operate with no detectable emissions as indicated by an instrument reading of less than 500 ppmv above background, as determined initially and thereafter at least once per year by the methods specified in §61.355(h) of this subpart.

(B) Each opening shall be maintained in a closed, sealed position (e.g., covered by a lid that is gasketed and latched) at all times that waste is in the tank except when it is necessary to use the opening for waste sampling or removal, or for equipment inspection, maintenance, or repair.

(C) If the cover and closed-vent system operate such that the tank is maintained at a pressure less than atmospheric pressure, then paragraph (a)(1)(i)(B) of this section does not apply to any opening that meets all of the following conditions:

(1) The purpose of the opening is to provide dilution air to reduce the explosion hazard;

(2) The opening is designed to operate with no detectable emissions as indicated by an instrument reading of less than 500 ppmv above background, as determined initially and thereafter at least once per year by the methods specified in §61.355(h); and

(3) The pressure is monitored continuously to ensure that the pressure in the tank remains below atmospheric pressure.

(ii) The closed-vent system and control device shall be designed and operated in accordance with the requirements of §61.349 of this subpart.

(2) The owner or operator must install, operate, and maintain an enclosure and closed-vent system that routes all organic vapors vented from the tank, located inside the enclosure, to a control device in accordance with the requirements specified in paragraph (e) of this section.

(b) For a tank that meets all the conditions specified in paragraph (b)(1) of this section, the owner or operator may elect to comply with paragraph (b)(2) of this section as an alternative to the requirements specified in paragraph (a)(1) of this section.

(1) The waste managed in the tank complying with paragraph (b)(2) of this section shall meet all of the following conditions:

(i) Each waste stream managed in the tank must have a flow-weighted annual average water content less than or equal to 10 percent water, on a volume basis as total water.

(ii) The waste managed in the tank either:

(A) Has a maximum organic vapor pressure less than 5.2 kilopascals (kPa) (0.75 pounds per square inch (psi));

(B) Has a maximum organic vapor pressure less than 27.6 kPa (4.0 psi) and is managed in a tank having design capacity less than 151 m³ (40,000 gal); or

(C) Has a maximum organic vapor pressure less than 76.6 kPa (11.1 psi) and is managed in a tank having a design capacity less than 75 m³ (20,000 gal).

(2) The owner or operator shall install, operate, and maintain a fixed roof as specified in paragraph (a)(1)(i).

(3) For each tank complying with paragraph (b) of this section, one or more devices which vent directly to the atmosphere may be used on the tank provided each device remains in a closed, sealed position during normal operations except when the device needs to open to prevent physical damage or permanent deformation of the tank or cover resulting from filling or emptying the tank, diurnal temperature changes, atmospheric pressure changes or malfunction of the unit in accordance with good engineering and safety practices for handling flammable, explosive, or other hazardous materials.

(c) Each fixed-roof, seal, access door, and all other openings shall be checked by visual inspection initially and quarterly thereafter to ensure that no cracks or gaps occur and that access doors and other openings are closed and gasketed properly.

(d) Except as provided in §61.350 of this subpart, when a broken seal or gasket or other problem is identified, or when detectable emissions are measured, first efforts at repair shall be made as soon as practicable, but not later than 45 calendar days after identification.

(e) Each owner or operator who controls air pollutant emissions by using an enclosure vented through a closed-vent system to a control device must meet the requirements specified in paragraphs (e)(1) through (4) of this section.

(1) The tank must be located inside a total enclosure. The enclosure must be designed and operated in accordance with the criteria for a permanent total enclosure as specified in "Procedure T—Criteria for and Verification of a Permanent or Temporary Total Enclosure" in 40 CFR 52.741, appendix B. The enclosure may have permanent or temporary openings to allow worker access; passage of material into or out of the enclosure by conveyor, vehicles, or other mechanical means; entry of permanent mechanical or electrical equipment; or direct airflow into the enclosure. The owner or operator must perform the verification procedure for the enclosure as specified in section 5.0 of Procedure T initially when the enclosure is first installed and, thereafter, annually. A facility that has conducted an initial compliance demonstration and that performs annual compliance demonstrations in accordance with the requirements for Tank Level 2 control requirements 40 CFR 264.1084(i) or 40 CFR 265(i) is not required to make repeat demonstrations of initial and continuous compliance for the purposes of this subpart.

(2) The enclosure must be vented through a closed-vent system to a control device that is designed and operated in accordance with the standards for control devices specified in §61.349.

(3) Safety devices, as defined in this subpart, may be installed and operated as necessary on any enclosure, closed-vent system, or control device used to comply with the requirements of paragraphs (e)(1) and (2) of this section.

(4) The closed-vent system must be designed and operated in accordance with the requirements of §61.349.

[55 FR 8346, Mar. 7, 1990, as amended at 55 FR 18331, May 2, 1990; 58 FR 3096, Jan. 7, 1993; 67 FR 68532, Nov. 12, 2002; 68 FR 6082, Feb. 6, 2003; 68 FR 67935, Dec. 4, 2003]

 [Back to Top](#)

§61.344 Standards: Surface impoundments.

(a) The owner or operator shall meet the following standards for each surface impoundment in which waste is placed in accordance with §61.342(c)(1)(ii) of this subpart:

(1) The owner or operator shall install, operate, and maintain on each surface impoundment a cover (e.g., air-supported structure or rigid cover) and closed-vent system that routes all organic vapors vented from the surface impoundment to a control device.

(i) The cover shall meet the following requirements:

(A) The cover and all openings (e.g., access hatches, sampling ports, and gauge wells) shall be designed to operate with no detectable emissions as indicated by an instrument reading of less than 500 ppmv above background, initially and thereafter at least once per year by the methods specified in §61.355(h) of this subpart.

(B) Each opening shall be maintained in a closed, sealed position (e.g., covered by a lid that is gasketed and latched) at all times that waste is in the surface impoundment except when it is necessary to use the opening for waste sampling or removal, or for equipment inspection, maintenance, or repair.

(C) If the cover and closed-vent system operate such that the enclosure of the surface impoundment is maintained at a pressure less than atmospheric pressure, then paragraph (a)(1)(i)(B) of this section does not apply to any opening that meets all of the following conditions:

(1) The purpose of the opening is to provide dilution air to reduce the explosion hazard;

(2) The opening is designed to operate with no detectable emissions as indicated by an instrument reading of less than 500 ppmv above background, as determined initially and thereafter at least once per year by the methods specified in §61.355(h) of this subpart; and

(3) The pressure is monitored continuously to ensure that the pressure in the enclosure of the surface impoundment remains below atmospheric pressure.

(D) The cover shall be used at all times that waste is placed in the surface impoundment except during removal of treatment residuals in accordance with 40 CFR 268.4 or closure of the surface impoundment in accordance with 40 CFR 264.228. (Note: the treatment residuals generated by these activities may be subject to the requirements of this part.)

(ii) The closed-vent system and control device shall be designed and operated in accordance with §61.349 of this subpart.

(b) Each cover seal, access hatch, and all other openings shall be checked by visual inspection initially and quarterly thereafter to ensure that no cracks or gaps occur and that access hatches and other openings are closed and gasketed properly.

(c) Except as provided in §61.350 of this subpart, when a broken seal or gasket or other problem is identified, or when detectable emissions are measured, first efforts at repair shall be made as soon as practicable, but not later than 15 calendar days after identification.

[55 FR 8346, Mar. 7, 1990, as amended at 58 FR 3097, Jan. 7, 1993]

 [Back to Top](#)

§61.345 Standards: Containers.

(a) The owner or operator shall meet the following standards for each container in which waste is placed in accordance with §61.342(c)(1)(ii) of this subpart:

(1) The owner or operator shall install, operate, and maintain a cover on each container used to handle, transfer, or store waste in accordance with the following requirements:

(i) The cover and all openings (e.g., bungs, hatches, and sampling ports) shall be designed to operate with no detectable emissions as indicated by an instrument reading of less than 500 ppmv above background, initially and thereafter at least once per year by the methods specified in §61.355(h) of this subpart.

(ii) Except as provided in paragraph (a)(4) of this section, each opening shall be maintained in a closed, sealed position (e.g., covered by a lid that is gasketed and latched) at all times that waste is in the container except when it is necessary to use the opening for waste loading, removal, inspection, or sampling.

(2) When a waste is transferred into a container by pumping, the owner or operator shall perform the transfer using a submerged fill pipe. The submerged fill pipe outlet shall extend to within two fill pipe diameters of the bottom of the container while the container is being loaded. During loading of the waste, the cover shall remain in place and all openings shall be maintained in a closed, sealed position except for those openings required for the submerged fill pipe, those openings required for venting of the container to prevent physical damage or permanent deformation of the container or cover, and any openings complying with paragraph (a)(4) of this section.

(3) Treatment of a waste in a container, including aeration, thermal or other treatment, must be performed by the owner or operator in a manner such that while the waste is being treated the container meets the standards specified in paragraphs (a)(3)(i) through (iii) of this section, except for covers and closed-vent systems that meet the requirements in paragraph (a)(4) of this section.

(i) The owner or operator must either:

(A) Vent the container inside a total enclosure which is exhausted through a closed-vent system to a control device in accordance with the requirements of paragraphs (a)(3)(ii)(A) and (B) of this section; or

(B) Vent the covered or closed container directly through a closed-vent system to a control device in accordance with the requirements of paragraphs (a)(3)(ii)(B) and (C) of this section.

(ii) The owner or operator must meet the following requirements, as applicable to the type of air emission control equipment selected by the owner or operator:

(A) The total enclosure must be designed and operated in accordance with the criteria for a permanent total enclosure as specified in section 5 of the "Procedure T—Criteria for and Verification of a Permanent or Temporary Total Enclosure" in 40 CFR 52.741, appendix B. The enclosure may have permanent or temporary openings to allow worker access; passage of containers through the enclosure by conveyor or other mechanical means; entry of permanent mechanical or electrical equipment; or direct airflow into the enclosure. The owner or operator must perform the verification procedure for the enclosure as specified in section 5.0 of "Procedure T—Criteria for and Verification of a Permanent or Temporary Total Enclosure" initially when the enclosure is first installed and, thereafter, annually. A facility that has conducted an initial compliance demonstration and that performs annual compliance demonstrations in accordance with the Container Level 3 control requirements in 40 CFR 264.1086(e)(2)(i) or 40 CFR 265.1086(e)(2)(i) is not required to make repeat demonstrations of initial and continuous compliance for the purposes of this subpart.

(B) The closed-vent system and control device must be designed and operated in accordance with the requirements of §61.349.

(C) For a container cover, the cover and all openings (e.g., doors, hatches) must be designed to operate with no detectable emissions as indicated by an instrument reading of less than 500 ppmv above background, initially and thereafter at least once per year by the methods specified in §61.355(h).

(iii) Safety devices, as defined in this subpart, may be installed and operated as necessary on any container, enclosure, closed-vent system, or control device used to comply with the requirements of paragraph (a)(3)(i) of this section.

(4) If the cover and closed-vent system operate such that the container is maintained at a pressure less than atmospheric pressure, the owner or operator may operate the system with an opening that is not sealed and kept closed at all times if the following conditions are met:

(i) The purpose of the opening is to provide dilution air to reduce the explosion hazard;

(ii) The opening is designed to operate with no detectable emissions as indicated by an instrument reading of less than 500 ppmv above background, as determined initially and thereafter at least once per year by methods specified in §61.355(h); and

(iii) The pressure is monitored continuously to ensure that the pressure in the container remains below atmospheric pressure.

(b) Each cover and all openings shall be visually inspected initially and quarterly thereafter to ensure that they are closed and gasketed properly.

(c) Except as provided in §61.350 of this subpart, when a broken seal or gasket or other problem is identified, first efforts at repair shall be made as soon as practicable, but not later than 15 calendar days after identification.

[55 FR 8346, Mar. 7, 1990, as amended at 58 FR 3097, Jan. 7, 1993; 67 FR 68532, Nov. 12, 2002; 68 FR 67936, Dec. 4, 2003]

[↑ Back to Top](#)

§61.346 Standards: Individual drain systems.

(a) Except as provided in paragraph (b) of this section, the owner or operator shall meet the following standards for each individual drain system in which waste is placed in accordance with §61.342(c)(1)(ii) of this subpart:

(1) The owner or operator shall install, operate, and maintain on each drain system opening a cover and closed-vent system that routes all organic vapors vented from the drain system to a control device.

(i) The cover shall meet the following requirements:

(A) The cover and all openings (e.g., access hatches, sampling ports) shall be designed to operate with no detectable emissions as indicated by an instrument reading of less than 500 ppmv above background, initially and thereafter at least once per year by the methods specified in §61.355(h) of this subpart.

(B) Each opening shall be maintained in a closed, sealed position (e.g., covered by a lid that is gasketed and latched) at all times that waste is in the drain system except when it is necessary to use the opening for waste sampling or removal, or for equipment inspection, maintenance, or repair.

(C) If the cover and closed-vent system operate such that the individual drain system is maintained at a pressure less than atmospheric pressure, then paragraph (a)(1)(i)(B) of this section does not apply to any opening that meets all of the following conditions:

(1) The purpose of the opening is to provide dilution air to reduce the explosion hazard;

(2) The opening is designed to operate with no detectable emissions as indicated by an instrument reading of less than 500 ppmv above background, as determined initially and thereafter at least once per year by the methods specified in §61.355(h); and

(3) The pressure is monitored continuously to ensure that the pressure in the individual drain system remains below atmospheric pressure.

(ii) The closed-vent system and control device shall be designed and operated in accordance with §61.349 of this subpart.

(2) Each cover seal, access hatch, and all other openings shall be checked by visual inspection initially and quarterly thereafter to ensure that no cracks or gaps occur and that access hatches and other openings are closed and gasketed properly.

(3) Except as provided in §61.350 of this subpart, when a broken seal or gasket or other problem is identified, or when detectable emissions are measured, first efforts at repair shall be made as soon as practicable, but not later than 15 calendar days after identification.

(b) As an alternative to complying with paragraph (a) of this section, an owner or operator may elect to comply with the following requirements:

(1) Each drain shall be equipped with water seal controls or a tightly sealed cap or plug.

(2) Each junction box shall be equipped with a cover and may have a vent pipe. The vent pipe shall be at least 90 cm (3 ft) in length and shall not exceed 10.2 cm (4 in) in diameter.

(i) Junction box covers shall have a tight seal around the edge and shall be kept in place at all times, except during inspection and maintenance.

(ii) One of the following methods shall be used to control emissions from the junction box vent pipe to the atmosphere:

(A) Equip the junction box with a system to prevent the flow of organic vapors from the junction box vent pipe to the atmosphere during normal operation. An example of such a system includes use of water seal controls on the junction box. A flow indicator shall be installed, operated, and maintained on each junction box vent pipe to ensure that organic vapors are not vented from the junction box to the atmosphere during normal operation.

(B) Connect the junction box vent pipe to a closed-vent system and control device in accordance with §61.349 of this subpart.

(3) Each sewer line shall not be open to the atmosphere and shall be covered or enclosed in a manner so as to have no visual gaps or cracks in joints, seals, or other emission interfaces.

(4) Equipment installed in accordance with paragraphs (b)(1), (b)(2), or (b)(3) of this section shall be inspected as follows:

(i) Each drain using water seal controls shall be checked by visual or physical inspection initially and thereafter quarterly for indications of low water levels or other conditions that would reduce the effectiveness of water seal controls.

(ii) Each drain using a tightly sealed cap or plug shall be visually inspected initially and thereafter quarterly to ensure caps or plugs are in place and properly installed.

(iii) Each junction box shall be visually inspected initially and thereafter quarterly to ensure that the cover is in place and to ensure that the cover has a tight seal around the edge.

(iv) The unburied portion of each sewer line shall be visually inspected initially and thereafter quarterly for indication of cracks, gaps, or other problems that could result in benzene emissions.

(5) Except as provided in §61.350 of this subpart, when a broken seal, gap, crack or other problem is identified, first efforts at repair shall be made as soon as practicable, but not later than 15 calendar days after identification.

[55 FR 8346, Mar. 7, 1990, as amended at 55 FR 37231, Sept. 10, 1990; 58 FR 3097, Jan. 7, 1993]

 [Back to Top](#)

§61.347 Standards: Oil-water separators.

(a) Except as provided in §61.352 of this subpart, the owner or operator shall meet the following standards for each oil-water separator in which waste is placed in accordance with §61.342(c)(1)(ii) of this subpart:

(1) The owner or operator shall install, operate, and maintain a fixed-roof and closed-vent system that routes all organic vapors vented from the oil-water separator to a control device.

(i) The fixed-roof shall meet the following requirements:

(A) The cover and all openings (e.g., access hatches, sampling ports, and gauge wells) shall be designed to operate with no detectable emissions as indicated by an instrument reading of less than 500 ppmv above background, as determined initially and thereafter at least once per year by the methods specified in §61.355(h) of this subpart.

(B) Each opening shall be maintained in a closed, sealed position (e.g., covered by a lid that is gasketed and latched) at all times that waste is in the oil-water separator except when it is necessary to use the opening for waste sampling or removal, or for equipment inspection, maintenance, or repair.

(C) If the cover and closed-vent system operate such that the oil-water separator is maintained at a pressure less than atmospheric pressure, then paragraph (a)(1)(i)(B) of this section does not apply to any opening that meets all of the following conditions:

(1) The purpose of the opening is to provide dilution air to reduce the explosion hazard;

(2) The opening is designed to operate with no detectable emissions as indicated by an instrument reading of less than 500 ppmv above background, as determined initially and thereafter at least once per year by the methods specified in §61.355(h); and

(3) The pressure is monitored continuously to ensure that the pressure in the oil-water separator remains below atmospheric pressure.

(ii) The closed-vent system and control device shall be designed and operated in accordance with the requirements of §61.349 of this subpart.

(b) Each cover seal, access hatch, and all other openings shall be checked by visual inspection initially and quarterly thereafter to ensure that no cracks or gaps occur between the cover and oil-water separator wall and that access hatches and other openings are closed and gasketed properly.

(c) Except as provided in §61.350 of this subpart, when a broken seal or gasket or other problem is identified, or when detectable emissions are measured, first efforts at repair shall be made as soon as practicable, but not later than 15 calendar days after identification.

[55 FR 8346, Mar. 7, 1990, as amended at 58 FR 3098, Jan. 7, 1993]

 [Back to Top](#)

§61.348 Standards: Treatment processes.

(a) Except as provided in paragraph (a)(5) of this section, the owner or operator shall treat the waste stream in accordance with the following requirements:

(1) The owner or operator shall design, install, operate, and maintain a treatment process that either:

(i) Removes benzene from the waste stream to a level less than 10 parts per million by weight (ppmw) on a flow-weighted annual average basis,

(ii) Removes benzene from the waste stream by 99 percent or more on a mass basis, or

(iii) Destroys benzene in the waste stream by incinerating the waste in a combustion unit that achieves a destruction efficiency of 99 percent or greater for benzene.

(2) Each treatment process complying with paragraphs (a)(1)(i) or (a)(1)(ii) of this section shall be designed and operated in accordance with the appropriate waste management unit standards specified in §§61.343 through 61.347 of this subpart. For example, if a treatment process is a tank, then the owner or operator shall comply with §61.343 of this subpart.

(3) For the purpose of complying with the requirements specified in paragraph (a)(1)(i) of this section, the intentional or unintentional reduction in the benzene concentration of a waste stream by dilution of the waste stream with other wastes or materials is not allowed.

(4) An owner or operator may aggregate or mix together individual waste streams to create a combined waste stream for the purpose of facilitating treatment of waste to comply with the requirements of paragraph (a)(1) of this section except as provided in paragraph (a)(5) of this section.

(5) If an owner or operator aggregates or mixes any combination of process wastewater, product tank drawdown, or landfill leachate subject to §61.342(c)(1) of this subpart together with other waste streams to create a combined waste stream for the purpose of facilitating management or treatment of waste in a wastewater treatment system, then the wastewater treatment system shall be operated in accordance with paragraph (b) of this section. These provisions apply to above-ground wastewater treatment systems as well as those that are at or below ground level.

(b) Except for facilities complying with §61.342(e), the owner or operator that aggregates or mixes individual waste streams as defined in paragraph (a)(5) of this section for management and treatment in a wastewater treatment system shall comply with the following requirements:

(1) The owner or operator shall design and operate each waste management unit that comprises the wastewater treatment system in accordance with the appropriate standards specified in §§61.343 through 61.347 of this subpart.

(2) The provisions of paragraph (b)(1) of this section do not apply to any waste management unit that the owner or operator demonstrates to meet the following conditions initially and, thereafter, at least once per year:

(i) The benzene content of each waste stream entering the waste management unit is less than 10 ppmw on a flow-weighted annual average basis as determined by the procedures specified in §61.355(c) of this subpart; and

(ii) The total annual benzene quantity contained in all waste streams managed or treated in exempt waste management units comprising the facility wastewater treatment systems is less than 1 Mg/yr (1.1 ton/yr). For this determination, total annual benzene quantity shall be calculated as follows:

(A) The total annual benzene quantity shall be calculated as the sum of the individual benzene quantities determined at each location where a waste stream first enters an exempt waste management unit. The benzene quantity discharged from an exempt waste management unit shall not be included in this calculation.

(B) The annual benzene quantity in a waste stream managed or treated in an enhanced biodegradation unit shall not be included in the calculation of the total annual benzene quantity, if the enhanced biodegradation unit is the first exempt unit in which the waste is managed or treated. A unit shall be considered enhanced biodegradation if it is a suspended-growth process that generates biomass, uses recycled biomass, and periodically removes biomass from the process. An enhanced biodegradation unit typically operates at a food-to-microorganism ratio in the range of 0.05 to 1.0 kg of biological oxygen demand per kg of biomass per day, a mixed liquor suspended solids ratio in the range of 1 to 8 grams per liter (0.008 to 0.7 pounds per liter), and a residence time in the range of 3 to 36 hours.

(c) The owner and operator shall demonstrate that each treatment process or wastewater treatment system unit, except as provided in paragraph (d) of this section, achieves the appropriate conditions specified in paragraphs (a) or (b) of this section in accordance with the following requirements:

(1) Engineering calculations in accordance with requirements specified in §61.356(e) of this subpart;
or

(2) Performance tests conducted using the test methods and procedures that meet the requirements specified in §61.355 of this subpart.

(d) A treatment process or waste stream is in compliance with the requirements of this subpart and exempt from the requirements of paragraph (c) of this section provided that the owner or operator

documents that the treatment process or waste stream is in compliance with other regulatory requirements as follows:

(1) The treatment process is a hazardous waste incinerator for which the owner or operator has been issued a final permit under 40 CFR part 270 and complies with the requirements of 40 CFR part 264, subpart O;

(2) The treatment process is an industrial furnace or boiler burning hazardous waste for energy recovery for which the owner or operator has been issued a final permit under 40 CFR part 270 and complies with the requirements of 40 CFR part 266, subpart D;

(3) The waste stream is treated by a means or to a level that meets benzene-specific treatment standards in accordance with the Land Disposal Restrictions under 40 CFR part 268, and the treatment process is designed and operated with a closed-vent system and control device meeting the requirements of §61.349 of this subpart;

(4) The waste stream is treated by a means or to a level that meets benzene-specific effluent limitations or performance standards in accordance with the Effluent Guidelines and Standards under 40 CFR parts 401-464, and the treatment process is designed and operated with a closed-vent system and control device meeting the requirements of §61.349 of this subpart; or

(5) The waste stream is discharged to an underground injection well for which the owner or operator has been issued a final permit under 40 CFR part 270 and complies with the requirements of 40 CFR part 122.

(e) Except as specified in paragraph (e)(3) of this section, if the treatment process or wastewater treatment system unit has any openings (e.g., access doors, hatches, etc.), all such openings shall be sealed (e.g., gasketed, latched, etc.) and kept closed at all times when waste is being treated, except during inspection and maintenance.

(1) Each seal, access door, and all other openings shall be checked by visual inspections initially and quarterly thereafter to ensure that no cracks or gaps occur and that openings are closed and gasketed properly.

(2) Except as provided in §61.350 of this subpart, when a broken seal or gasket or other problem is identified, first efforts at repair shall be made as soon as practicable, but not later than 15 calendar days after identification.

(3) If the cover and closed-vent system operate such that the treatment process and wastewater treatment system unit are maintained at a pressure less than atmospheric pressure, the owner or operator may operate the system with an opening that is not sealed and kept closed at all times if the following conditions are met:

(i) The purpose of the opening is to provide dilution air to reduce the explosion hazard;

(ii) The opening is designed to operate with no detectable emissions as indicated by an instrument reading of less than 500 ppmv above background, as determined initially and thereafter at least once per year by the methods specified in §61.355(h); and

(iii) The pressure is monitored continuously to ensure that the pressure in the treatment process and wastewater treatment system unit remain below atmospheric pressure.

(f) Except for treatment processes complying with paragraph (d) of this section, the Administrator may request at any time an owner or operator demonstrate that a treatment process or wastewater treatment system unit meets the applicable requirements specified in paragraphs (a) or (b) of this section by conducting a performance test using the test methods and procedures as required in §61.355 of this subpart.

(g) The owner or operator of a treatment process or wastewater treatment system unit that is used to comply with the provisions of this section shall monitor the unit in accordance with the applicable requirements in §61.354 of this subpart.

[55 FR 8346, Mar. 7, 1990, as amended at 55 FR 37231, Sept. 10, 1990; 58 FR 3098, Jan. 7, 1993; 65 FR 62160, Oct. 17, 2000]

 [Back to Top](#)

§61.349 Standards: Closed-vent systems and control devices.

(a) For each closed-vent system and control device used to comply with standards in accordance with §§61.343 through 61.348 of this subpart, the owner or operator shall properly design, install, operate, and maintain the closed-vent system and control device in accordance with the following requirements:

(1) The closed-vent system shall:

(i) Be designed to operate with no detectable emissions as indicated by an instrument reading of less than 500 ppmv above background, as determined initially and thereafter at least once per year by the methods specified in §61.355(h) of this subpart.

(ii) Vent systems that contain any bypass line that could divert the vent stream away from a control device used to comply with the provisions of this subpart shall install, maintain, and operate according to the manufacturer's specifications a flow indicator that provides a record of vent stream flow away from the control device at least once every 15 minutes, except as provided in paragraph (a)(1)(ii)(B) of this section.

(A) The flow indicator shall be installed at the entrance to any bypass line that could divert the vent stream away from the control device to the atmosphere.

(B) Where the bypass line valve is secured in the closed position with a car-seal or a lock-and-key type configuration, a flow indicator is not required.

(iii) All gauging and sampling devices shall be gas-tight except when gauging or sampling is taking place.

(iv) For each closed-vent system complying with paragraph (a) of this section, one or more devices which vent directly to the atmosphere may be used on the closed-vent system provided each device remains in a closed, sealed position during normal operations except when the device needs to open to prevent physical damage or permanent deformation of the closed-vent system resulting from malfunction of the unit in accordance with good engineering and safety practices for handling flammable, explosive, or other hazardous materials.

(2) The control device shall be designed and operated in accordance with the following conditions:

(i) An enclosed combustion device (e.g., a vapor incinerator, boiler, or process heater) shall meet one of the following conditions:

(A) Reduce the organic emissions vented to it by 95 weight percent or greater;

(B) Achieve a total organic compound concentration of 20 ppmv (as the sum of the concentrations for individual compounds using Method 18) on a dry basis corrected to 3 percent oxygen; or

(C) Provide a minimum residence time of 0.5 seconds at a minimum temperature of 760 °C (1,400 °F). If a boiler or process heater issued as the control device, then the vent stream shall be introduced into the flame zone of the boiler or process heater.

(ii) A vapor recovery system (e.g., a carbon adsorption system or a condenser) shall recover or control the organic emissions vented to it with an efficiency of 95 weight percent or greater, or shall recover or control the benzene emissions vented to it with an efficiency of 98 weight percent or greater.

(iii) A flare shall comply with the requirements of 40 CFR 60.18.

(iv) A control device other than those described in paragraphs (a)(2) (i) through (iii) of this section may be used provided that the following conditions are met:

(A) The device shall recover or control the organic emissions vented to it with an efficiency of 95 weight percent or greater, or shall recover or control the benzene emissions vented to it with an efficiency of 98 weight percent or greater.

(B) The owner or operator shall develop test data and design information that documents the control device will achieve an emission control efficiency of either 95 percent or greater for organic compounds or 98 percent or greater for benzene.

(C) The owner or operator shall identify:

(1) The critical operating parameters that affect the emission control performance of the device;

(2) The range of values of these operating parameters that ensure the emission control efficiency specified in paragraph (a)(2)(iv)(A) of this section is maintained during operation of the device; and

(3) How these operating parameters will be monitored to ensure the proper operation and maintenance of the device.

(D) The owner or operator shall submit the information and data specified in paragraphs (a)(2)(iv) (B) and (C) of this section to the Administrator prior to operation of the alternative control device.

(E) The Administrator will determine, based on the information submitted under paragraph (a)(2)(iv)(D) of this section, if the control device subject to paragraph (a)(2)(iv) of this section meets the requirements of §61.349. The control device subject to paragraph (a)(2)(iv) of this section may be operated prior to receiving approval from the Administrator. However, if the Administrator determines that the control device does not meet the requirements of §61.349, the facility may be subject to enforcement action beginning from the time the control device began operation.

(b) Each closed-vent system and control device used to comply with this subpart shall be operated at all times when waste is placed in the waste management unit vented to the control device except when maintenance or repair of the waste management unit cannot be completed without a shutdown of the control device.

(c) An owner and operator shall demonstrate that each control device, except for a flare, achieves the appropriate conditions specified in paragraph (a)(2) of this section by using one of the following methods:

(1) Engineering calculations in accordance with requirements specified in §61.356(f) of this subpart;
or

(2) Performance tests conducted using the test methods and procedures that meet the requirements specified in §61.355 of this subpart.

(d) An owner or operator shall demonstrate compliance of each flare in accordance with paragraph (a)(2)(iii) of this section.

(e) The Administrator may request at any time an owner or operator demonstrate that a control device meets the applicable conditions specified in paragraph (a)(2) of this section by conducting a performance test using the test methods and procedures as required in §61.355, and for control devices subject to paragraph (a)(2)(iv) of this section, the Administrator may specify alternative test methods and procedures, as appropriate.

(f) Each closed-vent system and control device shall be visually inspected initially and quarterly thereafter. The visual inspection shall include inspection of ductwork and piping and connections to covers and control devices for evidence of visible defects such as holes in ductwork or piping and loose connections.

(g) Except as provided in §61.350 of this subpart, if visible defects are observed during an inspection, or if other problems are identified, or if detectable emissions are measured, a first effort to repair the closed-vent system and control device shall be made as soon as practicable but no later than 5 calendar days after detection. Repair shall be completed no later than 15 calendar days after the emissions are detected or the visible defect is observed.

(h) The owner or operator of a control device that is used to comply with the provisions of this section shall monitor the control device in accordance with §61.354(c) of this subpart.

[55 FR 8346, Mar. 7, 1990; 55 FR 12444, Apr. 3, 1990, as amended at 55 FR 37231, Sept. 10, 1990; 58 FR 3098, Jan. 7, 1993; 65 FR 62160, Oct. 17, 2000]

 [Back to Top](#)

§61.350 Standards: Delay of repair.

(a) Delay of repair of facilities or units that are subject to the provisions of this subpart will be allowed if the repair is technically impossible without a complete or partial facility or unit shutdown.

(b) Repair of such equipment shall occur before the end of the next facility or unit shutdown.

 [Back to Top](#)

§61.351 Alternative standards for tanks.

(a) As an alternative to the standards for tanks specified in §61.343 of this subpart, an owner or operator may elect to comply with one of the following:

- (1) A fixed roof and internal floating roof meeting the requirements in 40 CFR 60.112b(a)(1);
- (2) An external floating roof meeting the requirements of 40 CFR 60.112b (a)(2); or
- (3) An alternative means of emission limitation as described in 40 CFR 60.114b.

(b) If an owner or operator elects to comply with the provisions of this section, then the owner or operator is exempt from the provisions of §61.343 of this subpart applicable to the same facilities.

[55 FR 8346, Mar. 7, 1990, as amended at 55 FR 37231, Sept. 10, 1990]

[↑ Back to Top](#)

§61.352 Alternative standards for oil-water separators.

(a) As an alternative to the standards for oil-water separators specified in §61.347 of this subpart, an owner or operator may elect to comply with one of the following:

- (1) A floating roof meeting the requirements in 40 CFR 60.693-2(a); or
- (2) An alternative means of emission limitation as described in 40 CFR 60.694.

(b) For portions of the oil-water separator where it is infeasible to construct and operate a floating roof, such as over the weir mechanism, a fixed roof vented to a vapor control device that meets the requirements in §§61.347 and 61.349 of this subpart shall be installed and operated.

(c) Except as provided in paragraph (b) of this section, if an owner or operator elects to comply with the provisions of this section, then the owner or operator is exempt from the provisions in §61.347 of this subpart applicable to the same facilities.

[↑ Back to Top](#)

§61.353 Alternative means of emission limitation.

(a) If, in the Administrator's judgment, an alternative means of emission limitation will achieve a reduction in benzene emissions at least equivalent to the reduction in benzene emissions from the source achieved by the applicable design, equipment, work practice, or operational requirements in §§61.342 through 61.349, the Administrator will publish in the FEDERAL REGISTER a notice permitting the use of the alternative means for purposes of compliance with that requirement. The notice may condition the permission on requirements related to the operation and maintenance of the alternative means.

(b) Any notice under paragraph (a) of this section shall be published only after public notice and an opportunity for a hearing.

(c) Any person seeking permission under this section shall collect, verify, and submit to the Administrator information showing that the alternative means achieves equivalent emission reductions.

[55 FR 8346, Mar. 7, 1990, as amended at 58 FR 3099, Jan. 7, 1993]

[↑ Back to Top](#)

§61.354 Monitoring of operations.

(a) Except for a treatment process or waste stream complying with §61.348(d), the owner or operator shall monitor each treatment process or wastewater treatment system unit to ensure the unit is properly operated and maintained by one of the following monitoring procedures:

(1) Measure the benzene concentration of the waste stream exiting the treatment process complying with §61.348(a)(1)(i) at least once per month by collecting and analyzing one or more samples using the procedures specified in §61.355(c)(3).

(2) Install, calibrate, operate, and maintain according to manufacturer's specifications equipment to continuously monitor and record a process parameter (or parameters) for the treatment process or wastewater treatment system unit that indicates proper system operation. The owner or operator shall inspect at least once each operating day the data recorded by the monitoring equipment (e.g., temperature monitor or flow indicator) to ensure that the unit is operating properly.

(b) If an owner or operator complies with the requirements of §61.348(b), then the owner or operator shall monitor each wastewater treatment system to ensure the unit is properly operated and maintained by the appropriate monitoring procedure as follows:

(1) For the first exempt waste management unit in each waste treatment train, other than an enhanced biodegradation unit, measure the flow rate, using the procedures of §61.355(b), and the benzene concentration of each waste stream entering the unit at least once per month by collecting and analyzing one or more samples using the procedures specified in §61.355(c)(3).

(2) For each enhanced biodegradation unit that is the first exempt waste management unit in a treatment train, measure the benzene concentration of each waste stream entering the unit at least once per month by collecting and analyzing one or more samples using the procedures specified in §61.355(c)(3).

(c) An owner or operator subject to the requirements in §61.349 of this subpart shall install, calibrate, maintain, and operate according to the manufacturer's specifications a device to continuously monitor the control device operation as specified in the following paragraphs, unless alternative monitoring procedures or requirements are approved for that facility by the Administrator. The owner or operator shall inspect at least once each operating day the data recorded by the monitoring equipment (e.g., temperature monitor or flow indicator) to ensure that the control device is operating properly.

(1) For a thermal vapor incinerator, a temperature monitoring device equipped with a continuous recorder. The device shall have an accuracy of ± 1 percent of the temperature being monitored in $^{\circ}\text{C}$ or ± 0.5 $^{\circ}\text{C}$, whichever is greater. The temperature sensor shall be installed at a representative location in the combustion chamber.

(2) For a catalytic vapor incinerator, a temperature monitoring device equipped with a continuous recorder. The device shall be capable of monitoring temperature at two locations, and have an accuracy of ± 1 percent of the temperature being monitored in $^{\circ}\text{C}$ or ± 0.5 $^{\circ}\text{C}$, whichever is greater. One temperature sensor shall be installed in the vent stream at the nearest feasible point to the catalyst bed inlet and a second temperature sensor shall be installed in the vent stream at the nearest feasible point to the catalyst bed outlet.

(3) For a flare, a monitoring device in accordance with 40 CFR 60.18(f)(2) equipped with a continuous recorder.

(4) For a boiler or process heater having a design heat input capacity less than 44 MW (150×10^6 BTU/hr), a temperature monitoring device equipped with a continuous recorder. The device shall have an accuracy of ± 1 percent of the temperature being monitored in $^{\circ}\text{C}$ or ± 0.5 $^{\circ}\text{C}$, whichever is greater. The temperature sensor shall be installed at a representative location in the combustion chamber.

(5) For a boiler or process heater having a design heat input capacity greater than or equal to 44 MW (150×10^6 BTU/hr), a monitoring device equipped with a continuous recorder to measure a parameter(s) that indicates good combustion operating practices are being used.

(6) For a condenser, either:

(i) A monitoring device equipped with a continuous recorder to measure either the concentration level of the organic compounds or the concentration level of benzene in the exhaust vent stream from the condenser; or

(ii) A temperature monitoring device equipped with a continuous recorder. The device shall be capable of monitoring temperature at two locations, and have an accuracy of ± 1 percent of the temperature being monitored in $^{\circ}\text{C}$ or ± 0.5 $^{\circ}\text{C}$, whichever is greater. One temperature sensor shall be installed at a location in the exhaust stream from the condenser, and a second temperature sensor shall be installed at a location in the coolant fluid exiting the condenser.

(7) For a carbon adsorption system that regenerates the carbon bed directly in the control device such as a fixed-bed carbon adsorber, either:

(i) A monitoring device equipped with a continuous recorder to measure either the concentration level of the organic compounds or the benzene concentration level in the exhaust vent stream from the carbon bed; or

(ii) A monitoring device equipped with a continuous recorder to measure a parameter that indicates the carbon bed is regenerated on a regular, predetermined time cycle.

(8) For a vapor recovery system other than a condenser or carbon adsorption system, a monitoring device equipped with a continuous recorder to measure either the concentration level of the organic compounds or the benzene concentration level in the exhaust vent stream from the control device.

(9) For a control device subject to the requirements of §61.349(a)(2)(iv), devices to monitor the parameters as specified in §61.349(a)(2)(iv)(C).

(d) For a carbon adsorption system that does not regenerate the carbon bed directly on site in the control device (e.g., a carbon canister), either the concentration level of the organic compounds or the concentration level of benzene in the exhaust vent stream from the carbon adsorption system shall be monitored on a regular schedule, and the existing carbon shall be replaced with fresh carbon immediately when carbon breakthrough is indicated. The device shall be monitored on a daily basis or at intervals no greater than 20 percent of the design carbon replacement interval, whichever is greater. As an alternative to conducting this monitoring, an owner or operator may replace the carbon in the carbon adsorption system with fresh carbon at a regular predetermined time interval that is less than the carbon replacement interval that is determined by the maximum design flow rate and either the organic concentration or the benzene concentration in the gas stream vented to the carbon adsorption system.

(e) An alternative operation or process parameter may be monitored if it can be demonstrated that another parameter will ensure that the control device is operated in conformance with these standards and the control device's design specifications.

(f) Owners or operators using a closed-vent system that contains any bypass line that could divert a vent stream from a control device used to comply with the provisions of this subpart shall do the following:

(1) Visually inspect the bypass line valve at least once every month, checking the position of the valve and the condition of the car-seal or closure mechanism required under §61.349(a)(1)(ii) to ensure that the valve is maintained in the closed position and the vent stream is not diverted through the bypass line.

(2) Visually inspect the readings from each flow monitoring device required by §61.349(a)(1)(ii) at least once each operating day to check that vapors are being routed to the control device as required.

(g) Each owner or operator who uses a system for emission control that is maintained at a pressure less than atmospheric pressure with openings to provide dilution air shall install, calibrate, maintain, and operate according to the manufacturer's specifications a device equipped with a continuous recorder to monitor the pressure in the unit to ensure that it is less than atmospheric pressure.

[55 FR 8346, Mar. 7, 1990, as amended at 58 FR 3099, Jan. 7, 1993; 65 FR 62160, Oct. 17, 2000]

 [Back to Top](#)

§61.355 Test methods, procedures, and compliance provisions.

(a) An owner or operator shall determine the total annual benzene quantity from facility waste by the following procedure:

(1) For each waste stream subject to this subpart having a flow-weighted annual average water content greater than 10 percent water, on a volume basis as total water, or is mixed with water or other wastes at any time and the resulting mixture has an annual average water content greater than 10 percent as specified in §61.342(a), the owner or operator shall:

(i) Determine the annual waste quantity for each waste stream using the procedures specified in paragraph (b) of this section.

(ii) Determine the flow-weighted annual average benzene concentration for each waste stream using the procedures specified in paragraph (c) of this section.

(iii) Calculate the annual benzene quantity for each waste stream by multiplying the annual waste quantity of the waste stream times the flow-weighted annual average benzene concentration.

(2) Total annual benzene quantity from facility waste is calculated by adding together the annual benzene quantity for each waste stream generated during the year and the annual benzene quantity for each process unit turnaround waste annualized according to paragraph (b)(4) of this section.

(3) If the total annual benzene quantity from facility waste is equal to or greater than 10 Mg/yr (11 ton/yr), then the owner or operator shall comply with the requirements of §61.342 (c), (d), or (e).

(4) If the total annual benzene quantity from facility waste is less than 10 Mg/yr (11 ton/yr) but is equal to or greater than 1 Mg/yr (1.1 ton/yr), then the owner or operator shall:

(i) Comply with the recordkeeping requirements of §61.356 and reporting requirements of §61.357 of this subpart; and

(ii) Repeat the determination of total annual benzene quantity from facility waste at least once per year and whenever there is a change in the process generating the waste that could cause the total annual benzene quantity from facility waste to increase to 10 Mg/yr (11 ton/yr) or more.

(5) If the total annual benzene quantity from facility waste is less than 1 Mg/yr (1.1 ton/yr), then the owner or operator shall:

(i) Comply with the recordkeeping requirements of §61.356 and reporting requirements of §61.357 of this subpart; and

(ii) Repeat the determination of total annual benzene quantity from facility waste whenever there is a change in the process generating the waste that could cause the total annual benzene quantity from facility waste to increase to 1 Mg/yr (1.1 ton/yr) or more.

(6) The benzene quantity in a waste stream that is generated less than one time per year, except as provided for process unit turnaround waste in paragraph (b)(4) of this section, shall be included in the determination of total annual benzene quantity from facility waste for the year in which the waste is generated unless the waste stream is otherwise excluded from the determination of total annual benzene quantity from facility waste in accordance with paragraphs (a) through (c) of this section. The benzene quantity in this waste stream shall not be annualized or averaged over the time interval between the activities that resulted in generation of the waste, for purposes of determining the total annual benzene quantity from facility waste.

(b) For purposes of the calculation required by paragraph (a) of this section, an owner or operator shall determine the annual waste quantity at the point of waste generation, unless otherwise provided in paragraphs (b) (1), (2), (3), and (4) of this section, by one of the methods given in paragraphs (b) (5) through (7) of this section.

(1) The determination of annual waste quantity for sour water streams that are processed in sour water strippers shall be made at the point that the water exits the sour water stripper.

(2) The determination of annual waste quantity for wastes at coke by-product plants subject to and complying with the control requirements of §61.132, 61.133, 61.134, or 61.139 of subpart L of this part shall be made at the location that the waste stream exits the process unit component or waste management unit controlled by that subpart or at the exit of the ammonia still, provided that the following conditions are met:

(i) The transfer of wastes between units complying with the control requirements of subpart L of this part, process units, and the ammonia still is made through hard piping or other enclosed system.

(ii) The ammonia still meets the definition of a sour water stripper in §61.341.

(3) The determination of annual waste quantity for wastes that are received at hazardous waste treatment, storage, or disposal facilities from offsite shall be made at the point where the waste enters the hazardous waste treatment, storage, or disposal facility.

(4) The determination of annual waste quantity for each process unit turnaround waste generated only at 2 year or greater intervals, may be made by dividing the total quantity of waste generated during the most recent process unit turnaround by the time period (in the nearest tenth of a year) between the turnaround resulting in generation of the waste and the most recent preceding process turnaround for the unit. The resulting annual waste quantity shall be included in the calculation of the annual benzene quantity as provided in paragraph (a)(1)(iii) of this section for the year in which the turnaround occurs and for each subsequent year until the unit undergoes the next process turnaround. For estimates of total

annual benzene quantity as specified in the 90-day report, required under §61.357(a)(1), the owner or operator shall estimate the waste quantity generated during the most recent turnaround, and the time period between turnarounds in accordance with good engineering practices. If the owner or operator chooses not to annualize process unit turnaround waste, as specified in this paragraph, then the process unit turnaround waste quantity shall be included in the calculation of the annual benzene quantity for the year in which the turnaround occurs.

(5) Select the highest annual quantity of waste managed from historical records representing the most recent 5 years of operation or, if the facility has been in service for less than 5 years but at least 1 year, from historical records representing the total operating life of the facility;

(6) Use the maximum design capacity of the waste management unit; or

(7) Use measurements that are representative of maximum waste generation rates.

(c) For the purposes of the calculation required by §§61.355(a) of this subpart, an owner or operator shall determine the flow-weighted annual average benzene concentration in a manner that meets the requirements given in paragraph (c)(1) of this section using either of the methods given in paragraphs (c)(2) and (c)(3) of this section.

(1) The determination of flow-weighted annual average benzene concentration shall meet all of the following criteria:

(i) The determination shall be made at the point of waste generation except for the specific cases given in paragraphs (c)(1)(i)(A) through (D) of this section.

(A) The determination for sour water streams that are processed in sour water strippers shall be made at the point that the water exits the sour water stripper.

(B) The determination for wastes at coke by-product plants subject to and complying with the control requirements of §61.132, 61.133, 61.134, or 61.139 of subpart L of this part shall be made at the location that the waste stream exits the process unit component or waste management unit controlled by that subpart or at the exit of the ammonia still, provided that the following conditions are met:

(1) The transfer of wastes between units complying with the control requirements of subpart L of this part, process units, and the ammonia still is made through hard piping or other enclosed system.

(2) The ammonia still meets the definition of a sour water stripper in §61.341.

(C) The determination for wastes that are received from offsite shall be made at the point where the waste enters the hazardous waste treatment, storage, or disposal facility.

(D) The determination of flow-weighted annual average benzene concentration for process unit turnaround waste shall be made using either of the methods given in paragraph (c)(2) or (c)(3) of this section. The resulting flow-weighted annual average benzene concentration shall be included in the calculation of annual benzene quantity as provided in paragraph (a)(1)(iii) of this section for the year in which the turnaround occurs and for each subsequent year until the unit undergoes the next process unit turnaround.

(ii) Volatilization of the benzene by exposure to air shall not be used in the determination to reduce the benzene concentration.

(iii) Mixing or diluting the waste stream with other wastes or other materials shall not be used in the determination—to reduce the benzene concentration.

(iv) The determination shall be made prior to any treatment of the waste that removes benzene, except as specified in paragraphs (c)(1)(i)(A) through (D) of this section.

(v) For wastes with multiple phases, the determination shall provide the weighted-average benzene concentration based on the benzene concentration in each phase of the waste and the relative proportion of the phases.

(2) *Knowledge of the waste.* The owner or operator shall provide sufficient information to document the flow-weighted annual average benzene concentration of each waste stream. Examples of information that could constitute knowledge include material balances, records of chemicals purchases, or previous test results provided the results are still relevant to the current waste stream conditions. If test data are used, then the owner or operator shall provide documentation describing the testing protocol and the means by which sampling variability and analytical variability were accounted for in the determination of the flow-weighted annual average benzene concentration for the waste stream. When an owner or operator and the Administrator do not agree on determinations of the flow-weighted annual average benzene concentration based on knowledge of the waste, the procedures under paragraph (c)(3) of this section shall be used to resolve the disagreement.

(3) Measurements of the benzene concentration in the waste stream in accordance with the following procedures:

(i) Collect a minimum of three representative samples from each waste stream. Where feasible, samples shall be taken from an enclosed pipe prior to the waste being exposed to the atmosphere.

(ii) For waste in enclosed pipes, the following procedures shall be used:

(A) Samples shall be collected prior to the waste being exposed to the atmosphere in order to minimize the loss of benzene prior to sampling.

(B) A static mixer shall be installed in the process line or in a by-pass line unless the owner or operator demonstrates that installation of a static mixer in the line is not necessary to accurately determine the benzene concentration of the waste stream.

(C) The sampling tap shall be located within two pipe diameters of the static mixer outlet.

(D) Prior to the initiation of sampling, sample lines and cooling coil shall be purged with at least four volumes of waste.

(E) After purging, the sample flow shall be directed to a sample container and the tip of the sampling tube shall be kept below the surface of the waste during sampling to minimize contact with the atmosphere.

(F) Samples shall be collected at a flow rate such that the cooling coil is able to maintain a waste temperature less than 10 °C (50 °F).

(G) After filling, the sample container shall be capped immediately (within 5 seconds) to leave a minimum headspace in the container.

(H) The sample containers shall immediately be cooled and maintained at a temperature below 10 °C (50 °F) for transfer to the laboratory.

(iii) When sampling from an enclosed pipe is not feasible, a minimum of three representative samples shall be collected in a manner to minimize exposure of the sample to the atmosphere and loss of benzene prior to sampling.

(iv) Each waste sample shall be analyzed using one of the following test methods for determining the benzene concentration in a waste stream:

(A) Method 8020, Aromatic Volatile Organics, in "Test Methods for Evaluating Solid Waste, Physical/Chemical Methods," EPA Publication No. SW-846 (incorporation by reference as specified in §61.18 of this part);

(B) Method 8021, Volatile Organic Compounds in Water by Purge and Trap Capillary Column Gas Chromatography with Photoionization and Electrolytic Conductivity Detectors in Series in "Test Methods for Evaluating Solid Waste, Physical/Chemical Methods," EPA Publication No. SW-846 (incorporation by reference as specified in §61.18 of this part);

(C) Method 8240, Gas Chromatography/Mass Spectrometry for Volatile Organics in "Test Methods for Evaluating Solid Waste, Physical/Chemical Methods," EPA Publication No. SW-846 (incorporation by reference as specified in §61.18 of this part);

(D) Method 8260, Gas Chromatography/Mass Spectrometry for Volatile Organics: Capillary Column Technique in "Test Methods for Evaluating Solid Waste, Physical/Chemical Methods," EPA Publication No. SW-846 (incorporation by reference as specified in §61.18 of this part);

(E) Method 602, Purgeable Aromatics, as described in 40 CFR part 136, appendix A, Test Procedures for Analysis of Organic Pollutants, for wastewaters for which this is an approved EPA method; or

(F) Method 624, Purgeables, as described in 40 CFR part 136, appendix A, Test Procedures for Analysis of Organic Pollutants, for wastewaters for which this is an approved EPA method.

(v) The flow-weighted annual average benzene concentration shall be calculated by averaging the results of the sample analyses as follows:

$$\bar{C} = \frac{1}{Q_t} \times \sum_{i=1}^n (Q_i)(C_i)$$

[View or download PDF](#)

Where:

\bar{C} = Flow-weighted annual average benzene concentration for waste stream, ppmw.

Q_t = Total annual waste quantity for waste stream, kg/yr (lb/yr).

n = Number of waste samples (at least 3).

Q_i = Annual waste quantity for waste stream represented by C_i , kg/yr (lb/yr).

C_i = Measured concentration of benzene in waste sample i , ppmw.

(d) An owner or operator using performance tests to demonstrate compliance of a treatment process with §61.348 (a)(1)(i) shall measure the flow-weighted annual average benzene concentration of the waste stream exiting the treatment process by collecting and analyzing a minimum of three representative

samples of the waste stream using the procedures in paragraph (c)(3) of this section. The test shall be conducted under conditions that exist when the treatment process is operating at the highest inlet waste stream flow rate and benzene content expected to occur. Operations during periods of startup, shutdown, and malfunction shall not constitute representative conditions for the purpose of a test. The owner or operator shall record all process information as is necessary to document the operating conditions during the test.

(e) An owner or operator using performance tests to demonstrate compliance of a treatment process with §61.348(a)(1)(ii) of this subpart shall determine the percent reduction of benzene in the waste stream on a mass basis by the following procedure:

(1) The test shall be conducted under conditions that exist when the treatment process is operating at the highest inlet waste stream flow rate and benzene content expected to occur. Operations during periods of startup, shutdown, and malfunction shall not constitute representative conditions for the purpose of a test. The owner or operator shall record all process information as is necessary to document the operating conditions during the test.

(2) All testing equipment shall be prepared and installed as specified in the appropriate test methods.

(3) The mass flow rate of benzene entering the treatment process (E_b) shall be determined by computing the product of the flow rate of the waste stream entering the treatment process, as determined by the inlet flow meter, and the benzene concentration of the waste stream, as determined using the sampling and analytical procedures specified in paragraph (c)(2) or (c)(3) of this section. Three grab samples of the waste shall be taken at equally spaced time intervals over a 1-hour period. Each 1-hour period constitutes a run, and the performance test shall consist of a minimum of 3 runs conducted over a 3-hour period. The mass flow rate of benzene entering the treatment process is calculated as follows:

$$E_b = \frac{K}{n \times 10^6} \left[\sum_{i=1}^n V_i C_i \right]$$

[View or download PDF](#)

Where:

E_b = Mass flow rate of benzene entering the treatment process, kg/hr (lb/hr).

K = Density of the waste stream, kg/m³ (lb/ft³).

V_i = Average volume flow rate of waste entering the treatment process during each run i , m³/hr (ft³/hr).

C_i = Average concentration of benzene in the waste stream entering the treatment process during each run i , ppmw.

n = Number of runs.

10^6 = Conversion factor for ppmw.

(4) The mass flow rate of benzene exiting the treatment process (E_a) shall be determined by computing the product of the flow rate of the waste stream exiting the treatment process, as determined by the outlet flow meter or the inlet flow meter, and the benzene concentration of the waste stream, as determined using the sampling and analytical procedures specified in paragraph (c)(2) or (c)(3) of this section. Three grab samples of the waste shall be taken at equally spaced time intervals over a 1-hour period. Each 1-hour period constitutes a run, and the performance test shall consist of a minimum of 3 runs conducted over the same 3-hour period at which the mass flow rate of benzene entering the

treatment process is determined. The mass flow rate of benzene exiting the treatment process is calculated as follows:

$$E_a = \frac{K}{n \times 10^6} \left[\sum_{i=1}^n V_i C_i \right]$$

[View or download PDF](#)

Where:

E_a = Mass flow rate of benzene exiting the treatment process, kg/hr (lb/hr).

K = Density of the waste stream, kg/m³ (lb/ft³).

V_i = Average volume flow rate of waste exiting the treatment process during each run i , m³/hr (ft³/hr).

C_i = Average concentration of benzene in the waste stream exiting the treatment process during each run i , ppmw.

n = Number of runs.

10^6 = Conversion factor for ppmw.

(f) An owner or operator using performance tests to demonstrate compliance of a treatment process with §61.348(a)(1)(iii) of this subpart shall determine the benzene destruction efficiency for the combustion unit by the following procedure:

(1) The test shall be conducted under conditions that exist when the combustion unit is operating at the highest inlet waste stream flow rate and benzene content expected to occur. Operations during periods of startup, shutdown, and malfunction shall not constitute representative conditions for the purpose of a test. The owner or operator shall record all process information necessary to document the operating conditions during the test.

(2) All testing equipment shall be prepared and installed as specified in the appropriate test methods.

(3) The mass flow rate of benzene entering the combustion unit shall be determined by computing the product of the flow rate of the waste stream entering the combustion unit, as determined by the inlet flow meter, and the benzene concentration of the waste stream, as determined using the sampling procedures in paragraph (c)(2) or (c)(3) of this section. Three grab samples of the waste shall be taken at equally spaced time intervals over a 1-hour period. Each 1-hour period constitutes a run, and the performance test shall consist of a minimum of 3 runs conducted over a 3-hour period. The mass flow rate of benzene into the combustion unit is calculated as follows:

$$E_b = \frac{K}{n \times 10^6} \left[\sum_{i=1}^n V_i C_i \right]$$

[View or download PDF](#)

Where:

E_b = Mass flow rate of benzene entering the combustion unit, kg/hr (lb/hr).

K = Density of the waste stream, kg/m³ (lb/ft³).

V_i = Average volume flow rate of waste entering the combustion unit during each run i , m³/hr (ft³/hr).

C_i = Average concentration of benzene in the waste stream entering the combustion unit during each run i , ppmw.

n = Number of runs.

10^6 = Conversion factor for ppmw.

(4) The mass flow rate of benzene exiting the combustion unit exhaust stack shall be determined as follows:

(i) The time period for the test shall not be less than 3 hours during which at least 3 stack gas samples are collected and be the same time period at which the mass flow rate of benzene entering the treatment process is determined. Each sample shall be collected over a 1-hour period (e.g., in a tedlar bag) to represent a time-integrated composite sample and each 1-hour period shall correspond to the periods when the waste feed is sampled.

(ii) A run shall consist of a 1-hour period during the test. For each run:

(A) The reading from each measurement shall be recorded;

(B) The volume exhausted shall be determined using Method 2, 2A, 2C, or 2D from appendix A of 40 CFR part 60, as appropriate.

(C) The average benzene concentration in the exhaust downstream of the combustion unit shall be determined using Method 18 from appendix A of 40 CFR part 60.

(iii) The mass of benzene emitted during each run shall be calculated as follows:

$$M_i = D_b VC(10^{-6})$$

[View or download PDF](#)

Where:

M_i = Mass of benzene emitted during run i , kg (lb).

V = Volume of air-vapor mixture exhausted at standard conditions, m^3 (ft^3).

C = Concentration of benzene measured in the exhaust, ppmv.

D_b = Density of benzene, $3.24 \text{ kg}/m^3$ ($0.202 \text{ lb}/ft^3$).

10^6 = Conversion factor for ppmv.

(iv) The benzene mass emission rate in the exhaust shall be calculated as follows:

$$E_a = \left(\sum_{i=1}^n M_i \right) / T$$

[View or download PDF](#)

Where:

E_a = Mass flow rate of benzene emitted from the combustion unit, kg/hr (lb/hr).

M_i = Mass of benzene emitted from the combustion unit during run i , kg (lb).

T = Total time of all runs, hr.

n = Number of runs.

(5) The benzene destruction efficiency for the combustion unit shall be calculated as follows:

$$R = \frac{E_b - E_a}{E_b} \times 100$$

[View or download PDF](#)

Where:

R = Benzene destruction efficiency for the combustion unit, percent.

E_b = Mass flow rate of benzene entering the combustion unit, kg/hr (lb/hr).

E_a = Mass flow rate of benzene emitted from the combustion unit, kg/hr (lb/hr).

(g) An owner or operator using performance tests to demonstrate compliance of a wastewater treatment system unit with §61.348(b) shall measure the flow-weighted annual average benzene concentration of the wastewater stream where the waste stream enters an exempt waste management unit by collecting and analyzing a minimum of three representative samples of the waste stream using the procedures in paragraph (c)(3) of this section. The test shall be conducted under conditions that exist when the wastewater treatment system is operating at the highest inlet wastewater stream flow rate and benzene content expected to occur. Operations during periods of startup, shutdown, and malfunction shall not constitute representative conditions for the purpose of a test. The owner or operator shall record all process information as is necessary to document the operating conditions during the test.

(h) An owner or operator shall test equipment for compliance with no detectable emissions as required in §§61.343 through 61.347, and §61.349 of this subpart in accordance with the following requirements:

(1) Monitoring shall comply with Method 21 from appendix A of 40 CFR part 60.

(2) The detection instrument shall meet the performance criteria of Method 21.

(3) The instrument shall be calibrated before use on each day of its use by the procedures specified in Method 21.

(4) Calibration gases shall be:

(i) Zero air (less than 10 ppm of hydrocarbon in air); and

(ii) A mixture of methane or n-hexane and air at a concentration of approximately, but less than, 10,000 ppm methane or n-hexane.

(5) The background level shall be determined as set forth in Method 21.

(6) The instrument probe shall be traversed around all potential leak interfaces as close as possible to the interface as described in Method 21.

(7) The arithmetic difference between the maximum concentration indicated by the instrument and the background level is compared to 500 ppm for determining compliance.

(i) An owner or operator using a performance test to demonstrate compliance of a control device with either the organic reduction efficiency requirement or the benzene reduction efficiency requirement specified under §61.349(a)(2) shall use the following procedures:

(1) The test shall be conducted under conditions that exist when the waste management unit vented to the control device is operating at the highest load or capacity level expected to occur. Operations during periods of startup, shutdown, and malfunction shall not constitute representative conditions for the purpose of a test. The owner or operator shall record all process information necessary to document the operating conditions during the test.

(2) Sampling sites shall be selected using Method 1 or 1A from appendix A of 40 CFR part 60, as appropriate.

(3) The mass flow rate of either the organics or benzene entering and exiting the control device shall be determined as follows:

(i) The time period for the test shall not be less than 3 hours during which at least 3 stack gas samples are collected. Samples of the vent stream entering and exiting the control device shall be collected during the same time period. Each sample shall be collected over a 1-hour period (e.g., in a tedlar bag) to represent a time-integrated composite sample.

(ii) A run shall consist of a 1-hour period during the test. For each run:

(A) The reading from each measurement shall be recorded;

(B) The volume exhausted shall be determined using Method 2, 2A, 2C, or 2D from appendix A of 40 CFR part 60, as appropriate;

(C) The organic concentration or the benzene concentration, as appropriate, in the vent stream entering and exiting the control shall be determined using Method 18 from appendix A of 40 CFR part 60.

(iii) The mass of organics or benzene entering and exiting the control device during each run shall be calculated as follows:

$$M_{aj} = \frac{K_1 V_{aj}}{10^6} \left(\sum_{i=1}^n C_{ai} MW_i \right)$$

[View or download PDF](#)

$$M_{bj} = \frac{K_1 V_{bj}}{10^6} \left(\sum_{i=1}^n C_{bi} MW_i \right)$$

[View or download PDF](#)

M_{aj} = Mass of organics or benzene in the vent stream entering the control device during run j, kg (lb).

M_{bj} = Mass of organics or benzene in the vent stream exiting the control device during run j, kg (lb).

V_{aj} = Volume of vent stream entering the control device during run j, at standard conditions, m³ (ft³).

V_{bj} = Volume of vent stream exiting the control device during run j, at standard conditions, m³ (ft³).

C_{ai} = Organic concentration of compound i or the benzene concentration measured in the vent stream entering the control device as determined by Method 18, ppm by volume on a dry basis.

C_{bi} = Organic concentration of compound i or the benzene concentration measured in the vent stream exiting the control device as determined by Method 18, ppm by volume on a dry basis.

MW_i = Molecular weight of organic compound i in the vent stream, or the molecular weight of benzene, kg/kg-mol (lb/lb-mole).

n = Number of organic compounds in the vent stream; if benzene reduction efficiency is being demonstrated, then n = 1.

K_1 = Conversion factor for molar volume at standard conditions (293 K and 760 mm Hg (527 R and 14.7 psia))
= 0.0416 kg-mol/m³ (0.00118 lb-mol/ft³)

10⁻⁶ = Conversion factor for ppmv.

(iv) The mass flow rate of organics or benzene entering and exiting the control device shall be calculated as follows:

$$E_a = \left(\sum_{j=1}^n M_{aj} \right) / T$$

$$E_b = \left(\sum_{j=1}^n M_{bj} \right) / T$$

[View or download PDF](#)

Where:

E_a = Mass flow rate of organics or benzene entering the control device, kg/hr (lb/hr).

E_b = Mass flow rate of organics or benzene exiting the control device, kg/hr (lb/hr).

M_{aj} = Mass of organics or benzene in the vent stream entering the control device during run j, kg (lb).

M_{bj} = Mass of organics or benzene in the vent stream exiting the control device during run j, kg (lb).

T = Total time of all runs, hr.

n = Number of runs.

(4) The organic reduction efficiency or the benzene reduction efficiency for the control device shall be calculated as follows:

$$R = \frac{E_a - E_b}{E_a} \times 100$$

[View or download PDF](#)

Where:

R = Total organic reduction of efficiency or benzene reduction efficiency for the control device, percent.

E_a = Mass flow rate of organics or benzene entering the control device, kg/hr (lb/hr).

E_a = Mass flow rate of organic or benzene emitted from the control device, kg/hr (lb/hr).

(j) An owner or operator shall determine the benzene quantity for the purposes of the calculation required by §61.342 (c)(3)(ii)(B) according to the provisions of paragraph (a) of this section, except that the procedures in paragraph (a) of this section shall also apply to wastes with a water content of 10 percent or less.

(k) An owner or operator shall determine the benzene quantity for the purposes of the calculation required by §61.342(e)(2) by the following procedure:

(1) For each waste stream that is not controlled for air emissions in accordance with §61.343, 61.344, 61.345, 61.346, 61.347, or 61.348(a), as applicable to the waste management unit that manages the waste, the benzene quantity shall be determined as specified in paragraph (a) of this section, except that paragraph (b)(4) of this section shall not apply, i.e., the waste quantity for process unit turnaround waste is not annualized but shall be included in the determination of benzene quantity for the year in which the waste is generated for the purposes of the calculation required by §61.342(e)(2).

(2) For each waste stream that is controlled for air emissions in accordance with §61.343, 61.344, 61.345, 61.346, 61.347, or 61.348(a), as applicable to the waste management unit that manages the waste, the determination of annual waste quantity and flow-weighted annual average benzene concentration shall be made at the first applicable location as described in paragraphs (k)(2)(i), (k)(2)(ii), and (k)(2)(iii) of this section and prior to any reduction of benzene concentration through volatilization of the benzene, using the methods given in (k)(2)(iv) and (k)(2)(v) of this section.

(i) Where the waste stream enters the first waste management unit not complying with §§61.343, 61.344, 61.345, 61.346, 61.347, and 61.348(a) that are applicable to the waste management unit,

(ii) For each waste stream that is managed or treated only in compliance with §§61.343 through 61.348(a) up to the point of final direct discharge from the facility, the determination of benzene quantity shall be prior to any reduction of benzene concentration through volatilization of the benzene, or

(iii) For wastes managed in units controlled for air emissions in accordance with §§61.343, 61.344, 61.345, 61.346, 61.347, and 61.348(a), and then transferred offsite, facilities shall use the first applicable offsite location as described in paragraphs (k)(2)(i) and (k)(2)(ii) of this section if they have documentation from the offsite facility of the benzene quantity at this location. Facilities without this documentation for offsite wastes shall use the benzene quantity determined at the point where the transferred waste leaves the facility.

(iv) Annual waste quantity shall be determined using the procedures in paragraphs (b)(5), (6), or (7) of this section, and

(v) The flow-weighted annual average benzene concentration shall be determined using the procedures in paragraphs (c)(2) or (3) of this section.

(3) The benzene quantity in a waste stream that is generated less than one time per year, including process unit turnaround waste, shall be included in the determination of benzene quantity as determined in paragraph (k)(6) of this section for the year in which the waste is generated. The benzene quantity in this waste stream shall not be annualized or averaged over the time interval between the activities that resulted in generation of the waste for purposes of determining benzene quantity as determined in paragraph (k)(6) of this section.

(4) The benzene in waste entering an enhanced biodegradation unit, as defined in §61.348(b)(2)(ii)(B), shall not be included in the determination of benzene quantity, determined in paragraph (k)(6) of this section, if the following conditions are met:

(i) The benzene concentration for each waste stream entering the enhanced biodegradation unit is less than 10 ppmw on a flow-weighted annual average basis, and

(ii) All prior waste management units managing the waste comply with §§61.343, 61.344, 61.345, 61.346, 61.347 and 61.348(a).

(5) The benzene quantity for each waste stream in paragraph (k)(2) of this section shall be determined by multiplying the annual waste quantity of each waste stream times its flow-weighted annual average benzene concentration.

(6) The total benzene quantity for the purposes of the calculation required by §61.342(e)(2) shall be determined by adding together the benzene quantities determined in paragraphs (k)(1) and (k)(5) of this section for each applicable waste stream.

(7) If the benzene quantity determined in paragraph (6) of this section exceeds 6.0 Mg/yr (6.6 ton/yr) only because of multiple counting of the benzene quantity for a waste stream, the owner or operator may use the following procedures for the purposes of the calculation required by §61.342(e)(2):

(i) Determine which waste management units are involved in the multiple counting of benzene;

(ii) Determine the quantity of benzene that is emitted, recovered, or removed from the affected units identified in paragraph (k)(7)(i) of this section, or destroyed in the units if applicable, using either direct measurements or the best available estimation techniques developed or approved by the Administrator.

(iii) Adjust the benzene quantity to eliminate the multiple counting of benzene based on the results from paragraph (k)(7)(ii) of this section and determine the total benzene quantity for the purposes of the calculation required by §61.342(e)(2).

(iv) Submit in the annual report required under §61.357(a) a description of the methods used and the resulting calculations for the alternative procedure under paragraph (k)(7) of this section, the benzene quantity determination from paragraph (k)(6) of this section, and the adjusted benzene quantity determination from paragraph (k)(7)(iii) of this section.

[55 FR 8346, Mar. 7, 1990; 55 FR 12444, Apr. 3, 1990, as amended at 55 FR 37231, Sept. 10, 1990; 58 FR 3099, Jan. 7, 1993; 65 FR 62160, Oct. 17, 2000]

 [Back to Top](#)

§61.356 Recordkeeping requirements.

(a) Each owner or operator of a facility subject to the provisions of this subpart shall comply with the recordkeeping requirements of this section. Each record shall be maintained in a readily accessible location at the facility site for a period not less than two years from the date the information is recorded unless otherwise specified.

(b) Each owner or operator shall maintain records that identify each waste stream at the facility subject to this subpart, and indicate whether or not the waste stream is controlled for benzene emissions in accordance with this subpart. In addition the owner or operator shall maintain the following records:

(1) For each waste stream not controlled for benzene emissions in accordance with this subpart, the records shall include all test results, measurements, calculations, and other documentation used to determine the following information for the waste stream: waste stream identification, water content, whether or not the waste stream is a process wastewater stream, annual waste quantity, range of

benzene concentrations, annual average flow-weighted benzene concentration, and annual benzene quantity.

(2) For each waste stream exempt from §61.342(c)(1) in accordance with §61.342(c)(3), the records shall include:

(i) All measurements, calculations, and other documentation used to determine that the continuous flow of process wastewater is less than 0.02 liters (0.005 gallons) per minute or the annual waste quantity of process wastewater is less than 10 Mg/yr (11 ton/yr) in accordance with §61.342(c)(3)(i), or

(ii) All measurements, calculations, and other documentation used to determine that the sum of the total annual benzene quantity in all exempt waste streams does not exceed 2.0 Mg/yr (2.2 ton/yr) in accordance with §61.342(c)(3)(ii).

(3) For each facility where process wastewater streams are controlled for benzene emissions in accordance with §61.342(d) of this subpart, the records shall include for each treated process wastewater stream all measurements, calculations, and other documentation used to determine the annual benzene quantity in the process wastewater stream exiting the treatment process.

(4) For each facility where waste streams are controlled for benzene emissions in accordance with §61.342(e), the records shall include for each waste stream all measurements, including the locations of the measurements, calculations, and other documentation used to determine that the total benzene quantity does not exceed 6.0 Mg/yr (6.6 ton/yr).

(5) For each facility where the annual waste quantity for process unit turnaround waste is determined in accordance with §61.355(b)(5), the records shall include all test results, measurements, calculations, and other documentation used to determine the following information: identification of each process unit at the facility that undergoes turnarounds, the date of the most recent turnaround for each process unit, identification of each process unit turnaround waste, the water content of each process unit turnaround waste, the annual waste quantity determined in accordance with §61.355(b)(5), the range of benzene concentrations in the waste, the annual average flow-weighted benzene concentration of the waste, and the annual benzene quantity calculated in accordance with §61.355(a)(1)(iii) of this section.

(6) For each facility where wastewater streams are controlled for benzene emissions in accordance with §61.348(b)(2), the records shall include all measurements, calculations, and other documentation used to determine the annual benzene content of the waste streams and the total annual benzene quantity contained in all waste streams managed or treated in exempt waste management units.

(c) An owner or operator transferring waste off-site to another facility for treatment in accordance with §61.342(f) shall maintain documentation for each offsite waste shipment that includes the following information: Date waste is shipped offsite, quantity of waste shipped offsite, name and address of the facility receiving the waste, and a copy of the notice sent with the waste shipment.

(d) An owner or operator using control equipment in accordance with §§61.343 through 61.347 shall maintain engineering design documentation for all control equipment that is installed on the waste management unit. The documentation shall be retained for the life of the control equipment. If a control device is used, then the owner or operator shall maintain the control device records required by paragraph (f) of this section.

(e) An owner or operator using a treatment process or wastewater treatment system unit in accordance with §61.348 of this subpart shall maintain the following records. The documentation shall be retained for the life of the unit.

(1) A statement signed and dated by the owner or operator certifying that the unit is designed to operate at the documented performance level when the waste stream entering the unit is at the highest waste stream flow rate and benzene content expected to occur.

(2) If engineering calculations are used to determine treatment process or wastewater treatment system unit performance, then the owner or operator shall maintain the complete design analysis for the unit. The design analysis shall include for example the following information: Design specifications, drawings, schematics, piping and instrumentation diagrams, and other documentation necessary to demonstrate the unit performance.

(3) If performance tests are used to determine treatment process or wastewater treatment system unit performance, then the owner or operator shall maintain all test information necessary to demonstrate the unit performance.

(i) A description of the unit including the following information: type of treatment process; manufacturer name and model number; and for each waste stream entering and exiting the unit, the waste stream type (e.g., process wastewater, sludge, slurry, etc.), and the design flow rate and benzene content.

(ii) Documentation describing the test protocol and the means by which sampling variability and analytical variability were accounted for in the determination of the unit performance. The description of the test protocol shall include the following information: sampling locations, sampling method, sampling frequency, and analytical procedures used for sample analysis.

(iii) Records of unit operating conditions during each test run including all key process parameters.

(iv) All test results.

(4) If a control device is used, then the owner or operator shall maintain the control device records required by paragraph (f) of this section.

(f) An owner or operator using a closed-vent system and control device in accordance with §61.349 of this subpart shall maintain the following records. The documentation shall be retained for the life of the control device.

(1) A statement signed and dated by the owner or operator certifying that the closed-vent system and control device is designed to operate at the documented performance level when the waste management unit vented to the control device is or would be operating at the highest load or capacity expected to occur.

(2) If engineering calculations are used to determine control device performance in accordance with §61.349(c), then a design analysis for the control device that includes for example:

(i) Specifications, drawings, schematics, and piping and instrumentation diagrams prepared by the owner or operator, or the control device manufacturer or vendor that describe the control device design based on acceptable engineering texts. The design analysis shall address the following vent stream characteristics and control device operating parameters:

(A) For a thermal vapor incinerator, the design analysis shall consider the vent stream composition, constituent concentrations, and flow rate. The design analysis shall also establish the design minimum and average temperature in the combustion zone and the combustion zone residence time.

(B) For a catalytic vapor incinerator, the design analysis shall consider the vent stream composition, constituent concentrations, and flow rate. The design analysis shall also establish the design minimum and average temperatures across the catalyst bed inlet and outlet.

(C) For a boiler or process heater, the design analysis shall consider the vent stream composition, constituent concentrations, and flow rate. The design analysis shall also establish the design minimum and average flame zone temperatures, combustion zone residence time, and description of method and location where the vent stream is introduced into the flame zone.

(D) For a flare, the design analysis shall consider the vent stream composition, constituent concentrations, and flow rate. The design analysis shall also consider the requirements specified in 40 CFR 60.18.

(E) For a condenser, the design analysis shall consider the vent stream composition, constituent concentration, flow rate, relative humidity, and temperature. The design analysis shall also establish the design outlet organic compound concentration level or the design outlet benzene concentration level, design average temperature of the condenser exhaust vent stream, and the design average temperatures of the coolant fluid at the condenser inlet and outlet.

(F) For a carbon adsorption system that regenerates the carbon bed directly on-site in the control device such as a fixed-bed adsorber, the design analysis shall consider the vent stream composition, constituent concentration, flow rate, relative humidity, and temperature. The design analysis shall also establish the design exhaust vent stream organic compound concentration level or the design exhaust vent stream benzene concentration level, number and capacity of carbon beds, type and working capacity of activated carbon used for carbon beds, design total steam flow over the period of each complete carbon bed regeneration cycle, duration of the carbon bed steaming and cooling/drying cycles, design carbon bed temperature after regeneration, design carbon bed regeneration time, and design service life of carbon.

(G) For a carbon adsorption system that does not regenerate the carbon bed directly on-site in the control device, such as a carbon canister, the design analysis shall consider the vent stream composition, constituent concentration, flow rate, relative humidity, and temperature. The design analysis shall also establish the design exhaust vent stream organic compound concentration level or the design exhaust vent stream benzene concentration level, capacity of carbon bed, type and working capacity of activated carbon used for carbon bed, and design carbon replacement interval based on the total carbon working capacity of the control device and source operating schedule.

(H) For a control device subject to the requirements of §61.349(a)(2)(iv), the design analysis shall consider the vent stream composition, constituent concentration, and flow rate. The design analysis shall also include all of the information submitted under §61.349 (a)(2)(iv).

(ii) [Reserved]

(3) If performance tests are used to determine control device performance in accordance with §61.349(c) of this subpart:

(i) A description of how it is determined that the test is conducted when the waste management unit or treatment process is operating at the highest load or capacity level. This description shall include the estimated or design flow rate and organic content of each vent stream and definition of the acceptable operating ranges of key process and control parameters during the test program.

(ii) A description of the control device including the type of control device, control device manufacturer's name and model number, control device dimensions, capacity, and construction materials.

(iii) A detailed description of sampling and monitoring procedures, including sampling and monitoring locations in the system, the equipment to be used, sampling and monitoring frequency, and planned analytical procedures for sample analysis.

(iv) All test results.

(g) An owner or operator shall maintain a record for each visual inspection required by §§61.343 through 61.347 of this subpart that identifies a problem (such as a broken seal, gap or other problem) which could result in benzene emissions. The record shall include the date of the inspection, waste management unit and control equipment location where the problem is identified, a description of the problem, a description of the corrective action taken, and the date the corrective action was completed.

(h) An owner or operator shall maintain a record for each test of no detectable emissions required by §§61.343 through 61.347 and §61.349 of this subpart. The record shall include the following information: date the test is performed, background level measured during test, and maximum concentration indicated by the instrument reading measured for each potential leak interface. If detectable emissions are measured at a leak interface, then the record shall also include the waste management unit, control equipment, and leak interface location where detectable emissions were measured, a description of the problem, a description of the corrective action taken, and the date the corrective action was completed.

(i) For each treatment process and wastewater treatment system unit operated to comply with §61.348, the owner or operator shall maintain documentation that includes the following information regarding the unit operation:

(1) Dates of startup and shutdown of the unit.

(2) If measurements of waste stream benzene concentration are performed in accordance with §61.354(a)(1) of this subpart, the owner or operator shall maintain records that include date each test is performed and all test results.

(3) If a process parameter is continuously monitored in accordance with §61.354(a)(2) of this subpart, the owner or operator shall maintain records that include a description of the operating parameter (or parameters) to be monitored to ensure that the unit will be operated in conformance with these standards and the unit's design specifications, and an explanation of the criteria used for selection of that parameter (or parameters). This documentation shall be kept for the life of the unit.

(4) If measurements of waste stream benzene concentration are performed in accordance with §61.354(b), the owner or operator shall maintain records that include the date each test is performed and all test results.

(5) Periods when the unit is not operated as designed.

(j) For each control device, the owner or operator shall maintain documentation that includes the following information regarding the control device operation:

(1) Dates of startup and shutdown of the closed-vent system and control device.

(2) A description of the operating parameter (or parameters) to be monitored to ensure that the control device will be operated in conformance with these standards and the control device's design specifications and an explanation of the criteria used for selection of that parameter (or parameters). This documentation shall be kept for the life of the control device.

(3) Periods when the closed-vent system and control device are not operated as designed including all periods and the duration when:

(i) Any valve car-seal or closure mechanism required under §61.349(a)(1)(ii) is broken or the bypass line valve position has changed.

(ii) The flow monitoring devices required under §61.349(a)(1)(ii) indicate that vapors are not routed to the control device as required.

(4) If a thermal vapor incinerator is used, then the owner or operator shall maintain continuous records of the temperature of the gas stream in the combustion zone of the incinerator and records of all 3-hour periods of operation during which the average temperature of the gas stream in the combustion zone is more than 28 °C (50 °F) below the design combustion zone temperature.

(5) If a catalytic vapor incinerator is used, then the owner or operator shall maintain continuous records of the temperature of the gas stream both upstream and downstream of the catalyst bed of the incinerator, records of all 3-hour periods of operation during which the average temperature measured before the catalyst bed is more than 28 °C (50 °F) below the design gas stream temperature, and records of all 3-hour periods of operation during which the average temperature difference across the catalyst bed is less than 80 percent of the design temperature difference.

(6) If a boiler or process heater is used, then the owner or operator shall maintain records of each occurrence when there is a change in the location at which the vent stream is introduced into the flame zone as required by §61.349(a)(2)(i)(C). For a boiler or process heater having a design heat input capacity less than 44 MW (150 × 10⁶ BTU/hr), the owner or operator shall maintain continuous records of the temperature of the gas stream in the combustion zone of the boiler or process heater and records of all 3-hour periods of operation during which the average temperature of the gas stream in the combustion zone is more than 28 °C (50 °F) below the design combustion zone temperature. For a boiler or process heater having a design heat input capacity greater than or equal to 44 MW (150 × 10⁶ BTU/hr), the owner or operator shall maintain continuous records of the parameter(s) monitored in accordance with the requirements of §61.354(c)(5).

(7) If a flare is used, then the owner or operator shall maintain continuous records of the flare pilot flame monitoring and records of all periods during which the pilot flame is absent.

(8) If a condenser is used, then the owner or operator shall maintain records from the monitoring device of the parameters selected to be monitored in accordance with §61.354(c)(6). If concentration of organics or concentration of benzene in the control device outlet gas stream is monitored, then the owner or operator shall record all 3-hour periods of operation during which the concentration of organics or the concentration of benzene in the exhaust stream is more than 20 percent greater than the design value. If the temperature of the condenser exhaust stream and coolant fluid is monitored, then the owner or operator shall record all 3-hour periods of operation during which the temperature of the condenser exhaust vent stream is more than 6 °C (11 °F) above the design average exhaust vent stream temperature, or the temperature of the coolant fluid exiting the condenser is more than 6 °C (11 °F) above the design average coolant fluid temperature at the condenser outlet.

(9) If a carbon adsorber is used, then the owner or operator shall maintain records from the monitoring device of the concentration of organics or the concentration of benzene in the control device outlet gas stream. If the concentration of organics or the concentration of benzene in the control device outlet gas stream is monitored, then the owner or operator shall record all 3-hour periods of operation during which the concentration of organics or the concentration of benzene in the exhaust stream is more than 20 percent greater than the design value. If the carbon bed regeneration interval is monitored, then the owner or operator shall record each occurrence when the vent stream continues to flow through the control device beyond the predetermined carbon bed regeneration time.

(10) If a carbon adsorber that is not regenerated directly on site in the control device is used, then the owner or operator shall maintain records of dates and times when the control device is monitored, when breakthrough is measured, and shall record the date and time then the existing carbon in the control device is replaced with fresh carbon.

(11) If an alternative operational or process parameter is monitored for a control device, as allowed in §61.354(e) of this subpart, then the owner or operator shall maintain records of the continuously monitored parameter, including periods when the device is not operated as designed.

(12) If a control device subject to the requirements of §61.349(a)(2)(iv) is used, then the owner or operator shall maintain records of the parameters that are monitored and each occurrence when the parameters monitored are outside the range of values specified in §61.349(a)(2)(iv)(C), or other records as specified by the Administrator.

(k) An owner or operator who elects to install and operate the control equipment in §61.351 of this subpart shall comply with the recordkeeping requirements in 40 CFR 60.115b.

(l) An owner or operator who elects to install and operate the control equipment in §61.352 of this subpart shall maintain records of the following:

(1) The date, location, and corrective action for each visual inspection required by 40 CFR 60.693-2(a)(5), during which a broken seal, gap, or other problem is identified that could result in benzene emissions.

(2) Results of the seal gap measurements required by 40 CFR 60.693-2(a).

(m) If a system is used for emission control that is maintained at a pressure less than atmospheric pressure with openings to provide dilution air, then the owner or operator shall maintain records of the monitoring device and records of all periods during which the pressure in the unit is operated at a pressure that is equal to or greater than atmospheric pressure.

(n) Each owner or operator using a total enclosure to comply with control requirements for tanks in §61.343 or the control requirements for containers in §61.345 must keep the records required in paragraphs (n)(1) and (2) of this section. Owners or operators may use records as required in 40 CFR 264.1089(b)(2)(iv) or 40 CFR 265.1090(b)(2)(iv) for a tank or as required in 40 CFR 264.1089(d)(1) or 40 CFR 265.1090(d)(1) for a container to meet the recordkeeping requirement in paragraph (n)(1) of this section. The owner or operator must make the records of each verification of a total enclosure available for inspection upon request.

(1) Records of the most recent set of calculations and measurements performed to verify that the enclosure meets the criteria of a permanent total enclosure as specified in "Procedure T—Criteria for and Verification of a Permanent or Temporary Total Enclosure" in 40 CFR 52.741, appendix B;

(2) Records required for a closed-vent system and control device according to the requirements in paragraphs (d) (f), and (j) of this section.

[55 FR 8346, Mar. 7, 1990; 55 FR 12444, Apr. 3, 1990; 55 FR 18331, May 2, 1990, as amended at 58 FR 3103, Jan. 7, 1993; 65 FR 62161, Oct. 17, 2000; 67 FR 68533, Nov. 12, 2002]

 [Back to Top](#)

§61.357 Reporting requirements.

(a) Each owner or operator of a chemical plant, petroleum refinery, coke by-product recovery plant, and any facility managing wastes from these industries shall submit to the Administrator within 90 days after January 7, 1993, or by the initial startup for a new source with an initial startup after the effective date, a report that summarizes the regulatory status of each waste stream subject to §61.342 and is determined by the procedures specified in §61.355(c) to contain benzene. Each owner or operator subject to this subpart who has no benzene onsite in wastes, products, by-products, or intermediates shall submit an initial report that is a statement to this effect. For all other owners or operators subject to this subpart, the report shall include the following information:

(1) Total annual benzene quantity from facility waste determined in accordance with §61.355(a) of this subpart.

(2) A table identifying each waste stream and whether or not the waste stream will be controlled for benzene emissions in accordance with the requirements of this subpart.

(3) For each waste stream identified as not being controlled for benzene emissions in accordance with the requirements of this subpart the following information shall be added to the table:

(i) Whether or not the water content of the waste stream is greater than 10 percent;

(ii) Whether or not the waste stream is a process wastewater stream, product tank drawdown, or landfill leachate;

(iii) Annual waste quantity for the waste stream;

(iv) Range of benzene concentrations for the waste stream;

(v) Annual average flow-weighted benzene concentration for the waste stream; and

(vi) Annual benzene quantity for the waste stream.

(4) The information required in paragraphs (a) (1), (2), and (3) of this section should represent the waste stream characteristics based on current configuration and operating conditions. An owner or operator only needs to list in the report those waste streams that contact materials containing benzene. The report does not need to include a description of the controls to be installed to comply with the standard or other information required in §61.10(a).

(b) If the total annual benzene quantity from facility waste is less than 1 Mg/yr (1.1 ton/yr), then the owner or operator shall submit to the Administrator a report that updates the information listed in paragraphs (a)(1) through (a)(3) of this section whenever there is a change in the process generating the waste stream that could cause the total annual benzene quantity from facility waste to increase to 1 Mg/yr (1.1 ton/yr) or more.

(c) If the total annual benzene quantity from facility waste is less than 10 Mg/yr (11 ton/yr) but is equal to or greater than 1 Mg/yr (1.1 ton/yr), then the owner or operator shall submit to the Administrator a report that updates the information listed in paragraphs (a)(1) through (a)(3) of this section. The report shall be submitted annually and whenever there is a change in the process generating the waste stream that could cause the total annual benzene quantity from facility waste to increase to 10 Mg/yr (11 ton/yr) or more. If the information in the annual report required by paragraphs (a)(1) through (a)(3) of this section is not changed in the following year, the owner or operator may submit a statement to that effect.

(d) If the total annual benzene quantity from facility waste is equal to or greater than 10 Mg/yr (11 ton/yr), then the owner or operator shall submit to the Administrator the following reports:

(1) Within 90 days after January 7, 1993, unless a waiver of compliance under §61.11 of this part is granted, or by the date of initial startup for a new source with an initial startup after the effective date, a certification that the equipment necessary to comply with these standards has been installed and that the required initial inspections or tests have been carried out in accordance with this subpart. If a waiver of compliance is granted under §61.11, the certification of equipment necessary to comply with these standards shall be submitted by the date the waiver of compliance expires.

(2) Beginning on the date that the equipment necessary to comply with these standards has been certified in accordance with paragraph (d)(1) of this section, the owner or operator shall submit annually to the Administrator a report that updates the information listed in paragraphs (a)(1) through (a)(3) of this section. If the information in the annual report required by paragraphs (a)(1) through (a)(3) of this section is not changed in the following year, the owner or operator may submit a statement to that effect.

(3) If an owner or operator elects to comply with the requirements of §61.342(c)(3)(ii), then the report required by paragraph (d)(2) of this section shall include a table identifying each waste stream chosen for exemption and the total annual benzene quantity in these exempted streams.

(4) If an owner or operator elects to comply with the alternative requirements of §61.342(d) of this subpart, then he shall include in the report required by paragraph (d)(2) of this section a table presenting the following information for each process wastewater stream:

(i) Whether or not the process wastewater stream is being controlled for benzene emissions in accordance with the requirements of this subpart;

(ii) For each process wastewater stream identified as not being controlled for benzene emissions in accordance with the requirements of this subpart, the table shall report the following information for the process wastewater stream as determined at the point of waste generation: annual waste quantity, range of benzene concentrations, annual average flow-weighted benzene concentration, and annual benzene quantity;

(iii) For each process wastewater stream identified as being controlled for benzene emissions in accordance with the requirements of this subpart, the table shall report the following information for the process wastewater stream as determined at the exit to the treatment process: Annual waste quantity, range of benzene concentrations, annual average flow-weighted benzene concentration, and annual benzene quantity.

(5) If an owner or operator elects to comply with the alternative requirements of §61.342(e), then the report required by paragraph (d)(2) of this section shall include a table presenting the following information for each waste stream:

(i) For each waste stream identified as not being controlled for benzene emissions in accordance with the requirements of this subpart; the table shall report the following information for the waste stream as determined at the point of waste generation: annual waste quantity, range of benzene concentrations, annual average flow-weighted benzene concentration, and annual benzene quantity;

(ii) For each waste stream identified as being controlled for benzene emissions in accordance with the requirements of this subpart; the table shall report the following information for the waste stream as determined at the applicable location described in §61.355(k)(2): Annual waste quantity, range of benzene concentrations, annual average flow-weighted benzene concentration, and annual benzene quantity.

(6) Beginning 3 months after the date that the equipment necessary to comply with these standards has been certified in accordance with paragraph (d)(1) of this section, the owner or operator shall submit

quarterly to the Administrator a certification that all of the required inspections have been carried out in accordance with the requirements of this subpart.

(7) Beginning 3 months after the date that the equipment necessary to comply with these standards has been certified in accordance with paragraph (d)(1) of this section, the owner or operator shall submit a report quarterly to the Administrator that includes:

(i) If a treatment process or wastewater treatment system unit is monitored in accordance with §61.354(a)(1) of this subpart, then each period of operation during which the concentration of benzene in the monitored waste stream exiting the unit is equal to or greater than 10 ppmw.

(ii) If a treatment process or wastewater treatment system unit is monitored in accordance with §61.354(a)(2) of this subpart, then each 3-hour period of operation during which the average value of the monitored parameter is outside the range of acceptable values or during which the unit is not operating as designed.

(iii) If a treatment process or wastewater treatment system unit is monitored in accordance with §61.354(b), then each period of operation during which the flow-weighted annual average concentration of benzene in the monitored waste stream entering the unit is equal to or greater than 10 ppmw and/or the total annual benzene quantity is equal to or greater than 1.0 mg/yr.

(iv) For a control device monitored in accordance with §61.354(c) of this subpart, each period of operation monitored during which any of the following conditions occur, as applicable to the control device:

(A) Each 3-hour period of operation during which the average temperature of the gas stream in the combustion zone of a thermal vapor incinerator, as measured by the temperature monitoring device, is more than 28 °C (50 °F) below the design combustion zone temperature.

(B) Each 3-hour period of operation during which the average temperature of the gas stream immediately before the catalyst bed of a catalytic vapor incinerator, as measured by the temperature monitoring device, is more than 28 °C (50 °F) below the design gas stream temperature, and any 3-hour period during which the average temperature difference across the catalyst bed (i.e., the difference between the temperatures of the gas stream immediately before and after the catalyst bed), as measured by the temperature monitoring device, is less than 80 percent of the design temperature difference.

(C) Each 3-hour period of operation during which the average temperature of the gas stream in the combustion zone of a boiler or process heater having a design heat input capacity less than 44 MW (150 × 10⁶ BTU/hr), as measured by the temperature monitoring device, is more than 28 °C (50 °F) below the design combustion zone temperature.

(D) Each 3-hour period of operation during which the average concentration of organics or the average concentration of benzene in the exhaust gases from a carbon adsorber, condenser, or other vapor recovery system is more than 20 percent greater than the design concentration level of organics or benzene in the exhaust gas.

(E) Each 3-hour period of operation during which the temperature of the condenser exhaust vent stream is more than 6 °C (11 °F) above the design average exhaust vent stream temperature, or the temperature of the coolant fluid exiting the condenser is more than 6 °C (11 °F) above the design average coolant fluid temperature at the condenser outlet.

(F) Each period in which the pilot flame of a flare is absent.

(G) Each occurrence when there is a change in the location at which the vent stream is introduced into the flame zone of a boiler or process heater as required by §61.349(a)(2)(i)(C) of this subpart.

(H) Each occurrence when the carbon in a carbon adsorber system that is regenerated directly on site in the control device is not regenerated at the predetermined carbon bed regeneration time.

(I) Each occurrence when the carbon in a carbon adsorber system that is not regenerated directly on site in the control device is not replaced at the predetermined interval specified in §61.354(c) of this subpart.

(J) Each 3-hour period of operation during which the parameters monitored are outside the range of values specified in §61.349(a)(2)(iv)(C), or any other periods specified by the Administrator for a control device subject to the requirements of §61.349(a)(2)(iv).

(v) For a cover and closed-vent system monitored in accordance with §61.354(g), the owner or operator shall submit a report quarterly to the Administrator that identifies any period in which the pressure in the waste management unit is equal to or greater than atmospheric pressure.

(8) Beginning one year after the date that the equipment necessary to comply with these standards has been certified in accordance with paragraph (d)(1) of this section, the owner or operator shall submit annually to the Administrator a report that summarizes all inspections required by §§61.342 through 61.354 during which detectable emissions are measured or a problem (such as a broken seal, gap or other problem) that could result in benzene emissions is identified, including information about the repairs or corrective action taken.

(e) An owner or operator electing to comply with the provisions of §§61.351 or 61.352 of this subpart shall notify the Administrator of the alternative standard selected in the report required under §61.07 or §61.10 of this part.

(f) An owner or operator who elects to install and operate the control equipment in §61.351 of this subpart shall comply with the reporting requirements in 40 CFR 60.115b.

(g) An owner or operator who elects to install and operate the control equipment in §61.352 of this subpart shall submit initial and quarterly reports that identify all seal gap measurements, as required in 40 CFR 60.693-2(a), that are outside the prescribed limits.

[55 FR 8346, Mar. 7, 1990; 55 FR 12444, Apr. 3, 1990, as amended at 55 FR 37231, Sept. 10, 1990; 58 FR 3105, Jan. 7, 1993; 65 FR 62161, Oct. 17, 2000]

 [Back to Top](#)

§61.358 Delegation of authority.

(a) In delegating implementation and enforcement authority to a State under section 112(d) of the Clean Air Act, the authorities contained in paragraph (b) of this section shall be retained by the Administrator and not transferred to a State.

(b) Alternative means of emission limitation under §61.353 of this subpart will not be delegated to States.

 [Back to Top](#)

§61.359 [Reserved]

[↑ Back to Top](#)

Appendix A to Part 61

APPENDIX A
National Emission Standards for Hazardous Air Pollutants
Compliance Status Information

I. SOURCE REPORT

INSTRUCTIONS: Owners or operators of sources of hazardous pollutants subject to the National Emission Standards for Hazardous Air Pollutants are required to submit the information contained in Section I to the appropriate U.S. Environmental Protection Agency Regional Office prior to 90 days after the effective date of any standards or amendments which require the submission of such information.

A list of regional offices is provided in §61.04. _____

A. SOURCE INFORMATION

1. Identification/Location - Indicate the name and address of each source.

1	2	3	4	5	8	9	13	0	0	0	0	0	1		
Region	State		County		Source Number			14	16	17	18	19			
20	22	23	26	27 Source Name				46							
AQCR #		City Code		47 Street Address (Location of Plant)				66		80					
Dup 1-18		19		28 City Name		34 State		35		39					
40 State Regis. Number				54		55		58							
59 SIC				62		64		65		77		79		80	
FF				8		K/P		Staff							
Dup 1-18		5		25		STP		EC		80					
19		30		31		49									

2. Contact - Indicate the name and telephone number of the owner or operator or other responsible official whom EPA may contact concerning this report.

[View or download PDF](#)

Dup 1-18 4 1
19 20 21 Name 43

44 46
Area Code 47 Number 54 80

3. **Source Description** - Briefly state the nature of the source (e.g., "Chlor-alkali Plant" or "Machine Shop").

Dup 1-18 4 2
19 20 21 Description 50

51 Continued 79 80

4. **Alternative Mailing Address** - Indicate an alternative mailing address if correspondence is to be directed to a location different than that specified above.

Dup 1-18 4 3
19 20 21 Number Street or Box Number 45 80

Dup 1-18 4 4
19 20 21 City 35 State 37 38 41 Zip 44 80

5. **Compliance Status** - The emissions from this source can cannot meet the emission limitations contained in the National Emission Standards on or prior to 90 days after the effective date of any standards or amendments which require the submission of such information.

Signature of Owner, Operator or Other Responsible Official

NOTE: If the emissions from the source will exceed those limits set by the National Emission Standards for Hazardous Air Pollutants, the source will be in violation and subject to Federal enforcement actions unless granted a waiver of compliance by the Administrator of the U.S. Environmental Protection Agency. The information needed for such waivers is listed in Section II of this form.

- B. **PROCESS INFORMATION.** Part B should be completed separately for each point of emission for each hazardous pollutant. [Sources subject to 61.22(1) may omit number 4, below.]

Dup 1-13 14 16 17 18 19 20 SCC 27 28 29 30 31
NEQS X Ref LS SIP

[View or download PDF](#)

1. **Pollutant Emitted** - Indicate the type of hazardous pollutant emitted by the process. Indicate "AS" for asbestos, "BE" for beryllium, or "HG" for mercury.

32 33
Pollutant 34 Regulation 48 49
EC

2. **Process Description** - Provide a brief description of each process (e.g., "hydrogen end box" in a mercury chlor-alkali plant, "grinding machine" in a beryllium machine shop). Use additional sheets if necessary.

50 Process Description 74 80

Dup 1-18 6 1
19 20 21 50

51 79 80

Dup 1-18 6 2
19 20 21 50

51 79 80

3. **Amount of Pollutant** - Indicate the average weight of the hazardous material named in Item 1 which enters the process in pounds per month (based on the previous twelve months of operation).

Dup 1-18 6 3
19 20 21 lbs./mo. 29 36 80

4. **Control Devices**

a. Indicate the type of pollution control devices, if any, used to reduce the emissions from the process (e.g., venturi scrubber, baghouse, wet cyclone) and the estimated percent of the pollutant which the device removes from the process gas stream.

Dup 1-18 6 4
19 20 21 PRIMARY CONTROL DEVICE: 43

45 Primary Device Name 64 65 70 Percent Removal Efficiency 72 79

80

[View or download PDF](#)

Dup 1-18	6 5	SECONDARY CONTROL DEVICES:				45
	19 20	21				
47	Secondary Device Name			64	66	70
				% EFFIC.		79 80
				Percent Removal Efficiency		

- b. Asbestos Emission Control Devices Only
- If a baghouse is specified in Item 4a, give the following information:
 - The air flow permeability in cubic feet per minute per square foot of fabric area.
Air flow permeability = _____ cfm/ft²
 - The pressure drop in inches water gauge across the filter at which the baghouse is operated.
Operating pressure drop = _____ inches w.g.
 - If the baghouse material contains synthetic fill yarn, check whether this material is / / spun / / or not spun.
 - If the baghouse utilizes a felted fabric, give the minimum thickness in inches and the density in ounces per square yard.
Thickness = _____ inches Density = _____ oz/yd²
 - If a wet collection device is specified in Item 4a, give the designed unit contacting energy in inches water gauge.
 - Unit contacting energy = _____ inches w.g.

c. DISPOSAL OF ASBESTOS-CONTAINING WASTES. Part C should be completed separately for each asbestos-containing waste generation operation arising from sources subject to §61.22(a), (c), (e), and (h).

Dup 1-13	14	16	0 0	5	SCC		27	28 29	30	31
								NEDS X Ref	CS	SIP
A B	32	33	Regulation		48	49				
Pollutant						EC				

[View or download PDF](#)

- Waste Generation** - Provide a brief description of each process that generates asbestos-containing waste (e.g. disposal of control device wastes).

50 _____ Process Description _____ 79 80

- Asbestos Concentration** - Indicate the average percentage asbestos content of these materials.

Dup 1-18 6 1 _____ ASBESTOS CONCENTRATION: _____ 43 45 48

50 _____ 80

- Amount of Wastes** - Indicate the average weight of asbestos-containing wastes disposed of, measured in kg/day.

Dup 1-18 6 2 _____ kg/day _____ 27 29 34 80

- Control Methods** - Indicate the emission control methods used in all stages of waste disposal, from collection, processing, and packaging to transporting and deposition.

Dup 1-18 6 3 _____ Primary Control Method _____ 43

45 _____ 79 80

Dup 1-18 6 4 _____ _____ 50

51 _____ 79 80

- Waste Disposal** - Indicate the type of disposal site (sanitary landfill, open, covered) or incineration site (municipal, private) where the waste is disposed of and who operates the site (company, private, municipal). State the name and location of the site (closest city or town, county, state).

Dup 1-18 6 5 _____ TYPE OF SITE: _____ 33 35 _____ 50

51 _____ 79 80

[View or download PDF](#)

Dup 1-18 6 6 OPERATOR: 21 29 31 50
 19 20
 51 79 80
 Dup 1-18 6 7 LOCATION: 21 29
 31 70
 71 79 80

D. WASTE DISPOSAL SITES. Part D should be completed separately for each asbestos waste disposal site subject to section 61.22(1).

Dup 1-13 0 0 5 27 28 29 30 31
 14 16 17 18 19 20 SCC NEDS X Ref CS SIP
 A B
 32 33 Regulation 48 49
 Pollutant EC
 50 WASTE DISPOSAL SITE 68 80
 1. Description - Provide a brief description of the site, including its size and configuration, and the distance to the closest city or town, closest residence, and closest primary road.
 Dup 1-18 6 1 SITE DESCRIPTION 21 37 39 50
 51 79 80
 Dup 1-18 6 2 DISTANCE: 29 30 TOWN: 34 36 40 42 43 K M
 RESIDENCE: 54 56 60 62 63 K M ROAD: 65 69 71 75
 K M 77 78 80

[View or download PDF](#)

2. Inactivation - After the site is inactivated, indicate the method or methods used to comply with the standard and send a list of the actions that will be undertaken to maintain the inactivated site.

Dup 1-18 6 8 COMPLIANCE METHOD/INACTIVE SITE: 21 52
 19 20
 54 79 80

[View or download PDF](#)

II. WAIVER REQUESTS

A. *Waiver of Compliance.* Owners or operators of sources unable to operate in compliance with the National Emission Standards for Hazardous Air Pollutants prior to 90 days after the effective date of any standards or amendments which require the submission of such information may request a waiver of compliance from the Administrator of the U.S. Environmental Protection Agency for the time period necessary to install appropriate control devices or make modifications to achieve compliance. The Administrator may grant a waiver of compliance with the standard for a period not exceeding two years from the effective date of the hazardous pollutant standards, if he finds that such period is necessary for the installation of controls and that steps will be taken during the period of the waiver to assure that the health of persons will be protected from imminent endangerment.

The report information provided in Section I must accompany this application. Applications should be sent to the appropriate EPA regional office.

1. *Processes Involved*—Indicate the process or processes emitting hazardous pollutants to which emission controls are to be applied.

2. Controls

a. Describe the proposed type of control device to be added or modification to be made to the process to reduce the emission of hazardous pollutants to an acceptable level. (Use additional sheets if necessary.)

b. Describe the measures that will be taken during the waiver period to assure that the health of persons will be protected from imminent endangerment. (Use additional sheets if necessary.)

3. *Increments of Progress*—Specify the dates by which the following increments of progress will be met.

Date by which contracts for emission control systems or process modifications will be awarded; or date by which orders will be issued for the purchase of the component parts to accomplish emission control or process modification.

Dup 1-16

0 1 7	53 54	55	60	61	MO/DY/YR	66	80
17	19						

Date of initiation of on-site construction or installation of emission control equipment or process change.

Dup 1-16

0 2 7	53 54	55	60	61	MO/DY/YR	66	80
17	19						

Date by which on-site construction or installation of emission control equipment or process modification is to be completed.

Dup 1-16

0 3 7	53 54	55	60	61	MO/DY/YR	66	80
17	19						

Date by which final compliance is to be achieved.

Dup 1-16

0 4 7	53 54	55	60	61	MO/DY/YR	66	80
17	19						

[View or download PDF](#)

B. *Waiver of Emission Tests*. A waiver of emission testing may be granted to owners or operators of sources subject to emission testing if, in the judgment of the Administrator of the Environmental Protection Agency the emissions from the source comply with the appropriate standard or if the owners or operators of the source have requested a waiver of compliance or have been granted a waiver of compliance.

This application should accompany the report information provided in Section I.

1. *Reason*—State the reasons for requesting a waiver of emission testing. If the reason stated is that the emissions from the source are within the prescribed limits, documentation of this condition must be attached.

Date
Signature of the owner or operator

(Sec. 114, of the Clean Air Act as amended (42 U.S.C. 7414))

[40 FR 48303, Oct. 14, 1975, as amended at 43 FR 8800, Mar. 3, 1978; 50 FR 46295, Sept. 9, 1985]

[↑ Back to Top](#)

Appendix B to Part 61—Test Methods

Method 101—Determination of particulate and gaseous mercury emissions from chlor-alkali plants (air streams)

Method 101A—Determination of particulate and gaseous mercury emissions from sewage sludge incinerators

Method 102—Determination of particulate and gaseous mercury emissions from chlor-alkali plants (hydrogen streams)

Method 103—Beryllium screening method

Method 104—Determination of beryllium emissions from stationary sources

Method 105—Determination of mercury in wastewater treatment plant sewage sludges

Method 106—Determination of vinyl chloride emissions from stationary sources

Method 107—Determination of vinyl chloride content of in-process wastewater samples, and vinyl chloride content of polyvinyl chloride resin slurry, wet cake, and latex samples

Method 107A—Determination of vinyl chloride content of solvents, resin-solvent solution, polyvinyl chloride resin, resin slurry, wet resin, and latex samples

Method 108—Determination of particulate and gaseous arsenic emissions

Method 108A—Determination of arsenic content in ore samples from nonferrous smelters

Method 108B—Determination of arsenic content in ore samples from nonferrous smelters

Method 108C—Determination of arsenic content in ore samples from nonferrous smelters (molybdenum blue photometric procedure)

Method 111—Determination of Polonium—210 emissions from stationary sources

METHOD 101—DETERMINATION OF PARTICULATE AND GASEOUS MERCURY EMISSIONS FROM CHLOR-ALKALI PLANTS (AIR STREAMS)

NOTE: This method does not include all of the specifications (*e.g.*, equipment and supplies) and procedures (*e.g.*, sampling and analytical) essential to its performance. Some material is incorporated by reference from methods in appendix A to 40 CFR part 60. Therefore, to obtain reliable results, persons using this method should have a thorough knowledge of at least the following additional test methods: Method 1, Method 2, Method 3, and Method 5.

1.0 Scope and Application

1.1 Analytes.

Analyte	CAS No.	Sensitivity
Mercury (Hg)	7439-97-6	Dependent upon recorder and spectrophotometer.

1.2 Applicability. This method is applicable for the determination of Hg emissions, including both particulate and gaseous Hg, from chlor-alkali plants and other sources (as specified in the regulations) where the carrier-gas stream in the duct or stack is principally air.

1.3 Data Quality Objectives. Adherence to the requirements of this method will enhance the quality of the data obtained from air pollutant sampling methods.

2.0 Summary of Method

Particulate and gaseous Hg emissions are withdrawn isokinetically from the source and collected in acidic iodine monochloride (ICI) solution. The Hg collected (in the mercuric form) is reduced to elemental Hg, which is then aerated from the solution into an optical cell and measured by atomic absorption spectrophotometry.

3.0 Definitions [Reserved]

4.0 Interferences

4.1 Sample Collection. Sulfur dioxide (SO₂) reduces ICI and causes premature depletion of the ICI solution.

4.2 Sample Analysis.

4.2.1 ICI concentrations greater than 10⁻⁴ molar inhibit the reduction of the Hg (II) ion in the aeration cell.

4.2.2 Condensation of water vapor on the optical cell windows causes a positive interference.

5.0 Safety

5.1 Disclaimer. This method may involve hazardous materials, operations, and equipment. This test method does not purport to address all of the safety problems associated with its use. It is the responsibility of the user of this test method to establish appropriate safety and health practices and determine the applicability of regulatory limitations prior to performing this test method.

5.2 Corrosive Reagents. The following reagents are hazardous. Personal protective equipment and safe procedures are useful in preventing chemical splashes. If contact occurs, immediately flush with copious amounts of water for at least 15 minutes. Remove clothing under shower and decontaminate. Treat residual chemical burn as thermal burn.

5.2.1 Hydrochloric Acid (HCl). Highly toxic and corrosive. Causes severe damage to tissues. Vapors are highly irritating to eyes, skin, nose, and lungs, causing severe damage. May cause bronchitis, pneumonia, or edema of lungs. Exposure to concentrations of 0.13 to 0.2 percent can be lethal to humans in a few minutes. Provide ventilation to limit exposure. Reacts with metals, producing hydrogen gas.

5.2.2 Nitric Acid (HNO₃). Highly corrosive to eyes, skin, nose, and lungs. Vapors cause bronchitis, pneumonia, or edema of lungs. Reaction to inhalation may be delayed as long as 30 hours and still be fatal. Provide ventilation to limit exposure. Strong oxidizer. Hazardous reaction may occur with organic materials such as solvents.

5.2.3 Sulfuric Acid (H₂SO₄). Rapidly destructive to body tissue. Will cause third degree burns. Eye damage may result in blindness. Inhalation may be fatal from spasm of the larynx, usually within 30 minutes. 3 mg/m³ will cause lung damage. 1 mg/m³ for 8 hours will cause lung damage or, in higher concentrations, death. Provide ventilation to limit inhalation. Reacts violently with metals and organics.

6.0 Equipment and Supplies.

6.1 Sample Collection. A schematic of the sampling train used in performing this method is shown in Figure 101-1; it is similar to the Method 5 sampling train. The following items are required for sample collection:

6.1.1 Probe Nozzle, Pitot Tube, Differential Pressure Gauge, Metering System, Barometer, and Gas Density Determination Equipment. Same as Method 5, Sections 6.1.1.1, 6.1.1.3, 6.1.1.4, 6.1.1.9, 6.1.2, and 6.1.3, respectively.

6.1.2 Probe Liner. Borosilicate or quartz glass tubing. A heating system capable of maintaining a gas temperature of 120 ± 14 °C (248 ± 25 °F) at the probe exit during sampling may be used to prevent water condensation.

NOTE: Do not use metal probe liners.

6.1.3 Impingers. Four Greenburg-Smith impingers connected in series with leak-free ground glass fittings or any similar leak-free noncontaminating fittings. For the first, third, and fourth impingers, impingers that are modified by replacing the tip with a 13-mm ID (0.5-in.) glass tube extending to 13 mm (0.5 in.) from the bottom of the flask may be used.

6.1.4 Acid Trap. Mine Safety Appliances air line filter, Catalog number 81857, with acid absorbing cartridge and suitable connections, or equivalent.

6.2 Sample Recovery. The following items are needed for sample recovery:

6.2.1 Glass Sample Bottles. Leakless, with Teflon-lined caps, 1000- and 100-ml.

6.2.2 Graduated Cylinder. 250-ml.

6.2.3 Funnel and Rubber Policeman. To aid in transfer of silica gel to container; not necessary if silica gel is weighed in the field.

6.2.4 Funnel. Glass, to aid in sample recovery.

6.3 Sample Preparation and Analysis. The following items are needed for sample preparation and analysis:

6.3.1 Atomic Absorption Spectrophotometer. Perkin-Elmer 303, or equivalent, containing a hollow-cathode mercury lamp and the optical cell described in Section 6.3.2.

6.3.2 Optical Cell. Cylindrical shape with quartz end windows and having the dimensions shown in Figure 101-2. Wind the cell with approximately 2 meters (6 ft) of 24-gauge Nichrome wire, or equivalent, and wrap with fiberglass insulation tape, or equivalent; do not let the wires touch each other.

6.3.3 Aeration Cell. Constructed according to the specifications in Figure 101-3. Do not use a glass frit as a substitute for the blown glass bubbler tip shown in Figure 101-3.

6.3.4 Recorder. Matched to output of the spectrophotometer described in Section 6.3.1.

6.3.5 Variable Transformer. To vary the voltage on the optical cell from 0 to 40 volts.

6.3.6 Hood. For venting optical cell exhaust.

6.3.7 Flow Metering Valve.

6.3.8 Rate Meter. Rotameter, or equivalent, capable of measuring to within 2 percent a gas flow of 1.5 liters/min (0.053 cfm).

6.3.9 Aeration Gas Cylinder. Nitrogen or dry, Hg-free air, equipped with a single-stage regulator.

6.3.10 Tubing. For making connections. Use glass tubing (ungreased ball and socket connections are recommended) for all tubing connections between the solution cell and the optical cell; do not use Tygon tubing, other types of flexible tubing, or metal tubing as substitutes. Teflon, steel, or copper tubing may be used between the nitrogen tank and flow metering valve (Section 6.3.7), and Tygon, gum, or rubber tubing between the flow metering valve and the aeration cell.

6.3.11 Flow Rate Calibration Equipment. Bubble flow meter or wet-test meter for measuring a gas flow rate of 1.5 ± 0.1 liters/min (0.053 ± 0.0035 cfm).

6.3.12 Volumetric Flasks. Class A with penny head standard taper stoppers; 100-, 250-, 500-, and 1000-ml.

6.3.13 Volumetric Pipets. Class A; 1-, 2-, 3-, 4-, and 5-ml.

6.3.14 Graduated Cylinder. 50-ml.

6.3.15 Magnetic Stirrer. General-purpose laboratory type.

6.3.16 Magnetic Stirring Bar. Teflon-coated.

6.3.17 Balance. Capable of weighing to ± 0.5 g.

6.3.18 Alternative Analytical Apparatus. Alternative systems are allowable as long as they meet the following criteria:

6.3.18.1 A linear calibration curve is generated and two consecutive samples of the same aliquot size and concentration agree within 3 percent of their average.

6.3.18.2 A minimum of 95 percent of the spike is recovered when an aliquot of a source sample is spiked with a known concentration of Hg (II) compound.

6.3.18.3 The reducing agent should be added after the aeration cell is closed.

6.3.18.4 The aeration bottle bubbler should not contain a frit.

6.3.18.5 Any Tygon tubing used should be as short as possible and conditioned prior to use until blanks and standards yield linear and reproducible results.

6.3.18.6 If manual stirring is done before aeration, it should be done with the aeration cell closed.

6.3.18.7 A drying tube should not be used unless it is conditioned as the Tygon tubing above.

7.0 Reagents and Standards

Unless otherwise indicated, all reagents must conform to the specifications established by the Committee on Analytical Reagents of the American Chemical Society; where such specifications are not available, use the best available grade.

7.1 Sample Collection. The following reagents are required for sample collection:

7.1.1 Water. Deionized distilled, to conform to ASTM D 1193-77 or 91 (incorporated by reference—see §61.18), Type 1. If high concentrations of organic matter are not expected to be present, the analyst may eliminate the KMnO_4 test for oxidizable organic matter. Use this water in all dilutions and solution preparations.

7.1.2 Nitric Acid, 50 Percent (v/v). Mix equal volumes of concentrated HNO_3 and water, being careful to add the acid to the water slowly.

7.1.3 Silica Gel. Indicating type, 6- to 16-mesh. If previously used, dry at $175\text{ }^\circ\text{C}$ ($350\text{ }^\circ\text{F}$) for 2 hours. The tester may use new silica gel as received.

7.1.4 Potassium Iodide (KI) Solution, 25 Percent. Dissolve 250 g of KI in water, and dilute to 1 liter.

7.1.5 Iodine Monochloride Stock Solution, 1.0 M. To 800 ml of 25 percent KI solution, add 800 ml of concentrated HCl. Cool to room temperature. With vigorous stirring, slowly add 135 g of potassium iodate (KIO_3), and stir until all free iodine has dissolved. A clear orange-red solution occurs when all the KIO_3 has been added. Cool to room temperature, and dilute to 1800 ml with water. Keep the solution in amber glass bottles to prevent degradation.

7.1.6 Absorbing Solution, 0.1 M ICl. Dilute 100 ml of the 1.0 M ICl stock solution to 1 liter with water. Keep the solution in amber glass bottles and in darkness to prevent degradation. This reagent is stable for at least two months.

7.2 Sample Preparation and Analysis. The following reagents and standards are required for sample preparation and analysis:

7.2.1 Reagents.

7.2.1.1 Tin (II) Solution. Prepare fresh daily, and keep sealed when not being used. Completely dissolve 20 g of tin (II) chloride (or 25 g of tin (II) sulfate) crystals (Baker Analyzed reagent grade or any other brand that will give a clear solution) in 25 ml of concentrated HCl. Dilute to 250 ml with water. Do not substitute HNO_3 , H_2SO_4 , or other strong acids for the HCl.

7.2.1.2 Sulfuric Acid, 5 Percent (v/v). Dilute 25 ml of concentrated H_2SO_4 to 500 ml with water.

7.2.2 Standards

7.2.2.1 Hg Stock Solution, 1 mg Hg/ml. Prepare and store all Hg standard solutions in borosilicate glass containers. Completely dissolve 0.1354 g of Hg (II) chloride in 75 ml of water in a 100-ml glass volumetric flask. Add 10 ml of concentrated HNO_3 , and adjust the volume to exactly 100 ml with water. Mix thoroughly. This solution is stable for at least one month.

7.2.2.2 Intermediate Hg Standard Solution, 10 μg Hg/ml. Prepare fresh weekly. Pipet 5.0 ml of the Hg stock solution (Section 7.2.2.1) into a 500-ml glass volumetric flask, and add 20 ml of the 5 percent H_2SO_4 solution. Dilute to exactly 500 ml with water. Thoroughly mix the solution.

7.2.2.3 Working Hg Standard Solution, 200 ng Hg/ml. Prepare fresh daily. Pipet 5.0 ml of the intermediate Hg standard solution (Section 7.2.2.2) into a 250-ml volumetric glass flask. Add 10 ml of the 5 percent H₂SO₄ and 2 ml of the 0.1 M ICl absorbing solution taken as a blank (Section 8.7.4.3), and dilute to 250 ml with water. Mix thoroughly.

8.0 Sample Collection, Preservation, Transport, and Storage

Because of the complexity of this method, testers should be trained and experienced with the test procedures to ensure reliable results. Since the amount of Hg that is collected generally is small, the method must be carefully applied to prevent contamination or loss of sample.

8.1 Pretest Preparation. Follow the general procedure outlined in Method 5, Section 8.1, except omit Sections 8.1.2 and 8.1.3.

8.2 Preliminary Determinations. Follow the general procedure outlined in Method 5, Section 8.2, with the exception of the following:

8.2.1 Select a nozzle size based on the range of velocity heads to assure that it is not necessary to change the nozzle size in order to maintain isokinetic sampling rates below 28 liters/min (1.0 cfm).

8.2.2 Perform test runs such that samples are obtained over a period or periods that accurately determine the maximum emissions that occur in a 24-hour period. In the case of cyclic operations, run sufficient tests for the accurate determination of the emissions that occur over the duration of the cycle. A minimum sample time of 2 hours is recommended. In some instances, high Hg or high SO₂ concentrations make it impossible to sample for the desired minimum time. This is indicated by reddening (liberation of free iodine) in the first impinger. In these cases, the sample run may be divided into two or more subruns to ensure that the absorbing solution is not depleted.

8.3 Preparation of Sampling Train.

8.3.1 Clean all glassware (probe, impingers, and connectors) by rinsing with 50 percent HNO₃, tap water, 0.1 M ICl, tap water, and finally deionized distilled water. Place 100 ml of 0.1 M ICl in each of the first three impingers. Take care to prevent the absorbing solution from contacting any greased surfaces. Place approximately 200 g of preweighed silica gel in the fourth impinger. More silica gel may be used, but care should be taken to ensure that it is not entrained and carried out from the impinger during sampling. Place the silica gel container in a clean place for later use in the sample recovery. Alternatively, determine and record the weight of the silica gel plus impinger to the nearest 0.5 g.

8.3.2 Install the selected nozzle using a Viton A O-ring when stack temperatures are less than 260 °C (500 °F). Use a fiberglass string gasket if temperatures are higher. See APTD-0576 (Reference 3 in Method 5) for details. Other connecting systems using either 316 stainless steel or Teflon ferrules may be used. Mark the probe with heat-resistant tape or by some other method to denote the proper distance into the stack or duct for each sampling point.

8.3.3 Assemble the train as shown in Figure 101-1, using (if necessary) a very light coat of silicone grease on all ground glass joints. Grease only the outer portion (see APTD-0576) to avoid the possibility of contamination by the silicone grease.

NOTE: An empty impinger may be inserted between the third impinger and the silica gel to remove excess moisture from the sample stream.

8.3.4 After the sampling train has been assembled, turn on and set the probe heating system, if applicable, at the desired operating temperature. Allow time for the temperatures to stabilize. Place crushed ice around the impingers.

8.4 Leak-Check Procedures. Follow the leak-check procedures outlined in Method 5, Section 8.4.

8.5 Sampling Train Operation. Follow the general procedure outlined in Method 5, Section 8.5. For each run, record the data required on a data sheet such as the one shown in Figure 101-4.

8.6 Calculation of Percent Isokinetic. Same as Method 5, Section 8.6.

8.7 Sample Recovery. Begin proper cleanup procedure as soon as the probe is removed from the stack at the end of the sampling period.

8.7.1 Allow the probe to cool. When it can be safely handled, wipe off any external particulate matter near the tip of the probe nozzle, and place a cap over it. Do not cap off the probe tip tightly while the sampling train is cooling. Capping would create a vacuum and draw liquid out from the impingers.

8.7.2 Before moving the sampling train to the cleanup site, remove the probe from the train, wipe off the silicone grease, and cap the open outlet of the probe. Be careful not to lose any condensate that might be present. Wipe off the silicone grease from the impinger. Use either ground-glass stoppers, plastic caps, or serum caps to close these openings.

8.7.3 Transfer the probe and impinger assembly to a cleanup area that is clean, protected from the wind, and free of Hg contamination. The ambient air in laboratories located in the immediate vicinity of Hg-using facilities is not normally free of Hg contamination.

8.7.4 Inspect the train before and during disassembly, and note any abnormal conditions. Treat the samples as follows.

8.7.4.1 Container No. 1 (Impingers and Probe).

8.7.4.1.1 Using a graduated cylinder, measure the liquid in the first three impingers to within 1 ml. Record the volume of liquid present (*e.g.*, see Figure 5-6 of Method 5). This information is needed to calculate the moisture content of the effluent gas. (Use only glass storage bottles and graduated cylinders that have been precleaned as in Section 8.3.1) Place the contents of the first three impingers into a 1000-ml glass sample bottle.

8.7.4.1.2 Taking care that dust on the outside of the probe or other exterior surfaces does not get into the sample, quantitatively recover the Hg (and any condensate) from the probe nozzle, probe fitting, and probe liner as follows: Rinse these components with two 50-ml portions of 0.1 M ICI. Next, rinse the probe nozzle, fitting and liner, and each piece of connecting glassware between the probe liner and the back half of the third impinger with a maximum of 400 ml of water. Add all washings to the 1000-ml glass sample bottle containing the liquid from the first three impingers.

8.7.4.1.3 After all washings have been collected in the sample container, tighten the lid on the container to prevent leakage during shipment to the laboratory. Mark the height of the liquid to determine later whether leakage occurred during transport. Label the container to identify clearly its contents.

8.7.4.2 Container No. 2 (Silica Gel). Same as Method 5, Section 8.7.6.3.

8.7.4.3 Container No. 3 (Absorbing Solution Blank). Place 50 ml of the 0.1 M ICl absorbing solution in a 100-ml sample bottle. Seal the container. Use this blank to prepare the working Hg standard solution (Section 7.2.2.3).

9.0 Quality Control

9.1 Miscellaneous Quality Control Measures.

Section	Quality control measure	Effect
8.4 10.2	Sampling equipment leak-checks and calibration	Ensure accuracy and precision of sampling measurements.
10.5, 10.6	Spectrophotometer calibration	Ensure linearity of spectrophotometer response to standards.
11.3.3	Check for matrix effects	Eliminate matrix effects.

9.2 Volume Metering System Checks. Same as Method 5, Section 9.2.

10.0 Calibration and Standardizations

NOTE: Maintain a laboratory log of all calibrations.

10.1 Before use, clean all glassware, both new and used, as follows: brush with soap and tap water, liberally rinse with tap water, soak for 1 hour in 50 percent HNO₃, and then rinse with deionized distilled water.

10.2 Sampling Equipment. Calibrate the sampling equipment according to the procedures outlined in the following sections of Method 5: Section 10.1 (Probe Nozzle), Section 10.2 (Pitot Tube Assembly), Section 10.3 (Metering System), Section 10.5 (Temperature Sensors), Section 10.6 (Barometer).

10.3 Aeration System Flow Rate Meter. Assemble the aeration system as shown in Figure 101-5. Set the outlet pressure on the aeration gas cylinder regulator to a minimum pressure of 500 mm Hg (10 psi), and use the flow metering valve and a bubble flowmeter or wet-test meter to obtain a flow rate of 1.5 ±0.1 liters/min (0.053 ±0.0035 cfm) through the aeration cell. After the calibration of the aeration system flow rate meter is complete, remove the bubble flowmeter from the system.

10.4 Optical Cell Heating System. Using a 50-ml graduated cylinder, add 50 ml of water to the bottle section of the aeration cell, and attach the bottle section to the bubbler section of the cell. Attach the aeration cell to the optical cell and while aerating at 1.5 ±0.1 liters/min (0.053 ±0.0035 cfm), determine the minimum variable transformer setting necessary to prevent condensation of moisture in the optical cell and in the connecting tubing. (This setting should not exceed 20 volts.)

10.5 Spectrophotometer and Recorder.

10.5.1 The Hg response may be measured by either peak height or peak area.

NOTE: The temperature of the solution affects the rate at which elemental Hg is released from a solution and, consequently, it affects the shape of the absorption curve (area) and the point of maximum absorbance (peak height). Therefore, to obtain reproducible results, bring all solutions to room temperature before use.

10.5.2 Set the spectrophotometer wavelength at 253.7 nm, and make certain the optical cell is at the minimum temperature that will prevent water condensation. Then set the recorder scale as follows: Using a 50-ml graduated cylinder, add 50 ml of water to the aeration cell bottle. Add three drops of Antifoam B to the bottle, and then pipet 5.0 ml of the working Hg standard solution into the aeration cell.

NOTE: Always add the Hg-containing solution to the aeration cell after the 50 ml of water.

10.5.3 Place a Teflon-coated stirring bar in the bottle. Before attaching the bottle section to the bubbler section of the aeration cell, make certain that (1) the aeration cell exit arm stopcock (Figure 101-3) is closed (so that Hg will not prematurely enter the optical cell when the reducing agent is being added) and (2) there is no flow through the bubbler. If conditions (1) and (2) are met, attach the bottle section to the bubbler section of the aeration cell. Pipet 5 ml of tin (II) reducing solution into the aeration cell through the side arm, and immediately stopper the side arm. Stir the solution for 15 seconds, turn on the recorder, open the aeration cell exit arm stopcock, and immediately initiate aeration with continued stirring. Determine the maximum absorbance of the standard, and set this value to read 90 percent of the recorder full scale.

10.6 Calibration Curve.

10.6.1 After setting the recorder scale, repeat the procedure in Section 10.5 using 0.0-, 1.0-, 2.0-, 3.0-, 4.0-, and 5.0-ml aliquots of the working standard solution (final amount of Hg in the aeration cell is 0, 200, 400, 600, 800, and 1000 ng, respectively). Repeat this procedure on each aliquot size until two consecutive peaks agree within 3 percent of their average value.

NOTE: To prevent Hg carryover from one sample to another, do not close the aeration cell from the optical cell until the recorder pen has returned to the baseline.)

10.6.2 It should not be necessary to disconnect the aeration gas inlet line from the aeration cell when changing samples. After separating the bottle and bubbler sections of the aeration cell, place the bubbler section into a 600-ml beaker containing approximately 400 ml of water. Rinse the bottle section of the aeration cell with a stream of water to remove all traces of the tin (II) reducing agent. Also, to prevent the loss of Hg before aeration, remove all traces of the reducing agent between samples by washing with water. It will be necessary, however, to wash the aeration cell parts with concentrated HCl if any of the following conditions occur: (1) A white film appears on any inside surface of the aeration cell, (2) the calibration curve changes suddenly, or (3) the replicate samples do not yield reproducible results.

10.6.3 Subtract the average peak height (or peak area) of the blank (0.0-ml aliquot)—which must be less than 2 percent of recorder full scale—from the averaged peak heights of the 1.0-, 2.0-, 3.0-, 4.0-, and 5.0-ml aliquot standards. If the blank absorbance is greater than 2 percent of full-scale, the probable cause is Hg contamination of a reagent or carry-over of Hg from a previous sample. Prepare the calibration curve by plotting the corrected peak height of each standard solution versus the corresponding final total Hg weight in the aeration cell (in ng), and draw the best fit straight line. This line should either pass through the origin or pass through a point no further from the origin than ± 2 percent of the recorder full scale. If the line does not pass through or very near to the origin, check for nonlinearity of the curve and for incorrectly prepared standards.

11.0 Analytical Procedure

11.1 Sample Loss Check. Check the liquid level in each container to see whether liquid was lost during transport. If a noticeable amount of leakage occurred, either void the sample or use methods subject to the approval of the Administrator to account for the losses.

11.2 Sample Preparation. Treat each sample as follows:

11.2.1 Container No. 1 (Impingers and Probe). Carefully transfer the contents of Container No. 1 into a 1000-ml volumetric flask, and adjust the volume to exactly 1000 ml with water.

11.2.2 Dilutions. Pipet a 2-ml aliquot from the diluted sample from Section 11.2.1 into a 250-ml volumetric flask. Add 10 ml of 5 percent H₂SO₄, and adjust the volume to exactly 250 ml with water. This solution is stable for at least 72 hours.

NOTE: The dilution factor will be 250/2 for this solution.

11.3 Analysis. Calibrate the analytical equipment and develop a calibration curve as outlined in Sections 10.3 through 10.6.

11.3.1 Mercury Samples. Repeat the procedure used to establish the calibration curve with an appropriately sized aliquot (1 to 5 ml) of the diluted sample (from Section 11.2.2) until two consecutive peak heights agree within 3 percent of their average value. The peak maximum of an aliquot (except the 5-ml aliquot) must be greater than 10 percent of the recorder full scale. If the peak maximum of a 1.0-ml aliquot is off scale on the recorder, further dilute the original source sample to bring the Hg concentration into the calibration range of the spectrophotometer.

11.3.2 Run a blank and standard at least after every five samples to check the spectrophotometer calibration. The peak height of the blank must pass through a point no further from the origin than ± 2 percent of the recorder full scale. The difference between the measured concentration of the standard (the product of the corrected peak height and the reciprocal of the least squares slope) and the actual concentration of the standard must be less than 7 percent, or recalibration of the analyzer is required.

11.3.3 Check for Matrix Effects (optional). Use the Method of Standard Additions as follows to check at least one sample from each source for matrix effects on the Hg results. The Method of Standard Additions procedures described on pages 9-4 and 9-5 of the section entitled "General Information" of the Perkin Elmer Corporation Atomic Absorption Spectrophotometry Manual, Number 303-0152 (Reference 16 in Section 16.0) are recommended. If the results of the Method of Standard Additions procedure used on the single source sample do not agree to within ± 5 percent of the value obtained by the routine atomic absorption analysis, then reanalyze all samples from the source using the Method of Standard Additions procedure.

11.4 Container No. 2 (Silica Gel). Weigh the spent silica gel (or silica gel plus impinger) to the nearest 0.5 g using a balance. (This step may be conducted in the field.)

12.0 Data Analysis and Calculations

Carry out calculations, retaining at least one extra decimal significant figure beyond that of the acquired data. Round off figures only after the final calculation. Other forms of the equations may be used as long as they give equivalent results.

12.1 Average Dry Gas Meter Temperature and Average Orifice Pressure Drop, Dry Gas Volume, Volume of Water Vapor Condensed, Moisture Content, and Isokinetic Variation. Same as Method 5, Sections 12.2 through 12.5 and 12.11, respectively.

12.2 Stack Gas Velocity. Using the data from this test and Equation 2-9 of Method 2, calculate the average stack gas velocity v_s .

12.3 Total Mercury.

12.3.1 For each source sample, correct the average maximum absorbance of the two consecutive samples whose peak heights agree within 3 percent of their average for the contribution of the solution blank (see Section 10.6.3). Use the calibration curve and these corrected averages to determine the final total weight of Hg in ng in the aeration cell for each source sample.

12.3.2 Correct for any dilutions made to bring the sample into the working range of the spectrophotometer. Then calculate the Hg in the original solution, m_{Hg} , as follows:

$$m_{\text{Hg}} = \left[C_{\text{Hg(AC)}} (DF)(V_r)(10^{-3}) \right] / S \quad \text{Eq. 101-1}$$

[View or download PDF](#)

Where:

$C_{\text{Hg(AC)}}$ = Total ng of Hg in aliquot analyzed (reagent blank subtracted).

DF = Dilution factor for the Hg-containing solution (before adding to the aeration cell; e.g., DF = 250/2 if the source samples were diluted as described in Section 11.2.2).

V_r = Solution volume of original sample, 1000 ml for samples diluted as described in Section 11.2.1.

10^{-3} = Conversion factor, $\mu\text{g}/\text{ng}$.

S = Aliquot volume added to aeration cell, ml.

12.4 Mercury Emission Rate. Calculate the daily Hg emission rate, R, using Equation 101-2. For continuous operations, the operating time is equal to 86,400 seconds per day. For cyclic operations, use only the time per day each stack is in operation. The total Hg emission rate from a source will be the summation of results from all stacks.

$$R = \frac{K m_{\text{Hg}} V_s A_s (86,400 \times 10^{-6})}{[V_{m(\text{std})} + V_{w(\text{std})}] (T_s / P_s)} \quad \text{Eq. 101-2}$$

[View or download PDF](#)

Where:

K_1 = 0.3858 °K/mm Hg for metric units.

K_1 = 17.64 °R/in. Hg for English units.

K_3 = 10^{-6} g/ μg for metric units.

= 2.2046 " × 10^{-9} lb/ μg for English units.

P_s = Absolute stack gas pressure, mm Hg (in. Hg).

t = Daily operating time, sec/day.

T_s = Absolute average stack gas temperature, °K (°R).

$V_{m(\text{std})}$ = Dry gas sample volume at standard conditions, scm (scf).

$V_{w(\text{std})}$ = Volume of water vapor at standard conditions, scm (scf).

12.5 Determination of Compliance. Each performance test consists of three repetitions of the applicable test method. For the purpose of determining compliance with an applicable national emission standard, use the average of the results of all repetitions.

13.0 Method Performance

The following estimates are based on collaborative tests, wherein 13 laboratories performed duplicate analyses on two Hg-containing samples from a chlor-alkali plant and on one laboratory-prepared sample of known Hg concentration. The sample concentrations ranged from 2 to 65 µg Hg/ml.

13.1 Precision. The estimated intra-laboratory and inter-laboratory standard deviations are 1.6 and 1.8 µg Hg/ml, respectively.

13.2 Accuracy. The participating laboratories that analyzed a 64.3 µg Hg/ml (in 0.1 M ICl) standard obtained a mean of 63.7 µg Hg/ml.

13.3 Analytical Range. After initial dilution, the range of this method is 0.5 to 120 µg Hg/ml. The upper limit can be extended by further dilution of the sample.

14.0 Pollution Prevention. [Reserved]

15.0 Waste Management. [Reserved]

16.0 Alternative Procedures

16.1 Alternative Analyzer. Samples may also be analyzed by cold vapor atomic fluorescence spectrometry.

17.0 References

Same as Method 5, Section 17.0, References 1-3, 5, and 6, with the addition of the following:

1. Determining Dust Concentration in a Gas Stream. ASME Performance Test Code No. 27. New York, NY. 1957.

2. DeVorkin, Howard, *et al.* Air Pollution Source Testing Manual. Air Pollution Control District. Los Angeles, CA. November 1963.

3. Hatch, W.R., and W.I. Ott. Determination of Sub-Microgram Quantities of Mercury by Atomic Absorption Spectrophotometry. *Anal. Chem.* 40:2085-87. 1968.

4. Mark, L.S. Mechanical Engineers' Handbook. McGraw-Hill Book Co., Inc. New York, NY. 1951.

5. Western Precipitation Division of Joy Manufacturing Co. Methods for Determination of Velocity, Volume, Dust and Mist Content of Gases. Bulletin WP-50. Los Angeles, CA. 1968.

6. Perry, J.H. Chemical Engineers' Handbook. McGraw-Hill Book Co., Inc. New York, NY. 1960.

7. Shigehara, R.T., W.F. Todd, and W.S. Smith. Significance of Errors in Stack Sampling Measurements. *Stack Sampling News.* 1(3):6-18. September 1973.

8. Smith, W.S., R.T. Shigehara, and W.F. Todd. A Method of Interpreting Stack Sampling Data. *Stack Sampling News*. 1(2):8-17. August 1973.

9. Standard Method for Sampling Stacks for Particulate Matter. In: 1971 Annual Book of ASTM Standards, Part 23. ASTM Designation D 2928-71. Philadelphia, PA 1971.

10. Vennard, J.K. *Elementary Fluid Mechanics*. John Wiley and Sons, Inc. New York. 1947.

11. Mitchell, W.J. and M.R. Midgett. Improved Procedure for Determining Mercury Emissions from Mercury Cell Chlor-Alkali Plants. *J. APCA*. 26:674-677. July 1976.

12. Shigehara, R.T. Adjustments in the EPA Nomograph for Different Pitot Tube Coefficients and Dry Molecular Weights. *Stack Sampling News*. 2:4-11. October 1974.

13. Vollaro, R.F. Recommended Procedure for Sample Traverses in Ducts Smaller than 12 Inches in Diameter. U.S. Environmental Protection Agency, Emission Measurement Branch. Research Triangle Park, NC. November 1976.

14. Klein, R. and C. Hach. *Standard Additions: Uses and Limitation in Spectrophotometric Measurements*. *Amer. Lab.* 9:21. 1977.

15. Perkin Elmer Corporation. *Analytical Methods for Atomic Absorption Spectrophotometry*. Norwalk, Connecticut. September 1976.

18.0 Tables, Diagrams, Flowcharts, and Validation Data

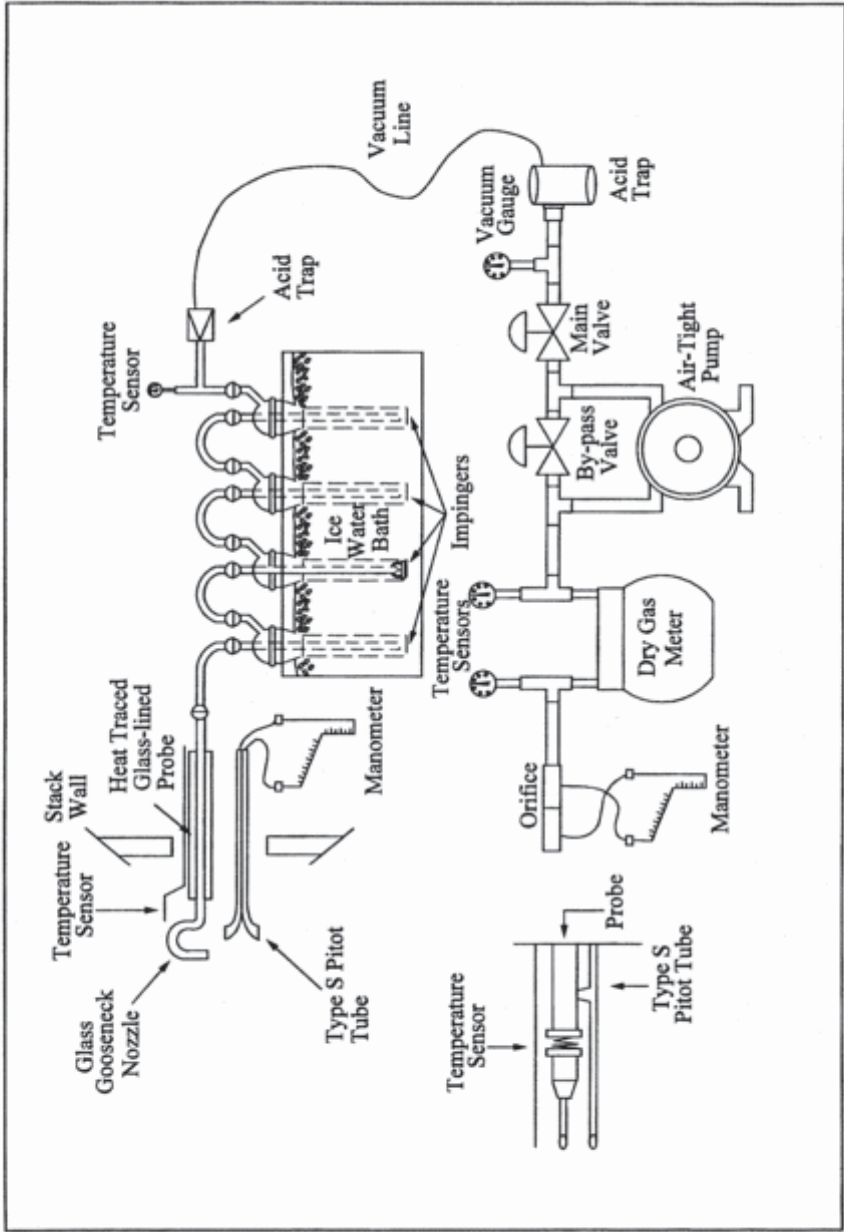

Figure 101-1. Mercury Sampling Train.

[View or download PDF](#)

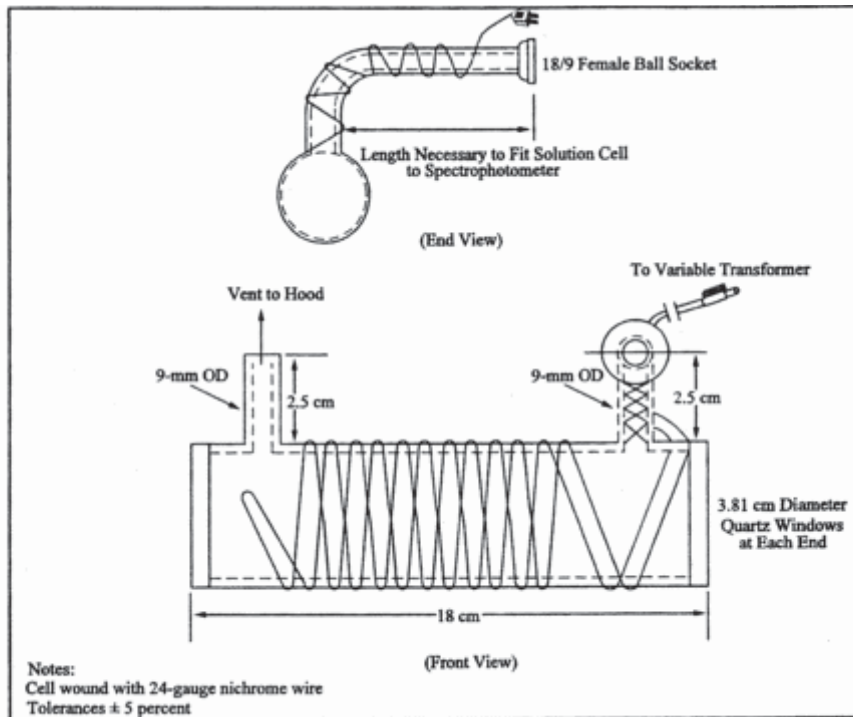

Figure 101-2. Optical Cell.

[View or download PDF](#)

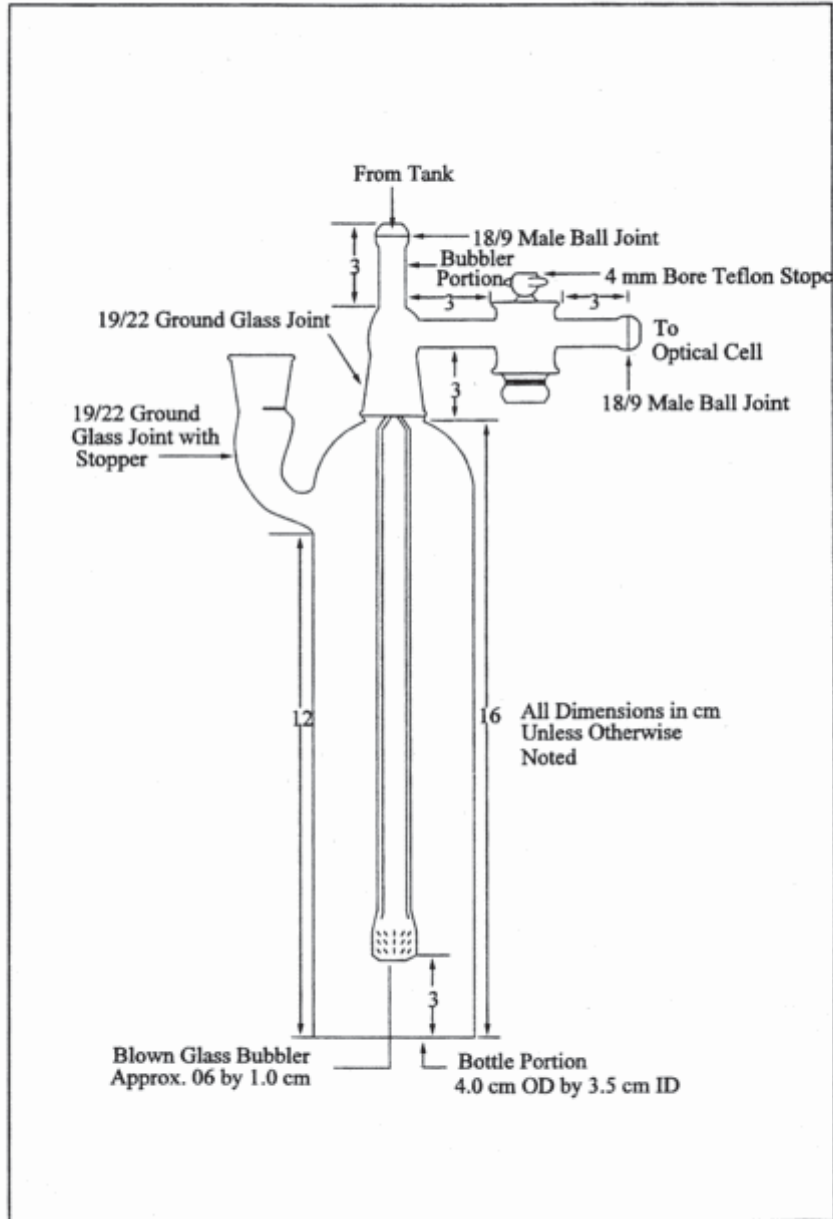

Figure 101-3. Aeration Cell.

[View or download PDF](#)

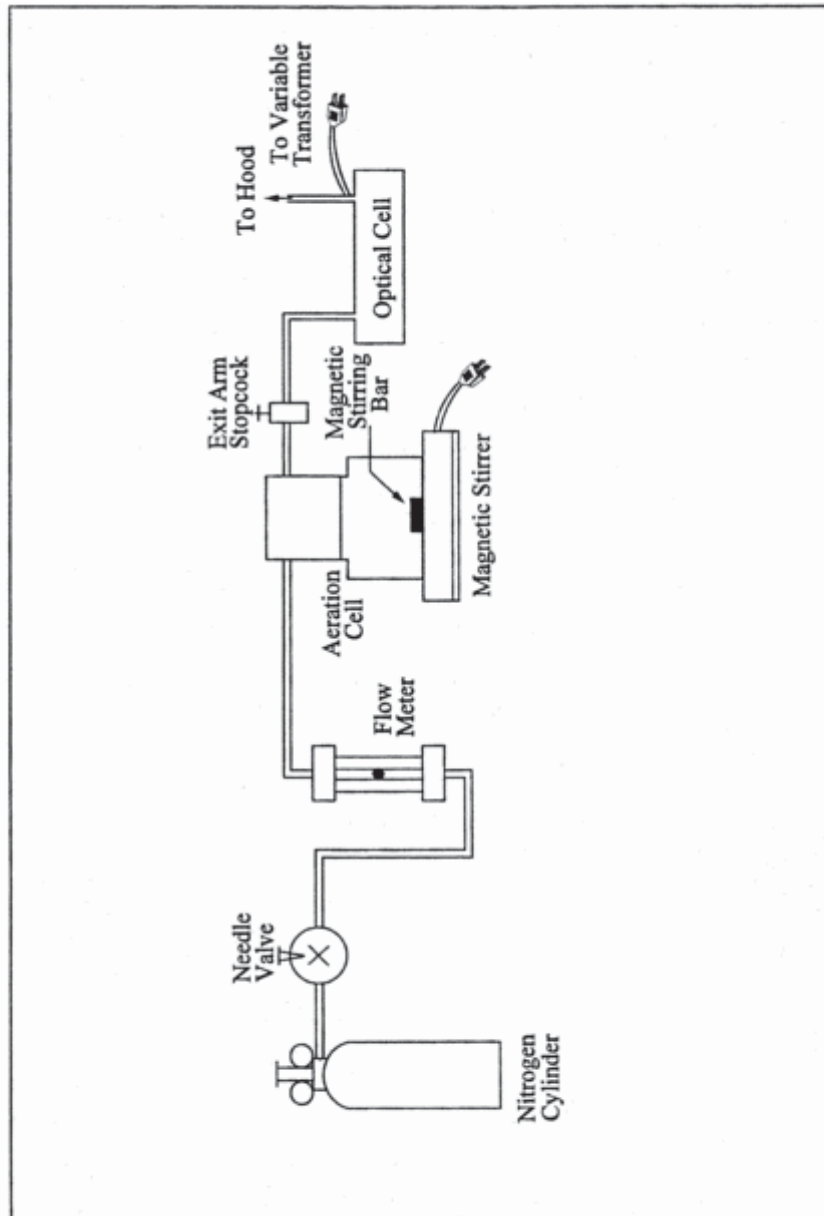

Figure 101-5. Schematic of Aeration System.

[View or download PDF](#)

METHOD 101A—DETERMINATION OF PARTICULATE AND GASEOUS MERCURY EMISSIONS FROM SEWAGE SLUDGE INCINERATORS

NOTE: This method does not include all of the specifications (e.g., equipment and supplies) and procedures (e.g., sampling and analytical) essential to its performance. Some material is incorporated by reference from methods in appendix A to 40 CFR part 60 and in this part. Therefore, to obtain reliable results, persons using this method should also have a thorough knowledge of at least the following additional test methods: Methods 1, Method 2, Method 3, and Method 5 of part 60 (appendix A), and Method 101 part 61 (appendix B).

1.0 Scope and Application

1.1 Analytes.

Analyte	CAS No.	Sensitivity
Mercury (Hg)	7439-97-6	Dependent upon spectrophotometer and recorder.

1.2 Applicability. This method is applicable for the determination of Hg emissions from sewage sludge incinerators and other sources as specified in an applicable subpart of the regulations.

1.3 Data Quality Objectives. Adherence to the requirements of this method will enhance the quality of the data obtained from air pollutant sampling methods.

2.0 Summary of Method

2.1 Particulate and gaseous Hg emissions are withdrawn isokinetically from the source and are collected in acidic potassium permanganate (KMnO₄) solution. The Hg collected (in the mercuric form) is reduced to elemental Hg, which is then aerated from the solution into an optical cell and measured by atomic absorption spectrophotometry.

3.0 Definitions. [Reserved]

4.0 Interferences

4.1 Sample Collection. Excessive oxidizable organic matter in the stack gas prematurely depletes the KMnO₄ solution and thereby prevents further collection of Hg.

4.2 Analysis. Condensation of water vapor on the optical cell windows causes a positive interference.

5.0 Safety

5.1 Disclaimer. This method may involve hazardous materials, operations, and equipment. This test method may not address all of the safety problems associated with its use. It is the responsibility of the user of this test method to establish appropriate safety and health practices and determine the applicability of regulatory limitations prior to performing this test method.

5.2 Corrosive Reagents. The following reagents are hazardous. Personal protective equipment and safe procedures are useful in preventing chemical splashes. If contact occurs, immediately flush with copious amounts of water for at least 15 minutes. Remove clothing under shower and decontaminate. Treat residual chemical burns as thermal burns.

5.2.1 Hydrochloric Acid (HCl). Highly toxic. Vapors are highly irritating to eyes, skin, nose, and lungs, causing severe damage. May cause bronchitis, pneumonia, or edema of lungs. Exposure to concentrations of 0.13 to 0.2 percent can be lethal to humans in a few minutes. Provide ventilation to limit exposure. Reacts with metals, producing hydrogen gas.

5.2.2 Nitric Acid (HNO₃). Highly corrosive to eyes, skin, nose, and lungs. Vapors cause bronchitis, pneumonia, or edema of lungs. Reaction to inhalation may be delayed as long as 30 hours and still be fatal. Provide ventilation to limit exposure. Strong oxidizer. Hazardous reaction may occur with organic materials such as solvents.

5.2.3 Sulfuric acid (H_2SO_4). Rapidly destructive to body tissue. Will cause third degree burns. Eye damage may result in blindness. Inhalation may be fatal from spasm of the larynx, usually within 30 minutes. May cause lung tissue damage with edema. 3 mg/m^3 will cause lung damage in uninitiated. 1 mg/m^3 for 8 hours will cause lung damage or, in higher concentrations, death. Provide ventilation to limit inhalation. Reacts violently with metals and organics.

5.3 Chlorine Evolution. Hydrochloric acid reacts with KMnO_4 to liberate chlorine gas. Although this is a minimal concern when small quantities of HCl (5-10 ml) are used in the impinger rinse, a potential safety hazard may still exist. At sources that emit higher concentrations of oxidizable materials (e.g., power plants), more HCl may be required to remove the larger amounts of brown deposit formed in the impingers. In such cases, the potential safety hazards due to sample container pressurization are greater, because of the larger volume of HCl rinse added to the recovered sample. These hazards are eliminated by storing and analyzing the HCl impinger wash separately from the permanganate impinger sample.

6.0 Equipment and Supplies

6.1 Sample Collection and Sample Recovery. Same as Method 101, Sections 6.1 and 6.2, respectively, with the following exceptions:

6.1.1 Probe Liner. Same as in Method 101, Section 6.1.2, except that if a filter is used ahead of the impingers, the probe heating system must be used to minimize the condensation of gaseous Hg.

6.1.2 Filter Holder (Optional). Borosilicate glass with a rigid stainless-steel wire-screen filter support (do not use glass frit supports) and a silicone rubber or Teflon gasket, designed to provide a positive seal against leakage from outside or around the filter. The filter holder must be equipped with a filter heating system capable of maintaining a temperature around the filter holder of $120 \pm 14 \text{ }^\circ\text{C}$ ($248 \pm 25 \text{ }^\circ\text{F}$) during sampling to minimize both water and gaseous Hg condensation. A filter may also be used in cases where the stream contains large quantities of particulate matter.

6.2 Sample Analysis. Same as Method 101, Section 6.3, with the following additions and exceptions:

6.2.1 Volumetric Pipets. Class A; 1-, 2-, 3-, 4-, 5-, 10-, and 20-ml.

6.2.2 Graduated Cylinder. 25-ml.

6.2.3 Steam Bath.

6.2.4 Atomic Absorption Spectrophotometer or Equivalent. Any atomic absorption unit with an open sample presentation area in which to mount the optical cell is suitable. Instrument settings recommended by the particular manufacturer should be followed. Instruments designed specifically for the measurement of mercury using the cold-vapor technique are commercially available and may be substituted for the atomic absorption spectrophotometer.

6.2.5 Optical Cell. Alternatively, a heat lamp mounted above the cell or a moisture trap installed upstream of the cell may be used.

6.2.6 Aeration Cell. Alternatively, aeration cells available with commercial cold vapor instrumentation may be used.

6.2.7 Aeration Gas Cylinder. Nitrogen, argon, or dry, Hg-free air, equipped with a single-stage regulator. Alternatively, aeration may be provided by a peristaltic metering pump. If a commercial cold vapor instrument is used, follow the manufacturer's recommendations.

7.0 Reagents and Standards

Unless otherwise indicated, it is intended that all reagents conform to the specifications established by the Committee on Analytical Reagents of the American Chemical Society, where such specifications are available; otherwise, use the best available grade.

7.1 Sample Collection and Recovery. The following reagents are required for sample collection and recovery:

7.1.1 Water. Deionized distilled, to conform to ASTM D 1193-77 or 91 Type 1. If high concentrations of organic matter are not expected to be present, the analyst may eliminate the KMnO_4 test for oxidizable organic matter. Use this water in all dilutions and solution preparations.

7.1.2 Nitric Acid, 50 Percent (V/V). Mix equal volumes of concentrated HNO_3 and water, being careful to add the acid to the water slowly.

7.1.3 Silica Gel. Indicating type, 6 to 16 mesh. If previously used, dry at $175\text{ }^\circ\text{C}$ ($350\text{ }^\circ\text{F}$) for 2 hours. New silica gel may be used as received.

7.1.4 Filter (Optional). Glass fiber filter, without organic binder, exhibiting at least 99.95 percent efficiency on $0.3\text{-}\mu\text{m}$ dioctyl phthalate smoke particles. The filter in cases where the gas stream contains large quantities of particulate matter, but blank filters should be analyzed for Hg content.

7.1.5 Sulfuric Acid, 10 Percent (V/V). Carefully add and mix 100 ml of concentrated H_2SO_4 to 900 ml of water.

7.1.6 Absorbing Solution, 4 Percent KMnO_4 (W/V). Prepare fresh daily. Dissolve 40 g of KMnO_4 in sufficient 10 percent H_2SO_4 to make 1 liter. Prepare and store in glass bottles to prevent degradation.

7.1.7 Hydrochloric Acid, 8 N. Carefully add and mix 67 ml of concentrated HCl to 33 ml of water.

7.2 Sample Analysis. The following reagents and standards are required for sample analysis:

7.2.1 Water. Same as in Section 7.1.1.

7.2.2 Tin (II) Solution. Prepare fresh daily, and keep sealed when not being used. Completely dissolve 20 g of tin (II) chloride (or 25 g of tin (II) sulfate) crystals (Baker Analyzed reagent grade or any other brand that will give a clear solution) in 25 ml of concentrated HCl. Dilute to 250 ml with water. Do not substitute HNO_3 , H_2SO_4 , or other strong acids for the HCl.

7.2.3 Sodium Chloride-Hydroxylamine Solution. Dissolve 12 g of sodium chloride and 12 g of hydroxylamine sulfate (or 12 g of hydroxylamine hydrochloride) in water and dilute to 100 ml.

7.2.4 Hydrochloric Acid, 8 N. Same as Section 7.1.7.

7.2.5 Nitric Acid, 15 Percent (V/V). Carefully add 15 ml HNO_3 to 85 ml of water.

7.2.6 Antifoam B Silicon Emulsion. J.T. Baker Company (or equivalent).

7.2.7 Mercury Stock Solution, 1 mg Hg/ml. Prepare and store all Hg standard solutions in borosilicate glass containers. Completely dissolve 0.1354 g of Hg (II) chloride in 75 ml of water. Add 10 ml of concentrated HNO₃, and adjust the volume to exactly 100 ml with water. Mix thoroughly. This solution is stable for at least one month.

7.2.8 Intermediate Hg Standard Solution, 10 µg/ml. Prepare fresh weekly. Pipet 5.0 ml of the Hg stock solution (Section 7.2.7) into a 500 ml volumetric flask, and add 20 ml of 15 percent HNO₃ solution. Adjust the volume to exactly 500 ml with water. Thoroughly mix the solution.

7.2.9 Working Hg Standard Solution, 200 ng Hg/ml. Prepare fresh daily. Pipet 5.0 ml from the "Intermediate Hg Standard Solution" (Section 7.2.8) into a 250-ml volumetric flask. Add 5 ml of 4 percent KMnO₄ absorbing solution and 5 ml of 15 percent HNO₃. Adjust the volume to exactly 250 ml with water. Mix thoroughly.

7.2.10 Potassium Permanganate, 5 Percent (W/V). Dissolve 5 g of KMnO₄ in water and dilute to 100 ml.

7.2.11 Filter. Whatman No. 40, or equivalent.

8.0 Sample Collection, Preservation, Transport, and Storage

Same as Method 101, Section 8.0, with the exception of the following:

8.1 Preliminary Determinations. Same as Method 101, Section 8.2, except that the liberation of free iodine in the first impinger due to high Hg or sulfur dioxide concentrations is not applicable. In this method, high oxidizable organic content may make it impossible to sample for the desired minimum time. This problem is indicated by the complete bleaching of the purple color of the KMnO₄ solution. In cases where an excess of water condensation is encountered, collect two runs to make one sample, or add an extra impinger in front of the first impinger (also containing acidified KMnO₄ solution).

8.2 Preparation of Sampling Train. Same as Method 101, Section 8.3, with the exception of the following:

8.2.1 In this method, clean all the glass components by rinsing with 50 percent HNO₃, tap water, 8 N HCl, tap water, and finally with deionized distilled water. Then place 50 ml of absorbing solution in the first impinger and 100 ml in each of the second and third impingers.

8.2.2 If a filter is used, use a pair of tweezers to place the filter in the filter holder. Be sure to center the filter, and place the gasket in the proper position to prevent the sample gas stream from bypassing the filter. Check the filter for tears after assembly is completed. Be sure also to set the filter heating system at the desired operating temperature after the sampling train has been assembled.

8.3 Sampling Train Operation. In addition to the procedure outlined in Method 101, Section 8.5, maintain a temperature around the filter (if applicable) of 120 ±14 °C (248 ±25 °F).

8.4 Sample Recovery. Same as Method 101, Section 8.7, with the exception of the following:

8.4.1 Transfer the probe, impinger assembly, and (if applicable) filter assembly to the cleanup area.

8.4.2 Treat the sample as follows:

8.4.2.1 Container No. 1 (Impinger, Probe, and Filter Holder) and, if applicable, Container No. 1A (HCl rinse).

8.4.2.1.1 Using a graduated cylinder, measure the liquid in the first three impingers to within 1 ml. Record the volume of liquid present (e.g., see Figure 5-6 of Method 5). This information is needed to calculate the moisture content of the effluent gas. (Use only graduated cylinder and glass storage bottles that have been precleaned as in Section 8.2.1.) Place the contents of the first three impingers (four if an extra impinger was added as described in Section 8.1) into a 1000-ml glass sample bottle labeled Container No. 1.

NOTE: If a filter is used, remove the filter from its holder as outlined under Section 8.4.3.

8.4.2.1.2 Taking care that dust on the outside of the probe or other exterior surfaces does not get into the sample, quantitatively recover the Hg (and any condensate) from the probe nozzle, probe fitting, probe liner, front half of the filter holder (if applicable), and impingers as follows: Rinse these components with a total of 400 ml (350 ml if an extra impinger was added as described in Section 8.1) of fresh absorbing solution, carefully assuring removal of all loose particulate matter from the impingers; add all washings to the 1000 ml glass sample bottle. To remove any residual brown deposits on the glassware following the permanganate rinse, rinse with approximately 100 ml of water, carefully assuring removal of all loose particulate matter from the impingers. Add this rinse to Container No. 1.

8.4.2.1.3 If no visible deposits remain after this water rinse, do not rinse with 8 N HCl. If deposits do remain on the glassware after the water rinse, wash impinger walls and stems with 25 ml of 8 N HCl, and place the wash in a separate container labeled Container No. 1A as follows: Place 200 ml of water in a sample container labeled Container No. 1A. Wash the impinger walls and stem with the HCl by turning the impinger on its side and rotating it so that the HCl contacts all inside surfaces. Pour the HCl wash carefully with stirring into Container No. 1A.

8.4.2.1.4 After all washings have been collected in the appropriate sample container(s), tighten the lid(s) on the container(s) to prevent leakage during shipment to the laboratory. Mark the height of the fluid level to allow subsequent determination of whether leakage has occurred during transport. Label each container to identify its contents clearly.

8.4.3 Container No. 2 (Silica Gel). Same as Method 5, Section 8.7.6.3.

8.4.4 Container No. 3 (Filter). If a filter was used, carefully remove it from the filter holder, place it in a 100-ml glass sample bottle, and add 20 to 40 ml of absorbing solution. If it is necessary to fold the filter, be sure that the particulate cake is inside the fold. Carefully transfer to the 100-ml sample bottle any particulate matter and filter fibers that adhere to the filter holder gasket by using a dry Nylon bristle brush and a sharp-edged blade. Seal the container. Label the container to identify its contents clearly. Mark the height of the fluid level to allow subsequent determination of whether leakage has occurred during transport.

8.4.5 Container No. 4 (Filter Blank). If a filter was used, treat an unused filter from the same filter lot as that used for sampling according to the procedures outlined in Section 8.4.4.

8.4.6 Container No. 5 (Absorbing Solution Blank). Place 650 ml of 4 percent KMnO_4 absorbing solution in a 1000-ml sample bottle. Seal the container.

8.4.7 Container No. 6 (HCl Rinse Blank). Place 200 ml of water in a 1000-ml sample bottle, and add 25 ml of 8 N HCl carefully with stirring. Seal the container. Only one blank sample per 3 runs is required.

9.0 Quality Control

9.1 Miscellaneous Quality Control Measures.

Section	Quality control measure	Effect
8.0, 10.0	Sampling equipment leak-checks and calibration	Ensure accuracy and precision of sampling measurements.
10.2	Spectrophotometer calibration	Ensure linearity of spectrophotometer response to standards.
11.3.3	Check for matrix effects	Eliminate matrix effects.

9.2 Volume Metering System Checks. Same as Method 5, Section 9.2.

10.0 Calibration and Standardization

Same as Method 101, Section 10.0, with the following exceptions:

10.1 Optical Cell Heating System Calibration. Same as in Method 101, Section 10.4, except use a 25 ml graduated cylinder to add 25 ml of water to the bottle section of the aeration cell.

10.2 Spectrophotometer and Recorder Calibration.

10.2.1 The Hg response may be measured by either peak height or peak area.

NOTE: The temperature of the solution affects the rate at which elemental Hg is released from a solution and, consequently, it affects the shape of the absorption curve (area) and the point of maximum absorbance (peak height). To obtain reproducible results, all solutions must be brought to room temperature before use.

10.2.2 Set the spectrophotometer wave length at 253.7 nm, and make certain the optical cell is at the minimum temperature that will prevent water condensation. Then set the recorder scale as follows: Using a 25-ml graduated cylinder, add 25 ml of water to the aeration cell bottle. Add three drops of Antifoam B to the bottle, and then pipet 5.0 ml of the working Hg standard solution into the aeration cell.

NOTE: Always add the Hg-containing solution to the aeration cell after the 25 ml of water.

10.2.3 Place a Teflon-coated stirring bar in the bottle. Add 5 ml of absorbing solution to the aeration bottle, and mix well. Before attaching the bottle section to the bubbler section of the aeration cell, make certain that (1) the aeration cell exit arm stopcock (Figure 101-3 of Method 101) is closed (so that Hg will not prematurely enter the optical cell when the reducing agent is being added) and (2) there is no flow through the bubbler. If conditions (1) and (2) are met, attach the bottle section to the bubbler section of the aeration cell. Add sodium chloride-hydroxylamine in 1 ml increments until the solution is colorless. Now add 5 ml of tin (II) solution to the aeration bottle through the side arm, and immediately stopper the side arm. Stir the solution for 15 seconds, turn on the recorder, open the aeration cell exit arm stopcock, and immediately initiate aeration with continued stirring. Determine the maximum absorbance of the standard, and set this value to read 90 percent of the recorder full scale.

11.0 Analytical Procedure

11.1 Sample Loss Check. Check the liquid level in each container to see if liquid was lost during transport. If a noticeable amount of leakage occurred, either void the sample or use methods subject to the approval of the Administrator to account for the losses.

11.2 Sample Preparation. Treat sample containers as follows:

11.2.1 Containers No. 3 and No. 4 (Filter and Filter Blank).

11.2.1.1 If a filter is used, place the contents, including the filter, of Containers No. 3 and No. 4 in separate 250-ml beakers, and heat the beakers on a steam bath until most of the liquid has evaporated. Do not heat to dryness. Add 20 ml of concentrated HNO₃ to the beakers, cover them with a watch glass, and heat on a hot plate at 70 °C (160 °F) for 2 hours. Remove from the hot plate.

11.2.1.2 Filter the solution from digestion of the Container No. 3 contents through Whatman No. 40 filter paper, and save the filtrate for addition to the Container No. 1 filtrate as described in Section 11.2.2. Discard the filter paper.

11.2.1.3 Filter the solution from digestion of the Container No. 4 contents through Whatman No. 40 filter paper, and save the filtrate for addition to Container No. 5 filtrate as described in Section 11.2.3 below. Discard the filter paper.

11.2.2 Container No. 1 (Impingers, Probe, and Filter Holder) and, if applicable, No. 1A (HCl rinse).

11.2.2.1 Filter the contents of Container No. 1 through Whatman No. 40 filter paper into a 1 liter volumetric flask to remove the brown manganese dioxide (MnO₂) precipitate. Save the filter for digestion of the brown MnO₂ precipitate. Add the sample filtrate from Container No. 3 to the 1-liter volumetric flask, and dilute to volume with water. If the combined filtrates are greater than 1000 ml, determine the volume to the nearest ml and make the appropriate corrections for blank subtractions. Mix thoroughly. Mark the filtrate as analysis Sample No. A.1 and analyze for Hg within 48 hr of the filtration step. Place the saved filter, which was used to remove the brown MnO₂ precipitate, into an appropriate sized container. In a laboratory hood, add 25 ml of 8 N HCl to the filter and allow to digest for a minimum of 24 hours at room temperature.

11.2.2.2 Filter the contents of Container 1A through Whatman No. 40 filter paper into a 500-ml volumetric flask. Then filter the digestate of the brown MnO₂ precipitate from Container No. 1 through Whatman No. 40 filter paper into the same 500-ml volumetric flask, and dilute to volume with water. Mark this combined 500 ml dilute solution as analysis Sample No. A.2. Discard the filters.

11.2.3 Container No. 5 (Absorbing Solution Blank) and No. 6 (HCl Rinse Blank).

11.2.3.1 Treat Container No. 5 as Container No. 1 (as described in Section 11.2.2), except substitute the filter blank filtrate from Container No. 4 for the sample filtrate from Container No. 3, and mark as Sample A.1 Blank.

11.2.3.2 Treat Container No. 6 as Container No. 1A, (as described in Section 11.2.2, except substitute the filtrate from the digested blank MnO₂ precipitate for the filtrate from the digested sample MnO₂ precipitate, and mark as Sample No. A.2 Blank.

NOTE: When analyzing samples A.1 Blank and HCl A.2 Blank, always begin with 10 ml aliquots. This applies specifically to blank samples.

11.3 Analysis. Calibrate the analytical equipment and develop a calibration curve as outlined in Section 10.0.

11.3.1 Mercury Samples. Then repeat the procedure used to establish the calibration curve with appropriately sized aliquots (1 to 10 ml) of the samples (from Sections 11.2.2 and 11.2.3) until two consecutive peak heights agree within 3 percent of their average value. If the 10 ml sample is below the

detectable limit, use a larger aliquot (up to 20 ml), but decrease the volume of water added to the aeration cell accordingly to prevent the solution volume from exceeding the capacity of the aeration bottle. If the peak maximum of a 1.0 ml aliquot is off scale, further dilute the original sample to bring the Hg concentration into the calibration range of the spectrophotometer. If the Hg content of the absorbing solution and filter blank is below the working range of the analytical method, use zero for the blank.

11.3.2 Run a blank and standard at least after every five samples to check the spectrophotometer calibration; recalibrate as necessary.

11.3.3 Check for Matrix Effects (optional). Same as Method 101, Section 11.3.3.

12.0 Data Analysis and Calculations

NOTE: Carry out calculations, retaining at least one extra decimal significant figure beyond that of the acquired data. Round off figures only after the final calculation. Other forms of the equations may be used as long as they give equivalent results.

12.1 Nomenclature.

$C_{(ftr)Hg}$ = Total ng of Hg in aliquot of $KMnO_4$ filtrate and HNO_3 digestion of filter analyzed (aliquot of analysis Sample No. A.1).

$C_{(ftr\ blk)Hg}$ = Total ng of Hg in aliquot of $KMnO_4$ blank and HNO_3 digestion of blank filter analyzed (aliquot of analysis Sample No. A.1 blank).

$C_{(HCl\ blk)Hg}$ = Total ng of Hg analyzed in aliquot of the 500-ml analysis Sample No. HCl A.2 blank.

$C_{(HCl)Hg}$ = Total ng of Hg analyzed in the aliquot from the 500-ml analysis Sample No. HCl A.2.

DF = Dilution factor for the HCl-digested Hg-containing solution, Analysis Sample No. "HCl A.2."

DF_{blk} = Dilution factor for the HCl-digested Hg containing solution, Analysis Sample No. "HCl A.2 blank."
(Refer to sample No. "HCl A.2" dilution factor above.)

$m_{(ftr)Hg}$ = Total blank corrected μg of Hg in $KMnO_4$ filtrate and HNO_3 digestion of filter sample.

$m_{(HCl)Hg}$ = Total blank corrected μg of Hg in HCl rinse and HCl digestate of filter sample.

m_{Hg} = Total blank corrected Hg content in each sample, μg .

S = Aliquot volume of sample added to aeration cell, ml.

S_{blk} = Aliquot volume of blank added to aeration cell, ml.

V_{f(blk)} = Solution volume of blank sample, 1000 ml for samples diluted as described in Section 11.2.2.

V_{f(ftr)} = Solution volume of original sample, normally 1000 ml for samples diluted as described in Section 11.2.2.

V_{f(HCl)} = Solution volume of original sample, 500 ml for samples diluted as described in Section 11.2.1.

10^{-3} = Conversion factor, $\mu g/ng$.

12.2 Average Dry Gas Meter Temperature and Average Orifice Pressure Drop, Dry Gas Volume, Volume of Water Vapor Condensed, Moisture Content, Isokinetic Variation, and Stack Gas Velocity and Volumetric Flow Rate. Same as Method 5, Sections 12.2 through 12.5, 12.11, and 12.12, respectively.

12.3 Total Mercury.

12.3.1 For each source sample, correct the average maximum absorbance of the two consecutive samples whose peak heights agree within 3 percent of their average for the contribution of the blank. Use the calibration curve and these corrected averages to determine the final total weight of Hg in ng in the aeration cell for each source sample.

12.3.2 Correct for any dilutions made to bring the sample into the working range of the spectrophotometer.

$$m_{(\text{HCl})\text{Hg}} = \frac{[C_{(\text{HCl})\text{Hg}} \text{DF}]}{S} - \frac{[C_{(\text{HCl}\text{blk})\text{Hg}} \text{DF}_{\text{blk}}]}{S_{\text{blk}}} V_{f(\text{HCl})} (10^{-3}) \quad \text{Eq. 101A-1}$$

[View or download PDF](#)

NOTE: This dilution factor applies only to the intermediate dilution steps, since the original sample volume $[(V)_{\text{HCl}}]$ of "HCl A.2" has been factored out in the equation along with the sample aliquot (S). In Eq. 101A-1, the sample aliquot, S, is introduced directly into the aeration cell for analysis according to the procedure outlined in Section 11.3.1. A dilution factor is required only if it is necessary to bring the sample into the analytical instrument's calibration range.

NOTE: The maximum allowable blank subtraction for the HCl is the lesser of the two following values: (1) the actual blank measured value (analysis Sample No. HCl A.2 blank), or (2) 5% of the Hg content in the combined HCl rinse and digested sample (analysis Sample No. HCl A.2).

$$m_{(\text{fir})\text{Hg}} = \frac{[C_{(\text{fir})\text{Hg}} \text{DF} V_{f(\text{fir})}]}{S} - \frac{[C_{(\text{fir}\text{blk})\text{Hg}} \text{DF}_{\text{blk}} V_{f(\text{blk})}]}{S_{\text{blk}}} \quad \text{Eq. 101A-2}$$

[View or download PDF](#)

NOTE: The maximum allowable blank subtraction for the HCl is the lesser of the two following values: (1) the actual blank measured value (analysis Sample No. "A.1 blank"), or (2) 5% of the Hg content in the filtrate (analysis Sample No. "A.1").

$$m_{\text{Hg}} = m_{(\text{HCl})\text{Hg}} + m_{(\text{fir})\text{Hg}} \quad \text{Eq. 101A-3}$$

[View or download PDF](#)

12.3 Mercury Emission Rate. Same as Method 101, Section 12.3.

12.4 Determination of Compliance. Same as Method 101, Section 12.4.

13.0 Method Performance

13.1 Precision. Based on eight paired-train tests, the intra-laboratory standard deviation was estimated to be 4.8 $\mu\text{g}/\text{ml}$ in the concentration range of 50 to 130 $\mu\text{g}/\text{m}^3$.

13.2 Bias. [Reserved]

13.3 Range. After initial dilution, the range of this method is 20 to 800 ng Hg/ml. The upper limit can be extended by further dilution of the sample.

14.0 Pollution Prevention [Reserved]

15.0 Waste Management [Reserved]

16.0 Alternative Procedures

16.1 Alternative Analyzers.

16.1.1 Inductively coupled plasma-atomic emission spectrometry (ICP-AES) may be used as an alternative to atomic absorption analysis provided the following conditions are met:

16.1.1.1 Sample collection, sample preparation, and analytical preparation procedures are as defined in the method except as necessary for the ICP-AES application.

16.1.1.2 The quality control procedures are conducted as prescribed.

16.1.1.3 The limit of quantitation for the ICP-AES must be demonstrated and the sample concentrations reported should be no less than two times the limit of quantitation. The limit of quantitation is defined as ten times the standard deviation of the blank value. The standard deviation of the blank value is determined from the analysis of seven blanks. It has been reported that for mercury and those elements that form hydrides, a continuous-flow generator coupled to an ICP-AES offers detection limits comparable to cold vapor atomic absorption.

16.1.2 Samples may also be analyzed by cold vapor atomic fluorescence spectrometry.

17.0 References

Same as Section 16.0 of Method 101, with the addition of the following:

1. Mitchell, W.J., *et al.* Test Methods to Determine the Mercury Emissions from Sludge Incineration Plants. U.S. Environmental Protection Agency. Research Triangle Park, NC. Publication No. EPA-600/4-79-058. September 1979.

2. Wilshire, Frank W., *et al.* Reliability Study of the U.S. EPA's Method 101A—Determination of Particulate and Gaseous Mercury Emissions. U.S. Environmental Protection Agency. Research Triangle Park, NC. Report No. 600/D-31/219 AREAL 367, NTIS Acc No. PB91-233361.

3. Memorandum from William J. Mitchell to Roger T. Shigehara discussing the potential safety hazard in Section 7.2 of Method 101A. February 28, 1990.

18.0 Tables, Diagrams, Flowcharts, And Validation Data [Reserved]

METHOD 102—DETERMINATION OF PARTICULATE AND GASEOUS MERCURY EMISSIONS FROM CHLOR-ALKALI PLANTS (HYDROGEN STREAMS)

NOTE: This method does not include all of the specifications (*e.g.*, equipment and supplies) and procedures (*e.g.*, sampling and analytical) essential to its performance. Some material is incorporated by reference from other methods in this part and in appendix A to 40 CFR part 60. Therefore, to obtain reliable results, persons using this method should have a thorough knowledge of at least the following additional test methods: Method 1, Method 2, Method 3, Method 5, and Method 101.

1.0 Scope and Application

1.1 Analytes.

Analyte	CAS No.	Sensitivity
Mercury (Hg)	7439-97-6	Dependent upon recorder and spectrophotometer.

1.2 **Applicability.** This method is applicable for the determination of Hg emissions, including both particulate and gaseous Hg, from chlor-alkali plants and other sources (as specified in the regulations) where the carrier-gas stream in the duct or stack is principally hydrogen.

1.3 **Data Quality Objectives.** Adherence to the requirements of this method will enhance the quality of the data obtained from air pollutant sampling methods.

2.0 Summary of Method

2.1 Particulate and gaseous Hg emissions are withdrawn isokinetically from the source and collected in acidic iodine monochloride (ICl) solution. The Hg collected (in the mercuric form) is reduced to elemental Hg, which is then aerated from the solution into an optical cell and measured by atomic absorption spectrophotometry.

3.0 Definitions [Reserved]

4.0 Interferences

Same as Method 101, Section 4.2.

5.0 Safety

5.1 **Disclaimer.** This method may involve hazardous materials, operations, and equipment. This test method may not address all of the safety problems associated with its use. It is the responsibility of the user of this test method to establish appropriate safety and health practices and determine the applicability of regulatory limitations prior to performing this test method.

5.2 **Corrosive Reagents.** Same as Method 101, Section 5.2.

5.3 **Explosive Mixtures.** The sampler must conduct the source test under conditions of utmost safety because hydrogen and air mixtures are explosive. Since the sampling train essentially is leakless, attention to safe operation can be concentrated at the inlet and outlet. If a leak does occur, however, remove the meter box cover to avoid a possible explosive mixture. The following specific precautions are recommended:

5.3.1 Operate only the vacuum pump during the test. The other electrical equipment, e.g., heaters, fans, and timers, normally are not essential to the success of a hydrogen stream test.

5.3.2 Seal the sample port to minimize leakage of hydrogen from the stack.

5.3.3 Vent sampled hydrogen at least 3 m (10 ft) away from the train. This can be accomplished by attaching a 13-mm (0.50-in.) ID Tygon tube to the exhaust from the orifice meter.

NOTE: A smaller ID tubing may cause the orifice meter calibration to be erroneous. Take care to ensure that the exhaust line is not bent or pinched.

6.0 Equipment and Supplies

Same as Method 101, Section 6.0, with the exception of the following:

6.1 Probe Heating System. Do not use, unless otherwise specified.

6.2 Glass Fiber Filter. Do not use, unless otherwise specified.

7.0 Reagents and Standards

Same as Method 101, Section 7.0.

8.0 Sample Collection, Preservation, Transport, and Storage

Same as Method 101, Section 8.0, with the exception of the following:

8.1 Setting of Isokinetic Rates.

8.1.1 If a nomograph is used, take special care in the calculation of the molecular weight of the stack gas and in the setting of the nomograph to maintain isokinetic conditions during sampling (Sections 8.1.1.1 through 8.1.1.3 below).

8.1.1.1 Calibrate the meter box orifice. Use the techniques described in APTD-0576 (see Reference 9 in Section 17.0 of Method 5 of appendix A to part 60). Calibration of the orifice meter at flow conditions that simulate the conditions at the source is suggested. Calibration should either be done with hydrogen or with some other gas having a similar Reynolds Number so that there is similarity between the Reynolds Numbers during calibration and during sampling. Alternative mercury-free thermometers may be used if the thermometers are, at a minimum, equivalent in terms of performance or suitably effective for the specific temperature measurement application.

8.1.1.2 The nomograph described in APTD-0576 cannot be used to calculate the C factor because the nomograph is designed for use when the stack gas dry molecular weight is 29 ± 4 . Instead, the following calculation should be made to determine the proper C factor:

$$C = 0.00154 \Delta H_{\text{H}_2\text{O}} @ C_p \sqrt{T_m} (P_s/P_m) \frac{(1 - B_{ws})^2}{(1 - B_{ws}) + 18B_{ws}} \quad \text{Eq. 102-1}$$

[View or download PDF](#)

Where:

B_{ws} = Fraction by volume of water vapor in the stack gas.

C_p = Pitot tube calibration coefficient, dimensionless.

M_d = Dry molecular weight of stack gas, lb/lb-mole.

P_s = Absolute pressure of stack gas, in. Hg.

P_m = Absolute pressure of gas at the meter, in. Hg.

T_m = Absolute temperature of gas at the orifice, °R.

$\Delta H_{\text{H}_2\text{O}}$ = Meter box calibration factor obtained in Section 8.1.1.1, in. H₂O.

0.00154 = (in. H₂O/°R).

NOTE: This calculation is left in English units, and is not converted to metric units because nomographs are based on English units.

8.1.1.3 Set the calculated C factor on the operating nomograph, and select the proper nozzle diameter and K factor as specified in APTD-0576. If the C factor obtained in Section 8.1.1.2 exceeds the values specified on the existing operating nomograph, expand the C scale logarithmically so that the values can be properly located.

8.1.2 If a calculator is used to set isokinetic rates, it is suggested that the isokinetic equation presented in Reference 13 in Section 17.0 of Method 101 be consulted.

8.2 Sampling in Small (<12-in. Diameter) Stacks. When the stack diameter (or equivalent diameter) is less than 12 inches, conventional pitot tube-probe assemblies should not be used. For sampling guidelines, see Reference 14 in Section 17.0 of Method 101.

9.0 Quality Control

Same as Method 101, Section 9.0.

10.0 Calibration and Standardizations

Same as Method 101, Section 10.0.

11.0 Analytical Procedure

Same as Method 101, Section 11.0.

12.0 Data Analysis and Calculations

Same as Method 101, Section 12.0.

13.0 Method Performance

Same as Method 101, Section 13.0.

13.1 Analytical Range. After initial dilution, the range of this method is 0.5 to 120 µg Hg/ml. The upper limit can be extended by further dilution of the sample.

14.0 Pollution Prevention. [Reserved]

15.0 Waste Management. [Reserved]

16.0 References

Same as Method 101, Section 16.0.

17.0 Tables, Diagrams, Flowcharts, and Validation Data. [Reserved]

METHOD 103—BERYLLIUM SCREENING METHOD

1.0 Scope and Application

1.1 Analytes.

Analyte	CAS No.	Sensitivity
Beryllium (Be)	7440-41-7	Dependent upon analytical procedure used.

1.2 Applicability. This procedure details guidelines and requirements for methods acceptable for use in determining Be emissions in ducts or stacks at stationary sources.

1.3 Data Quality Objectives. Adherence to the requirements of this method will enhance the quality of the data obtained from air pollutant sampling methods.

2.0 Summary of Method

2.1 Particulate Be emissions are withdrawn isokinetically from three points in a duct or stack and are collected on a filter. The collected sample is analyzed for Be using an appropriate technique.

3.0 Definitions. [Reserved]

4.0 Interferences. [Reserved]

5.0 Safety

5.1 Disclaimer. This method may involve hazardous materials, operations, and equipment. This test method may not address all of the safety problems associated with its use. It is the responsibility of the user of this test method to establish appropriate safety and health practices and determine the applicability of regulatory limitations prior to performing this test method.

5.2 Hydrochloric Acid (HCl). Highly corrosive and toxic. Vapors are highly irritating to eyes, skin, nose, and lungs, causing severe damage. May cause bronchitis, pneumonia, or edema of lungs. Exposure to concentrations of 0.13 to 0.2 percent can be lethal to humans in a few minutes. Provide ventilation to limit exposure. Reacts with metals, producing hydrogen gas. Personal protective equipment and safe procedures are useful in preventing chemical splashes. If contact occurs, immediately flush with copious amounts of water at least 15 minutes. Remove clothing under shower and decontaminate. Treat residual chemical burn as thermal burn.

6.0 Equipment and Supplies

6.1 Sample Collection. A schematic of the required sampling train configuration is shown in Figure 103-1 in Section 17.0. The essential components of the train are as follows:

6.1.1 Nozzle. Stainless steel, or equivalent, with sharp, tapered leading edge.

6.1.2 Probe. Sheathed borosilicate or quartz glass tubing.

6.1.3 Filter. Millipore AA, or equivalent, with appropriate filter holder that provides a positive seal against leakage from outside or around the filter. It is suggested that a Whatman 41, or equivalent, be placed immediately against the back side of the Millipore filter as a guard against breakage of the Millipore. Include the backup filter in the analysis. To be equivalent, other filters shall exhibit at least 99.95 percent efficiency (0.05 percent penetration) on 0.3 micron dioctyl phthalate smoke particles, and be amenable to the Be analysis procedure. The filter efficiency tests shall be conducted in accordance with ASTM D 2986-71, 78, 95a (incorporated by reference—see §61.18). Test data from the supplier's quality control program are sufficient for this purpose.

6.1.4 Meter-Pump System. Any system that will maintain isokinetic sampling rate, determine sample volume, and is capable of a sampling rate of greater than 14 lpm (0.5 cfm).

6.2 Measurement of Stack Conditions. The following equipment is used to measure stack conditions:

6.2.1 Pitot Tube. Type S, or equivalent, with a constant coefficient (± 5 percent) over the working range.

6.2.2 Inclined Manometer, or Equivalent. To measure velocity head to ± 10 percent of the minimum value.

6.2.3 Temperature Measuring Device. To measure stack temperature to ± 1.5 percent of the minimum absolute stack temperature.

6.2.4 Pressure Measuring Device. To measure stack pressure to ± 2.5 mm Hg (0.1 in. Hg).

6.2.5 Barometer. To measure atmospheric pressure to ± 2.5 mm Hg (0.1 in. Hg).

6.2.6 Wet and Dry Bulb Thermometers, Drying Tubes, Condensers, or Equivalent. To determine stack gas moisture content to ± 1 percent.

6.3 Sample Recovery.

6.3.1 Probe Cleaning Equipment. Probe brush or cleaning rod at least as long as probe, or equivalent. Clean cotton balls, or equivalent, should be used with the rod.

6.3.2 Leakless Glass Sample Bottles. To contain sample.

6.4 Analysis. All equipment necessary to perform an atomic absorption, spectrographic, fluorometric, chromatographic, or equivalent analysis.

7.0 Reagents and Standards

7.1 Sample Recovery.

7.1.1 Water. Deionized distilled, to conform to ASTM D 1193-77, 91 (incorporated by reference—see §61.18), Type 3.

7.1.2 Acetone. Reagent grade.

7.1.3 Wash Acid, 50 Percent (V/V) Hydrochloric Acid (HCl). Mix equal volumes of concentrated HCl and water, being careful to add the acid slowly to the water.

7.2 Analysis. Reagents and standards as necessary for the selected analytical procedure.

8.0 Sample Collection, Preservation, Transport, and Storage

Guidelines for source testing are detailed in the following sections. These guidelines are generally applicable; however, most sample sites differ to some degree and temporary alterations such as stack extensions or expansions often are required to insure the best possible sample site. Further, since Be is

hazardous, care should be taken to minimize exposure. Finally, since the total quantity of Be to be collected is quite small, the test must be carefully conducted to prevent contamination or loss of sample.

8.1 Selection of a Sampling Site and Number of Sample Runs. Select a suitable sample site that is as close as practicable to the point of atmospheric emission. If possible, stacks smaller than one foot in diameter should not be sampled.

8.1.1 Ideal Sampling Site. The ideal sampling site is at least eight stack or duct diameters downstream and two diameters upstream from any flow disturbance such as a bend, expansion or contraction. For rectangular cross sections, use Equation 103-1 in Section 12.2 to determine an equivalent diameter, D_e .

8.1.2 Alternate Sampling Site. Some sampling situations may render the above sampling site criteria impractical. In such cases, select an alternate site no less than two diameters downstream and one-half diameter upstream from any point of flow disturbance. Additional sample runs are recommended at any sample site not meeting the criteria of Section 8.1.1.

8.1.3 Number of Sample Runs Per Test. Three sample runs constitute a test. Conduct each run at one of three different points. Select three points that proportionately divide the diameter, or are located at 25, 50, and 75 percent of the diameter from the inside wall. For horizontal ducts, sample on a vertical line through the centroid. For rectangular ducts, sample on a line through the centroid and parallel to a side. If additional sample runs are performed per Section 8.1.2, proportionately divide the duct to accommodate the total number of runs.

8.2 Measurement of Stack Conditions. Using the equipment described in Section 6.2, measure the stack gas pressure, moisture, and temperature to determine the molecular weight of the stack gas. Sound engineering estimates may be made in lieu of direct measurements. Describe the basis for such estimates in the test report.

8.3 Preparation of Sampling Train.

8.3.1 Assemble the sampling train as shown in Figure 103-1. It is recommended that all glassware be precleaned by soaking in wash acid for two hours.

8.3.2 Leak check the sampling train at the sampling site. The leakage rate should not be in excess of 1 percent of the desired sample rate.

8.4 Sampling Train Operation.

8.4.1 For each run, measure the velocity at the selected sampling point. Determine the isokinetic sampling rate. Record the velocity head and the required sampling rate. Place the nozzle at the sampling point with the tip pointing directly into the gas stream. Immediately start the pump and adjust the flow to isokinetic conditions. At the conclusion of the test, record the sampling rate. Again measure the velocity head at the sampling point. The required isokinetic rate at the end of the period should not have deviated more than 20 percent from that originally calculated. Describe the reason for any deviation beyond 20 percent in the test report.

8.4.2 Sample at a minimum rate of 14 liters/min (0.5 cfm). Obtain samples over such a period or periods of time as are necessary to determine the maximum emissions which would occur in a 24-hour period. In the case of cyclic operations, perform sufficient sample runs so as to allow determination or calculation of the emissions that occur over the duration of the cycle. A minimum sampling time of two hours per run is recommended.

8.5 Sample Recovery.

8.5.1 It is recommended that all glassware be precleaned as in Section 8.3. Sample recovery should also be performed in an area free of possible Be contamination. When the sampling train is moved, exercise care to prevent breakage and contamination. Set aside a portion of the acetone used in the sample recovery as a blank for analysis. The total amount of acetone used should be measured for accurate blank correction. Blanks can be eliminated if prior analysis shows negligible amounts.

8.5.2 Remove the filter (and backup filter, if used) and any loose particulate matter from filter holder, and place in a container.

8.5.3 Clean the probe with acetone and a brush or long rod and cotton balls. Wash into the container with the filter. Wash out the filter holder with acetone, and add to the same container.

9.0 Quality Control. [Reserved]

10.0 Calibration and Standardization

10.1 Sampling Train. As a procedural check, compare the sampling rate regulation with a dry gas meter, spirometer, rotameter (calibrated for prevailing atmospheric conditions), or equivalent, attached to the nozzle inlet of the complete sampling train.

10.2 Analysis. Perform the analysis standardization as suggested by the manufacturer of the instrument, or the procedures for the analytical method in use.

11.0 Analytical Procedure

Make the necessary preparation of samples and analyze for Be. Any currently acceptable method (e.g., atomic absorption, spectrographic, fluorometric, chromatographic) may be used.

12.0 Data Analysis and Calculations

12.1 Nomenclature.

$A_s(\text{avg})$ = Stack area, m^2 (ft^2).

L = Length.

R = Be emission rate, g/day .

$V_s(\text{avg})$ = Average stack gas velocity, m/sec (ft/sec).

V_{total} = Total volume of gas sampled, m^3 (ft^3).

W = Width.

W_t = Total weight of Be collected, mg .

10^{-6} = Conversion factor, $\text{g}/\mu\text{g}$.

86,400 = Conversion factor, sec/day .

12.2 Calculate the equivalent diameter, D_e , for a rectangular cross section as follows:

$$D_c = \frac{2 \cdot L \cdot W}{L + W} \quad \text{Eq. 103-1}$$

[View or download PDF](#)

12.3 Calculate the Be emission rate, R, in g/day for each stack using Equation 103-2. For cyclic operations, use only the time per day each stack is in operation. The total Be emission rate from a source is the summation of results from all stacks.

$$R = \frac{W_i V_{s(\text{avg})} A_i (86,400) (10^{-6})}{V_{\text{total}}} \quad \text{Eq. 103-2}$$

[View or download PDF](#)

12.4 Test Report. Prepare a test report that includes as a minimum: A detailed description of the sampling train used, results of the procedural check described in Section 10.1 with all data and calculations made, all pertinent data taken during the test, the basis for any estimates made, isokinetic sampling calculations, and emission results. Include a description of the test site, with a block diagram and brief description of the process, location of the sample points in the stack cross section, and stack dimensions and distances from any point of disturbance.

13.0 Method Performance. [Reserved]

14.0 Pollution Prevention. [Reserved]

15.0 Waste Management. [Reserved]

16.0 References. [Reserved]

17.0 Tables, Diagrams, Flow Charts, and Validation Data

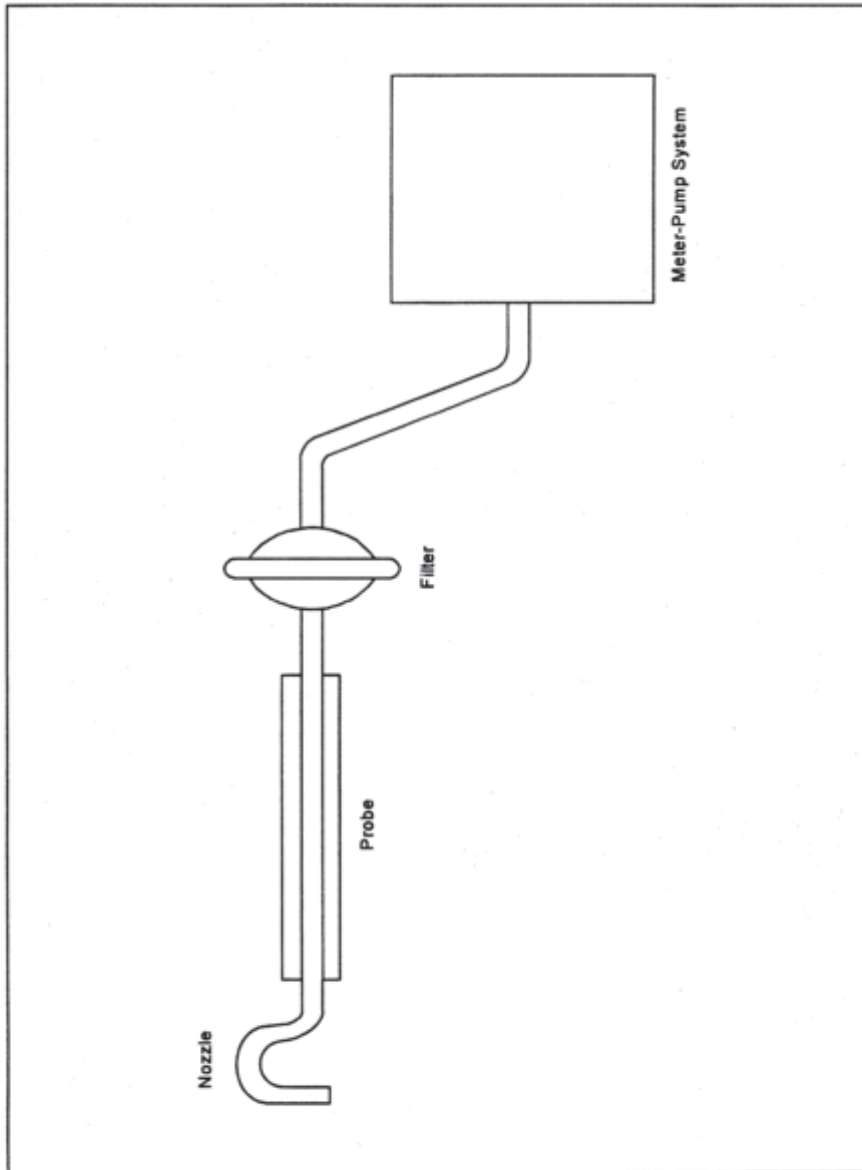

Figure 103-1. Beryllium Screening Method Sampling Train Schematic.

[View or download PDF](#)

METHOD 104—DETERMINATION OF BERYLLIUM EMISSIONS FROM STATIONARY SOURCES

NOTE: This method does not include all of the specifications (e.g., equipment and supplies) and procedures (e.g., sampling and analytical) essential to its performance. Some material is incorporated by reference from methods in appendix A to 40 CFR part 60. Therefore, to obtain reliable results, persons using this method should have a thorough knowledge of at least the following additional test methods: Method 1, Method 2, Method 3, and Method 5 in appendix A, part 60.

1.0 Scope and Application

1.1 Analytes.

Analyte	CAS No.	Sensitivity
Beryllium (Be)	7440-41-7	Dependent upon recorder and spectrophotometer.

1.2 Applicability. This method is applicable for the determination of Be emissions in ducts or stacks at stationary sources. Unless otherwise specified, this method is not intended to apply to gas streams other than those emitted directly to the atmosphere without further processing.

1.3 Data Quality Objectives. Adherences to the requirements of this method will enhance the quality of the data obtained from air pollutant sampling methods.

2.0 Summary of Method

2.1 Particulate and gaseous Be emissions are withdrawn isokinetically from the source and are collected on a glass fiber filter and in water. The collected sample is digested in an acid solution and is analyzed by atomic absorption spectrophotometry.

3.0 Definitions [Reserved]

4.0 Interferences

4.1 Matrix Effects. Analysis for Be by flame atomic absorption spectrophotometry is sensitive to the chemical composition and to the physical properties (e.g., viscosity, pH) of the sample. Aluminum and silicon, in particular, are known to interfere when present in appreciable quantities. The analytical procedure includes (optionally) the use of the Method of Standard Additions to check for these matrix effects, and sample analysis using the Method of Standard Additions if significant matrix effects are found to be present (see Reference 2 in Section 17.0).

5.0 Safety

5.1 Disclaimer. This method may involve hazardous materials, operations, and equipment. This test method may not address all of the safety problems associated with its use. It is the responsibility of the user of this test method to establish appropriate safety and health practices and determine the applicability of regulatory limitations prior to performing this test method.

5.2 Corrosive reagents. The following reagents are hazardous. Personal protective equipment and safe procedures are useful in preventing chemical splashes. If contact occurs, immediately flush with copious amounts of water at least 15 minutes. Remove clothing under shower and decontaminate. Treat residual chemical burn as thermal burn.

5.2.1 Hydrochloric Acid (HCl). Highly toxic. Vapors are highly irritating to eyes, skin, nose, and lungs, causing severe damage. May cause bronchitis, pneumonia, or edema of lungs. Exposure to concentrations of 0.13 to 0.2 percent can be lethal to humans in a few minutes. Provide ventilation to limit exposure. Reacts with metals, producing hydrogen gas.

5.2.2 Hydrogen Peroxide (H₂O₂). Irritating to eyes, skin, nose, and lungs.

5.2.3 Nitric Acid (HNO₃). Highly corrosive to eyes, skin, nose, and lungs. Vapors cause bronchitis, pneumonia, or edema of lungs. Reaction to inhalation may be delayed as long as 30 hours and still be fatal. Provide ventilation to limit exposure. Strong oxidizer. Hazardous reaction may occur with organic materials such as solvents.

5.2.4 Sodium Hydroxide (NaOH). Causes severe damage to eyes and skin. Inhalation causes irritation to nose, throat, and lungs. Reacts exothermically with limited amounts of water.

5.3 Beryllium is hazardous, and precautions should be taken to minimize exposure.

6.0 Equipment and Supplies

6.1 Sample Collection. Same as Method 5, Section 6.1, with the exception of the following:

6.1.1 Sampling Train. Same as Method 5, Section 6.1.1, with the exception of the following:

6.1.2 Probe Liner. Borosilicate or quartz glass tubing. A heating system capable of maintaining a gas temperature of 120 ± 14 °C (248 ± 25 °F) at the probe exit during sampling to prevent water condensation may be used.

NOTE: Do not use metal probe liners.

6.1.3 Filter Holder. Borosilicate glass, with a glass frit filter support and a silicone rubber gasket. Other materials of construction (e.g., stainless steel, Teflon, Viton) may be used, subject to the approval of the Administrator. The holder design shall provide a positive seal against leakage from the outside or around the filter. The holder shall be attached immediately at the outlet of the probe. A heating system capable of maintaining the filter at a minimum temperature in the range of the stack temperature may be used to prevent condensation from occurring.

6.1.4 Impingers. Four Greenburg-Smith impingers connected in series with leak-free ground glass fittings or any similar leak-free noncontaminating fittings. For the first, third, and fourth impingers, use impingers that are modified by replacing the tip with a 13 mm-ID (0.5 in.) glass tube extending to 13 mm (0.5 in.) from the bottom of the flask may be used.

6.2 Sample Recovery. The following items are needed for sample recovery:

6.2.1 Probe Cleaning Rod. At least as long as probe.

6.2.2 Glass Sample Bottles. Leakless, with Teflon-lined caps, 1000 ml.

6.2.3 Petri Dishes. For filter samples, glass or polyethylene, unless otherwise specified by the Administrator.

6.2.4 Graduated Cylinder. 250 ml.

6.2.5 Funnel and Rubber Policeman. To aid in transfer of silica gel to container; not necessary if silica gel is weighed in the field.

6.2.6 Funnel. Glass, to aid in sample recovery.

6.2.7 Plastic Jar. Approximately 300 ml.

6.3 Analysis. The following items are needed for sample analysis:

6.3.1 Atomic Absorption Spectrophotometer. Perkin-Elmer 303, or equivalent, with nitrous oxide/acetylene burner.

6.3.2 Hot Plate.

6.3.3 Perchloric Acid Fume Hood.

7.0 Reagents and Standards

NOTE: Unless otherwise indicated, it is intended that all reagents conform to the specifications established by the Committee on Analytical Reagents of the American Chemical Society, where such specifications are available; otherwise, use the best available grade.

7.1 Sample Collection. Same as Method 5, Section 7.1, including deionized distilled water conforming to ASTM D 1193-77 or 91 (incorporated by reference—see §61.18), Type 3. The Millipore AA filter is recommended.

7.2 Sample Recovery. Same as Method 5 in appendix A, part 60, Section 7.2, with the addition of the following:

7.2.1 Wash Acid, 50 Percent (V/V) Hydrochloric Acid (HCl). Mix equal volumes of concentrated HCl and water, being careful to add the acid slowly to the water.

7.3 Sample Preparation and Analysis. The following reagents and standards and standards are needed for sample preparation and analysis:

7.3.1 Water. Same as in Section 7.1.

7.3.2. Perchloric Acid (HClO₄). Concentrated (70 percent V/V).

7.3.3 Nitric Acid (HNO₃). Concentrated.

7.3.4 Beryllium Powder. Minimum purity 98 percent.

7.3.5 Sulfuric Acid (H₂SO₄) Solution, 12 N. Dilute 33 ml of concentrated H₂SO₄ to 1 liter with water.

7.3.6 Hydrochloric Acid Solution, 25 Percent HCl (V/V).

7.3.7 Stock Beryllium Standard Solution, 10 µg Be/ml. Dissolve 10.0 mg of Be in 80 ml of 12 N H₂SO₄ in a 1000-ml volumetric flask. Dilute to volume with water. This solution is stable for at least one month. Equivalent strength Be stock solutions may be prepared from Be salts such as BeCl₂ and Be(NO₃)₂ (98 percent minimum purity).

7.3.8 Working Beryllium Standard Solution, 1 µg Be/ml. Dilute a 10 ml aliquot of the stock beryllium standard solution to 100 ml with 25 percent HCl solution to give a concentration of 1 mg/ml. Prepare this dilute stock solution fresh daily.

8.0 Sample Collection, Preservation, Transport, and Storage

The amount of Be that is collected is generally small, therefore, it is necessary to exercise particular care to prevent contamination or loss of sample.

8.1 Pretest Preparation. Same as Method 5, Section 8.1, except omit Section 8.1.3.

8.2 Preliminary Determinations. Same as Method 5, Section 8.2, with the exception of the following:

8.2.1 Select a nozzle size based on the range of velocity heads to assure that it is not necessary to change the nozzle size in order to maintain isokinetic sampling rates below 28 liters/min (1.0 cfm).

8.2.2 Obtain samples over a period or periods of time that accurately determine the maximum emissions that occur in a 24-hour period. In the case of cyclic operations, perform sufficient sample runs for the accurate determination of the emissions that occur over the duration of the cycle. A minimum sample time of 2 hours per run is recommended.

8.3 Preparation of Sampling Train. Same as Method 5, Section 8.3, with the exception of the following:

8.3.1 Prior to assembly, clean all glassware (probe, impingers, and connectors) by first soaking in wash acid for 2 hours, followed by rinsing with water.

8.3.2 Save a portion of the water for a blank analysis.

8.3.3 Procedures relating to the use of metal probe liners are not applicable.

8.3.4 Probe and filter heating systems are needed only if water condensation is a problem. If this is the case, adjust the heaters to provide a temperature at or above the stack temperature. However, membrane filters such as the Millipore AA are limited to about 107 °C (225 °F). If the stack gas is in excess of about 93 °C (200 °F), consideration should be given to an alternate procedure such as moving the filter holder downstream of the first impinger to insure that the filter does not exceed its temperature limit. After the sampling train has been assembled, turn on and set the probe heating system, if applicable, at the desired operating temperature. Allow time for the temperatures to stabilize. Place crushed ice around the impingers.

NOTE: An empty impinger may be inserted between the third impinger and the silica gel to remove excess moisture from the sample stream.

8.4 Leak Check Procedures, Sampling Train Operation, and Calculation of Percent Isokinetic. Same as Method 5, Sections 8.4, 8.5, and 8.6, respectively.

8.5 Sample Recovery. Same as Method 5, Section 8.7, except treat the sample as follows: Transfer the probe and impinger assembly to a cleanup area that is clean, protected from the wind, and free of Be contamination. Inspect the train before and during this assembly, and note any abnormal conditions. Treat the sample as follows: Disconnect the probe from the impinger train.

8.5.1 Container No. 1. Same as Method 5, Section 8.7.6.1.

8.5.2 Container No. 2. Place the contents (measured to 1 ml) of the first three impingers into a glass sample bottle. Use the procedures outlined in Section 8.7.6.2 of Method 5, where applicable, to rinse the probe nozzle, probe fitting, probe liner, filter holder, and all glassware between the filter holder and the back half of the third impinger with water. Repeat this procedure with acetone. Place both water and acetone rinse solutions in the sample bottle with the contents of the impingers.

8.5.3 Container No. 3. Same as Method 5, Section 8.7.6.3.

8.6 Blanks.

8.6.1 Water Blank. Save a portion of the water as a blank. Take 200 ml directly from the wash bottle being used and place it in a plastic sample container labeled "H₂O blank."

8.6.2 Filter. Save two filters from each lot of filters used in sampling. Place these filters in a container labeled "filter blank."

8.7 Post-test Glassware Rinsing. If an additional test is desired, the glassware can be carefully double rinsed with water and reassembled. However, if the glassware is out of use more than 2 days, repeat the initial acid wash procedure.

9.0 QUALITY CONTROL

Section	Quality control measure	Effect
8.4, 10.1	Sampling equipment leak checks and calibration	Ensure accuracy and precision of sampling measurements.
10.2	Spectrophotometer calibration	Ensure linearity of spectrophotometer response to standards.
11.5	Check for matrix effects	Eliminate matrix effects.

10.0 Calibration and Standardization

NOTE: Maintain a laboratory log of all calibrations.

10.1 Sampling Equipment. Same as Method 5, Section 10.0.

10.2 Preparation of Standard Solutions. Pipet 1, 3, 5, 8, and 10 ml of the 1.0 µg Be/ml working standard solution into separate 100 ml volumetric flasks, and dilute to the mark with water. The total amounts of Be in these standards are 1, 3, 5, 8, and 10 µg, respectively.

10.3 Spectrophotometer and Recorder. The Be response may be measured by either peak height or peak area. Analyze an aliquot of the 10-µg standard at 234.8 nm using a nitrous oxide/acetylene flame. Determine the maximum absorbance of the standard, and set this value to read 90 percent of the recorder full scale.

10.4 Calibration Curve.

10.4.1 After setting the recorder scale, analyze an appropriately sized aliquot of each standard and the BLANK (see Section 11) until two consecutive peaks agree within 3 percent of their average value.

10.4.3 Subtract the average peak height (or peak area) of the blank—which must be less than 2 percent of recorder full scale—from the averaged peak heights of the standards. If the blank absorbance is greater than 2 percent of full-scale, the probable cause is Be contamination of a reagent or carry-over of Be from a previous sample. Prepare the calibration curve by plotting the corrected peak height of each standard solution versus the corresponding total Be weight in the standard (in µg).

10.5 Spectrophotometer Calibration Quality Control. Calculate the least squares slope of the calibration curve. The line must pass through the origin or through a point no further from the origin than ±2 percent of the recorder full scale. Multiply the corrected peak height by the reciprocal of the least squares slope to determine the distance each calibration point lies from the theoretical calibration line. The difference between the calculated concentration values and the actual concentrations (i.e., 1, 3, 5, 8, and 10 µg Be) must be less than 7 percent for all standards.

11.0 Analytical Procedure

11.1 Sample Loss Check. Prior to analysis, check the liquid level in Container No. 2. Note on the analytical data sheet whether leakage occurred during transport. If a noticeable amount of leakage occurred, either void the sample or take steps, subject to the approval of the Administrator, to adjust the final results.

11.2 Glassware Cleaning. Before use, clean all glassware according to the procedure of Section 8.3.1.

11.3 Sample Preparation. The digestion of Be samples is accomplished in part in concentrated HClO_4 .

NOTE: The sample must be heated to light brown fumes after the initial HNO_3 addition; otherwise, dangerous perchlorates may result from the subsequent HClO_4 digestion. HClO_4 should be used only under a hood.

11.3.1 Container No. 1. Transfer the filter and any loose particulate matter from Container No. 1 to a 150-ml beaker. Add 35 ml concentrated HNO_3 . To oxidize all organic matter, heat on a hotplate until light brown fumes are evident. Cool to room temperature, and add 5 ml 12 N H_2SO_4 and 5 ml concentrated HClO_4 .

11.3.2 Container No. 2. Place a portion of the water and acetone sample into a 150 ml beaker, and put on a hotplate. Add portions of the remainder as evaporation proceeds and evaporate to dryness. Cool the residue, and add 35 ml concentrated HNO_3 . To oxidize all organic matter, heat on a hotplate until light brown fumes are evident. Cool to room temperature, and add 5 ml 12 N H_2SO_4 and 5 ml concentrated HClO_4 . Then proceed with step 11.3.4.

11.3.3 Final Sample Preparation. Add the sample from Section 11.3.2 to the 150-ml beaker from Section 11.3.1. Replace on a hotplate, and evaporate to dryness in a HClO_4 hood. Cool the residue to room temperature, add 10.0 ml of 25 percent V/V HCl, and mix to dissolve the residue.

11.3.4 Filter and Water Blanks. Cut each filter into strips, and treat each filter individually as directed in Section 11.3.1. Treat the 200-ml water blank as directed in Section 11.3.2. Combine and treat these blanks as directed in Section 11.3.3.

11.4 Spectrophotometer Preparation. Turn on the power; set the wavelength, slit width, and lamp current; and adjust the background corrector as instructed by the manufacturer's manual for the particular atomic absorption spectrophotometer. Adjust the burner and flame characteristics as necessary.

11.5 Analysis. Calibrate the analytical equipment and develop a calibration curve as outlined in Sections 10.4 and 10.5.

11.5.1 Beryllium Samples. Repeat the procedure used to establish the calibration curve with an appropriately sized aliquot of each sample (from Section 11.3.3) until two consecutive peak heights agree within 3 percent of their average value. The peak height of each sample must be greater than 10 percent of the recorder full scale. If the peak height of the sample is off scale on the recorder, further dilute the original source sample to bring the Be concentration into the calibration range of the spectrophotometer.

11.5.2 Run a blank and standard at least after every five samples to check the spectrophotometer calibration. The peak height of the blank must pass through a point no further from the origin than ± 2 percent of the recorder full scale. The difference between the measured concentration of the standard (the product of the corrected peak height and the reciprocal of the least squares slope) and the actual concentration of the standard must be less than 7 percent, or recalibration of the analyzer is required.

11.5.3 Check for Matrix Effects (optional). Use the Method of Standard Additions (see Reference 2 in Section 17.0) to check at least one sample from each source for matrix effects on the Be results. If the results of the Method of Standard Additions procedure used on the single source sample do not agree to within 5 percent of the value obtained by the routine atomic absorption analysis, then reanalyze all samples from the source using the Method of Standard Additions procedure.

11.6 Container No. 2 (Silica Gel). Weigh the spent silica gel (or silica gel plus impinger) to the nearest 0.5 g using a balance. (This step may be conducted in the field.)

12.0 Data Analysis and Calculations

Carry out calculations, retaining at least one extra decimal significant figure beyond that of the acquired data. Round off figures only after the final calculation. Other forms of the equations may be used as long as they give equivalent results.

12.1 Nomenclature.

$K_1 = 0.3858$ °K/mm Hg for metric units.

= 17.64 °R/in. Hg for English units.

$K_3 = 10^{-6}$ g/μg for metric units.

= 2.2046×10^{-9} lb/μg for English units.

m_{Be} = Total weight of beryllium in the source sample.

P_s = Absolute stack gas pressure, mm Hg (in. Hg).

t = Daily operating time, sec/day.

T_s = Absolute average stack gas temperature, °K (°R).

$V_{m(std)}$ = Dry gas sample volume at standard conditions, scm (scf).

$V_{w(std)}$ = Volume of water vapor at standard conditions, scm (scf).

12.2 Average Dry Gas Meter Temperature and Average Orifice Pressure Drop, Dry Gas Volume, Volume of Water Vapor Condensed, Moisture Content, Isokinetic Variation, and Stack Gas Velocity and Volumetric Flow Rate. Same as Method 5, Sections 12.2 through 12.5, 12.11, and 12.12, respectively.

12.3 Total Beryllium. For each source sample, correct the average maximum absorbance of the two consecutive samples whose peak heights agree within 3 percent of their average for the contribution of the solution blank (see Sections 11.3.4 and 11.5.2). Correcting for any dilutions if necessary, use the calibration curve and these corrected averages to determine the total weight of Be in each source sample.

12.4 Beryllium Emission Rate. Calculate the daily Hg emission rate, R , using Equation 104-1. For continuous operations, the operating time is equal to 86,400 seconds per day. For cyclic operations, use only the time per day each stack is in operation. The total Hg emission rate from a source will be the summation of results from all stacks.

$$R = \frac{K_1 K_3 t m_{Be} P_s v_s A_s}{T_s (V_{m(std)} + V_{w(std)})} \quad \text{Eq. 104-1}$$

[View or download PDF](#)

12.5 Determination of Compliance. Each performance test consists of three sample runs. For the purpose of determining compliance with an applicable national emission standard, use the average of the results of all sample runs.

13.0 *Method Performance. [Reserved]*

14.0 *Pollution Prevention. [Reserved]*

15.0 *Waste Management. [Reserved]*

16.0 *Alternative Procedures*

16.1 Inductively Coupled Plasma-Atomic Emission Spectrometry (ICP-AES) Analysis. ICP-AES may be used as an alternative to atomic absorption analysis provided the following conditions are met:

16.1.1 Sample collection, sample preparation, and analytical preparation procedures are as defined in the method except as necessary for the ICP-AES application.

16.1.2 Quality Assurance/Quality Control procedures, including audit material analysis, are conducted as prescribed in the method. The QA acceptance conditions must be met.

16.1.3 The limit of quantitation for the ICP-AES must be demonstrated and the sample concentrations reported should be no less than two times the limit of quantitation. The limit of quantitation is defined as ten times the standard deviation of the blank value. The standard deviation of the blank value is determined from the analysis of seven blanks. It has been reported that for mercury and those elements that form hydrides, a continuous-flow generator coupled to an ICP-AES offers detection limits comparable to cold vapor atomic absorption.

16.2 Inductively Coupled Plasma-Mass Spectrometry (ICP-MS) Analysis. ICP-MS may be used as an alternative to atomic absorption analysis.

16.3 Cold Vapor Atomic Fluorescence Spectrometry (CVAFS) Analysis. CVAFS may be used as an alternative to atomic absorption analysis.

17.0 *References*

Same as References 1, 2, and 4-11 of Section 16.0 of Method 101 with the addition of the following:

1. Amos, M.D., and J.B. Willis. Use of High-Temperature Pre-Mixed Flames in Atomic Absorption Spectroscopy. *Spectrochim. Acta.* 22:1325. 1966.

2. Fleet, B., K.V. Liberty, and T. S. West. A Study of Some Matrix Effects in the Determination of Beryllium by Atomic Absorption Spectroscopy in the Nitrous Oxide-Acetylene Flame. *Talanta* 17:203. 1970.

18.0 *Tables, Diagrams, Flowcharts, And Validation Data [Reserved]*

METHOD 105—DETERMINATION OF MERCURY IN WASTEWATER TREATMENT PLANT SEWAGE SLUDGES

NOTE: This method does not include all of the specifications (e.g., equipment and supplies) and procedures (e.g., sampling and analytical) essential to its performance. Some material is incorporated by reference from other

methods in this part. Therefore, to obtain reliable results, persons using this method should also have a thorough knowledge of at least the following additional test methods: Method 101 and Method 101A.

1.0 Scope and Application

1.1 Analytes.

Analyte	CAS No.	Sensitivity
Mercury (Hg)	7439-97-6	Dependent upon spectrophotometer and recorder.

1.2 Applicability. This method is applicable for the determination of total organic and inorganic Hg content in sewage sludges.

1.3 Data Quality Objectives. Adherence to the requirements of this method will enhance the quality of the data obtained from air pollutant sampling methods.

2.0 Summary of Method

2.1 Time-composite sludge samples are withdrawn from the conveyor belt subsequent to dewatering and before incineration or drying. A weighed portion of the sludge is digested in aqua regia and is oxidized by potassium permanganate (KMnO_4). Mercury in the digested sample is then measured by the conventional spectrophotometric cold-vapor technique.

3.0 Definitions [Reserved]

4.0 Interferences [Reserved]

5.0 Safety

5.1 Disclaimer. This method may involve hazardous materials, operations, and equipment. This test method may not address all of the safety problems associated with its use. It is the responsibility of the user of this test method to establish appropriate safety and health practices and determine the applicability of regulatory limitations prior to performing this test method.

5.2 Corrosive Reagents. The following reagents are hazardous. Personal protective equipment and safe procedures are useful in preventing chemical splashes. If contact occurs, immediately flush with copious amounts of water at least 15 minutes. Remove clothing under shower and decontaminate. Treat residual chemical burn as thermal burn.

5.2.1 Hydrochloric Acid (HCl). Highly toxic. Vapors are highly irritating to eyes, skin, nose, and lungs, causing severe damage. May cause bronchitis, pneumonia, or edema of lungs. Exposure to concentrations of 0.13 to 0.2 percent can be lethal to humans in a few minutes. Provide ventilation to limit exposure. Reacts with metals, producing hydrogen gas.

5.2.2 Nitric Acid (HNO_3). Highly corrosive to eyes, skin, nose, and lungs. Vapors cause bronchitis, pneumonia, or edema of lungs. Reaction to inhalation may be delayed as long as 30 hours and still be fatal. Provide ventilation to limit exposure. Strong oxidizer. Hazardous reaction may occur with organic materials such as solvents.

6.0 Equipment and Supplies

6.1 Sample Collection and Mixing. The following items are required for collection and mixing of the sludge samples:

- 6.1.1 Container. Plastic, 50-liter.
- 6.1.2 Scoop. To remove 950-ml (1 quart.) sludge sample.
- 6.1.3 Mixer. Mortar mixer, wheelbarrow-type, 57-liter (or equivalent) with electricity-driven motor.
- 6.1.4 Blender. Waring-type, 2-liter.
- 6.1.5 Scoop. To remove 100-ml and 20-ml samples of blended sludge.
- 6.1.6 Erlenmeyer Flasks. Four, 125-ml.
- 6.1.7 Beakers. Glass beakers in the following sizes: 50 ml (1), 200 ml (1), 400 ml (2).

6.2 Sample Preparation and Analysis. Same as Method 101, Section 6.3, with the addition of the following:

- 6.2.1 Hot Plate.
- 6.2.2 Desiccator.
- 6.2.3 Filter Paper. S and S No. 588 (or equivalent).
- 6.2.4 Beakers. Glass beakers, 200 ml and 400 ml (2 each).

7.0 *Reagents and Standards*

NOTE: Unless otherwise indicated, it is intended that all reagents conform to the specifications established by the Committee on Analytical Reagents of the American Chemical Society, where such specifications are available; otherwise, use the best available grade.

7.1 Sample Analysis. Same as Method 101A, Section 7.2, with the following additions and exceptions:

7.1.1 Hydrochloric Acid. The concentrated HCl specified in Method 101A, Section 7.2.4, is not required.

7.1.2 Aqua Regia. Prepare immediately before use. Carefully add one volume of concentrated HNO₃ to three volumes of concentrated HCl.

8.0 *Sample Collection, Preservation, Storage, and Transport*

8.1 Sludge Sampling. Withdraw equal volume increments of sludge [for a total of at least 15 liters (16 quarts)] at intervals of 30 min over an 8-hr period, and combine in a rigid plastic container.

8.2 Sludge Mixing. Transfer the entire 15-liter sample to a mortar mixer. Mix the sample for a minimum of 30 min at 30 rpm. Take six 100-ml portions of sludge, and combine in a 2-liter blender. Blend sludge for 5 min; add water as necessary to give a fluid consistency. Immediately after stopping the

blender, withdraw four 20-ml portions of blended sludge, and place them in separate, tared 125-ml Erlenmeyer flasks. Reweigh each flask to determine the exact amount of sludge added.

8.3 Sample Holding Time. Samples shall be analyzed within the time specified in the applicable subpart of the regulations.

9.0 Quality Control

Section	Quality control measure	Effect
10.0	Spectrophotometer calibration	Ensure linearity of spectrophotometer response to standards.
11.0	Check for matrix effects	Eliminate matrix effects.

10.0 Calibration and Standardization

Same as Method 101A, Section 10.2.

11.0 Analytical Procedures

11.1 Solids Content of Blended Sludge. Dry one of the 20-ml blended samples from Section 8.2 in an oven at 105 °C (221 °F) to constant weight. Cool in a desiccator, weigh and record the dry weight of the sample.

11.2 Aqua Regia Digestion of Blended Samples.

11.2.1 To each of the three remaining 20-ml samples from Section 8.2 add 25 ml of aqua regia, and digest the on a hot plate at low heat (do not boil) for 30 min, or until samples are a pale yellow-brown color and are void of the dark brown color characteristic of organic matter. Remove from hotplate and allow to cool.

11.2.2 Filter each digested sample separately through an S and S No. 588 filter or equivalent, and rinse the filter contents with 50 ml of water. Transfer the filtrate and filter washing to a 100-ml volumetric flask, and carefully dilute to volume with water.

11.3 Solids Content of the Sludge Before Blending. Remove two 100-ml portions of mixed sludge from the mortar mixer and place in separate, tared 400-ml beakers. Reweigh each beaker to determine the exact amount of sludge added. Dry in oven at 105 °C (221 °F) and cool in a desiccator to constant weight.

11.4 Analysis for Mercury. Analyze the three aqua regia-digested samples using the procedures outlined in Method 101A, Section 11.0.

12.0 Data Analysis and Calculations

12.1 Nomenclature.

C_m = Concentration of Hg in the digested sample, $\mu\text{g/g}$.

F_{sb} = Weight fraction of solids in the blended sludge.

F_{sm} = Weight fraction of solids in the collected sludge after mixing.

M = Hg content of the sewage sludge (on a dry basis), µg/g.

m = Mass of Hg in the aliquot of digested sample analyzed, µg.

n = number of digested samples (specified in Section 11.2 as three).

V_a = Volume of digested sample analyzed, ml.

V_s = Volume of digested sample, ml.

W_b = Weight of empty sample beaker, g.

W_{bs} = Weight of sample beaker and sample, g.

W_{bd} = Weight of sample beaker and sample after drying, g.

W_f = Weight of empty sample flask, g.

W_{fd} = Weight of sample flask and sample after drying, g.

W_{fs} = Weight of sample flask and sample, g.

12.2 Mercury Content of Digested Sample (Wet Basis).

12.2.1 For each sample analyzed for Hg content, calculate the arithmetic mean maximum absorbance of the two consecutive samples whose peak heights agree ±3 percent of their average. Correct this average value for the contribution of the blank. Use the calibration curve and these corrected averages to determine the final Hg concentration in the solution cell for each sludge sample.

12.2.2 Calculate the average Hg concentration of the digested samples by correcting for any dilutions made to bring the sample into the working range of the spectrophotometer and for the weight of the sludge portion digested, using Equation 105-1.

$$\bar{C}_m = \sum_{i=1}^n \left[\frac{mV_s}{V_s(W_{fs} - W_f)} \right]_i \quad \text{Eq. 105-1}$$

[View or download PDF](#)

12.3 Solids Content of Blended Sludge. Determine the solids content of the blended sludge using Equation 105-2.

$$F_{sb} = 1 - \frac{W_{fs} - W_{fd}}{W_{fs} - W_f} \quad \text{Eq. 105-2}$$

[View or download PDF](#)

12.4 Solids Content of Bulk Sample (before blending but, after mixing in mortar mixer). Determine the solids content of each 100 ml aliquot (Section 11.3), and average the results.

$$F_{sm} = 1 - \frac{W_{bs} - W_{bd}}{W_{bs} - W_b} \quad \text{Eq. 105-3}$$

[View or download PDF](#)

12.5 Mercury Content of Bulk Sample (Dry Basis). Average the results from the three samples from each 8-hr composite sample, and calculate the Hg concentration of the composite sample on a dry basis.

$$M = \frac{\bar{C}_m}{F_{sb}} \quad \text{Eq. 105-4}$$

[View or download PDF](#)

13.0 Method Performance

13.1 Range. The range of this method is 0.2 to 5 micrograms per gram; it may be extended by increasing or decreasing sample size.

14.0 Pollution Prevention. [Reserved]

15.0 Waste Management. [Reserved]

16.0 References

1. Bishop, J.N. Mercury in Sediments. Ontario Water Resources Commission. Toronto, Ontario, Canada. 1971.
2. Salma, M. Private Communication. EPA California/Nevada Basin Office. Alameda, California.
3. Hatch, W.R. and W.L. Ott. Determination of Sub-Microgram Quantities of Mercury by Atomic Absorption Spectrophotometry. Analytical Chemistry. 40:2085. 1968.
4. Bradenberger, H., and H. Bader. The Determination of Nanogram Levels of Mercury in Solution by a Flameless Atomic Absorption Technique. Atomic Absorption Newsletter. 6:101. 1967.
5. Analytical Quality Control Laboratory (AQCL). Mercury in Sediment (Cold Vapor Technique) (Provisional Method). U.S. Environmental Protection Agency. Cincinnati, Ohio. April 1972.
6. Kopp, J.F., M.C. Longbottom, and L.B. Lobring. "Cold Vapor" Method for Determining Mercury. Journal AWWA. 64(1):20-25. 1972.
7. Manual of Methods for Chemical Analysis of Water and Wastes. U.S. Environmental Protection Agency. Cincinnati, Ohio. Publication No. EPA-624/2-74-003. December 1974. pp. 118-138.
8. Mitchell, W.J., M.R. Midgett, J. Suggs, R.J. Velton, and D. Albrink. Sampling and Homogenizing Sewage for Analysis. Environmental Monitoring and Support Laboratory, Office of Research and Development, U.S. Environmental Protection Agency. Research Triangle Park, N.C. March 1979. p. 7.

17.0 Tables, Diagrams, Flowcharts, and Validation Data. [Reserved]

METHOD 106—DETERMINATION OF VINYL CHLORIDE EMISSIONS FROM STATIONARY SOURCES

1.0 Scope and Application

1.1 Analytes.

Analyte	CAS No.	Sensitivity
---------	---------	-------------

Vinyl Chloride (CH ₂ :CHCl)	75-01-4	Dependent upon analytical equipment.
----------------------------------------	---------	--------------------------------------

1.2 Applicability. This method is applicable for the determination of vinyl chloride emissions from ethylene dichloride, vinyl chloride, and polyvinyl chloride manufacturing processes. This method does not measure vinyl chloride contained in particulate matter.

1.3 Data Quality Objectives. Adherence to the requirements of this method will enhance the quality of the data obtained from air pollutant sampling methods.

2.0 Summary of Method

2.1 An integrated bag sample of stack gas containing vinyl chloride is subjected to GC analysis using a flame ionization detector (FID).

3.0 Definitions. [Reserved]

4.0 Interferences

4.1 Resolution interferences of vinyl chloride may be encountered on some sources. Therefore, the chromatograph operator should select the column and operating parameters best suited to the particular analysis requirements. The selection made is subject to approval of the Administrator. Approval is automatic, provided that confirming data are produced through an adequate supplemental analytical technique, and that the data are available for review by the Administrator. An example of this would be analysis with a different column or GC/mass spectroscopy.

5.0 Safety

5.1 Disclaimer. This method may involve hazardous materials, operations, and equipment. This test method may not address all of the safety problems associated with its use. It is the responsibility of the user of this test method to establish appropriate safety and health practices and determine the applicability of regulatory limitations prior to performing this test method.

5.2 Toxic Analyte. Care must be exercised to prevent exposure of sampling personnel to vinyl chloride, which is a carcinogen.

6.0 Equipment and Supplies

6.1 Sample Collection (see Figure 106-1). The sampling train consists of the following components:

6.1.1 Probe. Stainless steel, borosilicate glass, Teflon tubing (as stack temperature permits), or equivalent, equipped with a glass wool plug to remove particulate matter.

6.1.2 Sample Lines. Teflon, 6.4-mm outside diameter, of sufficient length to connect probe to bag. Use a new unused piece for each series of bag samples that constitutes an emission test, and discard upon completion of the test.

6.1.3 Quick Connects. Stainless steel, male (2) and female (2), with ball checks (one pair without), located as shown in Figure 106-1.

6.1.4 Tedlar Bags. 50- to 100-liter capacity, to contain sample. Aluminized Mylar bags may be used if the samples are analyzed within 24 hours of collection.

6.1.5 Bag Containers. Rigid leak-proof containers for sample bags, with covering to protect contents from sunlight.

6.1.6 Needle Valve. To adjust sample flow rates.

6.1.7 Pump. Leak-free, with minimum of 2-liter/min capacity.

6.1.8 Charcoal Tube. To prevent admission of vinyl chloride and other organics to the atmosphere in the vicinity of samplers.

6.1.9 Flowmeter. For observing sampling flow rate; capable of measuring a flow range from 0.10 to 1.00 liter/min.

6.1.10 Connecting Tubing. Teflon, 6.4-mm outside diameter, to assemble sampling train (Figure 106-1).

6.1.11 Tubing Fittings and Connectors. Teflon or stainless steel, to assemble sampling training.

6.2 Sample Recovery. Teflon tubing, 6.4-mm outside diameter, to connect bag to GC sample loop. Use a new unused piece for each series of bag samples that constitutes an emission test, and discard upon conclusion of analysis of those bags.

6.3 Analysis. The following equipment is required:

6.3.1 Gas Chromatograph. With FID potentiometric strip chart recorder and 1.0 to 5.0-ml heated sampling loop in automatic sample valve. The chromatographic system shall be capable of producing a response to 0.1-ppmv vinyl chloride that is at least as great as the average noise level. (Response is measured from the average value of the base line to the maximum of the wave form, while standard operating conditions are in use.)

6.3.2 Chromatographic Columns. Columns as listed below. Other columns may be used provided that the precision and accuracy of the analysis of vinyl chloride standards are not impaired and that information is available for review confirming that there is adequate resolution of vinyl chloride peak. (Adequate resolution is defined as an area overlap of not more than 10 percent of the vinyl chloride peak by an interferent peak. Calculation of area overlap is explained in Procedure 1 of appendix C to this part: "Determination of Adequate Chromatographic Peak Resolution.")

6.3.2.1 Column A. Stainless steel, 2.0 m by 3.2 mm, containing 80/100-mesh Chromasorb 102.

6.3.2.2 Column B. Stainless steel, 2.0 m by 3.2 mm, containing 20 percent GE SF-96 on 60/100-mesh Chromasorb P AW; or stainless steel, 1.0 m by 3.2 mm containing 80/100-mesh Porapak T. Column B is required as a secondary column if acetaldehyde is present. If used, column B is placed after column A. The combined columns should be operated at 120 °C (250 °F).

6.3.3 Rate Meters (2). Rotameter , or equivalent, 100-ml/min capacity, with flow control valves.

6.3.4 Gas Regulators. For required gas cylinders.

6.3.5 Temperature Sensor. Accurate to ± 1 °C (± 2 °F), to measure temperature of heated sample loop at time of sample injection.

6.3.6 Barometer. Accurate to ± 5 mm Hg, to measure atmospheric pressure around GC during sample analysis.

6.3.7 Pump. Leak-free, with minimum of 100-ml/min capacity.

6.3.8 Recorder. Strip chart type, optionally equipped with either disc or electronic integrator.

6.3.9 Planimeter. Optional, in place of disc or electronic integrator on recorder, to measure chromatograph peak areas.

6.4 Calibration and Standardization.

6.4.1 Tubing. Teflon, 6.4-mm outside diameter, separate pieces marked for each calibration concentration.

NOTE: The following items are required only if the optional standard gas preparation procedures (Section 10.1) are followed.

6.4.2 Tedlar Bags. Sixteen-inch-square size, with valve; separate bag marked for each calibration concentration.

6.4.3 Syringes. 0.5-ml and 50- μ l, gas tight, individually calibrated to dispense gaseous vinyl chloride.

6.4.4 Dry Gas Meter with Temperature and Pressure Gauges. Singer Model DTM-115 with 802 index, or equivalent, to meter nitrogen in preparation of standard gas mixtures, calibrated at the flow rate used to prepare standards.

7.0 Reagents and Standards

7.1 Analysis. The following reagents are required for analysis.

7.1.1 Helium or Nitrogen. Purity 99.9995 percent or greater, for chromatographic carrier gas.

7.1.2 Hydrogen. Purity 99.9995 percent or greater.

7.1.3 Oxygen or Air. Either oxygen (purity 99.99 percent or greater) or air (less than 0.1 ppmv total hydrocarbon content), as required by detector.

7.2 Calibration. Use one of the following options: either Sections 7.2.1 and 7.2.2, or Section 7.2.3.

7.2.1 Vinyl Chloride. Pure vinyl chloride gas certified by the manufacturer to contain a minimum of 99.9 percent vinyl chloride. If the gas manufacturer maintains a bulk cylinder supply of 99.9 + percent vinyl chloride, the certification analysis may have been performed on this supply, rather than on each gas cylinder prepared from this bulk supply. The date of gas cylinder preparation and the certified analysis must have been affixed to the cylinder before shipment from the gas manufacturer to the buyer.

7.2.2 Nitrogen. Same as described in Section 7.1.1.

7.2.3 Cylinder Standards. Gas mixture standards (50-, 10-, and 5 ppmv vinyl chloride) in nitrogen cylinders may be used to directly prepare a chromatograph calibration curve as described in Section 10.3 if the following conditions are met: (a) The manufacturer certifies the gas composition with an accuracy of

±3 percent or better. (b) The manufacturer recommends a maximum shelf life over which the gas concentration does not change by greater than ±5 percent from the certified value. (c) The manufacturer affixes the date of gas cylinder preparation, certified vinyl chloride concentration, and recommended maximum shelf to the cylinder before shipment to the buyer.

7.2.3.1 Cylinder Standards Certification. The manufacturer shall certify the concentration of vinyl chloride in nitrogen in each cylinder by (a) directly analyzing each cylinder and (b) calibrating his analytical procedure on the day of cylinder analysis. To calibrate his analytical procedure, the manufacturer shall use as a minimum, a three point calibration curve. It is recommended that the manufacturer maintain (1) a high concentration calibration standard (between 50 and 100 ppmv) to prepare his calibration curve by an appropriate dilution technique and (2) a low-concentration calibration standard (between 5 and 10 ppmv) to verify the dilution technique used. If the difference between the apparent concentration read from the calibration curve and the true concentration assigned to the low-concentration calibration standard exceeds 5 percent of the true concentration, the manufacturer shall determine the source of error and correct it, then repeat the three-point calibration.

7.2.3.2 Verification of Manufacturer's Calibration Standards. Before using a standard, the manufacturer shall verify each calibration standard (a) by comparing it to gas mixtures prepared (with 99 mole percent vinyl chloride) in accordance with the procedure described in Section 7.2.1 or (b) calibrating it against vinyl chloride cylinder Standard Reference Materials (SRM's) prepared by the National Institute of Standards and Technology, if such SRM's are available. The agreement between the initially determined concentration value and the verification concentration value must be ±5 percent. The manufacturer must reverify all calibration standards on a time interval consistent with the shelf life of the cylinder standards sold.

8.0 Sample Collection, Preservation, Storage, and Transport

NOTE: Performance of this method should not be attempted by persons unfamiliar with the operation of a gas chromatograph (GC) nor by those who are unfamiliar with source sampling, because knowledge beyond the scope of this presentation is required.

8.1 Bag Leak-Check. The following leak-check procedure is recommended, but not required, prior to sample collection. The post-test leak-check procedure is mandatory. Connect a water manometer and pressurize the bag to 5 to 10 cm H₂O (2 to 4 in. H₂O). Allow to stand for 10 min. Any displacement in the water manometer indicates a leak. Also, check the rigid container for leaks in this manner.

NOTE: An alternative leak-check method is to pressurize the bag to 5 to 10 cm H₂O and allow it to stand overnight. A deflated bag indicates a leak. For each sample bag in its rigid container, place a rotameter in line between the bag and the pump inlet. Evacuate the bag. Failure of the rotameter to register zero flow when the bag appears to be empty indicates a leak.

8.2 Sample Collection. Assemble the sample train as shown in Figure 106-1. Join the quick connects as illustrated, and determine that all connection between the bag and the probe are tight. Place the end of the probe at the centroid of the stack and start the pump with the needle valve adjusted to yield a flow that will fill over 50 percent of bag volume in the specific sample period. After allowing sufficient time to purge the line several times, change the vacuum line from the container to the bag and evacuate the bag until the rotameter indicates no flow. Then reposition the sample and vacuum lines and begin the actual sampling, keeping the rate proportional to the stack velocity. At all times, direct the gas exiting the rotameter away from sampling personnel. At the end of the sample period, shut off the pump, disconnect the sample line from the bag, and disconnect the vacuum line from the bag container. Protect the bag container from sunlight.

8.3 Sample Storage. Keep the sample bags out of direct sunlight. When at all possible, analysis is to be performed within 24 hours, but in no case in excess of 72 hours of sample collection. Aluminized Mylar bag samples must be analyzed within 24 hours.

8.4 Post-test Bag Leak-Check. Subsequent to recovery and analysis of the sample, leak-check the sample bag according to the procedure outlined in Section 8.1.

9.0 QUALITY CONTROL

Section	Quality control measure	Effect
10.3	Chromatograph calibration	Ensure precision and accuracy of chromatograph.

10.0 Calibration and Standardization

NOTE: Maintain a laboratory log of all calibrations.

10.1 Preparation of Vinyl Chloride Standard Gas Mixtures. (Optional Procedure-delete if cylinder standards are used.) Evacuate a 16-inch square Tedlar bag that has passed a leak-check (described in Section 8.1) and meter in 5.0 liters of nitrogen. While the bag is filling, use the 0.5-ml syringe to inject 250 μ l of 99.9 + percent vinyl chloride gas through the wall of the bag. Upon withdrawing the syringe, immediately cover the resulting hole with a piece of adhesive tape. The bag now contains a vinyl chloride concentration of 50 ppmv. In a like manner use the 50 μ l syringe to prepare gas mixtures having 10- and 5-ppmv vinyl chloride concentrations. Place each bag on a smooth surface and alternately depress opposite sides of the bag 50 times to further mix the gases. These gas mixture standards may be used for 10 days from the date of preparation, after which time new gas mixtures must be prepared. (Caution: Contamination may be a problem when a bag is reused if the new gas mixture standard is a lower concentration than the previous gas mixture standard.)

10.2 Determination of Vinyl Chloride Retention Time. (This section can be performed simultaneously with Section 10.3.) Establish chromatograph conditions identical with those in Section 11.3. Determine proper attenuator position. Flush the sampling loop with helium or nitrogen and activate the sample valve. Record the injection time, sample loop temperature, column temperature, carrier gas flow rate, chart speed, and attenuator setting. Record peaks and detector responses that occur in the absence of vinyl chloride. Maintain conditions with the equipment plumbing arranged identically to Section 11.2, and flush the sample loop for 30 seconds at the rate of 100 ml/min with one of the vinyl chloride calibration mixtures. Then activate the sample valve. Record the injection time. Select the peak that corresponds to vinyl chloride. Measure the distance on the chart from the injection time to the time at which the peak maximum occurs. This quantity divided by the chart speed is defined as the retention time. Since other organics may be present in the sample, positive identification of the vinyl chloride peak must be made.

10.3 Preparation of Chromatograph Calibration Curve. Make a GC measurement of each gas mixture standard (described in Section 7.2.3 or 10.1) using conditions identical to those listed in Sections 11.2 and 11.3. Flush the sampling loop for 30 seconds at the rate of 100 ml/min with one of the standard mixtures, and activate the sample valve. Record the concentration of vinyl chloride injected (C_c), attenuator setting, chart speed, peak area, sample loop temperature, column temperature, carrier gas flow rate, and retention time. Record the barometric pressure. Calculate A_c , the peak area multiplied by the attenuator setting. Repeat until two consecutive injection areas are within 5 percent, then plot the average of those two values versus C_c . When the other standard gas mixtures have been similarly analyzed and plotted, draw a straight line through the points derived by the least squares method. Perform calibration daily, or before and after the analysis of each emission test set of bag samples, whichever is more frequent. For each group of sample analyses, use the average of the two calibration curves which bracket that group to determine the respective sample concentrations. If the two calibration curves differ by more than 5 percent from their mean value, then report the final results by both calibration curves.

11.0 Analytical Procedure

11.2 Sample Recovery. With a new piece of Teflon tubing identified for that bag, connect a bag inlet valve to the gas chromatograph sample valve. Switch the valve to receive gas from the bag through the sample loop. Arrange the equipment so the sample gas passes from the sample valve to 100-ml/min rotameter with flow control valve followed by a charcoal tube and a 1-in. H₂O pressure gauge. Maintain the sample flow either by a vacuum pump or container pressurization if the collection bag remains in the rigid container. After sample loop purging is ceased, allow the pressure gauge to return to zero before activating the gas sampling valve.

11.3 Analysis.

11.3.1 Set the column temperature to 100 °C (210 °F) and the detector temperature to 150 °C (300 °F). When optimum hydrogen and oxygen (or air) flow rates have been determined, verify and maintain these flow rates during all chromatography operations. Using helium or nitrogen as the carrier gas, establish a flow rate in the range consistent with the manufacturer's requirements for satisfactory detector operation. A flow rate of approximately 40 ml/min should produce adequate separations. Observe the base line periodically and determine that the noise level has stabilized and that base line drift has ceased. Purge the sample loop for 30 seconds at the rate of 100 ml/min, shut off flow, allow the sample loop pressure to reach atmospheric pressure as indicated by the H₂O manometer, then activate the sample valve. Record the injection time (the position of the pen on the chart at the time of sample injection), sample number, sample loop temperature, column temperature, carrier gas flow rate, chart speed, and attenuator setting. Record the barometric pressure. From the chart, note the peak having the retention time corresponding to vinyl chloride as determined in Section 10.2. Measure the vinyl chloride peak area, A_m , by use of a disc integrator, electronic integrator, or a planimeter. Measure and record the peak heights, H_m . Record A_m and retention time. Repeat the injection at least two times or until two consecutive values for the total area of the vinyl chloride peak agree within 5 percent of their average. Use the average value for these two total areas to compute the bag concentration.

11.3.2 Compare the ratio of H_m to A_m for the vinyl chloride sample with the same ratio for the standard peak that is closest in height. If these ratios differ by more than 10 percent, the vinyl chloride peak may not be pure (possibly acetaldehyde is present) and the secondary column should be employed (see Section 6.3.2.2).

11.4 Determination of Bag Water Vapor Content. Measure the ambient temperature and barometric pressure near the bag. From a water saturation vapor pressure table, determine and record the water vapor content of the bag, B_{wb} , as a decimal figure. (Assume the relative humidity to be 100 percent unless a lesser value is known.)

12.0 Calculations and Data Analysis

12.1 Nomenclature.

A_m = Measured peak area.

A_r = Attenuation factor.

B_{wb} = Water vapor content of the bag sample, as analyzed, volume fraction.

C_b = Concentration of vinyl chloride in the bag, ppmv.

C_c = Concentration of vinyl chloride in the standard sample, ppmv.

P_i = Laboratory pressure at time of analysis, mm Hg.

P_r = Reference pressure, the laboratory pressure recorded during calibration, mm Hg.

T_i = Absolute sample loop temperature at the time of analysis, °K (°R).

T_r = Reference temperature, the sample loop temperature recorded during calibration, °K (°R).

12.2 Sample Peak Area. Determine the sample peak area, A_c , as follows:

$$A_c = A_m A_r \quad \text{Eq. 106-1}$$

[View or download PDF](#)

12.3 Vinyl Chloride Concentration. From the calibration curves prepared in Section 10.3, determine the average concentration value of vinyl chloride, C_c , that corresponds to A_c , the sample peak area. Calculate the concentration of vinyl chloride in the bag, C_b , as follows:

$$C_b = \frac{C_c P_r T_i}{P_i T_r (1 - B_{vb})} \quad \text{Eq. 106-2}$$

[View or download PDF](#)

13.0 Method Performance

13.1 Analytical Range. This method is designed for the 0.1 to 50 parts per million by volume (ppmv) range. However, common gas chromatograph (GC) instruments are capable of detecting 0.02 ppmv vinyl chloride. With proper calibration, the upper limit may be extended as needed.

14.0 Pollution Prevention, [Reserved]

15.0 Waste Management, [Reserved]

16.0 References

1. Brown D.W., E.W. Loy, and M.H. Stephenson. Vinyl Chloride Monitoring Near the B. F. Goodrich Chemical Company in Louisville, KY. Region IV, U.S. Environmental Protection Agency, Surveillance and Analysis Division, Athens, GA. June 24, 1974.

2. G.D. Clayton and Associates. Evaluation of a Collection and Analytical Procedure for Vinyl Chloride in Air. U.S. Environmental Protection Agency, Research Triangle Park, N.C. EPA Contract No. 68-02-1408, Task Order No. 2, EPA Report No. 75-VCL-1. December 13, 1974.

3. Midwest Research Institute. Standardization of Stationary Source Emission Method for Vinyl Chloride. U.S. Environmental Protection Agency, Research Triangle Park, N.C. Publication No. EPA-600/4-77-026. May 1977.

4. Scheil, G. and M.C. Sharp. Collaborative Testing of EPA Method 106 (Vinyl Chloride) that Will Provide for a Standardized Stationary Source Emission Measurement Method. U.S. Environmental Protection Agency, Research Triangle Park, N.C. Publication No. EPA 600/4-78-058. October 1978.

17.0 Tables, Diagrams Flowcharts, and Validation Data.

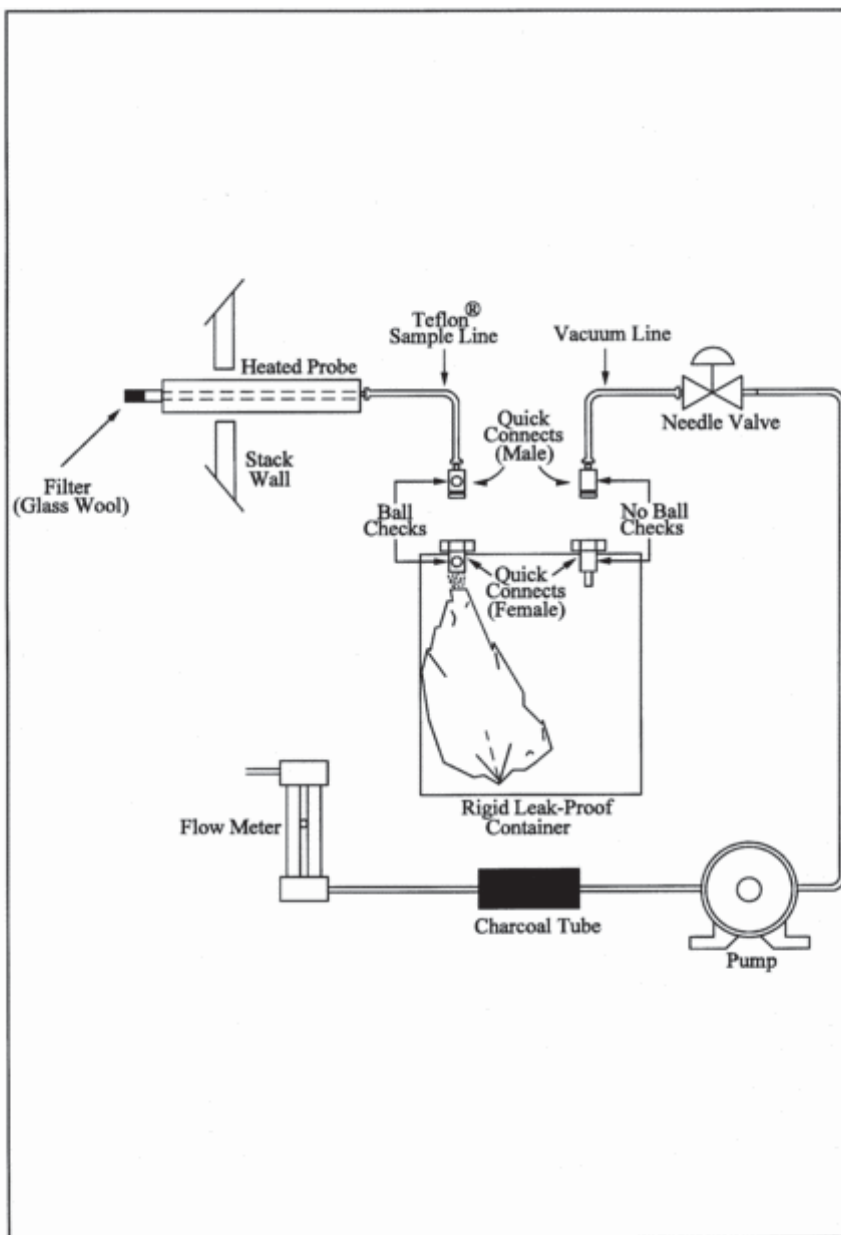

Figure 106-1. Integrated-bag sampling train.

[View or download PDF](#)

METHOD 107—DETERMINATION OF VINYL CHLORIDE CONTENT OF IN-PROCESS WASTEWATER SAMPLES, AND VINYL CHLORIDE CONTENT OF POLYVINYL CHLORIDE RESIN SLURRY, WET CAKE, AND LATEX SAMPLES

NOTE: Performance of this method should not be attempted by persons unfamiliar with the operation of a gas chromatograph (GC) nor by those who are unfamiliar with source sampling, because knowledge beyond the scope of this presentation is required. This method does not include all of the specifications (e.g., equipment and supplies) and procedures (e.g., sampling and analytical) essential to its performance. Some material is incorporated by reference from other methods in this part. Therefore, to obtain reliable results, persons using this method should have a thorough knowledge of at least the following additional test methods: Method 106.

1.0 Scope and Application

1.1 Analytes.

Analyte	CAS No.	Sensitivity
Vinyl Chloride (CH ₂ :CHCl)	75-01-4	Dependent upon analytical equipment.

1.2 Applicability. This method is applicable for the determination of the vinyl chloride monomer (VCM) content of in-process wastewater samples, and the residual vinyl chloride monomer (RCVM) content of polyvinyl chloride (PVC) resins, wet, cake, slurry, and latex samples. It cannot be used for polymer in fused forms, such as sheet or cubes. This method is not acceptable where methods from section 304(h) of the Clean Water Act, 33 U.S.C. 1251 *et seq.* (the Federal Water Pollution Control Amendments of 1972 as amended by the Clean Water Act of 1977) are required.

1.3 Data Quality Objectives. Adherence to the requirements of this method will enhance the quality of the data obtained from air pollutant sampling methods.

2.0 Summary of Method

2.1 The basis for this method relates to the vapor equilibrium that is established at a constant known temperature in a closed system between RVCM, PVC resin, water, and air. The RVCM in a PVC resin will equilibrate rapidly in a closed vessel, provided that the temperature of the PVC resin is maintained above the glass transition temperature of that specific resin.

2.2 A sample of PVC or in-process wastewater is collected in a vial or bottle and is conditioned. The headspace in the vial or bottle is then analyzed for vinyl chloride using gas chromatography with a flame ionization detector.

3.0 Definitions [Reserved]

4.0 Interferences

4.1 The chromatograph columns and the corresponding operating parameters herein described normally provide an adequate resolution of vinyl chloride; however, resolution interferences may be encountered on some sources. Therefore, the chromatograph operator shall select the column and operating parameters best suited to his particular analysis requirements, subject to the approval of the Administrator. Approval is automatic provided that confirming data are produced through an adequate supplemental analytical technique, such as analysis with a different column or GC/mass spectroscopy, and that these data are made available for review by the Administrator.

5.0 Safety

5.1 Disclaimer. This method may involve hazardous materials, operations, and equipment. This test method may not address all of the safety problems associated with its use. It is the responsibility of the user of this test method to establish appropriate safety and health practices and determine the applicability of regulatory limitations prior to performing this test method.

5.2 Toxic Analyte. Care must be exercised to prevent exposure of sampling personnel to vinyl chloride, which is a carcinogen. Do not release vinyl chloride to the laboratory atmosphere during preparation of standards. Venting or purging with VCM/air mixtures must be held to a minimum. When they are required, the vapor must be routed to outside air. Vinyl chloride, even at low ppm levels, must never be vented inside the laboratory. After vials have been analyzed, the gas must be vented prior to removal of the vial from the instrument turntable. Vials must be vented through a hypodermic needle

connected to an activated charcoal tube to prevent release of vinyl chloride into the laboratory atmosphere. The charcoal must be replaced prior to vinyl chloride breakthrough.

6.0 *Equipment and Supplies*

6.1 Sample Collection. The following equipment is required:

6.1.1 Glass bottles. 60-ml (2-oz) capacity, with wax-lined screw-on tops, for PVC samples.

6.1.2 Glass Vials. Headspace vials, with Teflon-faced butyl rubber sealing discs, for water samples.

6.1.3 Adhesive Tape. To prevent loosening of bottle tops.

6.2 Sample Recovery. The following equipment is required:

6.2.1 Glass Vials. Headspace vials, with butyl rubber septa and aluminum caps. Silicone rubber is not acceptable.

6.2.2 Analytical Balance. Capable of determining sample weight within an accuracy of ± 1 percent.

6.2.3 Vial Sealer. To seal headspace vials.

6.2.4 Syringe. 100-ml capacity.

6.3 Analysis. The following equipment is required:

6.3.1 Headspace Sampler and Chromatograph. Capable of sampling and analyzing a constant amount of headspace gas from a sealed vial, while maintaining that vial at a temperature of $90 \text{ }^{\circ}\text{C} \pm 0.5 \text{ }^{\circ}\text{C}$ ($194 \text{ }^{\circ}\text{F} \pm 0.9 \text{ }^{\circ}\text{F}$). The chromatograph shall be equipped with a flame ionization detector (FID). Perkin-Elmer Corporation Models F-40, F-42, F-45, HS-6, and HS-100, and Hewlett-Packard Corporation Model 19395A have been found satisfactory. Chromatograph backflush capability may be required.

6.3.2 Chromatographic Columns. Stainless steel 1 m by 3.2 mm and 2 m by 3.2 mm, both containing 50/80-mesh Porapak Q. Other columns may be used provided that the precision and accuracy of the analysis of vinyl chloride standards are not impaired and information confirming that there is adequate resolution of the vinyl chloride peak are available for review. (Adequate resolution is defined as an area overlap of not more than 10 percent of the vinyl chloride peak by an interferant peak. Calculation of area overlap is explained in Procedure 1 of appendix C to this part: "Determination of Adequate Chromatographic Peak Resolution.") Two 1.83 m columns, each containing 1 percent Carbowax 1500 on Carbowax B, have been found satisfactory for samples containing acetaldehyde.

6.3.3 Temperature Sensor. Range 0 to $100 \text{ }^{\circ}\text{C}$ (32 to $212 \text{ }^{\circ}\text{F}$) accurate to $0.1 \text{ }^{\circ}\text{C}$.

6.3.4 Integrator-Recorder. To record chromatograms.

6.3.5 Barometer. Accurate to 1 mm Hg.

6.3.6 Regulators. For required gas cylinders.

6.3.7 Headspace Vial Pre-Pressurizer. Nitrogen pressurized hypodermic needle inside protective shield.

7.0 Reagents and Standards

7.1 Analysis. Same as Method 106, Section 7.1, with the addition of the following:

7.1.1 Water. Interference-free.

7.2 Calibration. The following items are required for calibration:

7.2.1 Cylinder Standards (4). Gas mixture standards (50-, 500-, 2000- and 4000-ppm vinyl chloride in nitrogen cylinders). Cylinder standards may be used directly to prepare a chromatograph calibration curve as described in Section 10.3, if the following conditions are met: (a) The manufacturer certifies the gas composition with an accuracy of ± 3 percent or better (see Section 7.2.1.1). (b) The manufacturer recommends a maximum shelf life over which the gas concentration does not change by greater than ± 5 percent from the certified value. (c) The manufacturer affixes the date of gas cylinder preparation, certified vinyl chloride concentration, and recommended maximum shelf life to the cylinder before shipment to the buyer.

7.2.1.1 Cylinder Standards Certification. The manufacturer shall certify the concentration of vinyl chloride in nitrogen in each cylinder by (a) directly analyzing each cylinder and (b) calibrating the analytical procedure on the day of cylinder analysis. To calibrate the analytical procedure, the manufacturer shall use, as a minimum, a 3-point calibration curve. It is recommended that the manufacturer maintain (1) a high-concentration calibration standard (between 4000 and 8000 ppm) to prepare the calibration curve by an appropriate dilution technique and (2) a low-concentration calibration standard (between 50 and 500 ppm) to verify the dilution technique used. If the difference between the apparent concentration read from the calibration curve and the true concentration assigned to the low-concentration calibration standard exceeds 5 percent of the true concentration, the manufacturer shall determine the source of error and correct it, then repeat the 3-point calibration.

7.2.1.2 Verification of Manufacturer's Calibration Standards. Before using, the manufacturer shall verify each calibration standard by (a) comparing it to gas mixtures prepared (with 99 mole percent vinyl chloride) in accordance with the procedure described in Section 10.1 of Method 106 or by (b) calibrating it against vinyl chloride cylinder Standard Reference Materials (SRMs) prepared by the National Institute of Standards and Technology, if such SRMs are available. The agreement between the initially determined concentration value and the verification concentration value must be within 5 percent. The manufacturer must reverify all calibration standards on a time interval consistent with the shelf life of the cylinder standards sold.

8.0 Sample Collection, Preservation, Storage, and Transport

8.1 Sample Collection.

8.1.1 PVC Sampling. Allow the resin or slurry to flow from a tap on the tank or silo until the tap line has been well purged. Extend and fill a 60-ml sample bottle under the tap, and immediately tighten a cap on the bottle. Wrap adhesive tape around the cap and bottle to prevent the cap from loosening. Place an identifying label on each bottle, and record the date, time, and sample location both on the bottles and in a log book.

8.1.2 Water Sampling. At the sampling location fill the vials bubble-free to overflowing so that a convex meniscus forms at the top. The excess water is displaced as the sealing disc is carefully placed, with the Teflon side down, on the opening of the vial. Place the aluminum seal over the disc and the neck of the vial, and crimp into place. Affix an identifying label on the bottle, and record the date, time, and sample location both on the vials and in a log book.

8.2 Sample Storage. All samples must be analyzed within 24 hours of collection, and must be refrigerated during this period.

9.0 Quality Control

Section	Quality control measure	Effect
10.3	Chromatograph calibration	Ensure precision and accuracy of chromatograph.

10.0 Calibration and Standardization

NOTE: Maintain a laboratory log of all calibrations.

10.1 Preparation of Standards. Calibration standards are prepared as follows: Place 100 µl or about two equal drops of distilled water in the sample vial, then fill the vial with the VCM/nitrogen standard, rapidly seat the septum, and seal with the aluminum cap. Use a 1/8 -in. stainless steel line from the cylinder to the vial. Do not use rubber or Tygon tubing. The sample line from the cylinder must be purged (into a properly vented hood) for several minutes prior to filling the vials. After purging, reduce the flow rate to between 500 and 1000 cc/min. Place end of tubing into vial (near bottom). Position a septum on top of the vial, pressing it against the 1/8 -in. filling tube to minimize the size of the vent opening. This is necessary to minimize mixing air with the standard in the vial. Each vial is to be purged with standard for 90 seconds, during which time the filling tube is gradually slid to the top of the vial. After the 90 seconds, the tube is removed with the septum, simultaneously sealing the vial. Practice will be necessary to develop good technique. Rubber gloves should be worn during the above operations. The sealed vial must then be pressurized for 60 seconds using the vial prepressurizer. Test the vial for leakage by placing a drop of water on the septum at the needle hole. Prepressurization of standards is not required unless samples have been prepressurized.

10.2 Analyzer Calibration. Calibration is to be performed each 8-hour period the chromatograph is used. Alternatively, calibration with duplicate 50-, 500-, 2,000-, and 4,000-ppm standards (hereafter described as a four-point calibration) may be performed on a monthly basis, provided that a calibration confirmation test consisting of duplicate analyses of an appropriate standard is performed once per plant shift, or once per chromatograph carousel operation (if the chromatograph operation is less frequent than once per shift). The criterion for acceptance of each calibration confirmation test is that both analyses of 500-ppm standards [2,000-ppm standards if dispersion resin (excluding latex resin) samples are being analyzed] must be within 5 percent of the most recent four-point calibration curve. If this criterion is not met, then a complete four-point calibration must be performed before sample analyses can proceed.

10.3 Preparation of Chromatograph Calibration Curve. Prepare two vials each of 50-, 500-, 2,000-, and 4,000-ppm standards. Run the calibration samples in exactly the same manner as regular samples. Plot A_s , the integrator area counts for each standard sample, versus C_s , the concentration of vinyl chloride in each standard sample. Draw a straight line through the points derived by the least squares method.

11.0 Analytical Procedure

11.1 Preparation of Equipment. Install the chromatographic column and condition overnight at 160 °C (320 °F). In the first operation, Porapak columns must be purged for 1 hour at 230 °C (450 °F).

Do not connect the exit end of the column to the detector while conditioning. Hydrogen and air to the detector must be turned off while the column is disconnected.

11.2 Flow Rate Adjustments. Adjust flow rates as follows:

11.2.1. Nitrogen Carrier Gas. Set regulator on cylinder to read 50 psig. Set regulator on chromatograph to produce a flow rate of 30.0 cc/min. Accurately measure the flow rate at the exit end of the column using the soap film flowmeter and a stopwatch, with the oven and column at the analysis temperature. After the instrument program advances to the "B" (backflush) mode, adjust the nitrogen pressure regulator to exactly balance the nitrogen flow rate at the detector as was obtained in the "A" mode.

11.2.2. Vial Prepressurizer Nitrogen.

11.2.2.1 After the nitrogen carrier is set, solve the following equation and adjust the pressure on the vial prepressurizer accordingly.

$$P = \frac{T_1}{T_2} \left[P_1 - \frac{P_{w1} - P_{w2}}{7.50} \right] - 10 \text{ kPa} \quad \text{Eq. 107-1}$$

[View or download PDF](#)

Where:

T_1 = Ambient temperature, °K (°R).

T_2 = Conditioning bath temperature, °K (°R).

P_1 = Gas chromatograph absolute dosing pressure (analysis mode), k Pa.

P_{w1} = Water vapor pressure 525.8 mm Hg @ 90 °C.

P_{w2} = Water vapor pressure 19.8 mm Hg @ 22 °C.

7.50 = mm Hg per k Pa.

10 kPa = Factor to adjust the prepressurized pressure to slightly less than the dosing pressure.

11.2.2.2 Because of gauge errors, the apparatus may over-pressurize the vial. If the vial pressure is at or higher than the dosing pressure, an audible double injection will occur. If the vial pressure is too low, errors will occur on resin samples because of inadequate time for head-space gas equilibrium. This condition can be avoided by running several standard gas samples at various pressures around the calculated pressure, and then selecting the highest pressure that does not produce a double injection. All samples and standards must be pressurized for 60 seconds using the vial prepressurizer. The vial is then placed into the 90 °C conditioning bath and tested for leakage by placing a drop of water on the septum at the needle hole. A clean, burr-free needle is mandatory.

11.2.3. Burner Air Supply. Set regulator on cylinder to read 50 psig. Set regulator on chromatograph to supply air to burner at a rate between 250 and 300 cc/min. Check with bubble flowmeter.

11.2.4. Hydrogen Supply. Set regulator on cylinder to read 30 psig. Set regulator on chromatograph to supply approximately 35 ±5 cc/min. Optimize hydrogen flow to yield the most sensitive detector response without extinguishing the flame. Check flow with bubble meter and record this flow.

11.3 Temperature Adjustments. Set temperatures as follows:

11.3.1. Oven (chromatograph column), 140 °C (280 °F).

11.3.2. Dosing Line, 150 °C (300 °F).

11.3.3. Injection Block, 170 °C (340 °F).

11.3.4. Sample Chamber, Water Temperature, 90 °C ±1.0 °C (194 °F ±1.8 °F).

11.4 Ignition of Flame Ionization Detector. Ignite the detector according to the manufacturer's instructions.

11.5 Amplifier Balance. Balance the amplifier according to the manufacturer's instructions.

11.6 Programming the Chromatograph. Program the chromatograph as follows:

11.6.1. I—Dosing or Injection Time. The normal setting is 2 seconds.

11.6.2. A—Analysis Time. The normal setting is approximately 70 percent of the VCM retention time. When this timer terminates, the programmer initiates backflushing of the first column.

11.6.3. B—Backflushing Time. The normal setting is double the analysis time.

11.6.4. W—Stabilization Time. The normal setting is 0.5 min to 1.0 min.

11.6.5. X—Number of Analyses Per Sample. The normal setting is one.

11.7. Sample Treatment. All samples must be recovered and analyzed within 24 hours after collection.

11.7.1 Resin Samples. The weight of the resin used must be between 0.1 and 4.5 grams. An exact weight must be obtained (within ±1 percent) for each sample. In the case of suspension resins, a volumetric cup can be prepared for holding the required amount of sample. When the cup is used, open the sample bottle, and add the cup volume of resin to the tared sample vial (tared, including septum and aluminum cap). Obtain the exact sample weight, add 100 ml or about two equal drops of water, and immediately seal the vial. Report this value on the data sheet; it is required for calculation of RVCM. In the case of dispersion resins, the cup cannot be used. Weigh the sample in an aluminum dish, transfer the sample to the tared vial, and accurately weigh it in the vial. After prepressurization of the samples, condition them for a minimum of 1 hour in the 90 °C (190 °F) bath. Do not exceed 5 hours. Prepressurization is not required if the sample weight, as analyzed, does not exceed 0.2 gram. It is also not required if solution of the prepressurization equation yields an absolute prepressurization value that is within 30 percent of the atmospheric pressure.

NOTE: Some aluminum vial caps have a center section that must be removed prior to placing into sample tray. If the cap is not removed, the injection needle will be damaged.

11.7.2 Suspension Resin Slurry and Wet Cake Samples. Decant the water from a wet cake sample, and turn the sample bottle upside down onto a paper towel. Wait for the water to drain, place approximately 0.2 to 4.0 grams of the wet cake sample in a tared vial (tared, including septum and aluminum cap) and seal immediately. Then determine the sample weight (1 percent). All samples weighing over 0.2 gram, must be prepressurized prior to conditioning for 1 hour at 90 °C (190 °F), except as noted in Section 11.7.1. A sample of wet cake is used to determine total solids (TS). This is required for calculating the RVCM.

11.7.3 Dispersion Resin Slurry and Geon Latex Samples. The materials should not be filtered. Sample must be thoroughly mixed. Using a tared vial (tared, including septum and aluminum cap) add

approximately eight drops (0.25 to 0.35 g) of slurry or latex using a medicine dropper. This should be done immediately after mixing. Seal the vial as soon as possible. Determine sample weight (1 percent). Condition the vial for 1 hour at 90 °C (190 °F) in the analyzer bath. Determine the TS on the slurry sample (Section 11.10).

11.7.4 In-process Wastewater Samples. Using a tared vial (tared, including septum and aluminum cap) quickly add approximately 1 cc of water using a medicine dropper. Seal the vial as soon as possible. Determine sample weight (1 percent). Condition the vial for 1 hour at 90 °C (190 °F) in the analyzer bath.

11.8 Preparation of Sample Turntable.

11.8.1 Before placing any sample into turntable, be certain that the center section of the aluminum cap has been removed. The numbered sample vials should be placed in the corresponding numbered positions in the turntable. Insert samples in the following order:

11.8.1.1 Positions 1 and 2. Old 2000-ppm standards for conditioning. These are necessary only after the analyzer has not been used for 24 hours or longer.

11.8.1.2 Position 3. 50-ppm standard, freshly prepared.

11.8.1.3 Position 4. 500-ppm standard, freshly prepared.

11.8.1.4 Position 5. 2000-ppm standard, freshly prepared.

11.8.1.5 Position 6. 4000-ppm standard, freshly prepared.

11.8.1.6 Position 7. Sample No. 7 (This is the first sample of the day, but is given as 7 to be consistent with the turntable and the integrator printout.)

11.8.2 After all samples have been positioned, insert the second set of 50-, 500-, 2000-, and 4000-ppm standards. Samples, including standards, must be conditioned in the bath of 90 °C (190 °F) for a minimum of one hour and a maximum of five hours.

11.9 Start Chromatograph Program. When all samples, including standards, have been conditioned at 90 °C (190 °F) for at least one hour, start the analysis program according to the manufacturer's instructions. These instructions must be carefully followed when starting and stopping a program to prevent damage to the dosing assembly.

11.10 Determination of Total Solids. For wet cake, slurry, resin solution, and PVC latex samples, determine TS for each sample by accurately weighing approximately 3 to 4 grams of sample in an aluminum pan before and after placing in a draft oven (105 to 110 °C (221 to 230 °F)). Samples must be dried to constant weight. After first weighing, return the pan to the oven for a short period of time, and then reweigh to verify complete dryness. The TS are then calculated as the final sample weight divided by initial sample weight.

12.0 Calculations and Data Analysis

12.1 Nomenclature.

A_s = Chromatogram area counts of vinyl chloride for the sample, area counts.

A_s = Chromatogram area counts of vinyl chloride for the sample.

C_c = Concentration of vinyl chloride in the standard sample, ppm.

K_p = Henry's Law Constant for VCM in PVC 90 °C, 6.52×10^{-6} g/g/mm Hg.

K_w = Henry's Law Constant for VCM in water 90 °C, 7×10^{-7} g/g/mm Hg.

M_v = Molecular weight of VCM, 62.5 g/mole.

m = Sample weight, g.

P_a = Ambient atmospheric pressure, mm Hg.

R = Gas constant, (62360 ³ ml) (mm Hg)/(mole)(°K).

R_f = Response factor in area counts per ppm VCM.

R_s = Response factor, area counts/ppm.

T_1 = Ambient laboratory temperature, °K.

TS = Total solids expressed as a decimal fraction.

T_2 = Equilibrium temperature, °K.

V_g = Volume of vapor phase, ml.

$$= V_v - \frac{m(TS)}{1.36} - \frac{m(1-TS)}{0.9653}$$

[View or download PDF](#)

V_v = Vial volume, ³ ml.

1.36 = Density of PVC at 90 °C, g/³ ml.

0.9653 = Density of water at 90 °C, g/³ ml.

12.2 Response Factor. If the calibration curve described in Section 10.3 passes through zero, an average response factor, R_f , may be used to facilitate computation of vinyl chloride sample concentrations.

12.2.1 To compute R_f , first compute a response factor, R_s , for each sample as follows:

$$R_s = \frac{A_s}{C_c} \quad \text{Eq. 107-2}$$

[View or download PDF](#)

12.2.2 Sum the individual response factors, and calculate R_f . If the calibration curve does not pass through zero, use the calibration curve to determine each sample concentration.

12.3 Residual Vinyl Chloride Monomer Concentration, (C_{vc}) or Vinyl Chloride Monomer Concentration. Calculate C_{vc} in ppm or mg/kg as follows:

$$C_{vc} = \frac{A_s P_a}{R_f T_1} \left[\frac{M_v V_g}{R m} + K_p (TS) T_2 K_w (1-TS) T_2 \right] \quad \text{Eq. 107-3}$$

[View or download PDF](#)

NOTE: Results calculated using these equations represent concentration based on the total sample. To obtain results based on dry PVC content, divide by TS.

13.0 Method Performance

13.1 Range and Sensitivity. The lower limit of detection of vinyl chloride will vary according to the sampling and chromatographic system. The system should be capable of producing a measurement for a 50-ppm vinyl chloride standard that is at least 10 times the standard deviation of the system background noise level.

13.2 An interlaboratory comparison between seven laboratories of three resin samples, each split into three parts, yielded a standard deviation of 2.63 percent for a sample with a mean of 2.09 ppm, 4.16 percent for a sample with a mean of 1.66 ppm, and 5.29 percent for a sample with a mean of 62.66 ppm.

14.0 Pollution Prevention [Reserved]

15.0 Waste Management [Reserved]

16.0 References

1. B.F. Goodrich, Residual Vinyl Chloride Monomer Content of Polyvinyl Chloride Resins, Latex, Wet Cake, Slurry and Water Samples. B.F. Goodrich Chemical Group Standard Test Procedure No. 1005-E. B.F. Goodrich Technical Center, Avon Lake, Ohio. October 8, 1979.
2. Berens, A.R. The Diffusion of Vinyl Chloride in Polyvinyl Chloride. ACS-Division of Polymer Chemistry, Polymer Preprints 15 (2):197. 1974.
3. Berens, A.R. The Diffusion of Vinyl Chloride in Polyvinyl Chloride. ACS-Division of Polymer Chemistry, Polymer Preprints 15 (2):203. 1974.
4. Berens, A.R., *et. al.* Analysis for Vinyl Chloride in PVC Powders by Head-Space Gas Chromatography. Journal of Applied Polymer Science. 19:3169-3172. 1975.
5. Mansfield, R.A. The Evaluation of Henry's Law Constant (Kp) and Water Enhancement in the Perkin-Elmer Multifract F-40 Gas Chromatograph. B.F. Goodrich. Avon Lake, Ohio. February 10, 1978.

17.0 Tables, Diagrams, Flowcharts, and Validation Data [Reserved]

METHOD 107A—DETERMINATION OF VINYL CHLORIDE CONTENT OF SOLVENTS, RESIN-SOLVENT SOLUTION, POLYVINYL CHLORIDE RESIN, RESIN SLURRY, WET RESIN, AND LATEX SAMPLES

Introduction

Performance of this method should not be attempted by persons unfamiliar with the operation of a gas chromatograph (GC) or by those who are unfamiliar with source sampling because knowledge beyond the scope of this presentation is required. Care must be exercised to prevent exposure of sampling personnel to vinyl chloride, a carcinogen.

1. Applicability and Principle

1.1 Applicability. This is an alternative method and applies to the measurement of the vinyl chloride content of solvents, resin solvent solutions, polyvinyl chloride (PVC) resin, wet cake slurries, latex, and

fabricated resin samples. This method is not acceptable where methods from Section 304(h) of the Clean Water Act, 33 U.S.C. 1251 *et seq.*, (the Federal Water Pollution Control Act Amendments of 1972 as amended by the Clean Water Act of 1977) are required.

1.2 Principle. The basis for this method lies in the direct injection of a liquid sample into a chromatograph and the subsequent evaporation of all volatile material into the carrier gas stream of the chromatograph, thus permitting analysis of all volatile material including vinyl chloride.

2. Range and Sensitivity

The lower limit of detection of vinyl chloride in dry PVC resin is 0.2 ppm. For resin solutions, latexes, and wet resin, this limit rises inversely as the nonvolatile (resin) content decreases.

With proper calibration, the upper limit may be extended as needed.

3. Interferences

The chromatograph columns and the corresponding operating parameters herein described normally provide an adequate resolution of vinyl chloride. In cases where resolution interferences are encountered, the chromatograph operator shall select the column and operating parameters best suited to his particular analysis problem, subject to the approval of the Administrator. Approval is automatic, provided that the tester produces confirming data through an adequate supplemental analytical technique, such as analysis with a different column or GC/mass spectroscopy, and has the data available for review by the Administrator.

4. Precision and Reproducibility

A standard sample of latex containing 181.8 ppm vinyl chloride analyzed 10 times by the alternative method showed a standard deviation of 7.5 percent and a mean error of 0.21 percent.

A sample of vinyl chloride copolymer resin solution was analyzed 10 times by the alternative method and showed a standard deviation of 6.6 percent at a level of 35 ppm.

5. Safety

Do not release vinyl chloride to the laboratory atmosphere during preparation of standards. Venting or purging with vinyl chloride monomer (VCM) air mixtures must be held to minimum. When purging is required, the vapor must be routed to outside air. Vinyl chloride, even at low-ppm levels, must never be vented inside the laboratory.

6. Apparatus

6.1 Sampling. The following equipment is required:

6.1.1 Glass Bottles. 16-oz wide mouth wide polyethylene-lined, screw-on tops.

6.1.2 Adhesive Tape. To prevent loosening of bottle tops.

6.2 Sample Recovery. The following equipment is required:

6.2.1 Glass Vials. 20-ml capacity with polycone screw caps.

6.2.2 Analytical Balance. Capable of weighing to ± 0.01 gram.

6.2.3 Syringe. 50-microliter size, with removable needle.

6.2.4 Fritted Glass Sparger. Fine porosity.

6.2.5 Aluminum Weighing Dishes.

6.2.6 Sample Roller or Shaker. To help dissolve sample.

6.3 Analysis. The following equipment is required:

6.3.1 Gas Chromatograph. Hewlett Packard Model 5720A or equivalent.

6.3.2 Chromatograph Column. Stainless steel, 6.1 m by 3.2 mm, packed with 20 percent Tergitol E-35 on Chromosorb W AW 60/80 mesh. The analyst may use other columns provided that the precision and accuracy of the analysis of vinyl chloride standards are not impaired and that he has available for review information confirming that there is adequate resolution of the vinyl chloride peak. (Adequate resolution is defined as an area overlap of not more than 10 percent of the vinyl chloride peak by an interfering peak. Calculation of area overlap is explained in Appendix C, Procedure 1: "Determination of Adequate Chromatographic Peak Resolution.")

6.3.3 Valco Instrument Six-Port Rotary Valve. For column back flush.

6.3.4 Septa. For chromatograph injection port.

6.3.5 Injection Port Liners. For chromatograph used.

6.3.6 Regulators. For required gas cylinders.

6.3.7 Soap Film Flowmeter. Hewlett Packard No. 0101-0113 or equivalent.

6.4 Calibration. The following equipment is required:

6.4.1 Analytical Balance. Capable of weighing to ± 0.0001 g.

6.4.2 Erlenmeyer Flask With Glass Stopper. 125 ml.

6.4.3 Pipets. 0.1, 0.5, 1, 5, 10, and 50 ml.

6.4.4 Volumetric Flasks. 10 and 100 ml.

7. Reagents

Use only reagents that are of chromatograph grade.

7.1 Analysis. The following items are required:

7.1.1 Hydrogen Gas. Zero grade.

7.1.2 Nitrogen Gas. Zero grade.

7.1.3 Air. Zero grade.

7.1.4 Tetrahydrofuran (THF). Reagent grade.

Analyze the THF by injecting 10 microliters into the prepared gas chromatograph. Compare the THF chromatogram with that shown in Figure 107A-1. If the chromatogram is comparable to A, the THF should be sparged with pure nitrogen for approximately 2 hours using the fritted glass sparger to attempt to remove the interfering peak. Reanalyze the sparged THF to determine whether the THF is acceptable for use. If the scan is comparable to B, the THF should be acceptable for use in the analysis.

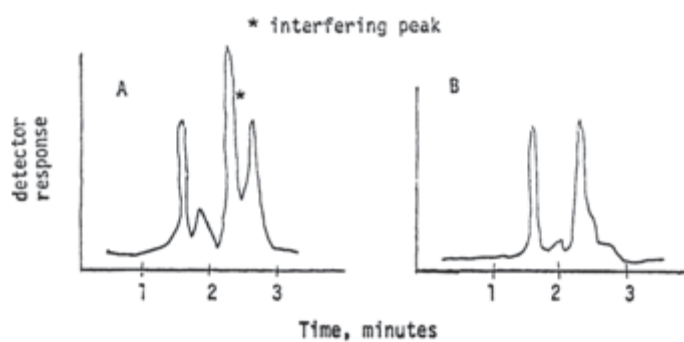

[View or download PDF](#)

7.1.5 N, N-Dimethylacetamide (DMAC). Spectrographic grade. For use in place of THF.

7.2 Calibration. The following item is required:

7.2.1 Vinyl Chloride 99.9 Percent. Ideal Gas Products lecture bottle, or equivalent. For preparation of standard solutions.

8. Procedure

8.1 Sampling. Allow the liquid or dried resin to flow from a tap on the tank, silo, or pipeline until the tap has been purged. Fill a wide-mouth pint bottle, and immediately tightly cap the bottle. Place an identifying label on each bottle and record the date, time, sample location, and material.

8.2 Sample Treatment. Sample must be run within 24 hours.

8.2.1 Resin Samples. Weigh 9.00 ± 0.01 g of THF or DMAC in a tared 20-ml vial. Add 1.00 ± 0.01 g of resin to the tared vial containing the THF or DMAC. Close the vial tightly with the screw cap, and shake or otherwise agitate the vial until complete solution of the resin is obtained. Shaking may require several minutes to several hours, depending on the nature of the resin.

8.2.2 Suspension Resin Slurry and Wet Resin Sample. Slurry must be filtered using a small Buchner funnel with vacuum to yield a wet resin sample. The filtering process must be continued only as long as a steady stream of water is exiting from the funnel. Excessive filtration time could result in some loss of VCM. The wet resin sample is weighed into a tared 20-ml vial with THF or DMAC as described earlier for resin samples (8.2.1) and treated the same as the resin sample. A sample of the wet resin is used to determine total solids as required for calculating the residual VCM (Section 8.3.4).

8.2.3 Latex and Resin Solvent Solutions. Samples must be thoroughly mixed. Weigh 1.00 ± 0.01 g of the latex or resin-solvent solution into a 20-ml vial containing 9.00 ± 0.01 g of THF or DMAC as for the resin samples (8.2.1). Cap and shake until complete solution is obtained. Determine the total solids of the latex or resin solution sample (Section 8.3.4).

8.2.4 Solvents and Non-viscous Liquid Samples. No preparation of these samples is required. The neat samples are injected directly into the GC.

8.3 Analysis.

8.3.1 Preparation of GC. Install the chromatographic column, and condition overnight at $70\text{ }^{\circ}\text{C}$. Do not connect the exit end of the column to the detector while conditioning.

8.3.1.1 Flow Rate Adjustments. Adjust the flow rate as follows:

a. Nitrogen Carrier Gas. Set regulator on cylinder to read 60 psig. Set column flow controller on the chromatograph using the soap film flowmeter to yield a flow rate of 40 cc/min.

b. Burner Air Supply. Set regulator on the cylinder at 40 psig. Set regulator on the chromatograph to supply air to the burner to yield a flow rate of 250 to 300 cc/min using the flowmeter.

c. Hydrogen. Set regulator on cylinder to read 60 psig. Set regulator on the chromatograph to supply 30 to 40 cc/min using the flowmeter. Optimize hydrogen flow to yield the most sensitive detector response without extinguishing the flame. Check flow with flowmeter and record this flow.

d. Nitrogen Back Flush Gas. Set regulator on the chromatograph using the soap film flowmeter to yield a flow rate of 40 cc/min.

8.3.1.2 Temperature Adjustments. Set temperature as follows:

a. Oven (chromatographic column) at $70\text{ }^{\circ}\text{C}$.

b. Injection Port at $100\text{ }^{\circ}\text{C}$.

c. Detector at $300\text{ }^{\circ}\text{C}$.

8.3.1.3 Ignition of Flame Ionization Detector. Ignite the detector according to the manufacturer's instructions. Allow system to stabilize approximately 1 hour.

8.3.1.4 Recorder. Set pen at zero and start chart drive.

8.3.1.5 Attenuation. Set attenuation to yield desired peak height depending on sample VCM content.

8.3.2 Chromatographic Analyses.

a. Sample Injection. Remove needle from 50-microliter syringe. Open sample vial and draw 50-microliters of THF or DMAC sample recovery solution into the syringe. Recap sample vial. Attach needle to the syringe and while holding the syringe vertically (needle uppermost), eject 40 microliters into an absorbent tissue. Wipe needle with tissue. Now inject 10 microliters into chromatograph system. Repeat the injection until two consecutive values for the height of the vinyl chloride peak do not vary more than 5 percent. Use the average value for these two peak heights to compute the sample concentration.

b. Back Flush. After 4 minutes has elapsed after sample injection, actuate the back flush valve to purge the first 4 feet of the chromatographic column of solvent and other high boilers.

c. Sample Data. Record on the chromatograph strip chart the data from the sample label.

d. Elution Time. Vinyl chloride elutes at 2.8 minutes. Acetaldehyde elutes at 3.7 minutes. Analysis is considered complete when chart pen becomes stable. After 5 minutes, reset back flush valve and inject next sample.

8.3.3 Chromatograph Servicing.

a. Septum. Replace after five sample injections.

b. Sample Port Liner. Replace the sample port liner with a clean spare after five sample injections.

c. Chromatograph Shutdown. If the chromatograph has been shut down overnight, rerun one or more samples from the preceding day to test stability and precision prior to starting on the current day's work.

8.3.4 Determination of Total Solids (TS). For wet resin, resin solution, and PVC latex samples, determine the TS for each sample by accurately weighing approximately 3 to 5 grams of sample into a tared aluminum pan. The initial procedure is as follows:

a. Where water is the major volatile component: Tare the weighing dish, and add 3 to 5 grams of sample to the dish. Weigh to the nearest milligram.

b. Where volatile solvent is the major volatile component: Transfer a portion of the sample to a 20-ml screw cap vial and cap immediately. Weigh the vial to the nearest milligram. Uncap the vial and transfer a 3- to 5-gram portion of the sample to a tared aluminum weighing dish. Recap the vial and reweigh to the nearest milligram. The vial weight loss is the sample weight.

To continue, place the weighing pan in a 130 °C oven for 1 hour. Remove the dish and allow to cool to room temperature in a desiccator. Weigh the pan to the nearest 0.1 mg. Total solids is the weight of material in the aluminum pan after heating divided by the net weight of sample added to the pan originally times 100.

9. Calibration of the Chromatograph

9.1 Preparation of Standards. Prepare a 1 percent by weight (approximate) solution of vinyl chloride in THF or DMAC by bubbling vinyl chloride gas from a cylinder into a tared 125-ml glass-stoppered flask containing THF or DMAC. The weight of vinyl chloride to be added should be calculated prior to this operation, i.e., 1 percent of the weight of THF or DMAC contained in the tared flask. This must be carried out in a laboratory hood. Adjust the vinyl chloride flow from the cylinder so that the vinyl chloride dissolves essentially completely in the THF or DMAC and is not blown to the atmosphere. Take particular care not to volatilize any of the solution. Stopper the flask and swirl the solution to effect complete mixing. Weigh the stoppered flask to nearest 0.1 mg to determine the exact amount of vinyl chloride added.

Pipet 10 ml of the approximately 1 percent solution into a 100-ml glass-stoppered volumetric flask, and add THF or DMAC to fill to the mark. Cap the flask and invert 10 to 20 times. This solution contains approximately 1,000 ppm by weight of vinyl chloride (note the exact concentration).

Pipet 50-, 10-, 5-, 1-, 0.5-, and 0.1-ml aliquots of the approximately 1,000 ppm solution into 10 ml glass stoppered volumetric flasks. Dilute to the mark with THF or DMAC, cap the flasks and invert each 10 to 20 times. These solutions contain approximately 500, 100, 50, 10, 5, and 1 ppm vinyl chloride. Note the exact concentration of each one. These standards are to be kept under refrigeration in stoppered bottles, and must be renewed every 3 months.

9.2 Preparation of Chromatograph Calibration Curve.

Obtain the GC for each of the six final solutions prepared in Section 9.1 by using the procedure in Section 8.3.2. Prepare a chart plotting peak height obtained from the chromatogram of each solution versus the known concentration. Draw a straight line through the points derived by the least squares method.

10. Calculations

10.1 Response Factor. From the calibration curve described in Section 9.2, select the value of C_c that corresponds to H_c for each sample. Compute the response factor, R_f , for each sample as follows:

$$R_f = \frac{C_c}{H_c} \quad \text{Eq. 107A-1}$$

[View or download PDF](#)

where:

R_f = Chromatograph response factor, ppm/mm.

C_c = Concentration of vinyl chloride in the standard sample, ppm.

H_c = Peak height of the standard sample, mm.

10.2 Residual vinyl chloride monomer concentration (C_{rvc}) or vinyl chloride monomer concentration in resin:

$$C_{rvc} = 10H_s R_f \quad \text{Eq. 107A-2}$$

[View or download PDF](#)

Where:

C_{rvc} = Concentration of residual vinyl chloride monomer, ppm.

H_s = Peak height of sample, mm.

R_f = Chromatograph response factor.

10.3 Samples containing volatile material, i.e., resin solutions, wet resin, and latexes:

$$C_{rvc} = \frac{H_s R_f (1,000)}{TS} \quad \text{Eq. 107A-3}$$

[View or download PDF](#)

where:

TS = Total solids in the sample, weight fraction.

10.4 Samples of solvents and in process wastewater:

$$C_{inc} = \frac{H_s R_f}{0.888} \quad \text{Eq. 107A-4}$$

[View or download PDF](#)

Where:

0.888 = Specific gravity of THF.

11. Bibliography

1. Communication from R. N. Wheeler, Jr.; Union Carbide Corporation. Part 61 National Emissions Standards for Hazardous Air Pollutants appendix B, Method 107—Alternate Method, September 19, 1977.

METHOD 108—DETERMINATION OF PARTICULATE AND GASEOUS ARSENIC EMISSIONS

NOTE: This method does not include all of the specifications (e.g., equipment and supplies) and procedures (e.g., sampling and analytical) essential to its performance. Some material is incorporated by reference from other methods in appendix A to 40 CFR part 60. Therefore, to obtain reliable results, persons using this method should have a thorough knowledge of at least the following additional test methods: Method 1, Method 2, Method 3, Method 5, and Method 12.

1.0 Scope and Application.

1.1 Analytes.

Analyte	CAS No.	Sensitivity
Arsenic compounds as arsenic (As)	7440-38-2	Lower limit 10 µg/ml or less.

1.2 Applicability. This method is applicable for the determination of inorganic As emissions from stationary sources as specified in an applicable subpart of the regulations.

1.3 Data Quality Objectives. Adherence to the requirements of this method will enhance the quality of the data obtained from air pollutant sampling methods.

2.0 Summary of Method

Particulate and gaseous As emissions are withdrawn isokinetically from the source and are collected on a glass mat filter and in water. The collected arsenic is then analyzed by means of atomic absorption spectrophotometry (AAS).

3.0 Definitions. [Reserved]

4.0 Interferences

Analysis for As by flame AAS is sensitive to the chemical composition and to the physical properties (e.g., viscosity, pH) of the sample. The analytical procedure includes a check for matrix effects (Section 11.5).

5.0 Safety

5.1 This method may involve hazardous materials, operations, and equipment. This test method may not address all of the safety problems associated with its use. It is the responsibility of the user to establish appropriate safety and health practices and determine the applicability of regulatory limitations prior to performing this test method.

5.2 Corrosive reagents. The following reagents are hazardous. Personal protective equipment and safe procedures that prevent chemical splashes are recommended. If contact occurs, immediately flush with copious amounts of water for at least 15 minutes. Remove clothing under shower and decontaminate. Treat residual chemical burns as thermal burns.

5.2.1 Hydrochloric Acid (HCl). Highly corrosive liquid with toxic vapors. Vapors are highly irritating to eyes, skin, nose, and lungs, causing severe damage. May cause bronchitis, pneumonia, or edema of lungs. Exposure to concentrations of 0.13 to 0.2 percent can be lethal to humans in a few minutes. Provide ventilation to limit exposure. Reacts with metals, producing hydrogen gas.

5.2.2 Hydrogen Peroxide (H₂O₂). Very harmful to eyes. 30% H₂O₂ can burn skin, nose, and lungs.

5.2.3 Nitric Acid (HNO₃). Highly corrosive to eyes, skin, nose, and lungs. Vapors are highly toxic and can cause bronchitis, pneumonia, or edema of lungs. Reaction to inhalation may be delayed as long as 30 hours and still be fatal. Provide ventilation to limit exposure. Strong oxidizer. Hazardous reaction may occur with organic materials such as solvents.

5.2.4 Sodium Hydroxide (NaOH). Causes severe damage to eyes and skin. Inhalation causes irritation to nose, throat, and lungs. Reacts exothermically with small amounts of water.

6.0 Equipment and Supplies

6.1 Sample Collection. A schematic of the sampling train used in performing this method is shown in Figure 108-1; it is similar to the Method 5 sampling train of 40 CFR part 60, appendix A. The following items are required for sample collection:

6.1.1 Probe Nozzle, Probe Liner, Pitot Tube, Differential Pressure Gauge, Filter Holder, Filter Heating System, Temperature Sensor, Metering System, Barometer, and Gas Density Determination Equipment. Same as Method 5, Sections 6.1.1.1 to 6.1.1.7, 6.1.1.9, 6.1.2, and 6.1.3, respectively.

6.1.2 Impingers. Four impingers connected in series with leak-free ground-glass fittings or any similar leak-free noncontaminating fittings. For the first, third, and fourth impingers, use the Greenburg-Smith design, modified by replacing the tip with a 1.3-cm ID (0.5-in.) glass tube extending to about 1.3 cm (0.5 in.) from the bottom of the flask. For the second impinger, use the Greenburg-Smith design with the standard tip. Modifications (e.g., flexible connections between the impingers, materials other than glass, or flexible vacuum lines to connect the filter holder to the condenser) are subject to the approval of the Administrator.

6.1.3 Temperature Sensor. Place a temperature sensor, capable of measuring temperature to within 1 °C (2 °F), at the outlet of the fourth impinger for monitoring purposes.

6.2 Sample Recovery. The following items are required for sample recovery:

6.2.1 Probe-Liner and Probe-Nozzle Brushes, Petri Dishes, Graduated Cylinder and/or Balance, Plastic Storage Containers, and Funnel and Rubber Policeman. Same as Method 5, Sections 6.2.1 and 6.2.4 to 6.2.8, respectively.

6.2.2 Wash Bottles. Polyethylene (2).

6.2.3 Sample Storage Containers. Chemically resistant, polyethylene or polypropylene for glassware washes, 500- or 1000-ml.

6.3 Analysis. The following items are required for analysis:

6.3.1 Spectrophotometer. Equipped with an electrodeless discharge lamp and a background corrector to measure absorbance at 193.7 nanometers (nm). For measuring samples having less than 10 $\mu\text{g As/ml}$, use a vapor generator accessory or a graphite furnace.

6.3.2 Recorder. To match the output of the spectrophotometer.

6.3.3 Beakers. 150 ml.

6.3.4 Volumetric Flasks. Glass 50-, 100-, 200-, 500-, and 1000-ml; and polypropylene, 50-ml.

6.3.5 Balance. To measure within 0.5 g.

6.3.6 Volumetric Pipets. 1-, 2-, 3-, 5-, 8-, and 10-ml.

6.3.7 Oven.

6.3.8 Hot Plate.

7.0 Reagents and Standards

Unless otherwise indicated, it is intended that all reagents conform to the specifications established by the Committee on Analytical Reagents of the American Chemical Society, where such specifications are available; otherwise, use the best available grade.

7.1 The following reagents are required for sample collection:

7.1.1 Filters. Same as Method 5, Section 7.1.1, except that the filters need not be unreactive to SO_2 .

7.1.2 Silica Gel, Crushed Ice, and Stopcock Grease. Same as Method 5, Sections 7.1.2, 7.1.4, and 7.1.5, respectively.

7.1.3 Water. Deionized distilled to meet ASTM D 1193-77 or 91 (incorporated by reference-see §61.18), Type 3. When high concentrations of organic matter are not expected to be present, the KMnO_4 test for oxidizable organic matter may be omitted.

7.2 Sample Recovery.

7.2.1 0.1 N NaOH. Dissolve 4.00 g of NaOH in about 500 ml of water in a 1-liter volumetric flask. Then, dilute to exactly 1.0 liter with water.

7.3 Analysis. The following reagents and standards are required for analysis:

7.3.1 Water. Same as Section 7.1.3.

7.3.2 Sodium Hydroxide, 0.1 N. Same as in Section 7.2.1.

7.3.3 Sodium Borohydride (NaBH_4), 5 Percent Weight by Volume (W/V). Dissolve 50.0 g of NaBH_4 in about 500 ml of 0.1 N NaOH in a 1-liter volumetric flask. Then, dilute to exactly 1.0 liter with 0.1 N NaOH.

7.3.4 Hydrochloric Acid, Concentrated.

7.3.5 Potassium Iodide (KI), 30 Percent (W/V). Dissolve 300 g of KI in 500 ml of water in a 1 liter volumetric flask. Then, dilute to exactly 1.0 liter with water.

7.3.6 Nitric Acid, Concentrated.

7.3.7 Nitric Acid, 0.8 N. Dilute 52 ml of concentrated HNO_3 to exactly 1.0 liter with water.

7.3.8 Nitric Acid, 50 Percent by Volume (V/V). Add 50 ml concentrated HNO_3 to 50 ml water.

7.3.9 Stock Arsenic Standard, 1 mg As/ml. Dissolve 1.3203 g of primary standard grade As_2O_3 in 20 ml of 0.1 N NaOH in a 150 ml beaker. Slowly add 30 ml of concentrated HNO_3 . Heat the resulting solution and evaporate just to dryness. Transfer the residue quantitatively to a 1-liter volumetric flask, and dilute to 1.0 liter with water.

7.3.10 Arsenic Working Solution, 1.0 μg As/ml. Pipet exactly 1.0 ml of stock arsenic standard into an acid-cleaned, appropriately labeled 1-liter volumetric flask containing about 500 ml of water and 5 ml of concentrated HNO_3 . Dilute to exactly 1.0 liter with water.

7.3.11 Air. Suitable quality for AAS analysis.

7.3.12 Acetylene. Suitable quality for AAS analysis.

7.3.13 Nickel Nitrate, 5 Percent Ni (W/V). Dissolve 24.780 g of nickel nitrate hexahydrate [$\text{Ni}(\text{NO}_3)_2 \cdot 6\text{H}_2\text{O}$] in water in a 100-ml volumetric flask, and dilute to 100 ml with water.

7.3.14 Nickel Nitrate, 1 Percent Ni (W/V). Pipet 20 ml of 5 percent nickel nitrate solution into a 100-ml volumetric flask, and dilute to exactly 100 ml with water.

7.3.15 Hydrogen Peroxide, 3 Percent by Volume. Pipet 50 ml of 30 percent H_2O_2 into a 500-ml volumetric flask, and dilute to exactly 500 ml with water.

8.0 Sample Collection, Preservation, Transport, and Storage

8.1 Pretest Preparation. Follow the general procedure given in Method 5, Section 8.1, except the filter need not be weighed, and the 200 ml of 0.1N NaOH and Container 4 should be tared to within 0.5 g.

8.2 Preliminary Determinations. Follow the general procedure given in Method 5, Section 8.2, except select the nozzle size to maintain isokinetic sampling rates below 28 liters/min (1.0 cfm).

8.3 Preparation of Sampling Train. Follow the general procedure given in Method 5, Section 8.3.

8.4 Leak-Check Procedures. Same as Method 5, Section 8.4.

8.5 Sampling Train Operation. Follow the general procedure given in Method 5, Section 8.5, except maintain isokinetic sampling flow rates below 28 liters/min (1.0 cfm). For each run, record the data required on a data sheet similar to the one shown in Figure 108-2.

8.6 Calculation of Percent Isokinetic. Same as Method 5, Section 8.6.

8.7 Sample Recovery. Same as Method 5, Section 8.7, except that 0.1 N NaOH is used as the cleanup solvent instead of acetone and that the impinger water is treated as follows:

8.7.1 Container Number 4 (Impinger Water). Clean each of the first three impingers and connecting glassware in the following manner:

8.7.1.1 Wipe the impinger ball joints free of silicone grease, and cap the joints.

8.7.1.2 Rotate and agitate each of the first two impingers, using the impinger contents as a rinse solution.

8.7.1.3 Transfer the liquid from the first three impingers to Container Number 4. Remove the outlet ball-joint cap, and drain the contents through this opening. Do not separate the impinger parts (inner and outer tubes) while transferring their contents to the container.

8.7.1.4 Weigh the contents of Container No. 4 to within 0.5 g. Record in the log the weight of liquid along with a notation of any color or film observed in the impinger catch. The weight of liquid is needed along with the silica gel data to calculate the stack gas moisture content.

NOTE: Measure and record the total amount of 0.1 N NaOH used for rinsing under Sections 8.7.1.5 and 8.7.1.6.

8.7.1.5 Pour approximately 30 ml of 0.1 NaOH into each of the first two impingers, and agitate the impingers. Drain the 0.1 N NaOH through the outlet arm of each impinger into Container Number 4. Repeat this operation a second time; inspect the impingers for any abnormal conditions.

8.7.1.6 Wipe the ball joints of the glassware connecting the impingers and the back half of the filter holder free of silicone grease, and rinse each piece of glassware twice with 0.1 N NaOH; transfer this rinse into Container Number 4. (DO NOT RINSE or brush the glass-fritted filter support.) Mark the height of the fluid level to determine whether leakage occurs during transport. Label the container to identify clearly its contents.

8.8 Blanks.

8.8.1 Sodium Hydroxide. Save a portion of the 0.1 N NaOH used for cleanup as a blank. Take 200 ml of this solution directly from the wash bottle being used and place it in a plastic sample container labeled "NaOH blank."

8.8.2 Water. Save a sample of the water, and place it in a container labeled "H₂O blank."

8.8.3 Filter. Save two filters from each lot of filters used in sampling. Place these filters in a container labeled "filter blank."

9.0 Quality Control

9.1 MISCELLANEOUS QUALITY CONTROL MEASURES.

Section	Quality control measure	Effect
8.4, 10.1	Sampling equipment leak-checks and calibration	Ensures accuracy and precision of sampling measurements.
10.4	Spectrophotometer calibration	Ensures linearity of spectrophotometer response to standards.
11.5	Check for matrix effects	Eliminates matrix effects.

9.2 Volume Metering System Checks. Same as Method 5, Section 9.2.

10.0 Calibration and Standardization

NOTE: Maintain a laboratory log of all calibrations.

10.1 Sampling Equipment. Same as Method 5, Section 10.0.

10.2 Preparation of Standard Solutions.

10.2.1 For the high level procedure, pipet 1, 3, 5, 8, and 10 ml of the 1.0 mg As/ml stock solution into separate 100 ml volumetric flasks, each containing 5 ml of concentrated HNO₃. Dilute to the mark with water.

10.2.2 For the low level vapor generator procedure, pipet 1, 2, 3, and 5 ml of 1.0 µg As/ml standard solution into separate reaction tubes. Dilute to the mark with water.

10.2.3 For the low level graphite furnace procedure, pipet 1, 5, 10 and 15 ml of 1.0 µg As/ml standard solution into separate flasks along with 2 ml of the 5 percent nickel nitrate solution and 10 ml of the 3 percent H₂O₂ solution. Dilute to the mark with water.

10.3 Calibration Curve. Analyze a 0.8 N HNO₃ blank and each standard solution according to the procedures outlined in section 11.4.1. Repeat this procedure on each standard solution until two consecutive peaks agree within 3 percent of their average value. Subtract the average peak height (or peak area) of the blank—which must be less than 2 percent of recorder full scale—from the averaged peak height of each standard solution. If the blank absorbance is greater than 2 percent of full-scale, the probable cause is As contamination of a reagent or carry-over of As from a previous sample. Prepare the calibration curve by plotting the corrected peak height of each standard solution versus the corresponding final total As weight in the solution.

10.4 Spectrophotometer Calibration Quality Control. Calculate the least squares slope of the calibration curve. The line must pass through the origin or through a point no further from the origin than ±2 percent of the recorder full scale. Multiply the corrected peak height by the reciprocal of the least squares slope to determine the distance each calibration point lies from the theoretical calibration line. The difference between the calculated concentration values and the actual concentrations (e.g., 1, 3, 5, 8, and 10 mg As for the high-level procedure) must be less than 7 percent for all standards.

NOTE: For instruments equipped with direct concentration readout devices, preparation of a standard curve will not be necessary. In all cases, follow calibration and operational procedures in the manufacturers' instruction manual.

11.0 Analytical Procedure

11.1 Sample Loss Check. Prior to analysis, check the liquid level in Containers Number 2 and Number 4. Note on the analytical data sheet whether leakage occurred during transport. If a noticeable amount of leakage occurred, either void the sample or take steps, subject to the approval of the Administrator, to adjust the final results.

11.2 Sample Preparation.

11.2.1 Container Number 1 (Filter). Place the filter and loose particulate matter in a 150 ml beaker. Also, add the filtered solid material from Container Number 2 (see Section 11.2.2). Add 50 ml of 0.1 N NaOH. Then stir and warm on a hot plate at low heat (do not boil) for about 15 minutes. Add 10 ml of concentrated HNO₃, bring to a boil, then simmer for about 15 minutes. Filter the solution through a glass fiber filter. Wash with hot water, and catch the filtrate in a clean 150 ml beaker. Boil the filtrate, and evaporate to dryness. Cool, add 5 ml of 50 percent HNO₃, and then warm and stir. Allow to cool. Transfer to a 50-ml volumetric flask, dilute to volume with water, and mix well.

11.2.2 Container Number 2 (Probe Wash).

11.2.2.1 Filter (using a glass fiber filter) the contents of Container Number 2 into a 200 ml volumetric flask. Combine the filtered (solid) material with the contents of Container Number 1 (Filter).

11.2.2.2 Dilute the filtrate to exactly 200 ml with water. Then pipet 50 ml into a 150 ml beaker. Add 10 ml of concentrated HNO₃, bring to a boil, and evaporate to dryness. Allow to cool, add 5 ml of 50 percent HNO₃, and then warm and stir. Allow the solution to cool, transfer to a 50-ml volumetric flask, dilute to volume with water, and mix well.

11.2.3 Container Number 4 (Impinger Solution). Transfer the contents of Container Number 4 to a 500 ml volumetric flask, and dilute to exactly 500-ml with water. Pipet 50 ml of the solution into a 150-ml beaker. Add 10 ml of concentrated HNO₃, bring to a boil, and evaporate to dryness. Allow to cool, add 5 ml of 50 percent HNO₃, and then warm and stir. Allow the solution to cool, transfer to a 50-ml volumetric flask, dilute to volume with water, and mix well.

11.2.4 Filter Blank. Cut each filter into strips, and treat each filter individually as directed in Section 11.2.1, beginning with the sentence, "Add 50 ml of 0.1 N NaOH."

11.2.5 Sodium Hydroxide and Water Blanks. Treat separately 50 ml of 0.1 N NaOH and 50 ml water, as directed under Section 11.2.3, beginning with the sentence, "Pipet 50 ml of the solution into a 150-ml beaker."

11.3 Spectrophotometer Preparation. Turn on the power; set the wavelength, slit width, and lamp current. Adjust the background corrector as instructed by the manufacturer's manual for the particular atomic absorption spectrophotometer. Adjust the burner and flame characteristics as necessary.

11.4 Analysis. Calibrate the analytical equipment and develop a calibration curve as outlined in Sections 10.2 through 10.4.

11.4.1 Arsenic Samples. Analyze an appropriately sized aliquot of each diluted sample (from Sections 11.2.1 through 11.2.3) until two consecutive peak heights agree within 3 percent of their average value. If applicable, follow the procedures outlined in Section 11.4.1.1. If the sample concentration falls outside the range of the calibration curve, make an appropriate dilution with 0.8 N HNO₃ so that the final concentration falls within the range of the curve. Using the calibration curve, determine the arsenic concentration in each sample fraction.

NOTE: Because instruments vary between manufacturers, no detailed operating instructions will be given here. Instead, the instrument manufacturer's detailed operating instructions should be followed.

11.4.1.1 Arsenic Determination at Low Concentration. The lower limit of flame AAS is 10 µg As/ml. If the arsenic concentration of any sample is at a lower level, use the graphite furnace or vapor generator which is available as an accessory component. Flame, graphite furnace, or vapor generators may be used for samples whose concentrations are between 10 and 30 µg/ml. Follow the manufacturer's instructions in the use of such equipment.

11.4.1.1.1 Vapor Generator Procedure. Place a sample containing between 0 and 5 µg of arsenic in the reaction tube, and dilute to 15 ml with water. Since there is some trial and error involved in this procedure, it may be necessary to screen the samples by conventional atomic absorption until an approximate concentration is determined. After determining the approximate concentration, adjust the volume of the sample accordingly. Pipet 15 ml of concentrated HCl into each tube. Add 1 ml of 30 percent KI solution. Place the reaction tube into a 50 °C (120 °F) water bath for 5 minutes. Cool to room temperature. Connect the reaction tube to the vapor generator assembly. When the instrument response has returned to baseline, inject 5.0 ml of 5 percent NaBH₄, and integrate the resulting spectrophotometer signal over a 30-second time period.

11.4.1.1.2 Graphite Furnace Procedure. Dilute the digested sample so that a 5 ml aliquot contains less than 1.5 µg of arsenic. Pipet 5 ml of this digested solution into a 10-ml volumetric flask. Add 1 ml of the 1 percent nickel nitrate solution, 0.5 ml of 50 percent HNO₃, and 1 ml of the 3 percent hydrogen peroxide and dilute to 10 ml with water. The sample is now ready for analysis.

11.4.1.2 Run a blank (0.8 N HNO₃) and standard at least after every five samples to check the spectrophotometer calibration. The peak height of the blank must pass through a point no further from the origin than ±2 percent of the recorder full scale. The difference between the measured concentration of the standard (the product of the corrected average peak height and the reciprocal of the least squares slope) and the actual concentration of the standard must be less than 7 percent, or recalibration of the analyzer is required.

11.4.1.3 Determine the arsenic concentration in the filter blank (i.e., the average of the two blank values from each lot).

11.4.2 Container Number 3 (Silica Gel). This step may be conducted in the field. Weigh the spent silica gel (or silica gel plus impinger) to the nearest 0.5 g; record this weight.

11.5 Check for matrix effects on the arsenic results. Same as Method 12, Section 11.5.

12.0 Data Analysis and Calculations

12.1 NOMENCLATURE

B_{ws} = Water in the gas stream, proportion by volume.

C_a = Concentration of arsenic as read from the standard curve, µg/ml.

C_s = Arsenic concentration in stack gas, dry basis, converted to standard conditions, g/dsm³ (gr/dscf).

E_a = Arsenic mass emission rate, g/hr (lb/hr).

F_d = Dilution factor (equals 1 if the sample has not been diluted).

I = Percent of isokinetic sampling.

m_{bi} = Total mass of all four impingers and contents before sampling, g.

m_f = Total mass of all four impingers and contents after sampling, g.

m_n = Total mass of arsenic collected in a specific part of the sampling train, μg .

m_t = Total mass of arsenic collected in the sampling train, μg .

T_m = Absolute average dry gas meter temperature (see Figure 108-2), $^{\circ}\text{K}$ ($^{\circ}\text{R}$).

V_m = Volume of gas sample as measured by the dry gas meter, dry basis, m^3 (ft^3).

$V_{m(\text{std})}$ = Volume of gas sample as measured by the dry gas meter, corrected to standard conditions, m^3 (ft^3).

V_n = Volume of solution in which the arsenic is contained, ml.

$V_{w(\text{std})}$ = Volume of water vapor collected in the sampling train, corrected to standard conditions, m^3 (ft^3).

ΔH = Average pressure differential across the orifice meter (see Figure 108-2), mm H_2O (in. H_2O).

12.2 Average Dry Gas Meter Temperatures (T_m) and Average Orifice Pressure Drop (ΔH). See data sheet (Figure 108-2).

12.3 Dry Gas Volume. Using data from this test, calculate $V_{m(\text{std})}$ according to the procedures outlined in Method 5, Section 12.3.

12.4 Volume of Water Vapor.

$$V_{w(\text{std})} = K_2(m_f - m_{bi}) \quad \text{Eq. 108-1}$$

[View or download PDF](#)

Where:

$K_2 = 0.001334 \text{ m}^3/\text{g}$ for metric units.

$= 0.047012 \text{ ft}^3/\text{g}$ for English units.

12.5 Moisture Content.

$$B_{ws} = \frac{V_{w(\text{std})}}{V_{m(\text{std})} + V_{w(\text{std})}} \quad \text{Eq. 108-2}$$

[View or download PDF](#)

12.6 Amount of Arsenic Collected.

12.6.1 Calculate the amount of arsenic collected in each part of the sampling train, as follows:

$$m_n = C_a F_d V_n \quad \text{Eq. 108-3}$$

[View or download PDF](#)

12.6.2 Calculate the total amount of arsenic collected in the sampling train as follows:

$$m_t = m_{(\text{filters})} + m_{(\text{probe})} + m_{(\text{impingers})} - m_{(\text{filter blank})} - m_{(\text{NaOH blank})} - m_{(\text{water blank})} \quad \text{Eq. 108-4}$$

[View or download PDF](#)

12.7 Calculate the arsenic concentration in the stack gas (dry basis, adjusted to standard conditions) as follows:

$$C_s = K_3(m_t/V_{m(\text{std})}) \quad \text{Eq. 108-5}$$

[View or download PDF](#)

Where:

$K_3 = 10^{-6}$ g/ μg for metric units

= 1.54×10^{-5} gr/ μg for English units

12.8 Stack Gas Velocity and Volumetric Flow Rate. Calculate the average stack gas velocity and volumetric flow rate using data obtained in this method and the equations in Sections 12.2 and 12.3 of Method 2.

12.9 Pollutant Mass Rate. Calculate the arsenic mass emission rate as follows:

$$E_s = C_s Q_{sd} \quad \text{Eq. 108-6}$$

[View or download PDF](#)

12.10 Isokinetic Variation. Same as Method 5, Section 12.11.

13.0 Method Performance

13.1 Sensitivity. The lower limit of flame AAS 10 μg As/ml. The analytical procedure includes provisions for the use of a graphite furnace or vapor generator for samples with a lower arsenic concentration.

14.0 Pollution Prevention. [Reserved]

15.0 Waste Management. [Reserved]

16.0 Alternative Procedures

16.1 Inductively coupled plasma-atomic emission spectrometry (ICP-AES) Analysis. ICP-AES may be used as an alternative to atomic absorption analysis provided the following conditions are met:

16.1.1 Sample collection, sample preparation, and analytical preparation procedures are as defined in the method except as necessary for the ICP-AES application.

16.1.2 Quality Assurance/Quality Control procedures, including audit material analysis, are conducted as prescribed in the method. The QA acceptance conditions must be met.

16.1.3 The limit of quantitation for the ICP-AES must be demonstrated and the sample concentrations reported should be no less than two times the limit of quantitation. The limit of quantitation is defined as ten times the standard deviation of the blank value. The standard deviation of the blank value is determined from the analysis of seven blanks. It has been reported that for mercury and those elements that form hydrides, a continuous-flow generator coupled to an ICP-AES offers detection limits comparable to cold vapor atomic absorption.

16.2 Inductively Coupled Plasma-Mass Spectrometry (ICP-MS) Analysis. ICP-MS may be used as an alternative to atomic absorption analysis.

16.3 Cold Vapor Atomic Fluorescence Spectrometry (CVAFS) Analysis. CVAFS may be used as an alternative to atomic absorption analysis.

17.0 References.

Same as References 1 through 9 of Method 5, Section 17.0, with the addition of the following:

1. Perkin Elmer Corporation. Analytical Methods for Atomic Absorption Spectrophotometry. 303-0152. Norwalk, Connecticut. September 1976. pp. 5-6.

2. Standard Specification for Reagent Water. In: Annual Book of American Society for Testing and Materials Standards. Part 31: Water, Atmospheric Analysis. American Society for Testing and Materials. Philadelphia, PA. 1974. pp. 40-42.

3. Stack Sampling Safety Manual (Draft). U.S. Environmental Protection Agency, Office of Air Quality Planning and Standard, Research Triangle Park, NC. September 1978.

18.0 Tables, Diagrams, Flowcharts, and Validation Data

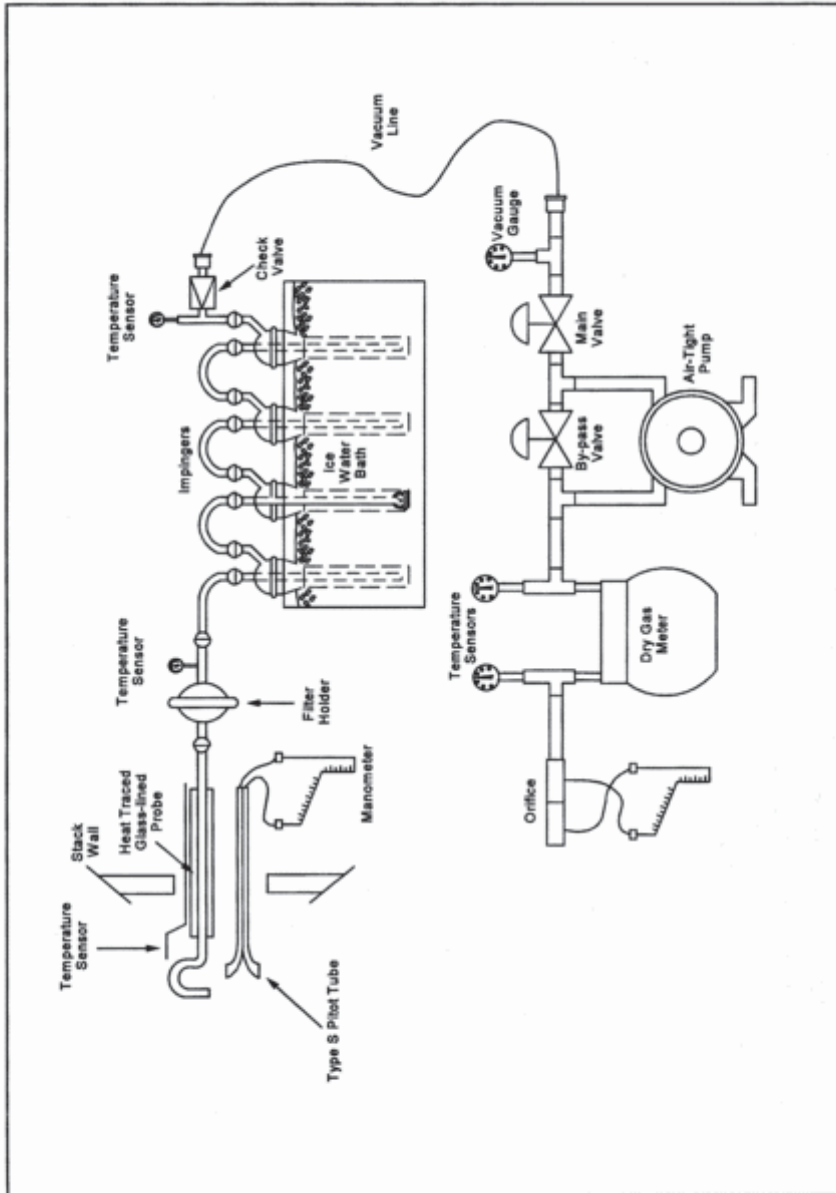

Figure 108-1. Arsenic Sampling Train

[View or download PDF](#)

Analyte	CAS No.	Sensitivity
Arsenic compounds as arsenic (As)	7440-38-2	Lower limit 10 µg/ml or less.

1.2 Applicability. This method applies to the determination of inorganic As content of process ore and reverberatory matte samples from nonferrous smelters and other sources as specified in an applicable subpart of the regulations.

1.3 Data Quality Objectives. Adherence to the requirements of this method will enhance the quality of the data obtained from air pollutant sampling methods.

2.0 Summary of Method

Arsenic bound in ore samples is liberated by acid digestion and analyzed by flame atomic absorption spectrophotometry (AAS).

3.0 Definitions [Reserved]

4.0 Interferences

Analysis for As by flame AAS is sensitive to the chemical composition and to the physical properties (e.g., viscosity, pH) of the sample. The analytical procedure includes a check for matrix effects (section 11.5).

5.0 Safety

5.1 Disclaimer. This method may involve hazardous materials, operations, and equipment. This test method may not address all of the safety problems associated with its use. It is the responsibility of the user to establish appropriate safety and health practices and determine the applicability of regulatory limitations prior to performing this test method.

5.2 Corrosive Reagents. The following reagents are hazardous. Personal protective equipment and safe procedures that prevent chemical splashes are recommended. If contact occurs, immediately flush with copious amounts of water for at least 15 minutes. Remove clothing under shower and decontaminate. Treat residual chemical burns as thermal burns.

5.2.1 Hydrochloric Acid (HCl). Highly corrosive liquid with toxic vapors. Vapors are highly irritating to eyes, skin, nose, and lungs, causing severe damage. May cause bronchitis, pneumonia, or edema of lungs. Exposure to concentrations of 0.13 to 0.2 percent can be lethal to humans in a few minutes. Provide ventilation to limit exposure. Reacts with metals, producing hydrogen gas.

5.2.2 Hydrofluoric Acid (HF). Highly corrosive to eyes, skin, nose, throat, and lungs. Reaction to exposure may be delayed by 24 hours or more. Provide ventilation to limit exposure.

5.2.3 Hydrogen Peroxide (H₂O₂). Very harmful to eyes. 30% H₂O₂ can burn skin, nose, and lungs.

5.2.4 Nitric Acid (HNO₃). Highly corrosive to eyes, skin, nose, and lungs. Vapors are highly toxic and can cause bronchitis, pneumonia, or edema of lungs. Reaction to inhalation may be delayed as long as 30 hours and still be fatal. Provide ventilation to limit exposure. Strong oxidizer. Hazardous reaction may occur with organic materials such as solvents.

5.2.5 Sodium Hydroxide (NaOH). Causes severe damage to eyes and skin. Inhalation causes irritation to nose, throat, and lungs. Reacts exothermically with limited amounts of water.

6.0 *Equipment and Supplies*

6.1 Sample Collection and Preparation. The following items are required for sample collection and preparation:

- 6.1.1 Parr Acid Digestion Bomb. Stainless steel with vapor-tight Teflon cup and cover.
- 6.1.2 Volumetric Pipets. 2- and 5-ml sizes.
- 6.1.3 Volumetric Flask. 50-ml polypropylene with screw caps, (one needed per standard).
- 6.1.4 Funnel. Polyethylene or polypropylene.
- 6.1.5 Oven. Capable of maintaining a temperature of approximately 105 °C (221 °F).
- 6.1.6 Analytical Balance. To measure to within 0.1 mg.

6.2 Analysis. The following items are required for analysis:

6.2.1 Spectrophotometer and Recorder. Equipped with an electrodeless discharge lamp and a background corrector to measure absorbance at 193.7 nm. For measuring samples having less than 10 µg As/ml, use a graphite furnace or vapor generator accessory. The recorder shall match the output of the spectrophotometer.

6.2.2 Volumetric Flasks. Class A, 50-ml (one needed per sample and blank), 500-ml, and 1-liter.

6.2.3 Volumetric Pipets. Class A, 1-, 5-, 10-, and 25-ml sizes.

7.0 *Reagents and Standards.*

Unless otherwise indicated, it is intended that all reagents conform to the specifications established by the Committee on Analytical Reagents of the American Chemical Society, where such specifications are available; otherwise, use the best available grade.

7.1 Sample Collection and Preparation. The following reagents are required for sample collection and preparation:

7.1.1 Water. Deionized distilled to meet ASTM D 1193-77 or 91 Type 3 (incorporated by reference—See §61.18). When high concentrations of organic matter are not expected to be present, the KMnO_4 test for oxidizable organic matter may be omitted. Use in all dilutions requiring water.

7.1.2 Nitric Acid Concentrated.

7.1.3 Nitric Acid, 0.5 N. In a 1-liter volumetric flask containing water, add 32 ml of concentrated HNO_3 and dilute to volume with water.

7.1.4 Hydrofluoric Acid, Concentrated.

7.1.5 Potassium Chloride (KCl) Solution, 10 percent weight by volume (W/V). Dissolve 10 g KCl in water, add 3 ml concentrated HNO₃, and dilute to 100 ml.

7.1.6 Filter. Teflon filters, 3-micron porosity, 47-mm size. (Available from Millipore Co., type FS, Catalog Number FSLW04700.)

7.1.7 Sodium Borohydride (NaBH₄), 5 Percent (W/V). Dissolve 50.0 g of NaBH₄ in about 500 ml of 0.1 N NaOH in a 1-liter volumetric flask. Then, dilute to exactly 1.0 liter with 0.1 N NaOH.

7.1.8 Nickel Nitrate, 5 Percent Ni (W/V). Dissolve 24.780 g of nickel nitrate hexahydrate [Ni(NO₃)₂·6H₂O] in water in a 100-ml volumetric flask, and dilute to 100 ml with water.

7.1.9 Nickel Nitrate, 1 Percent Ni (W/V). Pipet 20 ml of 5 percent nickel nitrate solution into a 100-ml volumetric flask, and dilute to 100 ml with water.

7.2 Analysis. The following reagents and standards are required for analysis:

7.2.2 Sodium Hydroxide, 0.1 N. Dissolve 2.00 g of NaOH in water in a 500-ml volumetric flask. Dilute to volume with water.

7.2.3 Nitric Acid, 0.5 N. Same as in Section 7.1.3.

7.2.4 Potassium Chloride Solution, 10 percent. Same as in Section 7.1.5.

7.2.5 Hydrochloric Acid, Concentrated.

7.2.6 Potassium Iodide (KI), 30 Percent (W/V). Dissolve 300 g of KI in about 500 ml of water in a 1-liter volumetric flask. Then, dilute to exactly 1.0 liter with water.

7.2.7 Hydrogen Peroxide, 3 Percent by Volume. Pipet 50 ml of 30 percent H₂O₂ into a 500-ml volumetric flask, and dilute to exactly 500 ml with water.

7.2.8 Stock Arsenic Standard, 1 mg As/ml. Dissolve 1.3203 g of primary grade As₂O₃ in 20 ml of 0.1 N NaOH. Slowly add 30 ml of concentrated HNO₃, and heat in an oven at 105 °C (221 °F) for 2 hours. Allow to cool, and dilute to 1 liter with deionized distilled water.

7.2.9 Nitrous Oxide. Suitable quality for AAS analysis.

7.2.10 Acetylene. Suitable quality for AAS analysis.

7.2.11 Quality Assurance Audit Samples. When making compliance determinations, and upon availability, audit samples may be obtained from the appropriate EPA regional Office or from the responsible enforcement authority.

NOTE: The responsible enforcement authority should be notified at least 30 days prior to the test date to allow sufficient time for sample delivery.

8.0 Sample Collection, Preservation, Transport, and Storage

8.1 Sample Collection. A sample that is representative of the ore lot to be tested must be taken prior to analysis. (A portion of the samples routinely collected for metals analysis may be used provided the sample is representative of the ore being tested.)

8.2 Sample Preparation. The sample must be ground into a finely pulverized state.

9.0 QUALITY CONTROL

Section	Quality control measure	Effect
10.2	Spectrophotometer calibration	Ensure linearity of spectrophotometer response to standards.
11.5	Check for matrix effects	Eliminate matrix effects.

10.0 Calibration and Standardizations

NOTE: Maintain a laboratory log of all calibrations.

10.1 Preparation of Standard Solutions. Pipet 1, 5, 10, and 25 ml of the stock As solution into separate 100-ml volumetric flasks. Add 10 ml KCl solution and dilute to the mark with 0.5 N HNO₃. This will give standard concentrations of 10, 50, 100, and 250 µg As/ml. For low-level arsenic samples that require the use of a graphite furnace or vapor generator, follow the procedures in Section 11.3:1. Dilute 10 ml of KCl solution to 100 ml with 0.5 N HNO₃ and use as a reagent blank.

10.2 Calibration Curve. Analyze the reagent blank and each standard solution according to the procedures outlined in Section 11.3. Repeat this procedure on each standard solution until two consecutive peaks agree within 3 percent of their average value. Subtract the average peak height (or peak area) of the blank—which must be less than 2 percent of recorder full scale—from the averaged peak heights of each standard solution. If the blank absorbance is greater than 2 percent of full-scale, the probable cause is Hg contamination of a reagent or carry-over of As from a previous sample. Prepare the calibration curve by plotting the corrected peak height of each standard solution versus the corresponding final total As weight in the solution.

10.3 Spectrophotometer Calibration Quality Control. Calculate the least squares slope of the calibration curve. The line must pass through the origin or through a point no further from the origin than ±2 percent of the recorder full scale. Multiply the corrected peak height by the reciprocal of the least squares slope to determine the distance each calibration point lies from the theoretical calibration line. The difference between the calculated concentration values and the actual concentrations must be less than 7 percent for all standards.

NOTE: For instruments equipped with direct concentration readout devices, preparation of a standard curve will not be necessary. In all cases, follow calibration and operational procedures in the manufacturer's instruction manual.

11.0 Analytical Procedure

11.1 Sample Preparation. Weigh 50 to 500 mg of finely pulverized sample to the nearest 0.1 mg. Transfer the sample into the Teflon cup of the digestion bomb, and add 2 ml each of concentrated HNO₃ and HF. Seal the bomb immediately to prevent the loss of any volatile arsenic compounds that may form. Heat in an oven at 105 °C (221 °F) for 2 hours. Remove the bomb from the oven and allow to cool. Using a Teflon filter, quantitatively filter the digested sample into a 50-ml polypropylene volumetric flask. Rinse the bomb three times with small portions of 0.5 N HNO₃, and filter the rinses into the flask. Add 5 ml of KCl solution to the flask, and dilute to 50 ml with 0.5 N HNO₃.

11.2 Spectrophotometer Preparation.

11.2.1 Turn on the power; set the wavelength, slit width, and lamp current. Adjust the background corrector as instructed by the manufacturer's manual for the particular atomic absorption spectrophotometer. Adjust the burner and flame characteristics as necessary.

11.2.2 Develop a spectrophotometer calibration curve as outlined in Sections 10.2 and 10.3.

11.3 Arsenic Determination. Analyze an appropriately sized aliquot of each diluted sample (from Section 11.1) until two consecutive peak heights agree within 3 percent of their average value. If applicable, follow the procedures outlined in Section 11.3.1. If the sample concentration falls outside the range of the calibration curve, make an appropriate dilution with 0.5 N HNO₃ so that the final concentration falls within the range of the curve. Using the calibration curve, determine the As concentration in each sample.

NOTE: Because instruments vary between manufacturers, no detailed operating instructions will be given here. Instead, the instrument manufacturer's detailed operating instructions should be followed.

11.3.1 Arsenic Determination at Low Concentration. The lower limit of flame AAS is 10 µg As/ml. If the arsenic concentration of any sample is at a lower level, use the vapor generator or graphite furnace which is available as an accessory component. Flame, graphite furnace, or vapor generators may be used for samples whose concentrations are between 10 and 30 µg/ml. Follow the manufacturer's instructions in the use of such equipment.

11.3.1.1 Vapor Generator Procedure. Place a sample containing between 0 and 5 µg of arsenic in the reaction tube, and dilute to 15 ml with water. Since there is some trial and error involved in this procedure, it may be necessary to screen the samples by conventional AAS until an approximate concentration is determined. After determining the approximate concentration, adjust the volume of the sample accordingly. Pipet 15 ml of concentrated HCl into each tube. Add 1 ml of 30 percent KI solution. Place the reaction tube into a 50 °C (120 °F) water bath for 5 minutes. Cool to room temperature. Connect the reaction tube to the vapor generator assembly. When the instrument response has returned to baseline, inject 5.0 ml of 5 percent NaBH₄ and integrate the resulting spectrophotometer signal over a 30-second time period.

11.3.1.2 Graphite Furnace Procedure. Pipet 5 ml of the digested solution into a 10-ml volumetric flask. Add 1 ml of the 1 percent nickel nitrate solution, 0.5 ml of 50 percent HNO₃, and 1 ml of the 3 percent H₂O₂, and dilute to 10 ml with water. The sample is now ready to inject in the furnace for analysis.

11.4 Run a blank and standard at least after every five samples to check the spectrophotometer calibration. The peak height of the blank must pass through a point no further from the origin than ±2 percent of the recorder full scale. The difference between the measured concentration of the standard (the product of the corrected average peak height and the reciprocal of the least squares slope) and the actual concentration of the standard must be less than 7 percent, or recalibration of the analyzer is required.

11.5 Mandatory Check for Matrix Effects on the Arsenic Results. Same as Method 12, Section 11.5.

12.0 Data Analysis and Calculations

12.1 Calculate the percent arsenic in the ore sample as follows:

$$\% \text{ As} = \frac{5C_s F_d}{W} \quad \text{Eq. 108A-1}$$

[View or download PDF](#)

Where:

C_a = Concentration of As as read from the standard curve, $\mu\text{g/ml}$.

F_d = Dilution factor (equals to 1 if the sample has not been diluted).

W = Weight of ore sample analyzed, mg.

5 = (50 ml sample " 100)/(10³ $\mu\text{g/mg}$).

13.0 Method Performance

13.1 Sensitivity. The lower limit of flame AAS is 10 $\mu\text{g As/ml}$. The analytical procedure includes provisions for the use of a graphite furnace or vapor generator for samples with a lower arsenic concentration.

14.0 Pollution Prevention. [Reserved]

15.0 Waste Management. [Reserved]

16.0 Alternative Procedures

16.1 Alternative Analyzer. Inductively coupled plasma-atomic emission spectrometry (ICP-AES) may be used as an alternative to atomic absorption analysis provided the following conditions are met:

16.1.1 Sample collection, sample preparation, and analytical preparation procedures are as defined in the method except as necessary for the ICP-AES application.

16.1.2 Quality Assurance/Quality Control procedures, including audit material analysis, are conducted as prescribed in the method. The QA acceptance conditions must be met.

16.1.3 The limit of quantitation for the ICP-AES must be demonstrated and the sample concentrations reported should be no less than two times the limit of quantitation. The limit of quantitation is defined as ten times the standard deviation of the blank value. The standard deviation of the blank value is determined from the analysis of seven blanks. It has been reported that for mercury and those elements that form hydrides, a continuous-flow generator coupled to an ICP-AES offers detection limits comparable to cold vapor atomic absorption.

17.0 References

Same as References 1 through 9 of Section 17.0 of Method 5, with the addition of the following:

1. Perkin Elmer Corporation. Analytical Methods of Atomic Absorption Spectrophotometry. 303-0152. Norwalk, Connecticut. September 1976. pp 5-6.

2. Ringwald, D. Arsenic Determination on Process Materials from ASARCO's Copper Smelter in Tacoma, Washington. Unpublished Report. Prepared for Emission Measurement Branch, Emission Standards and Engineering Division, U.S. Environmental Protection Agency, Research Triangle Park, North Carolina. August 1980. 35 pp.

3. Stack Sampling Safety Manual (Draft). U.S. Environmental Protection Agency, Office of Air Quality Planning and Standard, Research Triangle Park, NC. September 1978.

18.0 Tables, Diagrams, Flowcharts, and Validation Data. [Reserved]

METHOD 108B—DETERMINATION OF ARSENIC CONTENT IN ORE SAMPLES FROM NONFERROUS SMELTERS

NOTE: This method does not include all of the specifications (e.g., equipment and supplies) and procedures (e.g., sampling and analytical) essential to its performance. Some material is incorporated by reference from other methods in this appendix and in appendix A to 40 CFR part 60. Therefore, to obtain reliable results, persons using this method should have a thorough knowledge of at least the following additional test methods: Method 12 and Method 108A.

1.0 Scope and Application

1.1 Analytes.

Analyte	CAS No.	Sensitivity
Arsenic compounds as arsenic (As)	7440-38-2	Lower limit 10 µg/ml.

1.2 Applicability. This method applies to the determination of inorganic As content of process ore and reverberatory matte samples from nonferrous smelters and other sources as specified in an applicable subpart of the regulations. Samples resulting in an analytical concentration greater than 10 µg As/ml may be analyzed by this method. For lower level arsenic samples, Method 108C should be used.

1.3 Data Quality Objectives. Adherence to the requirements of this method will enhance the quality of the data obtained from air pollutant sampling methods.

2.0 Summary of Method

Arsenic bound in ore samples is liberated by acid digestion and analyzed by flame atomic absorption spectrophotometry (AAS).

3.0 Definitions [Reserved]

4.0 Interferences

Analysis for As by flame AAS is sensitive to the chemical composition and to the physical properties (e.g., viscosity, pH) of the sample. The analytical procedure includes a check for matrix effects (Section 11.4).

5.0 Safety

5.1 Disclaimer. This method may involve hazardous materials, operations, and equipment. This test method may not address all of the safety problems associated with its use. It is the responsibility of the user to establish appropriate safety and health practices and determine the applicability of regulatory limitations prior to performing this test method.

5.2 Corrosive Reagents. The following reagents are hazardous. Personal protective equipment and safe procedures that prevent chemical splashes are recommended. If contact occurs, immediately flush with copious amounts of water for at least 15 minutes. Remove clothing under shower and decontaminate. Treat residual chemical burns as thermal burns.

5.2.1 Hydrochloric acid (HCl). Highly corrosive liquid with toxic vapors. Vapors are highly irritating to eyes, skin, nose, and lungs, causing severe damage. May cause bronchitis, pneumonia, or edema of lungs. Exposure to concentrations of 0.13 to 0.2 percent can be lethal to humans in a few minutes. Provide ventilation to limit exposure. Reacts with metals, producing hydrogen gas.

5.2.2 Hydrofluoric Acid (HF). Highly corrosive to eyes, skin, nose, throat, and lungs. Reaction to exposure may be delayed by 24 hours or more. Provide ventilation to limit exposure.

5.2.3 Nitric Acid (HNO₃). Highly corrosive to eyes, skin, nose, and lungs. Vapors are highly toxic and can cause bronchitis, pneumonia, or edema of lungs. Reaction to inhalation may be delayed as long as 30 hours and still be fatal. Provide ventilation to limit exposure. Strong oxidizer. Hazardous reaction may occur with organic materials such as solvents.

5.2.4 Perchloric Acid (HClO₄). Corrosive to eyes, skin, nose, and throat. Provide ventilation to limit exposure. Very strong oxidizer. Keep separate from water and oxidizable materials to prevent vigorous evolution of heat, spontaneous combustion, or explosion. Heat solutions containing HClO₄ only in hoods specifically designed for HClO₄.

6.0 *Equipment and Supplies*

6.1 Sample Preparation. The following items are required for sample preparation:

6.1.1 Teflon Beakers. 150-ml.

6.1.2 Graduated Pipets. 5-ml disposable.

6.1.3 Graduated Cylinder. 50-ml.

6.1.4 Volumetric Flask. 100-ml.

6.1.5 Analytical Balance. To measure within 0.1 mg.

6.1.6 Hot Plate.

6.1.7 Perchloric Acid Fume Hood.

6.2 Analysis. The following items are required for analysis:

6.2.1 Spectrophotometer. Equipped with an electrodeless discharge lamp and a background corrector to measure absorbance at 193.7 nm.

6.2.2 Beaker and Watch Glass. 400-ml.

6.2.3 Volumetric Flask. 1-liter.

6.2.4 Volumetric Pipets. 1-, 5-, 10-, and 25-ml.

7.0 *Reagents and Standards*

Unless otherwise indicated, it is intended that all reagents conform to the specifications established by the Committee on Analytical Reagents of the American Chemical Society, where such specifications are available; otherwise, use the best available grade.

7.1 Sample Preparation. The following reagents are required for sample preparation:

7.1.1 Water. Deionized distilled to meet ASTM D 1193-77 or 91 Type 3 (incorporated by reference—see §61.18).

7.1.2 Nitric Acid, Concentrated.

7.1.3 Hydrofluoric Acid, Concentrated.

7.1.4 Perchloric Acid, 70 Percent.

7.1.5 Hydrochloric Acid, Concentrated.

7.2 Analysis. The following reagents and standards are required for analysis:

7.2.1 Water. Same as in Section 7.1.1.

7.2.2 Stock Arsenic Standard, 1.0 mg As/ml. Dissolve 1.3203 g of primary grade As_2O_3 [dried at 105 °C (221 °F)] in a 400-ml beaker with 10 ml of HNO_3 and 5 ml of HCl. Cover with a watch glass, and heat gently until dissolution is complete. Add 10 ml of HNO_3 and 25 ml of $HClO_4$, evaporate to strong fumes of $HClO_4$, and reduce to about 20 ml volume. Cool, add 100 ml of water and 100 ml of HCl, and transfer quantitatively to a 1-liter volumetric flask. Dilute to volume with water and mix.

7.2.3 Acetylene. Suitable quality for AAS analysis.

7.2.4 Air. Suitable quality for AAS analysis.

8.0 Sample Collection, Preservation, Transport, and Storage

Same as in Method 108A, Sections 8.1 and 8.2.

9.0 QUALITY CONTROL

Section	Quality control measure	Effect
10.2	Spectrophotometer calibration	Ensure linearity of spectrophotometer response to standards.
11.4	Check for matrix effects	Eliminate matrix effects.

10.0 Calibration and Standardization

NOTE: Maintain a laboratory log of all calibrations.

10.1 Preparation of Standard Solutions. Pipet 1, 5, 10, and 25 ml of the stock As solution into separate 100-ml volumetric flasks. Add 2 ml of $HClO_4$, 10 ml of HCl, and dilute to the mark with water. This will provide standard concentrations of 10, 50, 100, and 250 μg As/ml.

10.2 Calibration Curve and Spectrophotometer Calibration Quality Control. Same as Method 108A, Sections 10.2 and 10.3

11.0 Analytical Procedure

11.1 Sample Preparation. Weigh 100 to 1000 mg of finely pulverized sample to the nearest 0.1 mg. Transfer the sample to a 150-ml Teflon beaker. Dissolve the sample by adding 15 ml of HNO_3 , 10 ml of HCl, 10 ml of HF, and 10 ml of $HClO_4$ in the exact order as described, and let stand for 10 minutes. In a $HClO_4$ fume hood, heat on a hot plate until 2-3 ml of $HClO_4$ remain, then cool. Add 20 ml of water and 10

ml of HCl. Cover and warm until the soluble salts are in solution. Cool, and transfer quantitatively to a 100-ml volumetric flask. Dilute to the mark with water.

11.2 Spectrophotometer Preparation. Same as in Method 108A, Section 11.2.

11.3 Arsenic Determination. If the sample concentration falls outside the range of the calibration curve, make an appropriate dilution with 2 percent HClO_4 /10 percent HCl (prepared by diluting 2 ml concentrated HClO_4 and 10 ml concentrated HCl to 100 ml with water) so that the final concentration falls within the range of the curve. Using the calibration curve, determine the As concentration in each sample.

NOTE: Because instruments vary between manufacturers, no detailed operating instructions will be given here. Instead, the instrument manufacturer's detailed operating instructions should be followed.

Run a blank and standard at least after every five samples to check the spectrophotometer calibration. The peak height of the blank must pass through a point no further from the origin than ± 2 percent of the recorder full scale. The difference between the measured concentration of the standard (the product of the corrected average peak height and the reciprocal of the least squares slope) and the actual concentration of the standard must be less than 7 percent, or recalibration of the analyzer is required.

11.4 Mandatory Check for Matrix Effects on the Arsenic Results. Same as Method 12, Section 11.5.

12.0 Data Analysis and Calculations

Same as in Method 108A, Section 12.0.

13.0 Method Performance

13.1 Sensitivity. The lower limit of flame AAS is 10 $\mu\text{g As/ml}$.

14.0 Pollution Prevention [Reserved]

15.0 Waste Management [Reserved]

16.0 References

Same as in Method 108A, Section 16.0.

17.0 Tables, Diagrams, Flowcharts, and Validation Data [Reserved]

METHOD 108C—DETERMINATION OF ARSENIC CONTENT IN ORE SAMPLES FROM NONFERROUS SMELTERS (MOLYBDENUM BLUE PHOTOMETRIC PROCEDURE)

NOTE: This method does not include all of the specifications (e.g., equipment and supplies) and procedures (e.g., sampling and analytical) essential to its performance. Some material is incorporated by reference from other methods in this part. Therefore, to obtain reliable results, persons using this method should have a thorough knowledge of at least Method 108A.

1.0 Scope and Application

1.1 Analytes.

Analyte	CAS No.	Sensitivity
Arsenic compounds as arsenic (As)	7440-38-2	Lower limit 0.0002 percent As by weight.

1.2 Applicability. This method applies to the determination of inorganic As content of process ore and reverberatory matte samples from nonferrous smelters and other sources as specified in an applicable subpart of the regulations.

1.3 Data Quality Objectives. Adherence to the requirements of this method will enhance the quality of the data obtained from air pollutant sampling methods.

2.0 Summary of Method

Arsenic bound in ore samples is liberated by acid digestion and analyzed by the molybdenum blue photometric procedure.

3.0 Definitions. [Reserved]

4.0 Interferences. [Reserved]

5.0 Safety

5.1 Disclaimer. This method may involve hazardous materials, operations, and equipment. This test method may not address all of the safety problems associated with its use. It is the responsibility of the user to establish appropriate safety and health practices and determine the applicability of regulatory limitations prior to performing this test method.

5.2 Corrosive Reagents. The following reagents are hazardous. Personal protective equipment and safe procedures that prevent chemical splashes are recommended. If contact occurs, immediately flush with copious amounts of water for at least 15 minutes. Remove clothing under shower and decontaminate. Treat residual chemical burns as thermal burns.

5.2.1 Hydrochloric Acid (HCl). Highly corrosive liquid with toxic vapors. Vapors are highly irritating to eyes, skin, nose, and lungs, causing severe damage. May cause bronchitis, pneumonia, or edema of lungs. Exposure to concentrations of 0.13 to 0.2 percent can be lethal to humans in a few minutes. Provide ventilation to limit exposure. Reacts with metals, producing hydrogen gas.

5.2.2 Hydrofluoric Acid (HF). Highly corrosive to eyes, skin, nose, throat, and lungs. Reaction to exposure may be delayed by 24 hours or more. Provide ventilation to limit exposure.

5.2.3 Nitric Acid (HNO₃). Highly corrosive to eyes, skin, nose, and lungs. Vapors are highly toxic and can cause bronchitis, pneumonia, or edema of lungs. Reaction to inhalation may be delayed as long as 30 hours and still be fatal. Provide ventilation to limit exposure. Strong oxidizer. Hazardous reaction may occur with organic materials such as solvents.

5.2.4 Perchloric Acid (HClO₄). Corrosive to eyes, skin, nose, and throat. Provide ventilation to limit exposure. Very strong oxidizer. Keep separate from water and oxidizable materials to prevent vigorous evolution of heat, spontaneous combustion, or explosion. Heat solutions containing HClO₄ only in hoods specifically designed for HClO₄.

5.2.5 Sulfuric acid (H₂SO₄). Rapidly destructive to body tissue. Will cause third degree burns. Eye damage may result in blindness. Inhalation may be fatal from spasm of the larynx, usually within 30 minutes. May cause lung tissue damage with edema. 3 mg/m³ will cause lung damage in uninitiated. 1

mg/m³ for 8 hours will cause lung damage or, in higher concentrations, death. Provide ventilation to limit inhalation. Reacts violently with metals and organics.

6.0 *Equipment and Supplies*

6.1 Sample Preparation. The following items are required for sample preparation:

6.1.1 Analytical Balance. To measure to within 0.1 mg.

6.1.2 Erlenmeyer Flask. 300-ml.

6.1.3 Hot Plate.

6.1.4 Distillation Apparatus. No. 6, in ASTM E 50-82, 86, or 90 (Reapproved 1995)(incorporated by reference—see §61.18); detailed in Figure 108C-1.

6.1.5 Graduated Cylinder. 50-ml.

6.1.6 Perchloric Acid Fume Hood.

6.2 Analysis. The following items are required for analysis:

6.2.1 Spectrophotometer. Capable of measuring at 660 nm.

6.2.2 Volumetric Flasks. 50- and 100-ml.

7.0 *Reagents and Standards*

Unless otherwise indicated, it is intended that all reagents conform to the specifications established by the Committee on Analytical Reagents of the American Chemical Society, where such specifications are available; otherwise, use the best available grade.

7.1 Sample Preparation. The following reagents are required for sample preparation:

7.1.1 Water. Deionized distilled to meet ASTM D 1193-77 or 91 Type 3 (incorporated by reference—see §61.18). When high concentrations of organic matter are not expected to be present, the KMnO₄ test for oxidizable organic matter may be omitted. Use in all dilutions requiring water.

7.1.2 Nitric Acid, Concentrated.

7.1.3 Hydrofluoric Acid, Concentrated.

7.1.4 Sulfuric Acid, Concentrated.

7.1.5 Perchloric Acid, 70 Percent.

7.1.6 Hydrochloric Acid, Concentrated.

7.1.7 Dilute Hydrochloric Acid. Add one part concentrated HCl to nine parts water.

7.1.8 Hydrazine Sulfate ((NH₂)₂·H₂SO₄).

7.1.9 Potassium Bromide (KBr).

7.1.10 Bromine Water, Saturated.

7.2 Analysis. The following reagents and standards are required for analysis:

7.2.1 Water. Same as in Section 7.1.1.

7.2.2 Methyl Orange Solution, 1 g/liter.

7.2.3 Ammonium Molybdate Solution, 5 g/liter. Dissolve 0.5 g $(\text{NH}_4)_2\text{Mo}_7\text{O}_{24}\cdot 4\text{H}_2\text{O}$ in water in a 100-ml volumetric flask, and dilute to the mark. This solution must be freshly prepared.

7.2.4 Standard Arsenic Solution, 10 μg As/ml. Dissolve 0.13203 g of As_2O_3 in 100 ml HCl in a 1-liter volumetric flask. Add 200 ml of water, cool, dilute to the mark with water, and mix. Transfer 100 ml of this solution to a 1-liter volumetric flask, add 40 ml HCl, cool, dilute to the mark, and mix.

7.2.5 Hydrazine Sulfate Solution, 1 g/liter. Dissolve 0.1 g of $[(\text{NH}_2)_2\cdot\text{H}_2\text{SO}_4]$ in water, and dilute to 100 ml in a volumetric flask. This solution must be freshly prepared.

7.2.6 Potassium Bromate (KBrO_3) Solution, 0.03 Percent Weight by Volume (W/V). Dissolve 0.3 g KBrO_3 in water, and dilute to 1 liter with water.

7.2.7 Ammonium Hydroxide (NH_4OH), Concentrated.

7.2.8 Boiling Granules.

7.2.9 Hydrochloric Acid, 50 percent by volume. Dilute equal parts concentrated HCl with water.

8.0 Sample Collection, Preservation, Transport, and Storage

Same as in Method 108A, Sections 8.1 and 8.2.

9.0 QUALITY CONTROL

Section	Quality control measure	Effect
10.2	Calibration curve preparation	Ensure linearity of spectrophotometric response to standards.

10.0 Calibration and Standardizations

NOTE: Maintain a laboratory log of all calibrations.

10.1 Preparation of Standard Solutions. Transfer 1.0, 2.0, 4.0, 8.0, 12.0, 16.0, and 20.0 ml of standard arsenic solution (10 $\mu\text{g}/\text{ml}$) to each of seven 50-ml volumetric flasks. Dilute to 20 ml with dilute HCl. Add one drop of methyl orange solution and neutralize to the yellow color with dropwise addition of NH_4OH . Just bring back to the red color by dropwise addition of dilute HCl, and add 10 ml in excess. Proceed with the color development as described in Section 11.2.

10.2 Calibration Curve. Plot the spectrophotometric readings of the calibration solutions against μg As per 50 ml of solution. Use this curve to determine the As concentration of each sample.

10.3 Spectrophotometer Calibration Quality Control. Calculate the least squares slope of the calibration curve. The line must pass through the origin or through a point no further from the origin than ± 2 percent of the recorder full scale. Multiply the corrected peak height by the reciprocal of the least squares slope to determine the distance each calibration point lies from the theoretical calibration line. The difference between the calculated concentration values and the actual concentrations must be less than 7 percent for all standards.

11.0 Analytical Procedure

11.1 Sample Preparation.

11.1.1 Weigh 1.0 g of finely pulverized sample to the nearest 0.1 mg. Transfer the sample to a 300 ml Erlenmeyer flask and add 15 ml of HNO_3 , 4 ml HCl , 2 ml HF , 3 ml HClO_4 , and 15 ml H_2SO_4 , in the order listed. In a HClO_4 fume hood, heat on a hot plate to decompose the sample. Then heat while swirling over an open flame until dense white fumes evolve. Cool, add 15 ml of water, swirl to hydrate the H_2SO_4 completely, and add several boiling granules. Cool to room temperature.

11.1.2 Add 1 g of KBr , 1 g hydrazine sulfate, and 50 ml HCl . Immediately attach the distillation head with thermometer and dip the side arm into a 50-ml graduated cylinder containing 25 ml of water and 2 ml of bromine water. Keep the graduated cylinder immersed in a beaker of cold water during distillation. Distill until the temperature of the vapor in the flask reaches 107°C (225°F). When distillation is complete, remove the flask from the hot plate, and simultaneously wash down the side arm with water as it is removed from the cylinder.

11.1.3 If the expected arsenic content is in the range of 0.0020 to 0.10 percent, dilute the distillate to the 50-ml mark of the cylinder with water, stopper, and mix. Transfer a 5.0-ml aliquot to a 50-ml volumetric flask. Add 10 ml of water and a boiling granule. Place the flask on a hot plate, and heat gently until the bromine is expelled and the color of methyl orange indicator persists upon the addition of 1 to 2 drops. Cool the flask to room temperature. Neutralize just to the yellow color of the indicator with dropwise additions of NH_4OH . Bring back to the red color by dropwise addition of dilute HCl , and add 10 ml excess. Proceed with the molybdenum blue color development as described in Section 11.2.

11.1.4 If the expected arsenic content is in the range of 0.0002 to 0.0010 percent As , transfer either the entire initial distillate or the measured remaining distillate from Section 11.1.2 to a 250-ml beaker. Wash the cylinder with two successive portions of concentrated HNO_3 , adding each portion to the distillate in the beaker. Add 4 ml of concentrated HClO_4 , a boiling granule, and cover with a flat watch glass placed slightly to one side. Boil gently on a hot plate until the volume is reduced to approximately 10 ml. Add 3 ml of HNO_3 , and continue the evaporation until HClO_4 is refluxing on the beaker cover. Cool briefly, rinse the underside of the watch glass and the inside of the beaker with about 3-5 ml of water, cover, and continue the evaporation to expel all but 2 ml of the HClO_4 .

NOTE: If the solution appears cloudy due to a small amount of antimony distilling over, add 4 ml of 50 percent HCl and 5 ml of water, cover, and warm gently until clear. If cloudiness persists, add 5 ml of HNO_3 and 2 ml H_2SO_4 . Continue the evaporation of volatile acids to solubilize the antimony until dense white fumes of H_2SO_4 appear. Retain at least 1 ml of the H_2SO_4 .

11.1.5 To the 2 ml of HClO_4 solution or 1 ml of H_2SO_4 solution, add 15 ml of water, boil gently for 2 minutes, and then cool. Proceed with the molybdenum blue color development by neutralizing the solution directly in the beaker just to the yellow indicator color by dropwise addition of NH_4OH . Obtain the red color by dropwise addition of dilute HCl . Transfer the solution to a 50-ml volumetric flask. Rinse the beaker successively with 10 ml of dilute HCl , followed by several small portions of water. At this point the volume of solution in the flask should be no more than 40 ml. Continue with the color development as described in Section 11.2.

11.2 Analysis.

11.2.1 Add 1 ml of KBrO_3 solution to the flask and heat on a low-temperature hot plate to about 50 °C (122 °F) to oxidize the arsenic and methyl orange. Add 5.0 ml of ammonium molybdate solution to the warm solution and mix. Add 2.0 ml of hydrazine sulfate solution, dilute until the solution comes within the neck of the flask, and mix. Place the flask in a 400 ml beaker, 80 percent full of boiling water, for 10 minutes. Enough heat must be supplied to prevent the water bath from cooling much below the boiling point upon inserting the volumetric flask. Remove the flask, cool to room temperature, dilute to the mark, and mix.

11.2.2 Transfer a suitable portion of the reference solution to an absorption cell, and adjust the spectrophotometer to the initial setting using a light band centered at 660 nm. While maintaining this spectrophotometer adjustment, take the readings of the calibration solutions followed by the samples.

12.0 Data Analysis and Calculations

Same as in Method 108A, Section 12.0.

13.0 Method Performance. [Reserved]

14.0 Pollution Prevention. [Reserved]

15.0 Waste Management. [Reserved]

16.0 References

1. Ringwald, D. Arsenic Determination on Process Materials from ASARCO's Copper Smelter in Tacoma, Washington. Unpublished Report. Prepared for the Emission Measurement Branch, Technical Support Division, U.S. Environmental Protection Agency, Research Triangle Park, North Carolina. August 1980. 35 pp.

17.0 TABLES, DIAGRAMS, FLOWCHARTS, AND VALIDATION DATA

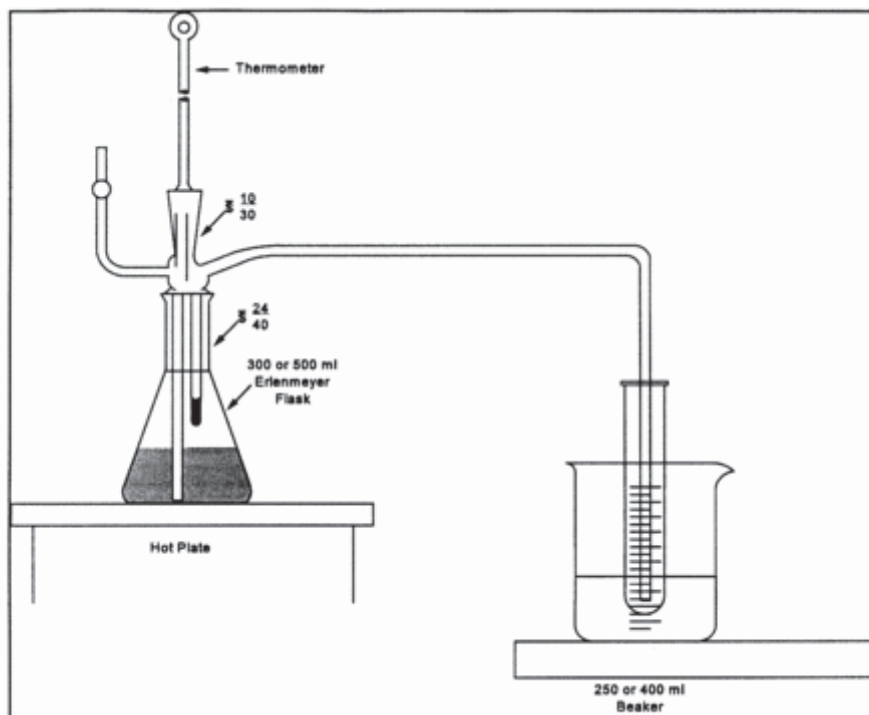

Figure 108C-1. Distillation Apparatus.

[View or download PDF](#)

METHOD 111—DETERMINATION OF POLONIUM-210 EMISSIONS FROM STATIONARY SOURCES

NOTE: This method does not include all of the specifications (e.g., equipment and supplies) and procedures (e.g., sampling and analytical) essential to its performance. Some material is incorporated by reference from methods in appendix A to 40 CFR part 60. Therefore, to obtain reliable results, persons using this method should have a thorough knowledge of at least the following additional test methods: Method 1, Method 2, Method 3, and Method 5.

1.0 Scope and Application

1.1 Analytes.

Analyte	CAS No.	Sensitivity
Polonium	7440-08-6	Not specified.

1.2 Applicability. This method is applicable for the determination of the polonium-210 content of particulate matter samples collected from stationary source exhaust stacks, and for the use of these data to calculate polonium-210 emissions from individual sources and from all affected sources at a facility.

1.3 Data Quality Objectives. Adherence to the requirements of this method will enhance the quality of the data obtained from air pollutant sampling methods.

2.0 Summary of Method

A particulate matter sample, collected according to Method 5, is analyzed for polonium-210 content: the polonium-210 in the sample is put in solution, deposited on a metal disc, and the radioactive disintegration rate measured. Polonium in acid solution spontaneously deposits on surfaces of metals that

are more electropositive than polonium. This principle is routinely used in the radiochemical analysis of polonium-210. Data reduction procedures are provided, allowing the calculation of polonium-210 emissions from individual sources and from all affected sources at a facility, using data obtained from Methods 2 and 5 and from the analytical procedures herein.

3.0 Definitions [Reserved]

4.0 Interferences [Reserved]

5.0 Safety

5.1 Disclaimer. This method may involve hazardous materials, operations, and equipment. This test method may not address all of the safety problems associated with its use. It is the responsibility of the user of this test method to establish appropriate safety and health practices and determine the applicability of regulatory limitations prior to performing this test method.

5.2 Corrosive Reagents. The following reagents are hazardous. Personal protective equipment and safe procedures are useful in preventing chemical splashes. If contact occurs, immediately flush with copious amounts of water at least 15 minutes. Remove clothing under shower and decontaminate. Treat residual chemical burns as thermal burns.

5.2.1 Hydrochloric Acid (HCl). Highly corrosive liquid with toxic vapors. Vapors are highly irritating to eyes, skin, nose, and lungs, causing severe damage. May cause bronchitis, pneumonia, or edema of lungs. Exposure to concentrations of 0.13 to 0.2 percent can be lethal to humans in a few minutes. Provide ventilation to limit exposure. Reacts with metals, producing hydrogen gas.

5.2.2 Hydrofluoric Acid (HF). Highly corrosive to eyes, skin, nose, throat, and lungs. Reaction to exposure may be delayed by 24 hours or more. Provide ventilation to limit exposure.

5.2.3 Nitric Acid (HNO₃). Highly corrosive to eyes, skin, nose, and lungs. Vapors cause bronchitis, pneumonia, or edema of lungs. Reaction to inhalation may be delayed as long as 30 hours and still be fatal. Provide ventilation to limit exposure. Strong oxidizer. Hazardous reaction may occur with organic materials such as solvents.

5.2.4 Perchloric Acid (HClO₄). Corrosive to eyes, skin, nose, and throat. Provide ventilation to limit exposure. Keep separate from water and oxidizable materials to prevent vigorous evolution of heat, spontaneous combustion, or explosion. Heat solutions containing HClO₄ only in hoods specifically designed for HClO₄.

6.0 Equipment and Supplies

6.1 Alpha Spectrometry System. Consisting of a multichannel analyzer, biasing electronics, silicon surface barrier detector, vacuum pump and chamber.

6.2 Constant Temperature Bath at 85 °C (185 °F).

6.3 Polished Silver Discs. 3.8 cm diameter, 0.4 mm thick with a small hole near the edge.

6.4 Glass Beakers. 400 ml, 150 ml.

6.5 Hot Plate, Electric.

6.6 Fume Hood.

- 6.7 Teflon Beakers, 150 ml.
- 6.8 Magnetic Stirrer.
- 6.9 Stirring Bar.
- 6.10 Hooks. Plastic or glass, to suspend plating discs.
- 6.11 Internal Proportional Counter. For measuring alpha particles.
- 6.12 Nucleopore Filter Membranes. 25 mm diameter, 0.2 micrometer pore size or equivalent.
- 6.13 Planchets. Stainless steel, 32 mm diameter with 1.5 mm lip.
- 6.14 Transparent Plastic Tape. 2.5 cm wide with adhesive on both sides.
- 6.15 Epoxy Spray Enamel.
- 6.16 Suction Filter Apparatus. For 25 mm diameter filter.
- 6.17 Wash Bottles, 250 ml capacity.
- 6.18 Graduated Cylinder, plastic, 25 ml capacity.
- 6.19 Volumetric Flasks, 100 ml, 250 ml.

7.0 *Reagents and Standards*

Unless otherwise indicated, it is intended that all reagents conform to the specifications established by the Committee on Analytical Reagents of the American Chemical Society, where such specifications are available; otherwise, use the best available grade.

- 7.1 Ascorbic Acid.
- 7.2 Ammonium Hydroxide (NH_4OH), 15 M.
- 7.3 Water. Deionized distilled, to conform to ASTM D 1193-77 or 91 (incorporated by reference—see §61.18), Type 3. Use in all dilutions requiring water.
- 7.4 Ethanol ($\text{C}_2\text{H}_5\text{OH}$), 95 percent.
- 7.5 Hydrochloric Acid, 12 M.
- 7.6 Hydrochloric Acid, 1 M. Dilute 83 ml of the 12 M HCl to 1 liter with distilled water.
- 7.7 Hydrofluoric Acid, 29 M.
- 7.8 Hydrofluoric Acid, 3 M. Dilute 52 ml of the 29 M HF to 500 ml with distilled water. Use a plastic graduated cylinder and storage bottle.

7.9 Lanthanum Carrier, 0.1 mg La⁺³/ml. Dissolve 0.078 gram lanthanum nitrate, La(NO₃)₃·6H₂O in 250 ml of 1 M HCl.

7.10 Nitric Acid, 16 M.

7.11 Perchloric Acid, 12 M.

7.12 Polonium-209 Solution.

7.13 Silver Cleaner. Any mild abrasive commercial silver cleaner.

7.14 Degreaser.

7.15 Standard Solution. Standardized solution of an alpha-emitting actinide element, such as plutonium-239 or americium-241.

8.0 Sample Collection, Preservation, Transport, and Storage. [Reserved]

9.0 Quality Control

9.1 General Requirement.

9.1.1 All analysts using this method are required to demonstrate their ability to use the method and to define their respective accuracy and precision criteria.

9.2 MISCELLANEOUS QUALITY CONTROL MEASURES

Section	Quality control measure	Effect
10.1	Standardization of alpha spectrometry system	Ensure precision of sample analyses.
10.3	Standardization of internal proportional counter	Ensure precise sizing of sample aliquot.
11.1, 11.2	Determination of procedure background and instrument background	Minimize background effects.

10.0 Calibration and Standardization

10.1 Standardization of Alpha Spectrometry System.

10.1.1 Add a quantity of the actinide standard solution to a 100 ml volumetric flask so that the final concentration when diluted to a volume of 100 ml will be approximately 1 pCi/ml.

10.1.2 Add 10 ml of 16 M HNO₃ and dilute to 100 ml with water.

10.1.3 Add 20 ml of 1 M HCl to each of six 150 ml beakers. Add 1.0 ml of lanthanum carrier, 0.1 mg lanthanum per ml, to the acid solution in each beaker.

10.1.4 Add 1.0 ml of the 1 pCi/ml working solution (from Section 10.1.1) to each beaker. Add 5.0 ml of 3 M HF to each beaker.

10.1.5 Cover beakers and allow solutions to stand for a minimum of 30 minutes. Filter the contents of each beaker through a separate filter membrane using the suction filter apparatus. After each filtration, wash the filter membrane with 10 ml of distilled water and 5 ml of ethanol, and allow the filter membrane to air dry on the filter apparatus.

10.1.6 Carefully remove the filter membrane and mount it, filtration side up, with double-side tape on the inner surface of a planchet. Place planchet in an alpha spectrometry system and count each planchet for 1000 minutes.

10.1.7 Calculate the counting efficiency of the detector for each aliquot of the 1 pCi/ml actinide working solution using Eq. 111-1 in Section 12.2.

10.1.8 Determine the average counting efficiency of the detector, E_c , by calculating the average of the six determinations.

10.2 Preparation of Standardized Solution of Polonium-209.

10.2.1 Add a quantity of the Po-209 solution to a 100 ml volumetric flask so that the final concentration when diluted to a 100 ml volume will be approximately 1 pCi/ml.

10.2.2 Follow the procedures outlined in Sections 10.1.2 through 10.1.6, except substitute 1.0 ml of polonium-209 tracer solution (Section 10.2.1) and 3.0 ml of 15 M ammonium hydroxide for the 1 pCi/ml actinide working solution and the 3 M HF, respectively.

10.2.3 Calculate the activity of each aliquot of the polonium-209 tracer solution using Eq. 111-2 in Section 12.3.

10.2.4 Determine the average activity of the polonium-209 tracer solution, F , by averaging the results of the six determinations.

10.3 Standardization of Internal Proportional Counter

10.3.1 Add a quantity of the actinide standard solution to a 100 ml volumetric flask so that the final concentration when diluted to a 100 ml volume will be approximately 100 pCi/ml.

10.3.2 Follow the procedures outlined in Sections 10.1.2 through 10.1.6, except substitute the 100 pCi/ml actinide working solution for the 1 pCi/ml solution, place the planchet in an internal proportional counter (instead of an alpha spectrometry system), and count for 100 minutes (instead of 1000 minutes).

10.3.3 Calculate the counting efficiency of the internal proportional counter for each aliquot of the 100 pCi/ml actinide working solution using Eq. 111-3 in 12.4.

10.3.4 Determine the average counting efficiency of the internal proportional counter, E_i , by averaging the results of the six determinations.

11.0 ANALYTICAL PROCEDURE

NOTE: Perform duplicate analyses of all samples, including background counts and Method 5 samples. Duplicate measurements are considered acceptable when the difference between them is less than two standard deviations as described in EPA 600/4-77-001 or subsequent revisions.

11.1 Determination of Procedure Background. Background counts used in all equations are determined by performing the specific analysis required using the analytical reagents only. All procedure

background counts and sample counts for the internal proportional counter should utilize a counting time of 100 minutes; for the alpha spectrometry system, 1000 minutes. These background counts should be performed no less frequently than once per 10 sample analyses.

11.2 Determination of Instrument Background. Instrument backgrounds of the internal proportional counter and the alpha spectrometry system should be determined on a weekly basis. Instrument background should not exceed procedure background. If this occurs, it may be due to a malfunction or contamination, and should be corrected before use.

11.4 Sample Preparation. Treat the Method 5 samples [*i.e.*, the glass fiber filter (Container No. 1) and the acetone rinse (Container No. 2)] as follows:

11.4.1 Container No. 1. Transfer the filter and any loose particulate matter from the sample container to a 150-ml Teflon beaker.

11.4.2 Container No. 2. Note the level of liquid in the container, and confirm on the analysis sheet whether leakage occurred during transport. If a noticeable amount of leakage has occurred, either void the sample or use methods, subject to the approval of the Administrator, to correct the final results. Transfer the contents to a 400-ml glass beaker. Add polonium-209 tracer solution to the glass beaker in an amount approximately equal to the amount of polonium-210 expected in the total particulate sample. Record the activity of the tracer solution added. Add 16 M nitric acid to the beaker to digest and loosen the residue.

11.4.3 Transfer the contents of the glass beaker to the Teflon beaker containing the glass fiber filter. Rinse the glass beaker with 16 M HNO₃. If necessary, reduce the volume in the beaker by evaporation until all of the nitric acid HNO₃ from the glass beaker has been transferred to the Teflon beaker.

11.4.4 Add 30 ml of 29 M HF to the Teflon beaker and evaporate to near dryness on a hot plate in a properly operating hood.

NOTE: Do not allow the residue to go to dryness and overheat; this will result in loss of polonium.

11.4.5 Repeat step 11.4.4 until the filter is dissolved.

11.4.6 Add 100 ml of 16 M HNO₃ to the residue in the Teflon beaker and evaporate to near dryness.

NOTE: Do not allow the residue to go to dryness.

11.4.7 Add 50 ml of 16 M HNO₃ and 10 ml of 12 M perchloric acid to the Teflon beaker and heat until dense fumes of perchloric acid are evolved.

11.4.8 Repeat steps 11.4.4 to 11.4.7 as necessary until sample is completely dissolved.

11.4.9 Add 10 ml of 12 M HCl to the Teflon beaker and evaporate to dryness. Repeat additions and evaporations several times.

11.4.10 Transfer the sample to a 250-ml volumetric flask and dilute to volume with 3 M HCl.

11.5 Sample Screening. To avoid contamination of the alpha spectrometry system, check each sample as follows:

11.5.1 Add 20 ml of 1 M HCl, 1 ml of the lanthanum carrier solution (0.1 mg La/ml), a 1 ml aliquot of the sample solution from Section 11.4.10, and 3 ml of 15 M ammonium hydroxide to a 250-ml beaker in the order listed. Allow this solution to stand for a minimum of 30 minutes.

11.5.2 Filter the solution through a filter membrane using the suction filter apparatus. Wash the filter membrane with 10 ml of water and 5 ml of ethanol, and allow the filter membrane to air dry on the filter apparatus.

11.5.3 Carefully remove the filter membrane and mount it, filtration side up, with double-side tape on the inner surface of a planchet. Place the planchet in an internal proportional counter, and count for 100 minutes.

11.5.4 Calculate the activity of the sample using Eq. 11-4 in Section 12.5.

11.5.5 Determine the aliquot volume of the sample solution from Section 11.4.10 to be analyzed for polonium-210, such that the aliquot contains an activity between 1 and 4 picocuries. Use Eq. 11-5 in Section 12.6.

11.6 Preparation of Silver Disc for Spontaneous Electrodeposition.

11.6.1 Clean both sides of the polished silver disc with silver cleaner and with degreaser.

11.6.2 Place disc on absorbent paper and spray one side with epoxy spray enamel. This should be carried out in a well-ventilated area, with the disc lying flat to keep paint on one side only. Allow paint to dry for 24 hours before using disc for deposition.

11.7 Sample Analysis.

11.7.1 Add the aliquot of sample solution from Section 11.4.10 to be analyzed for polonium-210, the volume of which was determined in Section 11.5.5, to a suitable 200-ml container to be placed in a constant temperature bath.

NOTE: Aliquot volume may require a larger container.

11.7.2 If necessary, bring the volume to 100 ml with 1 M HCl. If the aliquot volume exceeds 100 ml, use total aliquot.

11.7.3 Add 200 mg of ascorbic acid and heat solution to 85 °C (185 °F) in a constant temperature bath.

11.7.4 Suspend a silver disc in the heated solution using a glass or plastic rod with a hook inserted through the hole in the disc. The disc should be totally immersed in the solution, and the solution must be stirred constantly, at all times during the plating operation. Maintain the disc in solution for 3 hours.

11.7.5 Remove the silver disc, rinse with deionized distilled water, and allow to air dry at room temperature.

11.7.6 Place the disc, with deposition side (unpainted side) up, on a planchet and secure with double-side plastic tape. Place the planchet with disc in alpha spectrometry system and count for 1000 minutes.

12.0 Data Analysis and Calculations.

12.1 Nomenclature.

A = Picocuries of polonium-210 in the Method 5 sample (from Section 12.8).

A_A = Picocuries of actinide added.

A_L = Volume of sample aliquot used, in ml (specified in Section 11.5.1 as 1 ml).

A_S = Aliquot to be analyzed, in ml.

B_B = Procedure background counts measured in polonium-209 spectral region.

B_T = Polonium-209 tracer counts in sample.

C_T = Total counts in polonium-210 spectral region.

D = Decay correction for time "t" (in days) from sample collection to sample counting, given by: $D = e^{-0.005t}$

E_C = Average counting efficiency of detector (from Section 10.1.8), as counts per disintegration.

E_{Ci} = Counting efficiency of the detector for aliquot i of the actinide working solution, counts per disintegration.

E_i = Average counting efficiency of the internal proportional counter, as determined in Section 10.3.4, counts per disintegration.

E_{ii} = Counting efficiency of the internal proportional counter for aliquot i of the 100 pCi/ml actinide working solution, counts per disintegration.

E_Y = The fraction of polonium-209 recovered on the planchet (from Section 12.7).

F = Average activity of polonium-209 in sample (from Section 10.2.4), in pCi.

F_i = activity of aliquot i of the polonium-209 tracer solution, in pCi.

L = Dilution factor (unitless). This is the volume of sample solution prepared (specified as 250 ml in Section 11.1.10) divided by the volume of the aliquot of sample solution analyzed for polonium-210 (from Section 11.7.1).

M_i = Phosphorous rock processing rate of the source being tested, during run i, Mg/hr.

M_k = Phosphate rock processed annually by source k, in Mg/yr.

n = Number of calciners at the elemental phosphorus plant.

P = Total activity of sample solution from Section 11.4.10, in pCi (see Eq. 111-4).

Q_{sd} = Volumetric flow rate of effluent stream, as determined by Method 2, in dscm/hr.

S = Annual polonium-210 emissions from the entire facility, in curies/yr.

$V_{m(std)}$ = Volume of air sample, as determined by Method 5, in dscm.

X_k = Emission rate from source k, from Section 12.10, in curies/Mg.

10^{-12} = Curies per picocurie.

2.22 = Disintegrations per minute per picocurie.

250 = Volume of solution from Section 11.4.10, in ml.

12.2 Counting Efficiency. Calculate the counting efficiency of the detector for each aliquot of the 1 pCi/ml actinide working solution using Eq. 111-1.

$$E_{Ci} = \frac{C_s - C_B}{2.22 A_A T} \quad \text{Eq. 111-1}$$

[View or download PDF](#)

Where:

C_B = Background counts in same peak area as C_s .

C_s = Gross counts in actinide peak.

T = Counting time in minutes, specified in Section 10.1.6 as 1000 minutes.

12.3 Polonium-209 Tracer Solution Activity. Calculate the activity of each aliquot of the polonium-209 tracer solution using Eq. 111-2.

$$F_1 = \frac{C_s - C_B}{2.22 E_{Ci} T} \quad \text{Eq. 111-2}$$

[View or download PDF](#)

Where:

C_B = Background counts in the 4.88 MeV region of spectrum the in the counting time T .

C_s = Gross counts of polonium-209 in the 4.88 MeV region of the spectrum in the counting time T .

T = Counting time, specified in Section 10.1.6 as 1000 minutes.

12.4 Control Efficiency of Internal Proportional Counter. Calculate the counting efficiency of the internal proportional counter for each aliquot of the 100 pCi/ml actinide working solution using Eq. 111-3.

$$E_{II} = \frac{C_s - C_B}{2.22 A_A T} \quad \text{Eq. 111-3}$$

[View or download PDF](#)

Where:

C_B = Gross counts of procedure background.

C_s = Gross counts of standard.

T = Counting time in minutes, specified in Section 10.3.2 as 100 minutes.

12.5 Calculate the activity of the sample using Eq. 111-4.

$$P = \frac{250 (C_s - C_B)}{2.22 E_1 A_L T} \quad \text{Eq. 111-4}$$

[View or download PDF](#)

Where:

C_B = Total counts of procedure background. (See Section 11.1).

C_S = Total counts of screening sample.

T = Counting time for sample and background (which must be equal), in minutes (specified in Section 11.5.3 as 100 minutes).

12.6 Aliquot Volume. Determine the aliquot volume of the sample solution from Section 11.4.10 to be analyzed for polonium-210, such that the aliquot contains an activity between 1 and 4 picocuries using Eq. 111-5.

$$A_s = \frac{250 \text{ (desired picocuries in aliquot)}}{P} \quad \text{Eq. 111-5}$$

[View or download PDF](#)

12.7 Polonium-209 Recovery. Calculate the fraction of polonium-209 recovered on the planchet, E_Y , using Eq. 111-6.

$$E_Y = \frac{B_T - B_B}{2.22 \bar{F} \bar{E}_C T} \quad \text{Eq. 111-6}$$

[View or download PDF](#)

Where:

T = Counting time, specified in Section 11.1 as 1000 minutes.

12.8 Polonium-210 Activity. Calculate the activity of polonium-210 in the Method 5 sample (including glass fiber filter and acetone rinse) using Eq. 111-7.

$$A = \frac{(C_T - C_B) L}{2.22 E_Y \bar{E}_C T D} \quad \text{Eq. 111-7}$$

[View or download PDF](#)

Where:

C_B = Procedure background counts in polonium-210 spectral region.

T = Counting time, specified in Section 11.1 as 1000 minutes for all alpha spectrometry sample and background counts.

12.9 Emission Rate from Each Stack.

12.9.1 For each test run, i , on a stack, calculate the measured polonium-210 emission rate, R_{Si} , using Eq. 111-8.

$$R_{Si} = \frac{(10^{-12})AQ_{sd}}{V_{m(sdt)}M_i} \quad \text{Eq. 111-8}$$

[View or download PDF](#)

12.9.2 Determine the average polonium-210 emission rate from the stack, R_s , by taking the sum of the measured emission rates for all runs, and dividing by the number of runs performed.

12.9.3 Repeat steps 12.9.1 and 12.9.2 for each stack of each calciner.

12.10 Emission Rate from Each Source. Determine the total polonium-210 emission rate, X_k , from each source, k , by taking the sum of the average emission rates from all stacks to which the source exhausts.

12.11 Annual Polonium-210 Emission Rate from Entire Facility. Determine the annual elemental phosphorus plant emissions of polonium-210, S , using Eq. 111-9.

$$S = \frac{\sum_{k=1}^n (X_k M_k)}{n} \quad \text{Eq. 111-9}$$

[View or download PDF](#)

13.0 *Method Performance. [Reserved]*

14.0 *Pollution Prevention. [Reserved]*

15.0 *Waste Management. [Reserved]*

16.0 *References*

1. Blanchard, R.L. "Rapid Determination of Lead-210 and Polonium-210 in Environmental Samples by Deposition on Nickel." *Anal. Chem.*, 38:189, pp. 189-192. February 1966.

17.0 *Tables, Diagrams, Flowcharts, and Validation Data [Reserved]*

METHOD 114—TEST METHODS FOR MEASURING RADIONUCLIDE EMISSIONS FROM STATIONARY SOURCES

1. *Purpose and Background*

This method provides the requirements for: (1) Stack monitoring and sample collection methods appropriate for radionuclides; (2) radiochemical methods which are used in determining the amounts of radionuclides collected by the stack sampling and; (3) quality assurance methods which are conducted in conjunction with these measurements. These methods are appropriate for emissions for stationary sources. A list of references is provided.

Many different types of facilities release radionuclides into air. These radionuclides differ in the chemical and physical forms, half-lives and type of radiation emitted. The appropriate combination of sample extraction, collection and analysis for an individual radionuclide is dependent upon many interrelated factors including the mixture of other radionuclides present. Because of this wide range of conditions, no single method for monitoring or sample collection and analysis of a radionuclide is applicable to all types of facilities. Therefore, a series of methods based on "principles of measurement" are described for monitoring and sample collection and analysis which are applicable to the measurement of radionuclides found in effluent streams at stationary sources. This approach provides the user with the

flexibility to choose the most appropriate combination of monitoring and sample collection and analysis methods which are applicable to the effluent stream to be measured.

2. Stack Monitoring and Sample Collection Methods

Monitoring and sample collection methods are described based on “principles of monitoring and sample collection” which are applicable to the measurement of radionuclides from effluent streams at stationary sources. Radionuclides of most elements will be in the particulate form in these effluent streams and can be readily collected using a suitable filter media. Radionuclides of hydrogen, oxygen, carbon, nitrogen, the noble gases and in some circumstances iodine will be in the gaseous form. Radionuclides of these elements will require either the use of an in-line or off-line monitor to directly measure the radionuclides, or suitable sorbers, condensers or bubblers to collect the radionuclides.

2.1 Radionuclides as Particulates. The extracted effluent stream is passed through a filter media to remove the particulates. The filter must have a high efficiency for removal of sub-micron particles. The guidance in ANSI/HPS N13.1-1999 (section 6.6.2 Filter media) shall be followed in using filter media to collect particulates (incorporated by reference—see §61.18 of this part).

2.2 Radionuclides as Gases.

2.2.1 The Radionuclide Tritium (H-3). Tritium in the form of water vapor is collected from the extracted effluent sample by sorption, condensation or dissolution techniques. Appropriate collectors may include silica gel, molecular sieves, and ethylene glycol or water bubblers.

Tritium in the gaseous form may be measured directly in the sample stream using Method B-1, collected as a gas sample or may be oxidized using a metal catalyst to tritiated water and collected as described above.

2.2.2 Radionuclides of Iodine. Iodine is collected from an extracted sample by sorption or dissolution techniques. Appropriate collectors may include charcoal, impregnated charcoal, metal zeolite and caustic solutions.

2.2.3 Radionuclides of Argon, Krypton and Xenon. Radionuclides of these elements are either measured directly by an in-line or off-line monitor, or are collected from the extracted sample by low temperature sorption techniques. Appropriate sorbers may include charcoal or metal zeolite.

2.2.4 Radionuclides of Oxygen, Carbon, Nitrogen and Radon. Radionuclides of these elements are measured directly using an in-line or off-line monitor. Radionuclides of carbon in the form of carbon dioxide may be collected by dissolution in caustic solutions.

2.3 Definition of Terms

In-line monitor means a continuous measurement system in which the detector is placed directly in or adjacent to the effluent stream. This may involve either gross radioactivity measurements or specific radionuclide measurements. Gross measurements shall be made in conformance with the conditions specified in Methods A-4, B-2 and G-4.

Off-line monitor means a measurement system in which the detector is used to continuously measure an extracted sample of the effluent stream. This may involve either gross radioactivity measurements or specific radionuclide measurements. Gross measurements shall be made in conformance with the conditions specified in Methods A-4, B-2 and G-4.

Sample collection means a procedure in which the radionuclides are removed from an extracted sample of the effluent using a collection media. These collection media include filters, absorbers, bubblers and condensers. The collected sample is analyzed using the methods described in Section 3.

3. Radionuclide Analysis Methods

A series of methods based on “principles of measurement” are described which are applicable to the analysis of radionuclides collected from airborne effluent streams at stationary sources. These methods are applicable only under the conditions stated and within the limitations described. Some methods specify that only a single radionuclide be present in the sample or the chemically separated sample. This condition should be interpreted to mean that no other radionuclides are present in quantities which would interfere with the measurement.

Also identified (Table 1) are methods for a selected list of radionuclides. The listed radionuclides are those which are most commonly used and which have the greatest potential for causing dose to members of the public. Use of methods based on principles of measurement other than those described in this section must be approved in advance of use by the Administrator. For radionuclides not listed in Table 1, any of the described methods may be used provided the user can demonstrate that the applicability conditions of the method have been met.

The type of method applicable to the analysis of a radionuclide is dependent upon the type of radiation emitted, i.e., alpha, beta or gamma. Therefore, the methods described below are grouped according to principles of measurements for the analysis of alpha, beta and gamma emitting radionuclides.

3.1 Methods for Alpha Emitting Radionuclides

3.1.1 Method A-1, Radiochemistry-Alpha Spectrometry.

Principle: The element of interest is separated from other elements, and from the sample matrix using radiochemical techniques. The procedure may involve precipitation, ion exchange, or solvent extraction. Carriers (elements chemically similar to the element of interest) may be used. The element is deposited on a planchet in a very thin film by electrodeposition or by coprecipitation on a very small amount of carrier, such as lanthanum fluoride. The deposited element is then counted with an alpha spectrometer. The activity of the nuclide of interest is measured by the number of alpha counts in the appropriate energy region. A correction for chemical yield and counting efficiency is made using a standardized radioactive nuclide (tracer) of the same element. If a radioactive tracer is not available for the element of interest, a predetermined chemical yield factor may be used.

Applicability: This method is applicable for determining the activity of any alpha-emitting radionuclide, regardless of what other radionuclides are present in the sample provided the chemical separation step produces a very thin sample and removes all other radionuclides which could interfere in the spectral region of interest. APHA-605(2), ASTM-D-3972(13).

3.1.2 Method A-2, Radiochemistry-Alpha Counting.

Principle: The element of interest is separated from other elements, and from the sample matrix using radiochemistry. The procedure may involve precipitation, ion exchange, or solvent extraction. Carriers (elements chemically similar to the element of interest) may be used. The element is deposited on a planchet in a thin film and counted with an alpha counter. A correction for chemical yield (if necessary) is made. The alpha count rate measures the total activity of all emitting radionuclides of the separated element.

Applicability: This method is applicable for the measurement of any alpha-emitting radionuclide, provided no other alpha emitting radionuclide is present in the separated sample. It may also be applicable for determining compliance, when other radionuclides of the separated element are present, provided that the calculated emission rate is assigned to the radionuclide which could be present in the sample that has the highest dose conversion factor. IDO-12096(18).

3.1.3 Method A-3, Direct Alpha Spectrometry.

Principle: The sample, collected on a suitable filter, is counted directly on an alpha spectrometer. The sample must be thin enough and collected on the surface of the filter so that any absorption of alpha particle energy in the sample or the filter, which would degrade the spectrum, is minimal.

Applicability: This method is applicable to simple mixtures of alpha emitting radionuclides and only when the amount of particulates collected on the filter paper are relatively small and the alpha spectra is adequately resolved. Resolutions should be 50 keV (FWHM) or better, ASTM-D-3084(16).

3.1.4 Method A-4, Direct Alpha Counting (Gross alpha determination).

Principle: The sample, collected on a suitable filter, is counted with an alpha counter. The sample must be thin enough so that self-absorption is not significant and the filter must be of such a nature that the particles are retained on the surface.

Applicability: Gross alpha determinations may be used to measure emissions of specific radionuclides only (1) when it is known that the sample contains only a single radionuclide, or the identity and isotopic ratio of the radionuclides in the sample are well-known, and (2) measurements using either Method A-1, A-2 or A-5 have shown that this method provides a reasonably accurate measurement of the emission rate. Gross alpha measurements are applicable to unidentified mixtures of radionuclides only for the purposes and under the conditions described in section 3.7. APHA-601(3), ASTM-D-1943(10).

3.1.5 Method A-5, Chemical Determination of Uranium.

Principle: Uranium may be measured chemically by either colorimetry or fluorometry. In both procedures, the sample is dissolved, the uranium is oxidized to the hexavalent form and extracted into a suitable solvent. Impurities are removed from the solvent layer. For colorimetry, dibenzoylmethane is added, and the uranium is measured by the absorbance in a colorimeter. For fluorometry, a portion of the solution is fused with a sodium fluoride-lithium fluoride flux and the uranium is determined by the ultraviolet activated fluorescence of the fused disk in a fluorometer.

Applicability: This method is applicable to the measurements of emission rates of uranium when the isotopic ratio of the uranium radionuclides is well known. ASTM-E-318(15), ASTM-D-2907(14).

3.1.6 Method A-6, Radon-222—Continuous Gas Monitor.

Principle: Radon-222 is measured directly in a continuously extracted sample stream by passing the air stream through a calibrated scintillation cell. Prior to the scintillation cell, the air stream is treated to remove particulates and excess moisture. The alpha particles from radon-222 and its decay products strike a zinc sulfide coating on the inside of the scintillation cell producing light pulses. The light pulses are detected by a photomultiplier tube which generates electrical pulses. These pulses are processed by the system electronics and the read out is in pCi/l of radon-222.

Applicability: This method is applicable to the measurement of radon-222 in effluent streams which do not contain significant quantities of radon-220. Users of this method should calibrate the monitor in a

radon calibration chamber at least twice per year. The background of the monitor should also be checked periodically by operating the instrument in a low radon environment. EPA 520/1-89-009(24).

3.1.7 Method A-7, Radon-222-Alpha Track Detectors

Principle: Radon-222 is measured directly in the effluent stream using alpha track detectors (ATD). The alpha particles emitted by radon-222 and its decay products strike a small plastic strip and produce submicron damage tracks. The plastic strip is placed in a caustic solution that accentuates the damage tracks which are counted using a microscope or automatic counting system. The number of tracks per unit area is correlated to the radon concentration in air using a conversion factor derived from data generated in a radon calibration facility.

Applicability: Prior approval from EPA is required for use of this method. This method is only applicable to effluent streams which do not contain significant quantities of radon-220, unless special detectors are used to discriminate against radon-220. This method may be used only when ATDs have been demonstrated to produce data comparable to data obtained with Method A-6. Such data should be submitted to EPA when requesting approval for the use of this method. EPA 520/1-89-009(24).

3.2 Methods for Gaseous Beta Emitting Radionuclides.

3.2.1 Method B-1, Direct Counting in Flow-Through Ionization Chambers.

Principle: An ionization chamber containing a specific volume of gas which flows at a given flow rate through the chamber is used. The sample (effluent stream sample) acts as the counting gas for the chamber. The activity of the radionuclide is determined from the current measured in the ionization chamber.

Applicability: This method is applicable for measuring the activity of a gaseous beta-emitting radionuclide in an effluent stream that is suitable as a counting gas, when no other beta-emitting nuclides are present. DOE/EP-0096(17), NCRP-58(23).

3.2.2 Method B-2, Direct Counting With In-line or Off-line Beta Detectors.

Principle: The beta detector is placed directly in the effluent stream (in-line) or an extracted sample of the effluent stream is passed through a chamber containing a beta detector (off-line). The activities of the radionuclides present in the effluent stream are determined from the beta count rate, and a knowledge of the radionuclides present and the relationship of the gross beta count rate and the specific radionuclide concentration.

Applicability: This method is applicable only to radionuclides with maximum beta particle energies greater than 0.2 MeV. This method may be used to measure emissions of specific radionuclides only when it is known that the sample contains only a single radionuclide or the identity and isotopic ratio of the radionuclides in the effluent stream are well known. Specific radionuclide analysis of periodic grab samples may be used to identify the types and quantities of radionuclides present and to establish the relationship between specific radionuclide analyses and gross beta count rates.

This method is applicable to unidentified mixtures of gaseous radionuclides only for the purposes and under the conditions described in section 3.7.

3.3 Methods for Non-Gaseous Beta Emitting Radionuclides.

3.3.1 Method B-3, Radiochemistry-Beta Counting.

Principle: The element of interest is separated from other elements, and from the sample matrix by radiochemistry. This may involve precipitation, distillation, ion exchange, or solvent extraction. Carriers (elements chemically similar to the element of interest) may be used. The element is deposited on a planchet, and counted with a beta counter. Corrections for chemical yield, and decay (if necessary) are made. The beta count rate determines the total activity of all radionuclides of the separated element. This method may also involve the radiochemical separation and counting of a daughter element, after a suitable period of ingrowth, in which case it is specific for the parent nuclide.

Applicability: This method is applicable for measuring the activity of any beta-emitting radionuclide, with a maximum energy greater than 0.2 MeV, provided no other radionuclide is present in the separated sample. APHA-608(5).

3.3.2 Method B-4, Direct Beta Counting (Gross beta determination).

Principle: The sample, collected on a suitable filter, is counted with a beta counter. The sample must be thin enough so that self-absorption corrections can be made.

Applicability: Gross beta measurements are applicable only to radionuclides with maximum beta particle energies greater than 0.2 MeV. Gross beta measurements may be used to measure emissions of specific radionuclides only (1) when it is known that the sample contains only a single radionuclide, and (2) measurements made using Method B-3 show reasonable agreement with the gross beta measurement. Gross beta measurements are applicable to mixtures of radionuclides only for the purposes and under the conditions described in section 3.7. APHA-602(4), ASTM-D-1890(11).

3.3.3 Method B-5, Liquid Scintillation Spectrometry.

Principle: An aliquot of a collected sample or the result of some other chemical separation or processing technique is added to a liquid scintillation "cocktail" which is viewed by photomultiplier tubes in a liquid scintillation spectrometer. The spectrometer is adjusted to establish a channel or "window" for the pulse energy appropriate to the nuclide of interest. The activity of the nuclide of interest is measured by the counting rate in the appropriate energy channel. Corrections are made for chemical yield where separations are made.

Applicability: This method is applicable to any beta-emitting nuclide when no other radionuclide is present in the sample or the separated sample provided that it can be incorporated in the scintillation cocktail. This method is also applicable for samples which contain more than one radionuclide but only when the energies of the beta particles are sufficiently separated so that they can be resolved by the spectrometer. This method is most applicable to the measurement of low-energy beta emitters such as tritium and carbon-14. APHA-609(6), EML-LV-539-17(19).

3.4 Gamma Emitting Radionuclides

3.4.1 Method G-1, High Resolution Gamma Spectrometry.

Principle: The sample is counted with a high resolution gamma detector, usually either a Ge(Li) or a high purity Ge detector, connected to a multichannel analyzer or computer. The gamma emitting radionuclides in the sample are measured from the gamma count rates in the energy regions characteristic of the individual radionuclide. Corrections are made for counts contributed by other radionuclides to the spectral regions of the radionuclides of interest. Radiochemical separations may be made prior to counting but are usually not necessary.

Applicability: This method is applicable to the measurement of any gamma emitting radionuclide with gamma energies greater than 20 keV. It can be applied to complex mixtures of radionuclides. The

samples counted may be in the form of particulate filters, absorbers, liquids or gases. The method may also be applied to the analysis of gaseous gamma emitting radionuclides directly in an effluent stream by passing the stream through a chamber or cell containing the detector. ASTM-3649(9), IDO-12096(18).

3.4.2 Method G-2, Low Resolution Gamma Spectrometry.

Principle: The sample is counted with a low resolution gamma detector, a thallium activated sodium iodide crystal. The detector is coupled to a photomultiplier tube and connected to a multichannel analyzer. The gamma emitting radionuclides in the sample are measured from the gamma count rates in the energy regions characteristic of the individual radionuclides. Corrections are made for counts contributed by other radionuclides to the spectral regions of the radionuclides of interest. Radiochemical separation may be used prior to counting to obtain less complex gamma spectra if needed.

Applicability: This method is applicable to the measurement of gamma emitting radionuclides with energies greater than 100 keV. It can be applied only to relatively simple mixtures of gamma emitting radionuclides. The samples counted may be in the form of particulate filters, absorbers, liquids or gas. The method can be applied to the analysis of gaseous radionuclides directly in an effluent stream by passing the gas stream through a chamber or cell containing the detector. ASTM-D-2459(12), EMSL-LV-0539-17(19).

3.4.3 Method G-3, Single Channel Gamma Spectrometry.

Principle: The sample is counted with a thallium activated sodium iodide crystal. The detector is coupled to a photomultiplier tube connected to a single channel analyzer. The activity of a gamma emitting radionuclide is determined from the gamma counts in the energy range for which the counter is set.

Applicability: This method is applicable to the measurement of a single gamma emitting radionuclide. It is not applicable to mixtures of radionuclides. The samples counted may be in the form of particulate filters, absorbers, liquids or gas. The method can be applied to the analysis of gaseous radionuclides directly in an effluent stream by passing the gas stream through a chamber or cell containing the detector.

3.4.4 Method G-4, Gross Gamma Counting.

Principle: The sample is counted with a gamma detector usually a thallium activated sodium iodine crystal. The detector is coupled to a photomultiplier tube and gamma rays above a specific threshold energy level are counted.

Applicability: Gross gamma measurements may be used to measure emissions of specific radionuclides only when it is known that the sample contains a single radionuclide or the identity and isotopic ratio of the radionuclides in the effluent stream are well known. When gross gamma measurements are used to determine emissions of specific radionuclides periodic measurements using Methods G-1 or G-2 should be made to demonstrate that the gross gamma measurements provide reliable emission data. This method may be applied to analysis of gaseous radionuclides directly in an effluent stream by placing the detector directly in or adjacent to the effluent stream or passing an extracted sample of the effluent stream through a chamber or cell containing the detector.

3.5 Counting Methods. All of the above methods with the exception of Method A-5 involve counting the radiation emitted by the radionuclide. Counting methods applicable to the measurement of alpha, beta and gamma radiations are listed below. The equipment needed and the counting principles involved are described in detail in ASTM-3648(8).

3.5.1 Alpha Counting:

- *Gas Flow Proportional Counters.* The alpha particles cause ionization in the counting gas and the resulting electrical pulses are counted. These counters may be windowless or have very thin windows.
- *Scintillation Counters.* The alpha particles transfer energy to a scintillator resulting in a production of light photons which strike a photomultiplier tube converting the light photons to electrical pulses which are counted. The counters may involve the use of solid scintillation materials such as zinc sulfide or liquid scintillation solutions.
- *Solid-State Counters.* Semiconductor materials, such as silicon surface-barrier p-n junctions, act as solid ionization chambers. The alpha particles interact with the detector producing electron hole pairs. The charged pair is collected by an applied electrical field and the resulting electrical pulses are counted.
- *Alpha Spectrometers.* Semiconductor detectors used in conjunction with multichannel analyzers for energy discrimination.

3.5.2 Beta Counting:

- *Ionization Chambers.* These chambers contain the beta-emitting nuclide in gaseous form. The ionization current produced is measured.
- *Geiger-Muller (GM) Counters-or Gas Flow Proportional Counters.* The beta particles cause ionization in the counting gas and the resulting electrical pulses are counted. Proportional gas flow counters which are heavily shielded by lead or other metal, and provided with an anti-coincidence shield to reject cosmic rays, are called low background beta counters.
- *Scintillation Counters.* The beta particles transfer energy to a scintillator resulting in a production of light photons, which strike a photomultiplier tube converting the light photon to electrical pulses which are counted. This may involve the use of anthracene crystals, plastic scintillator, or liquid scintillation solutions with organic phosphors.
- *Liquid Scintillation Spectrometers.* Liquid scintillation counters which use two photomultiplier tubes in coincidence to reduce background counts. This counter may also electronically discriminate among pulses of a given range of energy.

3.5.3 Gamma Counting:

- *Low-Resolution Gamma Spectrometers.* The gamma rays interact with thallium activated sodium iodide or cesium iodide crystal resulting in the release of light photons which strike a photomultiplier tube converting the light pulses to electrical pulses proportional to the energy of the gamma ray. Multi-channel analyzers are used to separate and store the pulses according to the energy absorbed in the crystal.
- *High-Resolution gamma Spectrometers.* Gamma rays interact with a lithium-drifted (Ge(Li)) or high-purity germanium (HPGe) semiconductor detectors resulting in a production of electron-hole pairs. The charged pair is collected by an applied electrical field. A very stable low noise preamplifier amplifies the pulses of electrical charge resulting from the gamma photon interactions. Multichannel analyzers or computers are used to separate and store the pulses according to the energy absorbed in the crystal.
- *Single Channel Analyzers.* Thallium activated sodium iodide crystals used with a single window analyzer. Pulses from the photomultiplier tubes are separated in a single predetermined energy range.

3.5.4 Calibration of Counters. Counters are calibrated for specific radionuclide measurements using a standard of the radionuclide under either identical or very similar conditions as the sample to be counted. For gamma spectrometers a series of standards covering the energy range of interest may be used to construct a calibration curve relating gamma energy to counting efficiency.

In those cases where a standard is not available for a radionuclide, counters may be calibrated using a standard with energy characteristics as similar as possible to the radionuclide to be measured. For gross alpha and beta measurements of the unidentified mixtures of radionuclides, alpha counters are calibrated with a natural uranium standard and beta counters with a cesium-137 standard. The standard must contain the same weight and distribution of solids as the samples, and be mounted in an identical manner. If the samples contain variable amounts of solids, calibration curves relating weight of solids present to counting efficiency are prepared. Standards other than those prescribed may be used provided it can be shown that such standards are more applicable to the radionuclide mixture measured.

3.6 Radiochemical Methods for Selected Radionuclides. Methods for a selected list of radionuclides are listed in Table 1. The radionuclides listed are those which are most commonly used and which have the greatest potential for causing doses to members of the public. For radionuclides not listed in Table 1, methods based on any of the applicable “principles of measurement” described in section 3.1 through 3.4 may be used.

3.7 Applicability of Gross Alpha and Beta Measurements to Unidentified Mixtures of Radionuclides. Gross alpha and beta measurements may be used as a screening measurement as a part of an emission measurement program to identify the need to do specific radionuclide analyses or to confirm or verify that unexpected radionuclides are not being released in significant quantities.

Gross alpha (Method A-4) or gross beta (Methods B-2 or B-4) measurements may also be used for the purpose of comparing the measured concentrations in the effluent stream with the limiting “Concentration Levels for Environmental Compliance” in table 2 of appendix E. For unidentified mixtures, the measured concentration value shall be compared with the lowest environmental concentration limit for any radionuclide which is not known to be absent from the effluent stream.

TABLE 1—LIST OF APPROVED METHODS FOR SPECIFIC RADIONUCLIDES

Radionuclide	Approved methods of analysis
Am-241	A-1, A-2, A-3, A-4
Ar-41	B-1, B-2, G-1, G-2, G-3, G-4
Ba-140	G-1, G-2, G-3, G-4
Br-82	G-1, G-2, G-3, G-4
C-11	B-1, B-2, G-1, G-2, G-3, G-4
C-14	B-5
Ca-45	B-3, B-4, B-5
Ce-144	G-1, G-2, G-3, G-4
Cm-244	A-1, A-2, A-3, A-4
Co-60	G-1, G-2, G-3, G-4

Cr-51	G-1, G-2, G-3, G-4
Cs-134	G-1, G-2, G-3, G-4
Cs-137	G-1, G-2, G-3, G-4
Fe-55	B-5, G-1
Fe-59	G-1, G-2, G-3, G-4
Ga-67	G-1, G-2, G-3, G-4
H-3 (H ₂ O)	B-5
H-3 (gas)	B-1
I-123	G-1, G-2, G-3, G-4
I-125	G-1
I-131	G-1, G-2, G-3, G-4
In-113m	G-1, G-2, G-3, G-4
Ir-192	G-1, G-2, G-3, G-4
Kr-85	B-1, B-2, B-5, G-1, G-2, G-3, G-4
Kr-87	B-1, B-2, G-1, G-2, G-3, G-4
Kr-88	B-1, B-2, G-1, G-2, G-3, G-4
Mn-54	G-1, G-2, G-3, G-4
Mo-99	G-1, G-2, G-3, G-4
N-13	B-1, B-2, G-1, G-2, G-3, G-4
O-15	B-1, B-2, G-1, G-2, G-3, G-4
P-32	B-3, B-4, B-5
Pm-147	B-3, B-4, B-5
Po-210	A-1, A-2, A-3, A-4
Pu-238	A-1, A-2, A-3, A-4
Pu-239	A-1, A-2, A-3, A-4
Pu-240	A-1, A-2, A-3, A-4
Ra-226	A-1, A-2, G-1, G-2
S-35	B-5
Se-75	G-1, G-2, G-3, G-4
Sr-90	B-3, B-4, B-5

Tc-99	B-3, B-4, B-5
Te-201	G-1, G-2, G-3, G-4
Uranium (total alpha)	A-1, A-2, A-3, A-4
Uranium (Isotopic)	A-1, A-3
Uranium (Natural)	A-5
Xe-133	G-1
Yb-169	G-1, G-2, G-3, G-4
Zn-65	G-1, G-2, G-3, G-4

4. Quality Assurance Methods

Each facility required to measure their radionuclide emissions shall conduct a quality assurance program in conjunction with the radionuclide emission measurements. This program shall assure that the emission measurements are representative, and are of known precision and accuracy and shall include administrative controls to assure prompt response when emission measurements indicate unexpectedly large emissions. The program shall consist of a system of policies, organizational responsibilities, written procedures, data quality specifications, audits, corrective actions and reports. This quality assurance program shall include the following program elements:

4.1 The organizational structure, functional responsibilities, levels of authority and lines of communications for all activities related to the emissions measurement program shall be identified and documented.

4.2 Administrative controls shall be prescribed to ensure prompt response in the event that emission levels increase due to unplanned operations.

4.3 The sample collection and analysis procedures used in measuring the emissions shall be described including where applicable:

4.3.1 Identification of sampling sites and number of sampling points, including the rationale for site selections.

4.3.2 A description of sampling probes and representativeness of the samples.

4.3.3 A description of any continuous monitoring system used to measure emissions, including the sensitivity of the system, calibration procedures and frequency of calibration.

4.3.4 A description of the sample collection systems for each radionuclide measured, including frequency of collection, calibration procedures and frequency of calibration.

4.3.5 A description of the laboratory analysis procedures used for each radionuclide measured, including frequency of analysis, calibration procedures and frequency of calibration.

4.3.6 A description of the sample flow rate measurement systems or procedures, including calibration procedures and frequency of calibration.

4.3.7 A description of the effluent flow rate measurement procedures, including frequency of measurements, calibration procedures and frequency of calibration.

4.4 The objectives of the quality assurance program shall be documented and shall state the required precision, accuracy and completeness of the emission measurement data including a description of the procedures used to assess these parameters. Accuracy is the degree of agreement of a measurement with a true or known value. Precision is a measure of the agreement among individual measurements of the same parameters under similar conditions. Completeness is a measure of the amount of valid data obtained compared to the amount expected under normal conditions.

4.5 A quality control program shall be established to evaluate and track the quality of the emissions measurement data against preset criteria. The program should include where applicable a system of replicates, spiked samples, split samples, blanks and control charts. The number and frequency of such quality control checks shall be identified.

4.6 A sample tracking system shall be established to provide for positive identification of samples and data through all phases of the sample collection, analysis and reporting system. Sample handling and preservation procedures shall be established to maintain the integrity of samples during collection, storage and analysis.

4.7 Regular maintenance, calibration and field checks shall be performed for each sampling system in use by satisfying the requirements found in Table 2: Maintenance, Calibration and Field Check Requirements.

TABLE 2—MAINTENANCE, CALIBRATION AND FIELD CHECK REQUIREMENTS

Sampling system components	Frequency of activity
Cleaning of thermal anemometer elements	As required by application.
Inspect pitot tubes for contaminant deposits	At least annually.
Inspect pitot tube systems for leaks	At least annually.
Inspect sharp-edged nozzles for damage	At least annually or after maintenance that could cause damage.
Check nozzles for alignment, presence of deposits, or other potentially degrading factors	Annually.
Check transport lines of HEPA-filtered applications to determine if cleaning is required	Annually.
Clean transport lines	Visible deposits for HEPA-filtered applications. Mean mass of deposited material exceeds 1g/m ² for other applications.
Inspect or test the sample transport system for leaks	At least annually.

Check mass flow meters of sampling systems with a secondary or transfer standard	At least quarterly.
Inspect rotameters of sampling systems for presence of foreign matter	At the start of each sampling period.
Check response of stack flow rate systems	At least quarterly.
Calibration of flow meters of sampling systems	At least annually.
Calibration of effluent flow measurement devices	At least annually.
Calibration of timing devices	At least annually.

4.8 Periodic internal and external audits shall be performed to monitor compliance with the quality assurance program. These audits shall be performed in accordance with written procedures and conducted by personnel who do not have responsibility for performing any of the operations being audited.

4.9 A corrective action program shall be established including criteria for when corrective action is needed, what corrective actions will be taken and who is responsible for taking the corrective action.

4.10 Periodic reports to responsible management shall be prepared on the performance of the emissions measurements program. These reports should include assessment of the quality of the data, results of audits and description of corrective actions.

4.11 The quality assurance program should be documented in a quality assurance project plan that should address each of the above requirements.

5. References

(1) American National Standards Institute "Guide to Sampling Airborne Radioactive Materials in Nuclear Facilities", ANSI-N13.1-1969, American National Standards Institute, New York, New York (1969).

(2) American Public Health Association, "Methods of Air Sampling", 2nd Edition, Method 605, "Tentative Method of Analysis for Plutonium Content of Atmospheric Particulate Matter". American Public Health Association, New York, NY (1977).

(3) Ibid, Method 601, "Tentative Method of Analysis for Gross Alpha Radioactivity Content of the Atmosphere".

(4) Ibid, Method 602, "Tentative Method of the Analysis for Gross Beta Radioactivity Content of the Atmosphere".

(5) Ibid, Method 608, "Tentative Method of Analysis for Strontium-90 Content of Atmospheric Particulate Matter".

(6) Ibid, Method 609, "Tentative Method of Analysis for Tritium Content of the Atmosphere".

- (7) Ibid, Method 603, "Tentative Method of Analysis for Iodine-131 Content of the Atmosphere".
- (8) American Society for Testing and Materials, 1986 Annual Book ASTM Standards, Designation D-3648-78, "Standard Practices for the Measurement of Radioactivity". American Society for Testing and Materials, Philadelphia, PA (1986).
- (9) Ibid, Designation D-3649-85, "Standard Practice for High Resolution Gamma Spectrometry".
- (10) Ibid, Designation D-1943-81, "Standard Test Method for Alpha Particle Radioactivity of Water".
- (11) Ibid, Designation D-1890-81, "Standard Test Method for Beta Particle Radioactivity of Water".
- (12) Ibid, Designation D-2459-72, "Standard Test Method for Gamma Spectrometry of Water".
- (13) Ibid, Designation D-3972-82, "Standard Test Method for Isotopic Uranium in Water by Radiochemistry".
- (14) Ibid, Designation D-2907-83, "Standard Test Methods for Microquantities of Uranium in Water by Fluorometry".
- (15) Ibid, Designation E-318, "Standard Test Method for Uranium in Aqueous Solutions by Colorimetry".
- (16) Ibid, Designation D-3084-75, "Standard Practice for Alpha Spectrometry of Water".
- (17) Corley, J.P. and C.D. Corbit, "A Guide for Effluent Radiological Measurements at DOE Installations", DOE/EP-0096, Pacific Northwest Laboratories, Richland, Washington (1983).
- (18) Department of Energy, "RESL Analytical Chemistry Branch Procedures Manual", IDO-12096, U.S. Department of Energy, Idaho Falls, Idaho (1982).
- (19) Environmental Protection Agency, "Radiochemical Analytical Procedures for Analysis of Environmental Samples", EMSL-LV-0539-17, U.S. Environmental Protection Agency, Environmental Monitoring and Support Laboratory, Las Vegas, Nevada (1979).
- (20) Environmental Protection Agency, "Radiochemistry Procedures Manual", EPA 520/5-84-006, Eastern Environmental Radiation Facility, Montgomery, Alabama (1984).
- (21) National Council on Radiation Protection and Measurements, NCRP Report No. 50, "Environmental Radiation Measurements", National Council on Radiation Protection and Measurement, Bethesda, Maryland (1976).
- (22) Ibid, Report No. 47, "Tritium Measurement Techniques". (1976).
- (23) Ibid, Report No. 58 "A Handbook of Radioactivity Measurement Procedures" (1985).
- (24) Environmental Protection Agency, "Indoor Radon and Radon Decay Product Measurement Protocols", EPA 520/1-89-009, U.S. Environmental Protection Agency, Washington, DC (1989).

This appendix describes the monitoring methods which must be used in determining the radon-222 emissions from underground uranium mines, uranium mill tailings piles, phosphogypsum stacks, and other piles of waste material emitting radon.

1. Radon-222 Emissions from Underground Uranium Mine Vents

1.1 Sampling Frequency and Calculation of Emissions. Radon-222 emissions from underground uranium mine vents shall be determined using one of the following methods:

1.1.1 Continuous Measurement. These measurements shall be made and the emissions calculated as follows:

(a) The radon-222 concentration shall be continuously measured at each mine vent whenever the mine ventilation system is operational.

(b) Each mine vent exhaust flow rate shall be measured at least 4 times per year.

(c) A weekly radon-222 emission rate for the mine shall be calculated and recorded weekly as follows:

$$A_w = C_1 Q_1 T_1 + C_2 Q_2 T_2 + \dots + C_i Q_i T_i$$

Where:

A_w = Total radon-222 emitted from the mine during week (Ci)

C_i = Average radon-222 concentration in mine vent i (Ci/m³)

Q_i = Volumetric flow rate from mine vent i (m³/hr)

T_i = Hours of mine ventilation system operation during week for mine vent i (hr)

(d) The annual radon-222 emission rate is the sum of the weekly emission rates during a calendar year.

1.1.2 Periodic Measurement. This method is applicable only to mines that continuously operate their ventilation system except for extended shutdowns. Mines which start up and shut down their ventilation system frequently must use the continuous measurement method describe in Section 1.1.1 above. Emission rates determined using periodic measurements shall be measured and calculated as follows:

(a) The radon-222 shall be continuously measured at each mine vent for at least one week every three months.

(b) Each mine vent exhaust flow rate shall be measured at least once during each of the radon-222 measurement periods.

(c) A weekly radon-222 emission rate shall be calculated for each weekly period according to the method described in Section 1.1.1. In this calculation T = 168 hr.

(d) The annual radon-222 emission rate from the mine should be calculated as follows:

$$A_y = \frac{52 - W_s}{n} (A_{w1} + A_{w2} + \dots + A_{wn})$$

[View or download PDF](#)

Where:

A_y = Annual radon-222 emission rate from the mine(Ci)

A_{wi} = Weekly radon-222 emission rate during the measurement period i (Ci)

n = Number of weekly measurement periods per year

W_s = Number of weeks during the year that the mine ventilation system is shut down in excess of 7 consecutive days, i.e. the sum of the number of weeks each shut down exceeds 7 days

1.2 Test Methods and Procedures

Each underground mine required to test its emissions, unless an equivalent or alternative method has been approved by the Administrator, shall use the following test methods:

1.2.1 Test Method 1 of appendix A to part 60 shall be used to determine velocity traverses. The sampling point in the duct shall be either the centroid of the cross section or the point of average velocity.

1.2.2 Test Method 2 of appendix A to part 60 shall be used to determine velocity and volumetric flow rates.

1.2.3 Test Methods A-6 or A-7 of appendix B, Method 114 to part 61 shall be used for the analysis of radon-222. Use of Method A-7 requires prior approval of EPA based on conditions described in appendix B.

1.2.4 A quality assurance program shall be conducted in conformance with the programs described for Continuous Radon Monitors and Alpha Track Detectors in EPA 520/1-89-009. (2)

2. Radon-222 Emissions from Uranium Mill Tailings Piles

2.1 Measurement and Calculation of Radon Flux from Uranium Mill Tailings Piles.

2.1.1 Frequency of Flux Measurement. A single set of radon flux measurements may be made, or if the owner or operator chooses, more frequent measurements may be made over a one year period. These measurements may involve quarterly, monthly or weekly intervals. All radon measurements shall be made as described in paragraphs 2.1.2 through 2.1.6 except that for measurements made over a one year period, the requirement of paragraph 2.1.4(c) shall not apply. The mean radon flux from the pile shall be the arithmetic mean of the mean radon flux for each measurement period. The weather conditions, moisture content of the tailings and area of the pile covered by water existing at the time of the measurement shall be chosen so as to provide measurements representative of the long term radon flux from the pile and shall be subject to EPA review and approval.

2.1.2 Distribution of Flux Measurements. The distribution and number of radon flux measurements required on a pile will depend on clearly defined areas of the pile (called regions) that can have significantly different radon fluxes due to surface conditions. The mean radon flux shall be determined for each individual region of the pile. Regions that shall be considered for operating mill tailings piles are:

- (a) Water covered areas,
- (b) Water saturated areas (beaches),

- (c) Dry top surface areas, and
- (d) Sides, except where earthen material is used in dam construction.

For mill tailings after disposal the pile shall be considered to consist of only one region.

2.1.3 Number of Flux Measurements. Radon flux measurements shall be made within each region on the pile, except for those areas covered with water. Measurements shall be made at regularly spaced locations across the surface of the region, realizing that surface roughness will prohibit measurements in some areas of a region. The minimum number of flux measurements considered necessary to determine a representative mean radon flux value for each type of region on an operating pile is:

- (a) Water covered area—no measurements required as radon flux is assumed to be zero,
- (b) Water saturated beaches—100 radon flux measurements,
- (c) Loose and dry top surface—100 radon flux measurements,
- (d) Sides—100 radon flux measurements, except where earthen material is used in dam construction.

For a mill tailings pile after disposal which consists of only one region a minimum of 100 measurements are required.

2.1.4 Restrictions to Radon Flux Measurements. The following restrictions are placed on making radon flux measurements:

- (a) Measurements shall not be initiated within 24 hours of a rainfall.
- (b) If a rainfall occurs during the 24 hour measurements period, the measurement is invalid if the seal around the lip of the collector has washed away or if the collector is surrounded by water.
- (c) Measurements shall not be performed if the ambient temperature is below 35 °F or if the ground is frozen.

2.1.5 Areas of Pile Regions. The approximate area of each region of the pile shall be determined in units of square meters.

2.1.6 Radon Flux Measurement. Measuring radon flux involves the adsorption of radon on activated charcoal in a large-area collector. The radon collector is placed on the surface of the pile area to be measured and allowed to collect radon for a time period of 24 hours. The radon collected on the charcoal is measured by gamma-ray spectroscopy. The detailed measurement procedure provided in appendix A of EPA 520/5-85-0029(1) shall be used to measure the radon flux on uranium mill tailings, except the surface of the tailings shall not be penetrated by the lip of the radon collector as directed in the procedure, rather the collector shall be carefully positioned on a flat surface with soil or tailings used to seal the edge.

2.1.7 Calculations. The mean radon flux for each region of the pile and for the total pile shall be calculated and reported as follows:

- (a) The individual radon flux calculations shall be made as provided in appendix A EPA 86 (1). The mean radon flux for each region of the pile shall be calculated by summing all individual flux measurements for the region and dividing by the total number of flux measurements for the region.

(b) The mean radon flux for the total uranium mill tailings pile shall be calculated as follows.

$$J_s = \frac{J_1 A_1 + \dots + J_2 A_2 + \dots + J_i A_i}{A_t}$$

[View or download PDF](#)

Where:

J_s = Mean flux for the total pile (pCi/m²-s)

J_i = Mean flux measured in region i (pCi/m²-s)

A_i = Area of region i (m²)

A_t = Total area of the pile (m²)

2.1.8 Reporting. The results of individual flux measurements, the approximate locations on the pile, and the mean radon flux for each region and the mean radon flux for the total stack shall be included in the emission test report. Any condition or unusual event that occurred during the measurements that could significantly affect the results should be reported.

3.0 Radon-222 Emissions from Phosphogypsum Stacks.

3.1 Measurement and Calculation of the Mean Radon Flux. Radon flux measurements shall be made on phosphogypsum stacks as described below:

3.1.1 Frequency of Measurements. A single set of radon flux measurements may be made after the phosphogypsum stack becomes inactive, or if the owner or operator chooses, more frequent measurements may be made over a one year period. These measurements may involve quarterly, monthly or weekly intervals. All radon measurements shall be made as described in paragraphs 3.1.2 through 3.1.6 except that for measurements made over a one year period, the requirement of paragraph 3.1.4(c) shall not apply. For measurements made over a one year period, the radon flux shall be the arithmetic mean of the mean radon flux for each measurement period.

3.1.2 Distribution and Number of Flux Measurements. The distribution and number of radon flux measurements required on a stack will depend on clearly defined areas of the stack (called regions) that can have significantly different radon fluxes due to surface conditions. The mean radon flux shall be determined for each individual region of the stack. Regions that shall be considered are:

- (a) Water covered areas,
- (b) Water saturated areas (beaches),
- (c) Loose and dry top surface areas,
- (d) Hard-packed roadways, and
- (e) Sides.

3.1.3 Number of Flux Measurements. Radon flux measurements shall be made within each region on the phosphogypsum stack, except for those areas covered with water. Measurements shall be made at regularly spaced locations across the surface of the region, realizing that surface roughness will prohibit measurements in some areas of a region. The minimum number of flux measurements considered necessary to determine a representative mean radon flux value for each type of region is:

- (a) Water covered area—no measurements required as radon flux is assumed to be zero,
- (b) Water saturated beaches—50 radon flux measurements,
- (c) Loose and dry top surface—100 radon flux measurements,
- (d) Hard-packed roadways—50 radon flux measurements, and
- (e) Sides—100 radon flux measurements.

A minimum of 300 measurements are required. A stack that has no water cover can be considered to consist of two regions, top and sides, and will require a minimum of only 200 measurements.

3.1.4 Restrictions to Radon Flux Measurements. The following restrictions are placed on making radon flux measurements:

- (a) Measurements shall not be initiated within 24 hours of a rainfall.
- (b) If a rainfall occurs during the 24 hour measurement period, the measurement is invalid if the seal around the lip of the collector has washed away or if the collector is surrounded by water.
- (c) Measurements shall not be performed if the ambient temperature is below 35 °F or if the ground is frozen.

3.1.5 Areas of Stack Regions. The approximate area of each region of the stack shall be determined in units of square meters.

3.1.6 Radon Flux Measurements. Measuring radon flux involves the adsorption of radon on activated charcoal in a large-area collector. The radon collector is placed on the surface of the stack area to be measured and allowed to collect radon for a time period of 24 hours. The radon collected on the charcoal is measured by gamma-ray spectroscopy. The detailed measurement procedure provided in appendix A of EPA 520/5-85-0029(1) shall be used to measure the radon flux on phosphogypsum stacks, except the surface of the phosphogypsum shall not be penetrated by the lip of the radon collector as directed in the procedure, rather the collector shall be carefully positioned on a flat surface with soil or phosphogypsum used to seal the edge.

3.1.7 Calculations. The mean radon flux for each region of the phosphogypsum stack and for the total stack shall be calculated and reported as follows:

- (a) The individual radon flux calculations shall be made as provided in appendix A EPA 86 (1). The mean radon flux for each region of the stack shall be calculated by summing all individual flux measurements for the region and dividing by the total number of flux measurements for the region.
- (b) The mean radon flux for the total phosphogypsum stack shall be calculated as follows.

$$J_s = \frac{J_1A_1 + J_2A_2 + \dots + J_iA_i}{A_t}$$

[View or download PDF](#)

Where:

J_s = Mean flux for the total stack (pCi/m²-s)

J_i = Mean flux measured in region i (pCi/m²-s)

A_i = Area of region i (m^2)

A_t = Total area of the stack

3.1.8 Reporting. The results of individual flux measurements, the approximate locations on the stack, and the mean radon flux for each region and the mean radon flux for the total stack shall be included in the emission test report. Any condition or unusual event that occurred during the measurements that could significantly affect the results should be reported.

4.0 Quality Assurance Procedures for Measuring Rn-222 Flux

A. SAMPLING PROCEDURES

Records of field activities and laboratory measurements shall be maintained. The following information shall be recorded for each charcoal canister measurement:

- (a) Site
- (b) Name of pile
- (c) Sample location
- (d) Sample ID number
- (e) Date and time on
- (f) Date and time off
- (g) Observations of meteorological conditions and comments

Records shall include all applicable information associated with determining the sample measurement, calculations, observations, and comments.

B. SAMPLE CUSTODY

Custodial control of all charcoal samples exposed in the field shall be maintained in accordance with EPA chain-of-custody field procedures. A control record shall document all custody changes that occur between the field and laboratory personnel.

C. CALIBRATION PROCEDURES AND FREQUENCY

The radioactivity of two standard charcoal sources, each containing a carefully determined quantity of radium-226 uniformly distributed through 180g of activated charcoal, shall be measured. An efficiency factor is computed by dividing the average measured radioactivity of the two standard charcoal sources, minus the background, in cpm by the known radioactivity of the charcoal sources in dpm. The same two standard charcoal sources shall be counted at the beginning and at the end of each day's counting as a check of the radioactivity counting equipment. A background count using unexposed charcoal should also be made at the beginning and at the end of each counting day to check for inadvertent contamination of the detector or other changes affecting the background. The unexposed charcoal comprising the blank is changed with each new batch of charcoal used.

D. INTERNAL QUALITY CONTROL CHECKS AND FREQUENCY

The charcoal from every tenth exposed canister shall be recounted. Five percent of the samples analyzed shall be either blanks (charcoal having no radioactivity added) or samples spiked with known quantities of radium-226.

E. DATA PRECISION, ACCURACY, AND COMPLETENESS

The precision, accuracy, and completeness of measurements and analyses shall be within the following limits for samples measuring greater than 1.0 pCi/m²-s.

- (a) Precision: 10%
- (b) Accuracy: $\pm 10\%$
- (c) Completeness: at least 85% of the measurements must yield useable results.

5.0 REFERENCES

(1) Hartley, J.N. and Freeman, H.D., "Radon Flux Measurements on Gardinier and Royster phosphogypsum Piles Near Tampa and Mulberry, Florida," U.S. Environmental Protection Agency Report, EPA 520/5-85-029, January 1986.

(2) Environmental Protection Agency, "Indoor Radon and Radon Decay Product Measurement Protocols", EPA 520/1-89-009, U.S. Environmental Protection Agency, Washington, DC. (1989).

[38 FR 8826, Apr. 6, 1973]

EDITORIAL NOTES: 1. For FEDERAL REGISTER citations to appendix B see the List of CFR Sections Affected, which appears in the Finding Aids section of the printed volume and at www.fdsys.gov.

2. At 65 FR 62161, Oct. 17, 2000, appendix B to part 61 was amended by revising Methods 101, 101A, 102, 103, 104, 105, 106, 107, 107A, 108, 108A, 108B, 108C, and 111. However, because the amendment contains no revised text for Method 107A, this part of the revision could not be incorporated.

[↑ Back to Top](#)

Appendix C to Part 61—Quality Assurance Procedures

Procedure 1—Determination of Adequate Chromatographic Peak Resolution

In this method of dealing with resolution, the extent to which one chromatographic peak overlaps another is determined.

For convenience, consider the range of the elution curve of each compound as running from -2σ to $+2\sigma$. This range is used in other resolution criteria, and it contains 95.45 percent of the area of a normal curve. If two peaks are separated by a known distance, b , one can determine the fraction of the area of one curve that lies within the range of the other. The extent to which the elution curve of a contaminant compound overlaps the curve of a compound that is under analysis is found by integrating the contaminant curve over the limits $b-2\sigma_s$ to $b+2\sigma_s$, where σ_s is the standard deviation of the sample curve.

This calculation can be simplified in several ways. Overlap can be determined for curves of unit area; then actual areas can be introduced. Desired integration can be resolved into two integrals of the normal distribution function for which there are convenient calculation programs and tables. An example

would be Program 15 in Texas Instruments Program Manual ST1, 1975, Texas Instruments, Inc., Dallas, Texas 75222.

$$\frac{1}{\sqrt{2\pi}\sigma_c} \int_{b-2\sigma_s}^{b+2\sigma_s} e^{-\frac{t^2}{2\sigma_c^2}} dt = \frac{1}{\sqrt{2\pi}} \int_{\frac{b-2\sigma_s}{\sigma_c}}^{\frac{b+2\sigma_s}{\sigma_c}} e^{-\frac{x^2}{2}} dx = \frac{1}{\sqrt{2\pi}} \int_{\frac{b-2\sigma_s}{\sigma_c}}^{\infty} e^{-\frac{x^2}{2}} dx - \frac{1}{\sqrt{2\pi}} \int_{\frac{b+2\sigma_s}{\sigma_c}}^{\infty} e^{-\frac{x^2}{2}} dx$$

The following calculation steps are required:*

1. $2\sigma_s = t_s / \sqrt{2 \ln 2}$

2. $\sigma_c = t_c / \sqrt{2 \ln 2}$

3. $x_1 = (b - 2\sigma_s) / \sigma_c$

4. $x_2 = (b + 2\sigma_s) / \sigma_c$

5. $Q(x_1) = \frac{1}{\sqrt{2\pi}} \int_{x_1}^{\infty} e^{-\frac{x^2}{2}} dx$

6. $Q(x_2) = \frac{1}{\sqrt{2\pi}} \int_{x_2}^{\infty} e^{-\frac{x^2}{2}} dx$

7. $I_o = Q(x_1) - Q(x_2)$

8. $A_o = I_o A_c / A_s$

9. Percentage overlap = $A_o \times 100$.

where:

A_s = Area of the sample peak of interest determined by electronic integration or by the formula $A_s = h_s t_s$.

A_c = Area of the contaminant peak, determined in the same manner as A_s .

b = Distance on the chromatographic chart that separates the maxima of the two peaks.

H_s = Peak height of the sample compound of interest, measured from the average value of the baseline to the maximum of the curve.

t_s = Width of sample peak of interest at 1/2 peak height.

t_c = Width of the contaminant peak at 1/2 of peak height.

σ_s = Standard deviation of the sample compound of interest elution curve.

σ_c = Standard deviation of the contaminant elution curve.

$Q(x_1)$ = Integral of the normal distribution function from x_1 to infinity.

$Q(x_2)$ = Integral of the normal distribution function from x_2 to infinity.

I_o = Overlap integral.

A_o = Area overlap fraction.

*In most instances, $Q(x_2)$ is very small and may be neglected.

[View or download PDF](#)

In judging the suitability of alternate GC columns or the effects of altering chromatographic conditions, one can employ the area overlap as the resolution parameter with a specific maximum permissible value.

The use of Gaussian functions to describe chromatographic elution curves is widespread. However, some elution curves are highly asymmetric. In cases where the sample peak is followed by a contaminant that has a leading edge that rises sharply but the curve then tails off, it may be possible to define an effective width for t_c as "twice the distance from the leading edge to a perpendicular line through the maxim of the contaminant curve, measured along a perpendicular bisection of that line."

Procedure 2—Procedure for Field Auditing GC Analysis

Responsibilities of audit supervisor and analyst at the source sampling site include the following:

A. The audit supervisor verifies that audit cylinders are stored in a safe location both before and after the audit to prevent vandalism.

B. At the beginning and conclusion of the audit, the analyst records each cylinder number and pressure. An audit cylinder is never analyzed when the pressure drops below 200 psi.

C. During the audit, the analyst performs a minimum of two consecutive analyses of each audit cylinder gas. The audit must be conducted to coincide with the analysis of source test samples, normally immediately after GC calibration and prior to sample analyses.

D. At the end of audit analyses, the audit supervisor requests the calculated concentrations from the analyst and compares the results with the actual audit concentrations. If each measured concentration agrees with the respective actual concentration within ± 10 percent, he directs the analyst to begin analyzing source samples. Audit supervisor judgment and/or supervisory policy determine action when agreement is not within ± 10 percent. When a consistent bias in excess of 10 percent is found, it may be possible to proceed with the sample analysis, with a corrective factor to be applied to the results at a later time. However, every attempt should be made to locate the cause of the discrepancy, as it may be misleading. The audit supervisor records each cylinder number, cylinder pressure (at the end of the audit), and all calculated concentrations. The individual being audited must not under any circumstance be told actual audit concentrations until calculated concentrations have been submitted to the audit supervisor.

FIELD AUDIT REPORT

Part A— To be filled out by organization supplying audit cylinders.

1. Organization supplying audit sample(s) and shipping address

2. Audit supervisor, organization, and phone number

3. Shipping instructions: Name, Address, Attention

4. Guaranteed arrival date for cylinders

5. Planned shipping date for cylinders

6. Details on audit cylinders from last analysis

	Low conc.	High conc.
a. Date of last analysis		
b. Cylinder number		
c. Cylinder pressure, psi		

d. Audit gas(es)/balance gas		
e. Audit gas(es), ppm		
f. Cylinder construction		

Part B—To be filled out by audit supervisor.

1. Process sampled
2. Audit location
3. Name of individual audit
4. Audit date

5. Audit results:

	Low conc. cylinder	High conc. cylinder
a. Cylinder number		
b. Cylinder pressure before audit, psi		
c. Cylinder pressure after audit, psi		
d. Measured concentration, ppm Injection #1* Injection #2* Average		
e. Actual audit concentration, ppm (Part A, 6e)		
f. Audit accuracy: ¹		
Low Conc. Cylinder		
High Conc. Cylinder		
Percent ¹ accuracy=		
Measured Conc. – Actual Conc.		
× 100		
Actual Conc.		
g. Problems detected (if any)		

¹Results of two consecutive injections that meet the sample analysis criteria of the test method.

[47 FR 39178, Sept. 7, 1982]

[↑ Back to Top](#)

Appendix D to Part 61—Methods for Estimating Radionuclide Emissions

1. Purpose and Background

Facility owners or operators may estimate radionuclide emissions to the atmosphere for dose calculations instead of measuring emissions. Particulate emissions from mill tailings piles should be estimated using the procedures listed in reference re #2. All other emissions may be estimated by using the "Procedures" listed below, or using the method described in reference #1.

2. Procedure

To estimate emissions to the atmosphere:

(a) Determine the amount (in curies) used at facilities for the period under consideration. Radioactive materials in sealed packages that remain unopened, and have not leaked during the assessment period should not be included in the calculation.

(b) Multiply the amount used by the following factors which depend on the physical state of the radionuclide. They are:

(i) 1 for gases;

(ii) 10^{-3} for liquids or particulate solids; and

(iii) 10^{-6} for solids.

If any nuclide is heated to a temperature of 100 degrees Celsius or more, boils at a temperature of 100 degrees Celsius or less, or is intentionally dispersed into the environment, it must be considered to be a gas.

(c) If a control device is installed between the place of use and the point of release, multiply emissions from (b) by an adjustment factor. These are presented in Table 1.

TABLE 1—ADJUSTMENT TO EMISSION FACTORS FOR EFFLUENT CONTROLS

Controls	Types of radionuclides controlled	Adjustment factor to emissions	Comments and conditions
HEPA filters	Particulates	0.01	Not applicable to gaseous radionuclides; periodic testing is prudent to ensure high removal efficiency.
Fabric filter	Particulates	0.1	Monitoring would be prudent to guard against tears in filter.
Sintered metal	Particulates	1	Insufficient data to make recommendation.
Activated carbon filters	Iodine gas	0.1	Efficiency is time dependent; monitoring is necessary to ensure effectiveness.

Douglas bags: Held one week or longer for decay	Xenon	0.5/wk	Based on xenon half-life of 5.3 days;
Douglas bags: Released within one week	Xenon	1	Provides no reduction of exposure to general public.
Venturi scrubbers	Particulates Gases	0.05 1	Although venturis may remove gases, variability in gaseous removal efficiency dictates adjustment factor for particulates only.
Packed bed scrubbers	Gases	0.1	Not applicable to particulates.
Electrostatic precipitators	Particulates	0.05	Not applicable for gaseous radionuclides
Xenon traps	Xenon	0.1	Efficiency is time dependent; monitoring is necessary to ensure effectiveness.
Fume hoods	All	1	Provides no reduction to general public exposures.
Vent stacks	All	1	Generally provides no reduction of exposure to general public.

References

(1) Environmental Protection Agency, "A Guide for Determining Compliance with the Clean Air Act Standards for Radionuclides Emissions from NRC-Licensed and Non-DOE Federal Facilities", EPA 520/1-89-002, January 1989.

(2) Nuclear Regulatory Commission, "Methods for Estimating Radioactive and Toxic Airborne Source Terms for Uranium Milling Operations", U.S. Nuclear Regulatory Commission Regulatory Guide 3.59, March 1987.

[54 FR 51711, Dec. 15, 1989]

[↑ Back to Top](#)

Appendix E to Part 61—Compliance Procedures Methods for Determining Compliance With Subpart I

1. Purpose and Background

This Appendix provides simplified procedures to reduce the burden on Nuclear Regulatory Commission (NRC) licensees, and non-Department of Energy Federal facilities in determining compliance with 40 CFR part 61, subpart I. The procedures consist of a series of increasingly more stringent steps, depending on the facility's potential to exceed the standard.

First, a facility can be found in compliance if the quantity of radioactive material possessed during the year is less than that listed in a table of annual possession quantities. A facility will also be in compliance if the average annual radionuclide emission concentration is less than that listed in a table of air concentration levels. If the facility is not in compliance by these tables, it can establish compliance by estimating a dose using screening procedure developed by the National Council on Radiation Protection and Measurements with a radiological source term derived using EPA approved emission factors. These procedures are described in a "Guide for Determining Compliance with the Clean Air Act Standards for Radionuclide Emissions From NRC-Licensed and Non-DOE Federal Facilities."

A user-friendly computer program called COMPLY has been developed to reduce the burden on the regulated community. The Agency has also prepared a "User's Guide for the COMPLY Code" to assist the regulated community in using the code, and in handling more complex situations such as multiple release points. The basis for these compliance procedures are provided in "Background Information Document: Procedures Approved for Demonstrating Compliance with 40 CFR Part 61, Subpart I". The compliance model is the highest level in the COMPLY computer code and provides for the most realistic assessment of dose by allowing the use of site-specific information.

2. Table of Annual Possession Quantity

(a) Table 1 may be used for determining if facilities are in compliance with the standard. The possession table can only be used if the following conditions are met:

- (i) No person lives within 10 meters of any release point; and
- (ii) No milk, meat, or vegetables are produced within 100 meters of any release point.

(b) Procedures described in Reference (1) shall be used to determine compliance or exemption from reporting by use of Table 2.

TABLE 1—ANNUAL POSSESSION QUANTITIES FOR ENVIRONMENTAL COMPLIANCE

[Annual Possession Quantities (Ci/yr)]

Radionuclide	Gaseous form*	Liquid/powder forms	Solid form*
Ac-225	9.6E-05	9.6E-02	9.6E + 01
Ac-227	1.6E-07	1.6E-04	1.6E-01
Ac-228	3.4E-03	3.4E + 00	3.4E + 03
Ag-106	1.6E + 00	1.6E + 03	1.6E + 06
Ag-106m	2.6E-03	2.6E + 00	2.6E + 03
Ag-108m	6.5E-06	6.5E-03	6.5E + 00
Ag-110m	9.4E-05	9.4E-02	9.4E + 01
Ag-111	6.7E-02	6.7E + 01	6.7E + 04
Al-26	4.0E-06	4.0E-03	4.0E + 00
Am-241	2.3E-06	2.3E-03	2.3E + 00

Am-242	1.8E-02	1.8E + 01	1.8E + 04
Am-242m	2.5E-06	2.5E-03	2.5E + 00
Am-243	2.3E-06	2.3E-03	2.3E + 00
Am-244	4.6E-02	4.6E + 01	4.6E + 04
Am-245	7.0E + 00	7.0E + 03	7.0E + 06
Am-246	9.8E-01	9.8E + 02	9.8E + 05
Ar-37	1.4E + 06		
Ar-41	1.4E + 00		
As-72	2.9E-02	2.9E + 01	2.9E + 04
As-73	6.0E-02	6.0E + 01	6.0E + 04
As-74	4.3E-03	4.3E + 00	4.3E + 03
As-76	8.8E-02	8.8E + 01	8.8E + 04
As-77	7.9E-01	7.9E + 02	7.9E + 05
At-211	1.0E-02	1.0E + 01	1.0E + 04
Au-193	4.2E-01	4.2E + 02	4.2E + 05
Au-194	3.5E-02	3.5E + 01	3.5E + 04
Au-195	3.3E-03	3.3E + 00	3.3E + 03
Au-198	4.6E-02	4.6E + 01	4.6E + 04
Au-199	1.5E-01	1.5E + 02	1.5E + 05
Ba-131	1.0E-02	1.0E + 01	1.0E + 04
Ba-133	4.9E-05	4.9E-02	4.9E + 01
Ba-133m	9.3E-02	9.3E + 01	9.3E + 04
Ba-135m	5.8E-01	5.8E + 02	5.8E + 05
Ba-139	4.7E + 00	4.7E + 03	4.7E + 06
Ba-140	2.1E-03	2.1E + 00	2.1E + 03
Ba-141	1.3E + 00	1.3E + 03	1.3E + 06
Ba-142	1.1E + 00	1.1E + 03	1.1E + 06
Be-7	2.3E-02	2.3E + 01	2.3E + 04
Be-10	3.0E-03	3.0E + 00	3.0E + 03
Bi-206	3.1E-03	3.1E + 00	3.1E + 03

Bi-207	8.4E-06	8.4E-03	8.4E + 00
Bi-210	4.2E-03	4.2E + 00	4.2E + 03
Bi-212	4.7E-02	4.7E + 01	4.7E + 04
Bi-213	6.0E-02	6.0E + 01	6.0E + 04
Bi-214	1.4E-01	1.4E + 02	1.4E + 05
Bk-249	7.0E-04	7.0E-01	7.0E + 02
Bk-250	1.0E-01	1.0E + 02	1.0E + 05
Br-77	7.5E-02	7.5E + 01	7.5E + 04
Br-80	1.2E + 01	1.2E + 04	1.2E + 07
Br-80m	1.5E + 00	1.5E + 03	1.5E + 06
Br-82	1.6E-02	1.6E + 01	1.6E + 04
Br-83	9.9E + 00	9.9E + 03	9.9E + 06
Br-84	5.6E-01	5.6E + 02	5.6E + 05
C-11	1.3E + 00	1.3E + 03	1.3E + 06
C-14	2.9E-01	2.9E + 02	2.9E + 05
Ca-41	2.7E-02	2.7E + 01	2.7E + 04
Ca-45	5.8E-02	5.8E + 01	5.8E + 04
Ca-47	1.1E-02	1.1E + 01	1.1E + 04
Cd-109	5.0E-03	5.0E + 00	5.0E + 03
Cd-113	3.3E-04	3.3E-01	3.3E + 02
Cd-113m	4.4E-04	4.4E-01	4.4E + 02
Cd-115	5.4E-02	5.4E + 01	5.4E + 04
Cd-115m	1.0E-02	1.0E + 01	1.0E + 04
Cd-117	5.6E-02	5.6E + 01	5.6E + 04
Cd-117m	1.3E-01	1.3E + 02	1.3E + 05
Ce-139	2.6E-03	2.6E + 00	2.6E + 03
Ce-141	1.8E-02	1.8E + 01	1.8E + 04
Ce-143	1.0E-01	1.0E + 02	1.0E + 05
Ce-144	1.7E-03	1.7E + 00	1.7E + 03
Cf-248	2.0E-05	2.0E-02	2.0E + 01

Cf-249	1.7E-06	1.7E-03	1.7E + 00
Cf-250	4.0E-06	4.0E-03	4.0E + 00
Cf-251	1.7E-06	1.7E-03	1.7E + 00
Cf-252	6.4E-06	6.4E-03	6.4E + 00
Cf-253	3.3E-04	3.3E-01	3.3E + 02
Cf-254	3.6E-06	3.6E-03	3.6E + 00
Cl-36	1.9E-04	1.9E-01	1.9E + 02
Cl-38	6.5E-01	6.5E + 02	6.5E + 05
Cm-242	6.0E-05	6.0E-02	6.0E + 01
Cm-243	3.3E-06	3.3E-03	3.3E + 00
Cm-244	4.2E-06	4.2E-03	4.2E + 00
Cm-245	2.3E-06	2.3E-03	2.3E + 00
Cm-246	2.3E-06	2.3E-03	2.3E + 00
Cm-247	2.3E-06	2.3E-03	2.3E + 00
Cm-248	6.4E-07	6.4E-04	6.4E-01
Cm-249	4.6E + 00	4.6E + 03	4.6E + 06
Cm-250	1.1E-07	1.1E-04	1.1E-01
Co-56	2.4E-04	2.4E-01	2.4E + 02
Co-57	1.6E-03	1.6E + 00	1.6E + 03
Co-58	9.0E-04	9.0E-01	9.0E + 02
Co-58m	1.7E-01	1.7E + 02	1.7E + 05
Co-60	1.6E-05	1.6E-02	1.6E + 01
Co-60m	4.0E + 00	4.0E + 03	4.0E + 06
Co-61	3.8E + 00	3.8E + 03	3.8E + 06
Cr-49	9.0E-01	9.0E + 02	9.0E + 05
Cr-51	6.3E-02	6.3E + 01	6.3E + 04
Cs-129	1.5E-01	1.5E + 02	1.5E + 05
Cs-131	2.8E-01	2.8E + 02	2.8E + 05
Cs-132	1.3E-02	1.3E + 01	1.3E + 04
Cs-134	5.2E-05	5.2E-02	5.2E + 01

Cs-134m	3.2E-01	3.2E + 02	3.2E + 05
Cs-135	2.4E-02	2.4E + 01	2.4E + 04
Cs-136	2.1E-03	2.1E + 00	2.1E + 03
Cs-137	2.3E-05	2.3E-02	2.3E + 01
Cs-138	4.4E-01	4.4E + 02	4.4E + 05
Cu-61	4.0E-01	4.0E + 02	4.0E + 05
Cu-64	5.2E-01	5.2E + 02	5.2E + 05
Cu-67	1.5E-01	1.5E + 02	1.5E + 05
Dy-157	4.4E-01	4.4E + 02	4.4E + 05
Dy-165	5.6E + 00	5.6E + 03	5.6E + 06
Dy-166	8.1E-02	8.1E + 01	8.1E + 04
Er-169	4.0E-01	4.0E + 02	4.0E + 05
Er-171	3.6E-01	3.6E + 02	3.6E + 05
Es-253	2.6E-04	2.6E-01	2.6E + 02
Es-254	2.3E-05	2.3E-02	2.3E + 01
Es-254m	1.8E-03	1.8E + 00	1.8E + 03
Eu-152	1.6E-05	1.6E-02	1.6E + 01
Eu-152m	3.5E-01	3.5E + 02	3.5E + 05
Eu-154	2.0E-05	2.0E-02	2.0E + 01
Eu-155	5.2E-04	5.2E-01	5.2E + 02
Eu-156	3.2E-03	3.2E + 00	3.2E + 03
F-18	5.6E-01	5.6E + 02	5.6E + 05
Fe-52	4.9E-02	4.9E + 01	4.9E + 04
Fe-55	1.4E-01	1.4E + 02	1.4E + 05
Fe-59	1.3E-03	1.3E + 00	1.3E + 03
Fm-254	1.8E-02	1.8E + 01	1.8E + 04
Fm-255	4.0E-03	4.0E + 00	4.0E + 03
Fr-223	1.4E-01	1.4E + 02	1.4E + 05
Ga-66	5.6E-02	5.6E + 01	5.6E + 04
Ga-67	1.1E-01	1.1E + 02	1.1E + 05

Ga-68	7.6E-01	7.6E + 02	7.6E + 05
Ga-72	3.6E-02	3.6E + 01	3.6E + 04
Gd-152	4.4E-06	4.4E-03	4.4E + 00
Gd-153	2.0E-03	2.0E + 00	2.0E + 03
Gd-159	6.8E-01	6.8E + 02	6.8E + 05
Ge-68	2.3E-04	2.3E-01	2.3E + 02
Ge-71	2.6E + 00	2.6E + 03	2.6E + 06
Ge-77	1.0E-01	1.0E + 02	1.0E + 05
H-3	1.5E + 01	1.5E + 04	1.5E + 07
Hf-181	2.5E-03	2.5E + 00	2.5E + 03
Hg-193m	9.5E-02	9.5E + 01	9.5E + 04
Hg-197	2.4E-01	2.4E + 02	2.4E + 05
Hg-197m	2.5E-01	2.5E + 02	2.5E + 05
Hg-203	5.2E-03	5.2E + 00	5.2E + 03
Ho-166	2.8E-01	2.8E + 02	2.8E + 05
Ho-166m	6.0E-06	6.0E-03	6.0E + 00
I-123	4.9E-01	4.9E + 02	4.9E + 05
I-124	9.3E-03	9.3E + 00	9.3E + 03
I-125	6.2E-03	6.2E + 00	6.2E + 03
I-126	3.7E-03	3.7E + 00	3.7E + 03
I-128	9.3E + 00	9.3E + 03	9.3E + 06
I-129	2.6E-04	2.6E-01	2.6E + 02
I-130	4.6E-02	4.6E + 01	4.6E + 04
I-131	6.7E-03	6.7E + 00	6.7E + 03
I-132	2.0E-01	2.0E + 02	2.0E + 05
I-133	6.7E-02	6.7E + 01	6.7E + 04
I-134	3.2E-01	3.2E + 02	3.2E + 05
I-135	1.2E-01	1.2E + 02	1.2E + 05
In-111	4.9E-02	4.9E + 01	4.9E + 04
In-113m	2.1E + 00	2.1E + 03	2.1E + 06

In-114m	4.9E-03	4.9E + 00	4.9E + 03
In-115	2.7E-04	2.7E-01	2.7E + 02
In-115m	1.4E + 00	1.4E + 03	1.4E + 06
In-116m	3.5E-01	3.5E + 02	3.5E + 05
In-117	1.3E + 00	1.3E + 03	1.3E + 06
In-117m	7.6E-02	7.6E + 01	7.6E + 04
Ir-190	3.5E-03	3.5E + 00	3.5E + 03
Ir-192	9.7E-04	9.7E-01	9.7E + 02
Ir-194	2.5E-01	2.5E + 02	2.5E + 05
Ir-194m	1.5E-04	1.5E-01	1.5E + 02
K-40	6.8E-05	6.8E-02	6.8E + 01
K-42	2.9E-01	2.9E + 02	2.9E + 05
K-43	6.0E-02	6.0E + 01	6.0E + 04
K-44	4.9E-01	4.9E + 02	4.9E + 05
Kr-79	7.0E + 00		
Kr-81	1.8E + 02		
Kr-83m	2.0E + 04		
Kr-85	8.4E + 02		
Kr-85m	1.1E + 01		
Kr-87	2.0E + 00		
Kr-88	4.2E-01		
La-140	1.6E-02	1.6E + 01	1.6E + 04
La-141	1.1E + 00	1.1E + 03	1.1E + 06
La-142	2.3E-01	2.3E + 02	2.3E + 05
Lu-177	1.4E-01	1.4E + 02	1.4E + 05
Lu-177m	3.5E-04	3.5E-01	3.5E + 02
Mg-28	2.1E-02	2.1E + 01	2.1E + 04
Mn-52	3.5E-03	3.5E + 00	3.5E + 03
Mn-52m	5.2E-01	5.2E + 02	5.2E + 05
Mn-53	5.7E-02	5.7E + 01	5.7E + 04

Mn-54	2.5E-04	2.5E-01	2.5E + 02
Mn-56	2.5E-01	2.5E + 02	2.5E + 05
Mo-93	1.5E-03	1.5E + 00	1.5E + 03
Mo-99**	5.7E-02	5.7E + 01	5.7E + 04
Mo-101	8.4E-01	8.4E + 02	8.4E + 05
Na-22	3.2E-05	3.2E-02	3.2E + 01
Na-24	2.6E-02	2.6E + 01	2.6E + 04
Nb-90	2.5E-02	2.5E + 01	2.5E + 04
Nb-93m	1.2E-02	1.2E + 01	1.2E + 04
Nb-94	6.0E-06	6.0E-03	6.0E + 00
Nb-95	2.3E-03	2.3E + 00	2.3E + 03
Nb-95m	2.0E-02	2.0E + 01	2.0E + 04
Nb-96	2.5E-02	2.5E + 01	2.5E + 04
Nb-97	1.0E + 00	1.0E + 03	1.0E + 06
Nd-147	3.0E-02	3.0E + 01	3.0E + 04
Nd-149	1.1E + 00	1.1E + 03	1.1E + 06
Ni-56	2.0E-03	2.0E + 00	2.0E + 03
Ni-57	2.1E-02	2.1E + 01	2.1E + 04
Ni-59	2.2E-02	2.2E + 01	2.2E + 04
Ni-63	1.4E-01	1.4E + 02	1.4E + 05
Ni-65	7.0E-01	7.0E + 02	7.0E + 05
Np-235	3.0E-02	3.0E + 01	3.0E + 04
Np-237	1.8E-06	1.8E-03	1.8E + 00
Np-238	1.9E-02	1.9E + 01	1.9E + 04
Np-239	1.0E-01	1.0E + 02	1.0E + 05
Np-240	6.5E-01	6.5E + 02	6.5E + 05
Np-240m	4.7E + 00	4.7E + 03	4.7E + 06
Os-185	9.2E-04	9.2E-01	9.2E + 02
Os-191m	9.0E-01	9.0E + 02	9.0E + 05
Os-191	3.8E-02	3.8E + 01	3.8E + 04

Os-193	2.9E-01	2.9E + 02	2.9E + 05
P-32	1.7E-02	1.7E + 01	1.7E + 04
P-33	1.2E-01	1.2E + 02	1.2E + 05
Pa-230	6.3E-04	6.3E-01	6.3E + 02
Pa-231	8.3E-07	8.3E-04	8.3E-01
Pa-233	9.3E-03	9.3E + 00	9.3E + 03
Pa-234	9.3E-02	9.3E + 01	9.3E + 04
Pb-203	8.3E-02	8.3E + 01	8.3E + 04
Pb-205	1.2E-02	1.2E + 01	1.2E + 04
Pb-209	1.1E + 01	1.1E + 04	1.1E + 07
Pb-210	5.5E-05	5.5E-02	5.5E + 01
Pb-211	1.2E-01	1.2E + 02	1.2E + 05
Pb-212	6.0E-03	6.0E + 00	6.0E + 03
Pb-214	1.2E-01	1.2E + 02	1.2E + 05
Pd-103	2.1E-01	2.1E + 02	2.1E + 05
Pd-107	8.2E-02	8.2E + 01	8.2E + 04
Pd-109	9.4E-01	9.4E + 02	9.4E + 05
Pm-143	7.6E-04	7.6E-01	7.6E + 02
Pm-144	1.1E-04	1.1E-01	1.1E + 02
Pm-145	5.2E-04	5.2E-01	5.2E + 02
Pm-146	4.4E-05	4.4E-02	4.4E + 01
Pm-147	2.6E-02	2.6E + 01	2.6E + 04
Pm-148	1.7E-02	1.7E + 01	1.7E + 04
Pm-148m	7.6E-04	7.6E-01	7.6E + 02
Pm-149	2.8E-01	2.8E + 02	2.8E + 05
Pm-151	1.2E-01	1.2E + 02	1.2E + 05
Po-210	9.3E-05	9.3E-02	9.3E + 01
Pr-142	2.8E-01	2.8E + 02	2.8E + 05
Pr-143	1.0E-01	1.0E + 02	1.0E + 05
Pr-144	1.5E + 01	1.5E + 04	1.5E + 07

Pt-191	6.4E-02	6.4E + 01	6.4E + 04
Pt-193	2.1E-02	2.1E + 01	2.1E + 04
Pt-193m	4.8E-01	4.8E + 02	4.8E + 05
Pt-195m	1.4E-01	1.4E + 02	1.4E + 05
Pt-197	1.1E + 00	1.1E + 03	1.1E + 06
Pt-197m	3.6E + 00	3.6E + 03	3.6E + 06
Pu-236	7.0E-06	7.0E-03	7.0E + 00
Pu-237	2.3E-02	2.3E + 01	2.3E + 04
Pu-238	2.7E-06	2.7E-03	2.7E + 00
Pu-239	2.5E-06	2.5E-03	2.5E + 00
Pu-240	2.5E-06	2.5E-03	2.5E + 00
Pu-241	1.3E-04	1.3E-01	1.3E + 02
Pu-242	2.5E-06	2.5E-03	2.5E + 00
Pu-243	3.8E + 00	3.8E + 03	3.8E + 06
Pu-244	2.4E-06	2.4E-03	2.4E + 00
Pu-245	2.1E-01	2.1E + 02	2.1E + 05
Pu-246	4.8E-03	4.8E + 00	4.8E + 03
Ra-223	1.3E-04	1.3E-01	1.3E + 02
Ra-224	3.2E-04	3.2E-01	3.2E + 02
Ra-225	1.3E-04	1.3E-01	1.3E + 02
Ra-226	5.5E-06	5.5E-03	5.5E + 00
Ra-228	1.3E-05	1.3E-02	1.3E + 01
Rb-81	4.2E-01	4.2E + 02	4.2E + 05
Rb-83	1.4E-03	1.4E + 00	1.4E + 03
Rb-84	2.0E-03	2.0E + 00	2.0E + 03
Rb-86	1.7E-02	1.7E + 01	1.7E + 04
Rb-87	1.0E-02	1.0E + 01	1.0E + 04
Rb-88	1.7E + 00	1.7E + 03	1.7E + 06
Rb-89	6.4E-01	6.4E + 02	6.4E + 05
Re-184	1.8E-03	1.8E + 00	1.8E + 03

Re-184m	3.6E-04	3.6E-01	3.6E + 02
Re-186	1.9E-01	1.9E + 02	1.9E + 05
Re-187	9.3E + 00	9.3E + 03	9.3E + 06
Re-188	3.7E-01	3.7E + 02	3.7E + 05
Rh-103m	1.7E + 02	1.7E + 05	1.7E + 08
Rh-105	3.4E-01	3.4E + 02	3.4E + 05
Ru-97	8.3E-02	8.3E + 01	8.3E + 04
Ru-103	3.1E-03	3.1E + 00	3.1E + 03
Ru-105	2.9E-01	2.9E + 02	2.9E + 05
Ru-106	5.9E-04	5.9E-01	5.9E + 02
S-35	7.5E-02	7.5E + 01	7.5E + 04
Sb-117	2.0E + 00	2.0E + 03	2.0E + 06
Sb-122	3.9E-02	3.9E + 01	3.9E + 04
Sb-124	6.0E-04	6.0E-01	6.0E + 02
Sb-125	1.4E-04	1.4E-01	1.4E + 02
Sb-126	1.8E-03	1.8E + 00	1.8E + 03
Sb-126m	7.6E-01	7.6E + 02	7.6E + 05
Sb-127	2.0E-02	2.0E + 01	2.0E + 04
Sb-129	1.8E-01	1.8E + 02	1.8E + 05
Sc-44	1.4E-01	1.4E + 02	1.4E + 05
Sc-46	4.0E-04	4.0E-01	4.0E + 02
Sc-47	1.1E-01	1.1E + 02	1.1E + 05
Sc-48	1.1E-02	1.1E + 01	1.1E + 04
Sc-49	1.0E + 01	1.0E + 04	1.0E + 07
Se-73	1.6E-01	1.6E + 02	1.6E + 05
Se-75	1.1E-03	1.1E + 00	1.1E + 03
Se-79	6.9E-03	6.9E + 00	6.9E + 03
Si-31	4.7E + 00	4.7E + 03	4.7E + 06
Si-32	7.2E-04	7.2E-01	7.2E + 02
Sm-147	1.4E-05	1.4E-02	1.4E + 01

Sm-151	3.5E-02	3.5E + 01	3.5E + 04
Sm-153	2.4E-01	2.4E + 02	2.4E + 05
Sn-113	1.9E-03	1.9E + 00	1.9E + 03
Sn-117m	2.3E-02	2.3E + 01	2.3E + 04
Sn-119m	2.8E-02	2.8E + 01	2.8E + 04
Sn-123	1.8E-02	1.8E + 01	1.8E + 04
Sn-125	7.2E-03	7.2E + 00	7.2E + 03
Sn-126	4.7E-06	4.7E-03	4.7E + 00
Sr-82	1.9E-03	1.9E + 00	1.9E + 03
Sr-85	1.9E-03	1.9E + 00	1.9E + 03
Sr-85m	1.5E + 00	1.5E + 03	1.5E + 06
Sr-87m	1.2E + 00	1.2E + 03	1.2E + 06
Sr-89	2.1E-02	2.1E + 01	2.1E + 04
Sr-90	5.2E-04	5.2E-01	5.2E + 02
Sr-91	1.2E-01	1.2E + 02	1.2E + 05
Sr-92	2.5E-01	2.5E + 02	2.5E + 05
Ta-182	4.4E-04	4.4E-01	4.4E + 02
Tb-157	2.2E-03	2.2E + 00	2.2E + 03
Tb-160	8.4E-04	8.4E-01	8.4E + 02
Tc-95	9.0E-02	9.0E + 01	9.0E + 04
Tc-95m	1.4E-03	1.4E + 00	1.4E + 03
Tc-96	5.6E-03	5.6E + 00	5.6E + 03
Tc-96m	7.0E-01	7.0E + 02	7.0E + 05
Tc-97	1.5E-03	1.5E + 00	1.5E + 03
Tc-97m	7.2E-02	7.2E + 01	7.2E + 04
Tc-98	6.4E-06	6.4E-03	6.4E + 00
Tc-99	9.0E-03	9.0E + 00	9.0E + 03
Tc-99m	1.4E + 00	1.4E + 03	1.4E + 06
Tc-101	3.8E + 00	3.8E + 03	3.8E + 06
Te-121	6.0E-03	6.0E + 00	6.0E + 03

Te-121m	5.3E-04	5.3E-01	5.3E + 02
Te-123	1.2E-03	1.2E + 00	1.2E + 03
Te-123m	2.7E-03	2.7E + 00	2.7E + 03
Te-125m	1.5E-02	1.5E + 01	1.5E + 04
Te-127	2.9E + 00	2.9E + 03	2.9E + 06
Te-127m	7.3E-03	7.3E + 00	7.3E + 03
Te-129	6.5E + 00	6.5E + 03	6.5E + 06
Te-129m	6.1E-03	6.1E + 00	6.1E + 03
Te-131	9.4E-01	9.4E + 02	9.4E + 05
Te-131m	1.8E-02	1.8E + 01	1.8E + 04
Te-132	6.2E-03	6.2E + 00	6.2E + 03
Te-133	1.2E + 00	1.2E + 03	1.2E + 06
Te-133m	2.9E-01	2.9E + 02	2.9E + 05
Te-134	4.4E-01	4.4E + 02	4.4E + 05
Th-226	3.0E-02	3.0E + 01	3.0E + 04
Th-227	6.4E-05	6.4E-02	6.4E + 01
Th-228	2.9E-06	2.9E-03	2.9E + 00
Th-229	4.9E-07	4.9E-04	4.9E-01
Th-230	3.2E-06	3.2E-03	3.2E + 00
Th-231	8.4E-01	8.4E + 02	8.4E + 05
Th-232	6.0E-07	6.0E-04	6.0E-01
Th-234	2.0E-02	2.0E + 01	2.0E + 04
Ti-44	5.2E-06	5.2E-03	5.2E + 00
Ti-45	4.0E-01	4.0E + 02	4.0E + 05
Tl-200	4.4E-02	4.4E + 01	4.4E + 04
Tl-201	1.8E-01	1.8E + 02	1.8E + 05
Tl-202	1.0E-02	1.0E + 01	1.0E + 04
Tl-204	2.5E-02	2.5E + 01	2.5E + 04
Tm-170	2.4E-02	2.4E + 01	2.4E + 04
Tm-171	5.9E-02	5.9E + 01	5.9E + 04

U-230	5.0E-05	5.0E-02	5.0E + 01
U-231	1.4E-01	1.4E + 02	1.4E + 05
U-232	1.3E-06	1.3E-03	1.3E + 00
U-233	7.6E-06	7.6E-03	7.6E + 00
U-234	7.6E-06	7.6E-03	7.6E + 00
U-235	7.0E-06	7.0E-03	7.0E + 00
U-236	8.4E-06	8.4E-03	8.4E + 00
U-237	4.7E-02	4.7E + 01	4.7E + 04
U-238	8.6E-06	8.6E-03	8.6E + 00
U-239	8.3E + 00	8.3E + 03	8.3E + 06
U-240	1.8E-01	1.8E + 02	1.8E + 05
V-48	1.4E-03	1.4E + 00	1.4E + 03
V-49	1.3E + 00	1.3E + 03	1.3E + 06
W-181	1.1E-02	1.1E + 01	1.1E + 04
W-185	1.6E-01	1.6E + 02	1.6E + 05
W-187	1.1E-01	1.1E + 02	1.1E + 05
W-188	1.0E-02	1.0E + 01	1.0E + 04
Xe-122	7.6E-02	7.6E + 01	7.6E + 04
Xe-123	1.6E + 00	1.6E + 03	1.6E + 06
Xe-125	6.0E-01		
Xe-127	7.0E + 00		
Xe-129m	7.6E + 01		
Xe-131m	2.2E + 02		
Xe-133	5.2E + 01		
Xe-133m	6.0E + 01		
Xe-135	7.6E + 00		
Xe-135m	4.2E + 00		
Xe-138	9.9E-01		
Y-86	2.8E-02	2.8E + 01	2.8E + 04
Y-87	2.3E-02	2.3E + 01	2.3E + 04

Y-88	2.5E-04	2.5E-01	2.5E + 02
Y-90	1.1E-01	1.1E + 02	1.1E + 05
Y-90m	4.3E-01	4.3E + 02	4.3E + 05
Y-91	1.8E-02	1.8E + 01	1.8E + 04
Y-91m	1.6E + 00	1.6E + 03	1.6E + 06
Y-92	7.0E-01	7.0E + 02	7.0E + 05
Y-93	3.8E-01	3.8E + 02	3.8E + 05
Yb-169	5.5E-03	5.5E + 00	5.5E + 03
Yb-175	2.1E-01	2.1E + 02	2.1E + 05
Zn-62	8.6E-02	8.6E + 01	8.6E + 04
Zn-65	4.4E-04	4.4E-01	4.4E + 02
Zn-69	2.7E + 01	2.7E + 04	2.7E + 07
Zn-69m	2.0E-01	2.0E + 02	2.0E + 05
Zr-86	2.4E-02	2.4E + 01	2.4E + 04
Zr-88	2.7E-04	2.7E-01	2.7E + 02
Zr-89	1.6E-02	1.6E + 01	1.6E + 04
Zr-93	2.8E-03	2.8E + 00	2.8E + 03
Zr-95	6.4E-04	6.4E-01	6.4E + 02
Zr-97	4.6E-02	4.6E + 01	4.6E + 04

*Radionuclides boiling at 100 °C or less, or exposed to a temperature of 100 °C, must be considered a gas. Capsules containing radionuclides in liquid or powder form can be considered to be solids.

**Mo-99 contained in a generator to produce Technetium-99 can be assumed to be a solid.

3. Table of Concentration Levels

(a) Table 2 may be used for determining if facilities are in compliance with the standard.

1. The concentration table as applied to emission estimates can only be used if all releases are from point sources and concentrations have been measured at the stack or vent using EPA-approved methods, and the distance between each stack or vent and the nearest resident is greater than 3 times the diameter of the stack or vent. Procedures provided in Ref. (1) shall be used to determine compliance or exemption from reporting by use of Table 2.

2. The concentration table may be used to determine compliance with the standard based on environmental measurements provided these measurements are made in conformance with the requirements of §61.107(b)(5).

4. NCRP Screening Model

The procedures described in Reference (4) may be used to determine doses to members of the general public from emissions of radionuclides to the atmosphere. Both the total dose from all radionuclides emitted, and the dose caused by radioactive iodine must be considered in accordance with the procedures in Ref. (1).

5. The COMPLY Computer Code

The COMPLY computer code may be used to determine compliance with subpart I. The compliance model in the COMPLY computer code may be used to determine the dose to members of the general public from emissions of radionuclides to the atmosphere. The EPA may add radionuclides to all or any part of COMPLY to cover radionuclides that may be used by the regulated community.

TABLE 2—CONCENTRATION LEVELS FOR ENVIRONMENTAL COMPLIANCE

Radionuclide	Concentration (Ci/m³)	Radionuclide	Concentration (Ci/m³)
Ac-225	9.1E-14	Bi-207	1.0E-14
Ac-227	1.6E-16	Bi-210	2.9E-13
Ac-228	3.7E-12	Bi-212	5.6E-11
Ag-106	1.9E-09	Bi-213	7.1E-11
Ag-106m	1.2E-12	Bi-214	1.4E-10
Ag-108m	7.1E-15	Bk-249	5.6E-13
Ag-110m	9.1E-14	Bk-250	9.1E-11
Ag-111	2.5E-12	Br-77	4.2E-11
Al-26	4.8E-15	Br-80	1.4E-08
Am-241	1.9E-15	Br-80m	1.8E-09
Am-242	1.5E-11	Br-82	1.2E-11
Am-242m	2.0E-15	Br-83	1.2E-08
Am-243	1.8E-15	Br-84	6.7E-10
Am-244	4.0E-11	C-11	1.5E-09
Am-245	8.3E-09	C-14	1.0E-11
Am-246	1.2E-09	Ca-41	4.2E-13
Ar-37	1.6E-03	Ca-45	1.3E-12
Ar-41	1.7E-09	Ca-47	2.4E-12
As-72	2.4E-11	Cd-109	5.9E-13
As-73	1.1E-11	Cd-113	9.1E-15

As-74	2.2E-12	Cd-113m	1.7E-14
As-76	5.0E-11	Cd-115	1.6E-11
As-77	1.6E-10	Cd-115m	8.3E-13
At-211	1.1E-11	Cd-117	6.7E-11
Au-193	3.8E-10	Cd-117m	1.6E-10
Au-194	3.2E-11	Ce-139	2.6E-12
Au-195	3.1E-12	Ce-141	6.3E-12
Au-198	2.1E-11	Ce-143	3.0E-11
Au-199	4.8E-11	Ce-144	6.2E-13
Ba-131	7.1E-12	Cf-248	1.8E-14
Ba-133	5.9E-14	Cf-249	1.4E-15
Ba-133m	5.9E-11	Cf-250	3.2E-15
Ba-135m	1.8E-10	Cf-251	1.4E-15
Ba-139	5.6E-09	Cf-252	5.6E-15
Ba-140	1.3E-12	Cf-253	3.1E-13
Ba-141	1.4E-09	Cf-254	3.0E-15
Ba-142	1.3E-09	Cl-36	2.7E-15
Be-7	2.3E-11	Cl-38	7.7E-10
Be-10	1.6E-12	Cm-242	5.3E-14
Bi-206	2.3E-12	Cm-243	2.6E-15
Cm-244	3.3E-15	Eu-156	1.9E-12
Cm-245	1.8E-15	F-18	6.7E-10
Cm-246	1.9E-15	Fe-52	5.6E-11
Cm-247	1.9E-15	Fe-55	9.1E-12
Cm-248	5.0E-16	Fe-59	6.7E-13
Cm-249	3.7E-09	Fm-254	2.0E-11
Cm-250	9.1E-17	Fm-255	4.3E-12
Co-56	1.8E-13	Fr-223	3.3E-11
Co-57	1.3E-12	Ga-66	6.2E-11
Co-58	6.7E-13	Ga-67	7.1E-11

Co-58m	1.2E-10	Ga-68	9.1E-10
Co-60	1.7E-14	Ga-72	3.8E-11
Co-60m	4.3E-09	Gd-152	5.0E-15
Co-61	4.5E-09	Gd-153	2.1E-12
Cr-49	1.1E-09	Gd-159	2.9E-10
Cr-51	3.1E-11	Ge-68	2.0E-13
Cs-129	1.4E-10	Ge-71	2.4E-10
Cs-131	3.3E-11	Ge-77	1.0E-10
Cs-132	4.8E-12	H-3	1.5E-09
Cs-134	2.7E-14	Hf-181	1.9E-12
Cs-134m	1.7E-10	Hg-193m	1.0E-10
Cs-135	4.0E-13	Hg-197	8.3E-11
Cs-136	5.3E-13	Hg-197m	1.1E-10
Cs-137	1.9E-14	Hg-203	1.0E-12
Cs-138	5.3E-10	Ho-166	7.1E-11
Cu-61	4.8E-10	Ho-166m	7.1E-15
Cu-64	5.3E-10	I-123	4.3E-10
Cu-67	5.0E-11	I-124	6.2E-13
Dy-157	5.0E-10	I-125	1.2E-13
Dy-165	6.7E-09	I-126	1.1E-13
Dy-166	1.1E-11	I-128	1.1E-08
Er-169	2.9E-11	I-129	9.1E-15
Er-171	4.0E-10	I-130	4.5E-11
Es-253	2.4E-13	I-131	2.1E-13
Es-254	2.0E-14	I-132	2.3E-10
Es-254m	1.8E-12	I-133	2.0E-11
Eu-152	2.0E-14	I-134	3.8E-10
Eu-152m	3.6E-10	I-135	1.2E-10
Eu-154	2.3E-14	In-111	3.6E-11
Eu-155	5.9E-13	In-113m	2.5E-09

In-114m	9.1E-13	Nb-95	2.2E-12
In-115	7.1E-14	Nb-95m	1.4E-11
In-115m	1.6E-09	Nb-96	2.4E-11
In-116m	4.2E-10	Nb-97	1.2E-09
In-117	1.6E-09	Nd-147	7.7E-12
In-117m	9.1E-11	Nd-149	7.1E-10
Ir-190	2.6E-12	Ni-56	1.7E-12
Ir-192	9.1E-13	Ni-57	1.8E-11
Ir-194	1.1E-10	Ni-59	1.5E-11
Ir-194m	1.7E-13	Ni-63	1.4E-11
K-40	2.7E-14	Ni-65	8.3E-10
K-42	2.6E-10	Np-235	2.5E-11
K-43	6.2E-11	Np-237	1.2E-15
K-44	5.9E-10	Np-238	1.4E-11
Kr-79	8.3E-09	Np-239	3.8E-11
Kr-81	2.1E-07	Np-240	7.7E-10
Kr-83m	2.3E-05	Np-240m	5.6E-09
Kr-85	1.0E-06	Os-185	1.0E-12
Kr-85m	1.3E-08	Os-191m	2.9E-10
Kr-87	2.4E-09	Os-191	1.1E-11
Kr-88	5.0E-10	Os-193	9.1E-11
La-140	1.2E-11	P-32	3.3E-13
La-141	7.7E-10	P-33	2.4E-12
La-142	2.7E-10	Pa-230	3.2E-13
Lu-177	2.4E-11	Pa-231	5.9E-16
Lu-177m	3.6E-13	Pa-233	4.8E-12
Mg-28	1.5E-11	Pa-234	1.1E-10
Mn-52	2.8E-12	Pb-203	6.2E-11
Mn-52m	6.2E-10	Pb-205	5.6E-12
Mn-53	1.5E-11	Pb-209	1.3E-08

Mn-54	2.8E-13	Pb-210	2.8E-15
Mn-56	2.9E-10	Pb-211	1.4E-10
Mo-93	1.1E-12	Pb-212	6.3E-12
Mo-99	1.4E-11	Pb-214	1.2E-10
Mo-101	1.0E-09	Pd-103	3.8E-11
Na-22	2.6E-14	Pd-107	3.1E-11
Na-24	2.6E-11	Pd-109	4.8E-10
Nb-90	2.6E-11	Pm-143	9.1E-13
Nb-93m	1.0E-11	Pm-144	1.3E-13
Nb-94	7.1E-15	Pm-145	6.2E-13
Pm-146	5.3E-14	Re-184m	3.7E-13
Pm-147	1.1E-11	Re-186	1.8E-11
Pm-148	5.0E-12	Re-187	2.6E-10
Pm-148m	6.7E-13	Re-188	1.7E-10
Pm-149	4.2E-11	Rh-103m	2.1E-07
Pm-151	7.1E-11	Rh-105	1.3E-10
Po-210	7.1E-15	Ru-97	6.7E-11
Pr-142	1.1E-10	Ru-103	2.6E-12
Pr-143	7.1E-12	Ru-105	2.8E-10
Pr-144	1.8E-08	Ru-106	3.4E-13
Pt-191	4.3E-11	S-35	1.3E-12
Pt-193	1.8E-11	Sb-117	2.4E-09
Pt-193m	4.8E-11	Sb-122	1.4E-11
Pt-195m	3.2E-11	Sb-124	5.3E-13
Pt-197	4.0E-10	Sb-125	1.6E-13
Pt-197m	2.6E-09	Sb-126	1.4E-12
Pu-236	5.9E-15	Sb-126m	9.1E-10
Pu-237	1.9E-11	Sb-127	7.1E-12
Pu-238	2.1E-15	Sb-129	7.7E-11
Pu-239	2.0E-15	Sc-44	1.7E-10

Pu-240	2.0E-15	Sc-46	4.2E-13
Pu-241	1.0E-13	Sc-47	3.8E-11
Pu-242	2.0E-15	Sc-48	9.1E-12
Pu-243	4.2E-09	Sc-49	1.2E-08
Pu-244	2.0E-15	Se-73	1.7E-10
Pu-245	2.1E-10	Se-75	1.7E-13
Pu-246	2.2E-12	Se-79	1.1E-13
Ra-223	4.2E-14	Si-31	5.6E-09
Ra-224	1.5E-13	Si-32	3.4E-14
Ra-225	5.0E-14	Sm-147	1.4E-14
Ra-226	3.3E-15	Sm-151	2.1E-11
Ra-228	5.9E-15	Sm-153	5.9E-11
Rb-81	5.0E-10	Sn-113	1.4E-12
Rb-83	3.4E-13	Sn-117m	5.6E-12
Rb-84	3.6E-13	Sn-119m	5.3E-12
Rb-86	5.6E-13	Sn-123	1.1E-12
Rb-87	1.6E-13	Sn-125	1.7E-12
Rb-88	2.1E-09	Sn-126	5.3E-15
Rb-89	7.1E-10	Sr-82	6.2E-13
Re-184	1.5E-12	Sr-85	1.8E-12
Sr-85m	1.6E-09	Th-232	6.2E-16
Sr-87m	1.4E-09	Th-234	2.2E-12
Sr-89	1.8E-12	Ti-44	6.2E-15
Sr-90	1.9E-14	Ti-45	4.8E-10
Sr-91	9.1E-11	Tl-200	4.5E-11
Sr-92	2.9E-10	Tl-201	1.0E-10
Ta-182	4.5E-13	Tl-202	5.0E-12
Tb-157	2.5E-12	Tl-204	1.2E-12
Tb-160	7.7E-13	Tm-170	3.3E-12
Tc-95	1.0E-10	Tm-171	2.6E-11

Tc-95m	1.4E-12	U-230	1.5E-14
Tc-96	5.6E-12	U-231	4.2E-11
Tc-96m	6.7E-10	U-232	1.3E-15
Tc-97	7.1E-13	U-233	7.1E-15
Tc-97m	7.1E-12	U-234	7.7E-15
Tc-98	6.7E-15	U-235	7.1E-15
Tc-99	1.4E-13	U-236	7.7E-15
Tc-99m	1.7E-09	U-237	1.0E-11
Tc-101	4.5E-09	U-238	8.3E-15
Te-121	1.0E-12	U-239	4.3E-09
Te-121m	1.2E-13	U-240	1.3E-10
Te-123	1.4E-13	V-48	1.0E-12
Te-123m	2.0E-13	V-49	1.6E-10
Te-125m	3.6E-13	W-181	6.7E-12
Te-127	1.0E-09	W-185	2.6E-12
Te-127m	1.5E-13	W-187	7.7E-11
Te-129	7.7E-09	W-188	5.3E-13
Te-129m	1.4E-13	Xe-122	9.1E-11
Te-131	9.1E-11	Xe-123	1.6E-09
Te-131m	1.0E-12	Xe-125	1.1E-11
Te-132	7.1E-13	Xe-127	8.3E-09
Te-133	9.1E-10	Xe-129m	9.1E-08
Te-133m	2.2E-10	Xe-131m	2.6E-07
Te-134	5.3E-10	Xe-133	6.2E-08
Th-226	3.4E-11	Xe-133m	7.1E-08
Th-227	3.8E-14	Xe-135	9.1E-09
Th-228	3.1E-15	Xe-135m	5.0E-09
Th-229	5.3E-16	Xe-138	1.2E-09
Th-230	3.4E-15	Y-86	3.0E-11
Th-231	2.9E-10	Y-87	1.7E-11

Y-88	2.7E-13	Zn-65	9.1E-14
Y-90	1.3E-11	Zn-69	3.2E-08
Y-90m	1.9E-10	Zn-69m	1.7E-10
Y-91	2.1E-12	Zr-86	2.4E-11
Y-91m	1.3E-09	Zr-88	3.1E-13
Y-92	8.3E-10	Zr-89	1.3E-11
Y-93	2.9E-10	Zr-93	2.6E-12
Yb-169	3.7E-12	Zr-95	6.7E-13
Yb-175	4.3E-11	Zr-97	3.8E-11
Zn-62	9.1E-11		

6. References

(1) Environmental Protection Agency, "A Guide for Determining Compliance with the Clean Air Act Standards for Radionuclides Emissions from NRC-Licensed and Non-DOE Federal Facilities", EPA 520/1-89-002, October 1989.

(2) Environmental Protection Agency, "User's Guide for the COMPLY Code", EPA 520/1-89-003, October 1989.

(3) Environmental Protection Agency, "Background Information Document: Procedures Approved for Demonstrating Compliance with 40 CFR Part 61, Subpart I", EPA 520/1-89-001, January 1989.

(4) National Council on Radiation Protection and Measurement, "Screening Techniques for Determining Compliance with Environmental Standards" NCRP Commentary No. 3, Revision of January 1989 with addendum of October, 1989.

[54 FR 51711, Dec. 15, 1989]

 [Back to Top](#)

Appendix K

Subpart DD—National Emission Standards for Hazardous Air Pollutants from Off-Site Waste and Recovery Operations

Contents

[§63.680 Applicability and designation of affected sources.](#)

[§63.681 Definitions.](#)

[§63.682 \[Reserved\]](#)

[§63.683 Standards: General.](#)

[§63.684 Standards: Off-site material treatment.](#)

[§63.685 Standards: Tanks.](#)

[§63.686 Standards: Oil-water and organic-water separators.](#)

[§63.687 Standards: Surface impoundments.](#)

[§63.688 Standards: Containers.](#)

[§63.689 Standards: Transfer systems.](#)

[§63.690 Standards: Process vents.](#)

[§63.691 Standards: Equipment leaks.](#)

[§63.692 \[Reserved\]](#)

[§63.693 Standards: Closed-vent systems and control devices.](#)

[§63.694 Testing methods and procedures.](#)

[§63.695 Inspection and monitoring requirements.](#)

[§63.696 Recordkeeping requirements.](#)

[§63.697 Reporting requirements.](#)

[§63.698 Implementation and enforcement.](#)

[Table 1 to Subpart DD of Part 63—List of Hazardous Air Pollutants \(HAP\) for Subpart DD](#)

[Table 2 to Subpart DD of Part 63—Applicability of Paragraphs in Subpart A of This Part 63—General Provisions to Subpart DD](#)

[Table 3 to Subpart DD of Part 63—Tank Control Levels for Tanks at Existing Affected Sources as Required by 40 CFR 63.685\(b\)\(1\)](#)

[Table 4 to Subpart DD of Part 63—Tank Control Levels for Tanks at Existing Affected Sources as Required by 40 CFR 63.685\(b\)\(1\)\(ii\)](#)

[Table 5 to Subpart DD of Part 63—Tank Control Levels for Tanks at New Affected Sources as Required by 40 CFR 63.685\(b\)\(2\)](#)

SOURCE: 61 FR 34158, July 1, 1996, unless otherwise noted.

[↑ Back to Top](#)

§63.680 Applicability and designation of affected sources.

(a) The provisions of this subpart apply to the owner and operator of a plant site for which both of the conditions specified in paragraphs (a)(1) and (a)(2) of this section are applicable. If either one of these conditions does not apply to the plant site, then the owner and operator of the plant site are not subject to the provisions of this subpart.

(1) The plant site is a major source of hazardous air pollutant (HAP) emissions as defined in 40 CFR 63.2.

(2) At the plant site is located one or more of operations that receives off-site materials as specified in paragraph (b) of this section and the operations is one of the following waste management operations or recovery operations as specified in paragraphs (a)(2)(i) through (a)(2)(vi) of this section.

(i) A waste management operation that receives off-site material and the operation is regulated as a hazardous waste treatment, storage, and disposal facility (TSDF) under either 40 CFR part 264 or part 265.

(ii) A waste management operation that treats wastewater which is an off-site material and the operation is exempted from regulation as a hazardous waste treatment, storage, and disposal facility under 40 CFR 264.1(g)(6) or 40 CFR 265.1(c)(10).

(iii) A waste management operation that treats wastewater which is an off-site material and the operation meets both of the following conditions:

(A) The operation is subject to regulation under either section 402 or 307(b) of the Clean Water Act but is not owned by a "state" or "municipality" as defined by section 502(3) and 502(4), respectively, of the Clean Water Act; and

(B) The treatment of wastewater received from off-site is the predominant activity performed at the plant site.

(iv) A recovery operation that recycles or reprocesses hazardous waste which is an off-site material and the operation is exempted from regulation as a hazardous waste treatment, disposal, and storage facility under 40 CFR 264.1(g)(2) or 40 CFR 265.1(c)(6).

(v) A recovery operation that recycles or reprocesses used solvent which is an off-site material and the operation is not part of a chemical, petroleum, or other manufacturing process that is required to use air emission controls by another subpart of 40 CFR part 63 or 40 CFR part 61.

(vi) A recovery operation that re-refines or reprocesses used oil which is an off-site material and the operation is regulated under 40 CFR 279 subpart F—Standards for Used Oil Processors and Refiners.

(b) For the purpose of implementing this subpart, an off-site material is a material that meets all of the criteria specified in paragraph (b)(1) of this section but is not one of the materials specified in paragraph (b)(2) of this section.

(1) An off-site material is a material that meets all of the criteria specified in paragraphs (b)(1)(i) through (b)(1)(iii) of this section. If any one of these criteria do not apply to the material, then the material is not an off-site material subject to this subpart.

(i) The material is a waste, used oil, or used solvent as defined in §63.681 of this subpart;

(ii) The waste, used oil, or used solvent is not produced or generated within the plant site, but the material is delivered, transferred, or otherwise moved to the plant site from a location outside the boundaries of the plant site; and

(iii) The waste, used oil, or used solvent contains one or more of the hazardous air pollutants (HAP) listed in Table 1 of this subpart based on the composition of the material at the point-of-delivery, as defined in §63.681 of this subpart.

(2) For the purpose of implementing this subpart, the following materials are not off-site materials:

(i) Household waste as defined in 40 CFR 258.2.

(ii) Radioactive mixed waste managed in accordance with all applicable regulations under Atomic Energy Act and Nuclear Waste Policy Act authorities.

(iii) Waste that is generated as a result of implementing remedial activities required under the Resource Conservation and Recovery Act (RCRA) corrective action authorities (RCRA sections 3004(u), 3004(v), or 3008(h)), Comprehensive Environmental Response, Compensation, and Liability Act (CERCLA) authorities, or similar Federal or State authorities.

(iv) Waste containing HAP that is generated by residential households (e.g., old paint, home garden pesticides) and subsequently is collected as a community service by government agencies, businesses, or other organizations for the purpose of promoting the proper disposal of this waste.

(v) Waste that is transferred from a chemical manufacturing plant or other facility for which the owner or operator of the facility from which the waste is transferred has complied with the provisions of the air emission control standards for process wastewater specified by another subpart of this part. This exemption does not apply to a source which complies with another subpart of this part by transferring its wastewater off-site for control.

(vi) Waste that is transferred from a chemical manufacturing plant, petroleum refinery, or coke by-product recovery plant which is subject to 40 CFR part 61, subpart FF—National Emission Standards for Benzene Waste Operations, and for which both of the following conditions apply to the waste:

(A) The waste is generated at a facility that is not exempted under the provisions of 40 CFR 61.342(a) from meeting the air emission control standards of 40 CFR part 61, subpart FF; and

(B) The owner or operator of the facility from which the waste is transferred has complied with the provisions of 40 CFR 61.342(f)(2).

(vii) Ship ballast water pumped from a ship to an onshore wastewater treatment facility.

(viii) Hazardous waste that is stored for 10 days or less at a transfer facility in compliance with the provisions of 40 CFR 263.12.

(c) *Affected sources*—(1) *Off-site material management units*. For each operation specified in paragraphs (a)(2)(i) through (a)(2)(vi) of this section that is located at the plant site, the affected source is the entire group of off-site material management units associated with the operation. An off-site material management unit is a tank, container, surface impoundment, oil-water separator, organic-water separator, or transfer system used to manage off-site material. For the purpose of implementing the standards under this subpart, a unit that meets the definition of a tank or container but also is equipped with a vent that serves as a process vent for any of the processes listed in paragraphs (c)(2)(i) through (c)(2)(vi) of this section is not an off-site material management unit but instead is a process vent and is to be included in the appropriate affected source group under paragraph (c)(2) of this section. Examples of such a unit may include, but are not limited to, a distillate receiver vessel, a primary condenser, a bottoms receiver vessel, a surge control tank, a separator tank, and a hot well.

(2) *Process vents*. For each operation specified in paragraphs (a)(2)(i) through (a)(2)(vi) of this section that is located at the plant site, the affected source is the entire group of process equipment associated with the process vents for the processes listed in paragraphs (c)(2)(i) through (c)(2)(vi) of this section.

(i) Distillation process used for the treatment, recycling, or recovery of off-site material. Distillation means a process, either batch or continuous, separating one or more off-site material feed streams into two or more exit streams having different component concentrations from those in the feed stream or streams. The separation is achieved by the redistribution of the components between the liquid and vapor phases as they approach equilibrium within the distillation unit.

(ii) Fractionation process used for the treatment, recycling, or recovery of off-site material. Fractionation means a liquid mixture separation process or method used to separate a mixture of several volatile components of different boiling points in successive stages, each stage removing from the mixture some proportion of one of the components.

(iii) Thin-film evaporation process used for the treatment, recycling, or recovery of off-site material. Thin-film evaporation means a liquid mixture separation process or method that uses a heating surface consisting of a large diameter tube that may be either straight or tapered, horizontal or vertical. Liquid is spread on the tube wall by a rotating assembly of blades that maintain a close clearance from the wall or actually ride on the film of liquid on the wall.

(iv) Solvent extraction process used for the treatment, recycling, or recovery of off-site material. Solvent extraction means a separation process or method in which a solid or a solution is contacted with a liquid solvent (the material and the solvent being relatively insoluble in each other) to preferentially dissolve and transfer one or more components into the solvent.

(v) Steam stripping process used for the treatment, recycling, or recovery of off-site material. Steam stripping means a liquid mixture separation process or method in which vaporization of the volatile components of a liquid mixture occurs by the introduction of steam directly into the process.

(vi) Gas stripping process used for the treatment, recycling, or recovery of off-site material. Gas stripping means a desorption process or method used to transfer one or more volatile components from a liquid mixture into a gas stream either with or without the application of heat to the liquid. Packed towers, spray towers, and bubble-cap, sieve, or valve-type plate towers are examples of the process configurations used for contacting the gas and a liquid.

(3) *Equipment leaks.* For each operation specified in paragraphs (a)(2)(i) through (a)(2)(vi) of this section that is located at the plant site, the affected source is the entire group of equipment components for which each component meets all of the conditions specified in paragraphs (c)(3)(i) through (c)(3)(iii) of this section. If any one of these conditions do not apply to an equipment component, then that component is not part of the affected source for equipment leaks.

(i) The equipment component is a pump, compressor, agitator, pressure relief device, sampling connection system, open-ended valve or line, valve, connector, or instrumentation system;

(ii) The equipment component contains or contacts off-site material having a total HAP concentration equal to or greater than 10 percent by weight; and

(iii) The equipment component is intended to operate for 300 hours or more during a calendar year in off-site material service, as defined in §63.681 of this subpart.

(d) *Facility-wide exemption.* The owner or operator of affected sources subject to this subpart is exempted from the requirements of §§63.682 through 63.699 of this subpart in situations when the total annual quantity of the HAP that is contained in the off-site material received at the plant site is less than 1 megagram per year. For a plant site to be exempted under the provisions of this paragraph (d), the owner or operator must meet the requirements in paragraphs (d)(1) through (d)(3) of this section.

(1) The owner or operator must prepare an initial determination of the total annual HAP quantity in the off-site material received at the plant site. This determination is based on the total quantity of the HAP listed in Table 1 of this subpart as determined at the point-of-delivery for each off-site material stream.

(2) The owner or operator must prepare a new determination whenever the extent of changes to the quantity or composition of the off-site material received at the plant site could cause the total annual HAP quantity in the off-site material received at the plant site to exceed the limit of 1 megagram per year.

(3) The owner or operator must maintain documentation to support the owner's or operator's determination of the total annual HAP quantity in the off-site material received at the plant site. This documentation must include the basis and data used for determining the HAP content of the off-site material.

(e) *Compliance dates*—(1) *Existing sources*. The owner or operator of an affected source that commenced construction or reconstruction before October 13, 1994, must achieve compliance with the provisions of this subpart on or before the date specified in paragraphs (e)(1)(i), (ii), or (iii) of this section as applicable to the affected source.

(i) For an affected source that commenced construction or reconstruction before October 13, 1994 and receives off-site material for the first time before February 1, 2000, the owner or operator of this affected source must achieve compliance with the provisions of the subpart (except §§63.685(b)(1)(ii), 63.691(b)(2), and 63.691(c)(3)(i) and (ii)) on or before February 1, 2000 unless an extension has been granted by the Administrator as provided in §63.6(i). These existing affected sources shall be in compliance with the tank requirements of §63.685(b)(1)(ii) 2 years after the publication date of the final amendments on March 18, 2015, the equipment leak requirements of §63.691(b)(2) 1 year after the publication date of the final amendments on March 18, 2015, and the pressure relief device monitoring requirements of §63.691(c)(3)(i) and (ii) 3 years after the publication date of the final amendments on March 18, 2015.

(ii) For an affected source that commenced construction or reconstruction before October 13, 1994, but receives off-site material for the first time on or after February 1, 2000, but before March 18, 2015, the owner or operator of the affected source must achieve compliance with the provisions of this subpart (except §§63.685(b)(1)(ii), 63.691(b)(2), and 63.691(c)(3)(i) and (ii)) upon the first date that the affected source begins to manage off-site material. These existing affected sources shall be in compliance with the tank requirements of §63.685(b)(1)(ii) 2 years after the publication date of the final amendments on March 18, 2015, the equipment leak requirements of §63.691(b)(2) 1 year after the publication date of the final amendments on March 18, 2015, and the pressure relief device monitoring requirements of §63.691(c)(3)(i) and (ii) 3 years after the publication date of the final amendments on March 18, 2015.

(iii) For an affected source that commenced construction or reconstruction before October 13, 1994, but receives off-site material for the first time on or after March 18, 2015, the owner or operator of the affected source must achieve compliance with the provisions of this subpart (except §§63.685 (b)(1)(ii), 63.691(b)(2), and 63.691(c)(3)(i) and (ii)) upon the first date that the affected source begins to manage off-site material. These existing affected sources shall be in compliance with the tank requirements of §63.685(b)(1)(ii) 2 years after the publication date of the final amendments on March 18, 2015, the equipment leak requirements of §63.691(b)(2) 1 year after the publication date of the final amendments on March 18, 2015, and the pressure relief device monitoring requirements of §63.691(c)(3)(i) and (ii) 3 years after the publication date of the final amendments on March 18, 2015.

(2) *New sources*. The owner or operator of an affected source for which construction or reconstruction commences on or after October 13, 1994, must achieve compliance with the provisions of this subpart (except §§63.685(b)(2), 63.691(b)(2), and 63.691(c)(3)(i) and (ii)) on or before July 1, 1996, or upon initial startup of operations, whichever date is later as provided in 40 CFR 63.6(b). New affected sources that commenced construction or reconstruction after October 13, 1994, but on or before July 2, 2014, shall be in compliance with the tank requirements of §63.685(b)(2) 2 years after the publication date of the final amendments, the equipment leak requirements of §63.691(b)(2) 1 year after the publication date of the final amendments, and the pressure relief device monitoring requirements of §63.691(c)(3)(i) and (ii) 3 years after the effective date of the final amendments. New affected sources that commence construction or reconstruction after July 2, 2014, shall be in compliance with the tank

requirements of §63.685(b)(2), the equipment leak requirements of §63.691(b)(2), and the pressure relief device monitoring requirements of §63.691(c)(3)(i) and (ii) upon initial startup or by the effective date of the final amendments, whichever is later.

(f) The provisions of 40 CFR part 63, subpart A—General Provisions that apply and those that do not apply to this subpart are specified in Table 2 of this subpart.

(g) *Applicability of this subpart.* (1) The emission limitations set forth in this subpart and the emission limitations referred to in this subpart shall apply at all times except during periods of non-operation of the affected source (or specific portion thereof) resulting in cessation of the emissions to which this subpart applies.

(2) The owner or operator shall not shut down items of equipment that are required or utilized for compliance with this subpart during times when emissions are being routed to such items of equipment, if the shutdown would contravene requirements of this subpart applicable to such items of equipment.

[61 FR 34158, July 1, 1996, as amended at 65 FR 38963, July 20, 1999; 80 FR 14271, Mar. 18, 2015]

 [Back to Top](#)

§63.681 Definitions.

All terms used in this subpart shall have the meaning given to them in this section, 40 CFR 63.2 of this part, and the Act.

Boiler means an enclosed combustion device that extracts useful energy in the form of steam and is not an incinerator or a process heater.

Bypass means diverting a process vent or closed vent system stream to the atmosphere such that it does not first pass through an emission control device.

Closed-vent system means a system that is not open to the atmosphere and is composed of hard-piping, ductwork, connections, and, if necessary, fans, blowers, or other flow-inducing devices that conveys gas or vapor from an emission point to a control device.

Closure device means a cap, hatch, lid, plug, seal, valve, or other type of fitting that prevents or reduces air pollutant emissions to the atmosphere by blocking an opening in a cover when the device is secured in the closed position. Closure devices include devices that are detachable from the cover (e.g., a sampling port cap), manually operated (e.g., a hinged access lid or hatch), or automatically operated (e.g., a spring-loaded pressure relief valve).

Container means a portable unit used to hold material. Examples of containers include but are not limited to drums, dumpsters, roll-off boxes, bulk cargo containers commonly known as “portable tanks” or “totes”, cargo tank trucks, and tank rail cars.

Continuous record means documentation of data values measured at least once every 15 minutes and recorded at the frequency specified in this subpart.

Continuous recorder means a data recording device that either records an instantaneous data value at least once every 15 minutes or records 15-minute or more frequent block averages.

Continuous seal means a seal that forms a continuous closure that completely covers the space between the edge of the floating roof and the wall of a tank. A continuous seal may be a vapor-mounted seal, liquid-mounted seal, or metallic shoe seal. A continuous seal may be constructed of fastened segments so as to form a continuous seal.

Control device means equipment used for recovering, removing, oxidizing, or destroying organic vapors. Examples of such equipment include but are not limited to carbon adsorbers, condensers, vapor incinerators, flares, boilers, and process heaters.

Cover means a device or system that provides a continuous barrier over the material managed in an off-site material management unit to prevent or reduce air pollutant emissions to the atmosphere. A cover may have openings needed for operation, inspection, sampling, maintenance, and repair of the unit provided that each opening is closed when not in use (e.g., access hatches, sampling ports). A cover may be a separate piece of equipment which can be detached and removed from the unit or a *cover* may be formed by structural features permanently integrated into the design of the unit.

Emission point means an individual tank, surface impoundment, container, oil-water or organic-water separator, transfer system, process vent, or enclosure.

Enclosure means a structure that surrounds a tank or container, captures organic vapors emitted from the tank or container, and vents the captured vapor through a closed vent system to a control device.

External floating roof means a pontoon-type or double-deck type cover that rests on the liquid surface in a tank with no fixed roof.

Fixed roof means a cover that is mounted on a unit in a stationary position and does not move with fluctuations in the level of the liquid managed in the unit.

Flame zone means the portion of the combustion chamber in a boiler or process heater occupied by the flame envelope.

Floating roof means a cover consisting of a double deck, pontoon single deck, or internal floating cover which rests upon and is supported by the liquid being contained, and is equipped with a continuous seal.

Flow indicator means a device that indicates whether gas is flowing, or whether the valve position would allow gas to flow in a bypass line.

Hard-piping means pipe or tubing that is manufactured and properly installed in accordance with relevant standards and good engineering practices.

Hazardous air pollutants or *HAP* means the specific organic chemical compounds, isomers, and mixtures listed in Table 1 of this subpart.

Hazardous waste means a waste that is determined to be hazardous under the Resource Conservation and Recovery Act (PL 94-580) (RCRA), as implemented by 40 CFR parts 260 and 261.

In gas/vapor service means that a piece of equipment in off-site material service contains or contacts a gas or vapor at operating conditions.

In heavy liquid service means that a piece of equipment in off-site material service is not in gas/vapor service or in light liquid service.

In light liquid service means that a piece of equipment in off-site material service contains or contacts a liquid that meets the following conditions:

(1) The vapor pressure of one or more of the organic compounds is greater than 0.3 kilopascals at 20 °C;

(2) The total concentration of the pure organic compounds constituents having a vapor pressure greater than 0.3 kilopascals at 20 °C is equal to or greater than 20 percent by weight of the total process stream; and

(3) The fluid is a liquid at operating conditions. Note to *In light liquid service*: Vapor pressures may be determined by the methods described in 40 CFR 60.485(e)(1).

In liquid service means that a piece of equipment in off-site material service is not in gas/vapor service.

Individual drain system means a stationary system used to convey wastewater streams or residuals to a waste management unit or to discharge or disposal. The term includes hard-piping, all drains and junction boxes, together with their associated sewer lines and other junction boxes (e.g., manholes, sumps, and lift stations) conveying wastewater streams or residuals. For the purpose of this subpart, an individual drain system is not a drain and collection system that is designed and operated for the sole purpose of collecting rainfall runoff (e.g., stormwater sewer system) and is segregated from all other individual drain systems.

Internal floating roof means a cover that rests or floats on the liquid surface (but not necessarily in complete contact with it inside a tank that has a fixed roof).

Light-material service means the container is used to manage an off-site material for which both of the following conditions apply: the vapor pressure of one or more of the organic constituents in the off-site material is greater than 0.3 kilopascals (kPa) at 20 °C; and the total concentration of the pure organic constituents having a vapor pressure greater than 0.3 kPa at 20 °C is equal to or greater than 20 percent by weight.

Liquid-mounted seal means a foam- or liquid-filled continuous seal mounted in contact with the liquid in a unit.

Maximum HAP vapor pressure means the sum of the individual HAP equilibrium partial pressure exerted by an off-site material at the temperature equal to either: the local maximum monthly average temperature as reported by the National Weather Service when the off-site material is stored or treated at ambient temperature; or the highest calendar-month average temperature of the off-site material when the off-site material is stored at temperatures above the ambient temperature or when the off-site material is stored or treated at temperatures below the ambient temperature. For the purpose of this subpart, maximum HAP vapor pressure is determined using the procedures specified in §63.694(j) of this subpart.

Metallic shoe seal means a continuous seal that is constructed of metal sheets which are held vertically against the wall of the tank by springs, weighted levers, or other mechanisms and is connected to the floating roof by braces or other means. A flexible coated fabric (envelope) spans the annular space between the metal sheet and the floating roof.

No detectable organic emissions means no escape of organics to the atmosphere as determined using the procedure specified in §63.694(k) of this subpart.

Off-site material means a material that meets all of the criteria specified in paragraph §63.680(b)(1) of this subpart but is not one of the materials specified in §63.680(b)(2) of this subpart.

Off-site material management unit means a tank, container, surface impoundment, oil-water separator, organic-water separator, or transfer system used to manage off-site material.

Off-site material service means any time when a pump, compressor, agitator, pressure relief device, sampling connection system, open-ended valve or line, valve, connector, or instrumentation system contains or contacts off-site material.

Off-site material stream means an off-site material produced or generated by a particular process or source such that the composition and form of the material comprising the stream remain consistent. An off-site material stream may be delivered, transferred, or otherwise moved to the plant site in a continuous flow of material (e.g., wastewater flowing through a pipeline) or in a series of discrete batches of material (e.g., a truckload of drums all containing the same off-site material or multiple bulk truck loads of an off-site material produced by the same process).

Oil-water separator means a separator as defined for this subpart that is used to separate oil from water.

Operating parameter value means a minimum or maximum value established for a control device or treatment process parameter which, if achieved by itself or in combination with one or more other operating parameter values, determines that an owner or operator has complied with an applicable emission limitation or standard.

Organic-water separator means a separator as defined for this subpart that is used to separate organics from water.

Plant site means all contiguous or adjoining property that is under common control including properties that are separated only by a road or other public right-of-way. Common control includes properties that are owned, leased, or operated by the same entity, parent entity, subsidiary, or any combination thereof. A unit or group of units within a contiguous property that are not under common control (e.g., a wastewater treatment unit or solvent recovery unit located at the site but is sold to a different company) is a different plant site.

Point-of-delivery means the point at the boundary or within the plant site where the owner or operator first accepts custody, takes possession, or assumes responsibility for the management of an off-site material stream managed in a waste management operation or recovery operation specified in §63.680 (a)(2)(i) through (a)(2)(vi) of this subpart. The characteristics of an off-site material stream are determined prior to combining the off-site material stream with other off-site material streams or with any other materials.

Point-of-treatment means a point after the treated material exits the treatment process but before the first point downstream of the treatment process exit where the organic constituents in the treated material have the potential to volatilize and be released to the atmosphere. For the purpose of applying this definition to this subpart, the first point downstream of the treatment process exit is not a fugitive emission point due to an equipment leak from any of the following equipment components: Pumps, compressors, valves, connectors, instrumentation systems, or pressure relief devices.

Pressure release means the emission of materials resulting from the system pressure being greater than the set pressure of the pressure relief device. This release can be one release or a series of releases over a short time period.

Pressure relief device or valve means a safety device used to prevent operating pressures from exceeding the maximum allowable working pressure of the process equipment. A common pressure relief device is a spring-loaded pressure relief valve. Devices that are actuated either by a pressure of less than or equal to 2.5 pounds per square inch gauge or by a vacuum are not pressure relief devices.

Process heater means an enclosed combustion device that transfers heat released by burning fuel directly to process streams or to heat transfer liquids other than water.

Process vent means an open-ended pipe, stack, or duct through which a gas stream containing HAP is continuously or intermittently discharged to the atmosphere from any of the processes listed in §63.680(c)(2)(i) through (vi). For the purpose of this subpart, a process vent is none of the following: a pressure relief device; an open-ended line or other vent that is subject to the equipment leak control requirements under §63.691; or a stack or other vent that is used to exhaust combustion products from a boiler, furnace, process heater, incinerator, or other combustion device.

Recovery operation means the collection of off-site material management units, process vents, and equipment components used at a plant site to manage an off-site material stream from the point-of-delivery through the point where the material has been recycled, reprocessed, or re-refined to obtain the intended product or to remove the physical and chemical impurities of concern.

Separator means a waste management unit, generally a tank, used to separate oil or organics from water. A separator consists of not only the separation unit but also the forebay and other separator basins, skimmers, weirs, grit chambers, sludge hoppers, and bar screens that are located directly after the individual drain system and prior to any additional treatment units such as an air flotation unit clarifier or biological treatment unit. Examples of a separator include, but are not limited to, an API separator, parallel-plate interceptor, and corrugated-plate interceptor with the associated ancillary equipment.

Single-seal system means a floating roof having one continuous seal. This seal may be vapor-mounted, liquid-mounted, or a metallic shoe seal.

Surface impoundment means a unit that is a natural topographical depression, man-made excavation, or diked area formed primarily of earthen materials (although it may be lined with man-made materials), which is designed to hold an accumulation of liquids. Examples of surface impoundments include holding, storage, settling, and aeration pits, ponds, and lagoons.

Tank means a stationary unit that is constructed primarily of nonearthen materials (such as wood, concrete, steel, fiberglass, or plastic) which provide structural support and is designed to hold an accumulation of liquids or other materials.

Transfer system means a stationary system for which the predominant function is to convey liquids or solid materials from one point to another point within a waste management operation or recovery operation. For the purpose of this subpart, the conveyance of material using a container (as defined for this subpart) or a self-propelled vehicle (e.g., a front-end loader) is not a transfer system. Examples of a transfer system include but are not limited to a pipeline, an individual drain system, a gravity-operated conveyor (such as a chute), and a mechanically-powered conveyor (such as a belt or screw conveyor).

Temperature monitoring device means a piece of equipment used to monitor temperature and having an accuracy of ± 1 percent of the temperature being monitored expressed in degrees Celsius ($^{\circ}\text{C}$) or ± 1.2 degrees $^{\circ}\text{C}$, whichever value is greater.

Treatment process means a process in which an off-site material stream is physically, chemically, thermally, or biologically treated to destroy, degrade, or remove hazardous air pollutants contained in the off-site material. A treatment process can be composed of a single unit (e.g., a steam stripper) or a series

of units (e.g., a wastewater treatment system). A treatment process can be used to treat one or more off-site material streams at the same time.

Used oil means any oil refined from crude oil or any synthetic oil that has been used and as a result of such use is contaminated by physical or chemical impurities. This definition is the same definition of “used oil” in 40 CFR 279.1.

Used solvent means a mixture of aliphatic hydrocarbons or a mixture of one and two ring aromatic hydrocarbons that has been used as a solvent and as a result of such use is contaminated by physical or chemical impurities.

Vapor-mounted seal means a continuous seal that is mounted such that there is a vapor space between the liquid in the unit and the bottom of the seal.

Volatile organic hazardous air pollutant concentration or *VOHAP concentration* means the fraction by weight of those compounds listed in Table 1 of this subpart that are in an off-site material as measured using Method 305 in appendix A of this part and expressed in terms of parts per million (ppm). As an alternative to using Method 305, an owner or operator may determine the HAP concentration of an off-site material using any one of the other test methods specified in §63.694(b)(2)(ii) of this subpart. When a test method specified in §63.694(b)(2)(ii) of this subpart other than Method 305 is used to determine the speciated HAP concentration of an off-site material, the individual compound concentration may be adjusted by the corresponding f_{m305} value listed in Table 1 of this subpart to determine a VOHAP concentration.

Waste means a material generated from industrial, commercial, mining, or agricultural operations or from community activities that is discarded, discharged, or is being accumulated, stored, or physically, chemically, thermally, or biologically treated prior to being discarded or discharged.

Waste management operation means the collection of off-site material management units, process vents, and equipment components used at a plant site to manage an off-site material stream from the point-of-delivery to the point where the waste exits or is discharged from the plant site or the waste is placed for on-site disposal in a unit not subject to this subpart (e.g., a waste incinerator, a land disposal unit).

Waste stabilization process means any physical or chemical process used to either reduce the mobility of hazardous constituents in a waste or eliminate free liquids as determined by Test Method 9095—Paint Filter Liquids Test in “Test Methods for Evaluating Solid Waste, Physical/Chemical Methods,” EPA Publication No. SW-846, Third Edition, September 1986, as amended by Update I, November 15, 1992. (As an alternative, an owner or operator may use any more recent, updated version of Method 9095 approved by the EPA.) A waste stabilization process includes mixing the waste with binders or other materials and curing the resulting waste and binder mixture. Other synonymous terms used to refer to this process are “waste fixation” or “waste solidification.” A waste stabilization process does not include the adding of absorbent materials to the surface of a waste, without mixing, agitation, or subsequent curing, to absorb free liquid.

[61 FR 34158, July 1, 1996, as amended at 64 FR 38964, July 20, 1999; 80 FR 14272, Mar. 18, 2015]

 [Back to Top](#)

§63.682 [Reserved]

 [Back to Top](#)

§63.683 Standards: General.

(a) The general standards under this section apply to owners and operators of affected sources as designated in §63.680(c) of this subpart.

(b) *Off-site material management units.* (1) For each off-site material management unit that is part of an affected source, the owner or operator must meet the requirements in either paragraph (b)(1)(i), (b)(1)(ii), or (b)(1)(iii) of this section except for those off-site material management units exempted under paragraph (b)(2) of this section.

(i) The owner or operator controls air emissions from the off-site material management unit in accordance with the applicable standards specified in §§63.685 through 63.689 of this subpart.

(ii) The owner or operator removes or destroys HAP in the off-site material before placing the material in the off-site material management unit by treating the material in accordance with the standards specified in §63.684 of this subpart.

(iii) The owner or operator determines before placing off-site material in the off-site material management unit that the average VOHAP concentration of the off-site material is less than 500 parts per million by weight (ppmw) at the point-of-delivery. The owner or operator must perform an initial determination of the average VOHAP concentration of the off-site material using the procedures specified in §63.694(b) of this subpart. This initial determination must be performed either before the first time any portion of the off-site material stream is placed in the unit or by the compliance date, whichever date is later. Thereafter, the owner or operator must review and update, as necessary, this determination at least once every calendar year following the date of the initial determination for the off-site material stream.

(2) An off-site material management unit is exempted from the requirements in paragraph (b)(1) of this section when the owner or operator meets one of the exemptions provided in paragraphs (b)(2)(i) through (b)(2)(iv) of this section as applicable to the unit.

(i) An off-site material management unit is exempted from the requirements in paragraph (b)(1) of this section if the off-site material management unit is also subject to another subpart under 40 CFR part 63 or 40 CFR part 61, and the owner or operator is controlling the HAP listed in Table 1 of this subpart that are emitted from the unit in compliance with the provisions specified in the other applicable subpart under part 61 or part 63.

(ii) At the discretion of the owner or operator, one or a combination of off-site material management units may be exempted from the requirements in paragraph (b)(1) of this section when these units meet the condition that the total annual quantity of HAP contained in the off-site material placed in the units exempted under this paragraph (b)(2)(ii) is less than 1 megagram per year. For the off-site material management units selected by the owner or operator to be exempted from the requirements in paragraph (b)(1) of this section, the owner or operator must meet the requirements in paragraphs (b)(2)(ii)(A) and (b)(2)(ii)(B) of this section. An owner or operator may change the off-site material management units selected to be exempted under this paragraph (b)(2)(ii) by preparing a new designation for the exempt-units as required by paragraph (b)(2)(ii)(A) of this section and performing a new determination as required by paragraph (b)(2)(ii)(B) of this section.

(A) The owner or operator must designate each of the off-site material management units selected by the owner or operator to be exempt under paragraph (b)(2)(ii) of this section by either submitting to the Administrator a written notification identifying the exempt-units or permanently marking the exempt-units at the plant site. If an owner or operator chooses to prepare and submit a written notification, this notification must include a site plan, process diagram, or other appropriate documentation identifying each of the exempt-units. If an owner or operator chooses to permanently mark the exempt-units, each

exempt-unit must be marked in such a manner that it can be readily identified as an exempt-unit from the other off-site material management units located at the plant site.

(B) The owner or operator must prepare an initial determination of the total annual HAP quantity in the off-site material placed in the units exempted under this paragraph (b)(2)(ii). This determination is based on the total quantity of the HAP listed in Table 1 of this subpart as determined at the point where the off-site material is placed in each exempted unit. The owner or operator must perform a new determination whenever the extent of changes to the quantity or composition of the off-site material placed in the exempted units could cause the total annual HAP content in the off-site material to exceed 1 megagram per year. The owner or operator must maintain documentation to support the most recent determination of the total annual HAP quantity. This documentation must include the basis and data used for determining the HAP content of the off-site material.

(iii) A tank or surface impoundment is exempted from the requirements in paragraph (b)(1) of this section if the unit is used for a biological treatment process that meets the requirements in either paragraph (b)(2)(iii)(A) or (b)(2)(iii)(B) of this section and the owner or operator complies with the monitoring requirements in §63.684(e)(4) of this subpart.

(A) The HAP biodegradation efficiency (R_{bio}) for the biological treatment process is equal to or greater than 95 percent. The HAP biodegradation efficiency (R_{bio}) shall be determined in accordance with the requirements of §63.694(h) of this subpart.

(B) The total actual HAP mass removal rate (MR_{bio}) for the off-site material treated by the biological treatment process is equal to or greater than the required HAP mass removal rate (RMR) for the off-site material. The total actual HAP mass removal rate (MR_{bio}) must be determined in accordance with the requirements of §63.694(i) of this subpart. The required HAP mass removal rate (RMR) must be determined in accordance with the requirements of §63.694(e) of this subpart.

(iv) An off-site material management unit is exempted from the requirements in paragraph (b)(1) of this section if the off-site material placed in the unit is a hazardous waste that meets the conditions specified in either paragraph (b)(2)(iv)(A) or (b)(2)(iv)(B) of this section.

(A) The hazardous waste meets the numerical organic concentration limits, applicable to the hazardous waste, as specified in 40 CFR part 268—Land Disposal Restrictions, listed in the table, “Treatment Standards for Hazardous Waste” in 40 CFR 268.40.

(B) The organic hazardous constituents in the hazardous waste have been treated by the treatment technology established by the EPA for the hazardous waste in 40 CFR 268.42(a), or have been removed or destroyed by an equivalent method of treatment approved by the EPA under 40 CFR 268.42(b).

(v) A tank used for bulk feed of off-site material to a waste incinerator is exempted from the requirements specified in paragraph (b)(1) of this section if the tank meets all of the conditions specified in paragraphs (b)(2)(v)(A) through (b)(2)(v)(C) of this section.

(A) The tank is located inside an enclosure vented to a control device that is designed and operated in accordance with all applicable requirements specified under 40 CFR part 61, subpart FF—National Emission Standards for Benzene Waste Operations for a facility at which the total annual benzene quantity from the facility waste is equal to or greater than 10 megagrams per year;

(B) The enclosure and control device serving the tank were installed and began operation prior to July 1, 1996; and

(C) The enclosure is designed and operated in accordance with the criteria for a permanent total enclosure as specified in “Procedure T—Criteria for and Verification of a Permanent or Temporary Total Enclosure” under 40 CFR 52.741, appendix B. The enclosure may have permanent or temporary openings to allow worker access; passage of material into or out of the enclosure by conveyor, vehicles, or other mechanical or electrical equipment; or to direct air flow into the enclosure. The owner or operator must annually perform the verification procedure for the enclosure as specified in Section 5.0 to “Procedure T—Criteria for and Verification of a Permanent or Temporary Total Enclosure.”

(c) *Process vents.* (1) For each process vent that is part of an affected source, the owner or operator must meet the requirements in either paragraph (c)(1)(i) or (c)(1)(ii) of this section except for those process vents exempted under paragraph (c)(2) of this section.

(i) The owner or operator controls air emissions from the process vent in accordance with the standards specified in §63.690 of this subpart.

(ii) The owner or operator determines before placing off-site material in the process equipment associated with the process vent that the average VOHAP concentration of the off-site material is less than 500 ppmw at the point-of-delivery. The owner or operator must perform an initial determination of the average VOHAP concentration of the off-site material using the procedures specified in §63.694(b) of this subpart before any portion of the off-site material stream is placed in the unit. Thereafter, the owner or operator must review and update, as necessary, this determination at least once every calendar year following the date of the initial determination for the off-site material stream.

(2) A process vent is exempted from the requirements of paragraph (c)(1) of this section when the owner or operator meets one of the exemptions provided in paragraphs (c)(2)(i) through (c)(2)(iii) of this section.

(i) A process vent is exempted from the requirements in paragraph (c)(1) of this section if the process vent is also subject to another subpart under part 63 or 40 CFR part 61, and the owner or operator is controlling the HAP listed in Table 1 of this subpart that are emitted from the process vent in compliance with the provisions specified in the other applicable subpart under part 61 or part 63.

(ii) A process vent is exempted from the requirements specified in paragraph (c)(1) of this section if the owner or operator determines that the process vent stream flow rate is less than 0.005 cubic meters per minute (m^3/min) at standard conditions (as defined in 40 CFR 63.2). The process vent stream flow rate shall be determined in accordance with the procedures specified in §63.694(m) of this subpart. Documentation must be prepared by the owner or operator and maintained at the plant site to support the determination of the process vent stream flow rate. This documentation must include identification of each process vent exempted under this paragraph and the test results used to determine the process vent stream flow rate.

(iii) A process vent is exempted from the requirements specified in paragraph (c)(1) of this section if the owner or operator determines that the process vent stream flow rate is less than 6.0 m^3/min at standard conditions (as defined in 40 CFR 63.2) and the total HAP concentration is less than 20 ppmv. The process vent stream flow rate and total HAP concentration shall be determined in accordance with the procedures specified in §63.694(m) of this subpart. Documentation must be prepared by the owner or operator and maintained at the plant site to support the determination of the process vent stream flow rate and total HAP concentration. This documentation must include identification of each process vent exempted under this paragraph (c)(2)(iii) and the test results used to determine the process vent stream flow rate and total HAP concentration. The owner or operator must perform a new determination of the process vent stream flow rate and total HAP concentration when the extent of changes to operation of the unit on which the process vent is used could cause either the process vent stream flow rate to exceed the limit of 6.0 m^3/min or the total HAP concentration to exceed the limit of 20 ppmv.

(d) *Equipment leaks.* The owner or operator must control equipment leaks from each equipment component that is part of the affected source specified in §63.680(c)(3) of this subpart by implementing leak detection and control measures in accordance with the standards specified in §63.691 of this subpart.

(e) *General duty.* At all times, the owner or operator must operate and maintain any affected source, including associated air pollution control equipment and monitoring equipment, in a manner consistent with safety and good air pollution control practices for minimizing emissions. The general duty to minimize emissions does not require the owner operator to make any further efforts to reduce emissions if levels required by the applicable standard have been achieved. Determination of whether a source is operating in compliance with operation and maintenance requirements will be based on information available to the Administrator, which may include, but is not limited to, monitoring results, review of operation and maintenance procedures, review of operation and maintenance records, and inspection of the source.

(f) In addition to the cases listed in §63.695(e)(4), deviation means any of the cases listed in paragraphs (f)(1) through (6) of this section.

(1) Any instance in which an affected source subject to this subpart, or an owner or operator of such a source, fails to meet any requirement or obligation established by this subpart, including, but not limited to, any emission limit, operating limit or work practice standard.

(2) When a performance test indicates that emissions of a pollutant in Table 1 to this subpart are exceeding the emission standard for the pollutant specified in Table 1 to this subpart.

(3) When the average value of a monitored operating parameter, based on the data averaging period for compliance specified in §63.695, does not meet the operating limit specified in §63.693.

(4) When an affected source discharges directly into the atmosphere from any of the sources specified in paragraphs (f)(4)(i) and (ii) of this section.

(i) A pressure relief device, as defined in §63.681.

(ii) A bypass, as defined in §63.681.

(5) Any instance in which the affected source subject to this subpart, or an owner or operator of such a source, fails to meet any term or condition specified in paragraph (f)(5)(i) or (ii) of this section.

(i) Any term or condition that is adopted to implement an applicable requirement in this subpart.

(ii) Any term or condition relating to compliance with this subpart that is included in the operating permit for an affected source to obtain such a permit.

(6) Any failure to collect required data, except for periods of monitoring system malfunctions, repairs associated with monitoring system malfunctions, and required monitoring system quality assurance or quality control activities (including, as applicable, calibration checks and required zero and span adjustments).

[64 FR 38965, July 20, 1999, as amended at 80 FR 14272, Mar. 18, 2015]

 [Back to Top](#)

§63.684 Standards: Off-site material treatment.

(a) The provisions of this section apply to the treatment of off-site material to remove or destroy HAP for which §63.683(b)(1)(ii) of this subpart references the requirements of this section for such treatment.

(b) The owner or operator shall remove or destroy the HAP contained in off-site material streams to be managed in the off-site material management unit in accordance with §63.683(b)(1)(ii) of this subpart using a treatment process that continuously achieves, under normal operations, one or more of the performance levels specified in paragraphs (b)(1) through (b)(5) of this section (as applicable to the type of treatment process) for the range of off-site material stream compositions and quantities expected to be treated.

(1) *VOHAP concentration.* The treatment process shall reduce the VOHAP concentration of the off-site material using a means, other than by dilution, to achieve one of the following performance levels, as applicable:

(i) In the case when every off-site material stream entering the treatment process has an average VOHAP concentration equal to or greater than 500 ppmw at the point-of-delivery, then the VOHAP concentration of the off-site material shall be reduced to a level that is less than 500 ppmw at the point-of-treatment.

(ii) In the case when off-site material streams entering the treatment process are a mixture of off-site material streams having an average VOHAP concentration equal to or greater than 500 ppmw at the point-of-delivery with off-site material streams having average VOHAP concentrations less than 500 ppmw at the point-of-delivery, then the VOHAP concentration of the off-site material must be reduced to a level at the point-of-treatment that meets the performance level specified in either paragraph (b)(1)(ii)(A) or (B) of this section.

(A) Less than the VOHAP concentration limit (C_R) established for the treatment process using the procedure specified in §63.694(d); or

(B) Less than the lowest VOHAP concentration determined for each of the off-site material streams entering the treatment process as determined by the VOHAP concentration of the off-site material at the point-of-delivery.

(2) *HAP mass removal.* The treatment process shall achieve a performance level such that the total quantity of HAP actually removed from the off-site material stream (MR) is equal to or greater than the required mass removal (RMR) established for the off-site material stream using the procedure specified in §63.694(e) of this subpart. The MR for the off-site material streams shall be determined using the procedures specified in §63.694(f) of this subpart.

(3) *HAP reduction efficiency.* For any treatment process except a treatment process that uses biological degradation and is performed in an open tank or surface impoundment, the treatment process must achieve the applicable performance level specified in either paragraph (b)(3)(i) or (b)(3)(ii) of this section.

(i) In the case when the owner or operator determines that off-site material stream entering the treatment process has an average VOHAP concentration less than 10,000 ppmw at the point-of-delivery, then the treatment process shall achieve a performance level such that the total quantity of HAP in the off-site material stream is reduced by 95 percent or more. The HAP reduction efficiency (R) for the treatment process shall be determined using the procedure specified in §63.694(g) of this subpart. The average VOHAP concentration of the off-site material stream at the point-of-delivery shall be determined using the procedure specified in §63.694(b) of this subpart.

(ii) In the case when the off-site material stream entering the treatment process has an average VOHAP concentration equal to or greater than 10,000 ppmw at the point-of-delivery, then the treatment

process shall achieve a performance level such that the total quantity of HAP in the off-site material stream is reduced by 95 percent or more, and the average VOHAP concentration of the off-site material at the point-of-treatment is less than 100 parts per million by weight (ppmw). The HAP reduction efficiency (R) for the treatment process shall be determined using the procedure specified in §63.694(g) of this subpart. The average VOHAP concentration of the off-site material stream at the point-of-treatment shall be determined using the procedure specified in §63.694(c) of this subpart.

(4) *Biological degradation performed in an open tank or surface impoundment.* A treatment process using biological degradation and performed in an open tank or surface impoundment must achieve the performance level specified in either paragraph (b)(4)(i) or (b)(4)(ii) of this section.

(i) The HAP reduction efficiency (R) for the treatment process is equal to or greater than 95 percent, and the HAP biodegradation efficiency (R_{bio}) for the treatment process is equal to or greater than 95 percent. The HAP reduction efficiency (R) shall be determined using the procedure specified in §63.694(g) of this subpart. The HAP biodegradation efficiency (R_{bio}) shall be determined in accordance with the requirements of §63.694(h) of this subpart.

(ii) The total quantity of HAP actually removed from the off-site material stream by biological degradation (MR_{bio}) shall be equal to or greater than the required mass removal (RMR) established for the off-site material stream using the procedure specified in §63.694(e) of this subpart. The MR_{bio} of the off-site material stream shall be determined using the procedures specified in §63.694(i) of this subpart.

(5) *Incineration.* The treatment process must destroy the HAP contained in the off-site material stream using one of the combustion devices specified in paragraphs (b)(5)(i) through (v) of this section.

(i) An incinerator for which the owner or operator has been issued a final permit under 40 CFR part 270, and the incinerator is designed and operated in accordance with the requirements of 40 CFR part 264, subpart O—Incinerators, or

(ii) An incinerator for which the owner or operator has certified compliance with the interim status requirements of 40 CFR part 265, subpart O—Incinerators.

(iii) A boiler or industrial furnace for which the owner or operator has been issued a final permit under 40 CFR part 270, and the combustion unit is designed and operated in accordance with the requirements of 40 CFR part 266, subpart H—Hazardous Waste Burned in Boilers and Industrial Furnaces.

(iv) A boiler or industrial furnace for which the owner or operator has certified compliance with the interim status requirements of 40 CFR part 266, subpart H Hazardous Waste Burned in Boilers and Industrial Furnaces.

(v) An incinerator, boiler, or industrial furnace for which the owner or operator has submitted a Notification of Compliance under §§63.1207(j) and 63.1210(d) and complies with the requirements of subpart EEE of this part at all times (including times when non-hazardous waste is being burned).

(c) For a treatment process that removes the HAP from the off-site material by a means other than thermal destruction or biological degradation to achieve one of the performance levels specified in paragraph (b)(1), (b)(2), or (b)(3) of this section, the owner or operator shall manage the HAP removed from the off-site material in such a manner to minimize release of these HAP to the atmosphere, to the extent practical. Examples of HAP emission control measures that meet the requirements of this paragraph include managing the HAP removed from the off-site material in units that use air emission controls in accordance with the standards specified in §§63.685 through 63.689 of this subpart, as applicable to the unit.

(d) When the owner or operator treats the off-site material to meet one of the performance levels specified in paragraphs (b)(1) through (b)(4) of this section, the owner or operator shall demonstrate that the treatment process achieves the selected performance level for the range of expected off-site material stream compositions expected to be treated. An initial demonstration shall be performed as soon as possible but no later than 30 days after first time an owner or operator begins using the treatment process to manage off-site material streams in accordance with the requirements of either §63.683(b)(1)(ii) or §63.683(b)(2)(ii) of this subpart as applicable to the affected off-site material management unit or process equipment. Thereafter, the owner or operator shall review and update, as necessary, this demonstration at least once every calendar year following the date of the initial demonstration.

(e) When the owner or operator treats the off-site material to meet one of the performance levels specified in paragraphs (b)(1) through (b)(4) of this section, the owner or operator shall ensure that the treatment process is achieving the applicable performance requirements by continuously monitoring the operation of the process when it is used to treat off-site material by complying with paragraphs (e)(1) through (e)(3) or, for biological treatment units, paragraph (e)(4) of this section:

(1) A continuous monitoring system shall be installed and operated for each treatment that measures operating parameters appropriate for the treatment process technology. This system shall include a continuous recorder that records the measured values of the selected operating parameters. The monitoring equipment shall be installed, calibrated, and maintained in accordance with the equipment manufacturer's specifications. The continuous recorder shall be a data recording device that is capable of recording either an instantaneous data value at least once every 15 minutes or an average value for intervals of 15 minutes or less.

(2) For each monitored operating parameter, the owner or operator shall establish a minimum operating parameter value or a maximum operating parameter value, as appropriate, to define the range of conditions at which the treatment process must be operated to continuously achieve the applicable performance requirements of this section.

(3) When the treatment process is operating to treat off-site material, the owner or operator shall inspect the data recorded by the continuous monitoring system on a routine basis and operate the treatment process such that the actual value of each monitored operating parameter is greater than the minimum operating parameter value or less than the maximum operating parameter value, as appropriate, established for the treatment process.

(4) When the treatment process is a biological treatment process that is complying with paragraph (b)(4) of this section, the owner or operator must establish and implement a written procedure to monitor the appropriate parameters that demonstrate proper operation of the biological treatment unit in accordance with the evaluation required in §63.694(h) of this subpart. The written procedure must list the operating parameters that will be monitored and state the frequency of monitoring to ensure that the biological treatment unit is operating between the minimum operating parameter values and maximum operating parameter values to establish that the biological treatment unit is continuously achieving the performance requirement.

(f) The owner or operator must maintain records for each treatment process in accordance with the requirements of §63.696(a) of this subpart.

(g) The owner or operator must prepare and submit reports for each treatment process in accordance with the requirements of §63.697(a) of this subpart.

(h) The Administrator may at any time conduct or require that the owner or operator conduct testing necessary to demonstrate that a treatment process is achieving the applicable performance requirements of this section. The testing shall be conducted in accordance with the applicable requirements of this

section. The Administrator may elect to have an authorized representative observe testing conducted by the owner or operator.

[61 FR 34158, July 1, 1996, as amended at 64 FR 38967, July 20, 1999; 66 FR 1266, Jan. 8, 2001; 68 FR 37351, June 23, 2003; 80 FR 14273, Mar. 18, 2015]

 [Back to Top](#)

§63.685 Standards: Tanks.

(a) The provisions of this section apply to the control of air emissions from tanks for which §63.683(b)(1)(i) of this subpart references the use of this section for such air emission control.

(b) According to the date an affected source commenced construction or reconstruction and the date an affected source receives off-site material for the first time as established in §63.680(e)(i) through (iii), the owner or operator shall control air emissions from each tank subject to this section in accordance with either paragraph (b)(1)(i) or (ii) of this section.

(1)(i) For a tank that is part of an existing affected source but the tank is not used for a waste stabilization process as defined in §63.681, the owner or operator shall determine whether the tank is required to use either Tank Level 1 controls or Tank Level 2 controls as specified for the tank by Table 3 of this subpart based on the off-site material maximum HAP vapor pressure and the tank's design capacity. The owner or operator shall control air emissions from a tank required by Table 3 to use Tank Level 1 controls in accordance with the requirements of paragraph (c) of this section. The owner or operator shall control air emissions from a tank required by Table 3 to use Tank Level 2 controls in accordance with the requirements of paragraph (d) of this section.

(ii) For a tank that is part of an existing affected source but the tank is not used for a waste stabilization process as defined in §63.681, the owner or operator shall determine whether the tank is required to use either Tank Level 1 controls or Tank Level 2 controls as specified for the tank by Table 4 of this subpart based on the off-site material maximum HAP vapor pressure and the tank's design capacity. The owner or operator shall control air emissions from a tank required by Table 4 to use Tank Level 1 controls in accordance with the requirements of paragraph (c) of this section. The owner or operator shall control air emissions from a tank required by Table 4 to use Tank Level 2 controls in accordance with the requirements of paragraph (d) of this section.

(2) For a tank that is part of a new affected source but the tank is not used for a waste stabilization process as defined in §63.681, the owner or operator shall determine whether the tank is required to use either Tank Level 1 controls or Tank Level 2 controls as specified for the tank by Table 5 of this subpart based on the off-site material maximum HAP vapor pressure and the tank's design capacity. The owner or operator shall control air emissions from a tank required by Table 5 to use Tank Level 1 controls in accordance with the requirements of paragraph (c) of this section. The owner or operator shall control air emissions from a tank required by Table 5 to use Tank Level 2 controls in accordance with the requirements of paragraph (d) of this section.

(3) For a tank that is used for a waste stabilization process, the owner or operator shall control air emissions from the tank by using Tank Level 2 controls in accordance with the requirements of paragraph (d) of this section.

(c) Owners and operators controlling air emissions from a tank using Tank Level 1 controls shall meet the following requirements:

(1) The owner or operator shall determine the maximum HAP vapor pressure for an off-site material to be managed in the tank using Tank Level 1 controls before the first time the off-site material is placed in the tank. The maximum HAP vapor pressure shall be determined using the procedures specified in §63.694(j). Thereafter, the owner or operator shall perform a new determination whenever changes to the off-site material managed in the tank could potentially cause the maximum HAP vapor pressure to increase to a level that is equal to or greater than the maximum HAP vapor pressure limit for the tank design capacity category specified in Table 3, Table 4, or Table 5 of this subpart, as applicable to the tank.

(2) The owner or operator must control air emissions from the tank in accordance with the requirements in either paragraph (c)(2)(i), (c)(2)(ii), or (c)(2)(iii) of this section, as applicable to the tank.

(i) The owner or operator controls air emissions from the tank in accordance with the provisions specified in subpart OO of this part—National Emission Standards for Tanks—Level 1, except that §63.902(c)(2) and (3) shall not apply for the purposes of this subpart.

(ii) As an alternative to meeting the requirements in paragraph (c)(2)(i) of this section, an owner or operator may control air emissions from the tank in accordance with the provisions for Tank Level 2 controls as specified in paragraph (d) of this section.

(iii) As an alternative to meeting the requirements in paragraph (c)(2)(i) of this section when a tank is used as an interim transfer point to transfer off-site material from containers to another off-site material management unit, an owner or operator may control air emissions from the tank in accordance with the requirements in paragraphs (c)(2)(iii)(A) and (c)(2)(iii)(B) of this section. An example of such a tank is an in-ground tank into which organic-contaminated debris is dumped from roll-off boxes or dump trucks, and then this debris is promptly transferred from the tank to a macroencapsulation unit by a backhoe.

(A) During those periods of time when the material transfer activity is occurring, the tank may be operated without a cover.

(B) At all other times, air emissions from the tank must be controlled in accordance with the provisions specified in subpart OO of this part—National Emission Standards for Tanks—Level 1, with the exceptions specified in paragraphs (c)(2)(iii)(B)(1) and (2) of this section.

(1) Where §63.902(c)(2) provides an exception for a spring-loaded pressure-vacuum relief valve, conservation vent, or similar type of pressure relief device which vents to the atmosphere, only a conservation vent shall be eligible for the exception for the purposes of this subpart.

(2) Section 63.902(c)(3) shall not apply for the purposes of this subpart.

(d) Owners and operators controlling air emissions from a tank using Tank Level 2 controls shall use one of the following tanks:

(1) A fixed-roof tank equipped with an internal floating roof in accordance with the requirements specified in paragraph (e) of this section;

(2) A tank equipped with an external floating roof in accordance with the requirements specified in paragraph (f) of this section;

(3) A tank vented through a closed-vent system to a control device in accordance with the requirements specified in paragraph (g) of this section;

(4) A pressure tank designed and operated in accordance with the requirements specified in paragraph (h) of this section; or

(5) A tank located inside an enclosure that is vented through a closed-vent system to an enclosed combustion control device in accordance with the requirements specified in paragraph (i) of this section.

(e) The owner or operator who elects to control air emissions from a tank using a fixed-roof with an internal floating roof shall meet the requirements specified in paragraphs (e)(1) through (e)(3) of this section.

(1) The tank shall be equipped with a fixed roof and an internal floating roof in accordance with the following requirements:

(i) The internal floating roof shall be designed to float on the liquid surface except when the floating roof must be supported by the leg supports.

(ii) The internal floating roof shall be equipped with a continuous seal between the wall of the tank and the floating roof edge that meets either of the following requirements:

(A) A single continuous seal that is either a liquid-mounted seal or a metallic shoe seal, as defined in §63.681 of this subpart; or

(B) Two continuous seals mounted one above the other. The lower seal may be a vapor-mounted seal.

(iii) The internal floating roof shall meet the following specifications:

(A) Each opening in a noncontact internal floating roof except for automatic bleeder vents (vacuum breaker vents) and the rim space vents is to provide a projection below the liquid surface.

(B) Each opening in the internal floating roof shall be equipped with a gasketed cover or a gasketed lid except for leg sleeves, automatic bleeder vents, rim space vents, column wells, ladder wells, sample wells, and stub drains.

(C) Each penetration of the internal floating roof for the purpose of sampling shall have a slit fabric cover that covers at least 90 percent of the opening.

(D) Each automatic bleeder vent and rim space vent shall be gasketed.

(E) Each penetration of the internal floating roof that allows for passage of a ladder shall have a gasketed sliding cover.

(F) Each penetration of the internal floating roof that allows for passage of a column supporting the fixed roof shall have a flexible fabric sleeve seal or a gasketed sliding cover.

(2) The owner or operator shall operate the tank in accordance with the following requirements:

(i) When the floating roof is resting on the leg supports, the process of filling, emptying, or refilling shall be continuous and shall be accomplished as soon as practical.

(ii) Automatic bleeder vents are to be set closed at all times when the roof is floating, except when the roof is being floated off or is being landed on the leg supports.

(iii) Prior to filling the tank, each cover, access hatch, gauge float well or lid on any opening in the internal floating roof shall be bolted or fastened closed (i.e., no visible gaps). Rim space vents are to be set to open only when the internal floating roof is not floating or when the pressure beneath the rim exceeds the manufacturer's recommended setting.

(3) The owner or operator shall inspect the internal floating roof in accordance with the procedures specified in §63.695(b) of this subpart.

(f) The owner or operator who elects to control tank emissions by using an external floating roof shall meet the requirements specified in paragraphs (f)(1) through (f)(3) of this section.

(1) The owner or operator shall design the external floating roof in accordance with the following requirements:

(i) The external floating roof shall be designed to float on the liquid surface except when the floating roof must be supported by the leg supports.

(ii) The floating roof shall be equipped with two continuous seals, one above the other, between the wall of the tank and the roof edge. The lower seal is referred to as the primary seal, and the upper seal is referred to as the secondary seal.

(A) The primary seal shall be a liquid-mounted seal or a metallic shoe seal, as defined in §63.681 of this subpart. The total area of the gaps between the tank wall and the primary seal shall not exceed 212 square centimeters (cm²) per meter of tank diameter, and the width of any portion of these gaps shall not exceed 3.8 centimeters (cm). If a metallic shoe seal is used for the primary seal, the metallic shoe seal shall be designed so that one end extends into the liquid in the tank and the other end extends a vertical distance of at least 61 centimeters (24 inches) above the liquid surface.

(B) The secondary seal shall be mounted above the primary seal and cover the annular space between the floating roof and the wall of the tank. The total area of the gaps between the tank wall and the secondary seal shall not exceed 21.2 square centimeters (cm²) per meter of tank diameter, and the width of any portion of these gaps shall not exceed 1.3 centimeters (cm).

(iii) The external floating roof shall meet the following specifications:

(A) Except for automatic bleeder vents (vacuum breaker vents) and rim space vents, each opening in a noncontact external floating roof shall provide a projection below the liquid surface.

(B) Except for automatic bleeder vents, rim space vents, roof drains, and leg sleeves, each opening in the roof shall be equipped with a gasketed cover, seal, or lid.

(C) Each access hatch and each gauge float wells shall be equipped with covers designed to be bolted or fastened when the cover is secured in the closed position.

(D) Each automatic bleeder vent and each rim space vents shall be equipped with a gasket.

(E) Each roof drain that empties into the liquid managed in the tank shall be equipped with a slotted membrane fabric cover that covers at least 90 percent of the area of the opening.

(F) Each unslotted and slotted guide pole well shall be equipped with a gasketed sliding cover or a flexible fabric sleeve seal.

(G) Each unslotted guide pole shall be equipped with a gasketed cap on the end of the pole.

(H) Each slotted guide pole shall be equipped with a gasketed float or other device which closes off the surface from the atmosphere.

(I) Each gauge hatch and each sample well shall be equipped with a gasketed cover.

(2) The owner or operator shall operate the tank in accordance with the following requirements:

(i) When the floating roof is resting on the leg supports, the process of filling, emptying, or refilling shall be continuous and shall be accomplished as soon as practical.

(ii) Except for automatic bleeder vents, rim space vents, roof drains, and leg sleeves, each opening in the roof shall be secured and maintained in a closed position at all times except when the closure device must be open for access.

(iii) Covers on each access hatch and each gauge float well shall be bolted or fastened when secured in the closed position.

(iv) Automatic bleeder vents shall be set closed at all times when the roof is floating, except when the roof is being floated off or is being landed on the leg supports.

(v) Rim space vents shall be set to open only at those times that the roof is being floated off the roof leg supports or when the pressure beneath the rim seal exceeds the manufacturer's recommended setting.

(vi) The cap on the end of each unslotted guide pole shall be secured in the closed position at all times except when measuring the level or collecting samples of the liquid in the tank.

(vii) The cover on each gauge hatch or sample well shall be secured in the closed position at all times except when the hatch or well must be opened for access.

(viii) Both the primary seal and the secondary seal shall completely cover the annular space between the external floating roof and the wall of the tank in a continuous fashion except during inspections.

(3) The owner or operator shall inspect the external floating roof in accordance with the procedures specified in §63.695(b) of this subpart.

(g) The owner or operator who controls tank air emissions by venting to a control device shall meet the requirements specified in paragraphs (g)(1) through (g)(3) of this section.

(1) The tank shall be covered by a fixed roof and vented directly through a closed-vent system to a control device in accordance with the following requirements:

(i) The fixed roof and its closure devices shall be designed to form a continuous barrier over the entire surface area of the liquid in the tank.

(ii) Each opening in the fixed roof not vented to the control device shall be equipped with a closure device. If the pressure in the vapor headspace underneath the fixed roof is less than atmospheric pressure when the control device is operating, the closure devices shall be designed to operate such that when the closure device is secured in the closed position there are no visible cracks, holes, gaps, or other open spaces in the closure device or between the perimeter of the cover opening and the closure device. If the pressure in the vapor headspace underneath the fixed roof is equal to or greater than atmospheric

pressure when the control device is operating, the closure device shall be designed to operate with no detectable organic emissions.

(iii) The fixed roof and its closure devices shall be made of suitable materials that will minimize exposure of the off-site material to the atmosphere, to the extent practical, and will maintain the integrity of the equipment throughout its intended service life. Factors to be considered when selecting the materials for and designing the fixed roof and closure devices shall include: organic vapor permeability, the effects of any contact with the liquid and its vapor managed in the tank; the effects of outdoor exposure to wind, moisture, and sunlight; and the operating practices used for the tank on which the fixed roof is installed.

(iv) The closed-vent system and control device shall be designed and operated in accordance with the requirements of §63.693 of this subpart.

(2) Whenever an off-site material is in the tank, the fixed roof shall be installed with each closure device secured in the closed position and the vapor headspace underneath the fixed roof vented to the control device except that venting to the control device is not required, and opening of closure devices or removal of the fixed roof is allowed at the following times:

(i) To provide access to the tank for performing routine inspection, maintenance, or other activities needed for normal operations. Examples of such activities include those times when a worker needs to open a port to sample liquid in the tank, or when a worker needs to open a hatch to maintain or repair equipment. Following completion of the activity, the owner or operator shall promptly secure the closure device in the closed position or reinstall the cover, as applicable, to the tank.

(ii) To remove accumulated sludge or other residues from the bottom of the tank.

(3) The owner or operator shall inspect and monitor the air emission control equipment in accordance with the procedures specified in §63.695 of this subpart.

(h) The owner or operator who elects to control tank air emissions by using a pressure tank shall meet the following requirements.

(1) The tank shall be designed not to vent to the atmosphere as a result of compression of the vapor headspace in the tank during filling of the tank to its design capacity.

(2) All tank openings shall be equipped with closure devices designed to operate with no detectable organic emissions as determined using the procedure specified in §63.694(k) of this subpart.

(3) Whenever an off-site material is in the tank, the tank shall be operated as a closed system that does not vent to the atmosphere except at those times when purging of inerts from the tank is required and the purge stream is routed to a closed-vent system and control device designed and operated in accordance with the requirements of §63.693.

(i) The owner or operator who elects to control air emissions by using an enclosure vented through a closed-vent system to an enclosed combustion control device shall meet the requirements specified in paragraphs (i)(1) through (3) of this section.

(1) The tank shall be located inside an enclosure. The enclosure shall be designed and operated in accordance with the criteria for a permanent total enclosure as specified in "Procedure T—Criteria for and Verification of a Permanent or Temporary Total Enclosure" under 40 CFR 52.741, appendix B. The enclosure may have permanent or temporary openings to allow worker access; passage of material into or out of the enclosure by conveyor, vehicles, or other mechanical means; entry of permanent mechanical

or electrical equipment; or to direct airflow into the enclosure. The owner or operator shall perform the verification procedure for the enclosure as specified in Section 5.0 to “Procedure T—Criteria for and Verification of a Permanent or Temporary Total Enclosure” initially when the enclosure is first installed and, thereafter, annually.

(2) The enclosure shall be vented through a closed-vent system to an enclosed combustion control device that is designed and operated in accordance with the standards for either a vapor incinerator, boiler, or process heater specified in §63.693 of this subpart.

(3) The owner or operator shall inspect and monitor the closed-vent system and control device as specified in §63.693.

[61 FR 34158, July 1, 1996, as amended at 64 FR 38968, July 20, 1999; 66 FR 1266, Jan. 8, 2001; 80 FR 14273, Mar. 18, 2015]

[↑ Back to Top](#)

§63.686 Standards: Oil-water and organic-water separators.

(a) The provisions of this section apply to the control of air emissions from oil-water separators and organic-water separators for which §63.683(b)(1)(i) of this subpart references the use of this section for such air emission control.

(b) The owner or operator shall control air emissions from each separator subject to this section by using one of the following:

(1) A floating roof in accordance with all applicable provisions specified in subpart VV of this part—National Emission Standards for Oil-Water Separators and Organic-Water Separators, except that §§63.1043(c)(2), 63.1044(c)(2), and 63.1045(b)(3)(i) shall not apply for the purposes of this subpart. For portions of the separator where it is infeasible to install and operate a floating roof, such as over a weir mechanism, the owner or operator shall comply with the requirements specified in paragraph (b)(2) of this section.

(2) A fixed-roof that is vented through a closed-vent system to a control device in accordance with all applicable provisions specified in subpart VV of this part—National Emission Standards for Oil-Water Separators and Organic-Water Separators, except that §§63.1043(c)(2), 63.1044(c)(2), and 63.1045(b)(3)(i) shall not apply for the purposes of this subpart.

(3) A pressurized separator that operates as a closed system in accordance with all applicable provisions specified in subpart VV of this part—National Emission Standards for Oil-Water Separators and Organic-Water Separators, except that §§63.1043(c)(2), 63.1044(c)(2), and 63.1045(b)(3)(i) shall not apply for the purposes of this subpart.

[61 FR 34158, July 1, 1996, as amended at 64 FR 38969, July 20, 1999; 80 FR 14274, Mar. 18, 2015]

[↑ Back to Top](#)

§63.687 Standards: Surface impoundments.

(a) The provisions of this section apply to the control of air emissions from surface impoundments for which §63.683(b)(1)(i) of this subpart references the use of this section for such air emission control.

(b) The owner or operator shall control air emissions from each surface impoundment subject to this section by using one of the following:

(1) A floating membrane cover in accordance with the applicable provisions specified in subpart QQ of this part—National Emission Standards for Surface Impoundments, except that §§63.942(c)(2) and (3) and 63.943(c)(2) shall not apply for the purposes of this subpart; or

(2) A cover that is vented through a closed-vent system to a control device in accordance with all applicable provisions specified in subpart QQ of this part—National Emission Standards for Surface Impoundments, except that §§63.942(c)(2) and (3) and 63.943(c)(2) shall not apply for the purposes of this subpart.

[61 FR 34158, July 1, 1996, as amended at 64 FR 38969, July 20, 1999; 80 FR 14274, Mar. 18, 2015]

 [Back to Top](#)

§63.688 Standards: Containers.

(a) The provisions of this section apply to the control of air emissions from containers for which §63.683(b)(1)(i) of this subpart references the use of this section for such air emission control.

(b) The owner or operator shall control air emissions from each container subject to this section in accordance with the following requirements, as applicable to the container, except when the special provisions for waste stabilization processes specified in paragraph (c) of this section apply to the container.

(1) For a container having a design capacity greater than 0.1 m³ and less than or equal to 0.46 m³, the owner or operator must control air emissions from the container in accordance with the requirements in either paragraph (b)(1)(i) or (b)(1)(ii) of this section.

(i) The owner or operator controls air emissions from the container in accordance with the standards for Container Level 1 controls as specified in subpart PP of this part—National Emission Standards for Containers, except that §§63.922(d)(4) and (5) and 63.923(d)(4) and (5) shall not apply for the purposes of this subpart.

(ii) As an alternative to meeting the requirements in paragraph (b)(1)(i) of this section, an owner or operator may choose to control air emissions from the container in accordance with the standards for either Container Level 2 controls or Container Level 3 controls as specified in subpart PP of this part—National Emission Standards for Containers, except that §§63.922(d)(4) and (5) and 63.923(d)(4) and (5) shall not apply for the purposes of this subpart.

(2) For a container having a design capacity greater than 0.46 m³ and the container is not in light-material service as defined in §63.681 of this subpart, the owner or operator must control air emissions from the container in accordance with the requirements in either paragraph (b)(1)(i) or (b)(1)(ii) of this section.

(3) For a container having a design capacity greater than 0.46 m³ and the container is in light-material service as defined in §63.681 of this subpart, the owner or operator must control air emissions from the container in accordance with the requirements in either paragraph (b)(3)(i) or (b)(3)(ii) of this section.

(i) The owner or operator controls air emissions from the container in accordance with the standards for Container Level 2 controls as specified in subpart PP of this part—National Emission Standards for

Containers, except that §§63.922(d)(4) and (5) and 63.923(d)(4) and (5) shall not apply for the purposes of this subpart.

(ii) As an alternative to meeting the requirements in paragraph (b)(3)(i) of this section, an owner or operator may choose to control air emissions from the container in accordance with the standards for Container Level 3 controls as specified in 40 CFR part 63, subpart PP—National Emission Standards for Containers.

(c) When a container subject to this subpart and having a design capacity greater than 0.1 m³ is used for treatment of an off-site material by a waste stabilization process as defined in §63.681 of this subpart, the owner or operator shall control air emissions from the container at those times during the process when the off-site material in the container is exposed to the atmosphere in accordance with the standards for Container Level 3 controls as specified in 40 CFR part 63, subpart PP—National Emission Standards for Containers.

[61 FR 34158, July 1, 1996, as amended at 64 FR 38969, July 20, 1999; 80 FR 14274, Mar. 18, 2015]

 [Back to Top](#)

§63.689 Standards: Transfer systems.

(a) The provisions of this section apply to the control of air emissions from transfer systems for which §63.683(b)(1)(i) of this subpart references the use of this section for such air emission control.

(b) For each transfer system that is subject to this section and is an individual drain system, the owner or operator shall control air emissions in accordance with the standards specified in 40 CFR part 63, subpart RR—National Emission Standards for Individual Drain Systems.

(c) For each transfer system that is subject to this section but is not an individual drain system, the owner or operator shall control air emissions by using one of the transfer systems specified in paragraphs (c)(1) through (c)(3) of this section.

(1) A transfer system that uses covers in accordance with the requirements specified in paragraph (d) of this section.

(2) A transfer system that consists of continuous hard-piping. All joints or seams between the pipe sections shall be permanently or semi-permanently sealed (e.g., a welded joint between two sections of metal pipe or a bolted and gasketed flange).

(3) A transfer system that is enclosed and vented through a closed-vent system to a control device in accordance with the requirements specified in paragraphs (c)(3)(i) and (c)(3)(ii) of this section.

(i) The transfer system is designed and operated such that an internal pressure in the vapor headspace in the enclosure is maintained at a level less than atmospheric pressure when the control device is operating, and

(ii) The closed-vent system and control device are designed and operated in accordance with the requirements of §63.693 of this subpart.

(d) Owners and operators controlling air emissions from a transfer system using covers in accordance with the provisions of paragraph (c)(1) of this section shall meet the requirements specified in paragraphs (d)(1) through (d)(6) of this section.

(1) The cover and its closure devices shall be designed to form a continuous barrier over the entire surface area of the off-site material as it is conveyed by the transfer system except for the openings at the inlet and outlet to the transfer system through which the off-site material passes. The inlet and outlet openings used for passage of the off-site material through the transfer system shall be the minimum size required for practical operation of the transfer system.

(2) The cover shall be installed in a manner such that there are no visible cracks, holes, gaps, or other open spaces between cover section joints or between the interface of the cover edge and its mounting.

(3) Except for the inlet and outlet openings to the transfer system through which the off-site material passes, each opening in the cover shall be equipped with a closure device designed to operate such that when the closure device is secured in the closed position there are no visible cracks, holes, gaps, or other open spaces in the closure device or between the perimeter of the opening and the closure device.

(4) The cover and its closure devices shall be made of suitable materials that will minimize exposure of the off-site material to the atmosphere, to the extent practical, and will maintain the integrity of the equipment throughout its intended service life. Factors to be considered when selecting the materials for and designing the cover and closure devices shall include: organic vapor permeability; the effects of any contact with the material or its vapors conveyed in the transfer system; the effects of outdoor exposure to wind, moisture, and sunlight; and the operating practices used for the transfer system on which the cover is installed.

(5) Whenever an off-site material is in the transfer system, the cover shall be installed with each closure device secured in the closed position, except the opening of closure devices or removal of the cover is allowed to provide access to the transfer system for performing routine inspection, maintenance, repair, or other activities needed for normal operations. Examples of such activities include those times when a worker needs to open a hatch or remove the cover to repair conveyance equipment mounted under the cover or to clear a blockage of material inside the system. Following completion of the activity, the owner or operator shall promptly secure the closure device in the closed position or reinstall the cover, as applicable.

(6) The owner or operator shall inspect the air emission control equipment in accordance with the requirements specified in §63.695 of this subpart.

[61 FR 34158, July 1, 1996, as amended at 64 FR 38970, July 20, 1999; 80 FR 14275, Mar. 18, 2015]

 [Back to Top](#)

§63.690 Standards: Process vents.

(a) The provisions of this section apply to the control of air emissions from process vents for which §63.683(c)(1)(i) of this subpart references the use of this section for such air emission control.

(b) The owner or operator must route the vent stream from each affected process vent through a closed-vent system to a control device that meets the standards specified in §63.693 of this subpart. For the purpose of complying with this paragraph (b), a primary condenser is not a control device; however, a second condenser or other organic recovery device that is operated downstream of the primary condenser is considered a control device.

[64 FR 38970, July 20, 1999]

 [Back to Top](#)

§63.691 Standards: Equipment leaks.

(a) The provisions of this section apply to the control of air emissions from equipment leaks for which §63.683(d) references the use of this section for such air emissions control.

(b) According to the date an affected source commenced construction or reconstruction and the date an affected source receives off-site material for the first time, as established in §63.680(e)(i) through (iii), the owner or operator shall control the HAP emitted from equipment leaks in accordance with the applicable provisions specified in either paragraph (b)(1) or (2) of this section.

(1)(i) The owner or operator controls the HAP emitted from equipment leaks in accordance with §§61.241 through 61.247 in 40 CFR part 61, subpart V—National Emission Standards for Equipment Leaks, with the difference noted in paragraphs (b)(1)(iii) and (iv) of this section for the purposes of this subpart; or

(ii) The owner or operator controls the HAP emitted from equipment leaks in accordance with §§63.161 through 63.182 in subpart H of this part—National Emission Standards for Organic Hazardous Air Pollutants from Equipment Leaks, with the differences noted in paragraphs (b)(2)(i) through (iv) of this section for the purposes of this subpart.

(iii) On or after March 18, 2015, for the purpose of complying with the requirements of 40 CFR 61.242-6(a)(2) or the requirements of §63.167(a)(2), the open end is sealed when instrument monitoring of the open-ended valve or line conducted according to Method 21 of 40 CFR part 60, appendix A indicates no readings of 500 ppm or greater.

(iv) On or after March 18, 2015, for the purpose of complying with the requirements of 40 CFR 61.242-6(d) or the requirements of §63.167(d), open-ended valves or lines in an emergency shutdown system which are designed to open automatically in the event of a process upset and that are exempt from the requirements in 40 CFR 61.242-6(a), (b), and (c) or §63.167(a), (b), and (c) must comply with the requirements in §63.693(c)(2).

(2) The owner or operator controls the HAP emitted from equipment leaks in accordance with §§63.161 through 63.183 in subpart H of this part—National Emission Standards for Organic Hazardous Air Pollutants for Equipment Leaks, with the differences noted in paragraphs (b)(2)(i) through (v) of this section for the purposes of this subpart.

(i) For each valve in gas/vapor or in light liquid service, as defined in §63.681, that is part of an affected source under this subpart, an instrument reading that defines a leak is 500 ppm or greater as detected by Method 21 of 40 CFR part 60, appendix A.

(ii) For each pump in light liquid service, as defined in §63.681, that is part of an affected source under this subpart, an instrument reading that defines a leak is 1,000 ppm or greater as detected by Method 21 of 40 CFR part 60, appendix A. Repair is not required unless an instrument reading of 2,000 ppm or greater is detected.

(iii) On or after March 18, 2015, for the purpose of complying with the requirements of §63.167(a)(2), the open end is sealed when instrument monitoring of the open-ended valve or line conducted according to Method 21 of 40 CFR part 60, appendix A indicates no readings of 500 ppm or greater.

(iv) On or after March 18, 2015, for the purpose of complying with the requirements of §63.167(d), open-ended valves or lines in an emergency shutdown system which are designed to open automatically in the event of a process upset and that are exempt from the requirements in §63.167(a), (b), and (c) must comply with the requirements in §63.693(c)(2).

(v) For the purposes of this subpart, the pressure relief device requirements of §63.691(c) of this subpart rather than those of §63.165 or of 40 CFR 61.242-4, as applicable, shall apply. The pressure relief device requirements of §63.691(c)(3) and (4) apply in addition to the requirements of §63.169 or of 40 CFR 61.242-8, as applicable, for pressure relief devices in liquid service.

(c) *Requirements for pressure relief devices.* Except as provided in paragraph (c)(4) of this section, the owner or operator must comply with the requirements specified in paragraphs (c)(1) through (3) of this section for pressure relief devices in off-site material service.

(1) *Operating requirements.* Except during a pressure release event, operate each pressure relief device in gas/vapor service with an instrument reading of less than 500 ppm above background as detected by Method 21 of 40 CFR part 60, appendix A.

(2) *Pressure release requirements.* For pressure relief devices in gas/vapor service, the owner or operator must comply with either paragraph (c)(2)(i) or (ii) of this section following a pressure release, as applicable.

(i) If the pressure relief device does not consist of or include a rupture disk, the pressure relief device shall be returned to a condition indicated by an instrument reading of less than 500 ppm above background, as detected by Method 21 of 40 CFR part 60, appendix A, no later than 5 calendar days after the pressure release device returns to off-site material service following a pressure release, except as provided in §63.171.

(ii) If the pressure relief device consists of or includes a rupture disk, except as provided in §63.171, install a replacement disk as soon as practicable but no later than 5 calendar days after the pressure release.

(3) *Pressure release management.* Except as provided in paragraph (c)(4) of this section, emissions of HAP listed in Table 1 of this subpart may not be discharged directly to the atmosphere from pressure relief devices in off-site material service, and according to the date an affected source commenced construction or reconstruction and the date an affected source receives off-site material for the first time, as established in §63.680(e)(1)(i) through (iii), the owner or operator must comply with the requirements specified in paragraphs (c)(3)(i) and (ii) of this section for all pressure relief devices in off-site material service.

(i) The owner or operator must equip each pressure relief device in off-site material service with a device(s) or use a monitoring system. The device or monitoring system may be either specific to the pressure release device itself or may be associated with the process system or piping, sufficient to indicate a pressure release to the atmosphere. Examples of these types of devices or monitoring systems include, but are not limited to, a rupture disk indicator, magnetic sensor, motion detector on the pressure relief valve stem, flow monitor, pressure monitor, or parametric monitoring system. The devices or monitoring systems must be capable of meeting the requirements specified in paragraphs (c)(3)(i)(A) through (C) of this section.

(A) Identifying the pressure release;

(B) Recording the time and duration of each pressure release; and

(C) Notifying operators immediately that a pressure release is occurring.

(ii) If any pressure relief device in off-site material service releases directly to the atmosphere as a result of a pressure release event, the owner or operator must calculate the quantity of HAP listed in Table 1 of this subpart released during each pressure release event and report this quantity as required in

§63.697(b)(5). Calculations may be based on data from the pressure relief device monitoring alone or in combination with process parameter monitoring data and process knowledge.

(4) *Pressure relief devices routed to a drain system, fuel gas system, process or control device.* If a pressure relief device in off-site material service is designed and operated to route all pressure releases through a closed vent system to a drain system, fuel gas system, process or control device, paragraphs (c)(1), (2), and (3) of this section do not apply. The fuel gas system or closed vent system and the process or control device (if applicable) must meet the requirements of §63.693. The drain system (if applicable) must meet the requirements of §63.689.

[64 FR 38970, July 20, 1999, as amended at 66 FR 1266, Jan. 8, 2001; 80 FR 14275, Mar. 18, 2015]

 [Back to Top](#)

§63.692 [Reserved]

 [Back to Top](#)

§63.693 Standards: Closed-vent systems and control devices.

(a) The provisions of this section apply to closed-vent systems and control devices used to control air emissions for which another standard references the use of this section for such air emission control.

(b) For each closed-vent system and control device used to comply with this section, the owner or operator shall meet the following requirements:

(1) The owner or operator must use a closed-vent system that meets the requirements specified in paragraph (c) of this section.

(2) The owner or operator must use a control device that meets the requirements specified in paragraphs (d) through (h) of this section as applicable to the type and design of the control device selected by the owner or operator to comply with the provisions of this section.

(3) Whenever gases or vapors containing HAP are routed from a tank through a closed-vent system connected to a control device used to comply with the requirements of §63.685(b)(1), (2), or (3), the control device must be operating except as provided for in paragraphs (b)(3)(i) and (ii) of this section.

(i) The control device may only be bypassed for the purpose of performing planned routine maintenance of the closed-vent system or control device in situations when the routine maintenance cannot be performed during periods that tank emissions are vented to the control device.

(ii) On an annual basis, the total time that the closed-vent system or control device is bypassed to perform routine maintenance shall not exceed 240 hours per each calendar year.

(4) The owner or operator must inspect and monitor each closed-vent system in accordance with the requirements specified in either paragraph (b)(4)(i) or (b)(4)(ii) of this section.

(i) The owner or operator inspects and monitors the closed-vent system in accordance with the requirements specified in §63.695(c) of this subpart, and complies with the applicable recordkeeping requirements in §63.696 of this subpart and the applicable reporting requirements in §63.697 of this subpart.

(ii) As an alternative to meeting the requirements specified in paragraph (b)(4)(i) of this section, the owner or operator may choose to inspect and monitor the closed-vent system in accordance with the requirements under 40 CFR part 63, subpart H—National Emission Standards for Organic Hazardous Air Pollutants for Equipment Leaks as specified in 40 CFR 63.172(f) through (h), and complies with the applicable recordkeeping requirements in 40 CFR 63.181 and the applicable reporting requirements in 40 CFR 63.182.

(5) The owner or operator must monitor the operation of each control device in accordance with the requirements specified in paragraphs (d) through (h) of this section as applicable to the type and design of the control device selected by the owner or operator to comply with the provisions of this section.

(6) The owner or operator shall maintain records for each control device in accordance with the requirements of §63.696 of this subpart.

(7) The owner or operator shall prepare and submit reports for each control device in accordance with the requirements of §63.697 of this subpart.

(8) In the case when an owner or operator chooses to use a design analysis to demonstrate compliance of a control device with the applicable performance requirements specified in this section as provided for in paragraphs (d) through (g) of this section, the Administrator may require that the design analysis be revised or amended by the owner or operator to correct any deficiencies identified by the Administrator. If the owner or operator and the Administrator do not agree on the acceptability of using the design analysis (including any changes required by the Administrator) to demonstrate that the control device achieves the applicable performance requirements, then the disagreement must be resolved using the results of a performance test conducted by the owner or operator in accordance with the requirements of §63.694(l). The Administrator may choose to have an authorized representative observe the performance test conducted by the owner or operator. Should the results of this performance test not agree with the determination of control device performance based on the design analysis, then the results of the performance test will be used to establish compliance with this subpart.

(c) Closed-vent system requirements.

(1) The vent stream required to be controlled shall be conveyed to the control device by either of the following closed-vent systems:

(i) A closed-vent system that is designed to operate with no detectable organic emissions using the procedure specified in §63.694(k) of this subpart; or

(ii) A closed-vent system that is designed to operate at a pressure below atmospheric pressure. The system shall be equipped with at least one pressure gauge or other pressure measurement device that can be read from a readily accessible location to verify that negative pressure is being maintained in the closed-vent system when the control device is operating.

(2) In situations when the closed-vent system includes bypass devices that could be used to divert a vent stream from the closed-vent system to the atmosphere at a point upstream of the control device inlet, each bypass device must be equipped with either a flow indicator as specified in paragraph (c)(2)(i) of this section or a seal or locking device as specified in paragraph (c)(2)(ii) of this section, except as provided for in paragraph (c)(2)(iii) of this section:

(i) If a flow indicator is used, the indicator must be installed at the entrance to the bypass line used to divert the vent stream from the closed-vent system to the atmosphere. The flow indicator must indicate a reading at least once every 15 minutes. The owner or operator must maintain records of the following information: hourly records of whether the flow indicator was operating and whether flow was detected at

any time during the hour; and records of all periods when flow is detected or the flow indicator is not operating.

(ii) If a seal or locking device is used to comply with paragraph (c)(2) of this section, the device shall be placed on the mechanism by which the bypass device position is controlled (*e.g.*, valve handle, damper lever) when the bypass device is in the closed position such that the bypass device cannot be opened without breaking the seal or removing the lock. Examples of such devices include, but are not limited to, a car-seal or a lock-and-key configuration valve.

(iii) Equipment needed for safety reasons, including low leg drains, open-ended valves and lines not in emergency shutdown systems, and pressure relief devices subject to the requirements of §63.691(c) are not subject to the requirements of paragraphs (c)(2)(i) and (ii) of this section.

(d) Carbon adsorption control device requirements.

(1) The carbon adsorption system must achieve the performance specifications in either paragraph (d)(1)(i) or (d)(1)(ii) of this section.

(i) Recover 95 percent or more, on a weight-basis, of the total organic compounds (TOC), less methane and ethane, contained in the vent stream entering the carbon adsorption system; or

(ii) Recover 95 percent or more, on a weight-basis, of the total HAP listed in Table 1 of this subpart contained in the vent stream entering the carbon adsorption system.

(2) The owner or operator must demonstrate that the carbon adsorption system achieves the performance requirements in paragraph (d)(1) of this section by either performing a performance test as specified in paragraph (d)(2)(i) of this section or a design analysis as specified in paragraph (d)(2)(ii) of this section.

(i) An owner or operator choosing to use a performance test to demonstrate compliance must conduct the test in accordance with the requirements of §63.694(l) of this subpart.

(ii) An owner or operator choosing to use a design analysis to demonstrate compliance must include as part of this design analysis the information specified in either paragraph (d)(2)(ii)(A) or (d)(2)(ii)(B) of this section as applicable to the carbon adsorption system design.

(A) For a regenerable carbon adsorption system, the design analysis shall address the vent stream composition, constituent concentrations, flow rate, relative humidity, and temperature and shall establish the design exhaust vent stream organic compound concentration, adsorption cycle time, number and capacity of carbon beds, type and working capacity of activated carbon used for carbon beds, design total regeneration steam flow over the period of each complete carbon bed regeneration cycle, design carbon bed temperature after regeneration, design carbon bed regeneration time, and design service life of the carbon.

(B) For a nonregenerable carbon adsorption system (*e.g.*, a carbon canister), the design analysis shall address the vent stream composition, constituent concentrations, flow rate, relative humidity, and temperature and shall establish the design exhaust vent stream organic compound concentration, carbon bed capacity, activated carbon type and working capacity, and design carbon replacement interval based on the total carbon working capacity of the control device and emission point operating schedule.

(3) The owner or operator must monitor the operation of the carbon adsorption system in accordance with the requirements of §63.695(e) using one of the continuous monitoring systems specified in paragraphs (d)(3)(i) through (iii) of this section. Monitoring the operation of a nonregenerable

carbon adsorption system (e.g., a carbon canister) using a continuous monitoring system is not required when the carbon canister or the carbon in the control device is replaced on a regular basis according to the requirements in paragraph (d)(4)(iii) of this section.

(i) For a regenerative-type carbon adsorption system:

(A) A continuous parameter monitoring system to measure and record the average total regeneration stream mass flow or volumetric flow during each carbon bed regeneration cycle. The integrating regenerating stream flow monitoring device must have an accuracy of ± 10 percent; and

(B) A continuous parameter monitoring system to measure and record the average carbon bed temperature for the duration of the carbon bed steaming cycle and to measure the actual carbon bed temperature after regeneration and within 15 minutes of completing the cooling cycle. The accuracy of the temperature monitoring device must be ± 1 percent of the temperature being measured, expressed in degrees Celsius or ± 5 °C, whichever is greater.

(ii) A continuous monitoring system to measure and record the daily average concentration level of organic compounds in the exhaust gas stream from the control device. The organic monitoring system must comply either with Performance Specification 8 or 9 in 40 CFR part 60, appendix B. The relative accuracy provision of Performance Specification 8, Sections 2.4 and 3 need not be conducted.

(iii) A continuous monitoring system that measures other alternative operating parameters upon approval of the Administrator as specified in 40 CFR 63.8(f)(1) through (f)(5) of this part.

(4) The owner or operator shall manage the carbon used for the carbon adsorption system, as follows:

(i) Following the initial startup of the control device, all carbon in the control device shall be replaced with fresh carbon on a regular, predetermined time interval that is no longer than the carbon service life established for the carbon adsorption system. The provisions of this paragraph (d)(4)(i) do not apply to a nonregenerable carbon adsorption system (e.g., a carbon canister) for which the carbon canister or the carbon in the control device is replaced on a regular basis according to the requirements in paragraph (d)(4)(iii) of this section.

(ii) The spent carbon removed from the carbon adsorption system must be either regenerated, reactivated, or burned in one of the units specified in paragraphs (d)(4)(ii)(A) through (d)(4)(ii)(G) of this section.

(A) Regenerated or reactivated in a thermal treatment unit for which the owner or operator has been issued a final permit under 40 CFR part 270 that implements the requirements of 40 CFR part 264, subpart X.

(B) Regenerated or reactivated in a thermal treatment unit equipped with and operating air emission controls in accordance with this section.

(C) Regenerated or reactivated in a thermal treatment unit equipped with and operating organic air emission controls in accordance with a national emission standard for hazardous air pollutants under another subpart in 40 CFR part 63 or 40 CFR part 61.

(D) Burned in a hazardous waste incinerator for which the owner or operator has been issued a final permit under 40 CFR part 270 that implements the requirements of 40 CFR part 264, subpart O.

(E) Burned in a hazardous waste incinerator for which the owner or operator has designed and operates the incinerator in accordance with the interim status requirements of 40 CFR part 265, subpart O.

(F) Burned in a boiler or industrial furnace for which the owner or operator has been issued a final permit under 40 CFR part 270 that implements the requirements of 40 CFR part 266, subpart H.

(G) Burned in a boiler or industrial furnace for which the owner or operator has designed and operates the unit in accordance with the interim status requirements of 40 CFR part 266, subpart H.

(iii) As an alternative to meeting the requirements in paragraphs (d)(3) and (d)(4)(i) of this section, an owner or operator of a nonregenerable carbon adsorption system may choose to replace on a regular basis the carbon canister or the carbon in the control device using the procedures in either paragraph (d)(4)(iii)(A) or (d)(4)(iii)(B) of this section. For the purpose of complying with this paragraph (d)(4)(iii), a nonregenerable carbon adsorption system means a carbon adsorption system that does not regenerate the carbon bed directly onsite in the control device, such as a carbon canister. The spent carbon removed from the nonregenerable carbon adsorption system must be managed according to the requirements in paragraph (d)(4)(ii) of this section.

(A) Monitor the concentration level of the organic compounds in the exhaust vent from the carbon adsorption system on a regular schedule, and when carbon breakthrough is indicated, immediately replace either the existing carbon canister with a new carbon canister or replace the existing carbon in the control device with fresh carbon. Measurement of the concentration level of the organic compounds in the exhaust vent stream must be made with a detection instrument that is appropriate for the composition of organic constituents in the vent stream and is routinely calibrated to measure the organic concentration level expected to occur at breakthrough. The monitoring frequency must be daily or at an interval no greater than 20 percent of the time required to consume the total carbon working capacity established as a requirement of paragraph (d)(2)(ii)(B) of this section, whichever is longer.

(B) Replace either the existing carbon canister with a new carbon canister or replace the existing carbon in the control device with fresh carbon at a regular, predetermined time interval that is less than the design carbon replacement interval established as a requirement of paragraph (d)(2)(ii)(B) of this section.

(e) Condenser control device requirements.

(1) The condenser must achieve the performance specifications in either paragraph (e)(1)(i) or (e)(1)(ii) of this section.

(i) Recover 95 percent or more, on a weight-basis, of the total organic compounds (TOC), less methane and ethane, contained in the vent stream entering the condenser; or

(ii) Recover 95 percent or more, on a weight-basis, of the total HAP, listed in Table 1 of this subpart, contained in the vent stream entering the condenser.

(2) The owner or operator must demonstrate that the condenser achieves the performance requirements in paragraph (e)(1) of this section by either performing a performance test as specified in paragraph (e)(2)(i) of this section or a design analysis as specified in paragraph (e)(2)(ii) of this section.

(i) An owner or operator choosing to use a performance tests to demonstrate compliance must conduct the test in accordance with the requirements of §63.694(l) of this subpart.

(ii) An owner or operator choosing to use a design analysis to demonstrate compliance must include as part of this design analysis the following information: description of the vent stream composition, constituent concentrations, flow rate, relative humidity, and temperature; and specification of the design outlet organic compound concentration level, design average temperature of the condenser exhaust vent stream, and the design average temperatures of the coolant fluid at the condenser inlet and outlet.

(3) The owner or operator must monitor the operation of the condenser in accordance with the requirements of §63.695(e) of this subpart using one of the continuous monitoring systems specified in paragraphs (e)(3)(i) through (e)(3)(iii) of this section.

(i) A continuous parameter monitoring system to measure and record the daily average temperature of the exhaust gases from the control device. The accuracy of the temperature monitoring device shall be ± 1 percent of the temperature being measured, expressed in degrees Celsius or ± 5 °C, whichever is greater.

(ii) A continuous monitoring system to measure and record the daily average concentration level of organic compounds in the exhaust gas stream from the control device. The organic monitoring system must comply either with Performance Specification 8 or 9 in 40 CFR part 60, appendix B. The relative accuracy provision of Performance Specification 8, Sections 2.4 and 3 need not be conducted.

(iii) A continuous monitoring system that measures other alternative operating parameters upon approval of the Administrator as specified in 40 CFR 63.8(f)(1) through (f)(5) of this part.

(f) Vapor incinerator control device requirements.

(1) The vapor incinerator must achieve the performance specifications in either paragraph (f)(1)(i), (f)(1)(ii), or (f)(1)(iii) of this section.

(i) Destroy the total organic compounds (TOC), less methane and ethane, contained in the vent stream entering the vapor incinerator either:

(A) By 95 percent or more, on a weight-basis, or

(B) To achieve a total incinerator outlet concentration for the TOC, less methane and ethane, of less than or equal to 20 ppmv on a dry basis corrected to 3 percent oxygen.

(ii) Destroy the HAP listed in Table 1 of this subpart contained in the vent stream entering the vapor incinerator either:

(A) By 95 percent or more, on a total HAP weight-basis, or

(B) To achieve a total incinerator outlet concentration for the HAP, listed in Table 1 of this subpart, of less than or equal to 20 ppmv on a dry basis corrected to 3 percent oxygen.

(iii) Maintain the conditions in the vapor incinerator combustion chamber at a residence time of 0.5 seconds or longer and at a temperature of 760°C or higher.

(2) The owner or operator must demonstrate that the vapor incinerator achieves the performance requirements in paragraph (f)(1) of this section by conducting either a performance test as specified in paragraph (f)(2)(i) of this section or a design analysis as specified in paragraph (f)(2)(ii) of this section, except as provided for in paragraph (f)(2)(iii) of this section.

(i) An owner or operator choosing to use a performance test to demonstrate compliance must conduct the test in accordance with the requirements of §63.694(l) of this subpart.

(ii) An owner or operator choosing to use a design analysis to demonstrate compliance must include as part of this design analysis the information specified in either paragraph (f)(2)(ii)(A) or (f)(2)(ii)(B) of this section as applicable to the vapor incinerator design.

(A) For a thermal vapor incinerator, the design analysis shall address the vent stream composition, constituent concentrations, and flow rate and shall establish the design minimum and average temperatures in the combustion chamber and the combustion chamber residence time.

(B) For a catalytic vapor incinerator, the design analysis shall address the vent stream composition, constituent concentrations, and flow rate and shall establish the design minimum and average temperatures across the catalyst bed inlet and outlet, and the design service life of the catalyst.

(iii) An owner or operator is not required to conduct a performance test or design analysis if the incinerator has been issued a final permit under 40 CFR part 270 and complies with the requirements of 40 CFR part 264, subpart O, or has certified compliance with the interim status requirements of 40 CFR part 265, subpart O.

(3) The owner or operator must monitor the operation of the vapor incinerator in accordance with the requirements of §63.695(e) of this subpart using one of the continuous monitoring systems specified in paragraphs (f)(3)(i) through (f)(3)(iv) of this section as applicable to the type of vapor incinerator used.

(i) For a thermal vapor incinerator, a continuous parameter monitoring system to measure and record the daily average temperature of the exhaust gases from the control device. The accuracy of the temperature monitoring device must be ± 1 percent of the temperature being measured, expressed in degrees Celsius of ± 0.5 °C, whichever is greater.

(ii) For a catalytic vapor incinerator, a temperature monitoring device capable of monitoring temperature at two locations equipped with a continuous recorder. One temperature sensor shall be installed in the vent stream at the nearest feasible point to the catalyst bed inlet and a second temperature sensor shall be installed in the vent stream at the nearest feasible point to the catalyst bed outlet.

(iii) For either type of vapor incinerator, a continuous monitoring system to measure and record the daily average concentration of organic compounds in the exhaust vent stream from the control device. The organic monitoring system must comply either with Performance Specification 8 or 9 in 40 CFR part 60, appendix B. The relative accuracy provision of Performance Specification 8, Sections 2.4 and 3 need not be conducted.

(iv) For either type of vapor incinerator, a continuous monitoring system that measures alternative operating parameters other than those specified in paragraph (f)(3)(i) or (f)(3)(ii) of this section upon approval of the Administrator as specified in 40 CFR 63.8(f)(1) through (f)(5) of this part.

(g) Boilers and process heaters control device requirements.

(1) The boiler or process heater must achieve the performance specifications in either paragraph (g)(1)(i), (g)(1)(ii), (g)(1)(iii), (g)(1)(iv), or (g)(1)(v) of this section.

(i) Destroy the total organic compounds (TOC), less methane and ethane, contained in the vent stream introduced into the flame zone of the boiler or process heater either:

(A) By 95 percent or more, on a weight-basis, or

(B) To achieve in the exhausted combustion gases a total concentration for the TOC, less methane and ethane, of less than or equal to 20 parts ppmv on a dry basis corrected to 3 percent oxygen.

(ii) Destroy the HAP listed in Table 1 of this subpart contained in the vent stream entering the vapor incinerator either:

(A) By 95 percent or more, on a total HAP weight-basis, or

(B) To achieve in the exhausted combustion gases a total concentration for the HAP, listed in Table 1 of the subpart, of less than or equal to 20 ppmv on a dry basis corrected to 3 percent oxygen.

(iii) Introduce the vent stream into the flame zone of the boiler or process heater and maintain the conditions in the combustion chamber at a residence time of 0.5 seconds or longer and at a temperature of 760°C or higher.

(iv) Introduce the vent stream with the fuel that provides the predominate heat input to the boiler or process heater (i.e., the primary fuel); or

(v) Introduce the vent stream to a boiler or process heater for which the owner or operator either has been issued a final permit under 40 CFR part 270 and complies with the requirements of 40 CFR part 266, subpart H; or has certified compliance with the interim status requirements of 40 CFR part 266, subpart H; or has submitted a Notification of Compliance under §§63.1207(j) and 63.1210(d) and complies with the requirements of subpart EEE of this part at all times (including times when non-hazardous waste is being burned).

(2) The owner or operator must demonstrate that the boiler or process heater achieves the performance specifications in paragraph (g)(1) of this section chosen by the owner or operator using the applicable method specified in paragraph (g)(2)(i) or (g)(2)(ii) of this section.

(i) If an owner or operator chooses to comply with the performance specifications in either paragraph (g)(1)(i), (ii), or (iii) of this section, the owner or operator must demonstrate compliance with the applicable performance specifications by conducting either a performance test as specified in paragraph (g)(2)(i)(A) of this section or a design analysis as specified in paragraph (g)(2)(i)(B) of this section, except as provided for in paragraph (g)(2)(i)(C) of this section.

(A) An owner or operator choosing to use a performance test to demonstrate compliance must conduct the test in accordance with the requirements of §63.694(l) of this subpart.

(B) An owner or operator choosing to use a design analysis to demonstrate compliance must include as part of this design analysis the following information: description of the vent stream composition, constituent concentrations, and flow rate; specification of the design minimum and average flame zone temperatures and combustion zone residence time; and description of the method and location by which the vent stream is introduced into the flame zone.

(C) An owner or operator is not required to conduct a performance test or design analysis if the boiler or process heater has been issued a final permit under 40 CFR part 270 and complies with the requirements of 40 CFR part 266, subpart H; or has certified compliance with the interim status requirements of 40 CFR part 266, subpart H.

(ii) If an owner or operator chooses to comply with the performance specifications in either paragraph (g)(1)(iv) or (g)(1)(v) of this section, the owner or operator must demonstrate compliance by

maintaining the records that document that the boiler or process heater is designed and operated in accordance with the applicable requirements of this section.

(3) For a boiler or process heater complying with the performance specifications in either paragraph (g)(1)(i), (g)(1)(ii), or (g)(1)(iii) of this section, the owner or operator must monitor the operation of a boiler or process heater in accordance with the requirements of §63.695(e) of this subpart using one of the continuous monitoring systems specified in paragraphs (g)(3)(i) through (g)(3)(iii) of this section.

(i) A continuous parameter monitoring system to measure and record the daily average combustion zone temperature. The accuracy of the temperature sensor must be ± 1 percent of the temperature being measured, expressed in degrees Celsius or ± 0.5 °C, whichever is greater;

(ii) A continuous monitoring system to measure and record the daily average concentration of organic compounds in the exhaust vent stream from the control device. The organic monitoring system must comply either with Performance Specification 8 or 9 in 40 CFR part 60, appendix B. The relative accuracy provision of Performance Specification 8, Sections 2.4 and 3 need not be conducted.

(iii) A continuous monitoring system that measures alternative operating parameters other than those specified in paragraph (g)(3)(i) or (g)(3)(ii) of this section upon approval of the Administrator as specified in 40 CFR 63.8(f)(1) through (f)(5) of this part.

(h) Flare control device requirements.

(1) The flare must be designed and operated in accordance with the requirements in 40 CFR 63.11(b).

(2) The owner or operator must demonstrate that the flare achieves the requirements in paragraph (h)(1) of this section by performing the procedures specified in paragraph (h)(2)(i) of this section. A previous compliance demonstration for the flare that meets all of the conditions specified in paragraph (h)(2)(ii) of this section may be used by an owner or operator to demonstrate compliance with this paragraph (h)(2).

(i) To demonstrate that a flare achieves the requirements in paragraph (h)(1) of this section, the owner or operator performs all of the procedures specified in paragraphs (h)(2)(i)(A) through (h)(2)(i)(C) of this section.

(A) The owner or operator conducts a visible emission test for the flare in accordance with the requirements specified in 40 CFR 63.11(b)(4).

(B) The owner or operator determines the net heating value of the gas being combusted in the flare in accordance with the requirements specified in 40 CFR 63.11(b)(6); and

(C) The owner or operator determines the flare exit velocity in accordance with the requirements applicable to the flare design as specified in 40 CFR 63.11(b)(7) or 40 CFR 63.11(b)(8).

(ii) A previous compliance demonstration for the flare may be used by an owner or operator to demonstrate compliance with paragraph (h)(2) of this section provided that all conditions for the compliance determination and subsequent flare operation are met as specified in paragraphs (h)(2)(ii)(A) and (h)(2)(ii)(B) of this section.

(A) The owner or operator conducted the compliance determination using the procedures specified in paragraph (h)(2)(i) of this section.

(B) No flare operating parameter or process changes have occurred since completion of the compliance determination which could affect the compliance determination results.

(3) The owner or operator must monitor the operation of the flare using a heat sensing monitoring device (including but not limited to a thermocouple, ultraviolet beam sensor, or infrared sensor) that continuously detects the presence of a pilot flame. The owner or operator must record, for each 1-hour period, whether the monitor was continuously operating and whether a pilot flame was continuously present during each hour as required in §63.696(b)(3) of this subpart.

[64 FR 38970, July 20, 1999, as amended at 66 FR 1266, Jan. 8, 2001; 68 FR 37351, June 23, 2003; 80 FR 14276, Mar. 18, 2015]

 [Back to Top](#)

§63.694 Testing methods and procedures.

(a) This section specifies the testing methods and procedures required for this subpart to perform the following:

(1) To determine the average VOHAP concentration for off-site material streams at the point-of-delivery for compliance with standards specified §63.683 of this subpart, the testing methods and procedures are specified in paragraph (b) of this section.

(2) To determine the average VOHAP concentration for treated off-site material streams at the point-of-treatment for compliance with standards specified §63.684 of this subpart, the testing methods and procedures are specified in paragraph (c) of this section.

(3) To determine the treatment process VOHAP concentration limit (C_R) for compliance with standards specified §63.684 of this subpart, the testing methods and procedures are specified in paragraph (d) of this section.

(4) To determine treatment process required HAP removal rate (RMR) for compliance with standards specified §63.684 of this subpart, the testing methods and procedures are specified in paragraph (e) of this section.

(5) To determine treatment process actual HAP removal rate (MR) for compliance with standards specified §63.684 of this subpart, the testing methods and procedures are specified in paragraph (f) of this section.

(6) To determine treatment process required HAP reduction efficiency (R) for compliance with standards specified in §63.684 of this subpart, the testing methods and procedures are specified in paragraph (g) of this section.

(7) To determine treatment process required HAP biodegradation efficiency (R_{bio}) for compliance with standards specified in §63.684 of this subpart, the testing methods and procedures are specified in paragraph (h) of this section.

(8) To determine treatment process required actual HAP mass removal rate (MR_{bio}) for compliance with standards specified in §63.684 of this subpart, the testing methods and procedures are specified in paragraph (i) of this section.

(9) To determine maximum organic HAP vapor pressure of off-site materials in tanks for compliance with the standards specified in §63.685 of this subpart, the testing methods and procedures are specified in paragraph (j) of this section.

(10) To determine no detectable organic emissions, the testing methods and procedures are specified in paragraph (k) of this section.

(11) To determine closed-vent system and control device performance for compliance with the standards specified in §63.693 of this subpart, the testing methods and procedures are specified in paragraph (l) of this section.

(12) To determine process vent stream flow rate and total organic HAP concentration for compliance with the standards specified in §63.693 of this subpart, the testing methods and procedures are specified in paragraph (m) of this section.

(b) Testing methods and procedures to determine average VOHAP concentration of an off-site material stream at the point-of-delivery.

(1) The average VOHAP concentration of an off-site material at the point-of-delivery shall be determined using either direct measurement as specified in paragraph (b)(2) of this section or by knowledge as specified in paragraph (b)(3) of this section.

(2) *Direct measurement to determine VOHAP concentration*—(i) *Sampling*. Samples of the off-site material stream shall be collected from the container, pipeline, or other device used to deliver the off-site material stream to the plant site in a manner such that volatilization of organics contained in the sample is minimized and an adequately representative sample is collected and maintained for analysis by the selected method.

(A) The averaging period to be used for determining the average VOHAP concentration for the off-site material stream on a mass-weighted average basis shall be designated and recorded. The averaging period can represent any time interval that the owner or operator determines is appropriate for the off-site material stream but shall not exceed 1 year.

(B) A sufficient number of samples, but no less than four samples, shall be collected to represent the complete range of HAP compositions and HAP quantities that occur in the off-site material stream during the entire averaging period due to normal variations in the operating conditions for the source or process generating the off-site material stream. Examples of such normal variations are seasonal variations in off-site material quantity or fluctuations in ambient temperature.

(C) All samples shall be collected and handled in accordance with written procedures prepared by the owner or operator and documented in a site sampling plan. This plan shall describe the procedure by which representative samples of the off-site material stream are collected such that a minimum loss of organics occurs throughout the sample collection and handling process and by which sample integrity is maintained. A copy of the written sampling plan shall be maintained on-site in the plant site operating records. An example of an acceptable sampling plan includes a plan incorporating sample collection and handling procedures in accordance with the requirements specified in “Test Methods for Evaluating Solid Waste, Physical/Chemical Methods,” EPA Publication No. SW-846 or Method 25D in 40 CFR part 60, appendix A.

(ii) *Analysis*. Each collected sample must be prepared and analyzed in accordance with one of the following methods as applicable to the sampled off-site material for the purpose of measuring the HAP listed in Table 1 of this subpart:

(A) Method 305 in 40 CFR part 63, appendix A.

(B) Method 25D in 40 CFR part 60, appendix A.

(C) Method 624 in 40 CFR part 136, appendix A. If this method is used to analyze one or more compounds that are not on the method's published list of approved compounds, the Alternative Test Procedure specified in 40 CFR 136.4 and 40 CFR 136.5 must be followed.

(D) Method 625 in 40 CFR part 136, appendix A. For the purpose of using this method to comply with this subpart, the owner or operator must perform corrections to these compounds based on the "accuracy as recovery" using the factors in Table 7 of the method. If this method is used to analyze one or more compounds that are not on the method's published list of approved compounds, the Alternative Test Procedure specified in 40 CFR 136.4 and 40 CFR 136.5 must be followed.

(E) Method 1624 in 40 CFR part 136, appendix A.

(F) Method 1625 in 40 CFR part 136, appendix A.

(G) Method 8260 in "Test Methods for Evaluating Solid Waste, Physical/Chemical Methods," EPA Publication No. SW-846, Third Edition, September 1986, as amended by Update I, November 15, 1992. As an alternative, an owner or operator may use any more recent, updated version of Method 8260 approved by the EPA. For the purpose of using Method 8260 to comply with this subpart, the owner or operator must maintain a formal quality assurance program consistent with section 8 of Method 8260, and this program must include the following elements related to measuring the concentrations of volatile compounds:

(1) Documentation of site-specific procedures to minimize the loss of compounds due to volatilization, biodegradation, reaction, or sorption during the sample collection, storage, and preparation steps.

(2) Documentation of specific quality assurance procedures followed during sampling, sample preparation, sample introduction, and analysis.

(3) Measurement of the average accuracy and precision of the specific procedures, including field duplicates and field spiking of the off-site material source before or during sampling with compounds having similar chemical characteristics to the target analytes.

(H) Method 8270 in "Test Methods for Evaluating Solid Waste, Physical/Chemical Methods," EPA Publication No. SW-846, Third Edition, September 1986, as amended by Update I, November 15, 1992. As an alternative, an owner or operator may use any more recent, updated version of Method 8270 approved by the EPA. For the purpose of using Method 8270 to comply with this subpart, the owner or operator must maintain a formal quality assurance program consistent with Method 8270, and this program must include the following elements related to measuring the concentrations of volatile compounds:

(1) Documentation of site-specific procedures to minimize the loss of compounds due to volatilization, biodegradation, reaction, or sorption during the sample collection, storage, and preparation steps.

(2) Documentation of specific quality assurance procedures followed during sampling, sample preparation, sample introduction, and analysis.

(3) Measurement of the average accuracy and precision of the specific procedures, including field duplicates and field spiking of the off-site material source before or during sampling with compounds having similar chemical characteristics to the target analytes.

(I) Any other analysis method that has been validated in accordance with the procedures specified in section 5.1 and section 5.3 and the corresponding calculations in section 6.1 or section 6.3 of Method 301 in appendix A in 40 CFR part 63. The data are acceptable if they meet the criteria specified in section 6.1.5 or section 6.3.3 of Method 301. If correction is required under section 6.3.3 of Method 301, the data are acceptable if the correction factor is within the range of 0.7 to 1.30. Other sections of Method 301 are not required.

(iii) *Calculations.* The average VOHAP concentration (C) on a mass-weighted basis shall be calculated by using the results for all samples analyzed in accordance with paragraph (b)(2)(ii) of this section and the following equation. An owner or operator using a test method that provides species-specific chemical concentrations may adjust the measured concentrations to the corresponding concentration values which would be obtained had the off-site material samples been analyzed using Method 305. To adjust these data, the measured concentration for each individual HAP chemical species contained in the off-site material is multiplied by the appropriate species-specific adjustment factor (f_{m305}) listed in Table 1 of this subpart.

$$C = \frac{1}{Q_T} \times \sum_{i=1}^n (Q_i \times C_i)$$

[View or download PDF](#)

Where:

C = Average VOHAP concentration of the off-site material at the point-of-delivery on a mass-weighted basis, ppmw.

i = Individual sample "i" of the off-site material.

n = Total number of samples of the off-site material collected (at least 4) for the averaging period (not to exceed 1 year).

Q_i = Mass quantity of off-site material stream represented by C_i , kg/hr.

Q_T = Total mass quantity of off-site material during the averaging period, kg/hr.

C_i = Measured VOHAP concentration of sample "i" as determined in accordance with the requirements of §63.694(a), ppmw.

(3) Knowledge of the off-site material to determine VOHAP concentration.

(i) Documentation shall be prepared that presents the information used as the basis for the owner's or operator's knowledge of the off-site material stream's average VOHAP concentration. Examples of information that may be used as the basis for knowledge include: material balances for the source or process generating the off-site material stream; species-specific chemical test data for the off-site material stream from previous testing that are still applicable to the current off-site material stream; previous test data for other locations managing the same type of off-site material stream; or other knowledge based on information in documents such as manifests, shipping papers, or waste certification notices.

(ii) If test data are used as the basis for knowledge, then the owner or operator shall document the test method, sampling protocol, and the means by which sampling variability and analytical variability are accounted for in the determination of the average VOHAP concentration. For example, an owner or operator may use HAP concentration test data for the off-site material stream that are validated in

accordance with Method 301 in 40 CFR part 63, appendix A of this part as the basis for knowledge of the off-site material.

(iii) An owner or operator using species-specific chemical concentration test data as the basis for knowledge of the off-site material may adjust the test data to the corresponding average VOHAP concentration value which would be obtained had the off-site material samples been analyzed using Method 305. To adjust these data, the measured concentration for each individual HAP chemical species contained in the off-site material is multiplied by the appropriate species-specific adjustment factor (f_{m305}) listed in Table 1 of this subpart.

(iv) In the event that the Administrator and the owner or operator disagree on a determination of the average VOHAP concentration for an off-site material stream using knowledge, then the results from a determination of VOHAP concentration using direct measurement as specified in paragraph (b)(2) of this section shall be used to establish compliance with the applicable requirements of this subpart. The Administrator may perform or require that the owner or operator perform this determination using direct measurement.

(c) Determination of average VOHAP concentration of an off-site material stream at the point-of-treatment.

(1) *Sampling.* Samples of the off-site material stream shall be collected at the point-of-treatment in a manner such that volatilization of organics contained in the sample is minimized and an adequately representative sample is collected and maintained for analysis by the selected method.

(i) The averaging period to be used for determining the average VOHAP concentration for the off-site material stream on a mass-weighted average basis shall be designated and recorded. The averaging period can represent any time interval that the owner or operator determines is appropriate for the off-site material stream but shall not exceed 1 year.

(ii) A sufficient number of samples, but no less than four samples, shall be collected to represent the complete range of HAP compositions and HAP quantities that occur in the off-site material stream during the entire averaging period due to normal variations in the operating conditions for the treatment process. Examples of such normal variations are seasonal variations in off-site material quantity or fluctuations in ambient temperature.

(iii) All samples shall be collected and handled in accordance with written procedures prepared by the owner or operator and documented in a site sampling plan. This plan shall describe the procedure by which representative samples of the off-site material stream are collected such that a minimum loss of organics occurs throughout the sample collection and handling process and by which sample integrity is maintained. A copy of the written sampling plan shall be maintained on-site in the plant site operating records. An example of an acceptable sampling plan includes a plan incorporating sample collection and handling procedures in accordance with the requirements specified in "Test Methods for Evaluating Solid Waste, Physical/Chemical Methods," EPA Publication No. SW-846 or Method 25D in 40 CFR part 60, appendix A.

(2) *Analysis.* Each collected sample must be prepared and analyzed in accordance with one of the methods specified in paragraphs (b)(2)(ii)(A) through (b)(2)(ii)(I) of this section, as applicable to the sampled off-site material, for the purpose of measuring the HAP listed in Table 1 of this subpart.

(3) *Calculations.* The average VOHAP concentration (\bar{C}) a mass-weighted basis shall be calculated by using the results for all samples analyzed in accordance with paragraph (c)(2) of this section and the following equation. An owner or operator using a test method that provides species-specific chemical concentrations may adjust the measured concentrations to the corresponding concentration values which would be obtained had the off-site material samples been analyzed using Method 305. To adjust these

data, the measured concentration for each individual HAP chemical species contained in the off-site material is multiplied by the appropriate species-specific adjustment factor (f_{m305}) listed in Table 1 of this subpart.

$$\bar{C} = \frac{1}{Q_T} \times \sum_{i=1}^n (Q_i \times C_i)$$

[View or download PDF](#)

Where:

\bar{C} = Average VOHAP concentration of the off-site material on a mass-weighted basis, ppmw.

i = Individual sample "i" of the off-site material.

n = Total number of samples of the off-site material collected (at least 4) for the averaging period (not to exceed 1 year).

Q_i = Mass quantity of off-site material stream represented by C_i , kg/hr.

Q_T = Total mass quantity of off-site material during the averaging period, kg/hr.

C_i = Measured VOHAP concentration of sample "i" as determined in accordance with the requirements of §63.694(a), ppmw.

(d) *Determination of treatment process VOHAP concentration limit (C_R)*. (1) All of the off-site material streams entering the treatment process shall be identified.

(2) The average VOHAP concentration of each off-site material stream at the point-of-delivery shall be determined using the procedures specified in paragraph (b) of this section.

(3) The VOHAP concentration limit (C_R) shall be calculated by using the results determined for each individual off-site material stream and the following equation:

$$C_R = \frac{\sum_{x=1}^m (Q_x \times \bar{C}_x) + \sum_{y=1}^n (Q_y \times 500 \text{ ppmw})}{\sum_{x=1}^m Q_x + \sum_{y=1}^n Q_y}$$

[View or download PDF](#)

where:

C_R = VOHAP concentration limit, ppmw.

x = Individual off-site material stream "x" that has a VOHAP concentration less than 500 ppmw at the point-of-delivery.

y = Individual off-site material stream "y" that has a VOHAP concentration equal to or greater than 500 ppmw at the point-of-delivery.

m = Total number of "x" off-site material streams treated by process.

n = Total number of "y" off-site material streams treated by process.

Q_x = Total mass quantity of off-site material stream "x", kg/yr.

Q_y = Total mass quantity of off-site material stream "y", kg/yr.

\bar{C}_x = VOHAP concentration of off-site material stream "x" at the point-of-delivery, ppmw.

(e) Determination of required HAP mass removal rate (RMR).

(1) Each individual stream containing HAP that enters the treatment process shall be identified.

(2) The average VOHAP concentration at the point-of-delivery for each stream identified in paragraph (e)(1) of this section shall be determined using the test methods and procedures specified in paragraph (b) of this section.

(3) For each stream identified in paragraph (e)(1) of this section that has an average VOHAP concentration equal to or greater than 500 ppmw at the point-of-delivery, the average volumetric flow rate and the density of the off-site material stream at the point-of-delivery shall be determined.

(4) The required HAP mass removal rate (RMR) shall be calculated by using the average VOHAP concentration, average volumetric flow rate, and density determined in paragraph (e)(3) of this section for each stream and the following equation:

$$RMR = \sum_{y=1}^n \left[V_y \times k_y \times \frac{(\bar{C}_y - 500 \text{ ppmw})}{10^6} \right]$$

[View or download PDF](#)

Where:

RMR = Required HAP mass removal rate, kg/hr.

y = Individual stream "y" that has a VOHAP concentration equal to or greater than 500 ppmw at the point-of-delivery as determined in §63.694(b).

n = Total number of "y" streams treated by process.

V_y = Average volumetric flow rate of stream "y" at the point-of-delivery, m³/hr.

k_y = Density of stream "y", kg/m³.

\bar{C}_y = Average VOHAP concentration of stream "y" at the point-of-delivery as determined in §63.694(b)(2), ppmw.

(f) Determination of actual HAP mass removal rate (MR).

(1) The actual HAP mass removal rate (MR) shall be determined based on results for a minimum of three consecutive runs. The sampling time for each run shall be at least 1 hour.

(2) The HAP mass flow entering the process (E_b) and the HAP mass flow exiting the process (E_a) shall be determined using the test methods and procedures specified in paragraphs (g)(2) through (g)(4) of this section.

(3) The actual mass removal rate shall be calculated using the HAP mass flow rates determined in paragraph (f)(2) of this section and the following equation:

$$MR = E_b - E_a$$

where:

MR = Actual HAP mass removal rate, kg/hr.

E_b = HAP mass flow entering process as determined in paragraph (f)(2) of this section, kg/hr.

E_a = HAP mass flow exiting process as determined in paragraph (f)(2) of this section, kg/hr.

(g) Determination of treatment process HAP reduction efficiency (R).

(1) The HAP reduction efficiency (R) for a treatment process shall be determined based on results for a minimum of three consecutive runs.

(2) Each individual stream containing HAP that enters the treatment process shall be identified. Each individual stream containing HAP that exits the treatment process shall be identified. The owner or operator shall prepare a sampling plan for measuring the identified streams that accurately reflects the retention time of the material in the process.

(3) For each run, information shall be determined for each stream identified in paragraph (g)(2) of this section as specified in paragraphs (g)(3)(i) through (g)(3)(iii) of this section.

(i) The mass quantity shall be determined for each stream identified in paragraph (g)(2) of this section as entering the process (Q_b). The mass quantity shall be determined for each stream identified in paragraph (g)(2) of this section as exiting the process (Q_a).

(ii) The average VOHAP concentration at the point-of-delivery shall be determined for each stream entering the process (C_b) (as identified in paragraph (g)(2) of this section) using the test methods and procedures specified in paragraph (b) of this section.

(iii) The average VOHAP concentration at the point-of-treatment shall be determined for each stream exiting the process (C_a) (as identified in paragraph (g)(2) of this section) using the test methods and procedures specified in paragraph (c) of this section.

(4) The HAP mass flow entering the process (E_b) and the HAP mass flow exiting the process (E_a) shall be calculated using the results determined in paragraph (g)(3) of this section and the following equations:

$$E_a = \frac{1}{10^6} \sum_{j=1}^m (Q_{a_j} \times \overline{C_{a_j}})$$

$$E_b = \frac{1}{10^6} \sum_{j=1}^m (Q_{b_j} \times \overline{C_{b_j}})$$

[View or download PDF](#)

Where:

E_b = HAP mass flow entering process, kg/hr.

E_a = HAP mass flow exiting process, kg/hr.

m = Total number of runs (at least 3)

j = Individual run "j"

Q_{bj} = Mass quantity of material entering process during run "j", kg/hr.

Q_{aj} = Average mass quantity of material exiting process during run "j", kg/hr.

C_{aj} = Average VOHAP concentration of material exiting process during run "j" as determined in §63.694(c), ppmw.

C_{bj} = Average VOHAP concentration of material entering process during run "j" as determined in §63.694(b)(2), ppmw.

(5) The HAP reduction efficiency (R) shall be calculated using the HAP mass flow rates determined in paragraph (g)(4) of this section and the following equation:

$$R = \frac{E_b - E_a}{E_b} \times 100$$

[View or download PDF](#)

Where:

R = HAP reduction efficiency, percent.

E_b = HAP mass flow entering process as determined in paragraph (g)(4) of this section, kg/hr.

E_a = HAP mass flow exiting process as determined in accordance with the requirements of paragraph (g)(4) of this section, kg/hr.

(h) Determination of HAP biodegradation efficiency (R_{bio}).

(1) The fraction of HAP biodegraded (F_{bio}) shall be determined using one of the procedures specified in appendix C of this part 63.

(2) The HAP biodegradation efficiency (R_{bio}) shall be calculated by using the following equation:

$$R_{bio} = F_{bio} \times 100$$

where:

R_{bio} = HAP biodegradation efficiency, percent.

F_{bio} = Fraction of HAP biodegraded as determined in paragraph (h)(1) of this section.

(i) *Determination of actual HAP mass removal rate (MR_{bio})*. (1) The actual HAP mass removal rate (MR_{bio}) shall be determined based on results for a minimum of three consecutive runs. The sampling time for each run shall be at least 1 hour.

(2) The HAP mass flow entering the process (E_b) shall be determined using the test methods and procedures specified in paragraphs (g)(2) through (g)(4) of this section.

(3) The fraction of HAP biodegraded (F_{bio}) shall be determined using the procedure specified in 40 CFR part 63, appendix C of this part.

(4) The actual mass removal rate shall be calculated by using the HAP mass flow rates and fraction of HAP biodegraded determined in paragraphs (i)(2) and (i)(3), respectively, of this section and the following equation:

$$MR_{bio} = E_b \times F_{bio}$$

Where:

MR_{bio} = Actual HAP mass removal rate, kg/hr.

E_b = HAP mass flow entering process, kg/hr.

F_{bio} = Fraction of HAP biodegraded.

(j) *Determination of maximum HAP vapor pressure for off-site material in a tank.* (1) The maximum HAP vapor pressure of the off-site material composition managed in a tank shall be determined using either direct measurement as specified in paragraph (j)(2) of this section or by knowledge of the off-site material as specified by paragraph (j)(3) of this section.

(2) Direct measurement to determine the maximum HAP vapor pressure of an off-site material.

(i) Sampling. A sufficient number of samples shall be collected to be representative of the off-site material contained in the tank. All samples shall be collected and handled in accordance with written procedures prepared by the owner or operator and documented in a site sampling plan. This plan shall describe the procedure by which representative samples of the off-site material is collected such that a minimum loss of organics occurs throughout the sample collection and handling process and by which sample integrity is maintained. A copy of the written sampling plan shall be maintained on-site in the plant site operating records. An example of an acceptable sampling plan includes a plan incorporating sample collection and handling procedures in accordance with the requirements specified in "Test Methods for Evaluating Solid Waste, Physical/Chemical Methods," EPA Publication No. SW-846 or Method 25D in 40 CFR part 60, appendix A.

(ii) Analysis. Any one of the following methods may be used to analyze the samples and compute the maximum HAP vapor pressure of the off-site material:

(A) Method 25E in 40 CFR part 60 appendix A;

(B) Methods described in American Petroleum Institute Bulletin 2517, "Evaporation Loss from External Floating Roof Tanks,";

(C) Methods obtained from standard reference texts;

(D) ASTM Method 2879-83; or

(E) Any other method approved by the Administrator.

(3) *Use of knowledge to determine the maximum HAP vapor pressure of the off-site material.* Documentation shall be prepared and recorded that presents the information used as the basis

for the owner's or operator's knowledge that the maximum HAP vapor pressure of the off-site material is less than the maximum vapor pressure limit listed in Table 3, Table 4, or Table 5 of this subpart for the applicable tank design capacity category. Examples of information that may be used include: the off-site material is generated by a process for which at other locations it previously has been determined by direct measurement that the off-site material maximum HAP vapor pressure is less than the maximum vapor pressure limit for the appropriate tank design capacity category. In the event that the Administrator and the owner or operator disagree on a determination of the maximum HAP vapor pressure for an off-site material stream using knowledge, then the results from a determination of HAP vapor pressure using direct measurement as specified in paragraph (j)(2) of this section shall be used to establish compliance with the applicable requirements of this subpart. The Administrator may perform or require that the owner or operator perform this determination using direct measurement.

(k) Procedure for determining no detectable organic emissions for the purpose of complying with this subpart.

(1) The test shall be conducted in accordance with the procedures specified in Method 21 of 40 CFR part 60, appendix A. Each potential leak interface (i.e., a location where organic vapor leakage could occur) on the cover and associated closure devices shall be checked. Potential leak interfaces that are associated with covers and closure devices include, but are not limited to: the interface of the cover and its foundation mounting; the periphery of any opening on the cover and its associated closure device; and the sealing seat interface on a spring-loaded pressure-relief valve.

(2) The test shall be performed when the unit contains a material having a total organic concentration representative of the range of concentrations for the materials expected to be managed in the unit. During the test, the cover and closure devices shall be secured in the closed position.

(3) The detection instrument shall meet the performance criteria of Method 21 of 40 CFR part 60, appendix A, except the instrument response factor criteria in section 8.1.1 of Method 21 shall be for the weighted average composition of the organic constituents in the material placed in the unit at the time of monitoring, not for each individual organic constituent.

(4) The detection instrument shall be calibrated before use on each day of its use by the procedures specified in Method 21 of 40 CFR part 60, appendix A.

(5) Calibration gases shall be as follows:

(i) Zero air (less than 10 ppmv hydrocarbon in air); and

(ii) A mixture of methane or n-hexane in air at a concentration of approximately, but less than, 10,000 ppmv.

(6) An owner or operator may choose to adjust or not adjust the detection instrument readings to account for the background organic concentration level. If an owner or operator chooses to adjust the instrument readings for the background level, the background level value must be determined according to the procedures in Method 21 of 40 CFR part 60, appendix A.

(7) Each potential leak interface shall be checked by traversing the instrument probe around the potential leak interface as close to the interface as possible, as described in Method 21. In the case when the configuration of the cover or closure device prevents a complete traverse of the interface, all accessible portions of the interface shall be sampled. In the case when the configuration of the closure device prevents any sampling at the interface and the device is equipped with an enclosed extension or horn (e.g., some pressure relief devices), the instrument probe inlet shall be placed at approximately the center of the exhaust area to the atmosphere.

(8) An owner or operator must determine if a potential leak interface operates with no detectable emissions using the applicable procedure specified in paragraph (k)(8)(i) or (k)(8)(ii) of this section.

(i) If an owner or operator chooses not to adjust the detection instrument readings for the background organic concentration level, then the maximum organic concentration value measured by the detection instrument is compared directly to the applicable value for the potential leak interface as specified in paragraph (k)(9) of this section.

(ii) If an owner or operator chooses to adjust the detection instrument readings for the background organic concentration level, the value of the arithmetic difference between the maximum organic concentration value measured by the instrument and the background organic concentration value as determined in paragraph (k)(6) of this section is compared with the applicable value for the potential leak interface as specified in paragraph (k)(9) of this section.

(9) A potential leak interface is determined to operate with no detectable emissions using the applicable criteria specified in paragraphs (k)(9)(i) and (k)(9)(ii) of this section.

(i) For a potential leak interface other than a seal around a shaft that passes through a cover opening, the potential leak interface is determined to operate with no detectable organic emissions if the organic concentration value determined in paragraph (k)(8) is less than 500 ppmv.

(ii) For a seal around a shaft that passes through a cover opening, the potential leak interface is determined to operate with no detectable organic emissions if the organic concentration value determined in paragraph (k)(8) is less than 10,000 ppmv.

(l) *Control device performance test procedures.* Performance tests shall be based on representative performance (*i.e.*, performance based on normal operating conditions) and shall exclude periods of startup and shutdown unless specified by the Administrator. The owner or operator may not conduct performance tests during periods of malfunction. The owner or operator must record the process information that is necessary to document operating conditions during the test and include in such record an explanation to support that such conditions represent normal operation. Upon request, the owner or operator shall make available to the Administrator such records as may be necessary to determine the conditions of performance tests.

(1) Method 1 or 1A of 40 CFR part 60, appendix A, as appropriate, shall be used for selection of the sampling sites at the inlet and outlet of the control device.

(i) To determine compliance with a control device percent reduction requirement, sampling sites shall be located at the inlet of the control device as specified in paragraphs (l)(1)(i)(A) and (l)(1)(i)(B) of this section, and at the outlet of the control device.

(A) The control device inlet sampling site shall be located after the final product recovery device.

(B) If a vent stream is introduced with the combustion air or as an auxiliary fuel into a boiler or process heater, the location of the inlet sampling sites shall be selected to ensure that the measurement of total HAP concentration or TOC concentration, as applicable, includes all vent streams and primary and secondary fuels introduced into the boiler or process heater.

(ii) To determine compliance with an enclosed combustion device concentration limit, the sampling site shall be located at the outlet of the device.

(2) The gas volumetric flow rate shall be determined using Method 2, 2A, 2C, or 2D, 2F, or 2G of 40 CFR part 60, appendix A, as appropriate.

(3) To determine compliance with the control device percent reduction requirement, the owner or operator shall use Method 18 of 40 CFR part 60, appendix A to measure the HAP in Table 1 of this subpart or Method 25A of 40 CFR part 60, appendix A to measure TOC. Method 18 may be used to measure methane and ethane, and the measured concentration may be subtracted from the Method 25A measurement. Alternatively, any other method or data that has been validated according to the applicable procedures in Method 301 in appendix A of this part may be used. The following procedures shall be used to calculate percent reduction efficiency:

(i) A minimum of three sample runs must be performed. The minimum sampling time for each run shall be 1 hour. For Method 18, either an integrated sample or a minimum of four grab samples shall be taken. If grab sampling is used, then the samples shall be taken at approximately equal intervals in time such as 15 minute intervals during the run.

(ii) The mass rate of either TOC (minus methane and ethane) or total HAP (E_i and E_o , respectively) shall be computed.

(A) The following equations shall be used:

$$E_i = K_2 \times Q_i \times \sum_{j=1}^n (C_{ij} \times M_{ij})$$

$$E_o = K_2 \times Q_o \times \sum_{j=1}^n (C_{oj} \times M_{oj})$$

[View or download PDF](#)

Where:

C_i , C_o = Concentration of sample component j of the gas stream at the inlet and outlet of the control device, respectively, dry basis, parts per million by volume.

E_i , E_o = Mass rate of TOC (minus methane and ethane) or total HAP at the inlet and outlet of the control device, respectively, dry basis, kilogram per hour.

M_i , M_o = Molecular weight of sample component j of the gas stream at the inlet and outlet of the control device, respectively, gram/gram-mole.

Q_i , Q_o = Flow rate of gas stream at the inlet and outlet of the control device, respectively, dry standard cubic meter per minute.

K_2 = Constant, 2.494×10^{-6} (parts per million)⁻¹ (gram-mole per standard cubic meter) (kilogram/gram) (minute/hour), where standard temperature (gram-mole per standard cubic meter) is 20 °C.

(B) When the TOC mass rate is calculated, the average concentration reading (minus methane and ethane) measured by Method 25A of 40 CFR part 60, appendix A shall be used in the equation in paragraph (l)(3)(ii)(A) of this section.

(C) When the total HAP mass rate is calculated, only the HAP constituents shall be summed using the equation in paragraph (l)(3)(ii)(A) of this section.

(iii) The percent reduction in TOC (minus methane and ethane) or total HAP shall be calculated as follows:

$$R_{cd} = \frac{E_i - E_o}{E_i} \times 100$$

[View or download PDF](#)

where:

R_{cd} = Control efficiency of control device, percent.

E_i = Mass rate of TOC (minus methane and ethane) or total HAP at the inlet to the control device as calculated under paragraph (l)(3)(ii) of this section, kilograms TOC per hour or kilograms HAP per hour.

E_o = Mass rate of TOC (minus methane and ethane) or total HAP at the outlet of the control device, as calculated under paragraph (l)(3)(ii) of this section, kilograms TOC per hour or kilograms HAP per hour.

(iv) If the vent stream entering a boiler or process heater is introduced with the combustion air or as a secondary fuel, the weight-percent reduction of total HAP or TOC (minus methane and ethane) across the device shall be determined by comparing the TOC (minus methane and ethane) or total HAP in all combusted vent streams and primary and secondary fuels with the TOC (minus methane and ethane) or total HAP exiting the device, respectively.

(4) To determine compliance with the enclosed combustion device total HAP concentration limit of this subpart, the owner or operator shall use Method 18 of 40 CFR part 60, appendix A to measure the total HAP in Table 1 of this subpart or Method 25A of 40 CFR part 60, appendix A to measure TOC. Method 18 may be used to measure methane and ethane and the measured concentration may be subtracted from the Method 25A measurement. Alternatively, any other method or data that has been validated according to Method 301 in appendix A of this part, may be used. The following procedures shall be used to calculate parts per million by volume concentration, corrected to 3 percent oxygen:

(i) A minimum of three sample runs must be performed. The minimum sampling time for each run shall be 1 hour. For Method 18, either an integrated sample or a minimum of four grab samples shall be taken. If grab sampling is used, then the samples shall be taken at approximately equal intervals in time, such as 15 minute intervals during the run.

(ii) The TOC concentration or total HAP concentration shall be calculated according to paragraph (m)(4)(ii)(A) or (m)(4)(ii)(B) of this section.

(A) The TOC concentration (C_{TOC}) is the average concentration readings provided by Method 25 A of 40 CFR part 60, appendix A, minus the concentration of methane and ethane.

(B) The total HAP concentration (C_{HAP}) shall be computed according to the following equation:

$$C_{HAP} = \sum_{i=1}^x \frac{\sum_{j=1}^n C_{ji}}{x}$$

[View or download PDF](#)

where:

C_{HAP} = Total concentration of HAP compounds listed in Table 1 of this subpart, dry basis, parts per million by volume.

C_{ji} = Concentration of sample components j of sample i, dry basis, parts per million by volume.

n = Number of components in the sample.

x = Number of samples in the sample run.

(iii) The measured TOC concentration or total HAP concentration shall be corrected to 3 percent oxygen as follows:

(A) The emission rate correction factor or excess air, integrated sampling and analysis procedures of Method 3B of 40 CFR part 60, appendix A shall be used to determine the oxygen concentration (%O_{2dry}). Alternatively, the owner or operator may use Method 3A of 40 CFR part 60, appendix A to determine the oxygen concentration. The samples shall be collected during the same time that the samples are collected for determining TOC concentration or total HAP concentration.

(B) The concentration corrected to 3 percent oxygen (C_c) shall be computed using the following equation:

$$C_c = C_m \left(\frac{17.9}{20.9 - \%O_{2dry}} \right)$$

[View or download PDF](#)

where:

C_c = TOC concentration or total HAP concentration corrected to 3 percent oxygen, dry basis, parts per million by volume.

C_m = Measured TOC concentration or total HAP concentration, dry basis, parts per million by volume.

%O_{2dry} = Concentration of oxygen, dry basis, percent by volume.

(m) Determination of process vent stream flow rate and total HAP concentration.

(1) Method 1 or 1A of 40 CFR part 60, appendix A, as appropriate, must be used for selection of the sampling site.

(2) No traverse site selection method is needed for vents smaller than 0.10 meter in diameter. For vents smaller than 0.10 meter in diameter, sample at the center of the vent.

(3) Process vent stream gas volumetric flow rate must be determined using Method 2, 2A, 2C, 2D, 2F, or 2G of 40 CFR part 60, appendix A, as appropriate.

(4) Process vent stream total HAP concentration must be measured using the following procedures:

(i) Method 18 of 40 CFR part 60, appendix A, must be used to measure the total HAP concentration. Alternatively, any other method or data that has been validated according to the protocol in Method 301 of appendix A of this part may be used.

(ii) Where Method 18 of 40 CFR part 60, appendix A, is used, the following procedures must be used to calculate parts per million by volume concentration:

(A) The minimum sampling time for each run must be 1 hour in which either an integrated sample or four grab samples must be taken. If grab sampling is used, then the samples must be taken at approximately equal intervals in time, such as 15 minute intervals during the run.

(B) The total HAP concentration (C_{HAP}) must be computed according to the following equation:

$$C_{\text{HAP}} = \frac{\sum_{i=1}^x \left(\sum_{j=1}^n C_{ij} \right)}{X}$$

[View or download PDF](#)

Where:

C_{HAP} = Total concentration of HAP compounds listed in Table 1 of this subpart, dry basis, parts per million by volume.

C_{ij} = Concentration of sample component j of the sample i , dry basis, parts per million by volume.

n = Number of components in the sample.

x = Number of samples in the sample run.

[61 FR 34158, July 1, 1996, as amended at 64 FR 38974, July 20, 1999; 66 FR 1267, Jan. 8, 2001; 80 FR 14277, Mar. 18, 2015]

[↑ Back to Top](#)

§63.695 Inspection and monitoring requirements.

(a) The owner or operator must install, calibrate, maintain, and operate all monitoring system components according to §§63.8, 63.684(e), 63.693(d)(3), (e)(3), (f)(3), (g)(3), and (h)(3), and paragraph (a)(5) of this section and perform the inspection and monitoring procedures specified in paragraphs (a)(1) through (4) of this section.

(1) To inspect tank fixed roofs and floating roofs for compliance with the Tank Level 2 controls standards specified in §63.685 of this subpart, the inspection procedures are specified in paragraph (b) of this section.

(2) To inspect and monitor closed-vent systems for compliance with the standards specified in §63.693 of this subpart, the inspection and monitoring procedures are specified in paragraph (c) of this section.

(3) To inspect and monitor transfer system covers for compliance with the standards specified in §63.689(c)(1) of this subpart, the inspection and monitoring procedures are specified in paragraph (d) of this section.

(4) To monitor and record off-site material treatment processes for compliance with the standards specified in 63.684(e), the monitoring procedures are specified in paragraph (e) of this section.

(5)(i) Except for periods of monitoring system malfunctions, repairs associated with monitoring system malfunctions and required monitoring system quality assurance or quality control activities (including, as applicable, calibration checks and required zero and span adjustments), the owner or operator must operate the continuous monitoring system at all times the affected source is operating. A

monitoring system malfunction is any sudden, infrequent, not reasonably preventable failure of the monitoring system to provide data. Monitoring system failures that are caused in part by poor maintenance or careless operation are not malfunctions. The owner or operator is required to complete monitoring system repairs in response to monitoring system malfunctions and to return the monitoring system to operation as expeditiously as practicable.

(ii) The owner or operator may not use data recorded during monitoring system malfunctions, repairs associated with monitoring system malfunctions, or required monitoring system quality assurance or control activities in calculations used to report emissions or operating levels. The owner or operator must use all the data collected during all other required data collection periods in assessing the operation of the control device and associated control system. The owner or operator must report any periods for which the monitoring system failed to collect required data.

(b) Tank Level 2 fixed roof and floating roof inspection requirements.

(1) Owners and operators that use a tank equipped with an internal floating roof in accordance with the provisions of §63.685(e) of this subpart shall meet the following inspection requirements:

(i) The floating roof and its closure devices shall be visually inspected by the owner or operator to check for defects that could result in air emissions. Defects include, but are not limited to, the internal floating roof is not floating on the surface of the liquid inside the tank; liquid has accumulated on top of the internal floating roof; any portion of the roof seals have detached from the roof rim; holes, tears, or other openings are visible in the seal fabric; the gaskets no longer close off the waste surfaces from the atmosphere; or the slotted membrane has more than 10 percent open area.

(ii) The owner or operator shall inspect the internal floating roof components as follows except as provided for in paragraph (b)(1)(iii) of this section:

(A) Visually inspect the internal floating roof components through openings on the fixed-roof (e.g., manholes and roof hatches) at least once every calendar year after initial fill, and

(B) Visually inspect the internal floating roof, primary seal, secondary seal (if one is in service), gaskets, slotted membranes, and sleeve seals (if any) each time the tank is emptied and degassed and at least every 10 years. Prior to each inspection, the owner or operator shall notify the Administrator in accordance with the reporting requirements specified in §63.697 of this subpart.

(iii) As an alternative to performing the inspections specified in paragraph (b)(1)(ii) of this section for an internal floating roof equipped with two continuous seals mounted one above the other, the owner or operator may visually inspect the internal floating roof, primary and secondary seals, gaskets, slotted membranes, and sleeve seals (if any) each time the tank is emptied and degassed and at least every 5 years. Prior to each inspection, the owner or operator shall notify the Administrator in accordance with the reporting requirements specified in §63.697 of this subpart.

(iv) In the event that a defect is detected, the owner or operator shall repair the defect in accordance with the requirements of paragraph (b)(4) of this section.

(v) The owner or operator shall maintain a record of the inspection in accordance with the requirements specified in §63.696 of this subpart.

(2) Owners and operators that use a tank equipped with an external floating roof in accordance with the provisions of §63.685(f) of this subpart shall meet the following requirements:

(i) The owner or operator shall measure the external floating roof seal gaps in accordance with the following requirements:

(A) The owner or operator shall perform measurements of gaps between the tank wall and the primary seal within 60 days after initial operation of the tank following installation of the floating roof and, thereafter, at least once every 5 years. Prior to each inspection, the owner or operator shall notify the Administrator in accordance with the reporting requirements specified in §63.697 of this subpart.

(B) The owner or operator shall perform measurements of gaps between the tank wall and the secondary seal within 60 days after initial operation of the separator following installation of the floating roof and, thereafter, at least once every year. Prior to each inspection, the owner or operator shall notify the Administrator in accordance with the reporting requirements specified in §63.697 of this subpart.

(C) If a tank ceases to hold off-site material for a period of 1 year or more, subsequent introduction of off-site material into the tank shall be considered an initial operation for the purposes of paragraphs (b)(2)(i)(A) and (b)(2)(i)(B) of this section.

(D) The owner shall determine the total surface area of gaps in the primary seal and in the secondary seal individually using the following procedure.

(1) The seal gap measurements shall be performed at one or more floating roof levels when the roof is floating off the roof supports.

(2) Seal gaps, if any, shall be measured around the entire perimeter of the floating roof in each place where a 0.32-centimeter (cm) ($\frac{1}{8}$ -inch) diameter uniform probe passes freely (without forcing or binding against the seal) between the seal and the wall of the tank and measure the circumferential distance of each such location.

(3) For a seal gap measured under paragraph (b)(2) of this section, the gap surface area shall be determined by using probes of various widths to measure accurately the actual distance from the tank wall to the seal and multiplying each such width by its respective circumferential distance.

(4) The total gap area shall be calculated by adding the gap surface areas determined for each identified gap location for the primary seal and the secondary seal individually, and then dividing the sum for each seal type by the nominal diameter of the tank. These total gap areas for the primary seal and secondary seal are then compared to the respective standards for the seal type as specified in §63.685(f)(1) of this subpart.

(E) In the event that the seal gap measurements do not conform to the specifications in §63.685(f)(1) of this subpart, the owner or operator shall repair the defect in accordance with the requirements of paragraph (b)(4) of this section.

(F) The owner or operator shall maintain a record of the inspection in accordance with the requirements specified in §63.696 of this subpart.

(ii) The owner or operator shall visually inspect the external floating roof in accordance with the following requirements:

(A) The floating roof and its closure devices shall be visually inspected by the owner or operator to check for defects that could result in air emissions. Defects include, but are not limited to: holes, tears, or other openings in the rim seal or seal fabric of the floating roof; a rim seal detached from the floating roof; all or a portion of the floating roof deck being submerged below the surface of the liquid in the tank;

broken, cracked, or otherwise damaged seals or gaskets on closure devices; and broken or missing hatches, access covers, caps, or other closure devices.

(B) The owner or operator shall perform the inspections following installation of the external floating roof and, thereafter, at least once every year.

(C) In the event that a defect is detected, the owner or operator shall repair the defect in accordance with the requirements of paragraph (b)(4) of this section.

(D) The owner or operator shall maintain a record of the inspection in accordance with the requirements specified in §63.696(d) of this subpart.

(3) Owners and operators that use a tank equipped with a fixed roof in accordance with the provisions of §63.685(g) of this subpart shall meet the following requirements:

(i) The fixed roof and its closure devices shall be visually inspected by the owner or operator to check for defects that could result in air emissions. Defects include, but are not limited to, visible cracks, holes, or gaps in the roof sections or between the roof and the separator wall; broken, cracked, or otherwise damaged seals or gaskets on closure devices; and broken or missing hatches, access covers, caps, or other closure devices. In the case when a tank is buried partially or entirely underground, inspection is required only for those portions of the cover that extend to or above the ground surface, and those connections that are on such portions of the cover (e.g., fill ports, access hatches, gauge wells, etc.) and can be opened to the atmosphere.

(ii) The owner or operator must perform an initial inspection following installation of the fixed roof. Thereafter, the owner or operator must perform the inspections at least once every calendar year except as provided for in paragraph (f) of this section.

(iii) In the event that a defect is detected, the owner or operator shall repair the defect in accordance with the requirements of paragraph (b)(4) of this section.

(iv) The owner or operator shall maintain a record of the inspection in accordance with the requirements specified in §63.696(e) of this subpart.

(4) The owner or operator shall repair each defect detected during an inspection performed in accordance with the requirements of paragraph (b)(1), (b)(2), or (b)(3) of this section in the following manner:

(i) The owner or operator shall within 45 calendar days of detecting the defect either repair the defect or empty the tank and remove it from service. If within this 45-day period the defect cannot be repaired or the tank cannot be removed from service without disrupting operations at the plant site, the owner or operator is allowed two 30-day extensions. In cases when an owner or operator elects to use a 30-day extension, the owner or operator shall prepare and maintain documentation describing the defect, explaining why alternative storage capacity is not available, and specify a schedule of actions that will ensure that the control equipment will be repaired or the tank emptied as soon as possible.

(ii) When a defect is detected during an inspection of a tank that has been emptied and degassed, the owner or operator shall repair the defect before refilling the tank.

(c) Owners and operators that use a closed-vent system in accordance with the provisions of §63.693 of this subpart shall meet the following inspection and monitoring requirements:

(1) Each closed-vent system that is used to comply with §63.693(c)(1)(i) of this subpart shall be inspected and monitored in accordance with the following requirements:

(i) At initial startup, the owner or operator shall monitor the closed-vent system components and connections using the procedures specified in §63.694(k) of this subpart to demonstrate that the closed-vent system operates with no detectable organic emissions.

(ii) After initial startup, the owner or operator shall inspect and monitor the closed-vent system as follows:

(A) Closed-vent system joints, seams, or other connections that are permanently or semi-permanently sealed (e.g., a welded joint between two sections of hard piping or a bolted and gasketed ducting flange) shall be visually inspected at least once per year to check for defects that could result in air emissions. The owner or operator shall monitor a component or connection using the procedures specified in §63.694(k) of this subpart to demonstrate that it operates with no detectable organic emissions following any time the component is repaired or replaced (e.g., a section of damaged hard piping is replaced with new hard piping) or the connection is unsealed (e.g., a flange is unbolted).

(B) Closed-vent system components or connections other than those specified in paragraph (c)(1)(ii)(A) of this section, shall be monitored at least once per year using the procedures specified in §63.694(k) of this subpart to demonstrate that components or connections operate with no detectable organic emissions.

(C) The continuous monitoring system required by §63.693(b)(4)(i) shall monitor and record either an instantaneous data value at least once every 15 minutes or an average value for intervals of 15 minutes or less.

(D) The owner or operator shall visually inspect the seal or closure mechanism required by §63.693(c)(2)(ii) at least once every month to verify that the bypass mechanism is maintained in the closed position.

(iii) In the event that a defect or leak is detected, the owner or operator shall repair the defect or leak in accordance with the requirements of paragraph (c)(3) of this section.

(iv) The owner or operator shall maintain a record of the inspection and monitoring in accordance with the requirements specified in §63.696 of this subpart.

(2) Each closed-vent system that is used to comply with §63.693(c)(1)(ii) of this subpart shall be inspected and monitored in accordance with the following requirements:

(i) The closed-vent system shall be visually inspected by the owner or operator to check for defects that could result in air emissions. Defects include, but are not limited to, visible cracks, holes, or gaps in ductwork or piping; loose connections; or broken or missing caps or other closure devices.

(ii) The owner or operator must perform an initial inspection following installation of the closed-vent system. Thereafter, the owner or operator must perform the inspections at least once every calendar year except as provided for in paragraph (f) of this section.

(iii) In the event that a defect is detected, the owner or operator shall repair the defect in accordance with the requirements of paragraph (c)(3) of this section.

(iv) The owner or operator shall maintain a record of the inspection in accordance with the requirements specified in §63.696 of this subpart.

(3) The owner or operator shall repair all detected defects as follows:

(i) The owner or operator shall make first efforts at repair of the defect no later than 5 calendar days after detection and repair shall be completed as soon as possible but no later than 45 calendar days after detection.

(ii) Repair of a defect may be delayed beyond 45 calendar days if either of the conditions specified in paragraph (c)(3)(ii)(A) or (c)(3)(ii)(B) occurs. In this case, the owner or operator must repair the defect the next time the process or unit that vents to the closed-vent system is shutdown. Repair of the defect must be completed before the process or unit resumes operation.

(A) Completion of the repair is technically infeasible without the shutdown of the process or unit that vents to the closed-vent system.

(B) The owner or operator determines that the air emissions resulting from the repair of the defect within the specified period would be greater than the fugitive emissions likely to result by delaying the repair until the next time the process or unit that vents to the closed-vent system is shutdown.

(iii) The owner or operator shall maintain a record of the defect repair in accordance with the requirements specified in §63.696 of this subpart.

(d) Owners and operators that use a transfer system equipped with a cover in accordance with the provisions of §63.689(c)(1) of this subpart shall meet the following inspection requirements:

(1) The cover and its closure devices shall be visually inspected by the owner or operator to check for defects that could result in air emissions. Defects include, but are not limited to, visible cracks, holes, or gaps in the cover sections or between the cover and its mounting; broken, cracked, or otherwise damaged seals or gaskets on closure devices; and broken or missing hatches, access covers, caps, or other closure devices. In the case when a transfer system is buried partially or entirely underground, inspection is required only for those portions of the cover that extend to or above the ground surface, and those connections that are on such portions of the cover (e.g., access hatches, etc.) and can be opened to the atmosphere.

(2) The owner or operator must perform an initial inspection following installation of the cover. Thereafter, the owner or operator must perform the inspections at least once every calendar year except as provided for in paragraph (f) of this section.

(3) In the event that a defect is detected, the owner or operator shall repair the defect in accordance with the requirements of paragraph (d)(5) of this section.

(4) The owner or operator shall maintain a record of the inspection in accordance with the requirements specified in §63.696 of this subpart.

(5) The owner or operator shall repair all detected defects as follows:

(i) The owner or operator shall make first efforts at repair of the defect no later than 5 calendar days after detection and repair shall be completed as soon as possible but no later than 45 calendar days after detection except as provided in paragraph (d)(5)(ii) of this section.

(ii) Repair of a defect may be delayed beyond 45 calendar days if the owner or operator determines that repair of the defect requires emptying or temporary removal from service of the transfer system and no alternative transfer system is available at the site to accept the material normally handled by the system. In this case, the owner or operator shall repair the defect the next time the process or unit that is

generating the material handled by the transfer system stops operation. Repair of the defect must be completed before the process or unit resumes operation.

(iii) The owner or operator shall maintain a record of the defect repair in accordance with the requirements specified in §63.696 of this subpart.

(e) *Control device monitoring requirements.* For each control device required under §63.693 to be monitored in accordance with the provisions of this paragraph (e), the owner or operator must ensure that each control device operates properly by monitoring the control device in accordance with the requirements specified in paragraphs (e)(1) through (5) of this section.

(1) A continuous parameter monitoring system must be used to measure the operating parameter or parameters specified for the control device in §63.693(d) through §63.693(g) of this subpart as applicable to the type and design of the control device. The continuous parameter monitoring system must meet the following specifications and requirements:

(i) The continuous parameter monitoring system must measure either an instantaneous value at least once every 15 minutes or an average value for intervals of 15 minutes or less and continuously record either:

(A) Each measured data value; or

(B) Each block average value for each 1-hour period or shorter periods calculated from all measured data values during each period. If values are measured more frequently than once per minute, a single value for each minute may be used to calculate the hourly (or shorter period) block average instead of all measured values.

(ii) The monitoring system must be installed, calibrated, operated, and maintained in accordance with the manufacturer's specifications or other written procedures that provide reasonable assurance that the monitoring equipment is operating properly.

(2) Using the data recorded by the monitoring system, the owner or operator must calculate the daily average value for each monitored operating parameter for each operating day. If operation of the control device is continuous, the operating day is a 24-hour period. If control device operation is not continuous, the operating day is the total number of hours of control device operation per 24-hour period. Valid data points must be available for 75 percent of the operating hours in an operating day to compute the daily average.

(3) For each monitored operating parameter, the owner or operator must establish a minimum operating parameter value or a maximum operating parameter value, as appropriate, to define the range of conditions at which the control device must be operated to continuously achieve the applicable performance requirements specified in §63.693(b)(2) of this subpart. Each minimum or maximum operating parameter value must be established in accordance with the requirements in paragraphs (e)(3)(i) and (e)(3)(ii) of this section.

(i) If the owner or operator conducts a performance test to demonstrate control device performance, then the minimum or maximum operating parameter value must be established based on values measured during the performance test and supplemented, as necessary, by the control device design specifications, manufacturer recommendations, or other applicable information.

(ii) If the owner or operator uses a control device design analysis to demonstrate control device performance, then the minimum or maximum operating parameter value must be established based on

the control device design analysis and supplemented, as necessary, by the control device manufacturer recommendations or other applicable information.

(4) A deviation for a given control device is determined to have occurred when the monitoring data or lack of monitoring data result in any one of the criteria specified in paragraphs (e)(4)(i) through (iii) of this section being met. When multiple operating parameters are monitored for the same control device and during the same operating day more than one of these operating parameters meets a deviation criterion specified in paragraphs (e)(4)(i) through (iii) of this section, then a single deviation is determined to have occurred for the control device for that operating day.

(i) A deviation occurs when the daily average value of a monitored operating parameter is less than the minimum operating parameter limit (or, if applicable, greater than the maximum operating parameter limit) established for the operating parameter in accordance with the requirements of paragraph (e)(3) of this section.

(ii) A deviation occurs when the period of control device operation is 4 hours or greater in an operating day and the monitoring data are insufficient to constitute a valid hour of data for at least 75 percent of the operating hours. Monitoring data are insufficient to constitute a valid hour of data if measured values are unavailable for any of the 15-minute periods within the hour.

(iii) A deviation occurs when the period of control device operation is less than 4 hours in an operating day and more than 1 of the hours during the period does not constitute a valid hour of data due to insufficient monitoring data. Monitoring data are insufficient to constitute a valid hour of data if measured values are unavailable for any of the 15-minute periods within the hour.

(5) For each deviation, except when the deviation occurs during periods of non-operation of the unit or the process that is vented to the control device (resulting in cessation of HAP emissions to which the monitoring applies), the owner or operator shall be deemed to have failed to have applied control in a manner that achieves the required operating parameter limits. Failure to achieve the required operating parameter limits is a violation of this standard.

(f) *Alternative inspection and monitoring interval.* Following the initial inspection and monitoring of a piece of air pollution control equipment in accordance with the applicable provisions of this section, subsequent inspection and monitoring of the equipment may be performed at intervals longer than 1 year when an owner or operator determines that performing the required inspection or monitoring procedures would expose a worker to dangerous, hazardous, or otherwise unsafe conditions and the owner or operator complies with the requirements specified in paragraphs (f)(1) and (f)(2) of this section.

(1) The owner or operator must prepare and maintain at the plant site written documentation identifying the specific air pollution control equipment designated as "unsafe to inspect and monitor." The documentation must include for each piece of air pollution control equipment designated as such a written explanation of the reasons why the equipment is unsafe to inspect or monitor using the applicable procedures under this section.

(2) The owner or operator must develop and implement a written plan and schedule to inspect and monitor the air pollution control equipment using the applicable procedures specified in this section during times when a worker can safely access the air pollution control equipment. The required inspections and monitoring must be performed as frequently as practicable but do not need to be performed more frequently than the periodic schedule that would be otherwise applicable to the air pollution control equipment under the provisions of this section. A copy of the written plan and schedule must be maintained at the plant site.

[↑ Back to Top](#)

§63.696 Recordkeeping requirements.

(a) The owner or operator subject to this subpart shall comply with the recordkeeping requirements in §63.10 under 40 CFR 63 subpart A—General Provisions that are applicable to this subpart as specified in Table 2 of this subpart.

(b) The owner or operator of a control device subject to this subpart shall maintain the records in accordance with the requirements of 40 CFR 63.10 of this part.

(c) [Reserved]

(d) Each owner or operator using an internal floating roof to comply with the tank control requirements specified in §63.685(e) of this subpart or using an external floating roof to comply with the tank control requirements specified in §63.685(f) of this subpart shall prepare and maintain the following records:

(1) Documentation describing the floating roof design and the dimensions of the tank.

(2) A record for each inspection required by §63.695(b) of this subpart, as applicable to the tank, that includes the following information: a tank identification number (or other unique identification description as selected by the owner or operator) and the date of inspection.

(3) The owner or operator shall record for each defect detected during inspections required by §63.695(b) of this subpart the following information: the location of the defect, a description of the defect, the date of detection, and corrective action taken to repair the defect. In the event that repair of the defect is delayed in accordance with the provisions of §63.695(b)(4) of this section, the owner or operator shall also record the reason for the delay and the date that completion of repair of the defect is expected.

(4) Owners and operators that use a tank equipped with an external floating roof in accordance with the provisions of §63.685(f) of this subpart shall prepare and maintain records for each seal gap inspection required by §63.695(b) describing the results of the seal gap measurements. The records shall include the date of that the measurements are performed, the raw data obtained for the measurements, and the calculations of the total gap surface area. In the event that the seal gap measurements do not conform to the specifications in §63.695(b) of this subpart, the records shall include a description of the repairs that were made, the date the repairs were made, and the date the separator was emptied, if necessary.

(e) Each owner or operator using a fixed roof to comply with the tank control requirements specified in §63.685(g) of this subpart shall prepare and maintain the following records:

(1) A record for each inspection required by §63.695(b) of this subpart, as applicable to the tank, that includes the following information: a tank identification number (or other unique identification description as selected by the owner or operator) and the date of inspection.

(2) The owner or operator shall record for each defect detected during inspections required by §63.695(b) of this subpart the following information: the location of the defect, a description of the defect, the date of detection, and corrective action taken to repair the defect. In the event that repair of the defect is delayed in accordance with the provisions of §63.695(b)(4) of this section, the owner or operator shall also record the reason for the delay and the date that completion of repair of the defect is expected.

(f) Each owner or operator using an enclosure to comply with the tank control requirements specified in §63.685(i) of this subpart shall prepare and maintain records for the most recent set of calculations and measurements performed by the owner or operator to verify that the enclosure meets the criteria of a permanent total enclosure as specified in “Procedure T—Criteria for and Verification of a Permanent or Temporary Total Enclosure” under 40 CFR 52.741, appendix B.

(g) An owner or operator shall record, on a semiannual basis, the information specified in paragraphs (g)(1) and (g)(2) of this section for those planned routine maintenance operations that would require the control device not to meet the requirements of §63.693(d) through (h) of this subpart, as applicable.

(1) A description of the planned routine maintenance that is anticipated to be performed for the control device during the next 6 months. This description shall include the type of maintenance necessary, planned frequency of maintenance, and lengths of maintenance periods.

(2) A description of the planned routine maintenance that was performed for the control device during the previous 6 months. This description shall include the type of maintenance performed and the total number of hours during these 6 months that the control device did not meet the requirement of §63.693 (d) through (h) of this subpart, as applicable, due to planned routine maintenance.

(h) An owner or operator shall record the malfunction information specified in paragraphs (h)(1) through (3) of this section.

(1) In the event that an affected unit fails to meet an applicable standard, record the number of failures. For each failure, record the date, time and duration of the failure.

(2) For each failure to meet an applicable standard, record and retain a list of the affected sources or equipment, an estimate of the volume of each regulated pollutant emitted over any emission limit and a description of the method used to estimate the emissions.

(3) Record actions taken to minimize emissions in accordance with §63.683(e) and any corrective actions taken to return the affected unit to its normal or usual manner of operation.

(i) For pressure relief devices in off-site material service, keep records of the information specified in paragraphs (i)(1) through (5) of this section, as applicable.

(1) A list of identification numbers for pressure relief devices that the owner or operator elects to route emissions through a closed-vent system to a control device, process or drain system under the provisions in §63.691(c)(4).

(2) A list of identification numbers for pressure relief devices that do not consist of or include a rupture disk, subject to the provisions in §63.691(c)(2)(i).

(3) A list of identification numbers for pressure relief devices equipped with rupture disks, subject to the provisions in §63.691(c)(2)(ii).

(4) The dates and results of the Method 21 of 40 CFR part 60, appendix A, monitoring following a pressure release for each pressure relief device subject to the provisions in §63.691(c)(2)(i). The results of each monitoring event shall include:

(i) The measured background level.

(ii) The maximum instrument reading measured at each pressure relief device.

(5) For pressure relief devices in off-site material service subject to §63.691(c)(3), keep records of each pressure release to the atmosphere, including the following information:

(i) The source, nature, and cause of the pressure release.

(ii) The date, time, and duration of the pressure release.

(iii) An estimate of the quantity of HAP listed in Table 1 of this subpart emitted during the pressure release and the calculations used for determining this quantity.

(iv) The actions taken to prevent this pressure release.

(v) The measures adopted to prevent future such pressure releases.

(j) (1) For pressure tank closure devices, as specified in §63.685(h)(2), keep records of each release to the atmosphere, including the information specified in paragraphs (j)(3) through (7) of this section.

(2) For each closed vent system that includes bypass devices that could divert a stream away from the control device and into the atmosphere, as specified in §63.693(c)(2), and each open-ended valve or line in an emergency shutdown system which is designed to open automatically in the event of a process upset, as specified in §63.167(d) or 40 CFR 61.242-6(d), keep records of each release to the atmosphere, including the information specified in paragraphs (j)(3) through (9) of this section.

(3) The source, nature, and cause of the release.

(4) The date, time, and duration of the release.

(5) An estimate of the quantity of HAP listed in Table 1 of this subpart emitted during the release and the calculations used for determining this quantity.

(6) The actions taken to prevent this release.

(7) The measures adopted to prevent future such release.

(8) Hourly records of whether the bypass flow indicator specified under §63.693(c)(2) was operating and whether a diversion was detected at any time during the hour, as well as records of the times of all periods when the vent stream is diverted from the control device or the flow indicator is not operating.

(9) Where a seal mechanism is used to comply with §63.693(c)(2), hourly records of flow are not required. In such cases, the owner or operator shall record that the monthly visual inspection of the seals or closure mechanism has been done, and shall record the duration of all periods when the seal mechanism is broken, the bypass line valve position has changed, or the key for a lock-and-key type lock has been checked out, and records of any car-seal that has broken.

[61 FR 34158, July 1, 1996, as amended at 80 FR 14279, Mar. 18, 2015]

 [Back to Top](#)

§63.697 Reporting requirements.

(a) Each owner or operator of an affected source subject to this subpart must comply with the notification requirements specified in paragraph (a)(1) of this section and the reporting requirements specified in paragraphs (a)(2) and (3) of this section.

(1) The owner or operator of an affected source must submit notices to the Administrator in accordance with the applicable notification requirements in 40 CFR 63.9 as specified in Table 2 of this subpart. For the purpose of this subpart, an owner or operator subject to the initial notification requirements under 40 CFR 63.9(b)(2) must submit the required notification on or before October 19, 1999.

(i) For pressure relief devices in off-site material service subject to the requirements of §63.691(c), the owner or operator must submit the information listed in paragraph (a)(1)(ii) of this section in the notification of compliance status required under §63.9(h) within 150 days after the first applicable compliance date for pressure relief device monitoring.

(ii) For pressure relief devices in off-site material service, a description of the device or monitoring system to be implemented, including the pressure relief devices and process parameters to be monitored (if applicable), a description of the alarms or other methods by which operators will be notified of a pressure release, and a description of how the owner or operator will determine the information to be recorded under §63.696(i)(5)(ii) through (iii) (*i.e.*, the duration of the pressure release and the methodology and calculations for determining the quantity of HAP listed in Table 1 of this subpart emitted during the pressure release).

(2) The owner or operator of an affected source must submit reports to the Administrator in accordance with the applicable reporting requirements in 40 CFR 63.10 as specified in Table 2 of this subpart.

(3) *Electronic reporting.* Within 60 days after the date of completing each performance test (as defined in §63.2) required by this subpart, the owner or operator must submit the results of the performance test according to the manner specified by either paragraph (a)(3)(i) or (ii) of this section.

(i) For data collected using test methods supported by the EPA's Electronic Reporting Tool (ERT) as listed on the EPA's ERT Web site (<http://www.epa.gov/ttn/chief/ert/index.html>), the owner or operator must submit the results of the performance test to the EPA via the Compliance and Emissions Data Reporting Interface (CEDRI) accessed through the EPA's Central Data Exchange (CDX) (http://cdx.epa.gov/epa_home.asp). Performance test data must be submitted in a file format generated through the use of the EPA's ERT. Owners or operators who claim that some of the performance test information being submitted is confidential business information (CBI) must submit a complete file generated through the use of the EPA's ERT, including information claimed to be CBI, on a compact disc, flash drive, or other commonly used electronic storage media to the EPA. The electronic media must be clearly marked as CBI and mailed to U.S. EPA/OAPQS/CORE CBI Office, Attention: Group Leader, Measurement Policy Group, MD C404-02, 4930 Old Page Road, Durham, NC 27703. The same ERT file with the CBI omitted must be submitted to the EPA via the EPA's CDX as described earlier in this paragraph (a)(3)(i).

(ii) For data collected using test methods that are not supported by the EPA's ERT as listed on the EPA's ERT Web site, the owner or operator must submit the results of the performance test to the Administrator at the appropriate address listed in 40 CFR 60.4.

(b) The owner or operator of a control device used to meet the requirements of §63.693 of this subpart shall submit the following notifications and reports to the Administrator:

(1) A Notification of Performance Tests specified in §63.7 and §63.9(g) of this part,

(2) Performance test reports specified in §63.10(d)(2) of this part, and

(3) *Reports of malfunctions.* If a source fails to meet an applicable standard, report such events in the Periodic Report. Report the number of failures to meet an applicable standard. For each instance, report the date, time and duration of each failure. For each failure the report must include a list of the affected sources or equipment, an estimate of the volume of each regulated pollutant emitted over any emission limit, and a description of the method used to estimate the emissions.

(4) A summary report specified in §63.10(e)(3) shall be submitted on a semiannual basis (*i.e.*, once every 6-month period). The summary report must include a description of all deviations as defined in §§63.683(f) and 63.695(e) that have occurred during the 6-month reporting period. For each deviation caused when the daily average value of a monitored operating parameter is less than the minimum operating parameter limit (or, if applicable, greater than the maximum operating parameter limit), the report must include the daily average values of the monitored parameter, the applicable operating parameter limit, and the date and duration of the period that the deviation occurred. For each deviation caused by lack of monitoring data, the report must include the date and duration of period when the monitoring data were not collected and the reason why the data were not collected.

(5) For pressure relief devices in off-site material service subject to §63.691(c), Periodic Reports must include the information specified in paragraphs (b)(5)(i) through (iii) of this section.

(i) For pressure relief devices in off-site material service subject to §63.691(c), report the results of all monitoring conducted within the reporting period.

(ii) For pressure relief devices in gas/vapor service subject to §63.691(c)(2)(i), report any instrument reading of 500 ppm above background or greater, if detected more than 5 days after the pressure release.

(iii) For pressure relief devices in off-site material service subject to §63.691(c)(3), report each pressure release to the atmosphere, including the following information:

(A) The source, nature, and cause of the pressure release.

(B) The date, time, and duration of the pressure release.

(C) An estimate of the quantity of HAP listed in Table 1 of this subpart emitted during the pressure release and the method used for determining this quantity.

(D) The actions taken to prevent this pressure release.

(E) The measures adopted to prevent future such pressure releases.

(6) *Pressure tank closure device or bypass deviation report.* The owner or operator must submit to the Administrator the information specified in paragraph (b)(6)(iv) of this section when any of the conditions in paragraphs (b)(6)(i) through (iii) of this section are met.

(i) Any pressure tank closure device, as specified in §63.685(h)(2), has released to the atmosphere.

(ii) Any closed vent system that includes bypass devices that could divert a vent a stream away from the control device and into the atmosphere, as specified in §63.693(c)(2), has released directly to the atmosphere.

(iii) Any open-ended valve or line in an emergency shutdown system which is designed to open automatically in the event of a process upset, as specified in §63.167(d) or 40 CFR 61.242-6(d), has released directly to the atmosphere.

(iv) The pressure tank closure device or bypass deviation report must include the information specified in paragraphs (b)(6)(iv)(A) through (E) of this section.

(A) The source, nature and cause of the release.

(B) The date, time and duration of the discharge.

(C) An estimate of the quantity of HAP listed in Table 1 of this subpart emitted during the release and the method used for determining this quantity.

(D) The actions taken to prevent this release.

(E) The measures adopted to prevent future such releases.

(c) Each owner or operator using an internal floating roof or external floating roof to comply with the Tank Level 2 control requirements specified in §63.685(d) of this subpart shall notify the Administrator in advance of each inspection required under §63.695(b) of this subpart to provide the Administrator with the opportunity to have an observer present during the inspection. The owner or operator shall notify the Administrator of the date and location of the inspection as follows:

(1) Prior to each inspection to measure external floating roof seal gaps as required under §63.695(b) of this subpart, written notification shall be prepared and sent by the owner or operator so that it is received by the Administrator at least 30 calendar days before the date the measurements are scheduled to be performed.

(2) Prior to each visual inspection of an internal floating roof or external floating roof in a tank that has been emptied and degassed, written notification shall be prepared and sent by the owner or operator so that it is received by the Administrator at least 30 calendar days before refilling the tank except when an inspection is not planned as provided for in paragraph (c)(3) of this section.

(3) When a visual inspection is not planned and the owner or operator could not have known about the inspection 30 calendar days before refilling the tank, the owner or operator shall notify the Administrator as soon as possible, but no later than 7 calendar days before refilling of the tank. This notification may be made by telephone and immediately followed by a written explanation for why the inspection is unplanned. Alternatively, written notification, including the explanation for the unplanned inspection, may be sent so that it is received by the Administrator at least 7 calendar days before refilling the tank.

[61 FR 34158, July 1, 1996, as amended at 64 FR 38981, July 20, 1999; 80 FR 14279, Mar. 18, 2015]

 [Back to Top](#)

§63.698 Implementation and enforcement.

(a) This subpart can be implemented and enforced by the U.S. EPA, or a delegated authority such as the applicable State, local, or Tribal agency. If the U.S. EPA Administrator has delegated authority to a State, local, or Tribal agency, then that agency, in addition to the U.S. EPA, has the authority to implement and enforce this subpart. Contact the applicable U.S. EPA Regional Office to find out if this subpart is delegated to a State, local, or Tribal agency.

(b) In delegating implementation and enforcement authority of this subpart to a State, local, or Tribal agency under subpart E of this part, the authorities contained in paragraph (c) of this section are retained by the Administrator of U.S. EPA and cannot be transferred to the State, local, or Tribal agency.

(c) The authorities that cannot be delegated to State, local, or Tribal agencies are as specified in paragraphs (c)(1) through (5) of this section.

(1) Approval of alternatives to the requirements in §§63.680, 63.683 through 63.691, and 63.693. Where these standards reference another subpart, the cited provisions will be delegated according to the delegation provisions of the referenced subpart.

(2) Approval of major alternatives to test methods under §63.7(e)(2)(ii) and (f), as defined in §63.90, and as required in this subpart.

(3) Approval of major alternatives to monitoring under §63.8(f), as defined in §63.90, and as required in this subpart.

(4) Approval of major alternatives to recordkeeping and reporting under §63.10(f), as defined in §63.90, and as required in this subpart.

(5) Approval of alternatives to the electronic reporting requirements in §63.697(a)(3).

[68 FR 37352, June 23, 2003, as amended at 80 FR 14280, Mar. 18, 2015]

[↑ Back to Top](#)

Table 1 to Subpart DD of Part 63—List of Hazardous Air Pollutants (HAP) for Subpart DD

CAS No. ^a	Chemical name	f _m 305
75-07-0	Acetaldehyde	1.000
75-05-8	Acetonitrile	0.989
98-86-2	Acetophenone	0.314
107-02-8	Acrolein	1.000
107-13-1	Acrylonitrile	0.999
107-05-1	Allyl chloride	1.000
71-43-2	Benzene (includes benzene in gasoline)	1.000
98-07-7	Benzotrichloride (isomers and mixture)	0.958
100-44-7	Benzyl chloride	1.000
92-52-4	Biphenyl	0.864

542-88-1	Bis(chloromethyl)ether ^b	0.999
75-25-2	Bromoform	0.998
106-99-0	1,3-Butadiene	1.000
75-15-0	Carbon disulfide	1.000
56-23-5	Carbon tetrachloride	1.000
43-58-1	Carbonyl sulfide	1.000
133-90-4	Chloramben	0.633
108-90-7	Chlorobenzene	1.000
67-66-3	Chloroform	1.000
107-30-2	Chloromethyl methyl ether ^b	1.000
126-99-8	Chloroprene	1.000
98-82-8	Cumene	1.000
94-75-7	2,4-D, salts and esters	0.167
334-88-3	Diazomethane ^c	0.999
132-64-9	Dibenzofurans	0.967
96-12-8	1,2-Dibromo-3-chloropropane	1.000
106-46-7	1,4-Dichlorobenzene(p)	1.000
107-06-2	Dichloroethane (Ethylene dichloride)	1.000
111-44-4	Dichloroethyl ether (Bis(2-chloroethyl ether)	0.757
542-75-6	1,3-Dichloropropene	1.000
79-44-7	Dimethyl carbamoyl chloride ^c	0.150
64-67-5	Diethyl sulfate	0.0025

77-78-1	Dimethyl sulfate	0.086
121-69-7	N,N-Dimethylaniline	0.0008
51-28-5	2,4-Dinitrophenol	0.0077
121-14-2	2,4-Dinitrotoluene	0.0848
123-91-1	1,4-Dioxane (1,4-Diethyleneoxide)	0.869
106-89-8	Epichlorohydrin (1-Chloro-2,3-epoxypropane)	0.939
106-88-7	1,2-Epoxybutane	1.000
140-88-5	Ethyl acrylate	1.000
100-41-4	Ethyl benzene	1.000
75-00-3	Ethyl chloride (Chloroethane)	1.000
106-93-4	Ethylene dibromide (Dibromoethane)	0.999
107-06-2	Ethylene dichloride (1,2-Dichloroethane)	1.000
151-56-4	Ethylene imine (Aziridine)	0.867
75-21-8	Ethylene oxide	1.000
75-34-3	Ethylidene dichloride (1,1-Dichloroethane)	1.000
	Glycol ethers ^d that have a Henry's Law constant value equal to or greater than 0.1 Y/X (1.8×10^{-6} atm/gm-mole/m ³) at 25°C	^(e)
118-74-1	Hexachlorobenzene	0.97
87-68-3	Hexachlorobutadiene	0.88
67-72-1	Hexachloroethane	0.499
110-54-3	Hexane	1.000
78-59-1	Isophorone	0.506
58-89-9	Lindane (all isomers)	1.000

67-56-1	Methanol	0.855
74-83-9	Methyl bromide (Bromomethane)	1.000
74-87-3	Methyl chloride (Chloromethane)	1.000
71-55-6	Methyl chloroform (1,1,1-Trichloroethane)	1.000
78-93-3	Methyl ethyl ketone (2-Butanone)	0.990
74-88-4	Methyl iodide (Iodomethane)	1.0001
108-10-1	Methyl isobutyl ketone (Hexone)	0.9796
624-83-9	Methyl isocyanate	1.000
80-62-6	Methyl methacrylate	0.916
1634-04-4	Methyl tert butyl ether	1.000
75-09-2	Methylene chloride (Dichloromethane)	1.000
91-20-3	Naphthalene	0.994
98-95-3	Nitrobenzene	0.394
79-46-9	2-Nitropropane	0.989
82-68-8	Pentachloronitrobenzene (Quintobenzene)	0.839
87-86-5	Pentachlorophenol	0.0898
75-44-5	Phosgene ^c	1.000
123-38-6	Propionaldehyde	0.999
78-87-5	Propylene dichloride (1,2-Dichloropropane)	1.000
75-56-9	Propylene oxide	1.000
75-55-8	1,2-Propylenimine (2-Methyl aziridine)	0.945
100-42-5	Styrene	1.000
96-09-3	Styrene oxide	0.830
79-34-5	1,1,2,2-Tetrachloroethane	0.999
127-18-4	Tetrachloroethylene (Perchloroethylene)	1.000
108-88-3	Toluene	1.000

95-53-4	o-Toluidine	0.152
120-82-1	1,2,4-Trichlorobenzene	1.000
71-55-6	1,1,1-Trichloroethane (Methyl chlorform)	1.000
79-00-5	1,1,2-Trichloroethane (Vinyl trichloride)	1.000
79-01-6	Trichloroethylene	1.000
95-95-4	2,4,5-Trichlorophenol	0.108
88-06-2	2,4,6-Trichlorophenol	0.132
121-44-8	Triethylamine	1.000
540-84-1	2,2,4-Trimethylpentane	1.000
108-05-4	Vinyl acetate	1.000
593-60-2	Vinyl bromide	1.000
75-01-4	Vinyl chloride	1.000
75-35-4	Vinylidene chloride (1,1-Dichloroethylene)	1.000
1330-20-7	Xylenes (isomers and mixture)	1.000
95-47-6	o-Xylenes	1.000
108-38-3	m-Xylenes	1.000
106-42-3	p-Xylenes	1.000

NOTES:

$f_{m\ 305}$ = Method 305 fraction measure factor.

a. CAS numbers refer to the Chemical Abstracts Services registry number assigned to specific compounds, isomers, or mixtures of compounds.

b. Denotes a HAP that hydrolyzes quickly in water, but the hydrolysis products are also HAP chemicals.

c. Denotes a HAP that may react violently with water, exercise caustic is an expected analyte.

d. Denotes a HAP that hydrolyzes slowly in water.

e. The $f_{m,305}$ factors for some of the more common glycol ethers can be obtained by contacting the Waste and Chemical Processes Group, Office of Air Quality Planning and Standards, Research Triangle Park, NC 27711.

[64 FR 38981, July 20, 1999]

[↑ Back to Top](#)

Table 2 to Subpart DD of Part 63—Applicability of Paragraphs in Subpart A of This Part 63—General Provisions to Subpart DD

Subpart A reference	Applies to Subpart DD	Explanation
63.1(a)(1)	Yes	
63.1(a)(2)	Yes	
63.1(a)(3)	Yes	
63.1(a)(4)	No	Subpart DD (this table) specifies applicability of each paragraph in subpart A to subpart DD.
63.1(a)(5)- 63.1(a)(9)	No	
63.1(a)(10)	Yes	
63.1(a)(11)	Yes	
63.1(a)(12)	Yes	
63.1(b)(1)	No	Subpart DD specifies its own applicability.
63.1(b)(2)	No	Reserved.
63.1(b)(3)	No	
63.1(c)(1)	No	Subpart DD explicitly specifies requirements that apply.
63.1(c)(2)	No	Area sources are not subject to subpart DD.
63.1(c)(3)	No	Reserved.
63.1(c)(4)	No	Reserved.
63.1(c)(5)	Yes	Except that sources are not required to submit notifications overridden by this table.
63.1(d)	No	
63.1(e)	No	
63.2	Yes	§63.681 of subpart DD specifies that if the same term is defined in subparts A and DD, it shall have the meaning given in subpart

		DD.
63.3	Yes	
63.4(a)(1)- 63.4(a)(2)	Yes	
63.4(a)(3)	No	Reserved.
63.4(a)(4)	No	Reserved.
63.4(a)(5)	No	Reserved.
63.4(b)	Yes	
63.4(c)	Yes	
63.5(a)(1)	Yes	
63.5(a)(2)	Yes	
63.5(b)(1)	Yes	
63.5(b)(2)	No	Reserved.
63.5(b)(3)	Yes	
63.5(b)(4)	Yes	Except the cross-reference to §63.9(b) is changed to §63.9(b)(4) and (5). Subpart DD overrides §63.9(b)(2) and (b)(3).
63.5(b)(5)	No	Reserved.
63.5(b)(6)	Yes	
63.5(c)	No	Reserved.
63.5(d)(1)(i)	Yes	
63.5(d)(1)(ii)	Yes	
63.5(d)(1)(iii)	Yes	
63.5(d)(2)	No	
63.5(d)(3)	Yes	
63.5(d)(4)	Yes	
63.5(e)	Yes	
63.5(f)(1)	Yes	
63.5(f)(2)	Yes	
63.6(a)	Yes	
63.6(b)(1)	No	Subpart DD specifies compliance dates for sources subject to subpart DD.

63.6(b)(2)	No	
63.6(b)(3)	No	
63.6(b)(4)	No	
63.6(b)(5)	No	§63.697 of subpart DD includes notification requirements.
63.6(b)(6)	No	
63.6(b)(7)	No	
63.6(c)(1)	No	§63.680 of subpart DD specifies the compliance date.
63.6(c)(2)- 63.6(c)(4)	No	
63.6(c)(5)	Yes	
63.6(d)	No	
63.6(e)(1)(i)	No	See §63.683(e) for general duty requirement.
63.6(e)(1)(ii)	No	
63.6(e)(1)(iii)	Yes	
63.6(e)(2)	No	Reserved.
63.6(e)(3)	No	
63.6(f)(1)	No	
63.6(f)(2)(i)	Yes	
63.6(f)(2)(ii)	Yes	Subpart DD specifies the use of monitoring data in determining compliance with subpart DD.
63.6(f)(2)(iii) (A), (B), and (C)	Yes	
63.6(f)(2)(iii) (D)	No	
63.6(f)(2)(iv)	Yes	
63.6(f)(2)(v)	Yes	
63.6(f)(3)	Yes	
63.6(g)	Yes	
63.6(h)	No	Subpart DD does not require opacity and visible emission standards.
63.6(i)	Yes	Except for §63.6(i)(15), which is reserved.
63.6(j)	Yes	

63.7(a)(1)	No	Subpart DD specifies required testing and compliance demonstration procedures.
63.7(a)(2)	Yes	
63.7(a)(3)	Yes	
63.7(a)(4)	Yes	
63.7(b)	Yes	
63.7(c)	Yes	
63.7(d)	Yes	
63.7(e)(1)	No	See §63.694(l).
63.7(e)(2)	Yes	
63.7(e)(3)	No	Subpart DD specifies test methods and procedures.
63.7(e)(4)	Yes	
63.7(f)	Yes	
63.7(g)	Yes	
63.7(h)(1)	Yes	
63.7(h)(2)	Yes	
63.7(h)(3)	Yes	
63.7(h)(4)	No	
63.7(h)(5)	Yes	
63.8(a)	No	
63.8(b)(1)	Yes	
63.8(b)(2)	No	Subpart DD specifies locations to conduct monitoring.
63.8(b)(3)	Yes	
63.8(c)(1)(i)	Yes	
63.8(c)(1)(ii)	Yes	
63.8(c)(1)(iii)	No	
63.8(c)(2)	Yes	
63.8(c)(3)	Yes	
63.8(c)(4)	No	Subpart DD specifies monitoring frequency
63.8(c)(5)- 63.8(c)(8)	No	

63.8(d)	No	
63.8(e)	No	
63.8(f)(1)	Yes	
63.8(f)(2)	Yes	
63.8(f)(3)	Yes	
63.8(f)(4)(i)	Yes	
63.8(f)(4)(ii)	Yes	
63.8(f)(4)(iii)	No	
63.8(f)(5)(i)	Yes	
63.8(f)(5)(ii)	No	
63.8(f)(5)(iii)	Yes	
63.8(f)(6)	Yes	
63.8(g)	Yes	
63.9(a)	Yes	
63.9(b)(1)(i)	Yes	
63.9(b)(1)(ii)	No	
63.9(b)(2)	Yes	
63.9(b)(3)	No	
63.9(b)(4)	Yes	
63.9(b)(5)	Yes	
63.9(c)	Yes	
63.9(d)	Yes	
63.9(e)	Yes	
63.9(f)	No	
63.9(g)	Yes	
63.9(h)	Yes	
63.9(i)	Yes	
63.9(j)	No	
63.10(a)	Yes	
63.10(b)(1)	Yes	

63.10(b)(2)(i)	No	
63.10(b)(2)(ii)	No	See §63.696(h) for recordkeeping of (1) date, time and duration; (2) listing of affected source or equipment, and an estimate of the volume of each regulated pollutant emitted over the standard; and (3) actions to minimize emissions and correct the failure.
63.10(b)(2)(iii)	Yes	
63.10(b)(2)(iv)	No	
63.10(b)(2)(v)	No	
63.10(b)(2)(vi)-(ix)	Yes	
63.10(b)(2)(x)-(xi)	Yes	
63.10(b)(2)(xii)-(xiv)	No	
63.10(b)(3)	Yes	
63.10(c)(1)-(6)	No	
63.10(c)(7)-(8)	Yes	
63.10(c)(9)-(15)	No	
63.10(d)(1)	No	
63.10(d)(2)	Yes	
63.10(d)(3)	No	
63.10(d)(4)	Yes	
63.10(d)(5)(i)	Yes	
63.10(d)(5)	No	See §63.697(b)(3) for reporting of malfunctions.
63.10(e)(1)-63.10(e)(2)	No	
63.10(e)(3)	Yes	
63.10(e)(4)	No	
63.10(f)	Yes	
63.11-63.15	Yes	
63.16	No	

^aWherever subpart A specifies “postmark” dates, submittals may be sent by methods other than the U.S. Mail (e.g., by fax or courier). Submittals shall be sent by the specified dates, but a postmark is not required.

[↑ Back to Top](#)

Table 3 to Subpart DD of Part 63—Tank Control Levels for Tanks at Existing Affected Sources as Required by 40 CFR 63.685(b)(1)

Tank design capacity (cubic meters)	Maximum HAP vapor pressure of off-site material managed in tank (kilopascals)	Tank control level
Design capacity less than 75 m ³	Maximum HAP vapor pressure less than 76.6 kPa	Level 1.
Design capacity less than 75 m ³	Maximum HAP vapor pressure equal to or greater than 76.6 kPa	Level 2, except that fixed roof tanks equipped with an internal floating roof and tanks equipped with an external floating roof as provided for in §63.685(d)(1) and (2) shall not be used.
Design capacity equal to or greater than 75 m ³ and less than 151 m ³	Maximum HAP vapor pressure less than 27.6 kPa	Level 1.
	Maximum HAP vapor pressure equal to or greater than 27.6 kPa	Level 2.
Design capacity equal to or greater than 151 m ³	Maximum HAP vapor pressure less than 5.2 kPa	Level 1.
	Maximum HAP vapor pressure equal to or greater than 5.2 kPa	Level 2.

[↑ Back to Top](#)

Table 4 to Subpart DD of Part 63—Tank Control Levels for Tanks at Existing Affected Sources as Required by 40 CFR 63.685(b)(1)(ii)

Tank design capacity (cubic meters)	Maximum HAP vapor pressure of off-site material managed in tank (kilopascals)	Tank control level
--------------------------------------------	--------------------------------------------------------------------------------------	---------------------------

Design capacity less than 75 m ³	Maximum HAP vapor pressure less than 76.6 kPa	Level 1.
Design capacity less than 75 m ³	Maximum HAP vapor pressure equal to or greater than 76.6 kPa	Level 2, except that fixed roof tanks equipped with an internal floating roof and tanks equipped with an external floating roof as provided for in §63.685(d)(1) and (2) shall not be used.
Design capacity equal to or greater than 75 m ³ and less than 151 m ³	Maximum HAP vapor pressure less than 13.1 kPa	Level 1.
	Maximum HAP vapor pressure equal to or greater than 13.1 kPa	Level 2.
Design capacity equal to or greater than 151 m ³	Maximum HAP vapor pressure less than 5.2 kPa	Level 1.
	Maximum HAP vapor pressure equal to or greater than 5.2 kPa	Level 2.

[80 FR 14283, Mar. 18, 2015]

[↑ Back to Top](#)

Table 5 to Subpart DD of Part 63—Tank Control Levels for Tanks at New Affected Sources as Required by 40 CFR 63.685(b)(2)

Tank design capacity (cubic meters)	Maximum HAP vapor pressure of off-site material managed in tank (kilopascals)	Tank control level
Design capacity less than 38 m ³	Maximum HAP vapor pressure less than 76.6 kPa	Level 1.
Design capacity less than 38 m ³	Maximum HAP vapor pressure equal to or greater than 76.6 kPa	Level 2, except that fixed roof tanks equipped with an internal floating roof and tanks equipped with an external floating roof as provided for in §63.685(d)(1) and (2) shall not be used.
Design capacity equal to or greater	Maximum HAP vapor pressure less than 13.1	Level 1.

than 38 m ³ and less than 151 m ³	kPa	
	Maximum HAP vapor pressure equal to or greater than 13.1 kPa	Level 2.
Design capacity equal to or greater than 151 m ³	Maximum HAP vapor pressure less than 0.7 kPa	Level 1.
	Maximum HAP vapor pressure equal to or greater than 0.7 kPa	Level 2.

[80 FR 14283, Mar. 18, 2015]

[↑ Back to Top](#)

Appendix L

Title 40: Protection of Environment

PART 63—NATIONAL EMISSION STANDARDS FOR HAZARDOUS AIR POLLUTANTS FOR SOURCE CATEGORIES
(CONTINUED)

Subpart EEE—National Emission Standards for Hazardous Air Pollutants from Hazardous Waste Combustors

Contents

GENERAL

§63.1200 Who is subject to these regulations?

§63.1201 Definitions and acronyms used in this subpart.

§63.1202 [Reserved]

INTERIM EMISSIONS STANDARDS AND OPERATING LIMITS FOR INCINERATORS, CEMENT KILNS, AND LIGHTWEIGHT AGGREGATE KILNS

§63.1203 What are the standards for hazardous waste incinerators that are effective until compliance with the standards
under §63.1219?

§63.1204 What are the standards for hazardous waste burning cement kilns that are effective until compliance with the
standards under §63.1220?

§63.1205 What are the standards for hazardous waste burning lightweight aggregate kilns that are effective until
compliance with the standards under §63.1221?

MONITORING AND COMPLIANCE PROVISIONS

§63.1206 When and how must you comply with the standards and operating requirements?

§63.1207 What are the performance testing requirements?

§63.1208 What are the test methods?

§63.1209 What are the monitoring requirements?

NOTIFICATION, REPORTING AND RECORDKEEPING

§63.1210 What are the notification requirements?

§63.1211 What are the recordkeeping and reporting requirements?

OTHER

§63.1212 What are the other requirements pertaining to the NIC?

§63.1213 How can the compliance date be extended to install pollution prevention or waste minimization controls?

§63.1214 Implementation and enforcement.

§63.1215 What are the health-based compliance alternatives for total chlorine?

EMISSIONS STANDARDS AND OPERATING LIMITS FOR SOLID FUEL BOILERS, LIQUID FUEL BOILERS, AND HYDROCHLORIC ACID PRODUCTION FURNACES

§63.1216 What are the standards for solid fuel boilers that burn hazardous waste?

§63.1217 What are the standards for liquid fuel boilers that burn hazardous waste?

§63.1218 What are the standards for hydrochloric acid production furnaces that burn hazardous waste?

REPLACEMENT EMISSIONS STANDARDS AND OPERATING LIMITS FOR INCINERATORS, CEMENT KILNS, AND LIGHTWEIGHT AGGREGATE KILNS

§63.1219 What are the replacement standards for hazardous waste incinerators?

§63.1220 What are the replacement standards for hazardous waste burning cement kilns?

§63.1221 What are the replacement standards for hazardous waste burning lightweight aggregate kilns?

Table 1 to Subpart EEE of Part 63—General Provisions Applicable to Subpart EEE

Appendix to Subpart EEE of Part 63—Quality Assurance Procedures for Continuous Emissions Monitors Used for Hazardous Waste Combustors

SOURCE: 64 FR 53038, Sept. 30, 1999, unless otherwise noted.

[↑ Back to Top](#)

GENERAL

[↑ Back to Top](#)

§63.1200 Who is subject to these regulations?

The provisions of this subpart apply to all hazardous waste combustors: hazardous waste incinerators, hazardous waste cement kilns, hazardous waste lightweight aggregate kilns, hazardous waste solid fuel boilers, hazardous waste liquid fuel boilers, and hazardous waste hydrochloric acid production furnaces. Hazardous waste combustors are also subject to applicable requirements under parts 260 through 270 of this chapter.

(a) *What if I am an area source?* (1) Both area sources and major sources are subject to this subpart.

(2) Both area sources and major sources subject to this subpart, but not previously subject to title V, are immediately subject to the requirement to apply for and obtain a title V permit in all States, and in areas covered by part 71 of this chapter.

(b) These regulations in this subpart do not apply to sources that meet the criteria in Table 1 of this Section, as follows:

TABLE 1 TO §63.1200—HAZARDOUS WASTE COMBUSTORS EXEMPT FROM SUBPART EEE

If	And if	Then
(1) You are a previously affected source	(i) You ceased feeding hazardous waste for a period of time greater than the hazardous waste residence time (i.e., hazardous waste no longer resides in the combustion chamber); (ii) You have initiated the closure requirements of subpart G, parts 264 or 265 of this chapter; (iii) You begin complying with the requirements of all other applicable	You are no longer subject to this subpart (Subpart EEE).

	standards of this part (Part 63); and (iv) You notify the Administrator in writing that you are no longer an affected source under this subpart (Subpart EEE)	
(2) You are a research, development, and demonstration source	You operate for no longer than one year after first burning hazardous waste (Note that the Administrator can extend this one-year restriction on a case-by-case basis upon your written request documenting when you first burned hazardous waste and the justification for needing additional time to perform research, development, or demonstration operations).	You are not subject to this subpart (Subpart EEE). This exemption applies even if there is a hazardous waste combustor at the plant site that is regulated under this subpart. You still, however, remain subject to §270.65 of this chapter.
(3) The only hazardous wastes you burn are exempt from regulation under §266.100(c) of this chapter		You are not subject to the requirements of this subpart (Subpart EEE).
(4) You meet the definition of a small quantity burner under §266.108 of this chapter		You are not subject to the requirements of this subpart (Subpart EEE).

(c) Table 1 of this section specifies the provisions of subpart A (General Provisions, §§63.1-63.15) that apply and those that do not apply to sources affected by this subpart.

[64 FR 53038, Sept. 30, 1999, as amended at 65 FR 42297, July 10, 2000; 67 FR 6986, Feb. 14, 2002; 70 FR 59540, Oct. 12, 2005]

[↑ Back to Top](#)

§63.1201 Definitions and acronyms used in this subpart.

(a) The terms used in this subpart are defined in the Act, in subpart A of this part, or in this section as follows:

Air pollution control system means the equipment used to reduce the release of particulate matter and other pollutants to the atmosphere.

Automatic waste feed cutoff (AWFCO) system means a system comprised of cutoff valves, actuator, sensor, data manager, and other necessary components and electrical circuitry designed, operated and maintained to stop the flow of hazardous waste to the combustion unit automatically and immediately (except as provided by §63.1206(c)(3)(viii)) when any operating requirement is exceeded.

Btu means British Thermal Units.

By-pass duct means a device which diverts a minimum of 10 percent of a cement kiln's off gas, or a device which the Administrator determines on a case-by-case basis diverts a sample of kiln gas that contains levels of carbon monoxide or hydrocarbons representative of the levels in the kiln.

Combustion chamber means the area in which controlled flame combustion of hazardous waste occurs.

Continuous monitor means a device which continuously samples the regulated parameter specified in §63.1209 without interruption, evaluates the detector response at least once every 15 seconds, and computes and records the average value at least every 60 seconds, except during allowable periods of calibration and except as defined otherwise by the CEMS Performance Specifications in appendix B, part 60 of this chapter.

Dioxin/furan and dioxins and furans mean tetra-, penta-, hexa-, hepta-, and octa-chlorinated dibenzo dioxins and furans.

Existing source means any affected source that is not a new source.

Feedrate operating limits means limits on the feedrate of materials (e.g., metals, chlorine) to the combustor that are established based on comprehensive performance testing. The limits are established and monitored by knowing the concentration of the limited material (e.g., chlorine) in each feedstream and the flowrate of each feedstream.

Feedstream means any material fed into a hazardous waste combustor, including, but not limited to, any pumpable or nonpumpable solid, liquid, or gas.

Flowrate means the rate at which a feedstream is fed into a hazardous waste combustor.

Hazardous waste is defined in §261.3 of this chapter.

Hazardous waste burning cement kiln means a rotary kiln and any associated preheater or precalciner devices that produce clinker by heating limestone and other materials for subsequent production of cement for use in commerce, and that burns hazardous waste at any time.

Hazardous waste combustor means a hazardous waste incinerator, hazardous waste burning cement kiln, hazardous waste burning lightweight aggregate kiln, hazardous waste liquid fuel boiler, hazardous waste solid fuel boiler, or hazardous waste hydrochloric acid production furnace.

Hazardous waste hydrochloric acid production furnace and *Hazardous Waste HCl production furnace* mean a halogen acid furnace defined under §260.10 of this chapter that produces aqueous hydrochloric acid (HCl) product and that burns hazardous waste at any time.

Hazardous waste incinerator means a device defined as an incinerator in §260.10 of this chapter and that burns hazardous waste at any time. For purposes of this subpart, the hazardous waste incinerator includes all associated firing systems and air pollution control devices, as well as the combustion chamber equipment.

Hazardous waste lightweight aggregate kiln means a rotary kiln that produces clinker by heating materials such as slate, shale and clay for subsequent production of lightweight aggregate used in commerce, and that burns hazardous waste at any time.

Hazardous waste liquid fuel boiler means a boiler defined under §260.10 of this chapter that does not burn solid fuels and that burns hazardous waste at any time. Liquid fuel boiler includes boilers that only burn gaseous fuel.

Hazardous waste residence time means the time elapsed from cutoff of the flow of hazardous waste into the combustor (including, for example, the time required for liquids to flow from the cutoff valve into the combustor) until solid, liquid, and gaseous materials from the hazardous waste (excluding residues that may adhere to combustion chamber surfaces and excluding waste-derived recycled materials such as cement kiln dust and internally recycled metals) exit the combustion chamber. For combustors with multiple firing systems whereby the residence time may vary for the firing systems, the hazardous waste residence time for purposes of complying with this subpart means the longest residence time for any firing system in use at the time of the waste cutoff.

Hazardous waste solid fuel boiler means a boiler defined under §260.10 of this chapter that burns a solid fuel and that burns hazardous waste at any time.

Initial comprehensive performance test means the comprehensive performance test that is used as the basis for initially demonstrating compliance with the standards.

In-line kiln raw mill means a hazardous waste burning cement kiln design whereby kiln gas is ducted through the raw material mill for portions of time to facilitate drying and heating of the raw material.

Instantaneous monitoring for combustion system leak control means detecting and recording pressure, without use of an averaging period, at a frequency adequate to detect combustion system leak events from hazardous waste combustion.

Monovent means an exhaust configuration of a building or emission control device (e.g. positive pressure fabric filter) that extends the length of the structure and has a width very small in relation to its length (i.e., length to width ratio is typically greater than 5:1). The exhaust may be an open vent with or without a roof, louvered vents, or a combination of such features.

MTEC means maximum theoretical emissions concentration of metals or HCl/Cl, expressed as µg/dscm, and is calculated by dividing the feedrate by the gas flowrate.

New source means any affected source the construction or reconstruction of which is commenced after the dates specified under §§63.1206(a)(1)(i)(B), (a)(1)(ii)(B), and (a)(2)(ii).

One-minute average means the average of detector responses calculated at least every 60 seconds from responses obtained at least every 15 seconds.

Operating record means a documentation retained at the facility for ready inspection by authorized officials of all information required by the standards to document and maintain compliance with the applicable regulations, including data and information, reports, notifications, and communications with regulatory officials.

Operating requirements means operating terms or conditions, limits, or operating parameter limits developed under this subpart that ensure compliance with the emission standards.

Preheater tower combustion gas monitoring location means a location within the preheater tower of a dry process cement kiln downstream (in terms of gas flow) of all hazardous waste firing locations and where a representative sample of combustion gas to measure combustion efficiency can be monitored.

Raw material feed means the prepared and mixed materials, which include but are not limited to materials such as limestone, clay, shale, sand, iron ore, mill scale, cement kiln dust and flyash, that are fed to a cement or lightweight aggregate kiln. Raw material feed does not include the fuels used in the kiln to produce heat to form the clinker product.

Research, development, and demonstration source means a source engaged in laboratory, pilot plant, or prototype demonstration operations:

(1) Whose primary purpose is to conduct research, development, or short-term demonstration of an innovative and experimental hazardous waste treatment technology or process; and

(2) Where the operations are under the close supervision of technically-trained personnel.

Rolling average means the average of all one-minute averages over the averaging period.

Run means the net period of time during which an air emission sample is collected under a given set of operating conditions. Three or more runs constitutes a test. Unless otherwise specified, a run may be either intermittent or continuous.

Run average means the average of the one-minute average parameter values for a run.

System removal efficiency means $[1 - \text{Emission Rate (mass/time)} / \text{Feedrate (mass/time)}] \times 100$.

TEQ means the international method of expressing toxicity equivalents for dioxins and furans as defined in U.S. EPA, Interim Procedures for Estimating Risks Associated with Exposures to Mixtures of Chlorinated Dibenzo-p-dioxins and -dibenzofurans (CDDs and CDFs) and 1989 Update, March 1989.

You means the owner or operator of a hazardous waste combustor.

(b) The acronyms used in this subpart refer to the following:

AWFCO means automatic waste feed cutoff.

CAS means chemical abstract services registry.

CEMS means continuous emissions monitoring system.

CMS means continuous monitoring system.

DRE means destruction and removal efficiency.

MACT means maximum achievable control technology.

MTEC means maximum theoretical emissions concentration.

NIC means notification of intent to comply.

[64 FR 53038, Sept. 30, 1999, as amended at 65 FR 42297, July 10, 2000; 65 FR 67271, Nov. 9, 2000; 66 FR 35103, July 3, 2001; 67 FR 6986, Feb. 14, 2002; 67 FR 77691, Dec. 19, 2002; 70 FR 59540, Oct. 12, 2005]

§63.1202 [Reserved]

[↑ Back to Top](#)

INTERIM EMISSIONS STANDARDS AND OPERATING LIMITS FOR INCINERATORS, CEMENT KILNS, AND LIGHTWEIGHT AGGREGATE KILNS

[↑ Back to Top](#)

§63.1203 What are the standards for hazardous waste incinerators that are effective until compliance with the standards under §63.1219?

(a) *Emission limits for existing sources.* You must not discharge or cause combustion gases to be emitted into the atmosphere that contain:

(1) For dioxins and furans:

(i) Emissions in excess of 0.20 ng TEQ/dscm corrected to 7 percent oxygen; or

(ii) Emissions in excess of 0.40 ng TEQ/dscm corrected to 7 percent oxygen provided that the combustion gas temperature at the inlet to the initial particulate matter control device is 400 °F or lower based on the average of the test run average temperatures. (For purposes of compliance, operation of a wet particulate control device is presumed to meet the 400 °F or lower requirement);

(2) Mercury in excess of 130 µg/dscm corrected to 7 percent oxygen;

(3) Lead and cadmium in excess of 240 µg/dscm, combined emissions, corrected to 7 percent oxygen;

(4) Arsenic, beryllium, and chromium in excess of 97 µg/dscm, combined emissions, corrected to 7 percent oxygen;

(5) For carbon monoxide and hydrocarbons, either:

(i) Carbon monoxide in excess of 100 parts per million by volume, over an hourly rolling average (monitored continuously with a continuous emissions monitoring system), dry basis and corrected to 7 percent oxygen. If you elect to comply with this carbon monoxide standard rather than the hydrocarbon standard under paragraph (a)(5)(ii) of this section, you must also document that, during the destruction and removal efficiency (DRE) test runs or their equivalent as provided by §63.1206(b)(7), hydrocarbons do not exceed 10 parts per million by volume during those runs, over an hourly rolling average (monitored continuously with a continuous emissions monitoring system), dry basis, corrected to 7 percent oxygen, and reported as propane; or

(ii) Hydrocarbons in excess of 10 parts per million by volume, over an hourly rolling average (monitored continuously with a continuous emissions monitoring system), dry basis, corrected to 7 percent oxygen, and reported as propane;

(6) Hydrochloric acid and chlorine gas in excess of 77 parts per million by volume, combined emissions, expressed as hydrochloric acid equivalents, dry basis and corrected to 7 percent oxygen; and

(7) Particulate matter in excess of 34 mg/dscm corrected to 7 percent oxygen.

(b) *Emission limits for new sources.* You must not discharge or cause combustion gases to be emitted into the atmosphere that contain:

(1) Dioxins and furans in excess of 0.20 ng TEQ/dscm, corrected to 7 percent oxygen;

(2) Mercury in excess of 45 µg/dscm corrected to 7 percent oxygen;

(3) Lead and cadmium in excess of 120 µg/dscm, combined emissions, corrected to 7 percent oxygen;

(4) Arsenic, beryllium, and chromium in excess of 97 µg/dscm, combined emissions, corrected to 7 percent oxygen;

(5) For carbon monoxide and hydrocarbons, either:

(i) Carbon monoxide in excess of 100 parts per million by volume, over an hourly rolling average (monitored continuously with a continuous emissions monitoring system), dry basis and corrected to 7 percent oxygen. If you elect to comply with this carbon monoxide standard rather than the hydrocarbon standard under paragraph (b)(5)(ii) of this section, you must also document that, during the destruction and removal efficiency (DRE) test runs or their equivalent as provided by §63.1206(b)(7), hydrocarbons do not exceed 10 parts per million by volume during those runs, over an hourly rolling average (monitored continuously with a continuous emissions monitoring system), dry basis, corrected to 7 percent oxygen, and reported as propane; or

(ii) Hydrocarbons in excess of 10 parts per million by volume, over an hourly rolling average (monitored continuously with a continuous emissions monitoring system), dry basis, corrected to 7 percent oxygen, and reported as propane;

(6) Hydrochloric acid and chlorine gas in excess of 21 parts per million by volume, combined emissions, expressed as hydrochloric acid equivalents, dry basis and corrected to 7 percent oxygen; and

(7) Particulate matter in excess of 34 mg/dscm corrected to 7 percent oxygen.

(c) *Destruction and removal efficiency (DRE) standard—(1) 99.99% DRE.* Except as provided in paragraph (c)(2) of this section, you must achieve a destruction and removal efficiency (DRE) of 99.99% for each principle organic hazardous constituent (POHC) designated under paragraph (c)(3) of this section. You must calculate DRE for each POHC from the following equation:

$$DRE = [1 - (W_{out} / W_{in})] \times 100\%$$

Where:

W_{in} = mass feedrate of one principal organic hazardous constituent (POHC) in a waste feedstream; and

W_{out} = mass emission rate of the same POHC present in exhaust emissions prior to release to the atmosphere.

(2) *99.9999% DRE.* If you burn the dioxin-listed hazardous wastes F020, F021, F022, F023, F026, or F027 (see §261.31 of this chapter), you must achieve a destruction and removal efficiency (DRE) of 99.9999% for each principle organic hazardous constituent (POHC) that you designate under paragraph (c)(3) of this section. You must demonstrate this DRE performance on POHCs that are more difficult to incinerate than tetra-, penta-, and hexachlorodibenzo-*p*-dioxins and dibenzofurans. You must use the equation in paragraph (c)(1) of this section to calculate DRE for each POHC. In addition, you must notify the Administrator of your intent to incinerate hazardous wastes F020, F021, F022, F023, F026, or F027.

(3) *Principal organic hazardous constituents (POHCs)*. (i) You must treat the Principal Organic Hazardous Constituents (POHCs) in the waste feed that you specify under paragraph (c)(3)(ii) of this section to the extent required by paragraphs (c)(1) and (c)(2) of this section.

(ii) You must specify one or more POHCs that are representative of the most difficult to destroy organic compounds in your hazardous waste feedstream. You must base this specification on the degree of difficulty of incineration of the organic constituents in the hazardous waste and on their concentration or mass in the hazardous waste feed, considering the results of hazardous waste analyses or other data and information.

(d) *Significant figures*. The emission limits provided by paragraphs (a) and (b) of this section are presented with two significant figures. Although you must perform intermediate calculations using at least three significant figures, you may round the resultant emission levels to two significant figures to document compliance.

(e) The provisions of this section no longer apply after any of the following dates, whichever occurs first:

(1) The date that your source begins to comply with §63.1219 by placing a Documentation of Compliance in the operating record pursuant to §63.1211(c);

(2) The date that your source begins to comply with §63.1219 by submitting a Notification of Compliance pursuant to §63.1210(b); or

(3) The date for your source to comply with §63.1219 pursuant to §63.1206 and any extensions granted there under.

[67 FR 6809, Feb. 13, 2002, as amended at 70 FR 59541, Oct. 12, 2005; 73 FR 18979, Apr. 8, 2008]

 [Back to Top](#)

§63.1204 What are the standards for hazardous waste burning cement kilns that are effective until compliance with the standards under §63.1220?

(a) *Emission limits for existing sources*. You must not discharge or cause combustion gases to be emitted into the atmosphere that contain:

(1) For dioxins and furans:

(i) Emissions in excess of 0.20 ng TEQ/dscm corrected to 7 percent oxygen; or

(ii) Emissions in excess of 0.40 ng TEQ/dscm corrected to 7 percent oxygen provided that the combustion gas temperature at the inlet to the initial dry particulate matter control device is 400 °F or lower based on the average of the test run average temperatures;

(2) Mercury in excess of 120 µg/dscm corrected to 7 percent oxygen;

(3) Lead and cadmium in excess of 330 µg/dscm, combined emissions, corrected to 7 percent oxygen;

(4) Arsenic, beryllium, and chromium in excess of 56 µg/dscm, combined emissions, corrected to 7 percent oxygen;

(5) *Carbon monoxide and hydrocarbons.* (i) For kilns equipped with a by-pass duct or midkiln gas sampling system, either:

(A) Carbon monoxide in the by-pass duct or mid-kiln gas sampling system in excess of 100 parts per million by volume, over an hourly rolling average (monitored continuously with a continuous emissions monitoring system), dry basis and corrected to 7 percent oxygen. If you elect to comply with this carbon monoxide standard rather than the hydrocarbon standard under paragraph (a)(5)(i)(B) of this section, you must also document that, during the destruction and removal efficiency (DRE) test runs or their equivalent as provided by §63.1206(b)(7), hydrocarbons in the by-pass duct or mid-kiln gas sampling system do not exceed 10 parts per million by volume during those runs, over an hourly rolling average (monitored continuously with a continuous emissions monitoring system), dry basis, corrected to 7 percent oxygen, and reported as propane; or

(B) Hydrocarbons in the by-pass duct or midkiln gas sampling system in excess of 10 parts per million by volume, over an hourly rolling average (monitored continuously with a continuous emissions monitoring system), dry basis, corrected to 7 percent oxygen, and reported as propane;

(ii) For kilns not equipped with a by-pass duct or midkiln gas sampling system, either:

(A) Hydrocarbons in the main stack in excess of 20 parts per million by volume, over an hourly rolling average (monitored continuously with a continuous emissions monitoring system), dry basis, corrected to 7 percent oxygen, and reported as propane; or

(B) Carbon monoxide in the main stack in excess of 100 parts per million by volume, over an hourly rolling average (monitored continuously with a continuous emissions monitoring system), dry basis and corrected to 7 percent oxygen. If you elect to comply with this carbon monoxide standard rather than the hydrocarbon standard under paragraph (a)(5)(ii)(A) of this section, you also must document that, during the destruction and removal efficiency (DRE) test runs or their equivalent as provided by §63.1206(b)(7), hydrocarbons in the main stack do not exceed 20 parts per million by volume during those runs, over an hourly rolling average (monitored continuously with a continuous emissions monitoring system), dry basis, corrected to 7 percent oxygen, and reported as propane.

(6) Hydrochloric acid and chlorine gas in excess of 130 parts per million by volume, combined emissions, expressed as hydrochloric acid equivalents, dry basis, corrected to 7 percent oxygen; and

(7) Particulate matter in excess of 0.15 kg/Mg dry feed and opacity greater than 20 percent.

(i) You must use suitable methods to determine the kiln raw material feedrate.

(ii) Except as provided in paragraph (a)(7)(iii) of this section, you must compute the particulate matter emission rate, E, from the following equation:

$$E = (C_s \times Q_{sd})/P$$

Where:

E = emission rate of particulate matter, kg/Mg of kiln raw material feed;

C_s = concentration of particulate matter, kg/dscm;

Q_{sd} = volumetric flowrate of effluent gas, dscm/hr; and

P = total kiln raw material feed (dry basis), Mg/hr.

(iii) If you operate a preheater or preheater/precalciner kiln with dual stacks, you must test simultaneously and compute the combined particulate matter emission rate, E_c , from the following equation:

$$E_c = (C_{sk} \times Q_{sdk} + C_{sb} \times Q_{sdb})/P$$

Where:

E_c = the combined emission rate of particulate matter from the kiln and bypass stack, kg/Mg of kiln raw material feed;

C_{sk} = concentration of particulate matter in the kiln effluent, kg/dscm;

Q_{sdk} = volumetric flowrate of kiln effluent gas, dscm/hr;

C_{sb} = concentration of particulate matter in the bypass stack effluent, kg/dscm;

Q_{sdb} = volumetric flowrate of bypass stack effluent gas, dscm/hr; and

P = total kiln raw material feed (dry basis), Mg/hr.

(b) *Emission limits for new sources.* You must not discharge or cause combustion gases to be emitted into the atmosphere that contain:

(1) For dioxins and furans:

(i) Emissions in excess of 0.20 ng TEQ/dscm corrected to 7 percent oxygen; or

(ii) Emissions in excess of 0.40 ng TEQ/dscm corrected to 7 percent oxygen provided that the combustion gas temperature at the inlet to the initial dry particulate matter control device is 400 °F or lower based on the average of the test run average temperatures;

(2) Mercury in excess of 120 µg/dscm corrected to 7 percent oxygen;

(3) Lead and cadmium in excess of 180 µg/dscm, combined emissions, corrected to 7 percent oxygen;

(4) Arsenic, beryllium, and chromium in excess of 54 µg/dscm, combined emissions, corrected to 7 percent oxygen;

(5) *Carbon monoxide and hydrocarbons.* (i) For kilns equipped with a by-pass duct or midkiln gas sampling system, carbon monoxide and hydrocarbons emissions are limited in both the bypass duct or midkiln gas sampling system and the main stack as follows:

(A) Emissions in the by-pass or midkiln gas sampling system are limited to either:

(1) Carbon monoxide in excess of 100 parts per million by volume, over an hourly rolling average (monitored continuously with a continuous emissions monitoring system), dry basis and corrected to 7 percent oxygen. If you elect to comply with this carbon monoxide standard rather than the hydrocarbon standard under paragraph (b)(5)(i)(A)(2) of this section, you also must document that, during the destruction and removal efficiency (DRE) test runs or their equivalent as provided by §63.1206(b)(7), hydrocarbons do not exceed 10 parts per million by volume during those runs, over an hourly rolling average (monitored continuously with a continuous emissions monitoring system), dry basis, corrected to 7 percent oxygen, and reported as propane; or

(2) Hydrocarbons in the by-pass duct or midkiln gas sampling system in excess of 10 parts per million by volume, over an hourly rolling average (monitored continuously with a continuous emissions monitoring system), dry basis, corrected to 7 percent oxygen, and reported as propane; and

(B) Hydrocarbons in the main stack are limited, if construction of the kiln commenced after April 19, 1996 at a plant site where a cement kiln (whether burning hazardous waste or not) did not previously exist, to 50 parts per million by volume, over a 30-day block average (monitored continuously with a continuous monitoring system), dry basis, corrected to 7 percent oxygen, and reported as propane.

(ii) For kilns not equipped with a by-pass duct or midkiln gas sampling system, hydrocarbons and carbon monoxide are limited in the main stack to either:

(A) Hydrocarbons not exceeding 20 parts per million by volume, over an hourly rolling average (monitored continuously with a continuous emissions monitoring system), dry basis, corrected to 7 percent oxygen, and reported as propane; or

(B)(1) Carbon monoxide not exceeding 100 parts per million by volume, over an hourly rolling average (monitored continuously with a continuous emissions monitoring system), dry basis, corrected to 7 percent oxygen; and

(2) Hydrocarbons not exceeding 20 parts per million by volume, over an hourly rolling average (monitored continuously with a continuous monitoring system), dry basis, corrected to 7 percent oxygen, and reported as propane at any time during the destruction and removal efficiency (DRE) test runs or their equivalent as provided by §63.1206(b)(7); and

(3) If construction of the kiln commenced after April 19, 1996 at a plant site where a cement kiln (whether burning hazardous waste or not) did not previously exist, hydrocarbons are limited to 50 parts per million by volume, over a 30-day block average (monitored continuously with a continuous monitoring system), dry basis, corrected to 7 percent oxygen, and reported as propane.

(6) Hydrochloric acid and chlorine gas in excess of 86 parts per million, combined emissions, expressed as hydrochloric acid equivalents, dry basis and corrected to 7 percent oxygen; and

(7) Particulate matter in excess of 0.15 kg/Mg dry feed and opacity greater than 20 percent.

(i) You must use suitable methods to determine the kiln raw material feedrate.

(ii) Except as provided in paragraph (a)(7)(iii) of this section, you must compute the particulate matter emission rate, E , from the equation specified in paragraph (a)(7)(ii) of this section.

(iii) If you operate a preheater or preheater/precalciner kiln with dual stacks, you must test simultaneously and compute the combined particulate matter emission rate, E_c , from the equation specified in paragraph (a)(7)(iii) of this section.

(c) *Destruction and removal efficiency (DRE) standard*—(1) 99.99% DRE. Except as provided in paragraph (c)(2) of this section, you must achieve a destruction and removal efficiency (DRE) of 99.99% for each principle organic hazardous constituent (POHC) designated under paragraph (c)(3) of this section. You must calculate DRE for each POHC from the following equation:

$$DRE = [1 - (W_{out}/W_{in})] \times 100\%$$

Where:

W_{in} = mass feedrate of one principal organic hazardous constituent (POHC) in a waste feedstream; and

W_{out} = mass emission rate of the same POHC present in exhaust emissions prior to release to the atmosphere.

(2) *99.9999% DRE*. If you burn the dioxin-listed hazardous wastes F020, F021, F022, F023, F026, or F027 (see §261.31 of this chapter), you must achieve a destruction and removal efficiency (DRE) of 99.9999% for each principle organic hazardous constituent (POHC) that you designate under paragraph (c)(3) of this section. You must demonstrate this DRE performance on POHCs that are more difficult to incinerate than tetra-, penta-, and hexachlorodibenzo-*p*-dioxins and dibenzofurans. You must use the equation in paragraph (c)(1) of this section to calculate DRE for each POHC. In addition, you must notify the Administrator of your intent to incinerate hazardous wastes F020, F021, F022, F023, F026, or F027.

(3) *Principal organic hazardous constituents (POHCs)*. (i) You must treat the Principal Organic Hazardous Constituents (POHCs) in the waste feed that you specify under paragraph (c)(3)(ii) of this section to the extent required by paragraphs (c)(1) and (c)(2) of this section.

(ii) You must specify one or more POHCs that are representative of the most difficult to destroy organic compounds in your hazardous waste feedstream. You must base this specification on the degree of difficulty of incineration of the organic constituents in the hazardous waste and on their concentration or mass in the hazardous waste feed, considering the results of hazardous waste analyses or other data and information.

(d) *Cement kilns with in-line kiln raw mills*—(1) *General*. (i) You must conduct performance testing when the raw mill is on-line and when the mill is off-line to demonstrate compliance with the emission standards, and you must establish separate operating parameter limits under §63.1209 for each mode of operation, except as provided by paragraph (d)(1)(iv) of this section.

(ii) You must document in the operating record each time you change from one mode of operation to the alternate mode and begin complying with the operating parameter limits for that alternate mode of operation.

(iii) You must calculate rolling averages for operating parameter limits as provided by §63.1209(q)(2).

(iv) If your in-line kiln raw mill has dual stacks, you may assume that the dioxin/furan emission levels in the by-pass stack and the operating parameter limits determined during performance testing of the by-pass stack when the raw mill is off-line are the same as when the mill is on-line.

(2) *Emissions averaging*. You may comply with the mercury, semivolatile metal, low volatile metal, and hydrochloric acid/chlorine gas emission standards on a time-weighted average basis under the following procedures:

(i) *Averaging methodology*. You must calculate the time-weighted average emission concentration with the following equation:

$$C_{total} = \{C_{mill-off} \times (T_{mill-off} / (T_{mill-off} + T_{mill-on}))\} + \{C_{mill-on} \times (T_{mill-on} / (T_{mill-off} + T_{mill-on}))\}$$

Where:

C_{total} = time-weighted average concentration of a regulated constituent considering both raw mill on time and off time;

$C_{mill-off}$ = average performance test concentration of regulated constituent with the raw mill off-line;

$C_{mill-on}$ = average performance test concentration of regulated constituent with the raw mill on-line;

$T_{\text{mill-off}}$ = time when kiln gases are not routed through the raw mill; and

$T_{\text{mill-on}}$ = time when kiln gases are routed through the raw mill.

(ii) *Compliance.* (A) If you use this emission averaging provision, you must document in the operating record compliance with the emission standards on an annual basis by using the equation provided by paragraph (d)(2) of this section.

(B) Compliance is based on one-year block averages beginning on the day you submit the initial notification of compliance.

(iii) *Notification.* (A) If you elect to document compliance with one or more emission standards using this emission averaging provision, you must notify the Administrator in the initial comprehensive performance test plan submitted under §63.1207(e).

(B) You must include historical raw mill operation data in the performance test plan to estimate future raw mill down-time and document in the performance test plan that estimated emissions and estimated raw mill down-time will not result in an exceedance of an emission standard on an annual basis.

(C) You must document in the notification of compliance submitted under §63.1207(j) that an emission standard will not be exceeded based on the documented emissions from the performance test and predicted raw mill down-time.

(e) *Preheater or preheater/precalciner kilns with dual stacks—(1) General.* You must conduct performance testing on each stack to demonstrate compliance with the emission standards, and you must establish operating parameter limits under §63.1209 for each stack, except as provided by paragraph (d)(1)(iv) of this section for dioxin/furan emissions testing and operating parameter limits for the by-pass stack of in-line raw mills.

(2) *Emissions averaging.* You may comply with the mercury, semivolatile metal, low volatile metal, and hydrochloric acid/chlorine gas emission standards specified in this section on a gas flowrate-weighted average basis under the following procedures:

(i) *Averaging methodology.* You must calculate the gas flowrate-weighted average emission concentration using the following equation:

$$C_{\text{tot}} = \{C_{\text{main}} \times (Q_{\text{main}} / (Q_{\text{main}} + Q_{\text{bypass}}))\} + \{C_{\text{bypass}} \times (Q_{\text{bypass}} / (Q_{\text{main}} + Q_{\text{bypass}}))\}$$

Where:

C_{tot} = gas flowrate-weighted average concentration of the regulated constituent;

C_{main} = average performance test concentration demonstrated in the main stack;

C_{bypass} = average performance test concentration demonstrated in the bypass stack;

Q_{main} = volumetric flowrate of main stack effluent gas; and

Q_{bypass} = volumetric flowrate of bypass effluent gas.

(ii) *Compliance.* (A) You must demonstrate compliance with the emission standard(s) using the emission concentrations determined from the performance tests and the equation provided by paragraph (e)(1) of this section; and

(B) You must develop operating parameter limits for bypass stack and main stack flowrates that ensure the emission concentrations calculated with the equation in paragraph (e)(1) of this section do not exceed the emission standards on a 12-hour rolling average basis. You must include these flowrate limits in the Notification of Compliance.

(iii) *Notification.* If you elect to document compliance under this emissions averaging provision, you must:

(A) Notify the Administrator in the initial comprehensive performance test plan submitted under §63.1207(e). The performance test plan must include, at a minimum, information describing the flowrate limits established under paragraph (e)(2)(ii)(B) of this section; and

(B) Document in the Notification of Compliance submitted under §63.1207(j) the demonstrated gas flowrate-weighted average emissions that you calculate with the equation provided by paragraph (e)(2) of this section.

(f) *Significant figures.* The emission limits provided by paragraphs (a) and (b) of this section are presented with two significant figures. Although you must perform intermediate calculations using at least three significant figures, you may round the resultant emission levels to two significant figures to document compliance.

(g) [Reserved]

(h) When you comply with the particulate matter requirements of paragraphs (a)(7) or (b)(7) of this section, you are exempt from the New Source Performance Standard for particulate matter and opacity under §60.60 of this chapter.

(i) The provisions of this section no longer apply after any of the following dates, whichever occurs first:

(1) The date that your source begins to comply with §63.1220 by placing a Documentation of Compliance in the operating record pursuant to §63.1211(c);

(2) The date that your source begins to comply with §63.1220 by submitting a Notification of Compliance pursuant to §63.1210(b); or

(3) The date for your source to comply with §63.1220 pursuant to §63.1206 and any extensions granted there under.

[67 FR 6809, Feb. 13, 2002, as amended at 67 FR 6987, Feb. 14, 2002; 70 FR 59541, Oct. 12, 2005; 73 FR 18979, Apr. 8, 2008]

 [Back to Top](#)

§63.1205 What are the standards for hazardous waste burning lightweight aggregate kilns that are effective until compliance with the standards under §63.1221?

(a) *Emission limits for existing sources.* You must not discharge or cause combustion gases to be emitted into the atmosphere that contain:

(1) For dioxins and furans:

(i) Emissions in excess of 0.20 ng TEQ/dscm corrected to 7 percent oxygen; or

(ii) Rapid quench of the combustion gas temperature at the exit of the (last) combustion chamber (or exit of any waste heat recovery system) to 400 °F or lower based on the average of the test run average temperatures. You must also notify in writing the RCRA authority that you are complying with this option;

(2) Mercury in excess of 120 µg/dscm corrected to 7 percent oxygen;

(3) Lead and cadmium in excess of 250 µg/dscm, combined emissions, corrected to 7 percent oxygen;

(4) Arsenic, beryllium, and chromium in excess of 110 µg/dscm, combined emissions, corrected to 7 percent oxygen;

(5) *Carbon monoxide and hydrocarbons.* (i) Carbon monoxide in excess of 100 parts per million by volume, over an hourly rolling average (monitored continuously with a continuous emissions monitoring system), dry basis and corrected to 7 percent oxygen. If you elect to comply with this carbon monoxide standard rather than the hydrocarbon standard under paragraph (a)(5)(ii) of this section, you also must document that, during the destruction and removal efficiency (DRE) test runs or their equivalent as provided by §63.1206(b)(7), hydrocarbons do not exceed 20 parts per million by volume during those runs, over an hourly rolling average (monitored continuously with a continuous emissions monitoring system), dry basis, corrected to 7 percent oxygen, and reported as propane; or

(ii) Hydrocarbons in excess of 20 parts per million by volume, over an hourly rolling average, dry basis, corrected to 7 percent oxygen, and reported as propane;

(6) Hydrochloric acid and chlorine gas in excess of 600 parts per million by volume, combined emissions, expressed as hydrochloric acid equivalents, dry basis and corrected to 7 percent oxygen; and

(7) Particulate matter in excess of 57 mg/dscm corrected to 7 percent oxygen.

(b) *Emission limits for new sources.* You must not discharge or cause combustion gases to be emitted into the atmosphere that contain:

(1) For dioxins and furans:

(i) Emissions in excess of 0.20 ng TEQ/dscm corrected to 7 percent oxygen; or

(ii) Rapid quench of the combustion gas temperature at the exit of the (last) combustion chamber (or exit of any waste heat recovery system) to 400 °F or lower based on the average of the test run average temperatures. You must also notify in writing the RCRA authority that you are complying with this option;

(2) Mercury in excess of 120 µg/dscm corrected to 7 percent oxygen;

(3) Lead and cadmium in excess of 43 µg/dscm, combined emissions, corrected to 7 percent oxygen;

(4) Arsenic, beryllium, and chromium in excess of 110 µg/dscm, combined emissions, corrected to 7 percent oxygen;

(5) *Carbon monoxide and hydrocarbons.* (i) Carbon monoxide in excess of 100 parts per million by volume, over an hourly rolling average (monitored continuously with a continuous emissions monitoring

system), dry basis and corrected to 7 percent oxygen. If you elect to comply with this carbon monoxide standard rather than the hydrocarbon standard under paragraph (b)(5)(ii) of this section, you also must document that, during the destruction and removal efficiency (DRE) test runs or their equivalent as provided by §63.1206(b)(7), hydrocarbons do not exceed 20 parts per million by volume during those runs, over an hourly rolling average (monitored continuously with a continuous emissions monitoring system), dry basis, corrected to 7 percent oxygen, and reported as propane; or

(ii) Hydrocarbons in excess of 20 parts per million by volume, over an hourly rolling average, dry basis, corrected to 7 percent oxygen, and reported as propane;

(6) Hydrochloric acid and chlorine gas in excess of 600 parts per million by volume, combined emissions, expressed as hydrochloric acid equivalents, dry basis and corrected to 7 percent oxygen; and

(7) Particulate matter in excess of 57 mg/dscm corrected to 7 percent oxygen.

(c) *Destruction and removal efficiency (DRE) standard*—(1) *99.99% DRE*. Except as provided in paragraph (c)(2) of this section, you must achieve a destruction and removal efficiency (DRE) of 99.99% for each principal organic hazardous constituent (POHC) designated under paragraph (c)(3) of this section. You must calculate DRE for each POHC from the following equation:

$$\text{DRE} = [1 - (W_{\text{out}} / W_{\text{in}})] \times 100\%$$

Where:

W_{in} = mass feedrate of one principal organic hazardous constituent (POHC) in a waste feedstream; and

W_{out} = mass emission rate of the same POHC present in exhaust emissions prior to release to the atmosphere.

(2) *99.9999% DRE*. If you burn the dioxin-listed hazardous wastes F020, F021, F022, F023, F026, or F027 (see §261.31 of this chapter), you must achieve a destruction and removal efficiency (DRE) of 99.9999% for each principal organic hazardous constituent (POHC) that you designate under paragraph (c)(3) of this section. You must demonstrate this DRE performance on POHCs that are more difficult to incinerate than tetra-, penta-, and hexachlorodibenzo-dioxins and dibenzofurans. You must use the equation in paragraph (c)(1) of this section to calculate DRE for each POHC. In addition, you must notify the Administrator of your intent to burn hazardous wastes F020, F021, F022, F023, F026, or F027.

(3) *Principal organic hazardous constituents (POHCs)*. (i) You must treat the Principal Organic Hazardous Constituents (POHCs) in the waste feed that you specify under paragraph (c)(3)(ii) of this section to the extent required by paragraphs (c)(1) and (c)(2) of this section.

(ii) You must specify one or more POHCs that are representative of the most difficult to destroy organic compounds in your hazardous waste feedstream. You must base this specification on the degree of difficulty of incineration of the organic constituents in the hazardous waste and on their concentration or mass in the hazardous waste feed, considering the results of hazardous waste analyses or other data and information.

(d) *Significant figures*. The emission limits provided by paragraphs (a) and (b) of this section are presented with two significant figures. Although you must perform intermediate calculations using at least three significant figures, you may round the resultant emission levels to two significant figures to document compliance.

(e) The provisions of this section no longer apply after any of the following dates, whichever occurs first:

(1) The date that your source begins to comply with §63.1221 by placing a Documentation of Compliance in the operating record pursuant to §63.1211(c);

(2) The date that your source begins to comply with §63.1221 by submitting a Notification of Compliance pursuant to §63.1210(b); or

(3) The date for your source to comply with §63.1221 pursuant to §63.1206 and any extensions granted there under.

[67 FR 6812, Feb. 13, 2002, as amended at 67 FR 77691, Dec. 19, 2002; 70 FR 59541, Oct. 12, 2005; 73 FR 18979, Apr. 8, 2008]

[↑ Back to Top](#)

MONITORING AND COMPLIANCE PROVISIONS

[↑ Back to Top](#)

§63.1206 When and how must you comply with the standards and operating requirements?

(a) *Compliance dates*—(1) *Compliance dates for incinerators, cement kilns, and lightweight aggregate kilns that burn hazardous waste*—(i) *Compliance date for standards under §§63.1203, 63.1204, and 63.1205*—(A) *Compliance dates for existing sources.* You must comply with the emission standards under §§63.1203, 63.1204, and 63.1205 and the other requirements of this subpart no later than the compliance date, September 30, 2003, unless the Administrator grants you an extension of time under §63.6(i) or §63.1213, except:

(1) Cement kilns are exempt from the bag leak detection system requirements under paragraph (c)(8) of this section;

(2) The bag leak detection system required under §63.1206(c)(8) must be capable of continuously detecting and recording particulate matter emissions at concentrations of 1.0 milligram per actual cubic meter unless you demonstrate under §63.1209(g)(1) that a higher detection limit would adequately detect bag leaks, in lieu of the requirement for the higher detection limit under paragraph (c)(8)(ii)(A) of this section; and

(3) The excessive exceedances notification requirements for bag leak detection systems under paragraph (c)(8)(iv) of this section are waived.

(B) *New or reconstructed sources.* (1) If you commenced construction or reconstruction of your hazardous waste combustor after April 19, 1996, you must comply with the emission standards under §§63.1203, 63.1204, and 63.1205 and the other requirements of this subpart by the later of September 30, 1999 or the date the source starts operations, except as provided by paragraphs (a)(1)(i)(A)(1) through (3) and (a)(1)(i)(B)(2) of this section. The costs of retrofitting and replacement of equipment that is installed specifically to comply with this subpart, between April 19, 1996 and a source's compliance date, are not considered to be reconstruction costs.

(2) For a standard under §§63.1203, 63.1204, and 63.1205 that is more stringent than the standard proposed on April 19, 1996, you may achieve compliance no later than September 30, 2003 if you comply with the standard proposed on April 19, 1996 after September 30, 1999. This exception does not apply, however, to new or reconstructed area source hazardous waste combustors that become major sources after September 30, 1999. As provided by §63.6(b)(7), such sources must comply with the standards under §§63.1203, 63.1204, and 63.1205 at startup.

(ii) *Compliance date for standards under §§63.1219, 63.1220, and 63.1221—(A) Compliance dates for existing sources.* You must comply with the emission standards under §§63.1219, 63.1220, and 63.1221 and the other requirements of this subpart no later than the compliance date, October 14, 2008, unless the Administrator grants you an extension of time under §63.6(i) or §63.1213.

(B) *New or reconstructed sources.* (1) If you commenced construction or reconstruction of your hazardous waste combustor after April 20, 2004, you must comply with the new source emission standards under §§63.1219, 63.1220, and 63.1221 and the other requirements of this subpart by the later of October 12, 2005 or the date the source starts operations, except as provided by paragraphs (a)(1)(ii)(B)(2) and (a)(1)(ii)(B)(3) of this section. The costs of retrofitting and replacement of equipment that is installed specifically to comply with this subpart, between April 20, 2004, and a source's compliance date, are not considered to be reconstruction costs.

(2) For a standard under §§63.1219, 63.1220, and 63.1221 that is more stringent than the standard proposed on April 20, 2004, you may achieve compliance no later than October 14, 2008, if you comply with the standard proposed on April 20, 2004, after October 12, 2005. This exception does not apply, however, to new or reconstructed area source hazardous waste combustors that become major sources after October 14, 2008. As provided by §63.6(b)(7), such sources must comply with the standards under §§63.1219, 63.1220, and 63.1221 at startup.

(3) If you commenced construction or reconstruction of a cement kiln after April 20, 2004, you must comply with the new source emission standard for particulate matter under §63.1220(b)(7)(i) by the later of October 28, 2008 or the date the source starts operations.

(2) *Compliance date for solid fuel boilers, liquid fuel boilers, and hydrochloric acid production furnaces that burn hazardous waste for standards under §§63.1216, 63.1217, and 63.1218.* (i) *Compliance date for existing sources.* You must comply with the standards of this subpart no later than the compliance date, October 14, 2008, unless the Administrator grants you an extension of time under §63.6(i) or §63.1213.

(ii) *New or reconstructed sources.* (A) If you commenced construction or reconstruction of your hazardous waste combustor after April 20, 2004, you must comply with the new source emission standards of this subpart by the later of October 12, 2005, or the date the source starts operations, except as provided by paragraph (a)(2)(ii)(B) of this section. The costs of retrofitting and replacement of equipment that is installed specifically to comply with this subpart, between April 20, 2004, and a source's compliance date, are not considered to be reconstruction costs.

(B) For a standard in the subpart that is more stringent than the standard proposed on April 20, 2004, you may achieve compliance no later than October 14, 2008, if you comply with the standard proposed on April 20, 2004, after October 12, 2005. This exception does not apply, however, to new or reconstructed area source hazardous waste combustors that become major sources after October 14, 2008. As provided by §63.6(b)(7), such sources must comply with this subpart at startup.

(3) *Early compliance.* If you choose to comply with the emission standards of this subpart prior to the dates specified in paragraphs (a)(1) and (a)(2) of this section, your compliance date is the earlier of the date you postmark the Notification of Compliance under §63.1207(j)(1) or the dates specified in paragraphs (a)(1) and (a)(2) of this section.

(b) *Compliance with standards—(1) Applicability.* The emission standards and operating requirements set forth in this subpart apply at all times except:

(i) During periods of startup, shutdown, and malfunction; and

(ii) When hazardous waste is not in the combustion chamber (i.e., the hazardous waste feed to the combustor has been cut off for a period of time not less than the hazardous waste residence time) and you have documented in the operating record that you are complying with all otherwise applicable requirements and standards promulgated under authority of sections 112 (e.g., 40 CFR part 63, subparts LLL, DDDDD, and NNNNN) or 129 of the Clean Air Act in lieu of the emission standards under §§63.1203, 63.1204, 63.1205, 63.1215, 63.1216, 63.1217, 63.1218, 63.1219, 63.1220, and 63.1221; the monitoring and compliance standards of this section and §§63.1207 through 63.1209, except the modes of operation requirements of §63.1209(q); and the notification, reporting, and recordkeeping requirements of §§63.1210 through 63.1212.

(2) *Methods for determining compliance.* The Administrator will determine compliance with the emission standards of this subpart as provided by §63.6(f)(2). Conducting performance testing under operating conditions representative of the extreme range of normal conditions is consistent with the requirements of §§63.6(f)(2)(iii)(B) and 63.7(e)(1) to conduct performance testing under representative operating conditions.

(3) *Finding of compliance.* The Administrator will make a finding concerning compliance with the emission standards and other requirements of this subpart as provided by §63.6(f)(3).

(4) *Extension of compliance with emission standards.* The Administrator may grant an extension of compliance with the emission standards of this subpart as provided by §§63.6(i) and 63.1213.

(5) *Changes in design, operation, or maintenance—(i) Changes that may adversely affect compliance.* If you plan to change (as defined in paragraph (b)(5)(iii) of this section) the design, operation, or maintenance practices of the source in a manner that may adversely affect compliance with any emission standard that is not monitored with a CEMS:

(A) *Notification.* You must notify the Administrator at least 60 days prior to the change, unless you document circumstances that dictate that such prior notice is not reasonably feasible. The notification must include:

(1) A description of the changes and which emission standards may be affected; and

(2) A comprehensive performance test schedule and test plan under the requirements of §63.1207(f) that will document compliance with the affected emission standard(s);

(B) *Performance test.* You must conduct a comprehensive performance test under the requirements of §§63.1207(f)(1) and (g)(1) to document compliance with the affected emission standard(s) and establish operating parameter limits as required under §63.1209, and submit to the Administrator a Notification of Compliance under §§63.1207(j) and 63.1210(d); and

(C) *Restriction on waste burning.* (1) Except as provided by paragraph (b)(5)(i)(C)(2) of this section, after the change and prior to submitting the notification of compliance, you must not burn hazardous waste for more than a total of 720 hours (renewable at the discretion of the Administrator) and only for the purposes of pretesting or comprehensive performance testing. Pretesting is defined at §63.1207(h)(2)(i) and (ii).

(2) You may petition the Administrator to obtain written approval to burn hazardous waste in the interim prior to submitting a Notification of Compliance for purposes other than testing or pretesting. You must specify operating requirements, including limits on operating parameters, that you determine will ensure compliance with the emission standards of this subpart based on available information. The Administrator will review, modify as necessary, and approve if warranted the interim operating requirements.

(ii) *Changes that will not affect compliance.* If you determine that a change will not adversely affect compliance with the emission standards or operating requirements, you must document the change in the operating record upon making such change. You must revise as necessary the performance test plan, Documentation of Compliance, Notification of Compliance, and start-up, shutdown, and malfunction plan to reflect these changes.

(iii) *Definition of "change."* For purposes of paragraph (b)(5) of this section, "change" means any change in design, operation, or maintenance practices that were documented in the comprehensive performance test plan, Notification of Compliance, or startup, shutdown, and malfunction plan.

(6) *Compliance with the carbon monoxide and hydrocarbon emission standards.* This paragraph applies to sources that elect to comply with the carbon monoxide and hydrocarbon emissions standards of this subpart by documenting continuous compliance with the carbon monoxide standard using a continuous emissions monitoring system and documenting compliance with the hydrocarbon standard during the destruction and removal efficiency (DRE) performance test or its equivalent.

(i) If a DRE test performed pursuant to §63.1207(c)(2) is acceptable as documentation of compliance with the DRE standard, you may use the highest hourly rolling average hydrocarbon level achieved during the DRE test runs to document compliance with the hydrocarbon standard. An acceptable DRE test is any test for which the data and results are determined to meet quality assurance objectives (on a site-specific basis) such that the results adequately demonstrate compliance with the DRE standard.

(ii) If during this acceptable DRE test you did not obtain hydrocarbon emissions data sufficient to document compliance with the hydrocarbon standard, you must either:

(A) Perform, as part of the performance test, an "equivalent DRE test" to document compliance with the hydrocarbon standard. An equivalent DRE test is comprised of a minimum of three runs each with a minimum duration of one hour during which you operate the combustor as close as reasonably possible to the operating parameter limits that you established based on the initial DRE test. You must use the highest hourly rolling average hydrocarbon emission level achieved during the equivalent DRE test to document compliance with the hydrocarbon standard; or

(B) Perform a DRE test as part of the performance test.

(7) *Compliance with the DRE standard.* (i) Except as provided in paragraphs (b)(7)(ii) and (b)(7)(iii) of this section:

(A) You must document compliance with the Destruction and Removal Efficiency (DRE) standard under this subpart only once provided that you do not modify the source after the DRE test in a manner that could affect the ability of the source to achieve the DRE standard.

(B) You may use any DRE test data that documents that your source achieves the required level of DRE provided:

(1) You have not modified the design or operation of your source in a manner that could effect the ability of your source to achieve the DRE standard since the DRE test was performed; and,

(2) The DRE test data meet quality assurance objectives determined on a site-specific basis.

(ii) *Sources that feed hazardous waste at locations other than the normal flame zone.* (A) Except as provided by paragraph (b)(7)(ii)(B) of this section, if you feed hazardous waste at a location in the

combustion system other than the normal flame zone, then you must demonstrate compliance with the DRE standard during each comprehensive performance test;

(B)(1) A cement kiln that feeds hazardous waste at a location other than the normal flame zone need only demonstrate compliance with the DRE standard during three consecutive comprehensive performance tests provided that:

(i) All three tests achieve the DRE standard in this subpart; and

(ii) The design, operation, and maintenance features of each of the three tests are similar;

(iii) The data in lieu restriction of §63.1207(c)(2)(iv) does not apply when complying with the provisions of paragraph (b)(7)(ii)(B) of this section;

(2) If at any time you change your design, operation, and maintenance features in a manner that could reasonably be expected to affect your ability to meet the DRE standard, then you must comply with the requirements of paragraph (b)(7)(ii)(A) of this section.

(iii) For sources that do not use DRE previous testing to document conformance with the DRE standard pursuant to §63.1207(c)(2), you must perform DRE testing during the initial comprehensive performance test.

(8) *Applicability of particulate matter and opacity standards during particulate matter CEMS correlation tests.* (i) Any particulate matter and opacity standards of parts 60, 61, 63, 264, 265, and 266 of this chapter (i.e., any title 40 particulate or opacity standards) applicable to a hazardous waste combustor do not apply while you conduct particulate matter continuous emissions monitoring system (CEMS) correlation tests (i.e., correlation with manual stack methods) under the conditions of paragraphs (b)(8)(iii) through (vii) of this section.

(ii) Any permit or other emissions or operating parameter limits or conditions, including any limitation on workplace practices, that are applicable to hazardous waste combustors to ensure compliance with any particulate matter and opacity standards of parts 60, 61, 63, 264, 265, and 266 of this chapter (i.e., any title 40 particulate or opacity standards) do not apply while you conduct particulate matter CEMS correlation tests under the conditions of paragraphs (b)(8)(iii) through (vii) of this section.

(iii) For the provisions of this section to apply, you must:

(A) Develop a particulate matter CEMS correlation test plan that includes the following information. This test plan may be included as part of the comprehensive performance test plan required under §§63.1207(e) and (f):

(1) Number of test conditions and number of runs for each test condition;

(2) Target particulate matter emission level for each test condition;

(3) How you plan to modify operations to attain the desired particulate matter emission levels; and

(4) Anticipated normal particulate matter emission levels; and

(B) Submit the test plan to the Administrator for approval at least 90 calendar days before the correlation test is scheduled to be conducted.

(iv) The Administrator will review and approve/disapprove the correlation test plan under the procedures for review and approval of the site-specific test plan provided by §63.7(c)(3)(i) and (iii). If the Administrator fails to approve or disapprove the correlation test plan within the time period specified by §63.7(c)(3)(i), the plan is considered approved, unless the Administrator has requested additional information.

(v) The particulate matter and opacity standards and associated operating limits and conditions will not be waived for more than 96 hours, in the aggregate, for a correlation test, including all runs of all test conditions, unless more time is approved by the Administrator.

(vi) The stack sampling team must be on-site and prepared to perform correlation testing no later than 24 hours after you modify operations to attain the desired particulate matter emissions concentrations, unless you document in the correlation test plan that a longer period of conditioning is appropriate.

(vii) You must return to operating conditions indicative of compliance with the applicable particulate matter and opacity standards as soon as possible after correlation testing is completed.

(9) *Alternative standards for existing or new hazardous waste burning lightweight aggregate kilns using MACT.* (i) You may petition the Administrator to request alternative standards to the mercury or hydrogen chloride/chlorine gas emission standards of this subpart, to the semivolatile metals emission standards under §§63.1205, 63.1221(a)(3)(ii), or 63.1221(b)(3)(ii), or to the low volatile metals emissions standards under §§63.1205, 63.1221(a)(4)(ii), or 63.1221(b)(4)(ii) if:

(A) You cannot achieve one or more of these standards while using maximum achievable control technology (MACT) because of raw material contributions to emissions of mercury, semivolatile metals, low volatile metals, or hydrogen chloride/chlorine gas; or

(B) You determine that mercury is not present at detectable levels in your raw material.

(ii) The alternative standard that you recommend under paragraph (b)(9)(i)(A) of this section may be an operating requirement, such as a hazardous waste feedrate limitation for metals and/or chlorine, and/or an emission limitation.

(iii) The alternative standard must include a requirement to use MACT, or better, applicable to the standard for which the source is seeking relief, as defined in paragraphs (b)(9)(viii) and (ix) of this section.

(iv) *Documentation required.* (A) The alternative standard petition you submit under paragraph (b)(9)(i)(A) of this section must include data or information documenting that raw material contributions to emissions prevent you from complying with the emission standard even though the source is using MACT, as defined under paragraphs (b)(9)(viii) and (ix) of this section, for the standard for which you are seeking relief.

(B) Alternative standard petitions that you submit under paragraph (b)(9)(i)(B) of this section must include data or information documenting that mercury is not present at detectable levels in raw materials.

(v) You must include data or information with semivolatile metal and low volatility metal alternative standard petitions that you submit under paragraph (b)(9)(i)(A) of this section documenting that increased chlorine feedrates associated with the burning of hazardous waste, when compared to non-hazardous waste operations, do not significantly increase metal emissions attributable to raw materials.

(vi) You must include data or information with semivolatile metals, low volatile metals, and hydrogen chloride/chlorine gas alternative standard petitions that you submit under paragraph (b)(9)(i)(A) of this

section documenting that semivolatile metals, low volatile metals, and hydrogen chloride/chlorine gas emissions attributable to the hazardous waste only will not exceed the emission standards of this subpart.

(vii) You must not operate pursuant to your recommended alternative standards in lieu of emission standards specified in this subpart:

(A) Unless the Administrator approves the provisions of the alternative standard petition request or establishes other alternative standards; and

(B) Until you submit a revised Notification of Compliance that incorporates the revised standards.

(viii) For purposes of this alternative standard provision, MACT for existing hazardous waste burning lightweight aggregate kilns is defined as:

(A) For mercury, a hazardous waste feedrate corresponding to an MTEC of 24 µg/dscm or less;

(B) For semivolatile metals, a hazardous waste feedrate corresponding to an MTEC of 280,000 µg/dscm or less, and use of a particulate matter control device that achieves particulate matter emissions of 57 mg/dscm or less;

(C) For low volatile metals, a hazardous waste feedrate corresponding to an MTEC of 120,000 µg/dscm or less, and use of a particulate matter control device that achieves particulate matter emissions of 57 mg/dscm or less; and

(D) For hydrogen chloride/chlorine gas, a hazardous waste chlorine feedrate corresponding to an MTEC of 2,000,000 µgm/dscm or less, and use of an air pollution control device with a hydrogen chloride/chlorine gas removal efficiency of 85 percent or greater.

(ix) For purposes of this alternative standard provision, MACT for new hazardous waste burning lightweight aggregate kilns is defined as:

(A) For mercury, a hazardous waste feedrate corresponding to an MTEC of 4 µg/dscm or less;

(B) For semivolatile metals, a hazardous waste feedrate corresponding to an MTEC of 280,000 µg/dscm or less, and use of a particulate matter control device that achieves particulate matter emissions of 57 mg/dscm or less;

(C) For low volatile metals, a hazardous waste feedrate corresponding to an MTEC of 46,000 µg/dscm or less, and use of a particulate matter control device that achieves particulate matter emissions of 57 mg/dscm or less;

(D) For hydrogen chloride/chlorine gas, a hazardous waste chlorine feedrate corresponding to an MTEC of 14,000,000 µgm/dscm or less, and use of an air pollution control device with a hydrogen chloride/chlorine gas removal efficiency of 99.6 percent or greater.

(10) *Alternative standards for existing or new hazardous waste burning cement kilns using MACT.* (i) You may petition the Administrator to request alternative standards to the mercury or hydrogen chloride/chlorine gas emission standards of this subpart, to the semivolatile metals emission standards under §§63.1204, 63.1220(a)(3)(ii), or 63.1220(b)(3)(ii), or to the low volatile metals emissions standards under §§63.1204, 63.1220(a)(4)(ii), or 63.1220(b)(4)(ii) if:

(A) You cannot achieve one or more of these standards while using maximum achievable control technology (MACT) because of raw material contributions to emissions of mercury, semivolatile metals, low volatile metals, or hydrogen chloride/chlorine gas; or

(B) You determine that mercury is not present at detectable levels in your raw material.

(ii) The alternative standard that you recommend under paragraph (b)(10)(i)(A) of this section may be an operating requirement, such as a hazardous waste feedrate limitation for metals and/or chlorine, and/or an emission limitation.

(iii) The alternative standard must include a requirement to use MACT, or better, applicable to the standard for which the source is seeking relief, as defined in paragraphs (b)(10)(viii) and (ix) of this section.

(iv) *Documentation required.* (A) The alternative standard petition you submit under paragraph (b)(10)(i)(A) of this section must include data or information documenting that raw material contributions to emissions prevent you from complying with the emission standard even though the source is using MACT, as defined in paragraphs (b)(10)(viii) and (ix) of this section, for the standard for which you are seeking relief.

(B) Alternative standard petitions that you submit under paragraph (b)(10)(i)(B) of this section must include data or information documenting that mercury is not present at detectable levels in raw materials.

(v) You must include data or information with semivolatile metal and low volatile metal alternative standard petitions that you submit under paragraph (b)(10)(i)(A) of this section documenting that increased chlorine feedrates associated with the burning of hazardous waste, when compared to non-hazardous waste operations, do not significantly increase metal emissions attributable to raw materials.

(vi) You must include data or information with semivolatile metals, low volatile metals, and hydrogen chloride/chlorine gas alternative standard petitions that you submit under paragraph (b)(10)(i)(A) of this section documenting that emissions of the regulated metals and hydrogen chloride/chlorine gas attributable to the hazardous waste only will not exceed the emission standards in this subpart.

(vii) You must not operate pursuant to your recommended alternative standards in lieu of emission standards specified in this subpart:

(A) Unless the Administrator approves the provisions of the alternative standard petition request or establishes other alternative standards; and

(B) Until you submit a revised Notification of Compliance that incorporates the revised standards.

(viii) For purposes of this alternative standard provision, MACT for existing hazardous waste burning cement kilns is defined as:

(A) For mercury, a hazardous waste feedrate corresponding to an MTEC of 88 µg/dscm or less;

(B) For semivolatile metals, a hazardous waste feedrate corresponding to an MTEC of 31,000 µg/dscm or less, and use of a particulate matter control device that achieves particulate matter emissions of 0.15 kg/Mg dry feed or less;

(C) For low volatile metals, a hazardous waste feedrate corresponding to an MTEC of 54,000 µg/dscm or less, and use of a particulate matter control device that achieves particulate matter emissions of 0.15 kg/Mg dry feed or less; and

(D) For hydrogen chloride/chlorine gas, a hazardous waste chlorine feedrate corresponding to an MTEC of 720,000 $\mu\text{g}/\text{dscm}$ or less.

(ix) For purposes of this alternative standard provision, MACT for new hazardous waste burning cement kilns is defined as:

(A) For mercury, a hazardous waste feedrate corresponding to an MTEC of 7 $\mu\text{g}/\text{dscm}$ or less;

(B) For semivolatile metals, a hazardous waste feedrate corresponding to an MTEC of 31,000 $\mu\text{g}/\text{dscm}$ or less, and use of a particulate matter control device that achieves particulate matter emissions of 0.15 kg/Mg dry feed or less;

(C) For low volatile metals, a hazardous waste feedrate corresponding to an MTEC of 15,000 $\mu\text{g}/\text{dscm}$ or less, and use of a particulate matter control device that achieves particulate matter emissions of 0.15 kg/Mg dry feed or less;

(D) For hydrogen chloride/chlorine gas, a hazardous waste chlorine feedrate corresponding to an MTEC of 420,000 $\mu\text{g}/\text{dscm}$ or less.

(11) *Calculation of hazardous waste residence time.* You must calculate the hazardous waste residence time and include the calculation in the performance test plan under §63.1207(f) and the operating record. You must also provide the hazardous waste residence time in the Documentation of Compliance under §63.1211(c) and the Notification of Compliance under §§63.1207(j) and 63.1210(d).

(12) *Documenting compliance with the standards based on performance testing.* (i) You must conduct a minimum of three runs of a performance test required under §63.1207 to document compliance with the emission standards of this subpart.

(ii) You must document compliance with the emission standards based on the arithmetic average of the emission results of each run, except that you must document compliance with the destruction and removal efficiency standard for each run of the comprehensive performance test individually.

(13) *Cement kilns and lightweight aggregate kilns that feed hazardous waste at a location other than the end where products are normally discharged and where fuels are normally fired.* (i) Cement kilns that feed hazardous waste at a location other than the end where products are normally discharged and where fuels are normally fired must comply with the carbon monoxide and hydrocarbon standards of this subpart as follows:

(A) For existing sources, you must not discharge or cause combustion gases to be emitted into the atmosphere that contain either:

(1) Hydrocarbons in the main stack in excess of 20 parts per million by volume, over an hourly rolling average (monitored continuously with a continuous emissions monitoring system), dry basis, corrected to 7 percent oxygen, and reported as propane; or

(2) Hydrocarbons both in the by-pass duct and at a preheater tower combustion gas monitoring location in excess of 10 parts per million by volume, at each location, over an hourly rolling average (monitored continuously with a continuous emissions monitoring system), dry basis, corrected to 7 percent oxygen, and reported as propane; or

(3) If the only firing location of hazardous waste upstream (in terms of gas flow) of the point where combustion gases are diverted into the bypass duct is at the kiln end where products are normally discharged, then both hydrocarbons at the preheater tower combustion gas monitoring location in excess

of 10 parts per million by volume, over an hourly rolling average (monitored continuously with a continuous emissions monitoring system), dry basis, corrected to 7 percent oxygen, and reported as propane, and either hydrocarbons in the by-pass duct in excess of 10 parts per million by volume, over an hourly rolling average (monitored continuously with a continuous emissions monitoring system), dry basis, corrected to 7 percent oxygen, and reported as propane, or carbon monoxide in excess of 100 parts per million by volume, over an hourly rolling average (monitored continuously with a continuous emissions monitoring system), dry basis, and corrected to 7 percent oxygen. If you comply with the carbon monoxide standard of 100 parts per million by volume in the by-pass duct, then you must also not discharge or cause combustion gases to be emitted into the atmosphere that contain hydrocarbons in the by-pass duct in excess of 10 parts per million by volume, over an hourly rolling average (monitored continuously with a continuous emissions monitoring system), dry basis, corrected to 7 percent oxygen, and reported as propane, at any time during the destruction and removal efficiency (DRE) test runs or their equivalent as provided by §63.1206(b)(7).

(B) For new sources, you must not discharge or cause combustion gases to be emitted into the atmosphere that contain either:

(1) Hydrocarbons in the main stack in excess of 20 parts per million by volume, over an hourly rolling average (monitored continuously with a continuous emissions monitoring system), dry basis, corrected to 7 percent oxygen, and reported as propane; or

(2)(i) Hydrocarbons both in the by-pass duct and at a preheater tower combustion gas monitoring location in excess of 10 parts per million by volume, at each location, over an hourly rolling average (monitored continuously with a continuous emissions monitoring system), dry basis, corrected to 7 percent oxygen, and reported as propane, and

(ii) Hydrocarbons in the main stack, if construction of the kiln commenced after April 19, 1996 at a plant site where a cement kiln (whether burning hazardous waste or not) did not previously exist, to 50 parts per million by volume, over a 30-day block average (monitored continuously with a continuous emissions monitoring system), dry basis, corrected to 7 percent oxygen, and reported as propane; or

(3)(i) If the only firing location of hazardous waste upstream (in terms of gas flow) of the point where combustion gases are diverted into the bypass duct is at the kiln end where products are normally discharged, then both hydrocarbons at the preheater tower combustion gas monitoring location in excess of 10 parts per million by volume, over an hourly rolling average (monitored continuously with a continuous emissions monitoring system), dry basis, corrected to 7 percent oxygen, and reported as propane, and either hydrocarbons in the by-pass duct in excess of 10 parts per million by volume, over an hourly rolling average (monitored continuously with a continuous emissions monitoring system), dry basis, corrected to 7 percent oxygen, and reported as propane, or carbon monoxide in excess of 100 parts per million by volume, over an hourly rolling average (monitored continuously with a continuous emissions monitoring system), dry basis, and corrected to 7 percent oxygen. If you comply with the carbon monoxide standard of 100 parts per million by volume in the by-pass duct, then you must also not discharge or cause combustion gases to be emitted into the atmosphere that contain hydrocarbons in the by-pass duct in excess of 10 parts per million by volume, over an hourly rolling average (monitored continuously with a continuous emissions monitoring system), dry basis, corrected to 7 percent oxygen, and reported as propane, at any time during the destruction and removal efficiency (DRE) test runs or their equivalent as provided by §63.1206(b)(7).

(ii) If construction of the kiln commenced after April 19, 1996 at a plant site where a cement kiln (whether burning hazardous waste or not) did not previously exist, hydrocarbons are limited to 50 parts per million by volume, over a 30-day block average (monitored continuously with a continuous emissions monitoring system), dry basis, corrected to 7 percent oxygen, and reported as propane.

(ii) Lightweight aggregate kilns that feed hazardous waste at a location other than the end where products are normally discharged and where fuels are normally fired must comply with the hydrocarbon standards of this subpart as follows:

(A) Existing sources must comply with the 20 parts per million by volume hydrocarbon standard of this subpart;

(B) New sources must comply with the 20 parts per million by volume hydrocarbon standard of this subpart.

(14) *Alternative to the particulate matter standard for incinerators*—(i) *General*. In lieu of complying with the particulate matter standards under §63.1203, you may elect to comply with the following alternative metal emission control requirements:

(ii) *Alternative metal emission control requirements for existing incinerators*. (A) You must not discharge or cause combustion gases to be emitted into the atmosphere that contain cadmium, lead, and selenium in excess of 240 µg/dscm, combined emissions, corrected to 7 percent oxygen; and,

(B) You must not discharge or cause combustion gases to be emitted into the atmosphere that contain antimony, arsenic, beryllium, chromium, cobalt, manganese, and nickel in excess of 97 µg/dscm, combined emissions, corrected to 7 percent oxygen.

(iii) *Alternative metal emission control requirements for new incinerators*. (A) You must not discharge or cause combustion gases to be emitted into the atmosphere that contain cadmium, lead, and selenium in excess of 24 µg/dscm, combined emissions, corrected to 7 percent oxygen; and,

(B) You must not discharge or cause combustion gases to be emitted into the atmosphere that contain antimony, arsenic, beryllium, chromium, cobalt, manganese, and nickel in excess of 97 µg/dscm, combined emissions, corrected to 7 percent oxygen.

(iv) *Operating limits*. Semivolatile and low volatile metal operating parameter limits must be established to ensure compliance with the alternative emission limitations described in paragraphs (b)(14)(ii) and (iii) of this section pursuant to §63.1209(n), except that semivolatile metal feedrate limits apply to lead, cadmium, and selenium, combined, and low volatile metal feedrate limits apply to arsenic, beryllium, chromium, antimony, cobalt, manganese, and nickel, combined.

(15) *Alternative to the interim standards for mercury for cement and lightweight aggregate kilns*—(i) *General*. In lieu of complying with the applicable mercury standards of §§63.1204(a)(2) and (b)(2) for existing and new cement kilns and §§63.1205(a)(2) and (b)(2) for existing and new lightweight aggregate kilns, you may instead elect to comply with the alternative mercury standard described in paragraphs (b)(15)(ii) through (b)(15)(v) of this section.

(ii) *Operating requirement*. You must not exceed a hazardous waste feedrate corresponding to a maximum theoretical emission concentration (MTEC) of 120 µg/dscm on a twelve-hour rolling average.

(iii) To document compliance with the operating requirement of paragraph (b)(15)(ii) of this section, you must:

(A) Monitor and record the feedrate of mercury for each hazardous waste feedstream according to §63.1209(c);

(B) Monitor with a CMS and record in the operating record the gas flowrate (either directly or by monitoring a surrogate parameter that you have correlated to gas flowrate);

(C) Continuously calculate and record in the operating record a MTEC assuming mercury from all hazardous waste feedstreams is emitted;

(D) Interlock the MTEC calculated in paragraph (b)(15)(iii)(C) of this section to the AWFCO system to stop hazardous waste burning when the MTEC exceeds the operating requirement of paragraph (b)(15)(ii) of this section.

(iv) In lieu of the requirement in paragraph (b)(15)(iii) of this section, you may:

(A) Identify in the Notification of Compliance a minimum gas flowrate limit and a maximum feedrate limit of mercury from all hazardous waste feedstreams that ensures the MTEC calculated in paragraph (b)(15)(iii)(C) of this section is below the operating requirement of paragraph (b)(15)(ii) of this section; and

(B) Interlock the minimum gas flowrate limit and maximum feedrate limits in paragraph (b)(15)(iv)(A) of this section to the AWFCO system to stop hazardous waste burning when the gas flowrate or mercury feedrate exceeds the limits in paragraph (b)(15)(iv)(A) of this section.

(v) *Notification requirement.* You must notify in writing the RCRA authority that you intend to comply with the alternative standard.

(16) *Compliance with subcategory standards for liquid fuel boilers.* You must comply with the mercury, semivolatile metals, low volatile metals, and hydrogen chloride and chlorine standards for liquid fuel boilers under §63.1217 as follows:

(i) You must determine the as-fired heating value of each batch of hazardous waste fired by each firing system of the boiler so that you know the mass-weighted heating value of the hazardous waste fired at all times.

(ii) If the as-fired heating value of the hazardous waste is 10,000 Btu per pound or greater, you are subject to the thermal emission concentration standards (lb/million Btu) under §63.1217.

(iii) If the as-fired heating value of the hazardous waste is less than 10,000 Btu/lb, you are subject to the mass or volume emission concentration standards (µgm/dscm or ppmv) under §63.1217.

(iv) If the as-fired heating value of hazardous wastes varies above and below 10,000 Btu/lb over time, you are subject to the thermal concentration standards when the heating value is 10,000 Btu/lb or greater and the mass concentration standards when the heating value is less than 10,000 Btu/lb. You may elect to comply at all times with the more stringent operating requirements that ensure compliance with both the thermal emission concentration standards and the mass or volume emission concentration standards.

(c) *Operating requirements—(1) General.* (i) You must operate only under the operating requirements specified in the Documentation of Compliance under §63.1211(c) or the Notification of Compliance under §§63.1207(j) and 63.1210(d), except:

(A) During performance tests under approved test plans according to §63.1207(e), (f), and (g), and

(B) Under the conditions of paragraph (b)(1)(i) or (ii) of this section;

(ii) The Documentation of Compliance and the Notification of Compliance must contain operating requirements including, but not limited to, the operating requirements in this section and §63.1209

(iii) Failure to comply with the operating requirements is failure to ensure compliance with the emission standards of this subpart;

(iv) Operating requirements in the Notification of Compliance are applicable requirements for purposes of parts 70 and 71 of this chapter;

(v) The operating requirements specified in the Notification of Compliance will be incorporated in the title V permit.

(2) *Startup, shutdown, and malfunction plan.* (i) You are subject to the startup, shutdown, and malfunction plan requirements of §63.6(e)(3).

(ii) If you elect to comply with §§270.235(a)(1)(iii), 270.235(a)(2)(iii), or 270.235(b)(1)(ii) of this chapter to address RCRA concerns that you minimize emissions of toxic compounds from startup, shutdown, and malfunction events (including releases from emergency safety vents):

(A) The startup, shutdown, and malfunction plan must include a description of potential causes of malfunctions, including releases from emergency safety vents, that may result in significant releases of hazardous air pollutants, and actions the source is taking to minimize the frequency and severity of those malfunctions.

(B) You must submit the startup, shutdown, and malfunction plan to the Administrator for review and approval.

(1) *Approval procedure.* The Administrator will notify you of approval or intention to deny approval of the startup, shutdown, and malfunction plan within 90 calendar days after receipt of the original request and within 60 calendar days after receipt of any supplemental information that you submit. Before disapproving the plan, the Administrator will notify you of the Administrator's intention to disapprove the plan together with:

(i) Notice of the information and findings on which intended disapproval is based; and

(ii) Notice of opportunity for you to present additional information to the Administrator before final action on disapproval of the plan. At the time the Administrator notifies you of intention to disapprove the plan, the Administrator will specify how much time you will have after being notified on the intended disapproval to submit additional information.

(2) *Responsibility of owners and operators.* You are responsible for ensuring that you submit any supplementary and additional information supporting your plan in a timely manner to enable the Administrator to consider whether to approve the plan. Neither your submittal of the plan, nor the Administrator's failure to approve or disapprove the plan, relieves you of the responsibility to comply with the provisions of this subpart.

(C) *Changes to the plan that may significantly increase emissions.* (1) You must request approval in writing from the Administrator within 5 days after making a change to the startup, shutdown, and malfunction plan that may significantly increase emissions of hazardous air pollutants.

(2) To request approval of such changes to the startup, shutdown, and malfunction plan, you must follow the procedures provided by paragraph (c)(2)(ii)(B) of this section for initial approval of the plan.

(iii) You must identify in the plan a projected oxygen correction factor based on normal operations to use during periods of startup and shutdown.

(iv) You must record the plan in the operating record.

(v) *Operating under the startup, shutdown, and malfunction plan—(A) Compliance with AWFCO requirements during malfunctions.* (1) During malfunctions, the automatic waste feed cutoff requirements of §63.1206(c)(3) continue to apply, except for paragraphs (c)(3)(v) and (c)(3)(vi) of this section. If you exceed a part 63, subpart EEE, of this chapter emission standard monitored by a CEMS or COMs or operating limit specified under §63.1209, the automatic waste feed cutoff system must immediately and automatically cutoff the hazardous waste feed, except as provided by paragraph (c)(3)(viii) of this section. If the malfunction itself prevents immediate and automatic cutoff of the hazardous waste feed, however, you must cease feeding hazardous waste as quickly as possible.

(2) Although the automatic waste feed cutoff requirements continue to apply during a malfunction, an exceedance of an emission standard monitored by a CEMS or COMS or operating limit specified under §63.1209 is not a violation of this subpart if you take the corrective measures prescribed in the startup, shutdown, and malfunction plan.

(3) *Excessive exceedances during malfunctions.* For each set of 10 exceedances of an emission standard or operating requirement while hazardous waste remains in the combustion chamber (i.e., when the hazardous waste residence time has not transpired since the hazardous waste feed was cutoff) during a 60-day block period, you must:

(i) Within 45 days of the 10th exceedance, complete an investigation of the cause of each exceedance and evaluation of approaches to minimize the frequency, duration, and severity of each exceedance, and revise the startup, shutdown, and malfunction plan as warranted by the evaluation to minimize the frequency, duration, and severity of each exceedance; and

(ii) Record the results of the investigation and evaluation in the operating record, and include a summary of the investigation and evaluation, and any changes to the startup, shutdown, and malfunction plan, in the excess emissions report required under §63.10(e)(3).

(B) *Compliance with AWFCO requirements when burning hazardous waste during startup and shutdown.* (1) If you feed hazardous waste during startup or shutdown, you must include waste feed restrictions (e.g., type and quantity), and other appropriate operating conditions and limits in the startup, shutdown, and malfunction plan.

(2) You must interlock the operating limits you establish under paragraph (c)(2)(v)(B)(1) of this section with the automatic waste feed cutoff system required under §63.1206(c)(3), except for paragraphs (c)(3)(v) and (c)(3)(vi) of this section.

(3) When feeding hazardous waste during startup or shutdown, the automatic waste feed cutoff system must immediately and automatically cutoff the hazardous waste feed if you exceed the operating limits you establish under paragraph (c)(2)(v)(B)(1) of this section, except as provided by paragraph (c)(3)(viii) of this section.

(4) Although the automatic waste feed cutoff requirements of this paragraph apply during startup and shutdown, an exceedance of an emission standard or operating limit is not a violation of this subpart if you comply with the operating procedures prescribed in the startup, shutdown, and malfunction plan.

(3) *Automatic waste feed cutoff (AWFCO)—(i) General.* Upon the compliance date, you must operate the hazardous waste combustor with a functioning system that immediately and automatically cuts off the hazardous waste feed, except as provided by paragraph (c)(3)(viii) of this section:

(A) When any of the following are exceeded: Operating parameter limits specified under §63.1209; an emission standard monitored by a CEMS; and the allowable combustion chamber pressure;

(B) When the span value of any CMS detector, except a CEMS, is met or exceeded;

(C) Upon malfunction of a CMS monitoring an operating parameter limit specified under §63.1209 or an emission level; or

(D) When any component of the automatic waste feed cutoff system fails.

(ii) *Ducting of combustion gases.* During an AWFCO, you must continue to duct combustion gasses to the air pollution control system while hazardous waste remains in the combustion chamber (i.e., if the hazardous waste residence time has not transpired since the hazardous waste feed cutoff system was activated).

(iii) *Restarting waste feed.* You must continue to monitor during the cutoff the operating parameters for which limits are established under §63.1209 and the emissions required under that section to be monitored by a CEMS, and you must not restart the hazardous waste feed until the operating parameters and emission levels are within the specified limits.

(iv) *Failure of the AWFCO system.* If the AWFCO system fails to automatically and immediately cutoff the flow of hazardous waste upon exceedance of a parameter required to be interlocked with the AWFCO system under paragraph (c)(3)(i) of this section, you have failed to comply with the AWFCO requirements of paragraph (c)(3) of this section. If an equipment or other failure prevents immediate and automatic cutoff of the hazardous waste feed, however, you must cease feeding hazardous waste as quickly as possible.

(v) *Corrective measures.* If, after any AWFCO, there is an exceedance of an emission standard or operating requirement, irrespective of whether the exceedance occurred while hazardous waste remained in the combustion chamber (i.e., whether the hazardous waste residence time has transpired since the hazardous waste feed cutoff system was activated), you must investigate the cause of the AWFCO, take appropriate corrective measures to minimize future AWFCOs, and record the findings and corrective measures in the operating record.

(vi) *Excessive exceedance reporting.* (A) For each set of 10 exceedances of an emission standard or operating requirement while hazardous waste remains in the combustion chamber (i.e., when the hazardous waste residence time has not transpired since the hazardous waste feed was cutoff) during a 60-day block period, you must submit to the Administrator a written report within 5 calendar days of the 10th exceedance documenting the exceedances and results of the investigation and corrective measures taken.

(B) On a case-by-case basis, the Administrator may require excessive exceedance reporting when fewer than 10 exceedances occur during a 60-day block period.

(vii) *Testing.* The AWFCO system and associated alarms must be tested at least weekly to verify operability, unless you document in the operating record that weekly inspections will unduly restrict or upset operations and that less frequent inspection will be adequate. At a minimum, you must conduct operability testing at least monthly. You must document and record in the operating record AWFCO operability test procedures and results.

(viii) *Ramping down waste feed.* (A) You may ramp down the waste feedrate of pumpable hazardous waste over a period not to exceed one minute, except as provided by paragraph (c)(3)(viii)(B) of this section. If you elect to ramp down the waste feed, you must document ramp down procedures in

the operating and maintenance plan. The procedures must specify that the ramp down begins immediately upon initiation of automatic waste feed cutoff and the procedures must prescribe a bona fide ramping down. If an emission standard or operating limit is exceeded during the ramp down, you have failed to comply with the emission standards or operating requirements of this subpart.

(B) If the automatic waste feed cutoff is triggered by an exceedance of any of the following operating limits, you may not ramp down the waste feed cutoff: Minimum combustion chamber temperature, maximum hazardous waste feedrate, or any hazardous waste firing system operating limits that may be established for your combustor.

(4) *ESV openings*—(i) *Failure to meet standards*. If an emergency safety vent (ESV) opens when hazardous waste remains in the combustion chamber (i.e., when the hazardous waste residence time has not expired) during an event other than a malfunction as defined in the startup, shutdown, and malfunction plan such that combustion gases are not treated as during the most recent comprehensive performance test (e.g., if the combustion gas by-passes any emission control device that was operating during the performance test), you must document in the operating record whether you remain in compliance with the emission standards of this subpart considering emissions during the ESV opening event.

(ii) *ESV operating plan*. (A) You must develop an ESV operating plan, comply with the operating plan, and keep the plan in the operating record.

(B) The ESV operating plan must provide detailed procedures for rapidly stopping the waste feed, shutting down the combustor, and maintaining temperature and negative pressure in the combustion chamber during the hazardous waste residence time, if feasible. The plan must include calculations and information and data documenting the effectiveness of the plan's procedures for ensuring that combustion chamber temperature and negative pressure are maintained as is reasonably feasible.

(iii) *Corrective measures*. After any ESV opening that results in a failure to meet the emission standards as defined in paragraph (c)(4)(i) of this section, you must investigate the cause of the ESV opening, take appropriate corrective measures to minimize such future ESV openings, and record the findings and corrective measures in the operating record.

(iv) *Reporting requirements*. You must submit to the Administrator a written report within 5 days of an ESV opening that results in failure to meet the emission standards of this subpart (as determined in paragraph (c)(4)(i) of this section) documenting the result of the investigation and corrective measures taken.

(5) *Combustion system leaks*. (i) Combustion system leaks of hazardous air pollutants must be controlled by:

(A) Keeping the combustion zone sealed to prevent combustion system leaks; or

(B) Maintaining the maximum combustion zone pressure lower than ambient pressure using an instantaneous monitor; or

(C) Upon prior written approval of the Administrator, an alternative means of control to provide control of combustion system leaks equivalent to maintenance of combustion zone pressure lower than ambient pressure; or

(D) Upon prior written approval of the Administrator, other technique(s) which can be demonstrated to prevent fugitive emissions without use of instantaneous pressure limits; and

(ii) You must specify in the performance test workplan and Notification of Compliance the method that will be used to control combustion system leaks. If you control combustion system leaks by maintaining the combustion zone pressure lower than ambient pressure using an instantaneous monitor, you must also specify in the performance test workplan and Notification of Compliance the monitoring and recording frequency of the pressure monitor, and specify how the monitoring approach will be integrated into the automatic waste feed cutoff system.

(6) *Operator training and certification.* (i) You must establish training programs for all categories of personnel whose activities may reasonably be expected to directly affect emissions of hazardous air pollutants from the source. Such persons include, but are not limited to, chief facility operators, control room operators, continuous monitoring system operators, persons that sample and analyze feedstreams, persons that manage and charge feedstreams to the combustor, persons that operate emission control devices, and ash and waste handlers. Each training program shall be of a technical level commensurate with the person's job duties specified in the training manual. Each commensurate training program shall require an examination to be administered by the instructor at the end of the training course. Passing of this test shall be deemed the "certification" for personnel, except that, for control room operators, the training and certification program shall be as specified in paragraphs (c)(6)(iii) through (c)(6)(vi) of this section.

(ii) You must ensure that the source is operated and maintained at all times by persons who are trained and certified to perform these and any other duties that may affect emissions of hazardous air pollutants. A certified control room operator must be on duty at the site at all times the source is in operation.

(iii) Hazardous waste incinerator control room operators must:

(A) Be trained and certified under a site-specific, source-developed and implemented program that meets the requirements of paragraph (c)(6)(v) of this section; or

(B) Be trained under the requirements of, and certified under, one of the following American Society of Mechanical Engineers (ASME) standards: QHO-1-1994, QHO-1a-1996, or QHO-1-2004 (Standard for the Qualification and Certification of Hazardous Waste Incinerator Operators). If you elect to use the ASME program:

(1) Control room operators must, prior to the compliance date, achieve provisional certification, and must submit an application to ASME and be scheduled for the full certification exam. Within one year of the compliance date, control room operators must achieve full certification;

(2) New operators and operators of new sources must, before assuming their duties, achieve provisional certification, and must submit an application to ASME, and be scheduled for the full certification exam. Within one year of assuming their duties, these operators must achieve full certification; or

(C) Be trained and certified under a State program.

(iv) Control room operators of cement kilns, lightweight aggregate kilns, solid fuel boilers, liquid fuel boilers, and hydrochloric acid production furnaces must be trained and certified under:

(A) A site-specific, source-developed and implemented program that meets the requirements of paragraph (c)(6)(v) of this section; or

(B) A State program.

(v) Site-specific, source developed and implemented training programs for control room operators must include the following elements:

(A) Training on the following subjects:

(1) Environmental concerns, including types of emissions;

(2) Basic combustion principles, including products of combustion;

(3) Operation of the specific type of combustor used by the operator, including proper startup, waste firing, and shutdown procedures;

(4) Combustion controls and continuous monitoring systems;

(5) Operation of air pollution control equipment and factors affecting performance;

(6) Inspection and maintenance of the combustor, continuous monitoring systems, and air pollution control devices;

(7) Actions to correct malfunctions or conditions that may lead to malfunction;

(8) Residue characteristics and handling procedures; and

(9) Applicable Federal, state, and local regulations, including Occupational Safety and Health Administration workplace standards; and

(B) An examination designed and administered by the instructor; and

(C) Written material covering the training course topics that may serve as reference material following completion of the course.

(vi) To maintain control room operator qualification under a site-specific, source developed and implemented training program as provided by paragraph (c)(6)(v) of this section, control room operators must complete an annual review or refresher course covering, at a minimum, the following topics:

(A) Update of regulations;

(B) Combustor operation, including startup and shutdown procedures, waste firing, and residue handling;

(C) Inspection and maintenance;

(D) Responses to malfunctions or conditions that may lead to malfunction; and

(E) Operating problems encountered by the operator.

(vii) You must record the operator training and certification program in the operating record.

(7) *Operation and maintenance plan*—(i) You must prepare and at all times operate according to an operation and maintenance plan that describes in detail procedures for operation, inspection, maintenance, and corrective measures for all components of the combustor, including associated pollution control equipment, that could affect emissions of regulated hazardous air pollutants.

(ii) The plan must prescribe how you will operate and maintain the combustor in a manner consistent with good air pollution control practices for minimizing emissions at least to the levels achieved during the comprehensive performance test.

(iii) This plan ensures compliance with the operation and maintenance requirements of §63.6(e) and minimizes emissions of pollutants, automatic waste feed cutoffs, and malfunctions.

(iv) You must record the plan in the operating record.

(8) *Bag leak detection system requirements.* (i) If your combustor is equipped with a baghouse (fabric filter), you must continuously operate either:

(A) A bag leak detection system that meets the specifications and requirements of paragraph (c)(8)(ii) of this section and you must comply with the corrective measures and notification requirements of paragraphs (c)(8)(iii) and (iv) of this section; or

(B) A particulate matter detection system under paragraph (c)(9) of this section.

(ii) *Bag leak detection system specification and requirements.* (A) The bag leak detection system must be certified by the manufacturer to be capable of continuously detecting and recording particulate matter emissions at concentrations of 1.0 milligrams per actual cubic meter unless you demonstrate, under §63.1209(g)(1), that a higher detection limit would routinely detect particulate matter loadings during normal operations;

(B) The bag leak detection system shall provide output of relative or absolute particulate matter loadings;

(C) The bag leak detection system shall be equipped with an alarm system that will sound an audible alarm when an increase in relative particulate loadings is detected over a preset level;

(D) The bag leak detection system shall be installed and operated in a manner consistent with available written guidance from the U.S. Environmental Protection Agency or, in the absence of such written guidance, the manufacturer's written specifications and recommendations for installation, operation, and adjustment of the system;

(E) The initial adjustment of the system shall, at a minimum, consist of establishing the baseline output by adjusting the sensitivity (range) and the averaging period of the device, and establishing the alarm set points and the alarm delay time;

(F) Following initial adjustment, you must not adjust the sensitivity or range, averaging period, alarm set points, or alarm delay time, except as detailed in the operation and maintenance plan required under paragraph (c)(7) of this section. You must not increase the sensitivity by more than 100 percent or decrease the sensitivity by more than 50 percent over a 365 day period unless such adjustment follows a complete baghouse inspection which demonstrates the baghouse is in good operating condition;

(G) For negative pressure or induced air baghouses, and positive pressure baghouses that are discharged to the atmosphere through a stack, the bag leak detector shall be installed downstream of the baghouse and upstream of any wet acid gas scrubber; and

(H) Where multiple detectors are required, the system's instrumentation and alarm system may be shared among the detectors.

(iii) *Bag leak detection system corrective measures requirements.* The operating and maintenance plan required by paragraph (c)(7) of this section must include a corrective measures plan that specifies the procedures you will follow in the case of a bag leak detection system alarm or malfunction. The corrective measures plan must include, at a minimum, the procedures used to determine and record the time and cause of the alarm or bag leak detection system malfunction in accordance with the requirements of paragraph (c)(8)(iii)(A) of this section as well as the corrective measures taken to correct the control device or bag leak detection system malfunction or to minimize emissions in accordance with the requirements of paragraph (c)(8)(iii)(B) of this section. Failure to initiate the corrective measures required by this paragraph is failure to ensure compliance with the emission standards in this subpart.

(A) You must initiate the procedures used to determine the cause of the alarm or bag leak detection system malfunction within 30 minutes of the time the alarm first sounds; and

(B) You must alleviate the cause of the alarm or bag leak detection system malfunction by taking the necessary corrective measure(s) which may include, but are not to be limited to, the following:

(1) Inspecting the baghouse for air leaks, torn or broken filter elements, or any other malfunction that may cause an increase in emissions;

(2) Sealing off defective bags or filter media;

(3) Replacing defective bags or filter media, or otherwise repairing the control device;

(4) Sealing off a defective baghouse compartment;

(5) Cleaning the bag leak detection system probe, or otherwise repairing the bag leak detection system; or

(6) Shutting down the combustor.

(iv) *Excessive exceedances notification.* If you operate the combustor when the detector response exceeds the alarm set-point or the bag leak detection system is malfunctioning more than 5 percent of the time during any 6-month block time period, you must submit a notification to the Administrator within 30 days of the end of the 6-month block time period that describes the causes of the exceedances and bag leak detection system malfunctions and the revisions to the design, operation, or maintenance of the combustor, baghouse, or bag leak detection system you are taking to minimize exceedances and bag leak detection system malfunctions. To document compliance with this requirement:

(A) You must keep records of the date, time, and duration of each alarm and bag leak detection system malfunction, the time corrective action was initiated and completed, and a brief description of the cause of the alarm or bag leak detection system malfunction and the corrective action taken;

(B) You must record the percent of the operating time during each 6-month period that the alarm sounds and the bag leak detection system malfunctions;

(C) If inspection of the fabric filter demonstrates that no corrective action is required, then no alarm time is counted; and

(D) If corrective action is required, each alarm shall be counted as a minimum of 1 hour. Each bag leak detection system malfunction shall also be counted as a minimum of 1 hour.

(9) *Particulate matter detection system requirements.* You must continuously operate a particulate matter detection system (PMDS) that meets the specifications and requirements of paragraphs (c)(9)(i)

through (v) of this section and you must comply with the corrective measures and notification requirements of paragraphs (c)(9)(vii) and (viii) of this section if your combustor either: Is equipped with an electrostatic precipitator or ionizing wet scrubber and you do not establish site-specific control device operating parameter limits under §63.1209(m)(1)(iv) that are linked to the automatic waste feed cutoff system under paragraph (c)(3) of this section, or is equipped with a baghouse (fabric filter) and you do not operate a bag leak detection system as provided by paragraph (c)(8)(i)(B) of this section.

(i) *PMDS requirements.* (A) The PMDS must be certified by the manufacturer to be capable of continuously detecting and recording particulate matter emissions at concentrations of 1.0 milligrams per actual cubic meter unless you demonstrate, under §63.1209(g)(1), that a higher detection limit would routinely detect particulate matter loadings during normal operations;

(B) The particulate matter detector shall provide output of relative or absolute particulate matter loadings;

(C) The PMDS shall be equipped with an alarm system that will sound an audible alarm when an increase in relative or absolute particulate loadings is detected over the set-point;

(D) You must install, operate, and maintain the PMDS in a manner consistent with the provisions of paragraph (c)(9) of this section and available written guidance from the U.S. Environmental Protection Agency or, in the absence of such written guidance, the manufacturer's written specifications and recommendations for installation, operation, maintenance and quality assurance of the system.

(1) *Set-points established without extrapolation.* If you establish the alarm set-point without extrapolation under paragraph (c)(9)(iii)(A) of this section, you must request approval from the regulatory authority, in the continuous monitoring system test plan, of the quality assurance procedures that will reasonably ensure that PMDS response values below the alarm set-point correspond to PM emission concentrations below those demonstrated during the comprehensive performance test. Your recommended quality assurance procedures may include periodic testing under as-found conditions (i.e., normal operations) to obtain additional PM concentration and PMDS response run pairs, as warranted.

(2) *Set-points established with extrapolation.* If you establish the alarm set-point by extrapolation under paragraph (c)(9)(iii)(B) of this section, you must request approval from the regulatory authority, in the continuous monitoring system test plan, of the quality assurance procedures that will reasonably ensure that PMDS response values below the alarm set-point correspond to PM emission concentrations below the value that correlates to the alarm set-point.

(E) You must include procedures for installation, operation, maintenance, and quality assurance of the PMDS in the site-specific continuous monitoring system test plan required under §§63.1207(e) and 63.8(e)(3);

(F) Where multiple detectors are required to monitor multiple control devices, the system's instrumentation and alarm system may be shared among the detectors.

(G) You must establish the alarm set-point as a 6-hour rolling average as provided by paragraphs (c)(9)(ii), (c)(9)(iii), and (c)(9)(iv) of this section;

(H) Your PMDS must complete a minimum of one cycle of operation (sampling, analyzing, and data recording) for each successive 15-minute period. You must update the 6-hour rolling average of the detector response each hour with a one-hour block average that is the average of the detector responses over each 15-minute block; and

(I) If you exceed the alarm set-point (or if your PMDS malfunctions), you must comply with the corrective measures under paragraph (c)(9)(vii) of this section.

(ii) *Establishing the alarm set-point for operations under the Documentation of Compliance.* You must establish the alarm set-point for operations under the Documentation of Compliance (i.e., after the compliance date but prior to submitting a Notification of Compliance subsequent to conducting the initial comprehensive performance test) of an existing source as follows:

(A) You must obtain a minimum of three pairs of Method 5 or 5I data, provided in appendix A-3 to part 60 of this chapter, and PMDS data to establish an approximate correlation curve. Data obtained up to 60 months prior to the compliance date may be used provided that the design and operation of the combustor or PMDS has not changed in a manner that may adversely affect the correlation of PM concentrations and PMDS response.

(B) You must request approval from the regulatory authority, in the continuous monitoring system test plan, of your determination whether multiple correlation curves are needed considering the design and operation of your combustor and PMDS.

(C) You must approximate the correlation of the reference method data to the PMDS data.

(1) You may assume a linear correlation of the PMDS response to particulate matter emission concentrations;

(2) You may include a zero point correlation value. To establish a zero point, you must follow one or more of the following steps:

(i) Zero point data for in-situ instruments should be obtained, to the extent possible, by removing the instrument from the stack and monitoring ambient air on a test bench;

(ii) Zero point data for extractive instruments should be obtained by removing the extractive probe from the stack and drawing in clean ambient air;

(iii) Zero point data also can be obtained by performing manual reference method measurements when the flue gas is free of PM emissions or contains very low PM concentrations (e.g., when your process is not operating, but the fans are operating or your source is combusting only natural gas); and

(iv) If none of the steps in paragraphs (c)(9)(ii)(B)(2)(i) through (iii) of this section are possible, you must estimate the monitor response when no PM is in the flue gas (e.g., 4 mA = 0 mg/acm).

(3) For reference method data that were obtained from runs during a test condition where controllable operating factors were held constant, you must average the test run averages of PM concentrations and PMDS responses to obtain a single pair of data for PM concentration and PMDS response. You may use this pair of data and the zero point to define a linear correlation model for the PMDS.

(D) You must establish the alarm set-point as the PMDS response that corresponds to a PM concentration that is 50% of the PM emission standard or 125% of the highest PM concentration used to develop the correlation, whichever is greater. For reference method data that were obtained from runs during a test condition where controllable operating factors were held constant, you must use the average of the test run averages of PM concentrations for extrapolating the alarm set-point. The PM emission concentration used to extrapolate the alarm set-point must not exceed the PM emission standard, however.

(iii) *Establishing the initial alarm set-point for operations under the Notification of Compliance.* You must establish the initial alarm set-point for operations under the Notification of Compliance as provided by either paragraph (c)(9)(iii)(A) or paragraph (c)(9)(iii)(B) of this section. You must periodically revise the alarm set-point as provided by paragraph (c)(9)(iv) of this section.

(A) *Establishing the initial set-point without extrapolation.* (1) If you establish the initial alarm set-point without extrapolation, the alarm set-point is the average of the test run averages of the PMDS response during the runs of the comprehensive performance test that document compliance with the PM emission standard.

(2) During the comprehensive performance test, you may simulate PM emission concentrations at the upper end of the range of normal operations by means including feeding high levels of ash and detuning the emission control equipment.

(B) *Establishing the initial set-point by extrapolation.* You may extrapolate the particulate matter detector response to establish the alarm set-point under the following procedures:

(1) You must request approval from the regulatory authority, in the continuous monitoring system test plan, of the procedures you will use to establish an approximate correlation curve using the three pairs of Method 5 or 5I data (see methods in appendix A-3 of part 60 of this chapter) and PMDS data from the comprehensive performance test, the data pairs used to establish the correlation curve for the Documentation of Compliance under paragraph (c)(9)(ii) of this section, and additional data pairs, as warranted.

(2) You must request approval from the regulatory authority, in the continuous monitoring system test plan, of your determination of whether multiple correlation curves are needed considering the design and operation of your combustor and PMDS. If so, you must recommend the number of data pairs needed to establish those correlation curves and how the data will be obtained.

(3) During the comprehensive performance test, you may simulate PM emission concentrations at the upper end of the range of normal operations by means including feeding high levels of ash and detuning the emission control equipment.

(4) Data obtained up to 60 months prior to the comprehensive performance test may be used provided that the design and operation of the combustor or PMDS has not changed in a manner that may adversely affect the correlation of PM concentrations and PMDS response.

(5) You may include a zero point correlation value. To establish a zero point, you must follow the procedures under paragraph (c)(9)(ii)(C)(2) of this section.

(6) You must use a least-squares regression model to correlate PM concentrations to PMDS responses for data pairs. You may assume a linear regression model approximates the relationship between PM concentrations and PMDS responses.

(7) You must establish the alarm set-point as the PMDS response that corresponds to a PM concentration that is 50% of the PM emission standard or 125% of the highest PM concentration used to develop the correlation, whichever is greater. The emission concentration used to extrapolate the PMDS response must not exceed the PM emission standard.

(iv) *Revising the Notification of Compliance alarm set-point—(A) Revising set-points established without extrapolation.* If you establish the alarm set-point without extrapolation under paragraph (c)(9)(iii)(A) of this section, you must establish a new alarm set-point in the Notification of Compliance following each comprehensive performance test as the average of the test run averages of the PMDS

response during the runs of the comprehensive performance test that document compliance with the PM emission standard.

(B) *Revising set-points established with extrapolation.* If you establish the alarm set-point by extrapolation under paragraph (c)(9)(iii)(B) of this section, you must request approval from the regulatory authority, in the continuous monitoring system test plan, of the procedures for periodically revising the alarm set-point, considering the additional data pairs obtained during periodic comprehensive performance tests and data pairs obtained from other tests, such as for quality assurance.

(v) *Quality assurance—(A) Set-points established without extrapolation.* If you establish the alarm set-point without extrapolation under paragraph (c)(9)(iii)(A) of this section, you must request approval from the regulatory authority, in the continuous monitoring system test plan, of the quality assurance procedures that reasonably ensure that PMDS response values below the alarm set-point correspond to PM emission concentrations below the average of the PM concentrations demonstrated during the comprehensive performance test. Your recommended quality assurance procedures may include periodic testing under as-found conditions (i.e., normal operations) to obtain additional PM concentration and PMDS response run pairs, as warranted.

(B) *Set-points established with extrapolation.* If you establish the alarm set-point by extrapolation under paragraph (c)(9)(iii)(B) of this section, you must request approval from the regulatory authority, in the continuous monitoring system test plan, of the quality assurance procedures that reasonably ensure that PMDS response values below the alarm set-point correspond to PM emission concentrations below the value that correlated to the alarm set-point.

(vi) *PMDS are used for compliance assurance only.* For a PMDS for which the alarm set-point is established by extrapolation using a correlation curve under paragraphs (c)(9)(ii), (c)(9)(iii)(B), and (c)(9)(iv)(B) of this section, an exceedance of the PMDS response that appears to correlate with a PM concentration that exceeds the PM emission standard is not by itself evidence that the standard has been exceeded.

(vii) *PMDS corrective measures requirements.* The operating and maintenance plan required by paragraph (c)(7) of this section must include a corrective measures plan that specifies the procedures you will follow in the case of a PMDS alarm or malfunction. The corrective measures plan must include, at a minimum, the procedures used to determine and record the time and cause of the alarm or PMDS malfunction as well as the corrective measures taken to correct the control device or PMDS malfunction or minimize emissions as specified below. Failure to initiate the corrective measures required by this paragraph is failure to ensure compliance with the emission standards in this subpart.

(A) You must initiate the procedures used to determine the cause of the alarm or PMDS malfunction within 30 minutes of the time the alarm first sounds or the PMDS malfunctions; and

(B) You must alleviate the cause of the alarm or the PMDS malfunction by taking the necessary corrective measure(s) which may include shutting down the combustor.

(viii) *Excessive exceedances notification.* If you operate the combustor when the detector response exceeds the alarm set-point or when the PMDS is malfunctioning more than 5 percent of the time during any 6-month block time period, you must submit a notification to the Administrator within 30 days of the end of the 6-month block time period that describes the causes of the exceedances and the revisions to the design, operation, or maintenance of the combustor, emission control device, or PMDS you are taking to minimize exceedances. To document compliance with this requirement:

(A) You must keep records of the date, time, and duration of each alarm and PMDS malfunction, the time corrective action was initiated and completed, and a brief description of the cause of the alarm or PMDS malfunction and the corrective action taken;

(B) You must record the percent of the operating time during each 6-month period that the alarm sounds and the PMDS malfunctions;

(C) If inspection of the emission control device demonstrates that no corrective action is required, then no alarm time is counted; and

(D) If corrective action to the emission control device is required, each alarm shall be counted as a minimum of 1 hour. Each PMDS malfunction shall also be counted as a minimum of 1 hour.

[64 FR 53038, Sept. 30, 1999, as amended at 65 FR 42298, July 10, 2000; 65 FR 67271, Nov. 9, 2000; 66 FR 24272, May 14, 2001; 66 FR 35103, July 3, 2001; 66 FR 63317, Dec. 7, 2001; 67 FR 6813, Feb. 13, 2002; 67 FR 6989, Feb. 14, 2002; 67 FR 77691, Dec. 19, 2002; 70 FR 59541, Oct. 12, 2005; 70 FR 75047, Dec. 19, 2005; 71 FR 20459, Apr. 20, 2006; 71 FR 62393, Oct. 25, 2006; 73 FR 18979, Apr. 8, 2008; 73 FR 64094, Oct. 28, 2008]

 [Back to Top](#)

§63.1207 What are the performance testing requirements?

(a) *General.* The provisions of §63.7 apply, except as noted below.

(b) *Types of performance tests—(1) Comprehensive performance test.* You must conduct comprehensive performance tests to demonstrate compliance with the emission standards provided by this subpart, establish limits for the operating parameters provided by §63.1209, and demonstrate compliance with the performance specifications for continuous monitoring systems.

(2) *Confirmatory performance test.* You must conduct confirmatory performance tests to:

(i) Demonstrate compliance with the dioxin/furan emission standard when the source operates under normal operating conditions; and

(ii) Conduct a performance evaluation of continuous monitoring systems required for compliance assurance with the dioxin/furan emission standard under §63.1209(k).

(3) *One-Time Dioxin/Furan Test for Sources Not Subject to a Numerical Dioxin/Furan Standard.* For solid fuel boilers and hydrochloric acid production furnaces, for lightweight aggregate kilns that are not subject to a numerical dioxin/furan emission standard under §63.1221, and liquid fuel boilers that are not subject to a numerical dioxin/furan emission standard under §63.1217, you must conduct a one-time emission test for dioxin/furan under feed and operating conditions that are most likely to reflect daily maximum operating variability, similar to a dioxin/furan comprehensive performance test.

(i) You must conduct the dioxin/furan emissions test no later than the deadline for conducting the initial comprehensive performance test.

(ii) You may use dioxin/furan emissions data from previous testing to meet this requirement, provided that:

(A) The testing was conducted under feed and operating conditions that are most likely to reflect daily maximum operating variability, similar to a dioxin/furan compliance test;

(B) You have not changed the design or operation of the source in a manner that could significantly affect stack gas dioxin/furan emission concentrations; and

(C) The data meet quality assurance objectives that may be determined on a site-specific basis.

(iii) You may use dioxin/furan emissions data from a source to represent emissions from another on-site source in lieu of testing (i.e., data in lieu of testing) if the design and operation, including hazardous waste feed and other feedstreams, of the sources are identical.

(iv) You must include the results of the one-time dioxin/furan emissions test with the results of the initial comprehensive performance test in the Notification of Compliance.

(v) You must repeat the dioxin/furan emissions test if you change the design or operation of the source in a manner that may increase dioxin/furan emissions.

(vi) Sources that are required to perform the one-time dioxin/furan test pursuant to paragraph (b)(3) of this section are not required to perform confirmatory performance tests.

(c) *Initial comprehensive performance test*—(1) *Test date*. Except as provided by paragraphs (c)(2) and (c)(3) of this section, you must commence the initial comprehensive performance test not later than six months after the compliance date.

(2) *Data in lieu of the initial comprehensive performance test*. (i) You may request that previous emissions test data serve as documentation of conformance with the emission standards of this subpart provided that the previous testing:

(A) Was initiated after 54 months prior to the compliance date, except as provided by paragraphs (c)(2)(iii) or (c)(2)(iv) of this section;

(B) Results in data that meet quality assurance objectives (determined on a site-specific basis) such that the results demonstrate compliance with the applicable standards;

(C) Was in conformance with the requirements of paragraph (g)(1) of this section; and

(D) Was sufficient to establish the applicable operating parameter limits under §63.1209.

(ii) You must submit data in lieu of the initial comprehensive performance test in lieu of (i.e., if the data are in lieu of all performance testing) or with the notification of performance test required under paragraph (e) of this section.

(iii) The data in lieu test age restriction provided in paragraph (c)(2)(i)(A) of this section does not apply for the duration of the interim standards (i.e., the standards published in the FEDERAL REGISTER on February 13, 2002, 67 FR 6792). See 40 CFR parts 63, 264, 265, 266, 270, and 271 revised as of July 1, 2002. Paragraph (c)(2)(i)(A) of this section does not apply until EPA promulgates permanent replacement standards pursuant to the Settlement Agreement noticed in the FEDERAL REGISTER on November 16, 2001 (66 FR 57715).

(iv) The data in lieu test age restriction provided in paragraph (c)(2)(i)(A) of this section does not apply to DRE data provided you do not feed hazardous waste at a location in the combustion system other than the normal flame zone.

(3) For incinerators, cement kilns, and lightweight aggregate kilns, you must commence the initial comprehensive performance test to demonstrate compliance with the standards under §§63.1219, 63.1220, and 63.1221 not later than 12 months after the compliance date.

(d) *Frequency of testing*. Except as otherwise specified in paragraph (d)(4) of this section, you must conduct testing periodically as prescribed in paragraphs (d)(1) through (d)(3) of this section. The date of commencement of the initial comprehensive performance test is the basis for establishing the deadline to

commence the initial confirmatory performance test and the next comprehensive performance test. You may conduct performance testing at any time prior to the required date. The deadline for commencing subsequent confirmatory and comprehensive performance testing is based on the date of commencement of the previous comprehensive performance test. Unless the Administrator grants a time extension under paragraph (i) of this section, you must conduct testing as follows:

(1) *Comprehensive performance testing.* Except as otherwise specified in paragraph (d)(4) of this section, you must commence testing no later than 61 months after the date of commencing the previous comprehensive performance test used to show compliance with §63.1216, §63.1217, §63.1218, §63.1219, §63.1220, or §63.1221. If you submit data in lieu of the initial performance test, you must commence the subsequent comprehensive performance test within 61 months of commencing the test used to provide the data in lieu of the initial performance test.

(2) *Confirmatory performance testing.* Except as otherwise specified in paragraph (d)(4) of this section, you must commence confirmatory performance testing no later than 31 months after the date of commencing the previous comprehensive performance test used to show compliance with §63.1217, §63.1219, §63.1220, or §63.1221. If you submit data in lieu of the initial performance test, you must commence the initial confirmatory performance test within 31 months of the date six months after the compliance date. To ensure that the confirmatory test is conducted approximately midway between comprehensive performance tests, the Administrator will not approve a test plan that schedules testing within 18 months of commencing the previous comprehensive performance test.

(3) *Duration of testing.* You must complete performance testing within 60 days after the date of commencement, unless the Administrator determines that a time extension is warranted based on your documentation in writing of factors beyond your control that prevent you from meeting the 60-day deadline.

(4) *Applicable testing requirements under the interim standards—(i) Waiver of periodic comprehensive performance tests.* Except as provided by paragraph (c)(2) of this section, you must conduct only an initial comprehensive performance test under the interim standards (§§63.1203 through 63.1205); all subsequent comprehensive performance testing requirements are waived under the interim standards. The provisions in the introductory text to paragraph (d) and in paragraph (d)(1) of this section apply only to tests used to demonstrate compliance with the standards under §§63.1219 through 63.1221.

(ii) *Waiver of confirmatory performance tests.* You are not required to conduct a confirmatory test under the interim standards (§§63.1203 through 63.1205). The confirmatory testing requirements in the introductory text to paragraph (d) and in paragraph (d)(2) of this section apply only after you have demonstrated compliance with the standards under §§63.1219 through 63.1221.

(e) *Notification of performance test and CMS performance evaluation, and approval of test plan and CMS performance evaluation plan.* (1) The provisions of §63.7(b) and (c) and §63.8(e) apply, except:

(i) *Comprehensive performance test.* You must submit to the Administrator a notification of your intention to conduct a comprehensive performance test and CMS performance evaluation and a site-specific test plan and CMS performance evaluation test plan at least one year before the performance test and performance evaluation are scheduled to begin.

(A) The Administrator will notify you of approval or intent to deny approval of the site-specific test plan and CMS performance evaluation test plan within 9 months after receipt of the original plan.

(B) You must submit to the Administrator a notification of your intention to conduct the comprehensive performance test at least 60 calendar days before the test is scheduled to begin.

(ii) *Confirmatory performance test.* You must submit to the Administrator a notification of your intention to conduct a confirmatory performance test and CMS performance evaluation and a site-specific test plan and CMS performance evaluation test plan at least 60 calendar days before the performance test is scheduled to begin. The Administrator will notify you of approval or intent to deny approval of the site-specific test plan and CMS performance evaluation test plan within 30 calendar days after receipt of the original test plans.

(2) You must make your site-specific test plan and CMS performance evaluation test plan available to the public for review no later than 60 calendar days before initiation of the test. You must issue a public notice to all persons on your facility/public mailing list (developed pursuant to 40 CFR 70.7(h), 71.11(d)(3)(i)(E) and 124.10(c)(1)(ix)) announcing the availability of the test plans and the location where the test plans are available for review. The test plans must be accessible to the public for 60 calendar days, beginning on the date that you issue your public notice. The location must be unrestricted and provide access to the public during reasonable hours and provide a means for the public to obtain copies. The notification must include the following information at a minimum:

(i) The name and telephone number of the source's contact person;

(ii) The name and telephone number of the regulatory agency's contact person;

(iii) The location where the test plans and any necessary supporting documentation can be reviewed and copied;

(iv) The time period for which the test plans will be available for public review; and

(v) An expected time period for commencement and completion of the performance test and CMS performance evaluation test.

(3) *Petitions for time extension if Administrator fails to approve or deny test plans.* You may petition the Administrator under §63.7(h) to obtain a "waiver" of any performance test—initial or periodic performance test; comprehensive or confirmatory test. The "waiver" would be implemented as an extension of time to conduct the performance test at a later date.

(i) *Qualifications for the waiver.* (A) You may not petition the Administrator for a waiver under this section if the Administrator has issued a notification of intent to deny your test plan(s) under §63.7(c)(3)(i)(B);

(B) You must submit a site-specific emissions testing plan and a continuous monitoring system performance evaluation test plan at least one year before a comprehensive performance test is scheduled to begin as required by paragraph (c)(1) of this section, or at least 60 days before a confirmatory performance test is scheduled to begin as required by paragraph (d) of this section. The test plans must include all required documentation, including the substantive content requirements of paragraph (f) of this section and §63.8(e); and

(C) You must make a good faith effort to accommodate the Administrator's comments on the test plans.

(ii) *Procedures for obtaining a waiver and duration of the waiver.* (A) You must submit to the Administrator a waiver petition or request to renew the petition under §63.7(h) separately for each source at least 60 days prior to the scheduled date of the performance test;

(B) The Administrator will approve or deny the petition within 30 days of receipt and notify you promptly of the decision;

(C) The Administrator will not approve an individual waiver petition for a duration exceeding 6 months;

(D) The Administrator will include a sunset provision in the waiver ending the waiver within 6 months;

(E) You may submit a revised petition to renew the waiver under §63.7(h)(3)(iii) at least 60 days prior to the end date of the most recently approved waiver petition;

(F) The Administrator may approve a revised petition for a total waiver period up to 12 months.

(iii) *Content of the waiver.* (A) You must provide documentation to enable the Administrator to determine that the source is meeting the relevant standard(s) on a continuous basis as required by §63.7(h)(2). For extension requests for the initial comprehensive performance test, you must submit your Documentation of Compliance to assist the Administrator in making this determination.

(B) You must include in the petition information justifying your request for a waiver, such as the technical or economic infeasibility, or the impracticality, of the affected source performing the required test, as required by §63.7(h)(3)(iii).

(iv) *Public notice.* At the same time that you submit your petition to the Administrator, you must notify the public (e.g., distribute a notice to the facility/public mailing list developed pursuant to 40 CFR 70.7(h), 71.11(d)(3)(i)(E) and 124.10(c)(1)(ix)) of your petition to waive a performance test. The notification must include all of the following information at a minimum:

(A) The name and telephone number of the source's contact person;

(B) The name and telephone number of the regulatory agency's contact person;

(C) The date the source submitted its site-specific performance test plan and CMS performance evaluation test plans; and

(D) The length of time requested for the waiver.

(f) *Content of performance test plan.* The provisions of §§63.7(c)(2)(i)-(iii) and (v) regarding the content of the test plan apply. In addition, you must include the following information in the test plan:

(1) *Content of comprehensive performance test plan.* (i) An analysis of each feedstream, including hazardous waste, other fuels, and industrial furnace feedstocks, as fired, that includes:

(A) Heating value, levels of ash (for hazardous waste incinerators only), levels of semivolatile metals, low volatile metals, mercury, and total chlorine (organic and inorganic); and

(B) Viscosity or description of the physical form of the feedstream;

(ii) For organic hazardous air pollutants established by 42 U.S.C. 7412(b)(1), excluding caprolactam (CAS number 105602) as provided by §63.60:

(A) Except as provided by paragraph (f)(1)(ii)(D) of this section, an identification of such organic hazardous air pollutants that are present in each hazardous waste feedstream. You need not analyze for organic hazardous air pollutants that would reasonably not be expected to be found in the feedstream.

You must identify any constituents you exclude from analysis and explain the basis for excluding them. You must conduct the feedstream analysis according to §63.1208(b)(8);

(B) An approximate quantification of such identified organic hazardous air pollutants in the hazardous waste feedstreams, within the precision produced by analytical procedures of §63.1208(b)(8); and

(C) A description of blending procedures, if applicable, prior to firing the hazardous waste feedstream, including a detailed analysis of the materials prior to blending, and blending ratios.

(D) The Administrator may approve on a case-by-case basis a hazardous waste feedstream analysis for organic hazardous air pollutants in lieu of the analysis required under paragraph (f)(1)(ii)(A) of this section if the reduced analysis is sufficient to ensure that the POHCs used to demonstrate compliance with the applicable DRE standards of this subpart continue to be representative of the most difficult to destroy organic compounds in your hazardous waste feedstreams;

(iii) A detailed engineering description of the hazardous waste combustor, including:

(A) Manufacturer's name and model number of the hazardous waste combustor;

(B) Type of hazardous waste combustor;

(C) Maximum design capacity in appropriate units;

(D) Description of the feed system for each feedstream;

(E) Capacity of each feed system;

(F) Description of automatic hazardous waste feed cutoff system(s);

(G) Description of the design, operation, and maintenance practices for any air pollution control system; and

(H) Description of the design, operation, and maintenance practices of any stack gas monitoring and pollution control monitoring systems;

(iv) A detailed description of sampling and monitoring procedures including sampling and monitoring locations in the system, the equipment to be used, sampling and monitoring frequency, and planned analytical procedures for sample analysis;

(v) A detailed test schedule for each hazardous waste for which the performance test is planned, including date(s), duration, quantity of hazardous waste to be burned, and other relevant factors;

(vi) A detailed test protocol, including, for each hazardous waste identified, the ranges of hazardous waste feedrate for each feed system, and, as appropriate, the feedrates of other fuels and feedstocks, and any other relevant parameters that may affect the ability of the hazardous waste combustor to meet the emission standards;

(vii) A description of, and planned operating conditions for, any emission control equipment that will be used;

(viii) Procedures for rapidly stopping the hazardous waste feed and controlling emissions in the event of an equipment malfunction;

(ix) A determination of the hazardous waste residence time as required by §63.1206(b)(11);

(x) If you are requesting to extrapolate metal feedrate limits from comprehensive performance test levels under §§63.1209(l)(1)(v) or 63.1209(n)(2)(vii):

(A) A description of the extrapolation methodology and rationale for how the approach ensures compliance with the emission standards;

(B) Documentation of the historical range of normal (i.e., other than during compliance testing) metals feedrates for each feedstream;

(C) Documentation that the level of spiking recommended during the performance test will mask sampling and analysis imprecision and inaccuracy to the extent that the extrapolated feedrate limits adequately assure compliance with the emission standards;

(xi) If you do not continuously monitor regulated constituents in natural gas, process air feedstreams, and feedstreams from vapor recovery systems under §63.1209(c)(5), you must include documentation of the expected levels of regulated constituents in those feedstreams;

(xii) Documentation justifying the duration of system conditioning required to ensure the combustor has achieved steady-state operations under performance test operating conditions, as provided by paragraph (g)(1)(iii) of this section;

(xiii) For cement kilns with in-line raw mills, if you elect to use the emissions averaging provision of this subpart, you must notify the Administrator of your intent in the initial (and subsequent) comprehensive performance test plan, and provide the information required by the emission averaging provision;

(xiv) For preheater or preheater/precalciner cement kilns with dual stacks, if you elect to use the emissions averaging provision of this subpart, you must notify the Administrator of your intent in the initial (and subsequent) comprehensive performance test plan, and provide the information required by the emission averaging provision;

(xv) If you request to use Method 23 for dioxin/furan you must provide the information required under §63.1208(b)(1)(i)(B);

(xvi) If you are not required to conduct performance testing to document compliance with the mercury, semivolatile metals, low volatile metals, or hydrogen chloride/chlorine gas emission standards under paragraph (m) of this section, you must include with the comprehensive performance test plan documentation of compliance with the provisions of that section.

(xvii) If you propose to use a surrogate for measuring or monitoring gas flowrate, you must document in the comprehensive performance test plan that the surrogate adequately correlates with gas flowrate, as required by paragraph (m)(7) of this section, and §63.1209(j)(2), (k)(3), (m)(2)(i), (n)(5)(i), and (o)(2)(i).

(xviii) You must submit an application to request alternative monitoring under §63.1209(g)(1) not later than with the comprehensive performance test plan, as required by §63.1209(g)(1)(iii)(A).

(xix) You must document the temperature location measurement in the comprehensive performance test plan, as required by §§63.1209(j)(1)(i) and 63.1209(k)(2)(i).

(xx) If your source is equipped with activated carbon injection, you must document in the comprehensive performance test plan:

(A) The manufacturer specifications for minimum carrier fluid flowrate or pressure drop, as required by §63.1209(k)(6)(ii); and

(B) Key parameters that affect carbon adsorption, and the operating limits you establish for those parameters based on the carbon used during the performance test, if you elect not to specify and use the brand and type of carbon used during the comprehensive performance test, as required by §63.1209(k)(6)(iii).

(xxi) If your source is equipped with a carbon bed system, and you elect not to specify and use the brand and type of carbon used during the comprehensive performance test, you must include in the comprehensive performance test plan key parameters that affect carbon adsorption, and the operating limits you establish for those parameters based on the carbon used during the performance test, as required by §63.1209(k)(7)(ii).

(xxii) If you feed a dioxin/furan inhibitor into the combustion system, you must document in the comprehensive performance test plan key parameters that affect the effectiveness of the inhibitor, and the operating limits you establish for those parameters based on the inhibitor fed during the performance test, if you elect not to specify and use the brand and type of inhibitor used during the comprehensive performance test, as required by §63.1209(k)(9)(ii).

(xxiii) If your source is equipped with a wet scrubber and you elect to monitor solids content of the scrubber liquid manually but believe that hourly monitoring of solids content is not warranted, you must support an alternative monitoring frequency in the comprehensive performance test plan, as required by §63.1209(m)(1)(i)(B)(1)(i).

(xxiv) If your source is equipped with a particulate matter control device other than a wet scrubber, baghouse, or electrostatic precipitator, you must include in the comprehensive performance test plan:

(A) Documentation to support the operating parameter limits you establish for the control device, as required by §63.1209(m)(1)(iv)(A)(4); and

(B) Support for the use of manufacturer specifications if you recommend such specifications in lieu of basing operating limits on performance test operating levels, as required by §63.1209(m)(1)(iv)(D).

(xxv) If your source is equipped with a dry scrubber to control hydrogen chloride and chlorine gas, you must document in the comprehensive performance test plan key parameters that affect adsorption, and the limits you establish for those parameters based on the sorbent used during the performance test, if you elect not to specify and use the brand and type of sorbent used during the comprehensive performance test, as required by §63.1209(o)(4)(iii)(A); and

(xxvi) For purposes of calculating semivolatile metal, low volatile metal, mercury, and total chlorine (organic and inorganic), and ash feedrate limits, a description of how you will handle performance test feedstream analytical results that determines these constituents are not present at detectable levels.

(xxvii) Such other information as the Administrator reasonably finds necessary to determine whether to approve the performance test plan.

(2) *Content of confirmatory test plan.* (i) A description of your normal hydrocarbon or carbon monoxide operating levels, as specified in paragraph (g)(2)(i) of this section, and an explanation of how these normal levels were determined;

(ii) A description of your normal applicable operating parameter levels, as specified in paragraph (g)(2)(ii) of this section, and an explanation of how these normal levels were determined;

(iii) A description of your normal chlorine operating levels, as specified in paragraph (g)(2)(iii) of this section, and an explanation of how these normal levels were determined;

(iv) If you use carbon injection or a carbon bed, a description of your normal cleaning cycle of the particulate matter control device, as specified in paragraph (g)(2)(iv) of this section, and an explanation of how these normal levels were determined;

(v) A detailed description of sampling and monitoring procedures including sampling and monitoring locations in the system, the equipment to be used, sampling and monitoring frequency, and planned analytical procedures for sample analysis;

(vi) A detailed test schedule for each hazardous waste for which the performance test is planned, including date(s), duration, quantity of hazardous waste to be burned, and other relevant factors;

(vii) A detailed test protocol, including, for each hazardous waste identified, the ranges of hazardous waste feedrate for each feed system, and, as appropriate, the feedrates of other fuels and feedstocks, and any other relevant parameters that may affect the ability of the hazardous waste combustor to meet the dioxin/furan emission standard;

(viii) A description of, and planned operating conditions for, any emission control equipment that will be used;

(ix) Procedures for rapidly stopping the hazardous waste feed and controlling emissions in the event of an equipment malfunction; and

(x) Such other information as the Administrator reasonably finds necessary to determine whether to approve the confirmatory test plan.

(g) *Operating conditions during testing.* You must comply with the provisions of §63.7(e). Conducting performance testing under operating conditions representative of the extreme range of normal conditions is consistent with the requirement of §63.7(e)(1) to conduct performance testing under representative operating conditions.

(1) *Comprehensive performance testing—(i) Operations during testing.* For the following parameters, you must operate the combustor during the performance test under normal conditions (or conditions that will result in higher than normal emissions):

(A) *Chlorine feedrate.* You must feed normal (or higher) levels of chlorine during the dioxin/furan performance test;

(B) *Ash feedrate.* For hazardous waste incinerators, you must conduct the following tests when feeding normal (or higher) levels of ash: The semivolatile metal and low volatile metal performance tests; and the dioxin/furan and mercury performance tests if activated carbon injection or a carbon bed is used; and

(C) *Cleaning cycle of the particulate matter control device.* You must conduct the following tests when the particulate matter control device undergoes its normal (or more frequent) cleaning cycle: The particulate matter, semivolatile metal, and low volatile metal performance tests; and the dioxin/furan and mercury performance tests if activated carbon injection or a carbon bed is used.

(ii) *Modes of operation.* Given that you must establish limits for the applicable operating parameters specified in §63.1209 based on operations during the comprehensive performance test, you may conduct testing under two or more operating modes to provide operating flexibility.

(iii) *Steady-state conditions.* (A) Prior to obtaining performance test data, you must operate under performance test conditions until you reach steady-state operations with respect to emissions of pollutants you must measure during the performance test and operating parameters under §63.1209 for which you must establish limits. During system conditioning, you must ensure that each operating parameter for which you must establish a limit is held at the level planned for the performance test. You must include documentation in the performance test plan under paragraph (f) of this section justifying the duration of system conditioning.

(B) If you own or operate a hazardous waste cement kiln that recycles collected particulate matter (i.e., cement kiln dust) into the kiln, you must sample and analyze the recycled particulate matter prior to obtaining performance test data for levels of selected metals that must be measured during performance testing to document that the system has reached steady-state conditions (i.e., that metals levels have stabilized). You must document the rationale for selecting metals that are indicative of system equilibrium and include the information in the performance test plan under paragraph (f) of this section. To determine system equilibrium, you must sample and analyze the recycled particulate matter hourly for each selected metal, unless you submit in the performance test plan a justification for reduced sampling and analysis and the Administrator approves in writing a reduced sampling and analysis frequency.

(2) *Confirmatory performance testing.* You must conduct confirmatory performance testing for dioxin/furan under normal operating conditions for the following parameters:

(i) Carbon monoxide (or hydrocarbon) CEMS emissions levels must be within the range of the average value to the maximum value allowed, except as provided by paragraph (g)(2)(v) of this section. The average value is defined as the sum of the hourly rolling average values recorded (each minute) over the previous 12 months, divided by the number of rolling averages recorded during that time. The average value must not include calibration data, startup data, shutdown data, malfunction data, and data obtained when not burning hazardous waste;

(ii) Each operating limit (specified in §63.1209) established to maintain compliance with the dioxin/furan emission standard must be held within the range of the average value over the previous 12 months and the maximum or minimum, as appropriate, that is allowed, except as provided by paragraph (g)(2)(v) of this section. The average value is defined as the sum of the rolling average values recorded over the previous 12 months, divided by the number of rolling averages recorded during that time. The average value must not include calibration data, startup data, shutdown data, malfunction data, and data obtained when not burning hazardous waste;

(iii) You must feed chlorine at normal feedrates or greater; and

(iv) If the combustor is equipped with carbon injection or carbon bed, normal cleaning cycle of the particulate matter control device.

(v) The Administrator may approve an alternative range to that required by paragraphs (g)(2)(i) and (ii) of this section if you document in the confirmatory performance test plan that it may be problematic to maintain the required range during the test. In addition, when making the finding of compliance, the Administrator may consider test conditions outside of the range specified in the test plan based on a finding that you could not reasonably maintain the range specified in the test plan and considering factors including whether the time duration and level of the parameter when operations were out of the specified range were such that operations during the confirmatory test are determined to be reasonably representative of normal operations. In addition, the Administrator will consider the proximity of the emission test results to the standard.

(h) *Operating conditions during subsequent testing.* (1) Current operating parameter limits established under §63.1209 are waived during subsequent comprehensive performance testing.

(2) Current operating parameter limits are also waived during pretesting prior to comprehensive performance testing for an aggregate time not to exceed 720 hours of operation (renewable at the discretion of the Administrator) under an approved test plan or if the source records the results of the pretesting. Pretesting means:

(i) Operations when stack emissions testing for dioxin/furan, mercury, semivolatile metals, low volatile metals, particulate matter, or hydrogen chloride/chlorine gas is being performed; and

(ii) Operations to reach steady-state operating conditions prior to stack emissions testing under paragraph (g)(1)(iii) of this section.

(i) *Time extension for subsequent performance tests.* After the initial comprehensive performance test, you may request up to a one-year time extension for conducting a comprehensive or confirmatory performance test to consolidate performance testing with other state or federally required emission testing, or for other reasons deemed acceptable by the Administrator. If the Administrator grants a time extension for a comprehensive performance test, the deadlines for commencing the next comprehensive and confirmatory tests are based on the date that the subject comprehensive performance test commences.

(1) You must submit in writing to the Administrator any request under this paragraph for a time extension for conducting a performance test.

(2) You must include in the request for an extension for conducting a performance test the following:

(i) A description of the reasons for requesting the time extension;

(ii) The date by which you will commence performance testing.

(3) The Administrator will notify you in writing of approval or intention to deny approval of your request for an extension for conducting a performance test within 30 calendar days after receipt of sufficient information to evaluate your request. The 30-day approval or denial period will begin after you have been notified in writing that your application is complete. The Administrator will notify you in writing whether the application contains sufficient information to make a determination within 30 calendar days after receipt of the original application and within 30 calendar days after receipt of any supplementary information that you submit.

(4) When notifying you that your application is not complete, the Administrator will specify the information needed to complete the application. The Administrator will also provide notice of opportunity for you to present, in writing, within 30 calendar days after notification of the incomplete application, additional information or arguments to the Administrator to enable further action on the application.

(5) Before denying any request for an extension for performance testing, the Administrator will notify you in writing of the Administrator's intention to issue the denial, together with:

(i) Notice of the information and findings on which the intended denial is based; and

(ii) Notice of opportunity for you to present in writing, within 15 calendar days after notification of the intended denial, additional information or arguments to the Administrator before further action on the request.

(6) The Administrator's final determination to deny any request for an extension will be in writing and will set forth specific grounds upon which the denial is based. The final determination will be made within 30 calendar days after the presentation of additional information or argument (if the application is complete), or within 30 calendar days after the final date specified for the presentation if no presentation is made.

(j) *Notification of compliance*—(1) *Comprehensive performance test.* (i) Except as provided by paragraphs (j)(4) and (j)(5) of this section, within 90 days of completion of a comprehensive performance test, you must postmark a Notification of Compliance documenting compliance with the emission standards and continuous monitoring system requirements, and identifying operating parameter limits under §63.1209.

(ii) Upon postmark of the Notification of Compliance, you must comply with all operating requirements specified in the Notification of Compliance in lieu of the limits specified in the Documentation of Compliance required under §63.1211(c).

(2) *Confirmatory performance test.* Except as provided by paragraph (j)(4) of this section, within 90 days of completion of a confirmatory performance test, you must postmark a Notification of Compliance documenting compliance or noncompliance with the applicable dioxin/furan emission standard.

(3) See §§63.7(g), 63.9(h), and 63.1210(d) for additional requirements pertaining to the Notification of Compliance (e.g., you must include results of performance tests in the Notification of Compliance).

(4) *Time extension.* You may submit a written request to the Administrator for a time extension documenting that, for reasons beyond your control, you may not be able to meet the 90-day deadline for submitting the Notification of Compliance after completion of testing. The Administrator will determine whether a time extension is warranted.

(5) *Early compliance.* If you conduct the initial comprehensive performance test prior to the compliance date, you must postmark the Notification of Compliance within 90 days of completion of the performance test or by the compliance date, whichever is later.

(k) *Failure to submit a timely notification of compliance.* (1) If you fail to postmark a Notification of Compliance by the specified date, you must cease hazardous waste burning immediately.

(2) Prior to submitting a revised Notification of Compliance as provided by paragraph (k)(3) of this section, you may burn hazardous waste only for the purpose of pretesting or comprehensive performance testing and only for a maximum of 720 hours (renewable at the discretion of the Administrator).

(3) You must submit to the Administrator a Notification of Compliance subsequent to a new comprehensive performance test before resuming hazardous waste burning.

(l) *Failure of performance test*—(1) *Comprehensive performance test.* The provisions of this paragraph do not apply to the initial comprehensive performance test if you conduct the test prior to your compliance date.

(i) If you determine (based on CEM recordings, results of analyses of stack samples, or results of CMS performance evaluations) that you have exceeded any emission standard during a comprehensive performance test for a mode of operation, you must cease hazardous waste burning immediately under that mode of operation. You must make this determination within 90 days following completion of the performance test.

(ii) If you have failed to demonstrate compliance with the emission standards for any mode of operation:

(A) Prior to submitting a revised Notification of Compliance as provided by paragraph (l)(1)(ii)(C) of this section, you may burn hazardous waste only for the purpose of pretesting or comprehensive performance testing under revised operating conditions, and only for a maximum of 720 hours (renewable at the discretion of the Administrator), except as provided by paragraph (l)(3) of this section;

(B) You must conduct a comprehensive performance test under revised operating conditions following the requirements for performance testing of this section; and

(C) You must submit to the Administrator a Notification of Compliance subsequent to the new comprehensive performance test.

(2) *Confirmatory performance test.* If you determine (based on CEM recordings, results of analyses of stack samples, or results of CMS performance evaluations) that you have failed the dioxin/furan emission standard during a confirmatory performance test, you must cease burning hazardous waste immediately. You must make this determination within 90 days following completion of the performance test. To burn hazardous waste in the future:

(i) You must submit to the Administrator for review and approval a test plan to conduct a comprehensive performance test to identify revised limits on the applicable dioxin/furan operating parameters specified in §63.1209(k);

(ii) You must submit to the Administrator a Notification of Compliance with the dioxin/furan emission standard under the provisions of paragraphs (j) and (k) of this section and this paragraph (l). You must include in the Notification of Compliance the revised limits on the applicable dioxin/furan operating parameters specified in §63.1209(k); and

(iii) Until the Notification of Compliance is submitted, you must not burn hazardous waste except for purposes of pretesting or confirmatory performance testing, and for a maximum of 720 hours (renewable at the discretion of the Administrator), except as provided by paragraph (l)(3) of this section.

(3) You may petition the Administrator to obtain written approval to burn hazardous waste in the interim prior to submitting a Notification of Compliance for purposes other than testing or pretesting. You must specify operating requirements, including limits on operating parameters, that you determine will ensure compliance with the emission standards of this subpart based on available information including data from the failed performance test. The Administrator will review, modify as necessary, and approve if warranted the interim operating requirements. An approval of interim operating requirements will include a schedule for submitting a Notification of Compliance.

(m) *Waiver of performance test.* You are not required to conduct performance tests to document compliance with the mercury, semivolatile metals, low volatile metals, or hydrogen chloride/chlorine gas emission standards under the conditions specified in paragraphs (m)(1) or (m)(2) of this section. The waiver provisions of this paragraph apply in addition to the provisions of §63.7(h).

(1) *Emission standards based on exhaust gas flow rate.* (i) You are deemed to be in compliance with an emission standard based on the volumetric flow rate of exhaust gas (i.e., µg/dscm or ppmv) if the maximum theoretical emission concentration (MTEC) does not exceed the emission standard over the relevant averaging period specified under §63.1209(l), (n), and (o) of this section for the standard:

(A) Determine the feedrate of mercury, semivolatile metals, low volatile metals, or total chlorine and chloride from all feedstreams;

(B) Determine the stack gas flowrate; and

(C) Calculate a MTEC for each standard assuming all mercury, semivolatile metals, low volatile metals, or total chlorine (organic and inorganic) from all feedstreams is emitted;

(ii) To document compliance with this provision, you must:

(A) Monitor and record the feedrate of mercury, semivolatile metals, low volatile metals, and total chlorine and chloride from all feedstreams according to §63.1209(c);

(B) Monitor with a CMS and record in the operating record the gas flowrate (either directly or by monitoring a surrogate parameter that you have correlated to gas flowrate);

(C) Continuously calculate and record in the operating record the MTEC under the procedures of paragraph (m)(1)(i) of this section; and

(D) Interlock the MTEC calculated in paragraph (m)(1)(i)(C) of this section to the AWFCO system to stop hazardous waste burning when the MTEC exceeds the emission standard.

(iii) In lieu of the requirement in paragraphs (m)(1)(ii)(C) and (D) of this section, you may:

(A) Identify in the Notification of Compliance a minimum gas flowrate limit and a maximum feedrate limit of mercury, semivolatile metals, low volatile metals, and/or total chlorine and chloride from all feedstreams that ensures the MTEC as calculated in paragraph (m)(1)(i)(C) of this section is below the applicable emission standard; and

(B) Interlock the minimum gas flowrate limit and maximum feedrate limit of paragraph (m)(1)(iii)(A) of this section to the AWFCO system to stop hazardous waste burning when the gas flowrate or mercury, semivolatile metals, low volatile metals, and/or total chlorine and chloride feedrate exceeds the limits of paragraph (m)(1)(iii)(A) of this section.

(2) *Emission standards based on hazardous waste thermal concentration.* (i) You are deemed to be in compliance with an emission standard specified on a hazardous waste thermal concentration basis (i.e., pounds emitted per million Btu of heat input) if the HAP thermal concentration in the waste feed does not exceed the allowable HAP thermal concentration emission rate.

(ii) To document compliance with this provision, you must:

(A) Monitor and record the feedrate of mercury, semivolatile metals, low volatile metals, and total chlorine and chloride from all hazardous waste feedstreams in accordance with §63.1209(c);

(B) Determine and record the higher heating value of each hazardous waste feed;

(C) Continuously calculate and record the thermal feed rate of all hazardous waste feedstreams by summing the products of each hazardous waste feed rate multiplied by the higher heating value of that hazardous waste;

(D) Continuously calculate and record the total HAP thermal feed concentration for each constituent by dividing the HAP feedrate determined in paragraph (m)(2)(ii)(A) of this section by the thermal feed rate determined in paragraph (m)(2)(ii)(C) of this section for all hazardous waste feedstreams;

(E) Interlock the HAP thermal feed concentration for each constituent with the AWFCO to stop hazardous waste feed when the thermal feed concentration exceeds the applicable thermal emission standard.

(3) When you determine the feedrate of mercury, semivolatile metals, low volatile metals, or total chlorine and chloride for purposes of this provision, except as provided by paragraph (m)(4) of this section, you must assume that the analyte is present at the full detection limit when the feedstream analysis determines that the analyte is not detected in the feedstream.

(4) Owners and operators of hazardous waste burning cement kilns and lightweight aggregate kilns may assume that mercury is present in raw material at half the detection limit when the raw material feedstream analysis determines that mercury is not detected.

(5) You must state in the site-specific test plan that you submit for review and approval under paragraph (e) of this section that you intend to comply with the provisions of this paragraph. You must include in the test plan documentation that any surrogate that is proposed for gas flowrate adequately correlates with the gas flowrate.

[64 FR 53038, Sept. 30, 1999, as amended at 65 FR 42299, July 10, 2000; 65 FR 67271, Nov. 9, 2000; 66 FR 35106, July 3, 2001; 66 FR 63318, Dec. 6, 2001; 67 FR 6814, Feb. 13, 2002; 67 FR 6990, Feb. 14, 2002; 67 FR 77691, Dec. 19, 2002; 70 FR 59546, Oct. 12, 2005; 73 FR 18980, Apr. 8, 2008; 73 FR 64096, Oct. 28, 2008]

 [Back to Top](#)

§63.1208 What are the test methods?

(a) [Reserved]

(b) *Test methods.* You must use the following test methods to determine compliance with the emissions standards of this subpart:

(1) *Dioxins and furans.* (i) To determine compliance with the emission standard for dioxins and furans, you must use:

(A) Method 0023A, Sampling Method for Polychlorinated Dibenzo-*p*-Dioxins and Polychlorinated Dibenzofurans emissions from Stationary Sources, EPA Publication SW-846 (incorporated by reference—see §63.14); or

(B) Method 23, provided in appendix A, part 60 of this chapter, after approval by the Administrator.

(1) You may request approval to use Method 23 in the performance test plan required under §63.1207(e)(i) and (ii).

(2) In determining whether to grant approval to use Method 23, the Administrator may consider factors including whether dioxin/furan were detected at levels substantially below the emission standard in previous testing, and whether previous Method 0023 analyses detected low levels of dioxin/furan in the front half of the sampling train.

(3) Sources that emit carbonaceous particulate matter, such as coal-fired boilers, and sources equipped with activated carbon injection, will be deemed not suitable for use of Method 23 unless you document that there would not be a significant improvement in quality assurance with Method 0023A.

(ii) You must sample for a minimum of three hours, and you must collect a minimum sample volume of 2.5 dscm;

(iii) You may assume that nondetects are present at zero concentration.

(2) *Mercury*. You must use Method 29, provided in appendix A, part 60 of this chapter, to demonstrate compliance with emission standard for mercury.

(3) *Cadmium and lead*. You must use Method 29, provided in appendix A, part 60 of this chapter, to determine compliance with the emission standard for cadmium and lead (combined).

(4) *Arsenic, beryllium, and chromium*. You must use Method 29, provided in appendix A, part 60 of this chapter, to determine compliance with the emission standard for arsenic, beryllium, and chromium (combined).

(5) *Hydrogen chloride and chlorine gas*—(i) *Compliance with MACT standards*. To determine compliance with the emission standard for hydrogen chloride and chlorine gas (combined), you must use:

(A) Method 26/26A as provided in appendix A, part 60 of this chapter; or

(B) Methods 320 or 321 as provided in appendix A, part 63 of this chapter, or

(C) ASTM D 6735-01, Standard Test Method for Measurement of Gaseous Chlorides and Fluorides from Mineral Calcining Exhaust Sources—Impinger Method to measure emissions of hydrogen chloride, and Method 26/26A to measure emissions of chlorine gas, provided that you follow the provisions in paragraphs (b)(5)(C)(1) through (6) of this section. ASTM D 6735-01 is available for purchase from at least one of the following addresses: American Society for Testing and Materials (ASTM), 100 Barr Harbor Drive, Post Office Box C700, West Conshohocken, PA 19428-2959; or ProQuest, 300 North Zeeb Road, Ann Arbor, MI 48106.

(1) A test must include three or more runs in which a pair of samples is obtained simultaneously for each run according to section 11.2.6 of ASTM Method D6735-01.

(2) You must calculate the test run standard deviation of each set of paired samples to quantify data precision, according to Equation 1 of this section:

$$RSD_a = (100) \text{ Absolute Value } \left[\frac{C1_a - C2_a}{C1_a + C2_a} \right] \quad (\text{Eq. 1})$$

[View or download PDF](#)

Where:

RSD_a = The test run relative standard deviation of sample pair a, percent.

$C1_a$ and $C2_a$ = The HCl concentrations, milligram/dry standard cubic meter (mg/dscm), from the paired samples.

(3) You must calculate the test average relative standard deviation according to Equation 2 of this section:

$$RSD_{TA} = \frac{\sum_{a=1}^p RSD_a}{p} \quad (\text{Eq 2})$$

[View or download PDF](#)

Where:

RSD_{TA} = The test average relative standard deviation, percent.

RSD_a = The test run relative standard deviation for sample pair a.

p = The number of test runs, ≥ 3 .

(4) If RSDTA is greater than 20 percent, the data are invalid and the test must be repeated.

(5) The post-test analyte spike procedure of section 11.2.7 of ASTM Method D6735-01 is conducted, and the percent recovery is calculated according to section 12.6 of ASTM Method D6735-01.

(6) If the percent recovery is between 70 percent and 130 percent, inclusive, the test is valid. If the percent recovery is outside of this range, the data are considered invalid, and the test must be repeated.

(ii) *Compliance with risk-based limits under §63.1215.* To demonstrate compliance with emission limits established under §63.1215, you must use Method 26/26A as provided in appendix A, part 60 of this chapter, Method 320 as provided in appendix A, part 63 of this chapter, Method 321 as provided in appendix A, part 63 of this chapter, or ASTM D 6735-01, Standard Test Method for Measurement of Gaseous Chlorides and Fluorides from Mineral Calcining Exhaust Sources—Impinger Method (following the provisions of paragraphs (b)(5)(C)(1) through (6) of this section), except:

(A) For cement kilns and sources equipped with a dry acid gas scrubber, you must use Methods 320 or 321 as provided in appendix A, part 63 of this chapter, or ASTM D 6735-01 to measure hydrogen chloride, and the back-half, caustic impingers of Method 26/26A as provided in appendix A, part 60 of this chapter to measure chlorine gas; and

(B) For incinerators, boilers, and lightweight aggregate kilns, you must use Methods 320 or 321 as provided in appendix A, part 63 of this chapter, or ASTM D 6735-01 to measure hydrogen chloride, and Method 26/26A as provided in appendix A, part 60 of this chapter to measure total chlorine, and calculate chlorine gas by difference if:

(1) The bromine/chlorine ratio in feedstreams is greater than 5 percent; or

(2) The sulfur/chlorine ratio in feedstreams is greater than 50 percent.

(6) *Particulate matter.* You must use Methods 5 or 5I, provided in appendix A, part 60 of this chapter, to demonstrate compliance with the emission standard for particulate matter.

(7) *Other test methods.* You may use applicable test methods in EPA Publication SW-846, as incorporated by reference in paragraph (a) of this section, as necessary to demonstrate compliance with requirements of this subpart, except as otherwise specified in paragraphs (b)(2)-(b)(6) of this section.

(8) *Feedstream analytical methods.* You may use any reliable analytical method to determine feedstream concentrations of metals, chlorine, and other constituents. It is your responsibility to ensure

that the sampling and analysis procedures are unbiased, precise, and that the results are representative of the feedstream.

(9) *Opacity*. If you determine compliance with the opacity standard under the monitoring requirements of §§63.1209(a)(1)(iv) and (a)(1)(v), you must use Method 9, provided in appendix A, part 60 of this chapter.

[64 FR 53038, Sept. 30, 1999, as amended at 69 FR 18803, Apr. 9, 2004; 70 FR 34555, June 14, 2005; 70 FR 59547, Oct. 12, 2005]

[↑ Back to Top](#)

§63.1209 What are the monitoring requirements?

(a) *Continuous emissions monitoring systems (CEMS) and continuous opacity monitoring systems (COMS)*. (1)(i) You must use either a carbon monoxide or hydrocarbon CEMS to demonstrate and monitor compliance with the carbon monoxide and hydrocarbon standard under this subpart. You must also use an oxygen CEMS to continuously correct the carbon monoxide or hydrocarbon level to 7 percent oxygen.

(ii) (A) *Cement kilns under §63.1204*. Except as provided by paragraphs (a)(1)(iv) and (a)(1)(v) of the section, you must use a COMS to demonstrate and monitor compliance with the opacity standard under §§63.1204(a)(7) and (b)(7) at each point where emissions are vented from these affected sources including the bypass stack of a preheater or preheater/precalciner kiln with dual stacks.

(B) *Cement kilns under §63.1220*. Except as provided by paragraphs (a)(1)(iv) and (a)(1)(v) of the section and unless your source is equipped with a bag leak detection system under §63.1206(c)(8) or a particulate matter detection system under §63.1206(c)(9), you must use a COMS to demonstrate and monitor compliance with the opacity standard under §§63.1220(a)(7) and (b)(7) at each point where emissions are vented from these affected sources including the bypass stack of a preheater or preheater/precalciner kiln with dual stacks.

(C) You must maintain and operate each COMS in accordance with the requirements of §63.8(c) except for the requirements under §63.8(c)(3). The requirements of §63.1211(c) shall be complied with instead of §63.8(c)(3); and

(D) Compliance is based on a six-minute block average.

(iii) You must install, calibrate, maintain, and operate a particulate matter CEMS to demonstrate and monitor compliance with the particulate matter standards under this subpart. However, compliance with the requirements in this section to install, calibrate, maintain and operate the PM CEMS is not required until such time that the Agency promulgates all performance specifications and operational requirements applicable to PM CEMS.

(iv) If you operate a cement kiln subject to the provisions of this subpart and use a fabric filter with multiple stacks or an electrostatic precipitator with multiple stacks, you may, in lieu of installing the COMS required by paragraph (a)(1)(ii) of this section, comply with the opacity standard in accordance with the procedures of Method 9 to part 60 of this chapter:

(A) You must conduct the Method 9 test while the affected source is operating at the highest load or capacity level reasonably expected to occur within the day;

(B) The duration of the Method 9 test shall be at least 30 minutes each day;

(C) You must use the Method 9 procedures to monitor and record the average opacity for each six-minute block period during the test; and

(D) To remain in compliance, all six-minute block averages must not exceed the opacity standard.

(v) If you operate a cement kiln subject to the provisions of this subpart and use a particulate matter control device that exhausts through a monovent, or if the use of a COMS in accordance with the installation specification of Performance Specification 1 (PS-1) of appendix B to part 60 of this chapter is not feasible, you may, in lieu of installing the COMS required by paragraph (a)(1)(ii) of this section, comply with the opacity standard in accordance with the procedures of Method 9 to part 60 of this chapter:

(A) You must conduct the Method 9 test while the affected source is operating at the highest load or capacity level reasonably expected to occur within the day;

(B) The duration of the Method 9 test shall be at least 30 minutes each day;

(C) You must use the Method 9 procedures to monitor and record the average opacity for each six-minute block period during the test; and

(D) To remain in compliance, all six-minute block averages must not exceed the opacity standard.

(2) *Performance specifications.* You must install, calibrate, maintain, and continuously operate the CEMS and COMS in compliance with the quality assurance procedures provided in the appendix to this subpart and Performance Specifications 1 (opacity), 4B (carbon monoxide and oxygen), and 8A (hydrocarbons) in appendix B, part 60 of this chapter.

(3) *Carbon monoxide readings exceeding the span.* (i) Except as provided by paragraph (a)(3)(ii) of this section, if a carbon monoxide CEMS detects a response that results in a one-minute average at or above the 3,000 ppmv span level required by Performance Specification 4B in appendix B, part 60 of this chapter, the one-minute average must be recorded as 10,000 ppmv. The one-minute 10,000 ppmv value must be used for calculating the hourly rolling average carbon monoxide level.

(ii) Carbon monoxide CEMS that use a span value of 10,000 ppmv when one-minute carbon monoxide levels are equal to or exceed 3,000 ppmv are not subject to paragraph (a)(3)(i) of this section. Carbon monoxide CEMS that use a span value of 10,000 are subject to the same CEMS performance and equipment specifications when operating in the range of 3,000 ppmv to 10,000 ppmv that are provided by Performance Specification 4B for other carbon monoxide CEMS, except:

(A) Calibration drift must be less than 300 ppmv; and

(B) Calibration error must be less than 500 ppmv.

(4) *Hydrocarbon readings exceeding the span.* (i) Except as provided by paragraph (a)(4)(ii) of this section, if a hydrocarbon CEMS detects a response that results in a one-minute average at or above the 100 ppmv span level required by Performance Specification 8A in appendix B, part 60 of this chapter, the one-minute average must be recorded as 500 ppmv. The one-minute 500 ppmv value must be used for calculating the hourly rolling average HC level.

(ii) Hydrocarbon CEMS that use a span value of 500 ppmv when one-minute hydrocarbon levels are equal to or exceed 100 ppmv are not subject to paragraph (a)(4)(i) of this section. Hydrocarbon CEMS that use a span value of 500 ppmv are subject to the same CEMS performance and equipment

specifications when operating in the range of 100 ppmv to 500 ppmv that are provided by Performance Specification 8A for other hydrocarbon CEMS, except:

(A) The zero and high-level calibration gas must have a hydrocarbon level of between 0 and 100 ppmv, and between 250 and 450 ppmv, respectively;

(B) The strip chart recorder, computer, or digital recorder must be capable of recording all readings within the CEM measurement range and must have a resolution of 2.5 ppmv;

(C) The CEMS calibration must not differ by more than ± 15 ppmv after each 24-hour period of the seven day test at both zero and high levels;

(D) The calibration error must be no greater than 25 ppmv; and

(E) The zero level, mid-level, and high level calibration gas used to determine calibration error must have a hydrocarbon level of 0-200 ppmv, 150-200 ppmv, and 350-400 ppmv, respectively.

(5) *Petitions to use CEMS for other standards.* You may petition the Administrator to use CEMS for compliance monitoring for particulate matter, mercury, semivolatile metals, low volatile metals, and hydrogen chloride and chlorine gas under §63.8(f) in lieu of compliance with the corresponding operating parameter limits under this section.

(6) *Calculation of rolling averages—(i) Calculation of rolling averages initially.* The carbon monoxide or hydrocarbon CEMS must begin recording one-minute average values by 12:01 a.m. and hourly rolling average values by 1:01 a.m., when 60 one-minute values will be available for calculating the initial hourly rolling average for those sources that come into compliance on the regulatory compliance date. Sources that elect to come into compliance before the regulatory compliance date must begin recording one-minute and hourly rolling average values within 60 seconds and 60 minutes (when 60 one-minute values will be available for calculating the initial hourly rolling average), respectively, from the time at which compliance begins.

(ii) *Calculation of rolling averages upon intermittent operations.* You must ignore periods of time when one-minute values are not available for calculating the hourly rolling average. When one-minute values become available again, the first one-minute value is added to the previous 59 values to calculate the hourly rolling average.

(iii) *Calculation of rolling averages when the hazardous waste feed is cutoff.* (A) Except as provided by paragraph (a)(6)(iii)(B) of this section, you must continue monitoring carbon monoxide and hydrocarbons when the hazardous waste feed is cutoff if the source is operating. You must not resume feeding hazardous waste if the emission levels exceed the standard.

(B) You are not subject to the CEMS requirements of this subpart during periods of time you meet the requirements of §63.1206(b)(1)(ii) (compliance with emissions standards for nonhazardous waste burning sources when you are not burning hazardous waste).

(7) *Operating parameter limits for hydrocarbons.* If you elect to comply with the carbon monoxide and hydrocarbon emission standard by continuously monitoring carbon monoxide with a CEMS, you must demonstrate that hydrocarbon emissions during the comprehensive performance test do not exceed the hydrocarbon emissions standard. In addition, the limits you establish on the destruction and removal efficiency (DRE) operating parameters required under paragraph (j) of this section also ensure that you maintain compliance with the hydrocarbon emission standard. If you do not conduct the hydrocarbon demonstration and DRE tests concurrently, you must establish separate operating parameter limits under

paragraph (j) of this section based on each test and the more restrictive of the operating parameter limits applies.

(b) *Other continuous monitoring systems (CMS)*. (1) You must use CMS (e.g., thermocouples, pressure transducers, flow meters) to document compliance with the applicable operating parameter limits under this section.

(2) Except as specified in paragraphs (b)(2)(i) and (ii) of this section, you must install and operate continuous monitoring systems other than CEMS in conformance with §63.8(c)(3) that requires you, at a minimum, to comply with the manufacturer's written specifications or recommendations for installation, operation, and calibration of the system:

(i) *Calibration of thermocouples and pyrometers*. The calibration of thermocouples must be verified at a frequency and in a manner consistent with manufacturer specifications, but no less frequent than once per year. You must operate and maintain optical pyrometers in accordance with manufacturer specifications unless otherwise approved by the Administrator. You must calibrate optical pyrometers in accordance with the frequency and procedures recommended by the manufacturer, but no less frequent than once per year, unless otherwise approved by the Administrator. And,

(ii) *Accuracy and calibration of weight measurement devices for activated carbon injection systems*. If you operate a carbon injection system, the accuracy of the weight measurement device must be ± 1 percent of the weight being measured. The calibration of the device must be verified at least once each calendar quarter at a frequency of approximately 120 days.

(3) CMS must sample the regulated parameter without interruption, and evaluate the detector response at least once each 15 seconds, and compute and record the average values at least every 60 seconds.

(4) The span of the non-CEMS CMS detector must not be exceeded. You must interlock the span limits into the automatic waste feed cutoff system required by §63.1206(c)(3).

(5) *Calculation of rolling averages*—(i) *Calculation of rolling averages initially*. Continuous monitoring systems must begin recording one-minute average values by 12:01 a.m., hourly rolling average values by 1:01 a.m. (e.g., when 60 one-minute values will be available for calculating the initial hourly rolling average), and twelve-hour rolling averages by 12:01 p.m. (e.g., when 720 one-minute averages are available to calculate a 12-hour rolling average), for those sources that come into compliance on the regulatory compliance date. Sources that elect to come into compliance before the regulatory compliance date must begin recording one-minute, hourly rolling average, and 12-hour rolling average values within 60 seconds, 60 minutes (when 60 one-minute values will be available for calculating the initial hourly rolling average), and 720 minutes (when 720 one-minute values will be available for calculating the initial 12-hour rolling average) respectively, from the time at which compliance begins.

(ii) *Calculation of rolling averages upon intermittent operations*. You must ignore periods of time when one-minute values are not available for calculating rolling averages. When one-minute values become available again, the first one-minute value is added to the previous one-minute values to calculate rolling averages.

(iii) *Calculation of rolling averages when the hazardous waste feed is cutoff*. (A) Except as provided by paragraph (b)(5)(iii)(B) of this section, you must continue monitoring operating parameter limits with a CMS when the hazardous waste feed is cutoff if the source is operating. You must not resume feeding hazardous waste if an operating parameter exceeds its limit.

(B) You are not subject to the CMS requirements of this subpart during periods of time you meet the requirements of §63.1206(b)(1)(ii) (compliance with emissions standards for nonhazardous waste burning sources when you are not burning hazardous waste).

(c) *Analysis of feedstreams*—(1) *General*. Prior to feeding the material, you must obtain an analysis of each feedstream that is sufficient to document compliance with the applicable feedrate limits provided by this section.

(2) *Feedstream analysis plan*. You must develop and implement a feedstream analysis plan and record it in the operating record. The plan must specify at a minimum:

(i) The parameters for which you will analyze each feedstream to ensure compliance with the operating parameter limits of this section;

(ii) Whether you will obtain the analysis by performing sampling and analysis or by other methods, such as using analytical information obtained from others or using other published or documented data or information;

(iii) How you will use the analysis to document compliance with applicable feedrate limits (e.g., if you blend hazardous wastes and obtain analyses of the wastes prior to blending but not of the blended, as-fired, waste, the plan must describe how you will determine the pertinent parameters of the blended waste);

(iv) The test methods which you will use to obtain the analyses;

(v) The sampling method which you will use to obtain a representative sample of each feedstream to be analyzed using sampling methods described in appendix IX, part 266 of this chapter, or an equivalent method; and

(vi) The frequency with which you will review or repeat the initial analysis of the feedstream to ensure that the analysis is accurate and up to date.

(3) *Review and approval of analysis plan*. You must submit the feedstream analysis plan to the Administrator for review and approval, if requested.

(4) *Compliance with feedrate limits*. To comply with the applicable feedrate limits of this section, you must monitor and record feedrates as follows:

(i) Determine and record the value of the parameter for each feedstream by sampling and analysis or other method;

(ii) Determine and record the mass or volume flowrate of each feedstream by a CMS. If you determine flowrate of a feedstream by volume, you must determine and record the density of the feedstream by sampling and analysis (unless you report the constituent concentration in units of weight per unit volume (e.g., mg/l)); and

(iii) Calculate and record the mass feedrate of the parameter per unit time.

(5) *Waiver of monitoring of constituents in certain feedstreams*. You are not required to monitor levels of metals or chlorine in the following feedstreams to document compliance with the feedrate limits under this section provided that you document in the comprehensive performance test plan the expected levels of the constituent in the feedstream and account for those assumed feedrate levels in documenting compliance with feedrate limits: natural gas, process air, and feedstreams from vapor recovery systems.

(d) *Performance evaluations.* (1) The requirements of §§63.8(d) (Quality control program) and (e) (Performance evaluation of continuous monitoring systems) apply, except that you must conduct performance evaluations of components of the CMS under the frequency and procedures (for example, submittal of performance evaluation test plan for review and approval) applicable to performance tests as provided by §63.1207.

(2) You must comply with the quality assurance procedures for CEMS prescribed in the appendix to this subpart.

(e) *Conduct of monitoring.* The provisions of §63.8(b) apply.

(f) *Operation and maintenance of continuous monitoring systems.* The provisions of §63.8(c) apply except:

(1) *Section 63.8(c)(3).* The requirements of §63.1211(c), that requires CMSs to be installed, calibrated, and operational on the compliance date, shall be complied with instead of section 63.8(c)(3);

(2) *Section 63.8(c)(4)(ii).* The performance specifications for carbon monoxide, hydrocarbon, and oxygen CEMSs in subpart B, part 60 of this chapter that requires detectors to measure the sample concentration at least once every 15 seconds for calculating an average emission rate once every 60 seconds shall be complied with instead of section 63.8(c)(4)(ii); and

(3) Sections 63.8(c)(4)(i), (c)(5), and (c)(7)(i)(C) pertaining to COMS apply only to owners and operators of hazardous waste burning cement kilns.

(g) *Alternative monitoring requirements other than continuous emissions monitoring systems (CEMS)—(1) Requests to use alternatives to operating parameter monitoring requirements.* (i) You may submit an application to the Administrator under this paragraph for approval of alternative operating parameter monitoring requirements to document compliance with the emission standards of this subpart. For requests to use additional CEMS, however, you must use paragraph (a)(5) of this section and §63.8(f). Alternative requests to operating parameter monitoring requirements that include unproven monitoring methods may not be made under this paragraph and must be made under §63.8(f).

(ii) You may submit an application to waive an operating parameter limit specified in this section based on documentation that neither that operating parameter limit nor an alternative operating parameter limit is needed to ensure compliance with the emission standards of this subpart.

(iii) You must comply with the following procedures for applications submitted under paragraphs (g)(1)(i) and (ii) of this section:

(A) *Timing of the application.* You must submit the application to the Administrator not later than with the comprehensive performance test plan.

(B) *Content of the application.* You must include in the application:

(1) Data or information justifying your request for an alternative monitoring requirement (or for a waiver of an operating parameter limit), such as the technical or economic infeasibility or the impracticality of using the required approach;

(2) A description of the proposed alternative monitoring requirement, including the operating parameter to be monitored, the monitoring approach/technique (e.g., type of detector, monitoring location), the averaging period for the limit, and how the limit is to be calculated; and

(3) Data or information documenting that the alternative monitoring requirement would provide equivalent or better assurance of compliance with the relevant emission standard, or that it is the monitoring requirement that best assures compliance with the standard and that is technically and economically practicable.

(C) *Approval of request to use an alternative monitoring requirement or waive an operating parameter limit.* The Administrator will notify you of approval or intention to deny approval of the request within 90 calendar days after receipt of the original request and within 60 calendar days after receipt of any supplementary information that you submit. The Administrator will not approve an alternative monitoring request unless the alternative monitoring requirement provides equivalent or better assurance of compliance with the relevant emission standard, or is the monitoring requirement that best assures compliance with the standard and that is technically and economically practicable. Before disapproving any request, the Administrator will notify you of the Administrator's intention to disapprove the request together with:

(1) Notice of the information and findings on which the intended disapproval is based; and

(2) Notice of opportunity for you to present additional information to the Administrator before final action on the request. At the time the Administrator notifies you of intention to disapprove the request, the Administrator will specify how much time you will have after being notified of the intended disapproval to submit the additional information.

(D) *Responsibility of owners and operators.* You are responsible for ensuring that you submit any supplementary and additional information supporting your application in a timely manner to enable the Administrator to consider your application during review of the comprehensive performance test plan. Neither your submittal of an application, nor the Administrator's failure to approve or disapprove the application, relieves you of the responsibility to comply with the provisions of this subpart.

(iv) *Dual standards that incorporate the interim standards for HAP metals—(A) Semivolatile and low volatile metals.* You may petition the Administrator to waive a feedrate operating parameter limit under paragraph (n)(2) of this section for either the emission standards expressed in a thermal emissions format or the interim standards based on documentation that the feedrate operating parameter limit is not needed to ensure compliance with the relevant standard on a continuous basis.

(B) *Mercury.* You may petition the Administrator to waive a feedrate operating parameter limit under paragraph (l)(1) of this section for either the feed concentration standard under §§63.1220(a)(2)(i) and (b)(2)(i) or the interim standards based on documentation that the feedrate operating parameter limit is not needed to ensure compliance with the relevant standard on a continuous basis.

(2) *Administrator's discretion to specify additional or alternative requirements.* The Administrator may determine on a case-by-case basis at any time (e.g., during review of the comprehensive performance test plan, during compliance certification review) that you may need to limit additional or alternative operating parameters (e.g., opacity in addition to or in lieu of operating parameter limits on the particulate matter control device) or that alternative approaches to establish limits on operating parameters may be necessary to document compliance with the emission standards of this subpart.

(h) *Reduction of monitoring data.* The provisions of §63.8(g) apply.

(i) *When an operating parameter is applicable to multiple standards.* Paragraphs (j) through (p) of this section require you to establish limits on operating parameters based on comprehensive performance testing to ensure you maintain compliance with the emission standards of this subpart. For several parameters, you must establish a limit for the parameter to ensure compliance with more than one emission standard. An example is a limit on minimum combustion chamber temperature to ensure compliance with both the DRE standard of paragraph (j) of this section and the dioxin/furan standard of

paragraph (k) of this section. If the performance tests for such standards are not performed simultaneously, the most stringent limit for a parameter derived from independent performance tests applies.

(j) *DRE*. To remain in compliance with the destruction and removal efficiency (DRE) standard, you must establish operating limits during the comprehensive performance test (or during a previous DRE test under provisions of §63.1206(b)(7)) for the following parameters, unless the limits are based on manufacturer specifications, and comply with those limits at all times that hazardous waste remains in the combustion chamber (i.e., the hazardous waste residence time has not transpired since the hazardous waste feed cutoff system was activated):

(1) *Minimum combustion chamber temperature*. (i) You must measure the temperature of each combustion chamber at a location that best represents, as practicable, the bulk gas temperature in the combustion zone. You must document the temperature measurement location in the test plan you submit under §63.1207(e);

(ii) You must establish a minimum hourly rolling average limit as the average of the test run averages;

(2) *Maximum flue gas flowrate or production rate*. (i) As an indicator of gas residence time in the control device, you must establish and comply with a limit on the maximum flue gas flowrate, the maximum production rate, or another parameter that you document in the site-specific test plan as an appropriate surrogate for gas residence time, as the average of the maximum hourly rolling averages for each run.

(ii) You must comply with this limit on a hourly rolling average basis;

(3) *Maximum hazardous waste feedrate*. (i) You must establish limits on the maximum pumpable and total (i.e., pumpable and nonpumpable) hazardous waste feedrate for each location where hazardous waste is fed.

(ii) You must establish the limits as the average of the maximum hourly rolling averages for each run.

(iii) You must comply with the feedrate limit(s) on a hourly rolling average basis;

(4) *Operation of waste firing system*. You must specify operating parameters and limits to ensure that good operation of each hazardous waste firing system is maintained.

(k) *Dioxins and furans*. You must comply with the dioxin and furans emission standard by establishing and complying with the following operating parameter limits. You must base the limits on operations during the comprehensive performance test, unless the limits are based on manufacturer specifications.

(1) *Gas temperature at the inlet to a dry particulate matter control device*. (i) For sources other than a lightweight aggregate kiln, if the combustor is equipped with an electrostatic precipitator, baghouse (fabric filter), or other dry emissions control device where particulate matter is suspended in contact with combustion gas, you must establish a limit on the maximum temperature of the gas at the inlet to the device on an hourly rolling average. You must establish the hourly rolling average limit as the average of the test run averages.

(ii) For hazardous waste burning lightweight aggregate kilns, you must establish a limit on the maximum temperature of the gas at the exit of the (last) combustion chamber (or exit of any waste heat

recovery system) on an hourly rolling average. The limit must be established as the average of the test run averages;

(2) *Minimum combustion chamber temperature.* (i) For sources other than cement kilns, you must measure the temperature of each combustion chamber at a location that best represents, as practicable, the bulk gas temperature in the combustion zone. You must document the temperature measurement location in the test plan you submit under §§63.1207(e) and (f);

(ii) You must establish a minimum hourly rolling average limit as the average of the test run averages.

(3) *Maximum flue gas flowrate or production rate.* (i) As an indicator of gas residence time in the control device, you must establish and comply with a limit on the maximum flue gas flowrate, the maximum production rate, or another parameter that you document in the site-specific test plan as an appropriate surrogate for gas residence time, as the average of the maximum hourly rolling averages for each run.

(ii) You must comply with this limit on a hourly rolling average basis;

(4) *Maximum hazardous waste feedrate.* (i) You must establish limits on the maximum pumpable and total (pumpable and nonpumpable) hazardous waste feedrate for each location where waste is fed.

(ii) You must establish the limits as the average of the maximum hourly rolling averages for each run.

(iii) You must comply with the feedrate limit(s) on a hourly rolling average basis;

(5) *Particulate matter operating limit.* If your combustor is equipped with an activated carbon injection system, you must establish operating parameter limits on the particulate matter control device as specified by paragraph (m)(1) of this section;

(6) *Activated carbon injection parameter limits.* If your combustor is equipped with an activated carbon injection system:

(i) *Carbon feedrate.* You must establish a limit on minimum carbon injection rate on an hourly rolling average calculated as the average of the test run averages. If your carbon injection system injects carbon at more than one location, you must establish a carbon feedrate limit for each location.

(ii) *Carrier fluid.* You must establish a limit on minimum carrier fluid (gas or liquid) flowrate or pressure drop as an hourly rolling average based on the manufacturer's specifications. You must document the specifications in the test plan you submit under §§63.1207(e) and (f);

(iii) *Carbon specification.* (A) You must specify and use the brand (i.e., manufacturer) and type of carbon used during the comprehensive performance test until a subsequent comprehensive performance test is conducted, unless you document in the site-specific performance test plan required under §§63.1207(e) and (f) key parameters that affect adsorption and establish limits on those parameters based on the carbon used in the performance test.

(B) You may substitute at any time a different brand or type of carbon provided that the replacement has equivalent or improved properties compared to the carbon used in the performance test and conforms to the key sorbent parameters you identify under paragraph (k)(6)(iii)(A) of this section. You must include in the operating record documentation that the substitute carbon will provide the same level of control as the original carbon.

(7) *Carbon bed parameter limits.* If your combustor is equipped with a carbon bed system:

(i) *Monitoring bed life.* You must:

(A) Monitor performance of the carbon bed consistent with manufacturer's specifications and recommendations to ensure the carbon bed (or bed segment for sources with multiple segments) has not reached the end of its useful life to minimize dioxin/furan and mercury emissions at least to the levels required by the emission standards;

(B) Document the monitoring procedures in the operation and maintenance plan;

(C) Record results of the performance monitoring in the operating record; and

(D) Replace the bed or bed segment before it has reached the end of its useful life to minimize dioxin/furan and mercury emissions at least to the levels required by the emission standards.

(ii) *Carbon specification.* (A) You must specify and use the brand (i.e., manufacturer) and type of carbon used during the comprehensive performance test until a subsequent comprehensive performance test is conducted, unless you document in the site-specific performance test plan required under §§63.1207(e) and (f) key parameters that affect adsorption and establish limits on those parameters based on the carbon used in the performance test.

(B) You may substitute at any time a different brand or type of carbon provided that the replacement has equivalent or improved properties compared to the carbon used in the performance test. You must include in the operating record documentation that the substitute carbon will provide an equivalent or improved level of control as the original carbon.

(iii) *Maximum temperature.* You must measure the temperature of the carbon bed at either the bed inlet or exit and you must establish a maximum temperature limit on an hourly rolling average as the average of the test run averages.

(8) *Catalytic oxidizer parameter limits.* If your combustor is equipped with a catalytic oxidizer, you must establish limits on the following parameters:

(i) *Minimum flue gas temperature at the entrance of the catalyst.* You must establish a limit on minimum flue gas temperature at the entrance of the catalyst on an hourly rolling average as the average of the test run averages.

(ii) *Maximum time in-use.* You must replace a catalytic oxidizer with a new catalytic oxidizer when it has reached the maximum service time specified by the manufacturer.

(iii) *Catalyst replacement specifications.* When you replace a catalyst with a new one, the new catalyst must be equivalent to or better than the one used during the previous comprehensive test, as measured by:

(A) Catalytic metal loading for each metal;

(B) Space time, expressed in the units s^{-1} , the maximum rated volumetric flow of combustion gas through the catalyst divided by the volume of the catalyst; and

(C) Substrate construction, including materials of construction, washcoat type, and pore density.

(iv) *Maximum flue gas temperature.* You must establish a maximum flue gas temperature limit at the entrance of the catalyst as an hourly rolling average, based on manufacturer's specifications.

(9) *Inhibitor feedrate parameter limits.* If you feed a dioxin/furan inhibitor into the combustion system, you must establish limits for the following parameters:

(i) *Minimum inhibitor feedrate.* You must establish a limit on minimum inhibitor feedrate on an hourly rolling average as the average of the test run averages.

(ii) *Inhibitor specifications.* (A) You must specify and use the brand (i.e., manufacturer) and type of inhibitor used during the comprehensive performance test until a subsequent comprehensive performance test is conducted, unless you document in the site-specific performance test plan required under §§63.1207(e) and (f) key parameters that affect the effectiveness of the inhibitor and establish limits on those parameters based on the inhibitor used in the performance test.

(B) You may substitute at any time a different brand or type of inhibitor provided that the replacement has equivalent or improved properties compared to the inhibitor used in the performance test and conforms to the key parameters you identify under paragraph (k)(9)(ii)(A) of this section. You must include in the operating record documentation that the substitute inhibitor will provide the same level of control as the original inhibitor.

(l) *Mercury.* You must comply with the mercury emission standard by establishing and complying with the following operating parameter limits. You must base the limits on operations during the comprehensive performance test, unless the limits are based on manufacturer specifications.

(1) *Feedrate of mercury.* (i) For incinerators and solid fuel boilers, when complying with the mercury emission standards under §§63.1203, 63.1216 and 63.1219, you must establish a 12-hour rolling average limit for the total feedrate of mercury in all feedstreams as the average of the test run averages.

(ii) For liquid fuel boilers, when complying with the mercury emission standards of §63.1217, you must establish a rolling average limit for the mercury feedrate as follows on an averaging period not to exceed an annual rolling average:

(A) You must calculate a mercury system removal efficiency for each test run and calculate the average system removal efficiency of the test run averages. If emissions exceed the mercury emission standard during the comprehensive performance test, it is not a violation because the averaging period for the mercury emission standard is (not-to-exceed) one year and compliance is based on compliance with the mercury feedrate limit with an averaging period not-to-exceed one year.

(B) If you burn hazardous waste with a heating value of 10,000 Btu/lb or greater, you must calculate the mercury feedrate limit as follows:

(1) The mercury feedrate limit is the emission standard divided by $[1 - \text{system removal efficiency}]$.

(2) The mercury feedrate limit is a hazardous waste thermal concentration limit expressed as pounds of mercury in hazardous waste feedstreams per million Btu of hazardous waste fired.

(3) You must comply with the hazardous waste mercury thermal concentration limit by determining the feedrate of mercury in all hazardous waste feedstreams (lb/hr) at least once a minute and the hazardous waste thermal feedrate (MM Btu/hr) at least once a minute to calculate a 60-minute average thermal emission concentration as $[\text{hazardous waste mercury feedrate (lb/hr)} / \text{hazardous waste thermal feedrate (MM Btu/hr)}]$.

(4) You must calculate a rolling average hazardous waste mercury thermal concentration that is updated each hour.

(5) If you select an averaging period for the feedrate limit that is greater than a 12-hour rolling average, you must calculate the initial rolling average as though you had selected a 12-hour rolling average, as provided by paragraph (b)(5)(i) of this section. Thereafter, you must calculate rolling averages using either one-minute or one-hour updates. Hourly updates shall be calculated using the average of the one-minute average data for the preceding hour. For the period beginning with initial operation under this standard until the source has operated for the full averaging period that you select, the average feedrate shall be based only on actual operation under this standard.

(C) If you burn hazardous waste with a heating value of less than 10,000 Btu/lb, you must calculate the mercury feedrate limit as follows:

(1) You must calculate the mercury feedrate limit as the mercury emission standard divided by [1 – System Removal Efficiency].

(2) The feedrate limit is expressed as a mass concentration per unit volume of stack gas ($\mu\text{gm/dscm}$) and is converted to a mass feedrate (lb/hr) by multiplying it by the average stack gas flowrate of the test run averages.

(3) You must comply with the feedrate limit by determining the mercury feedrate (lb/hr) at least once a minute to calculate a 60-minute average feedrate.

(4) You must update the rolling average feedrate each hour with this 60-minute feedrate measurement.

(5) If you select an averaging period for the feedrate limit that is greater than a 12-hour rolling average, you must calculate the initial rolling average as though you had selected a 12-hour rolling average, as provided by paragraph (b)(5)(i) of this section. Thereafter, you must calculate rolling averages using either one-minute or one-hour updates. Hourly updates shall be calculated using the average of the one-minute average data for the preceding hour. For the period beginning with initial operation under this standard until the source has operated for the full averaging period that you select, the average feedrate shall be based only on actual operation under this standard.

(D) If your boiler is equipped with a wet scrubber, you must comply with the following unless you document in the performance test plan that you do not feed chlorine at rates that may substantially affect the system removal efficiency of mercury for purposes of establishing a mercury feedrate limit based on the system removal efficiency during the test:

(1) Scrubber blowdown must be minimized during a pretest conditioning period and during the performance test:

(2) Scrubber water must be preconditioned so that mercury in the water is at equilibrium with stack gas at the mercury feedrate level of the performance test; and

(3) You must establish an operating limit on minimum pH of scrubber water as the average of the test run averages and comply with the limit on an hourly rolling average.

(iii) For cement kilns:

(A) When complying with the emission standards under §§63.1220(a)(2)(i) and (b)(2)(i), you must:

(1) Comply with the mercury hazardous waste feed concentration operating requirement on a twelve-hour rolling average;

(2) Monitor and record in the operating record the as-fired mercury concentration in the hazardous waste (or the weighted-average mercury concentration for multiple hazardous waste feedstreams);

(3) Initiate an automatic waste feed cutoff that immediately and automatically cuts off the hazardous waste feed when the as-fired mercury concentration operating requirement is exceeded;

(B) When complying with the emission standards under §§63.1204 and 63.1220(a)(2)(ii)(A) and (b)(2)(ii)(A), you must establish a 12-hour rolling average limit for the feedrate of mercury in all feedstreams as the average of the test run averages;

(C) Except as provided by paragraph (I)(1)(iii)(D) of this section, when complying with the hazardous waste maximum theoretical emission concentration (MTEC) under §63.1220(a)(2)(ii)(B) and (b)(2)(ii)(B), you must:

(1) Comply with the MTEC operating requirement on a twelve-hour rolling average;

(2) Monitor and record the feedrate of mercury for each hazardous waste feedstream according to §63.1209(c);

(3) Monitor with a CMS and record in the operating record the gas flowrate (either directly or by monitoring a surrogate parameter that you have correlated to gas flowrate);

(4) Continuously calculate and record in the operating record a MTEC assuming mercury from all hazardous waste feedstreams is emitted;

(5) Initiate an automatic waste feed cutoff that immediately and automatically cuts off the hazardous waste feed when the MTEC operating requirement is exceeded;

(D) In lieu of complying with paragraph (I)(1)(iii)(C) of this section, you may:

(1) Identify in the Notification of Compliance a minimum gas flowrate limit and a maximum feedrate limit of mercury from all hazardous waste feedstreams that ensures the MTEC calculated in paragraph (I)(1)(iii)(C)(4) of this section is below the operating requirement under paragraphs §§63.1220(a)(2)(ii)(B) and (b)(2)(ii)(B); and

(2) Initiate an automatic waste feed cutoff that immediately and automatically cuts off the hazardous waste feed when either the gas flowrate or mercury feedrate exceeds the limits identified in paragraph (I)(1)(iii)(D)(1) of this section.

(iv) For lightweight aggregate kilns:

(A) When complying with the emission standards under §§63.1205, 63.1221(a)(2)(i) and (b)(2)(i), you must establish a 12-hour rolling average limit for the total feedrate of mercury in all feedstreams as the average of the test run averages;

(B) Except as provided by paragraph (I)(1)(iv)(C) of this section, when complying with the hazardous waste feedrate corresponding to a maximum theoretical emission concentration (MTEC) under §§63.1221(a)(2)(ii) and (b)(2)(ii), you must:

(1) Comply with the MTEC operating requirement on a twelve-hour rolling average;

(2) Monitor and record the feedrate of mercury for each hazardous waste feedstream according to §63.1209(c);

(3) Monitor with a CMS and record in the operating record the gas flowrate (either directly or by monitoring a surrogate parameter that you have correlated to gas flowrate);

(4) Continuously calculate and record in the operating record a MTEC assuming mercury from all hazardous waste feedstreams is emitted;

(5) Initiate an automatic waste feed cutoff that immediately and automatically cuts off the hazardous waste feed when the MTEC operating requirement is exceeded;

(C) In lieu of complying with paragraph (l)(1)(iv)(B) of this section, you may:

(1) Identify in the Notification of Compliance a minimum gas flowrate limit and a maximum feedrate limit of mercury from all hazardous waste feedstreams that ensures the MTEC calculated in paragraph (l)(1)(iv)(B)(4) of this section is below the operating requirement under paragraphs §§63.1221(a)(2)(ii) and (b)(2)(ii); and

(2) Initiate an automatic waste feed cutoff that immediately and automatically cuts off the hazardous waste feed when either the gas flowrate or mercury feedrate exceeds the limits identified in paragraph (l)(1)(iv)(C)(1) of this section.

(v) *Extrapolation of feedrate levels.* In lieu of establishing mercury feedrate limits as specified in paragraphs (l)(1)(i) through (iv) of this section, you may request as part of the performance test plan under §§63.7(b) and (c) and §§63.1207 (e) and (f) to use the mercury feedrates and associated emission rates during the comprehensive performance test to extrapolate to higher allowable feedrate limits and emission rates. The extrapolation methodology will be reviewed and approved, as warranted, by the Administrator. The review will consider in particular whether:

(A) Performance test metal feedrates are appropriate (i.e., whether feedrates are at least at normal levels; depending on the heterogeneity of the waste, whether some level of spiking would be appropriate; and whether the physical form and species of spiked material is appropriate); and

(B) Whether the extrapolated feedrates you request are warranted considering historical metal feedrate data.

(2) *Wet scrubber.* If your combustor is equipped with a wet scrubber, you must establish operating parameter limits prescribed by paragraph (o)(3) of this section, except for paragraph (o)(3)(iv).

(3) *Activated carbon injection.* If your combustor is equipped with an activated carbon injection system, you must establish operating parameter limits prescribed by paragraphs (k)(5) and (k)(6) of this section.

(4) *Activated carbon bed.* If your combustor is equipped with an activated carbon bed system, you must comply with the requirements of (k)(7) of this section to assure compliance with the mercury emission standard.

(m) *Particulate matter.* You must comply with the particulate matter emission standard by establishing and complying with the following operating parameter limits. You must base the limits on

operations during the comprehensive performance test, unless the limits are based on manufacturer specifications.

(1) *Control device operating parameter limits (OPLs)*—(i) *Wet scrubbers*. For sources equipped with wet scrubbers, including ionizing wet scrubbers, high energy wet scrubbers such as venturi, hydrosonic, collision, or free jet wet scrubbers, and low energy wet scrubbers such as spray towers, packed beds, or tray towers, you must establish limits on the following parameters:

(A) For high energy scrubbers only, minimum pressure drop across the wet scrubber on an hourly rolling average, established as the average of the test run averages;

(B) For all wet scrubbers:

(1) To ensure that the solids content of the scrubber liquid does not exceed levels during the performance test, you must either:

(i) Establish a limit on solids content of the scrubber liquid using a CMS or by manual sampling and analysis. If you elect to monitor solids content manually, you must sample and analyze the scrubber liquid hourly unless you support an alternative monitoring frequency in the performance test plan that you submit for review and approval; or

(ii) Establish a minimum blowdown rate using a CMS and either a minimum scrubber tank volume or liquid level using a CMS.

(2) For maximum solids content monitored with a CMS, you must establish a limit on a twelve-hour rolling average as the average of the test run averages.

(3) For maximum solids content measured manually, you must establish an hourly limit, as measured at least once per hour, unless you support an alternative monitoring frequency in the performance test plan that you submit for review and approval. You must establish the maximum hourly limit as the average of the manual measurement averages for each run.

(4) For minimum blowdown rate and either a minimum scrubber tank volume or liquid level using a CMS, you must establish a limit on an hourly rolling average as the average of the test run averages.

(C) For high energy wet scrubbers only, you must establish limits on either the minimum liquid to gas ratio or the minimum scrubber water flowrate and maximum flue gas flowrate on an hourly rolling average. If you establish limits on maximum flue gas flowrate under this paragraph, you need not establish a limit on maximum flue gas flowrate under paragraph (m)(2) of this section. You must establish these hourly rolling average limits as the average of the test run averages; and

(ii)-(iii) [Reserved]

(iv) *Other particulate matter control devices*. For each particulate matter control device that is not a fabric filter or high energy wet scrubber, or is not an electrostatic precipitator or ionizing wet scrubber for which you elect to monitor particulate matter loadings under §63.1206(c)(9) of this chapter for process control, you must ensure that the control device is properly operated and maintained as required by §63.1206(c)(7) and by monitoring the operation of the control device as follows:

(A) During each comprehensive performance test conducted to demonstrate compliance with the particulate matter emissions standard, you must establish a range of operating values for the control device that is a representative and reliable indicator that the control device is operating within the same

range of conditions as during the performance test. You must establish this range of operating values as follows:

(1) You must select a set of operating parameters appropriate for the control device design that you determine to be a representative and reliable indicator of the control device performance.

(2) You must measure and record values for each of the selected operating parameters during each test run of the performance test. A value for each selected parameter must be recorded using a continuous monitor.

(3) For each selected operating parameter measured in accordance with the requirements of paragraph (m)(1)(iv)(A)(1) of this section, you must establish a minimum operating parameter limit or a maximum operating parameter limit, as appropriate for the parameter, to define the operating limits within which the control device can operate and still continuously achieve the same operating conditions as during the performance test.

(4) You must prepare written documentation to support the operating parameter limits established for the control device and you must include this documentation in the performance test plan that you submit for review and approval. This documentation must include a description for each selected parameter and the operating range and monitoring frequency required to ensure the control device is being properly operated and maintained.

(B) You must install, calibrate, operate, and maintain a monitoring device equipped with a recorder to measure the values for each operating parameter selected in accordance with the requirements of paragraph (m)(1)(iv)(A)(1) of this section. You must install, calibrate, and maintain the monitoring equipment in accordance with the equipment manufacturer's specifications. The recorder must record the detector responses at least every 60 seconds, as required in the definition of continuous monitor.

(C) You must regularly inspect the data recorded by the operating parameter monitoring system at a sufficient frequency to ensure the control device is operating properly. An excursion is determined to have occurred any time that the actual value of a selected operating parameter is less than the minimum operating limit (or, if applicable, greater than the maximum operating limit) established for the parameter in accordance with the requirements of paragraph (m)(1)(iv)(A)(3) of this section.

(D) Operating parameters selected in accordance with paragraph (m)(1)(iv) of this section may be based on manufacturer specifications provided you support the use of manufacturer specifications in the performance test plan that you submit for review and approval.

(2) *Maximum flue gas flowrate or production rate.* (i) As an indicator of gas residence time in the control device, you must establish a limit on the maximum flue gas flowrate, the maximum production rate, or another parameter that you document in the site-specific test plan as an appropriate surrogate for gas residence time, as the average of the maximum hourly rolling averages for each run.

(ii) You must comply with this limit on a hourly rolling average basis;

(3) *Maximum ash feedrate.* Owners and operators of hazardous waste incinerators, solid fuel boilers, and liquid fuel boilers must establish a maximum ash feedrate limit as a 12-hour rolling average based on the average of the test run averages. This requirement is waived, however, if you comply with the particulate matter detection system requirements under §63.1206(c)(9).

(n) *Semivolatile metals and low volatility metals.* You must comply with the semivolatile metal (cadmium and lead) and low volatile metal (arsenic, beryllium, and chromium) emission standards by establishing and complying with the following operating parameter limits. You must base the limits on

operations during the comprehensive performance test, unless the limits are based on manufacturer specifications.

(1) *Maximum inlet temperature to dry particulate matter air pollution control device.* You must establish a limit on the maximum inlet temperature to the primary dry metals emissions control device (e.g., electrostatic precipitator, baghouse) on an hourly rolling average basis as the average of the test run averages.

(2) *Maximum feedrate of semivolatile and low volatile metals—(i) General.* You must establish feedrate limits for semivolatile metals (cadmium and lead) and low volatile metals (arsenic, beryllium, and chromium) as follows, except as provided by paragraph (n)(2)(vii) of this section.

(ii) For incinerators, cement kilns, and lightweight aggregate kilns, when complying with the emission standards under §§63.1203, 63.1204, 63.1205, and 63.1219, and for solid fuel boilers when complying with the emission standards under §63.1216, you must establish 12-hour rolling average limits for the total feedrate of semivolatile and low volatile metals in all feedstreams as the average of the test run averages.

(iii) *Cement kilns under §63.1220.* (A) When complying with the emission standards under §63.1220(a)(3)(i), (a)(4)(i), (b)(3)(i), and (b)(4)(i), you must establish 12-hour rolling average feedrate limits for semivolatile and low volatile metals as the thermal concentration of semivolatile metals or low volatile metals in all hazardous waste feedstreams. You must calculate hazardous waste thermal concentrations for semivolatile metals and low volatile metals for each run as the total mass feedrate of semivolatile metals or low volatile metals for all hazardous waste feedstreams divided by the total heat input rate for all hazardous waste feedstreams. The 12-hour rolling average feedrate limits for semivolatile metals and low volatile metals are the average of the test run averages, calculated on a thermal concentration basis, for all hazardous waste feeds.

(B) When complying with the emission standards under §§63.1220(a)(3)(ii), (a)(4)(ii), (b)(3)(ii), and (b)(4)(ii), you must establish 12-hour rolling average limits for the total feedrate of semivolatile and low volatile metals in all feedstreams as the average of the test run averages.

(iv) *Lightweight aggregate kilns under §63.1221.* (A) When complying with the emission standards under §§63.1221(a)(3)(i), (a)(4)(i), (b)(3)(i), and (b)(4)(i), you must establish 12-hour rolling average feedrate limits for semivolatile and low volatile metals as the thermal concentration of semivolatile metals or low volatile metals in all hazardous waste feedstreams as specified in paragraphs (n)(2)(iii)(A) of this section.

(B) When complying with the emission standards under §§63.1221(a)(3)(ii), (a)(4)(ii), (b)(3)(ii), and (b)(4)(ii), you must establish 12-hour rolling average limits for the total feedrate of semivolatile and low volatile metals in all feedstreams as the average of the test run averages.

(v) *Liquid fuel boilers under §63.1217—(A) Semivolatile metals.* You must establish a rolling average limit for the semivolatile metal feedrate as follows on an averaging period not to exceed an annual rolling average.

(1) *System removal efficiency.* You must calculate a semivolatile metal system removal efficiency for each test run and calculate the average system removal efficiency of the test run averages. If emissions exceed the semivolatile metal emission standard during the comprehensive performance test, it is not a violation because the averaging period for the semivolatile metal emission standard is one year and compliance is based on compliance with the semivolatile metal feedrate limit that has an averaging period not to exceed an annual rolling average.

(2) *Boilers that feed hazardous waste with a heating value of 10,000 Btu/lb or greater.* You must calculate the semivolatile metal feedrate limit as the semivolatile metal emission standard divided by [1 – System Removal Efficiency].

(i) The feedrate limit is a hazardous waste thermal concentration limit expressed as pounds of semivolatile metals in all hazardous waste feedstreams per million Btu of hazardous waste fed to the boiler.

(ii) You must comply with the hazardous waste semivolatile metal thermal concentration limit by determining the feedrate of semivolatile metal in all hazardous waste feedstreams (lb/hr) and the hazardous waste thermal feedrate (MM Btu/hr) at least once a minute to calculate a 60-minute average thermal emission concentration as [hazardous waste semivolatile metal feedrate (lb/hr) / hazardous waste thermal feedrate (MM Btu/hr)].

(iii) You must calculate a rolling average hazardous waste semivolatile metal thermal concentration that is updated each hour.

(iv) If you select an averaging period for the feedrate limit that is greater than a 12-hour rolling average, you must calculate the initial rolling average as though you had selected a 12-hour rolling average, as provided by paragraph (b)(5)(i) of this section. Thereafter, you must calculate rolling averages using either one-minute or one-hour updates. Hourly updates shall be calculated using the average of the one-minute average data for the preceding hour. For the period beginning with initial operation under this standard until the source has operated for the full averaging period that you select, the average feedrate shall be based only on actual operation under this standard.

(3) *Boilers that feed hazardous waste with a heating value less than 10,000 Btu/lb.* (i) You must calculate the semivolatile metal feedrate limit as the semivolatile metal emission standard divided by [1 – System Removal Efficiency].

(ii) The feedrate limit is expressed as a mass concentration per unit volume of stack gas ($\mu\text{gm/dscm}$) and is converted to a mass feedrate (lb/hr) by multiplying it by the average stack gas flowrate (dscm/hr) of the test run averages.

(iii) You must comply with the feedrate limit by determining the semivolatile metal feedrate (lb/hr) at least once a minute to calculate a 60-minute average feedrate.

(iv) You must update the rolling average feedrate each hour with this 60-minute feedrate measurement.

(v) If you select an averaging period for the feedrate limit that is greater than a 12-hour rolling average, you must calculate the initial rolling average as though you had selected a 12-hour rolling average, as provided by paragraph (b)(5)(i) of this section. Thereafter, you must calculate rolling averages using either one-minute or one-hour updates. Hourly updates shall be calculated using the average of the one-minute average data for the preceding hour. For the period beginning with initial operation under this standard until the source has operated for the full averaging period that you select, the average feedrate shall be based only on actual operation under this standard.

(B) *Chromium—(1) Boilers that feed hazardous waste with a heating value of 10,000 Btu/lb or greater.* (i) The 12-hour rolling average feedrate limit is a hazardous waste thermal concentration limit expressed as pounds of chromium in all hazardous waste feedstreams per million Btu of hazardous waste fed to the boiler. You must establish the 12-hour rolling average feedrate limit as the average of the test run averages.

(ii) You must comply with the hazardous waste chromium thermal concentration limit by determining the feedrate of chromium in all hazardous waste feedstreams (lb/hr) and the hazardous waste thermal feedrate (MMBtu/hr) at least once each minute as [hazardous waste chromium feedrate (lb/hr)/hazardous waste thermal feedrate (MMBtu/hr)].

(2) *Boilers that feed hazardous waste with a heating value less than 10,000 Btu/lb.* You must establish a 12-hour rolling average limit for the total feedrate (lb/hr) of chromium in all feedstreams as the average of the test run averages.

(vi) *LVM limits for pumpable wastes.* You must establish separate feedrate limits for low volatile metals in pumpable feedstreams using the procedures prescribed above for total low volatile metals. Dual feedrate limits for both pumpable and total feedstreams are not required, however, if you base the total feedrate limit solely on the feedrate of pumpable feedstreams.

(vii) *Extrapolation of feedrate levels.* In lieu of establishing feedrate limits as specified in paragraphs (n)(2)(ii) through (vi) of this section, you may request as part of the performance test plan under §§63.7(b) and (c) and §§63.1207(e) and (f) to use the semivolatile metal and low volatile metal feedrates and associated emission rates during the comprehensive performance test to extrapolate to higher allowable feedrate limits and emission rates. The extrapolation methodology will be reviewed and approved, as warranted, by the Administrator. The review will consider in particular whether:

(A) Performance test metal feedrates are appropriate (i.e., whether feedrates are at least at normal levels; depending on the heterogeneity of the waste, whether some level of spiking would be appropriate; and whether the physical form and species of spiked material is appropriate); and

(B) Whether the extrapolated feedrates you request are warranted considering historical metal feedrate data.

(3) *Control device operating parameter limits (OPLs).* You must establish operating parameter limits on the particulate matter control device as specified by paragraph (m)(1) of this section;

(4) *Maximum total chlorine and chloride feedrate.* You must establish a 12-hour rolling average limit for the feedrate of total chlorine and chloride in all feedstreams as the average of the test run averages.

(5) *Maximum flue gas flowrate or production rate.* (i) As an indicator of gas residence time in the control device, you must establish a limit on the maximum flue gas flowrate, the maximum production rate, or another parameter that you document in the site-specific test plan as an appropriate surrogate for gas residence time, as the average of the maximum hourly rolling averages for each run.

(ii) You must comply with this limit on a hourly rolling average basis.

(o) *Hydrogen chloride and chlorine gas.* You must comply with the hydrogen chloride and chlorine gas emission standard by establishing and complying with the following operating parameter limits. You must base the limits on operations during the comprehensive performance test, unless the limits are based on manufacturer specifications.

(1) *Feedrate of total chlorine and chloride—(i) Incinerators, cement kilns, lightweight aggregate kilns, solid fuel boilers, and hydrochloric acid production furnaces.* You must establish a 12-hour rolling average limit for the total feedrate of chlorine (organic and inorganic) in all feedstreams as the average of the test run averages.

(ii) *Liquid fuel boilers—(A) Boilers that feed hazardous waste with a heating value not less than 10,000 Btu/lb.* (1) The feedrate limit is a hazardous waste thermal concentration limit expressed as

pounds of chlorine (organic and inorganic) in all hazardous waste feedstreams per million Btu of hazardous waste fed to the boiler.

(2) You must establish a 12-hour rolling average feedrate limit as the average of the test run averages.

(3) You must comply with the feedrate limit by determining the mass feedrate of hazardous waste feedstreams (lb/hr) at least once a minute and by knowing the chlorine content (organic and inorganic, lb of chlorine/lb of hazardous waste) and heating value (Btu/lb) of hazardous waste feedstreams at all times to calculate a 1-minute average feedrate measurement as [hazardous waste chlorine content (lb of chlorine/lb of hazardous waste feed)/hazardous waste heating value (Btu/lb of hazardous waste)]. You must update the rolling average feedrate each hour with this 60-minute average feedrate measurement.

(B) *Boilers that feed hazardous waste with a heating value less than 10,000 Btu/lb.* You must establish a 12-hour rolling average limit for the total feedrate of chlorine (organic and inorganic) in all feedstreams as the average of the test run averages. You must update the rolling average feedrate each hour with a 60-minute average feedrate measurement.

(2) *Maximum flue gas flowrate or production rate.* (i) As an indicator of gas residence time in the control device, you must establish a limit on the maximum flue gas flowrate, the maximum production rate, or another parameter that you document in the site-specific test plan as an appropriate surrogate for gas residence time, as the average of the maximum hourly rolling averages for each run.

(ii) You must comply with this limit on a hourly rolling average basis;

(3) *Wet scrubber.* If your combustor is equipped with a wet scrubber:

(i) If your source is equipped with a high energy wet scrubber such as a venturi, hydrosonic, collision, or free jet wet scrubber, you must establish a limit on minimum pressure drop across the wet scrubber on an hourly rolling average as the average of the test run averages;

(ii) If your source is equipped with a low energy wet scrubber such as a spray tower, packed bed, or tray tower, you must establish a minimum pressure drop across the wet scrubber based on manufacturer's specifications. You must comply with the limit on an hourly rolling average;

(iii) If your source is equipped with a low energy wet scrubber, you must establish a limit on minimum liquid feed pressure to the wet scrubber based on manufacturer's specifications. You must comply with the limit on an hourly rolling average;

(iv) You must establish a limit on minimum pH on an hourly rolling average as the average of the test run averages;

(v) You must establish limits on either the minimum liquid to gas ratio or the minimum scrubber water flowrate and maximum flue gas flowrate on an hourly rolling average as the average of the test run averages. If you establish limits on maximum flue gas flowrate under this paragraph, you need not establish a limit on maximum flue gas flowrate under paragraph (o)(2) of this section; and

(4) *Dry scrubber.* If your combustor is equipped with a dry scrubber, you must establish the following operating parameter limits:

(i) *Minimum sorbent feedrate.* You must establish a limit on minimum sorbent feedrate on an hourly rolling average as the average of the test run averages.

(ii) *Minimum carrier fluid flowrate or nozzle pressure drop.* You must establish a limit on minimum carrier fluid (gas or liquid) flowrate or nozzle pressure drop based on manufacturer's specifications.

(iii) *Sorbent specifications.* (A) You must specify and use the brand (i.e., manufacturer) and type of sorbent used during the comprehensive performance test until a subsequent comprehensive performance test is conducted, unless you document in the site-specific performance test plan required under §§63.1207(e) and (f) key parameters that affect adsorption and establish limits on those parameters based on the sorbent used in the performance test.

(B) You may substitute at any time a different brand or type of sorbent provided that the replacement has equivalent or improved properties compared to the sorbent used in the performance test and conforms to the key sorbent parameters you identify under paragraph (o)(4)(iii)(A) of this section. You must record in the operating record documentation that the substitute sorbent will provide the same level of control as the original sorbent.

(p) *Maximum combustion chamber pressure.* If you comply with the requirements for combustion system leaks under §63.1206(c)(5) by maintaining the maximum combustion chamber zone pressure lower than ambient pressure to prevent combustion systems leaks from hazardous waste combustion, you must perform instantaneous monitoring of pressure and the automatic waste feed cutoff system must be engaged when negative pressure is not adequately maintained.

(q) *Operating under different modes of operation.* If you operate under different modes of operation, you must establish operating parameter limits for each mode. You must document in the operating record when you change a mode of operation and begin complying with the operating limits for an alternative mode of operation.

(1) *Operating under otherwise applicable standards after the hazardous waste residence time has transpired.* As provided by §63.1206(b)(1)(ii), you may operate under otherwise applicable requirements promulgated under sections 112 and 129 of the Clean Air Act in lieu of the substantive requirements of this subpart.

(i) The otherwise applicable requirements promulgated under sections 112 and 129 of the Clean Air Act are applicable requirements under this subpart.

(ii) You must specify (e.g., by reference) the otherwise applicable requirements as a mode of operation in your Documentation of Compliance under §63.1211(c), your Notification of Compliance under §63.1207(j), and your title V permit application. These requirements include the otherwise applicable requirements governing emission standards, monitoring and compliance, and notification, reporting, and recordkeeping.

(2) *Calculating rolling averages under different modes of operation.* When you transition to a different mode of operation, you must calculate rolling averages as follows:

(i) *Retrieval approach.* Calculate rolling averages anew using the continuous monitoring system values previously recorded for that mode of operation (i.e., you ignore continuous monitoring system values subsequently recorded under other modes of operation when you transition back to a mode of operation); or

(ii) *Start anew.* Calculate rolling averages anew without considering previous recordings.

(A) Rolling averages must be calculated as the average of the available one-minute values for the parameter until enough one-minute values are available to calculate hourly or 12-hour rolling averages, whichever is applicable to the parameter.

(B) You may not transition to a new mode of operation using this approach if the most recent operation in that mode resulted in an exceedance of an applicable emission standard measured with a CEMS or operating parameter limit prior to the hazardous waste residence time expiring; or

(iii) *Seamless transition.* Continue calculating rolling averages using data from the previous operating mode provided that both the operating limit and the averaging period for the parameter are the same for both modes of operation.

(r) *Averaging periods.* The averaging periods specified in this section for operating parameters are not-to-exceed averaging periods. You may elect to use shorter averaging periods. For example, you may elect to use a 1-hour rolling average rather than the 12-hour rolling average specified in paragraph (l)(1)(i) of this section for mercury.

[64 FR 53038, Sept. 30, 1999, as amended at 65 FR 42300, July 10, 2000; 65 FR 67271, Nov. 9, 2000; 66 FR 24272, May 14, 2001; 66 FR 35106, July 3, 2001; 67 FR 6815, Feb. 13, 2002; 67 FR 6991, Feb. 14, 2002; 67 FR 77691, Dec. 19, 2002; 70 FR 59548, Oct. 12, 2005; 73 FR 18981, Apr. 8, 2008]

[↑ Back to Top](#)

NOTIFICATION, REPORTING AND RECORDKEEPING

[↑ Back to Top](#)

§63.1210 What are the notification requirements?

(a) *Summary of requirements.* (1) You must submit the following notifications to the Administrator:

Reference	Notification
63.9(b)	Initial notifications that you are subject to Subpart EEE of this Part.
63.9(d)	Notification that you are subject to special compliance requirements.
63.9(j)	Notification and documentation of any change in information already provided under §63.9.
63.1206(b)(5)(i)	Notification of changes in design, operation, or maintenance.
63.1206(c)(8)(iv)	Notification of excessive bag leak detection system exceedances.
63.1206(c)(9)(v)	Notification of excessive particulate matter detection system exceedances.
63.1207(e), 63.9(e) 63.9(g)(1) and (3)	Notification of performance test and continuous monitoring system evaluation, including the performance test plan and CMS performance evaluation plan. ¹
63.1210(b)	Notification of intent to comply.

63.1210(d), 63.1207(j), 63.1207(k), 63.1207(l), 63.9(h), 63.10(d)(2), 63.10(e)(2)	Notification of compliance, including results of performance tests and continuous monitoring system performance evaluations.
-----------------------------------------------------------------------------------	------------------------------------------------------------------------------------------------------------------------------

¹You may also be required on a case-by-case basis to submit a feedstream analysis plan under §63.1209(c)(3).

(2) You must submit the following notifications to the Administrator if you request or elect to comply with alternative requirements:

Reference	Notification, request, petition, or application
63.9(i)	You may request an adjustment to time periods or postmark deadlines for submittal and review of required information.
63.10(e)(3)(ii)	You may request to reduce the frequency of excess emissions and CMS performance reports.
63.10(f)	You may request to waive recordkeeping or reporting requirements.
63.1204(d)(2)(iii), 63.1220(d)(2)(iii)	Notification that you elect to comply with the emission averaging requirements for cement kilns with in-line raw mills.
63.1204(e)(2)(iii), 63.1220(e)(2)(iii)	Notification that you elect to comply with the emission averaging requirements for preheater or preheater/precalciner kilns with dual stacks.
63.1206(b)(4), 63.1213, 63.6(i), 63.9(c)	You may request an extension of the compliance date for up to one year.
63.1206(b)(5)(i)(C)	You may request to burn hazardous waste for more than 720 hours and for purposes other than testing or pretesting after making a change in the design or operation that could affect compliance with emission standards and prior to submitting a revised Notification of Compliance.
63.1206(b)(8)(iii)(B)	If you elect to conduct particulate matter CEMS correlation testing and wish to have federal particulate matter and opacity standards and associated operating limits waived during the testing, you must notify the Administrator by submitting the correlation test plan for review and approval.
63.1206(b)(8)(v)	You may request approval to have the particulate matter and opacity standards and associated operating limits and conditions waived for more than 96 hours for a correlation test.
63.1206(b)(9)	Owners and operators of lightweight aggregate kilns may request approval of alternative emission standards for mercury, semivolatile metal, low volatile metal, and hydrogen chloride/chlorine gas under certain conditions.
63.1206(b)(10)	Owners and operators of cement kilns may request approval of

	alternative emission standards for mercury, semivolatile metal, low volatile metal, and hydrogen chloride/chlorine gas under certain conditions.
63.1206(b)(14)	Owners and operators of incinerators may elect to comply with an alternative to the particulate matter standard.
63.1206(b)(15)	Owners and operators of cement and lightweight aggregate kilns may request to comply with the alternative to the interim standards for mercury.
63.1206(c)(2)(ii)(C)	You may request to make changes to the startup, shutdown, and malfunction plan.
63.1206(c)(5)(i)(C)	You may request an alternative means of control to provide control of combustion system leaks.
63.1206(c)(5)(i)(D)	You may request other techniques to prevent fugitive emissions without use of instantaneous pressure limits.
63.1207(c)(2)	You may request to base initial compliance on data in lieu of a comprehensive performance test.
63.1207(d)(3)	You may request more than 60 days to complete a performance test if additional time is needed for reasons beyond your control.
63.1207(e)(3), 63.7(h)	You may request a time extension if the Administrator fails to approve or deny your test plan.
63.1207(h)(2)	You may request to waive current operating parameter limits during pretesting for more than 720 hours.
63.1207(f)(1)(ii)(D)	You may request a reduced hazardous waste feedstream analysis for organic hazardous air pollutants if the reduced analysis continues to be representative of organic hazardous air pollutants in your hazardous waste feedstreams.
63.1207(g)(2)(v)	You may request to operate under a wider operating range for a parameter during confirmatory performance testing.
63.1207(i)	You may request up to a one-year time extension for conducting a performance test (other than the initial comprehensive performance test) to consolidate testing with other state or federally-required testing.
63.1207(j)(4)	You may request more than 90 days to submit a Notification of Compliance after completing a performance test if additional time is needed for reasons beyond your control.
63.1207(l)(3)	After failure of a performance test, you may request to burn hazardous waste for more than 720 hours and for purposes other than testing or pretesting.
63.1209(a)(5), 63.8(f)	You may request: (1) Approval of alternative monitoring methods for

	compliance with standards that are monitored with a CEMS; and (2) approval to use a CEMS in lieu of operating parameter limits.
63.1209(g)(1)	You may request approval of: (1) Alternatives to operating parameter monitoring requirements, except for standards that you must monitor with a continuous emission monitoring system (CEMS) and except for requests to use a CEMS in lieu of operating parameter limits; or (2) a waiver of an operating parameter limit.
63.1209(l)(1)	You may request to extrapolate mercury feedrate limits.
63.1209(n)(2)	You may request to extrapolate semivolatile and low volatile metal feedrate limits.
63.1211(d)	You may request to use data compression techniques to record data on a less frequent basis than required by §63.1209.

(b) *Notification of intent to comply (NIC)*. These procedures apply to sources that have not previously complied with the requirements of paragraphs (b) and (c) of this section, and to sources that previously complied with the NIC requirements of §§63.1210 and 63.1212(a), which were in effect prior to October 11, 2000, that must make a technology change requiring a Class 1 permit modification to meet the standards of §§63.1219, 63.1220, and 63.1221.

(1) You must prepare a Notification of Intent to Comply that includes all of the following information:

(i) General information:

(A) The name and address of the owner/operator and the source;

(B) Whether the source is a major or an area source;

(C) Waste minimization and emission control technique(s) being considered;

(D) Emission monitoring technique(s) you are considering;

(E) Waste minimization and emission control technique(s) effectiveness;

(F) A description of the evaluation criteria used or to be used to select waste minimization and/or emission control technique(s); and

(G) A general description of how you intend to comply with the emission standards of this subpart.

(ii) As applicable to each source, information on key activities and estimated dates for these activities that will bring the source into compliance with emission control requirements of this subpart. You must include all of the following key activities and dates in your NIC:

(A) The dates by which you anticipate you will develop engineering designs for emission control systems or process changes for emissions;

(B) The date by which you anticipate you will commit internal or external resources for installing emission control systems or making process changes for emission control, or the date by which you will issue orders for the purchase of component parts to accomplish emission control or process changes.

(C) The date by which you anticipate you will submit construction applications;

(D) The date by which you anticipate you will initiate on-site construction, installation of emission control equipment, or process change;

(E) The date by which you anticipate you will complete on-site construction, installation of emission control equipment, or process change; and

(F) The date by which you anticipate you will achieve final compliance. The individual dates and milestones listed in paragraphs (b)(1)(ii)(A) through (F) of this section as part of the NIC are not requirements and therefore are not enforceable deadlines; the requirements of paragraphs (b)(1)(ii)(A) through (F) of this section must be included as part of the NIC only to inform the public of how you intend to comply with the emission standards of this subpart.

(iii) A summary of the public meeting required under paragraph (c) of this section;

(iv) If you intend to cease burning hazardous waste prior to or on the compliance date, the requirements of paragraphs (b)(1)(ii) and (b)(1)(iii) of this section do not apply. You must include in your NIC a schedule of key dates for the steps to be taken to stop hazardous waste activity at your combustion unit. Key dates include the date for submittal of RCRA closure documents required under subpart G, part 264 or subpart G, part 265 of this chapter.

(2) You must make a draft of the NIC available for public review no later than 30 days prior to the public meeting required under paragraph (c)(1) of this section or no later than 9 months after the effective date of the rule if you intend to cease burning hazardous waste prior to or on the compliance date.

(3) You must submit the final NIC to the Administrator:

(i) *Existing units*. No later than one year following the effective date of the emission standards of this subpart; or

(ii) *New units*. No later than 60 days following the informal public meeting.

(c) *NIC public meeting and notice*. (1) Prior to the submission of the NIC to the permitting agency and:

(i) *Existing units*. No later than 10 months after the effective date of the emission standards of this subpart, you must hold at least one informal meeting with the public to discuss the anticipated activities described in the draft NIC for achieving compliance with the emission standards of this subpart. You must post a sign-in sheet or otherwise provide a voluntary opportunity for attendees to provide their names and addresses.

(ii) *New units*. No earlier than thirty (30) days following notice of the informal public meeting, you must hold at least one informal meeting with the public to discuss the anticipated activities described in the draft NIC for achieving compliance with the emission standards of this subpart. You must post a sign-in sheet or otherwise provide a voluntary opportunity for attendees to provide their names and addresses.

(2) You must submit a summary of the meeting, along with the list of attendees and their addresses developed under paragraph (b)(1) of this section, and copies of any written comments or materials

submitted at the meeting, to the Administrator as part of the final NIC, in accordance with paragraph (b)(1)(iii) of this section;

(3) You must provide public notice of the NIC meeting at least 30 days prior to the meeting and you must maintain, and provide to the Administrator upon request, documentation of the notice. You must provide public notice in all of the following forms:

(i) *Newspaper advertisement.* You must publish a notice in a newspaper of general circulation in the county or equivalent jurisdiction of your facility. In addition, you must publish the notice in newspapers of general circulation in adjacent counties or equivalent jurisdiction where such publication would be necessary to inform the affected public. You must publish the notice as a display advertisement.

(ii) *Visible and accessible sign.* You must post a notice on a clearly marked sign at or near the source. If you place the sign on the site of the hazardous waste combustor, the sign must be large enough to be readable from the nearest spot where the public would pass by the site.

(iii) *Broadcast media announcement.* You must broadcast a notice at least once on at least one local radio station or television station.

(iv) *Notice to the facility mailing list.* You must provide a copy of the notice to the facility mailing list in accordance with §124.10(c)(1)(ix) of this chapter.

(4) You must include all of the following in the notices required under paragraph (c)(3) of this section:

(i) The date, time, and location of the meeting;

(ii) A brief description of the purpose of the meeting;

(iii) A brief description of the source and proposed operations, including the address or a map (e.g., a sketched or copied street map) of the source location;

(iv) A statement encouraging people to contact the source at least 72 hours before the meeting if they need special access to participate in the meeting;

(v) A statement describing how the draft NIC (and final NIC, if requested) can be obtained; and

(vi) The name, address, and telephone number of a contact person for the NIC.

(5) The requirements of this paragraph do not apply to sources that intend to cease burning hazardous waste prior to or on the compliance date.

(d) *Notification of compliance.* (1) The Notification of Compliance status requirements of §63.9(h) apply, except that:

(i) The notification is a Notification of Compliance, rather than compliance status;

(ii) The notification is required for the initial comprehensive performance test and each subsequent comprehensive and confirmatory performance test; and

(iii) You must postmark the notification before the close of business on the 90th day following completion of relevant compliance demonstration activity specified in this subpart rather than the 60th day as required by §63.9(h)(2)(ii).

(2) Upon postmark of the Notification of Compliance, the operating parameter limits identified in the Notification of Compliance, as applicable, shall be complied with, the limits identified in the Documentation of Compliance or a previous Notification of Compliance are no longer applicable.

(3) The Notification of Compliance requirements of §63.1207(j) also apply.

[64 FR 53038, Sept. 30, 1999, as amended at 64 FR 63211, Nov. 19, 1999; 65 FR 42301, July 10, 2000; 66 FR 24272, May 14, 2001; 67 FR 6992, Feb. 14, 2002; 70 FR 59552, Oct. 12, 2005; 73 FR 18982, Apr. 8, 2008; 73 FR 64097, Oct. 28, 2008]

[↑ Back to Top](#)

§63.1211 What are the recordkeeping and reporting requirements?

(a) *Summary of reporting requirements.* You must submit the following reports to the Administrator:

Reference	Report
63.10(d)(4)	Compliance progress reports, if required as a condition of an extension of the compliance date granted under §63.6(i).
63.10(d)(5)(i)	Periodic startup, shutdown, and malfunction reports.
63.10(d)(5)(ii)	Immediate startup, shutdown, and malfunction reports.
63.10(e)(3)	Excessive emissions and continuous monitoring system performance report and summary report.
63.1206(c)(2)(ii)(B)	Startup, shutdown, and malfunction plan.
63.1206(c)(3)(vi)	Excessive exceedances reports.
63.1206(c)(4)(iv)	Emergency safety vent opening reports.

(b) *Summary of recordkeeping requirements.* You must retain the following in the operating record:

Reference	Document, Data, or Information
63.1200, 63.10(b) and (c)	General. Information required to document and maintain compliance with the regulations of Subpart EEE, including data recorded by continuous monitoring systems (CMS), and copies of all notifications, reports, plans, and other documents submitted to the Administrator.
63.1204(d)(1)(ii), 63.1220(d)(1)(ii)	Documentation of mode of operation changes for cement kilns with in-line raw mills.
63.1204(d)(2)(ii),	Documentation of compliance with the emission averaging

63.1220(d)(2)(ii)	requirements for cement kilns with in-line raw mills.
63.1204(e)(2)(ii), 63.1220(e)(2)(ii)	Documentation of compliance with the emission averaging requirements for preheater or preheater/precalciner kilns with dual stacks.
63.1206(b)(1)(ii)	If you elect to comply with all applicable requirements and standards promulgated under authority of the Clean Air Act, including Sections 112 and 129, in lieu of the requirements of Subpart EEE when not burning hazardous waste, you must document in the operating record that you are in compliance with those requirements.
63.1206(b)(5)(ii)	Documentation that a change will not adversely affect compliance with the emission standards or operating requirements.
63.1206(b)(11)	Calculation of hazardous waste residence time.
63.1206(c)(2)	Startup, shutdown, and malfunction plan.
63.1206(c)(2)(v)(A)	Documentation of your investigation and evaluation of excessive exceedances during malfunctions.
63.1206(c)(3)(v)	Corrective measures for any automatic waste feed cutoff that results in an exceedance of an emission standard or operating parameter limit.
63.1206(c)(3)(vii)	Documentation and results of the automatic waste feed cutoff operability testing.
63.1206(c)(4)(ii)	Emergency safety vent operating plan.
63.1206(c)(4)(iii)	Corrective measures for any emergency safety vent opening.
63.1206(c)(5)(ii)	Method used for control of combustion system leaks.
63.1206(c)(6)	Operator training and certification program.
63.1206(c)(7)(i)(D)	Operation and maintenance plan.
63.1209(c)(2)	Feedstream analysis plan.
63.1209(k)(6)(iii), 63.1209(k)(7)(ii), 63.1209(k)(9)(ii), 63.1209(o)(4)(iii)	Documentation that a substitute activated carbon, dioxin/furan formation reaction inhibitor, or dry scrubber sorbent will provide the same level of control as the original material.
63.1209(k)(7)(i)(C)	Results of carbon bed performance monitoring.
63.1209(q)	Documentation of changes in modes of operation.
63.1211(c)	Documentation of compliance.

(c) *Documentation of compliance.* (1) By the compliance date, you must develop and include in the operating record a Documentation of Compliance. You are not subject to this requirement, however, if

you submit a Notification of Compliance under §63.1207(j) prior to the compliance date. Upon inclusion of the Documentation of Compliance in the operating record, hazardous waste burning incinerators, cement kilns, and lightweight aggregate kilns regulated under the interim standards of §§63.1203, 63.1204, and 63.1205 are no longer subject to compliance with the previously applicable Notification of Compliance.

(2) The Documentation of Compliance must identify the applicable emission standards under this subpart and the limits on the operating parameters under §63.1209 that will ensure compliance with those emission standards.

(3) You must include a signed and dated certification in the Documentation of Compliance that:

(i) Required CEMs and CMS are installed, calibrated, and continuously operating in compliance with the requirements of this subpart; and

(ii) Based on an engineering evaluation prepared under your direction or supervision in accordance with a system designed to ensure that qualified personnel properly gathered and evaluated the information and supporting documentation, and considering at a minimum the design, operation, and maintenance characteristics of the combustor and emissions control equipment, the types, quantities, and characteristics of feedstreams, and available emissions data:

(A) You are in compliance with the emission standards of this subpart; and

(B) The limits on the operating parameters under §63.1209 ensure compliance with the emission standards of this subpart.

(4) You must comply with the emission standards and operating parameter limits specified in the Documentation of Compliance.

(d) *Data compression.* You may submit a written request to the Administrator for approval to use data compression techniques to record data from CMS, including CEMS, on a frequency less than that required by §63.1209. You must submit the request for review and approval as part of the comprehensive performance test plan.

(1) You must record a data value at least once each ten minutes.

(2) For each CEMS or operating parameter for which you request to use data compression techniques, you must recommend:

(i) A fluctuation limit that defines the maximum permissible deviation of a new data value from a previously generated value without requiring you to revert to recording each one-minute value.

(A) If you exceed a fluctuation limit, you must record each one-minute value for a period of time not less than ten minutes.

(B) If neither the fluctuation limit nor the data compression limit are exceeded during that period of time, you may reinitiate recording data values on a frequency of at least once each ten minutes; and

(ii) A data compression limit defined as the closest level to an operating parameter limit or emission standard at which reduced data recording is allowed.

(A) Within this level and the operating parameter limit or emission standard, you must record each one-minute average.

(B) The data compression limit should reflect a level at which you are unlikely to exceed the specific operating parameter limit or emission standard, considering its averaging period, with the addition of a new one-minute average.

[64 FR 53038, Sept. 30, 1999, as amended at 64 FR 63212, Nov. 19, 1999; 65 FR 42301, July 10, 2000; 66 FR 24272, May 14, 2001; 66 FR 35106, July 3, 2001; 67 FR 6993, Feb. 14, 2002; 70 FR 59554, Oct. 12, 2005]

[↑ Back to Top](#)

OTHER

[↑ Back to Top](#)

§63.1212 What are the other requirements pertaining to the NIC?

(a) *Certification of intent to comply.* The Notice of Intent to Comply (NIC) must contain the following certification signed and dated by a responsible official as defined under §63.2 of this chapter: I certify under penalty of law that I have personally examined and am familiar with the information submitted in this document and all attachments and that, based on my inquiry of those individuals immediately responsible for obtaining the information, I believe that the information is true, accurate, and complete. I am aware that there are significant penalties for submitting false information, including the possibility of fine and imprisonment.

(b) *New units.* Any source that files a RCRA permit application or permit modification request for construction of a hazardous waste combustion unit after October 12, 2005 must:

(1) Prepare a draft NIC pursuant to §63.1210(b) and make it available to the public upon issuance of the notice of public meeting pursuant to §63.1210(c)(3);

(2) Prepare a draft comprehensive performance test plan pursuant to the requirements of §63.1207 and make it available for public review upon issuance of the notice of NIC public meeting;

(3) Provide notice to the public of a pre-application meeting pursuant to §124.31 of this chapter or notice to the public of a permit modification request pursuant to §270.42 of this chapter;

(4) Hold an informal public meeting [pursuant to §63.1210(c)(1) and (c)(2)] no earlier than 30 days following notice of the NIC public meeting and notice of the pre-application meeting or notice of the permit modification request to discuss anticipated activities described in the draft NIC and pre-application or permit modification request for achieving compliance with the emission standards of this subpart; and

(5) Submit a final NIC pursuant to §63.1210(b)(3).

(c) *Information Repository specific to new combustion units.* (1) Any source that files a RCRA permit application or modification request for construction of a new hazardous waste combustion unit after October 12, 2005 may be required to establish an information repository if deemed appropriate.

(2) The Administrator may assess the need, on a case-by-case basis for an information repository. When assessing the need for a repository, the Administrator shall consider the level of public interest, the presence of an existing repository, and any information available via the New Source Review and Title V permit processes. If the Administrator determines a need for a repository, then the Administrator shall notify the facility that it must establish and maintain an information repository.

(3) The information repository shall contain all documents, reports, data, and information deemed necessary by the Administrator. The Administrator shall have the discretion to limit the contents of the repository.

(4) The information repository shall be located and maintained at a site chosen by the source. If the Administrator finds the site unsuitable for the purposes and persons for which it was established, due to problems with location, hours of availability, access, or other relevant considerations, then the Administrator shall specify a more appropriate site.

(5) The Administrator shall require the source to provide a written notice about the information repository to all individuals on the source mailing list.

(6) The source shall be responsible for maintaining and updating the repository with appropriate information throughout a period specified by the Administrator. The Administrator may close the repository at his or her discretion based on the considerations in paragraph (c)(2) of this section.

[70 FR 59555, Oct. 12, 2005, as amended at 73 FR 18982, Apr. 8, 2008]

 [Back to Top](#)

§63.1213 How can the compliance date be extended to install pollution prevention or waste minimization controls?

(a) *Applicability.* You may request from the Administrator or State with an approved Title V program an extension of the compliance date of up to one year. An extension may be granted if you can reasonably document that the installation of pollution prevention or waste minimization measures will significantly reduce the amount and/or toxicity of hazardous wastes entering the feedstream(s) of the hazardous waste combustor(s), and that you could not install the necessary control measures and comply with the emission standards and operating requirements of this subpart by the compliance date.

(b) *Requirements for requesting an extension.* (1) You must make your requests for an (up to) one-year extension in writing in accordance with §63.6(i)(4)(B) and (C). The request must contain the following information:

(i) A description of pollution prevention or waste minimization controls that, when installed, will significantly reduce the amount and/or toxicity of hazardous wastes entering the feedstream(s) of the hazardous waste combustor(s). Pollution prevention or waste minimization measures may include: equipment or technology modifications, reformulation or redesign of products, substitution of raw materials, improvements in work practices, maintenance, training, inventory control, or recycling practices conducted as defined in §261.1(c) of this chapter;

(ii) A description of other pollution controls to be installed that are necessary to comply with the emission standards and operating requirements;

(iii) A reduction goal or estimate of the annual reductions in quantity and/or toxicity of hazardous waste(s) entering combustion feedstream(s) that you will achieve by installing the proposed pollution prevention or waste minimization measures;

(iv) A comparison of reductions in the amounts and/or toxicity of hazardous wastes combusted after installation of pollution prevention or waste minimization measures to the amounts and/or toxicity of hazardous wastes combusted prior to the installation of these measures. If the difference is less than a fifteen percent reduction, include a comparison to pollution prevention and waste minimization reductions recorded during the previous five years;

(v) Reasonable documentation that installation of the pollution prevention or waste minimization changes will not result in a net increase (except for documented increases in production) of hazardous constituents released to the environment through other emissions, wastes or effluents;

(vi) Reasonable documentation that the design and installation of waste minimization and other measures that are necessary for compliance with the emission standards and operating requirements of this subpart cannot otherwise be installed within the three year compliance period, and

(vii) The information required in §63.6(i)(6)(i)(B) through (D).

(2) You may enclose documentation prepared under an existing State-required pollution prevention program that contains the information prescribed in paragraph (b) of this section with a request for extension in lieu of complying with the time extension requirements of that paragraph.

(c) *Approval of request for extension of compliance date.* Based on the information provided in any request made under paragraph (a) of this section, the Administrator or State with an approved title V program may grant an extension of the compliance date of this subpart. The extension will be in writing in accordance with §§63.6(i)(10)(i) through 63.6(i)(10)(v)(A).

[57 FR 61992, Dec. 29, 1992, as amended at 67 FR 6994, Feb. 14, 2002; 67 FR 77691, Dec. 19, 2002]

 [Back to Top](#)

§63.1214 Implementation and enforcement.

(a) This subpart can be implemented and enforced by the U.S. EPA, or a delegated authority such as the applicable State, local, or Tribal agency. If the U.S. EPA Administrator has delegated authority to a State, local, or Tribal agency, then that agency, in addition to the U.S. EPA, has the authority to implement and enforce this subpart. Contact the applicable U.S. EPA Regional Office to find out if this subpart is delegated to a State, local, or Tribal agency.

(b) In delegating implementation and enforcement authority of this subpart to a State, local, or Tribal agency under subpart E of this part, the authorities contained in paragraph (c) of this section are retained by the Administrator of U.S. EPA and cannot be transferred to the State, local, or Tribal agency.

(c) The authorities that cannot be delegated to State, local, or Tribal agencies are as specified in paragraphs (c)(1) through (4) of this section.

(1) Approval of alternatives to requirements in §§63.1200, 63.1203, 63.1204, 63.1205, 63.1206(a), 63.1215, 63.1216, 63.1217, 63.1218, 63.1219, 63.1220, and 63.1221.

(2) Approval of major alternatives to test methods under §§63.7(e)(2)(ii) and (f), 63.1208(b), and 63.1209(a)(1), as defined under §63.90, and as required in this subpart.

(3) Approval of major alternatives to monitoring under §§63.8(f) and 63.1209(a)(5), as defined under §63.90, and as required in this subpart.

(4) Approval of major alternatives to recordkeeping and reporting under §§63.10(f) and 63.1211(a) through (c), as defined under §63.90, and as required in this subpart.

[68 FR 37356, June 23, 2003, as amended at 70 FR 59555, Oct. 12, 2005]

§63.1215 What are the health-based compliance alternatives for total chlorine?

(a) *General—(1) Overview.* You may establish and comply with health-based compliance alternatives for total chlorine under the procedures prescribed in this section for your hazardous waste combustors other than hydrochloric acid production furnaces. You may comply with these health-based compliance alternatives in lieu of the emission standards for total chlorine provided under §§63.1216, 63.1217, 63.1219, 63.1220, and 63.1221. To identify and comply with the limits, you must:

(i) Identify a total chlorine emission concentration (ppmv) expressed as chloride (Cl(-)) equivalent for each on site hazardous waste combustor. You may select total chlorine emission concentrations as you choose to demonstrate eligibility for the risk-based limits under this section, except as provided by paragraph (b)(7) of this section;

(ii) Apportion the total chlorine emission concentration between HCl and Cl₂ according to paragraph (b)(6)(i) of this section, and calculate HCl and Cl₂ emission rates (lb/hr) using the gas flowrate and other parameters from the most recent regulatory compliance test.

(iii) Calculate the annual average HCl-equivalent emission rate as prescribed in paragraph (b)(2) of this section.

(iv) Perform an eligibility demonstration to determine if your HCl-equivalent emission rate meets the national exposure standard and thus is below the annual average HCl-equivalent emission rate limit, as prescribed by paragraph (c) of this section;

(v) Submit your eligibility demonstration for review and approval, as prescribed by paragraph (e) of this section, which must include information to ensure that the 1-hour average HCl-equivalent emission rate limit is not exceeded, as prescribed by paragraph (d) of this section;

(vi) Demonstrate compliance with the annual average HCl-equivalent emission rate limit during the comprehensive performance test, as prescribed by the testing and monitoring requirements under paragraph (e) of this section;

(vii) Comply with compliance monitoring requirements, including establishing feedrate limits on total chlorine and chloride, and operating parameter limits on emission control equipment, as prescribed by paragraph (f) of this section; and

(viii) Comply with the requirements for changes, as prescribed by paragraph (h) of this section.

(2) *Definitions.* In addition to the definitions under §63.1201, the following definitions apply to this section:

1-Hour Average HCl-Equivalent Emission Rate means the HCl-equivalent emission rate (lb/hr) determined by equating the toxicity of chlorine to HCl using aRELS as the health risk metric for acute exposure.

1-Hour Average HCl-Equivalent Emission Rate Limit means the HCl-equivalent emission rate (lb/hr) determined by equating the toxicity of chlorine to HCl using aRELS as the health risk metric for acute exposure and which ensures that maximum 1-hour average ambient concentrations of HCl-equivalents do not exceed a Hazard Index of 1.0, rounded to the nearest tenths decimal place (0.1), at an off-site receptor location.

Acute Reference Exposure Level (aREL) means health thresholds below which there would be no adverse health effects for greater than once in a lifetime exposures of one hour. ARELs are developed by the California Office of Health Hazard Assessment and are available at http://www.oehha.ca.gov/air/acute_rels/acuterel.html.

Annual Average HCl-Equivalent Emission Rate means the HCl-equivalent emission rate (lb/hr) determined by equating the toxicity of chlorine to HCl using RfCs as the health risk metric for long-term exposure.

Annual Average HCl-Equivalent Emission Rate Limit means the HCl-equivalent emission rate (lb/hr) determined by equating the toxicity of chlorine to HCl using RfCs as the health risk metric for long-term exposure and which ensures that maximum annual average ambient concentrations of HCl equivalents do not exceed a Hazard Index of 1.0, rounded to the nearest tenths decimal place (0.1), at an off-site receptor location.

Hazard Index (HI) means the sum of more than one Hazard Quotient for multiple substances and/or multiple exposure pathways. In this section, the Hazard Index is the sum of the Hazard Quotients for HCl and chlorine.

Hazard Quotient (HQ) means the ratio of the predicted media concentration of a pollutant to the media concentration at which no adverse effects are expected. For chronic inhalation exposures, the HQ is calculated under this section as the air concentration divided by the RfC. For acute inhalation exposures, the HQ is calculated under this section as the air concentration divided by the aREL.

Look-up table analysis means a risk screening analysis based on comparing the HCl-equivalent emission rate from the affected source to the appropriate HCl-equivalent emission rate limit specified in Tables 1 through 4 of this section.

Reference Concentration (RfC) means an estimate (with uncertainty spanning perhaps an order of magnitude) of a continuous inhalation exposure to the human population (including sensitive subgroups) that is likely to be without an appreciable risk of deleterious effects during a lifetime. It can be derived from various types of human or animal data, with uncertainty factors generally applied to reflect limitations of the data used.

(b) *HCl-equivalent emission rates.* (1) You must express total chlorine emission rates for each hazardous waste combustor as HCl-equivalent emission rates.

(2) *Annual average rates.* You must calculate annual average toxicity-weighted HCl-equivalent emission rates for each combustor as follows:

$$ER_{LTw} = ER_{HCl} + ER_{Cl_2} \times (RfC_{HCl}/RfC_{Cl_2})$$

Where:

ER_{LTw} is the annual average HCl toxicity-weighted emission rate (HCl-equivalent emission rate) considering long-term exposures, lb/hr

ER_{HCl} is the emission rate of HCl in lbs/hr

ER_{Cl_2} is the emission rate of chlorine in lbs/hr

RfC_{HCl} is the reference concentration of HCl

RfC_{Cl_2} is the reference concentration of chlorine

(3) *1-hour average rates.* You must calculate 1-hour average toxicity-weighted HCl-equivalent emission rates for each combustor as follows:

$$ER_{STW} = ER_{HCl} + ER_{Cl_2} \times (aREL_{HCl}/aREL_{Cl_2})$$

Where:

ER_{STW} is the 1-hour average HCl-toxicity-weighted emission rate (HCl-equivalent emission rate) considering 1-hour (short-term) exposures, lb/hr

ER_{HCl} is the emission rate of HCl in lbs/hr

ER_{Cl_2} is the emission rate of chlorine in lbs/hr

$aREL_{HCl}$ is the aREL for HCl

$aREL_{Cl_2}$ is the aREL for chlorine

(4) You must use the RfC values for hydrogen chloride and chlorine found at <http://epa.gov/ttn/atw/toxsource/summary.html>.

(5) You must use the aREL values for hydrogen chloride and chlorine found at http://www.oehha.ca.gov/air/acute_rels/acutereel.html.

(6) *Cl₂/HCl ratios*—(i) *Ratio for calculating annual average HCl-equivalent emission rates.* (A) To calculate the annual average HCl-equivalent emission rate (lb/hr) for each combustor, you must apportion the total chlorine emission concentration (ppmv chloride (Cl⁻) equivalent) between HCl and chlorine according to the historical average Cl₂/HCl volumetric ratio for all regulatory compliance tests.

(B) You must calculate HCl and Cl₂ emission rates (lb/hr) using the apportioned emission concentrations and the gas flowrate and other parameters from the most recent regulatory compliance test.

(C) You must calculate the annual average HCl-equivalent emission rate using these HCl and Cl₂ emission rates and the equation in paragraph (b)(2) of this section.

(ii) *Ratio for calculating 1-hour average HCl-equivalent emission rates.* (A) To calculate the 1-hour average HCl-equivalent emission rate for each combustor as a criterion for you to determine under paragraph (d) of this section if an hourly rolling average feedrate limit on total chlorine and chloride may be waived, you must apportion the total chlorine emission concentration (ppmv chloride (Cl⁻) equivalent) between HCl and chlorine according to the historical highest Cl₂/HCl volumetric ratio for all regulatory compliance tests.

(B) You must calculate HCl and Cl₂ emission rates (lb/hr) using the apportioned emission concentrations and the gas flowrate and other parameters from the most recent regulatory compliance test.

(C) You must calculate the 1-hour average HCl-equivalent emission rate using these HCl and Cl₂ emission rates and the equation in paragraph (b)(3) of this section.

(iii) *Ratios for new sources.* (A) You must use engineering information to estimate the Cl₂/HCl volumetric ratio for a new source for the initial eligibility demonstration.

(B) You must use the Cl₂/HCl volumetric ratio demonstrated during the initial comprehensive performance test to demonstrate in the Notification of Compliance that your HCl-equivalent emission rate does not exceed your HCl-equivalent emission rate limit.

(C) When approving the test plan for the initial comprehensive performance test, the permitting authority will establish a periodic testing requirement, such as every 3 months for 1 year, to establish a record of representative Cl₂/HCl volumetric ratios.

(1) You must revise your HCl-equivalent emission rates and HCl-equivalent emission rate limits after each such test using the procedures prescribed in paragraphs (b)(6)(i) and (ii) of this section.

(2) If you no longer are eligible for the health-based compliance alternative, you must notify the permitting authority immediately and either:

(i) Submit a revised eligibility demonstration requesting lower HCl-equivalent emission rate limits, establishing lower HCl-equivalent emission rates, and establishing by downward extrapolation lower feedrate limits for total chlorine and chloride; or

(ii) Request a compliance schedule of up to three years to demonstrate compliance with the emission standards under §§63.1216, 63.1217, 63.1219, 63.1220, and 63.1221.

(iv) *Unrepresentative or inadequate historical Cl₂/HCl volumetric ratios.* (A) If you believe that the Cl₂/HCl volumetric ratio for one or more historical regulatory compliance tests is not representative of the current ratio, you may request that the permitting authority allow you to screen those ratios from the analysis of historical ratios.

(B) If the permitting authority believes that too few historical ratios are available to calculate a representative average ratio or establish a maximum ratio, the permitting authority may require you to conduct periodic testing to establish representative ratios.

(v) *Updating Cl₂/HCl ratios.* You must include the Cl₂/HCl volumetric ratio demonstrated during each performance test in your data base of historical Cl₂/HCl ratios to update the ratios you establish under paragraphs (b)(6)(i) and (ii) of this section for subsequent calculations of the annual average and 1-hour average HCl-equivalent emission rates.

(7) *Emission rates are capped.* The hydrogen chloride and chlorine emission rates you use to calculate the HCl-equivalent emission rate limit for incinerators, cement kilns, and lightweight aggregate kilns must not result in total chlorine emission concentrations exceeding:

(i) For incinerators that were existing sources on April 19, 1996: 77 parts per million by volume, combined emissions, expressed as chloride (Cl⁻) equivalent, dry basis and corrected to 7 percent oxygen;

(ii) For incinerators that are new or reconstructed sources after April 19, 1996: 21 parts per million by volume, combined emissions, expressed as chloride (Cl⁻) equivalent, dry basis and corrected to 7 percent oxygen;

(iii) For cement kilns that were existing sources on April 19, 1996: 130 parts per million by volume, combined emissions, expressed as chloride (Cl⁻) equivalent, dry basis and corrected to 7 percent oxygen;

(iv) For cement kilns that are new or reconstructed sources after April 19, 1996: 86 parts per million by volume, combined emissions, expressed as chloride (Cl⁻) equivalent, dry basis and corrected to 7 percent oxygen;

(v) For lightweight aggregate kilns that were existing sources on April 19, 1996: 600 parts per million by volume, combined emissions, expressed as chloride (Cl⁻) equivalent, dry basis and corrected to 7 percent oxygen;

(vi) For lightweight aggregate kilns that are new or reconstructed sources after April 19, 1996: 600 parts per million by volume, combined emissions, expressed as chloride (Cl⁻) equivalent, dry basis and corrected to 7 percent oxygen.

(c) *Eligibility demonstration*—(1) *General.* (i) You must perform an eligibility demonstration to determine whether the total chlorine emission rates you select for each on-site hazardous waste combustor meet the national exposure standards using either a look-up table analysis prescribed by paragraph (c)(3) of this section, or a site-specific compliance demonstration prescribed by paragraph (c)(4) of this section.

(ii) You must also determine in your eligibility demonstration whether each combustor may exceed the 1-hour HCl-equivalent emission rate limit absent an hourly rolling average limit on the feedrate of total chlorine and chloride, as provided by paragraph (d) of this section.

(2) *Definition of eligibility.* (i) Eligibility for the risk-based total chlorine standard is determined by comparing the annual average HCl-equivalent emission rate for the total chlorine emission rate you select for each combustor to the annual average HCl-equivalent emission rate limit.

(ii) The annual average HCl-equivalent emission rate limit ensures that the Hazard Index for chronic exposure from HCl and chlorine emissions from all on-site hazardous waste combustors is less than or equal to 1.0, rounded to the nearest tenths decimal place (0.1), for the actual individual most exposed to the facility's emissions, considering off-site locations where people reside and where people congregate for work, school, or recreation.

(iii) Your facility is eligible for the health-based compliance alternative for total chlorine if either:

(A) The annual average HCl-equivalent emission rate for each on-site hazardous waste combustor is below the appropriate value in the look-up table determined under paragraph (c)(3) of this section; or

(B) The annual average HCl-equivalent emission rate for each on-site hazardous waste combustor is below the annual average HCl-equivalent emission rate limit you calculate based on a site-specific compliance demonstration under paragraph (c)(4) of this section.

(3) *Look-up table analysis.* Look-up tables for the eligibility demonstration are provided as Tables 1 and 2 to this section.

(i) Table 1 presents annual average HCl-equivalent emission rate limits for sources located in flat terrain. For purposes of this analysis, flat terrain is terrain that rises to a level not exceeding one half the stack height within a distance of 50 stack heights.

(ii) Table 2 presents annual average HCl-equivalent emission rate limits for sources located in simple elevated terrain. For purposes of this analysis, simple elevated terrain is terrain that rises to a level exceeding one half the stack height, but that does not exceed the stack height, within a distance of 50 stack heights.

(iii) To determine the annual average HCl-equivalent emission rate limit for a source from the look-up table, you must use the stack height and stack diameter for your hazardous waste combustors and the distance between the stack and the property boundary.

(iv) If any of these values for stack height, stack diameter, and distance to nearest property boundary do not match the exact values in the look-up table, you must use the next lowest table value.

(v) *Adjusted HCl-equivalent emission rate limit for multiple on-site combustors.* (A) If you have more than one hazardous waste combustor on site, the sum across all hazardous waste combustors of the ratio of the adjusted HCl-equivalent emission rate limit to the HCl-equivalent emission rate limit provided by Tables 1 or 2 cannot exceed 1.0, according to the following equation:

$$\sum_{i=1}^n \frac{\text{HCl-Equivalent Emission Rate Limit Adjusted}_i}{\text{HCl-Equivalent Emission Rate Limit Table}_i} \leq 1.0$$

[View or download PDF](#)

Where:

i = number of on-site hazardous waste combustors;

HCl-Equivalent Emission Rate Limit Adjusted, means the apportioned, allowable HCl-equivalent emission rate limit for combustor i , and

HCl-Equivalent Emission Rate Limit Table, means the HCl-equivalent emission rate limit from Table 1 or 2 to §63.1215 for combustor i .

(B) The adjusted HCl-equivalent emission rate limit becomes the HCl-equivalent emission rate limit.

(4) *Site-specific compliance demonstration.* (i) You may use any scientifically-accepted peer-reviewed risk assessment methodology for your site-specific compliance demonstration to calculate an annual average HCl-equivalent emission rate limit for each on-site hazardous waste combustor. An example of one approach for performing the demonstration for air toxics can be found in the EPA's "Air Toxics Risk Assessment Reference Library, Volume 2, Site-Specific Risk Assessment Technical Resource Document," which may be obtained through the EPA's Air Toxics Web site at http://www.epa.gov/ttn/fera/risk_atra_main.html.

(ii) The annual average HCl-equivalent emission rate limit is the HCl-equivalent emission rate that ensures that the Hazard Index associated with maximum annual average exposures is not greater than 1.0 rounded to the nearest tenths decimal place (0.1).

(iii) To determine the annual average HCl-equivalent emission rate limit, your site-specific compliance demonstration must, at a minimum:

(A) Estimate long-term inhalation exposures through the estimation of annual or multi-year average ambient concentrations;

(B) Estimate the inhalation exposure for the actual individual most exposed to the facility's emissions from hazardous waste combustors, considering off-site locations where people reside and where people congregate for work, school, or recreation;

(C) Use site-specific, quality-assured data wherever possible;

(D) Use health-protective default assumptions wherever site-specific data are not available, and:

(E) Contain adequate documentation of the data and methods used for the assessment so that it is transparent and can be reproduced by an experienced risk assessor and emissions measurement expert.

(iv) Your site-specific compliance demonstration need not:

(A) Assume any attenuation of exposure concentrations due to the penetration of outdoor pollutants into indoor exposure areas;

(B) Assume any reaction or deposition of the emitted pollutants during transport from the emission point to the point of exposure.

(d) *Assurance that the 1-hour HCl-equivalent emission rate limit will not be exceeded.* To ensure that the 1-hour HCl-equivalent emission rate limit will not be exceeded when complying with the annual average HCl-equivalent emission rate limit, you must establish a 1-hour average HCl-equivalent emission rate for each combustor, establish a 1-hour average HCl-equivalent emission rate limit for each combustor, and consider site-specific factors including prescribed criteria to determine if the 1-hour average HCl-equivalent emission rate limit may be exceeded absent an hourly rolling average limit on the feedrate of total chlorine and chloride. If the 1-hour average HCl-equivalent emission rate limit may be exceeded, you must establish an hourly rolling average feedrate limit on total chlorine as provided by paragraph (f)(3) of this section.

(1) *1-hour average HCl-equivalent emission rate.* You must calculate the 1-hour average HCl-equivalent emission rate from the total chlorine emission concentration you select for each source as prescribed in paragraph (b)(6)(ii)(C) of this section.

(2) *1-hour average HCl-equivalent emission rate limit.* You must establish the 1-hour average HCl-equivalent emission rate limit for each affected source using either a look-up table analysis or site-specific analysis:

(i) *Look-up table analysis.* Look-up tables are provided for 1-hour average HCl-equivalent emission rate limits as Table 3 and Table 4 to this section. Table 3 provides limits for facilities located in flat terrain. Table 4 provides limits for facilities located in simple elevated terrain. You must use the Tables to establish 1-hour average HCl-equivalent emission rate limits as prescribed in paragraphs (c)(3)(iii) through (c)(3)(v) of this section for annual average HCl-equivalent emission rate limits.

(ii) *Site-specific analysis.* The 1-hour average HCl-equivalent emission rate limit is the HCl-equivalent emission rate that ensures that the Hazard Index associated with maximum 1-hour average exposures is not greater than 1.0 rounded to the nearest tenths decimal place (0.1). You must follow the risk assessment procedures under paragraph (c)(4) of this section to estimate short-term inhalation exposures through the estimation of maximum 1-hour average ambient concentrations.

(3) *Criteria for determining whether the 1-hour HCl-equivalent emission rate may be exceeded absent an hourly rolling average limit on the feedrate of total chlorine and chloride.* An hourly rolling average feedrate limit on total chlorine and chloride is waived if you determine considering the criteria listed below that the long-term feedrate limit (and averaging period) established under paragraph (c)(4)(i) of this section will also ensure that the 1-hour average HCl-equivalent emission rate will not exceed the 1-hour average HCl-equivalent emission rate limit you calculate for each combustor.

(i) The ratio of the 1-hour average HCl-equivalent emission rate based on the total chlorine emission rate you select for each hazardous waste combustor to the 1-hour average HCl-equivalent emission rate limit for the combustor; and

(ii) The potential for the source to vary total chlorine and chloride feedrates substantially over the averaging period for the feedrate limit established under paragraph (c)(4)(i) of this section.

(e) *Review and approval of eligibility demonstrations—(1) Content of the eligibility demonstration—*
(i) *General.* The eligibility demonstration must include the following information, at a minimum:

(A) Identification of each hazardous waste combustor combustion gas emission point (e.g., generally, the flue gas stack);

(B) The maximum and average capacity at which each combustor will operate, and the maximum rated capacity for each combustor, using the metric of stack gas volume (under both actual and standard conditions) emitted per unit of time, as well as any other metric that is appropriate for the combustor (e.g., million Btu/hr heat input for boilers; tons of dry raw material feed/hour for cement kilns);

(C) Stack parameters for each combustor, including, but not limited to stack height, stack diameter, stack gas temperature, and stack gas exit velocity;

(D) Plot plan showing all stack emission points, nearby residences and property boundary line;

(E) Identification of any stack gas control devices used to reduce emissions from each combustor;

(F) Identification of the RfC values used to calculate annual average HCl-equivalent emission rates and the aREL values used to calculate 1-hour average HCl-equivalent emission rates;

(G) Calculations used to determine the annual average and 1-hour average HCl-equivalent emission rates and rate limits, including calculation of the Cl_2/HCl ratios as prescribed by paragraph (b)(6) of this section;

(ii) *Additional content to implement the annual average HCl-equivalent emission rate limit.* You must include the following in your eligibility demonstration to implement the annual average HCl-equivalent emission rate limit:

(A) For incinerators, cement kilns, and lightweight aggregate kilns, calculations to confirm that the annual average HCl-equivalent emission rate that you calculate from the total chlorine emission rate you select for each combustor does not exceed the limits provided by paragraph (b)(7) of this section;

(B) Comparison of the annual average HCl-equivalent emission rate limit for each combustor to the annual average HCl-equivalent emission rate for the total chlorine emission rate you select for each combustor;

(C) The annual average HCl-equivalent emission rate limit for each hazardous waste combustor, and the limits on operating parameters required under paragraph (g)(1) of this section;

(D) Determination of the long-term chlorine feedrate limit, including the total chlorine system removal efficiency for sources that establish an (up to) annual rolling average feedrate limit under paragraph (g)(2)(ii) of this section;

(iii) *Additional content to implement the 1-hour average HCl-equivalent emission rate limit.* You must include the following in your eligibility demonstration to implement the 1-hour average HCl-equivalent emission rate limit:

(A) Determination of whether the combustor may exceed the 1-hour HCl-equivalent emission rate limit absent an hourly rolling average chlorine feedrate limit, including:

(1) Determination of the 1-hour average HCl-equivalent emission rate from the total chlorine emission rate you select for the combustor;

(2) Determination of the 1-hour average HCl-equivalent emission rate limit using either look-up Tables 3 and 4 to this section or site-specific risk analysis;

(3) Determination of the ratio of the 1-hour average HCl-equivalent emission rate to the 1-hour average HCl-equivalent emission rate limit for the combustor; and

(4) The potential for the source to vary total chlorine and chloride feedrates substantially over the averaging period for the long-term feedrate limit established under paragraphs (g)(2)(i) and (g)(2)(ii) of this section; and

(B) Determination of the hourly rolling average chlorine feedrate limit, including the total chlorine system removal efficiency.

(iv) *Additional content of a look-up table demonstration.* If you use the look-up table analysis to establish HCl-equivalent emission rate limits, your eligibility demonstration must also contain, at a minimum, the following:

(A) Documentation that the facility is located in either flat or simple elevated terrain; and

(B) For facilities with more than one on-site hazardous waste combustor, documentation that the sum of the ratios for all such combustors of the HCl-equivalent emission rate to the HCl-equivalent emission rate limit does not exceed 1.0.

(v) *Additional content of a site-specific compliance demonstration.* If you use a site-specific compliance demonstration, your eligibility demonstration must also contain, at a minimum, the following information to support your determination of the annual average HCl-equivalent emission rate limit for each combustor:

(A) Identification of the risk assessment methodology used;

(B) Documentation of the fate and transport model used;

(C) Documentation of the fate and transport model inputs, including the stack parameters listed in paragraph (d)(1)(i)(C) of this section converted to the dimensions required for the model;

(D) As applicable:

(1) Meteorological data;

(2) Building, land use, and terrain data;

(3) Receptor locations and population data, including areas where people congregate for work, school, or recreation; and

(4) Other facility-specific parameters input into the model;

(E) Documentation of the fate and transport model outputs; and

(F) Documentation of any exposure assessment and risk characterization calculations.

(2) *Review and approval*—(i) *Existing sources*. (A) If you operate an existing source, you must submit the eligibility demonstration to your permitting authority for review and approval not later than 12 months prior to the compliance date. You must also submit a separate copy of the eligibility demonstration to: U.S. EPA, Risk and Exposure Assessment Group, Emission Standards Division (C404-01), Attn: Group Leader, Research Triangle Park, North Carolina 27711, electronic mail address *REAG@epa.gov*.

(B) Your permitting authority should notify you of approval or intent to disapprove your eligibility demonstration within 6 months after receipt of the original demonstration, and within 3 months after receipt of any supplemental information that you submit. A notice of intent to disapprove your eligibility demonstration, whether before or after the compliance date, will identify incomplete or inaccurate information or noncompliance with prescribed procedures and specify how much time you will have to submit additional information or to achieve the MACT standards for total chlorine under §§63.1216, 63.1217, 63.1219, 63.1220, and 63.1221. If your eligibility demonstration is disapproved, the permitting authority may extend the compliance date of the total chlorine standards up to one year to allow you to make changes to the design or operation of the combustor or related systems as quickly as practicable to enable you to achieve compliance with the MACT total chlorine standards.

(C) If your permitting authority has not approved your eligibility demonstration by the compliance date, and has not issued a notice of intent to disapprove your demonstration, you may begin complying, on the compliance date, with the HCl-equivalent emission rate limits you present in your eligibility demonstration provided that you have made a good faith effort to provide complete and accurate information and to respond to any requests for additional information in a timely manner. If the permitting authority believes that you have not made a good faith effort to provide complete and accurate information or to respond to any requests for additional information, however, the authority may notify you in writing by the compliance date that you have not met the conditions for complying with the health-based compliance alternative without prior approval. Such notice will explain the basis for concluding that you have not made a good faith effort to comply with the health-based compliance alternative by the compliance date.

(D) If your permitting authority issues a notice of intent to disapprove your eligibility demonstration after the compliance date, the authority will identify the basis for that notice and specify how much time you will have to submit additional information or to comply with the MACT standards for total chlorine under §§63.1216, 63.1217, 63.1219, 63.1220, and 63.1221. The permitting authority may extend the compliance date of the total chlorine standards up to one-year to allow you to make changes to the design or operation of the combustor or related systems as quickly as practicable to enable you to achieve compliance with the MACT standards for total chlorine.

(ii) *New or reconstructed sources*—(A) *General*. The procedures for review and approval of eligibility demonstrations applicable to existing sources under paragraph (e)(2)(i) of this section also apply to new or reconstructed sources, except that the date you must submit the eligibility demonstration is as prescribed in this paragraph (e)(2)(ii).

(B) If you operate a new or reconstructed source that starts up before April 12, 2007, or a solid fuel boiler or liquid fuel boiler that is an area source that increases its emissions or its potential to emit such that it becomes a major source of HAP before April 12, 2007, you must either:

(1) Comply with the final total chlorine emission standards under §§63.1216, 63.1217, 63.1219, 63.1220, and 63.1221, by October 12, 2005, or upon startup, whichever is later, except for a standard that is more stringent than the standard proposed on April 20, 2004 for your source. If a final standard is more stringent than the proposed standard, you may comply with the proposed standard until October 14, 2008, after which you must comply with the final standard; or

(2) Submit an eligibility demonstration for review and approval under this section by April 12, 2006, and comply with the HCl-equivalent emission rate limits and operating requirements you establish in the eligibility demonstration.

(C) If you operate a new or reconstructed source that starts up on or after April 12, 2007, or a solid fuel boiler or liquid fuel boiler that is an area source that increases its emissions or its potential to emit such that it becomes a major source of HAP on or after April 12, 2007, you must either:

(1) Comply with the final total chlorine emission standards under §§63.1216, 63.1217, 63.1219, 63.1220, and 63.1221 upon startup. If the final standard is more stringent than the standard proposed for your source on April 20, 2004, however, and if you start operations before October 14, 2008, you may comply with the proposed standard until October 14, 2008, after which you must comply with the final standard; or

(2) Submit an eligibility demonstration for review and approval under this section 12 months prior to startup.

(3) The operating requirements in the eligibility demonstration are applicable requirements for purposes of parts 70 and 71 of this chapter and will be incorporated in the title V permit.

(f) *Testing requirements*—(1) *General*. You must comply with the requirements for comprehensive performance testing under §63.1207.

(2) *System removal efficiency*. (i) You must calculate the total chlorine removal efficiency of the combustor during each run of the comprehensive performance test.

(ii) You must calculate the average system removal efficiency as the average of the test run averages.

(iii) If your source does not control emissions of total chlorine, you must assume zero system removal efficiency.

(3) *Annual average HCl-equivalent emission rate limit*. If emissions during the comprehensive performance test exceed the annual average HCl-equivalent emission rate limit, eligibility for emission limits under this section is not affected. This emission rate limit is an annual average limit even though compliance is based on a 12-hour or (up to) an annual rolling average feedrate limit on total chlorine and chloride because the feedrate limit is also used for compliance assurance for the semivolatile metal emission standard

(4) *1-hour average HCl-equivalent emission rate limit*. Total chlorine emissions during each run of the comprehensive performance test cannot exceed the 1-hour average HCl-equivalent emission rate limit.

(5) *Test methods*. (i) If you operate a cement kiln or a combustor equipped with a dry acid gas scrubber, you must use EPA Method 320/321 or ASTM D 6735-01, or an equivalent method, to measure hydrogen chloride, and the back-half (caustic impingers) of Method 26/26A, or an equivalent method, to measure chlorine gas.

(ii) *Bromine and sulfur considerations*. If you operate an incinerator, boiler, or lightweight aggregate kiln and your feedstreams contain bromine or sulfur during the comprehensive performance test at levels specified under paragraph (e)(2)(ii)(B) of this section, you must use EPA Method 320/321 or ASTM D 6735-01, or an equivalent method, to measure hydrogen chloride, and Method 26/26A, or an equivalent method, to measure chlorine and hydrogen chloride, and determine your chlorine emissions as follows:

(A) You must determine your chlorine emissions to be the higher of the value measured by Method 26/26A as provided in appendix A-8, part 60 of this chapter, or an equivalent method, or the value calculated by the difference between the combined hydrogen chloride and chlorine levels measured by Method 26/26A as provided in appendix A-8, part 60 of this chapter, or an equivalent method, and the hydrogen chloride measurement from EPA Method 320/321 as provided in appendix A, part 63 of this chapter, or ASTM D 6735-01 as described under §63.1208(b)(5)(i)(C), or an equivalent method.

(B) The procedures under paragraph (f)(2)(ii) of this section for determining hydrogen chloride and chlorine emissions apply if you feed bromine or sulfur during the performance test at the levels specified in this paragraph (f)(5)(ii)(B):

(1) If the bromine/chlorine ratio in feedstreams is greater than 5 percent by mass; or

(2) If the sulfur/chlorine ratio in feedstreams is greater than 50 percent by mass.

(g) *Monitoring requirements*—(1) *General*. You must establish and comply with limits on the same operating parameters that apply to sources complying with the MACT standard for total chlorine under §63.1209(o), except that feedrate limits on total chlorine and chloride must be established according to paragraphs (g)(2) and (g)(3) of this section:

(2) *Feedrate limit to ensure compliance with the annual average HCl-equivalent emission rate limit*. (i) For sources subject to the feedrate limit for total chlorine and chloride under §63.1209(n)(4) to ensure compliance with the semivolatile metals standard:

(A) The feedrate limit (and averaging period) for total chlorine and chloride to ensure compliance with the annual average HCl-equivalent emission rate limit is the same as required by §63.1209(n)(4), except as provided by paragraph (g)(2)(i)(B) of this section.

(B) The numerical value of the total chlorine and chloride feedrate limit (i.e., not considering the averaging period) you establish under §63.1209(n)(4) must not exceed the value you calculate as the annual average HCl-equivalent emission rate limit (lb/hr) divided by $[1 - \text{system removal efficiency}]$, where the system removal efficiency is calculated as prescribed by paragraph (f)(2) of this section.

(ii) For sources exempt from the feedrate limit for total chlorine and chloride under §63.1209(n)(4) because they comply with §63.1207(m)(2), the feedrate limit for total chlorine and chloride to ensure compliance with the annual average HCl-equivalent emission rate must be established as follows:

(A) You must establish an average period for the feedrate limit that does not exceed an annual rolling average;

(B) The numerical value of the total chlorine and chloride feedrate limit (i.e., not considering the averaging period) must not exceed the value you calculate as the annual average HCl-equivalent emission rate limit (lb/hr) divided by $[1 - \text{system removal efficiency}]$, where the system removal efficiency is calculated as prescribed by paragraph (f)(2) of this section.

(C) You must calculate the initial rolling average as though you had selected a 12-hour rolling average, as provided by paragraph (b)(5)(i) of this section. You must calculate rolling averages thereafter as the average of the available one-minute values until enough one-minute values are available to calculate the rolling average period you select. At that time and thereafter, you update the rolling average feedrate each hour with a 60-minute average feedrate.

(3) *Feedrate limit to ensure compliance with the 1-hour average HCl-equivalent emission rate limit*. (i) You must establish an hourly rolling average feedrate limit on total chlorine and chloride to ensure

compliance with the 1-hour average HCl-equivalent emission rate limit unless you determine that the hourly rolling average feedrate limit is waived under paragraph (d) of this section.

(ii) You must calculate the hourly rolling average feedrate limit for total chlorine and chloride as the 1-hour average HCl-equivalent emission rate limit (lb/hr) divided by $[1 - \text{system removal efficiency}]$, where the system removal efficiency is calculated as prescribed by paragraph (f)(2)(ii) of this section.

(h) *Changes*—(1) *Changes over which you have control*—(i) *Changes that would affect the HCl-equivalent emission rate limit.* (A) If you plan to change the design, operation, or maintenance of the facility in a manner than would decrease the annual average or 1-hour average HCl-equivalent emission rate limit, you must submit to the permitting authority prior to the change a revised eligibility demonstration documenting the lower emission rate limits and calculations of reduced total chlorine and chloride feedrate limits.

(B) If you plan to change the design, operation, or maintenance of the facility in a manner than would increase the annual average or 1-hour average HCl-equivalent emission rate limit, and you elect to increase your total chlorine and chloride feedrate limits. You must also submit to the permitting authority prior to the change a revised eligibility demonstration documenting the increased emission rate limits and calculations of the increased feedrate limits prior to the change.

(ii) *Changes that could affect system removal efficiency.* (A) If you plan to change the design, operation, or maintenance of the combustor in a manner than could decrease the system removal efficiency, you are subject to the requirements of §63.1206(b)(5) for conducting a performance test to reestablish the combustor's system removal efficiency and you must submit a revised eligibility demonstration documenting the lower system removal efficiency and the reduced feedrate limits on total chlorine and chloride.

(B) If you plan to change the design, operation, or maintenance of the combustor in a manner than could increase the system removal efficiency, and you elect to document the increased system removal efficiency to establish higher feedrate limits on total chlorine and chloride, you are subject to the requirements of §63.1206(b)(5) for conducting a performance test to reestablish the combustor's system removal efficiency. You must also submit to the permitting authority a revised eligibility demonstration documenting the higher system removal efficiency and the increased feedrate limits on total chlorine and chloride.

(2) *Changes over which you do not have control that may decrease the HCl-equivalent emission rate limits.* These requirements apply if you use a site-specific risk assessment under paragraph (c)(4) of this section to demonstrate eligibility for the health-based limits.

(i) *Proactive review.* You must submit for review and approval with each comprehensive performance test plan either a certification that the information used in your eligibility demonstration has not changed in a manner that would decrease the annual average or 1-hour average HCl-equivalent emission rate limit, or a revised eligibility demonstration.

(ii) *Reactive review.* If in the interim between your comprehensive performance tests you have reason to know of changes that would decrease the annual average or 1-hour average HCl-equivalent emission rate limit, you must submit a revised eligibility demonstration as soon as practicable but not more frequently than annually.

(iii) *Compliance schedule.* If you determine that you cannot demonstrate compliance with a lower annual average HCl-equivalent emission rate limit during the comprehensive performance test because you need additional time to complete changes to the design or operation of the source, you may request that the permitting authority grant you additional time to make those changes as quickly as practicable.

Table 1 of §63.1215: Annual Average HCl-Equivalent Emission Rate Limits (lb/hr)—Flat Terrain

		Distance to property boundary (m)														
		35	50	70	100	200	300	500	700	1000	2000	3000	5000			
Stack Diameter = 0.3 m																
Stack Height (m)	5	3.7E+01	4.0E+01	7.3E+01	0.1E+01	1.6E+00	2.3E+00	4.1E+00	5.7E+00	0.1E+00	1.0E+01	1.6E+01	2.8E+01			
	10	1.0E+00	1.0E+00	1.1E+00	1.0E+00	2.1E+00	2.7E+00	4.8E+00	5.7E+00	0.5E+00	1.1E+01	1.8E+01	3.2E+01			
	20	2.3E+00	2.9E+00	2.3E+00	2.3E+00	2.7E+00	3.7E+00	5.6E+00	7.4E+00	1.0E+01	1.0E+01	2.5E+01	5.2E+01			
	30	4.1E+00	4.1E+00	4.1E+00	4.2E+00	4.7E+00	6.0E+00	9.5E+00	1.2E+01	1.8E+01	3.1E+01	4.8E+01	7.6E+01			
	50	1.2E+01	1.2E+01	1.2E+01	1.2E+01	1.3E+01	1.5E+01	2.0E+01	2.8E+01	3.8E+01	7.1E+01	1.0E+02	1.6E+02			
Stack Diameter = 0.5 m																
Stack Height (m)	5	6.0E+01	6.3E+01	1.4E+02	1.8E+00	3.0E+00	4.4E+00	7.2E+00	9.2E+00	1.3E+01	1.5E+01	2.0E+01	3.4E+01			
	10	1.4E+00	1.4E+00	1.6E+00	2.1E+00	3.9E+00	5.4E+00	8.3E+00	1.2E+01	1.3E+01	1.7E+01	2.2E+01	3.8E+01			
	20	3.7E+00	3.7E+00	3.7E+00	3.9E+00	4.9E+00	6.5E+00	9.5E+00	1.2E+01	1.3E+01	1.7E+01	2.2E+01	3.8E+01			
	30	6.5E+00	6.5E+00	6.5E+00	6.5E+00	6.7E+00	7.9E+00	1.0E+01	1.4E+01	1.9E+01	3.4E+01	5.1E+01	8.1E+01			
	50	1.4E+01	1.4E+01	1.4E+01	1.4E+01	1.4E+01	1.5E+01	2.1E+01	2.8E+01	3.8E+01	7.2E+01	1.0E+02	1.6E+02			
Stack Diameter = 1.0 m																
Stack Height (m)	10	3.2E+00	3.8E+00	4.0E+00	5.4E+00	9.6E+00	1.3E+01	1.8E+01	2.3E+01	2.8E+01	4.5E+01	6.3E+01	9.5E+01			
	20	5.9E+00	5.9E+00	5.9E+00	6.1E+00	9.6E+00	1.3E+01	1.8E+01	2.3E+01	2.8E+01	4.5E+01	6.3E+01	9.5E+01			
	30	1.0E+01	1.0E+01	1.0E+01	1.0E+01	1.2E+01	1.3E+01	1.8E+01	2.3E+01	2.8E+01	4.5E+01	6.3E+01	9.5E+01			
	50	1.8E+01	1.8E+01	1.8E+01	1.8E+01	1.8E+01	1.8E+01	2.3E+01	3.1E+01	4.2E+01	7.7E+01	1.1E+02	1.7E+02			
	70	7.4E+01	7.4E+01	7.4E+01	7.4E+01	7.4E+01	7.4E+01	8.0E+01	1.0E+02	1.4E+02	2.1E+02	2.7E+02	4.2E+02			
Stack Diameter = 1.5 m																
Stack Height (m)	10	4.1E+00	5.2E+00	6.4E+00	7.9E+00	1.3E+01	2.1E+01	2.7E+01	3.6E+01	4.8E+01	7.6E+01	9.1E+01	1.1E+02			
	20	7.0E+00	7.0E+00	7.0E+00	7.0E+00	7.0E+00	7.0E+00	7.0E+00	7.0E+00	7.0E+00	7.0E+00	7.0E+00	7.0E+00			
	30	1.3E+01	1.3E+01	1.3E+01	1.3E+01	1.3E+01	1.3E+01	1.3E+01	1.3E+01	1.3E+01	1.3E+01	1.3E+01	1.3E+01			
	50	2.3E+01	2.3E+01	2.3E+01	2.3E+01	2.3E+01	2.3E+01	2.3E+01	2.3E+01	2.3E+01	2.3E+01	2.3E+01	2.3E+01			
	70	1.0E+02	1.0E+02	1.0E+02	1.0E+02	1.0E+02	1.0E+02	1.1E+02	1.4E+02	1.8E+02	3.0E+02	4.0E+02	5.9E+02			
Stack Diameter = 2.0 m																
Stack Height (m)	10	5.0E+00	6.3E+00	7.7E+00	9.6E+00	1.7E+01	2.8E+01	3.3E+01	4.4E+01	5.9E+01	1.0E+02	1.4E+02	1.8E+02			
	20	9.3E+00	9.3E+00	9.4E+00	1.0E+01	1.7E+01	2.8E+01	3.3E+01	4.4E+01	5.9E+01	1.0E+02	1.4E+02	1.8E+02			
	30	1.6E+01	1.6E+01	1.6E+01	1.6E+01	1.6E+01	1.6E+01	1.6E+01	1.6E+01	1.6E+01	1.6E+01	1.6E+01	1.6E+01			
	50	2.9E+01	2.9E+01	2.9E+01	2.9E+01	2.9E+01	2.9E+01	2.9E+01	2.9E+01	2.9E+01	2.9E+01	2.9E+01	2.9E+01			
	70	1.4E+02	1.4E+02	1.4E+02	1.4E+02	1.4E+02	1.4E+02	1.4E+02	1.4E+02	1.4E+02	1.4E+02	1.4E+02	1.4E+02			
	100	3.0E+02	3.0E+02	3.0E+02	3.0E+02	3.0E+02	3.0E+02	3.0E+02	3.0E+02	3.0E+02	3.0E+02	3.0E+02	3.0E+02			
Stack Diameter = 3.0 m																
Stack Height (m)	10	6.9E+00	8.6E+00	1.0E+01	1.2E+01	2.2E+01	3.4E+01	4.0E+01	5.4E+01	7.1E+01	1.3E+02	1.8E+02	2.3E+02			
	20	1.0E+01	1.0E+01	1.0E+01	1.0E+01	1.0E+01	1.0E+01	1.0E+01	1.0E+01	1.0E+01	1.0E+01	1.0E+01	1.0E+01			
	30	2.0E+01	2.0E+01	2.0E+01	2.0E+01	2.0E+01	2.0E+01	2.0E+01	2.0E+01	2.0E+01	2.0E+01	2.0E+01	2.0E+01			
	50	4.2E+01	4.2E+01	4.2E+01	4.2E+01	4.2E+01	4.2E+01	4.2E+01	4.2E+01	4.2E+01	4.2E+01	4.2E+01	4.2E+01			
	70	2.3E+02	2.3E+02	2.3E+02	2.3E+02	2.3E+02	2.3E+02	2.3E+02	2.3E+02	2.3E+02	2.3E+02	2.3E+02	2.3E+02			
	100	3.5E+02	3.5E+02	3.5E+02	3.5E+02	3.5E+02	3.5E+02	3.5E+02	3.5E+02	3.5E+02	3.5E+02	3.5E+02	3.5E+02			
Stack Diameter = 4.0 m																
Stack Height (m)	10	2.0E+01	2.0E+01	2.0E+01	2.0E+01	2.0E+01	2.0E+01	2.0E+01	2.0E+01	2.0E+01	2.0E+01	2.0E+01	2.0E+01			
	20	5.1E+01	5.1E+01	5.1E+01	5.1E+01	5.1E+01	5.1E+01	5.1E+01	5.1E+01	5.1E+01	5.1E+01	5.1E+01	5.1E+01			
	30	2.9E+02	2.9E+02	2.9E+02	2.9E+02	2.9E+02	2.9E+02	2.9E+02	2.9E+02	2.9E+02	2.9E+02	2.9E+02	2.9E+02			
	50	5.7E+02	5.7E+02	5.7E+02	5.7E+02	5.7E+02	5.7E+02	5.7E+02	5.7E+02	5.7E+02	5.7E+02	5.7E+02	5.7E+02			

[View or download PDF](#)

Table 2 of §63.1215: Annual Average HCl-Equivalent Emission Rate Limits (lbs/hr)—Simple Elevated Terrain

		Distance to property boundary (m)												
		30	50	70	100	150	200	300	500	700	1000	2000	3000	5000
Stack Diameter = 0.3 m														
Stack height (m)														
5		1.3E+01	1.8E+01	2.5E+01	3.7E+01	6.4E+01	8.9E+01	1.4E+02	2.0E+02	3.1E+02	7.7E+02	1.3E+03	3.0E+03	2.6E+04
10		3.8E+01	3.8E+01	4.4E+01	6.1E+01	1.0E+02	1.4E+02	2.3E+02	3.4E+02	5.2E+02	1.3E+03	2.0E+03	4.8E+03	2.6E+04
20		1.1E+02	1.1E+02	1.2E+02	1.7E+02	2.8E+02	4.2E+02	7.0E+02	1.1E+03	1.7E+03	3.4E+03	5.2E+03	1.2E+04	3.9E+04
30		2.4E+02	2.4E+02	2.4E+02	3.5E+02	5.7E+02	8.6E+02	1.4E+03	2.3E+03	3.6E+03	7.0E+03	1.1E+04	2.6E+04	4.9E+04
50		7.7E+02	7.7E+02	7.7E+02	1.1E+03	1.8E+03	2.7E+03	4.5E+03	7.0E+03	1.1E+04	2.0E+04	3.4E+04	8.3E+04	6.5E+05
Stack Diameter = 0.5 m														
Stack height (m)														
5		1.8E+01	2.6E+01	3.5E+01	5.6E+01	1.0E+02	1.4E+02	2.3E+02	3.4E+02	5.2E+02	1.0E+03	1.7E+03	4.0E+03	2.8E+04
10		5.3E+01	5.3E+01	6.1E+01	8.5E+01	1.4E+02	2.0E+02	3.3E+02	5.0E+02	7.5E+02	1.5E+03	2.5E+03	6.0E+03	2.8E+04
20		1.5E+02	1.5E+02	1.5E+02	2.1E+02	3.5E+02	5.0E+02	8.3E+02	1.2E+03	1.8E+03	3.6E+03	5.2E+03	1.2E+04	3.9E+04
30		2.9E+02	2.9E+02	2.9E+02	4.1E+02	6.8E+02	9.7E+02	1.6E+03	2.3E+03	3.6E+03	7.0E+03	1.1E+04	2.8E+04	3.9E+04
50		8.0E+02	8.0E+02	8.0E+02	1.1E+03	1.8E+03	2.7E+03	4.5E+03	7.0E+03	1.1E+04	2.0E+04	3.4E+04	8.3E+04	6.9E+05
Stack Diameter = 1.0 m														
Stack height (m)														
10		9.7E+01	1.1E+02	1.1E+02	1.7E+02	2.7E+02	3.7E+02	6.0E+02	8.6E+02	1.3E+03	2.5E+03	4.1E+03	1.0E+04	4.1E+04
20		2.7E+02	2.7E+02	2.7E+02	3.9E+02	6.3E+02	8.8E+02	1.4E+03	2.0E+03	3.1E+03	6.0E+03	9.5E+03	2.3E+04	4.3E+04
30		4.3E+02	4.3E+02	4.3E+02	6.0E+02	1.0E+03	1.4E+03	2.3E+03	3.4E+03	5.2E+03	1.0E+04	1.7E+04	4.2E+04	5.2E+04
50		9.2E+02	9.2E+02	9.2E+02	1.3E+03	2.1E+03	3.1E+03	5.0E+03	7.5E+03	1.1E+04	2.0E+04	3.4E+04	8.3E+04	8.3E+04
70		4.0E+03	4.0E+03	4.0E+03	5.5E+03	9.0E+03	1.3E+04	2.0E+04	3.0E+04	4.1E+04	7.8E+04	1.1E+05	2.8E+05	9.8E+05
Stack Diameter = 1.5 m														
Stack height (m)														
10		2.0E+02	2.0E+02	2.3E+02	3.4E+02	5.1E+02	6.0E+02	1.0E+03	1.4E+03	2.1E+03	4.0E+03	6.2E+03	1.5E+04	5.4E+04
20		3.2E+02	3.2E+02	3.5E+02	5.1E+02	7.5E+02	8.8E+02	1.4E+03	2.0E+03	3.0E+03	5.8E+03	8.8E+03	2.2E+04	4.3E+04
30		6.0E+02	6.0E+02	6.0E+02	8.6E+02	1.3E+03	1.6E+03	2.6E+03	3.8E+03	5.6E+03	1.1E+04	1.7E+04	4.2E+04	5.5E+04
50		1.1E+03	1.1E+03	1.1E+03	1.6E+03	2.5E+03	3.1E+03	5.0E+03	7.2E+03	1.1E+04	2.0E+04	3.4E+04	8.3E+04	8.3E+04
70		5.1E+03	5.1E+03	5.1E+03	7.0E+03	1.1E+04	1.4E+04	2.2E+04	3.2E+04	4.8E+04	9.0E+04	1.5E+05	3.8E+05	9.8E+05
Stack Diameter = 2.0 m														
Stack height (m)														
10		2.0E+02	2.0E+02	2.3E+02	3.4E+02	5.1E+02	6.0E+02	1.0E+03	1.4E+03	2.1E+03	4.0E+03	6.2E+03	1.5E+04	5.4E+04
20		4.2E+02	4.2E+02	4.7E+02	6.3E+02	9.2E+02	1.0E+03	1.6E+03	2.2E+03	3.3E+03	6.3E+03	9.5E+03	2.3E+04	4.3E+04
30		8.4E+02	8.4E+02	8.4E+02	1.2E+03	1.8E+03	2.2E+03	3.6E+03	5.0E+03	7.5E+03	1.4E+04	2.5E+04	6.3E+04	6.3E+04
50		1.4E+03	1.4E+03	1.4E+03	2.0E+03	3.0E+03	3.6E+03	5.8E+03	8.0E+03	1.2E+04	2.2E+04	3.7E+04	9.0E+04	9.0E+04
70		5.9E+03	5.9E+03	5.9E+03	8.0E+03	1.2E+04	1.5E+04	2.4E+04	3.4E+04	5.0E+04	9.5E+04	1.6E+05	4.0E+05	8.3E+05
100		8.2E+03	8.2E+03	8.2E+03	1.1E+04	1.7E+04	2.2E+04	3.5E+04	5.0E+04	7.0E+04	1.3E+05	2.2E+05	5.5E+05	1.2E+06
Stack Diameter = 3.0 m														
Stack height (m)														
10		3.3E+02	3.4E+02	3.9E+02	5.5E+02	8.0E+02	9.2E+02	1.5E+03	2.1E+03	3.1E+03	5.8E+03	9.0E+03	2.2E+04	8.6E+04
20		6.5E+02	6.5E+02	7.0E+02	9.7E+02	1.4E+03	1.6E+03	2.6E+03	3.6E+03	5.4E+03	1.0E+04	1.6E+04	4.0E+04	8.6E+04
30		1.1E+03	1.1E+03	1.1E+03	1.6E+03	2.4E+03	2.8E+03	4.5E+03	6.0E+03	8.8E+03	1.7E+04	2.8E+04	7.0E+04	8.6E+04
50		1.7E+03	1.7E+03	1.7E+03	2.4E+03	3.6E+03	4.2E+03	6.6E+03	8.8E+03	1.3E+04	2.4E+04	4.0E+04	1.0E+05	1.0E+05
70		8.0E+03	8.0E+03	8.0E+03	1.1E+04	1.7E+04	2.0E+04	3.1E+04	4.2E+04	6.0E+04	1.1E+05	1.8E+05	4.5E+05	4.5E+05
100		1.3E+04	1.3E+04	1.3E+04	1.8E+04	2.7E+04	3.2E+04	5.0E+04	6.8E+04	1.0E+05	1.8E+05	3.0E+05	7.5E+05	7.5E+05
Stack Diameter = 4.0 m														
Stack height (m)														
10		1.3E+03	1.3E+03	1.3E+03	1.8E+03	2.7E+03	3.2E+03	5.0E+03	6.8E+03	1.0E+04	1.8E+04	3.0E+04	7.5E+04	7.5E+04
20		2.1E+03	2.1E+03	2.1E+03	2.8E+03	4.2E+03	5.0E+03	7.5E+03	1.0E+04	1.6E+04	2.6E+04	4.0E+04	1.0E+05	1.0E+05
30		3.5E+03	3.5E+03	3.5E+03	4.7E+03	7.0E+03	8.2E+03	1.2E+04	1.6E+04	2.4E+04	4.0E+04	6.0E+04	1.5E+05	1.5E+05
50		5.5E+03	5.5E+03	5.5E+03	7.5E+03	1.1E+04	1.3E+04	2.0E+04	2.7E+04	4.0E+04	6.5E+04	1.0E+05	2.5E+05	2.5E+05
70		1.1E+04	1.1E+04	1.1E+04	1.5E+04	2.2E+04	2.6E+04	4.0E+04	5.4E+04	8.0E+04	1.3E+05	2.0E+05	5.0E+05	5.0E+05
100		1.5E+04	1.5E+04	1.5E+04	2.0E+04	3.0E+04	3.6E+04	5.4E+04	7.2E+04	1.1E+05	1.7E+05	2.8E+05	7.0E+05	7.0E+05

Table 3 of §63.1215: 1-Hour Average HCl-Equivalent Emission Rates (lb/hr)—Flat Terrain

		Distance to property boundary (m)											
		30	50	70	100	200	300	500	700	1000	2000	3000	5000
Stack Diameter = 0.3 m													
Stack Height (m)	5	3.8E+00	5.1E+00	7.8E+00	8.0E+00	8.0E+00	2.4E+01	4.3E+01	8.2E+01	8.2E+01	1.1E+02	1.7E+02	3.1E+02
	10	9.7E+00	9.8E+00	1.1E+01	1.4E+01	1.6E+01	2.8E+01	4.9E+01	5.3E+01	6.2E+01	1.1E+02	1.7E+02	3.1E+02
	20	2.2E+01	2.2E+01	2.2E+01	2.2E+01	2.2E+01	2.2E+01	2.2E+01	2.2E+01	2.2E+01	2.2E+01	2.2E+01	2.2E+01
	30	3.8E+01	3.8E+01	3.8E+01	4.0E+01	4.4E+01	5.7E+01	8.0E+01	1.2E+02	1.5E+02	1.8E+02	2.8E+02	4.9E+02
	50	1.2E+02	1.2E+02	1.2E+02	1.2E+02	1.2E+02	1.4E+02	1.9E+02	2.6E+02	3.0E+02	3.1E+02	4.5E+02	7.5E+02
Stack Diameter = 0.5 m													
Stack Height (m)	5	6.9E+00	9.8E+00	1.5E+01	1.8E+01	3.2E+01	4.0E+01	7.5E+01	9.7E+01	1.2E+02	1.0E+02	2.1E+02	3.6E+02
	10	1.3E+01	1.4E+01	1.5E+01	2.0E+01	3.7E+01	5.1E+01	7.9E+01	9.7E+01	1.2E+02	1.0E+02	2.2E+02	3.6E+02
	20	3.0E+01	3.5E+01	3.8E+01	3.0E+01	4.6E+01	8.2E+01	8.1E+01	9.7E+01	1.2E+02	1.0E+02	2.2E+02	3.6E+02
	30	5.2E+01	5.2E+01	5.2E+01	5.2E+01	5.3E+01	6.4E+01	8.8E+01	1.3E+02	1.0E+02	3.2E+02	4.7E+02	7.7E+02
	50	1.3E+02	1.3E+02	1.3E+02	1.3E+02	1.3E+02	1.4E+02	1.9E+02	2.7E+02	3.7E+02	6.0E+02	9.7E+02	1.5E+03
Stack Diameter = 1.0 m													
Stack Height (m)	5	3.0E+01	3.4E+01	3.8E+01	5.1E+01	9.0E+01	1.2E+02	1.7E+02	2.2E+02	2.7E+02	3.0E+02	4.3E+02	6.1E+02
	10	6.0E+01	6.5E+01	6.8E+01	6.8E+01	9.0E+01	1.2E+02	1.7E+02	2.2E+02	2.7E+02	4.3E+02	6.1E+02	7.1E+02
	20	9.0E+01	9.8E+01	9.8E+01	9.8E+01	1.1E+02	1.2E+02	1.2E+02	1.2E+02	1.2E+02	1.2E+02	1.2E+02	1.2E+02
	30	1.7E+02	1.7E+02	1.7E+02	1.7E+02	1.7E+02	1.7E+02	1.7E+02	1.7E+02	1.7E+02	1.7E+02	1.7E+02	1.7E+02
	50	7.0E+02	7.0E+02	7.0E+02	7.0E+02	7.0E+02	7.0E+02	7.0E+02	7.0E+02	7.0E+02	7.0E+02	7.0E+02	7.0E+02
Stack Diameter = 1.5 m													
Stack Height (m)	5	3.0E+01	5.0E+01	6.1E+01	7.5E+01	1.2E+02	2.0E+02	3.4E+02	4.6E+02	4.6E+02	6.0E+02	8.0E+02	1.0E+03
	10	7.1E+01	7.1E+01	7.1E+01	7.1E+01	7.1E+01	7.1E+01	7.1E+01	7.1E+01	7.1E+01	7.1E+01	7.1E+01	7.1E+01
	20	1.2E+02	1.2E+02	1.2E+02	1.2E+02	1.2E+02	1.2E+02	1.2E+02	1.2E+02	1.2E+02	1.2E+02	1.2E+02	1.2E+02
	30	2.2E+02	2.2E+02	2.2E+02	2.2E+02	2.2E+02	2.2E+02	2.2E+02	2.2E+02	2.2E+02	2.2E+02	2.2E+02	2.2E+02
	50	9.8E+02	9.8E+02	9.8E+02	9.8E+02	9.8E+02	9.8E+02	9.8E+02	9.8E+02	9.8E+02	9.8E+02	9.8E+02	9.8E+02
Stack Diameter = 2.0 m													
Stack Height (m)	5	4.7E+01	6.0E+01	7.3E+01	9.2E+01	1.7E+02	2.8E+02	3.2E+02	4.2E+02	5.8E+02	9.7E+02	1.3E+03	1.5E+03
	10	9.8E+01	9.8E+01	9.8E+01	9.8E+01	1.7E+02	2.8E+02	3.2E+02	4.2E+02	5.8E+02	9.7E+02	1.3E+03	1.5E+03
	20	1.5E+02	1.5E+02	1.5E+02	1.5E+02	1.8E+02	2.8E+02	3.2E+02	4.2E+02	5.8E+02	9.7E+02	1.3E+03	1.5E+03
	30	2.7E+02	2.7E+02	2.7E+02	2.7E+02	2.7E+02	2.7E+02	2.7E+02	2.7E+02	2.7E+02	2.7E+02	2.7E+02	2.7E+02
	50	1.3E+03	1.3E+03	1.3E+03	1.3E+03	1.3E+03	1.3E+03	1.3E+03	1.3E+03	1.3E+03	1.3E+03	1.3E+03	1.3E+03
Stack Diameter = 3.0 m													
Stack Height (m)	5	9.2E+01	1.5E+02	1.9E+02	2.4E+02	3.9E+02	5.1E+02	5.1E+02	7.0E+02	9.3E+02	1.2E+03	1.5E+03	1.5E+03
	10	1.5E+02	1.5E+02	1.5E+02	1.5E+02	3.9E+02	5.1E+02	5.1E+02	7.0E+02	9.3E+02	1.2E+03	1.5E+03	1.5E+03
	20	1.9E+02	1.9E+02	1.9E+02	1.9E+02	3.9E+02	5.1E+02	5.1E+02	7.0E+02	9.3E+02	1.2E+03	1.5E+03	1.5E+03
	30	4.0E+02	4.0E+02	4.0E+02	4.0E+02	4.0E+02	4.0E+02	4.0E+02	4.0E+02	4.0E+02	4.0E+02	4.0E+02	4.0E+02
	50	2.2E+03	2.2E+03	2.2E+03	2.2E+03	2.2E+03	2.2E+03	2.2E+03	2.2E+03	2.2E+03	2.2E+03	2.2E+03	2.2E+03
Stack Diameter = 4.0 m													
Stack Height (m)	5	2.3E+02	2.3E+02	2.3E+02	2.3E+02	2.3E+02	2.3E+02	2.3E+02	2.3E+02	2.3E+02	2.3E+02	2.3E+02	2.3E+02
	10	4.8E+02	4.8E+02	4.8E+02	4.8E+02	4.8E+02	4.8E+02	4.8E+02	4.8E+02	4.8E+02	4.8E+02	4.8E+02	4.8E+02
	20	2.4E+03	2.4E+03	2.4E+03	2.4E+03	2.4E+03	2.4E+03	2.4E+03	2.4E+03	2.4E+03	2.4E+03	2.4E+03	2.4E+03
	30	5.4E+03	5.4E+03	5.4E+03	5.4E+03	5.4E+03	5.4E+03	5.4E+03	5.4E+03	5.4E+03	5.4E+03	5.4E+03	5.4E+03

[View or download PDF](#)

Table 4 of §63.1215: 1-Hour Average HCl-Equivalent Emission Rate Limits (lb/hr)—Simple Elevated Terrain
Distance to property boundary (m)

Stack Diameter = 0.3 m	30	50	70	100	200	300	500	700	1000	2000	3000	5000
Stack Height (m)	5	1.4E+00	1.9E+00	2.6E+00	3.8E+00	5.4E+00	7.8E+00	1.1E+01	1.6E+01	2.4E+01	3.5E+01	5.1E+01
10	4.0E+00	4.9E+00	6.6E+00	9.4E+00	1.3E+01	1.9E+01	2.8E+01	4.1E+01	6.0E+01	8.8E+01	1.3E+02	1.9E+02
20	1.1E+01	1.1E+01	1.5E+01	2.1E+01	3.0E+01	4.4E+01	6.4E+01	9.4E+01	1.4E+02	2.1E+02	3.1E+02	4.5E+02
30	2.3E+01	2.3E+01	3.1E+01	4.4E+01	6.4E+01	9.4E+01	1.4E+02	2.1E+02	3.1E+02	4.5E+02	6.6E+02	9.4E+02
50	7.3E+01	7.3E+01	9.7E+01	1.3E+02	1.9E+02	2.8E+02	4.1E+02	6.0E+02	8.8E+02	1.3E+03	1.9E+03	2.7E+03
Stack Diameter = 0.5 m	30	50	70	100	200	300	500	700	1000	2000	3000	5000
Stack Height (m)	5	1.9E+00	2.7E+00	3.7E+00	5.9E+00	8.4E+00	1.2E+01	1.7E+01	2.4E+01	3.5E+01	5.1E+01	7.3E+01
10	5.9E+00	5.9E+00	8.4E+00	1.2E+01	1.7E+01	2.4E+01	3.5E+01	5.1E+01	7.3E+01	1.0E+02	1.4E+02	2.0E+02
20	1.6E+01	1.6E+01	2.1E+01	3.0E+01	4.4E+01	6.4E+01	9.4E+01	1.4E+02	2.1E+02	3.1E+02	4.5E+02	6.6E+02
30	2.7E+01	2.7E+01	3.6E+01	5.1E+01	7.3E+01	1.0E+02	1.4E+02	2.1E+02	3.1E+02	4.5E+02	6.6E+02	9.4E+02
50	7.6E+01	7.6E+01	1.0E+02	1.4E+02	2.1E+02	3.1E+02	4.5E+02	6.6E+02	9.4E+02	1.4E+03	2.0E+03	2.7E+03
Stack Diameter = 1.0 m	30	50	70	100	200	300	500	700	1000	2000	3000	5000
Stack Height (m)	10	1.0E+01	1.0E+01	1.2E+01	1.7E+01	2.4E+01	3.5E+01	5.1E+01	7.3E+01	1.0E+02	1.4E+02	2.0E+02
20	2.6E+01	2.6E+01	3.4E+01	4.9E+01	7.0E+01	1.0E+02	1.4E+02	2.1E+02	3.1E+02	4.5E+02	6.6E+02	9.4E+02
30	4.2E+01	4.2E+01	5.5E+01	7.8E+01	1.1E+02	1.6E+02	2.3E+02	3.4E+02	5.0E+02	7.3E+02	1.0E+03	1.4E+03
50	9.0E+01	9.0E+01	1.2E+02	1.7E+02	2.4E+02	3.5E+02	5.1E+02	7.3E+02	1.0E+03	1.4E+03	2.0E+03	2.7E+03
70	3.0E+02	3.0E+02	3.9E+02	5.5E+02	7.8E+02	1.1E+03	1.6E+03	2.3E+03	3.4E+03	5.0E+03	7.3E+03	1.0E+04
Stack Diameter = 1.5 m	30	50	70	100	200	300	500	700	1000	2000	3000	5000
Stack Height (m)	10	2.1E+01	2.1E+01	2.6E+01	3.6E+01	5.1E+01	7.3E+01	1.0E+02	1.4E+02	2.1E+02	3.1E+02	4.5E+02
20	3.3E+01	3.3E+01	4.3E+01	6.0E+01	8.4E+01	1.2E+02	1.7E+02	2.4E+02	3.5E+02	5.1E+02	7.3E+02	1.0E+03
30	5.3E+01	5.3E+01	6.9E+01	9.7E+01	1.4E+02	2.0E+02	2.9E+02	4.1E+02	6.0E+02	8.8E+02	1.3E+03	1.9E+03
50	1.0E+02	1.0E+02	1.3E+02	1.8E+02	2.6E+02	3.7E+02	5.1E+02	7.3E+02	1.0E+03	1.4E+03	2.0E+03	2.7E+03
70	4.0E+02	4.0E+02	5.2E+02	7.2E+02	1.0E+03	1.4E+03	2.0E+03	2.9E+03	4.1E+03	6.0E+03	8.8E+03	1.3E+04
Stack Diameter = 2.0 m	30	50	70	100	200	300	500	700	1000	2000	3000	5000
Stack Height (m)	10	2.7E+01	2.7E+01	3.4E+01	4.7E+01	6.6E+01	9.4E+01	1.3E+02	1.9E+02	2.8E+02	4.1E+02	5.8E+02
20	4.0E+01	4.0E+01	5.2E+01	7.2E+01	1.0E+02	1.4E+02	2.0E+02	2.9E+02	4.1E+02	6.0E+02	8.8E+02	1.3E+03
30	7.0E+01	7.0E+01	9.1E+01	1.3E+02	1.9E+02	2.7E+02	3.9E+02	5.5E+02	7.8E+02	1.1E+03	1.6E+03	2.2E+03
50	1.3E+02	1.3E+02	1.7E+02	2.4E+02	3.4E+02	4.8E+02	6.7E+02	9.4E+02	1.3E+03	1.9E+03	2.7E+03	3.8E+03
70	5.0E+02	5.0E+02	6.5E+02	9.1E+02	1.3E+03	1.8E+03	2.6E+03	3.7E+03	5.1E+03	7.3E+03	1.0E+04	1.4E+04
100	1.9E+03	1.9E+03	2.5E+03	3.4E+03	4.8E+03	6.7E+03	9.4E+03	1.3E+04	1.9E+04	2.7E+04	3.8E+04	5.3E+04
Stack Diameter = 3.0 m	30	50	70	100	200	300	500	700	1000	2000	3000	5000
Stack Height (m)	10	3.5E+01	4.1E+01	5.0E+01	6.8E+01	9.7E+01	1.4E+02	2.0E+02	2.8E+02	4.1E+02	5.8E+02	8.1E+02
20	6.2E+01	6.2E+01	8.0E+01	1.1E+02	1.6E+02	2.3E+02	3.4E+02	4.8E+02	6.7E+02	9.4E+02	1.3E+03	1.9E+03
30	1.0E+02	1.0E+02	1.3E+02	1.8E+02	2.6E+02	3.7E+02	5.1E+02	7.3E+02	1.0E+03	1.4E+03	2.0E+03	2.7E+03
50	1.8E+02	1.8E+02	2.4E+02	3.4E+02	4.8E+02	6.7E+02	9.4E+02	1.3E+03	1.9E+03	2.7E+03	3.8E+03	5.3E+03
70	7.5E+02	7.5E+02	9.8E+02	1.4E+03	1.9E+03	2.7E+03	3.8E+03	5.1E+03	7.3E+03	1.0E+04	1.4E+04	1.9E+04
100	2.8E+03	2.8E+03	3.7E+03	5.1E+03	7.3E+03	1.0E+04	1.4E+04	1.9E+04	2.7E+04	3.8E+04	5.3E+04	7.3E+04
Stack Diameter = 4.0 m	30	50	70	100	200	300	500	700	1000	2000	3000	5000
Stack Height (m)	30	1.2E+02	1.2E+02	1.5E+02	2.1E+02	3.0E+02	4.1E+02	5.8E+02	8.1E+02	1.1E+03	1.6E+03	2.2E+03
50	2.2E+02	2.2E+02	2.8E+02	3.9E+02	5.5E+02	7.8E+02	1.1E+03	1.6E+03	2.2E+03	3.1E+03	4.3E+03	5.9E+03
70	4.0E+02	4.0E+02	5.2E+02	7.2E+02	1.0E+03	1.4E+03	2.0E+03	2.9E+03	4.1E+03	5.8E+03	8.1E+03	1.1E+04
100	1.0E+03	1.0E+03	1.3E+03	1.8E+03	2.6E+03	3.7E+03	5.1E+03	7.3E+03	1.0E+04	1.4E+04	1.9E+04	2.7E+04

[View or download PDF](#)

[70 FR 59565, Oct. 12, 2005, as amended at 73 FR 18982, Apr. 8, 2008; 73 FR 64097, Oct. 28, 2008]

[Back to Top](#)

EMISSIONS STANDARDS AND OPERATING LIMITS FOR SOLID FUEL BOILERS, LIQUID FUEL BOILERS, AND HYDROCHLORIC ACID PRODUCTION FURNACES

[Back to Top](#)

§63.1216 What are the standards for solid fuel boilers that burn hazardous waste?

(a) *Emission limits for existing sources.* You must not discharge or cause combustion gases to be emitted into the atmosphere that contain:

(1) For dioxins and furans, either carbon monoxide or hydrocarbon emissions in excess of the limits provided by paragraph (a)(5) of this section;

(2) Mercury in excess of 11 µgm/dscm corrected to 7 percent oxygen;

(3) For cadmium and lead combined, except for an area source as defined under §63.2, emissions in excess of 180 µgm/dscm, corrected to 7 percent oxygen;

(4) For arsenic, beryllium, and chromium combined, except for an area source as defined under §63.2, emissions in excess of 380 µgm/dscm, corrected to 7 percent oxygen;

(5) For carbon monoxide and hydrocarbons, either:

(i) Carbon monoxide in excess of 100 parts per million by volume, over an hourly rolling average (monitored continuously with a continuous emissions monitoring system), dry basis and corrected to 7 percent oxygen. If you elect to comply with this carbon monoxide standard rather than the hydrocarbon standard under paragraph (a)(5)(ii) of this section, you must also document that, during the destruction and removal efficiency (DRE) test runs or their equivalent as provided by §63.1206(b)(7), hydrocarbons do not exceed 10 parts per million by volume during those runs, over an hourly rolling average (monitored continuously with a continuous emissions monitoring system), dry basis, corrected to 7 percent oxygen, and reported as propane; or

(ii) Hydrocarbons in excess of 10 parts per million by volume, over an hourly rolling average (monitored continuously with a continuous emissions monitoring system), dry basis, corrected to 7 percent oxygen, and reported as propane;

(6) For hydrogen chloride and chlorine combined, except for an area source as defined under §63.2, emissions in excess of 440 parts per million by volume, expressed as a chloride (Cl⁻) equivalent, dry basis and corrected to 7 percent oxygen; and

(7) For particulate matter, except for an area source as defined under §63.2 or as provided by paragraph (e) of this section, emissions in excess of 68 mg/dscm corrected to 7 percent oxygen.

(b) *Emission limits for new sources.* You must not discharge or cause combustion gases to be emitted into the atmosphere that contain:

(1) For dioxins and furans, either carbon monoxide or hydrocarbon emissions in excess of the limits provided by paragraph (b)(5) of this section;

(2) Mercury in excess of 11 µgm/dscm corrected to 7 percent oxygen;

(3) For cadmium and lead combined, except for an area source as defined under §63.2, emissions in excess of 180 µgm/dscm, corrected to 7 percent oxygen;

(4) For arsenic, beryllium, and chromium combined, except for an area source as defined under §63.2, emissions in excess of 190 µgm/dscm, corrected to 7 percent oxygen;

(5) For carbon monoxide and hydrocarbons, either:

(i) Carbon monoxide in excess of 100 parts per million by volume, over an hourly rolling average (monitored continuously with a continuous emissions monitoring system), dry basis and corrected to 7 percent oxygen. If you elect to comply with this carbon monoxide standard rather than the hydrocarbon standard under paragraph (b)(5)(ii) of this section, you must also document that, during the destruction and removal efficiency (DRE) test runs or their equivalent as provided by §63.1206(b)(7), hydrocarbons do not exceed 10 parts per million by volume during those runs, over an hourly rolling average (monitored

continuously with a continuous emissions monitoring system), dry basis, corrected to 7 percent oxygen, and reported as propane; or

(ii) Hydrocarbons in excess of 10 parts per million by volume, over an hourly rolling average (monitored continuously with a continuous emissions monitoring system), dry basis, corrected to 7 percent oxygen, and reported as propane;

(6) For hydrogen chloride and chlorine combined, except for an area source as defined under §63.2, emissions in excess of 73 parts per million by volume, expressed as a chloride (Cl^-) equivalent, dry basis and corrected to 7 percent oxygen; and

(7) For particulate matter, except for an area source as defined under §63.2 or as provided by paragraph (e) of this section, emissions in excess of 34 mg/dscm corrected to 7 percent oxygen.

(c) *Destruction and removal efficiency (DRE) standard*—(1) *99.99% DRE*. Except as provided in paragraph (c)(2) of this section, you must achieve a DRE of 99.99% for each principle organic hazardous constituent (POHC) designated under paragraph (c)(3) of this section. You must calculate DRE for each POHC from the following equation:

$$\text{DRE} = [1 - (W_{\text{out}} \div W_{\text{in}})] \times 100\%$$

Where:

W_{in} = mass feedrate of one POHC in a waste feedstream; and

W_{out} = mass emission rate of the same POHC present in exhaust emissions prior to release to the atmosphere.

(2) *99.9999% DRE*. If you burn the dioxin-listed hazardous wastes F020, F021, F022, F023, F026, or F027 (see §261.31 of this chapter), you must achieve a DRE of 99.9999% for each POHC that you designate under paragraph (c)(3) of this section. You must demonstrate this DRE performance on POHCs that are more difficult to incinerate than tetra-, penta-, and hexachlorodibenzo-*p*-dioxins and dibenzofurans. You must use the equation in paragraph (c)(1) of this section to calculate DRE for each POHC. In addition, you must notify the Administrator of your intent to incinerate hazardous wastes F020, F021, F022, F023, F026, or F027.

(3) *Principal organic hazardous constituents (POHCs)*. (i) You must treat the POHCs in the waste feed that you specify under paragraph (c)(3)(ii) of this section to the extent required by paragraphs (c)(1) and (c)(2) of this section.

(ii) You must specify one or more POHCs that are representative of the most difficult to destroy organic compounds in your hazardous waste feedstream. You must base this specification on the degree of difficulty of incineration of the organic constituents in the hazardous waste and on their concentration or mass in the hazardous waste feed, considering the results of hazardous waste analyses or other data and information.

(d) *Significant figures*. The emission limits provided by paragraphs (a) and (b) of this section are presented with two significant figures. Although you must perform intermediate calculations using at least three significant figures, you may round the resultant emission levels to two significant figures to document compliance.

(e) *Alternative to the particulate matter standard*—(1) *General*. In lieu of complying with the particulate matter standards of this section, you may elect to comply with the following alternative metal emission control requirement:

(2) *Alternative metal emission control requirements for existing solid fuel boilers.* (i) You must not discharge or cause combustion gases to be emitted into the atmosphere that contain cadmium, lead, and selenium in excess of 180 µgm/dscm, combined emissions, corrected to 7 percent oxygen; and,

(ii) You must not discharge or cause combustion gases to be emitted into the atmosphere that contain antimony, arsenic, beryllium, chromium, cobalt, manganese, and nickel in excess of 380 µgm/dscm, combined emissions, corrected to 7 percent oxygen.

(3) *Alternative metal emission control requirements for new solid fuel boilers.* (i) You must not discharge or cause combustion gases to be emitted into the atmosphere that contain cadmium, lead, and selenium in excess of 180 µgm/dscm, combined emissions, corrected to 7 percent oxygen; and,

(ii) You must not discharge or cause combustion gases to be emitted into the atmosphere that contain antimony, arsenic, beryllium, chromium, cobalt, manganese, and nickel in excess of 190 µgm/dscm, combined emissions, corrected to 7 percent oxygen.

(4) *Operating limits.* Semivolatile and low volatile metal operating parameter limits must be established to ensure compliance with the alternative emission limitations described in paragraphs (e)(2) and (e)(3) of this section pursuant to §63.1209(n), except that semivolatile metal feedrate limits apply to lead, cadmium, and selenium, combined, and low volatile metal feedrate limits apply to arsenic, beryllium, chromium, antimony, cobalt, manganese, and nickel, combined.

(f) *Elective standards for area sources.* Area sources as defined under §63.2 are subject to the standards for cadmium and lead, the standards for arsenic, beryllium, and chromium, the standards for hydrogen chloride and chlorine, and the standards for particulate matter under this section if they elect under §266.100(b)(3) of this chapter to comply with those standards in lieu of the standards under 40 CFR 266.105, 266.106, and 266.107 to control those pollutants.

[70 FR 59565, Oct. 12, 2005]

[↑ Back to Top](#)

§63.1217 What are the standards for liquid fuel boilers that burn hazardous waste?

(a) *Emission limits for existing sources.* You must not discharge or cause combustion gases to be emitted into the atmosphere that contain:

(1)(i) Dioxins and furans in excess of 0.40 ng TEQ/dscm, corrected to 7 percent oxygen, for liquid fuel boilers equipped with a dry air pollution control system; or

(ii) Either carbon monoxide or hydrocarbon emissions in excess of the limits provided by paragraph (a)(5) of this section for sources not equipped with a dry air pollution control system;

(iii) A source equipped with a wet air pollution control system followed by a dry air pollution control system is not considered to be a dry air pollution control system, and a source equipped with a dry air pollution control system followed by a wet air pollution control system is considered to be a dry air pollution control system for purposes of this emission limit;

(2) For mercury, except as provided for in paragraph (a)(2)(iii) of this section:

(i) When you burn hazardous waste with an as-fired heating value less than 10,000 Btu/lb, emissions in excess of 19 µgm/dscm, corrected to 7 percent oxygen, on an (not-to-exceed) annual averaging period;

(ii) When you burn hazardous waste with an as-fired heating value 10,000 Btu/lb or greater, emissions in excess of 4.2×10^{-5} lbs mercury attributable to the hazardous waste per million Btu heat input from the hazardous waste on an (not-to-exceed) annual averaging period;

(iii) The boiler operated by Diversified Scientific Services, Inc. with EPA identification number TND982109142, and which burns radioactive waste mixed with hazardous waste, must comply with the mercury emission standard under §63.1219(a)(2);

(3) For cadmium and lead combined, except for an area source as defined under §63.2,

(i) When you burn hazardous waste with an as-fired heating value less than 10,000 Btu/lb, emissions in excess of 150 µgm/dscm, corrected to 7 percent oxygen, on an (not-to-exceed) annual averaging period;

(ii) When you burn hazardous waste with an as-fired heating value of 10,000 Btu/lb or greater, emissions in excess of 8.2×10^{-5} lbs combined cadmium and lead emissions attributable to the hazardous waste per million Btu heat input from the hazardous waste on an (not-to-exceed) annual averaging period;

(4) For chromium, except for an area source as defined under §63.2:

(i) When you burn hazardous waste with an as-fired heating value less than 10,000 Btu/lb, emissions in excess of 370 µgm/dscm, corrected to 7 percent oxygen;

(ii) When you burn hazardous waste with an as-fired heating value of 10,000 Btu/lb or greater, emissions in excess of 1.3×10^{-4} lbs chromium emissions attributable to the hazardous waste per million Btu heat input from the hazardous waste;

(5) For carbon monoxide and hydrocarbons, either:

(i) Carbon monoxide in excess of 100 parts per million by volume, over an hourly rolling average (monitored continuously with a continuous emissions monitoring system), dry basis and corrected to 7 percent oxygen. If you elect to comply with this carbon monoxide standard rather than the hydrocarbon standard under paragraph (a)(5)(ii) of this section, you must also document that, during the destruction and removal efficiency (DRE) test runs or their equivalent as provided by §63.1206(b)(7), hydrocarbons do not exceed 10 parts per million by volume during those runs, over an hourly rolling average (monitored continuously with a continuous emissions monitoring system), dry basis, corrected to 7 percent oxygen, and reported as propane; or

(ii) Hydrocarbons in excess of 10 parts per million by volume, over an hourly rolling average (monitored continuously with a continuous emissions monitoring system), dry basis, corrected to 7 percent oxygen, and reported as propane;

(6) For hydrogen chloride and chlorine, except for an area source as defined under §63.2:

(i) When you burn hazardous waste with an as-fired heating value less than 10,000 Btu/lb, emissions in excess of 31 parts per million by volume, combined emissions, expressed as a chloride (Cl^-) equivalent, dry basis and corrected to 7 percent oxygen;

(ii) When you burn hazardous waste with an as-fired heating value of 10,000 Btu/lb or greater, emissions in excess of 5.1×10^{-2} lbs combined emissions of hydrogen chloride and chlorine gas attributable to the hazardous waste per million Btu heat input from the hazardous waste;

(7) For particulate matter, except for an area source as defined under §63.2 or as provided by paragraph (e) of this section, emissions in excess of 80 mg/dscm corrected to 7 percent oxygen.

(b) *Emission limits for new sources.* You must not discharge or cause combustion gases to be emitted into the atmosphere that contain:

(1)(i) Dioxins and furans in excess of 0.40 ng TEQ/dscm, corrected to 7 percent oxygen, for liquid fuel boilers equipped with a dry air pollution control system; or

(ii) Either carbon monoxide or hydrocarbon emissions in excess of the limits provided by paragraph (b)(5) of this section for sources not equipped with a dry air pollution control system;

(iii) A source equipped with a wet air pollution control system followed by a dry air pollution control system is not considered to be a dry air pollution control system, and a source equipped with a dry air pollution control system followed by a wet air pollution control system is considered to be a dry air pollution control system for purposes of this emission limit;

(2) For mercury:

(i) When you burn hazardous waste with an as-fired heating value less than 10,000 Btu/lb, emissions in excess of 6.8 µgm/dscm, corrected to 7 percent oxygen, on an (not-to-exceed) annual averaging period;

(ii) When you burn hazardous waste with an as-fired heating value of 10,000 Btu/lb or greater, emissions in excess of 1.2×10^{-6} lbs mercury emissions attributable to the hazardous waste per million Btu heat input from the hazardous waste on an (not-to-exceed) annual averaging period;

(3) For cadmium and lead combined, except for an area source as defined under §63.2:

(i) When you burn hazardous waste with an as-fired heating value less than 10,000 Btu/lb, emissions in excess of 78 µgm/dscm, corrected to 7 percent oxygen, on an (not-to-exceed) annual averaging period;

(ii) When you burn hazardous waste with an as-fired heating value greater than or equal to 10,000 Btu/lb, emissions in excess of 6.2×10^{-6} lbs combined cadmium and lead emissions attributable to the hazardous waste per million Btu heat input from the hazardous waste on an (not-to-exceed) annual averaging period;

(4) For chromium, except for an area source as defined under §63.2:

(i) When you burn hazardous waste with an as-fired heating value less than 10,000 Btu/lb, emissions in excess of 12 µgm/dscm, corrected to 7 percent oxygen;

(ii) When you burn hazardous waste with an as-fired heating value of 10,000 Btu/lb or greater, emissions in excess of 1.4×10^{-5} lbs chromium emissions attributable to the hazardous waste per million Btu heat input from the hazardous waste;

(5) For carbon monoxide and hydrocarbons, either:

(i) Carbon monoxide in excess of 100 parts per million by volume, over an hourly rolling average (monitored continuously with a continuous emissions monitoring system), dry basis and corrected to 7 percent oxygen. If you elect to comply with this carbon monoxide standard rather than the hydrocarbon standard under paragraph (b)(5)(ii) of this section, you must also document that, during the destruction

and removal efficiency (DRE) test runs or their equivalent as provided by §63.1206(b)(7), hydrocarbons do not exceed 10 parts per million by volume during those runs, over an hourly rolling average (monitored continuously with a continuous emissions monitoring system), dry basis, corrected to 7 percent oxygen, and reported as propane; or

(ii) Hydrocarbons in excess of 10 parts per million by volume, over an hourly rolling average (monitored continuously with a continuous emissions monitoring system), dry basis, corrected to 7 percent oxygen, and reported as propane;

(6) For hydrogen chloride and chlorine, except for an area source as defined under §63.2:

(i) When you burn hazardous waste with an as-fired heating value less than 10,000 Btu/lb, emissions in excess of 31 parts per million by volume, combined emissions, expressed as a chloride (Cl⁻) equivalent, dry basis and corrected to 7 percent oxygen;

(ii) When you burn hazardous waste with an as-fired heating value of 10,000 Btu/lb or greater, emissions in excess of 5.1×10^{-2} lbs combined emissions of hydrogen chloride and chlorine gas attributable to the hazardous waste per million Btu heat input from the hazardous waste;

(7) For particulate matter, except for an area source as defined under §63.2 or as provided by paragraph (e) of this section, emissions in excess of 20 mg/dscm corrected to 7 percent oxygen.

(c) *Destruction and removal efficiency (DRE) standard*—(1) *99.99% DRE*. Except as provided in paragraph (c)(2) of this section, you must achieve a DRE of 99.99% for each principle organic hazardous constituent (POHC) designated under paragraph (c)(3) of this section. You must calculate DRE for each POHC from the following equation:

$$\text{DRE} = [1 - (W_{\text{out}} \div W_{\text{in}})] \times 100\%$$

Where:

W_{in} = mass feedrate of one POHC in a waste feedstream; and

W_{out} = mass emission rate of the same POHC present in exhaust emissions prior to release to the atmosphere.

(2) *99.9999% DRE*. If you burn the dioxin-listed hazardous wastes F020, F021, F022, F023, F026, or F027 (see §261.31 of this chapter), you must achieve a DRE of 99.9999% for each POHC that you designate under paragraph (c)(3) of this section. You must demonstrate this DRE performance on POHCs that are more difficult to incinerate than tetra-, penta-, and hexachlorodibenzo-*p*-dioxins and dibenzofurans. You must use the equation in paragraph (c)(1) of this section to calculate DRE for each POHC. In addition, you must notify the Administrator of your intent to incinerate hazardous wastes F020, F021, F022, F023, F026, or F027.

(3) *Principal organic hazardous constituents (POHCs)*. (i) You must treat the POHCs in the waste feed that you specify under paragraph (c)(3)(ii) of this section to the extent required by paragraphs (c)(1) and (c)(2) of this section.

(ii) You must specify one or more POHCs that are representative of the most difficult to destroy organic compounds in your hazardous waste feedstream. You must base this specification on the degree of difficulty of incineration of the organic constituents in the hazardous waste and on their concentration or mass in the hazardous waste feed, considering the results of hazardous waste analyses or other data and information.

(d) *Significant figures.* The emission limits provided by paragraphs (a) and (b) of this section are presented with two significant figures. Although you must perform intermediate calculations using at least three significant figures, you may round the resultant emission levels to two significant figures to document compliance.

(e) *Alternative to the particulate matter standard—(1) General.* In lieu of complying with the particulate matter standards of this section, you may elect to comply with the following alternative metal emission control requirement:

(2) *Alternative metal emission control requirements for existing liquid fuel boilers.* (i) When you burn hazardous waste with a heating value less than 10,000 Btu/lb:

(A) You must not discharge or cause combustion gases to be emitted into the atmosphere that contain cadmium, lead, and selenium, combined, in excess of 150 $\mu\text{g}/\text{dscm}$, corrected to 7 percent oxygen; and

(B) You must not discharge or cause combustion gases to be emitted into the atmosphere that contain antimony, arsenic, beryllium, chromium, cobalt, manganese, and nickel, combined, in excess of 370 $\mu\text{g}/\text{dscm}$, corrected to 7 percent oxygen;

(ii) When you burn hazardous waste with a heating value of 10,000 Btu/lb or greater:

(A) You must not discharge or cause combustion gases to be emitted into the atmosphere that contain in excess of 8.2×10^{-5} lbs combined emissions of cadmium, lead, and selenium attributable to the hazardous waste per million Btu heat input from the hazardous waste; and

(B) You must not discharge or cause combustion gases to be emitted into the atmosphere that contain either in excess of 1.3×10^{-4} lbs combined emissions of antimony, arsenic, beryllium, chromium, cobalt, manganese, and nickel attributable to the hazardous waste per million Btu heat input from the hazardous waste;

(3) *Alternative metal emission control requirements for new liquid fuel boilers.* (i) When you burn hazardous waste with a heating value less than 10,000 Btu/lb:

(A) You must not discharge or cause combustion gases to be emitted into the atmosphere that contain cadmium, lead, and selenium, combined, in excess of 78 $\mu\text{g}/\text{dscm}$, corrected to 7 percent oxygen; and

(B) You must not discharge or cause combustion gases to be emitted into the atmosphere that contain antimony, arsenic, beryllium, chromium, cobalt, manganese, and nickel, combined, in excess of 12 $\mu\text{g}/\text{dscm}$, corrected to 7 percent oxygen;

(ii) When you burn hazardous waste with a heating value greater than or equal to 10,000 Btu/lb:

(A) You must not discharge or cause combustion gases to be emitted into the atmosphere that contain in excess of 6.2×10^{-6} lbs combined emissions of cadmium, lead, and selenium attributable to the hazardous waste per million Btu heat input from the hazardous waste; and

(B) You must not discharge or cause combustion gases to be emitted into the atmosphere that contain either in excess of 1.4×10^{-5} lbs combined emissions of antimony, arsenic, beryllium, chromium, cobalt, manganese, and nickel attributable to the hazardous waste per million Btu heat input from the hazardous waste;

(4) *Operating limits.* Semivolatile and low volatile metal operating parameter limits must be established to ensure compliance with the alternative emission limitations described in paragraphs (e)(2) and (e)(3) of this section pursuant to §63.1209(n), except that semivolatile metal feedrate limits apply to lead, cadmium, and selenium, combined, and low volatile metal feedrate limits apply to arsenic, beryllium, chromium, antimony, cobalt, manganese, and nickel, combined.

(f) *Elective standards for area sources.* Area sources as defined under §63.2 are subject to the standards for cadmium and lead, the standards for chromium, the standards for hydrogen chloride and chlorine, and the standards for particulate matter under this section if they elect under §266.100(b)(3) of this chapter to comply with those standards in lieu of the standards under 40 CFR 266.105, 266.106, and 266.107 to control those pollutants.

[70 FR 59567, Oct. 12, 2005, as amended at 73 FR 18983, Apr. 8, 2008]

[↑ Back to Top](#)

§63.1218 What are the standards for hydrochloric acid production furnaces that burn hazardous waste?

(a) *Emission limits for existing sources.* You must not discharge or cause combustion gases to be emitted into the atmosphere that contain:

(1) For dioxins and furans, either carbon monoxide or hydrocarbon emissions in excess of the limits provided by paragraph (a)(5) of this section;

(2) For mercury, hydrogen chloride and chlorine gas emissions in excess of the levels provided by paragraph (a)(6) of this section;

(3) For lead and cadmium, except for an area source as defined under §63.2, hydrogen chloride and chlorine gas emissions in excess of the levels provided by paragraph (a)(6) of this section;

(4) For arsenic, beryllium, and chromium, except for an area source as defined under §63.2, hydrogen chloride and chlorine gas emissions in excess of the levels provided by paragraph (a)(6) of this section;

(5) For carbon monoxide and hydrocarbons, either:

(i) Carbon monoxide in excess of 100 parts per million by volume, over an hourly rolling average (monitored continuously with a continuous emissions monitoring system), dry basis and corrected to 7 percent oxygen. If you elect to comply with this carbon monoxide standard rather than the hydrocarbon standard under paragraph (a)(5)(ii) of this section, you must also document that, during the destruction and removal efficiency (DRE) test runs or their equivalent as provided by §63.1206(b)(7), hydrocarbons do not exceed 10 parts per million by volume during those runs, over an hourly rolling average (monitored continuously with a continuous emissions monitoring system), dry basis, corrected to 7 percent oxygen, and reported as propane; or

(ii) Hydrocarbons in excess of 10 parts per million by volume, over an hourly rolling average (monitored continuously with a continuous emissions monitoring system), dry basis, corrected to 7 percent oxygen, and reported as propane;

(6) For hydrogen chloride and chlorine gas, either:

(i) Emission in excess of 150 parts per million by volume, combined emissions, expressed as a chloride (Cl⁻) equivalent, dry basis and corrected to 7 percent oxygen; or

(ii) Emissions greater than the levels that would be emitted if the source is achieving a system removal efficiency (SRE) of less than 99.923 percent for total chlorine and chloride fed to the combustor. You must calculate SRE from the following equation:

$$\text{SRE} = [1 - (\text{Cl}_{\text{out}} / \text{Cl}_{\text{in}})] \times 100\%$$

Where:

Cl in = mass feedrate of total chlorine or chloride in all feedstreams, reported as chloride; and

Cl out = mass emission rate of hydrogen chloride and chlorine gas, reported as chloride, in exhaust emissions prior to release to the atmosphere.

(7) For particulate matter, except for an area source as defined under §63.2, hydrogen chloride and chlorine gas emissions in excess of the levels provided by paragraph (a)(6) of this section.

(b) *Emission limits for new sources.* You must not discharge or cause combustion gases to be emitted into the atmosphere that contain:

(1) For dioxins and furans, either carbon monoxide or hydrocarbon emissions in excess of the limits provided by paragraph (b)(5) of this section;

(2) For mercury, hydrogen chloride and chlorine gas emissions in excess of the levels provided by paragraph (b)(6) of this section;

(3) For lead and cadmium, except for an area source as defined under §63.2, hydrogen chloride and chlorine gas emissions in excess of the levels provided by paragraph (b)(6) of this section;

(4) For arsenic, beryllium, and chromium, except for an area source as defined under §63.2, hydrogen chloride and chlorine gas emissions in excess of the levels provided by paragraph (b)(6) of this section;

(5) For carbon monoxide and hydrocarbons, either:

(i) Carbon monoxide in excess of 100 parts per million by volume, over an hourly rolling average (monitored continuously with a continuous emissions monitoring system), dry basis and corrected to 7 percent oxygen. If you elect to comply with this carbon monoxide standard rather than the hydrocarbon standard under paragraph (b)(5)(ii) of this section, you must also document that, during the destruction and removal efficiency (DRE) test runs or their equivalent as provided by §63.1206(b)(7), hydrocarbons do not exceed 10 parts per million by volume during those runs, over an hourly rolling average (monitored continuously with a continuous emissions monitoring system), dry basis, corrected to 7 percent oxygen, and reported as propane; or

(ii) Hydrocarbons in excess of 10 parts per million by volume, over an hourly rolling average (monitored continuously with a continuous emissions monitoring system), dry basis, corrected to 7 percent oxygen, and reported as propane;

(6) For hydrogen chloride and chlorine gas, either:

(i) Emission in excess of 25 parts per million by volume, combined emissions, expressed as a chloride (Cl⁻) equivalent, dry basis and corrected to 7 percent oxygen; or

(ii) Emissions greater than the levels that would be emitted if the source is achieving a system removal efficiency (SRE) of less than 99.987 percent for total chlorine and chloride fed to the combustor. You must calculate SRE from the following equation:

$$\text{SRE} = [1 - (\text{Cl}_{\text{out}} / \text{Cl}_{\text{in}})] \times 100\%$$

Where:

Cl in = mass feedrate of total chlorine or chloride in all feedstreams, reported as chloride; and

Cl out = mass emission rate of hydrogen chloride and chlorine gas, reported as chloride, in exhaust emissions prior to release to the atmosphere.

(7) For particulate matter, except for an area source as defined under §63.2, hydrogen chloride and chlorine gas emissions in excess of the levels provided by paragraph (b)(6) of this section.

(c) *Destruction and removal efficiency (DRE) standard*—(1) 99.99% DRE. Except as provided in paragraph (c)(2) of this section, you must achieve a DRE of 99.99% for each principle organic hazardous constituent (POHC) designated under paragraph (c)(3) of this section. You must calculate DRE for each POHC from the following equation:

$$\text{DRE} = [1 - (W_{\text{out}} / W_{\text{in}})] \times 100\%$$

Where:

Win = mass feedrate of one POHC in a waste feedstream; and

Wout = mass emission rate of the same POHC present in exhaust emissions prior to release to the atmosphere.

(2) 99.9999% DRE. If you burn the dioxin-listed hazardous wastes F020, F021, F022, F023, F026, or F027 (see §261.31 of this chapter), you must achieve a DRE of 99.9999% for each POHC that you designate under paragraph (c)(3) of this section. You must demonstrate this DRE performance on POHCs that are more difficult to incinerate than tetra-, penta-, and hexachlorodibenzo-*p*-dioxins and dibenzofurans. You must use the equation in paragraph (c)(1) of this section to calculate DRE for each POHC. In addition, you must notify the Administrator of your intent to incinerate hazardous wastes F020, F021, F022, F023, F026, or F027.

(3) *Principal organic hazardous constituents (POHCs)*. (i) You must treat the POHCs in the waste feed that you specify under paragraph (c)(3)(ii) of this section to the extent required by paragraphs (c)(1) and (c)(2) of this section.

(ii) You must specify one or more POHCs that are representative of the most difficult to destroy organic compounds in your hazardous waste feedstream. You must base this specification on the degree of difficulty of incineration of the organic constituents in the hazardous waste and on their concentration or mass in the hazardous waste feed, considering the results of hazardous waste analyses or other data and information.

(d) *Significant figures*. The emission limits provided by paragraphs (a) and (b) of this section are presented with two significant figures. Although you must perform intermediate calculations using at least three significant figures, you may round the resultant emission levels to two significant figures to document compliance.

(e) *Elective standards for area sources.* Area sources as defined under §63.2 are subject to the standards for cadmium and lead, the standards for arsenic, beryllium, and chromium, the standards for hydrogen chloride and chlorine, and the standards for particulate matter under this section if they elect under §266.100(b)(3) of this chapter to comply with those standards in lieu of the standards under 40 CFR 266.105, 266.106, and 266.107 to control those pollutants.

[70 FR 59569, Oct. 12, 2005]

[↑ Back to Top](#)

REPLACEMENT EMISSIONS STANDARDS AND OPERATING LIMITS FOR INCINERATORS, CEMENT KILNS, AND LIGHTWEIGHT AGGREGATE KILNS

[↑ Back to Top](#)

§63.1219 What are the replacement standards for hazardous waste incinerators?

(a) *Emission limits for existing sources.* You must not discharge or cause combustion gases to be emitted into the atmosphere that contain:

(1) For dioxins and furans:

(i) For incinerators equipped with either a waste heat boiler or dry air pollution control system, either:

(A) Emissions in excess of 0.20 ng TEQ/dscm, corrected to 7 percent oxygen; or

(B) Emissions in excess of 0.40 ng TEQ/dscm, corrected to 7 percent oxygen, provided that the combustion gas temperature at the inlet to the initial particulate matter control device is 400 °F or lower based on the average of the test run average temperatures. (For purposes of compliance, operation of a wet particulate matter control device is presumed to meet the 400 °F or lower requirement);

(ii) Emissions in excess of 0.40 ng TEQ/dscm, corrected to 7 percent oxygen, for incinerators not equipped with either a waste heat boiler or dry air pollution control system;

(iii) A source equipped with a wet air pollution control system followed by a dry air pollution control system is not considered to be a dry air pollution control system, and a source equipped with a dry air pollution control system followed by a wet air pollution control system is considered to be a dry air pollution control system for purposes of this standard;

(2) Mercury in excess of 130 µgm/dscm, corrected to 7 percent oxygen;

(3) Cadmium and lead in excess of 230 µgm/dscm, combined emissions, corrected to 7 percent oxygen;

(4) Arsenic, beryllium, and chromium in excess of 92 µgm/dscm, combined emissions, corrected to 7 percent oxygen;

(5) For carbon monoxide and hydrocarbons, either:

(i) Carbon monoxide in excess of 100 parts per million by volume, over an hourly rolling average (monitored continuously with a continuous emissions monitoring system), dry basis and corrected to 7 percent oxygen. If you elect to comply with this carbon monoxide standard rather than the hydrocarbon

standard under paragraph (a)(5)(ii) of this section, you must also document that, during the destruction and removal efficiency (DRE) test runs or their equivalent as provided by §63.1206(b)(7), hydrocarbons do not exceed 10 parts per million by volume during those runs, over an hourly rolling average (monitored continuously with a continuous emissions monitoring system), dry basis, corrected to 7 percent oxygen, and reported as propane; or

(ii) Hydrocarbons in excess of 10 parts per million by volume, over an hourly rolling average (monitored continuously with a continuous emissions monitoring system), dry basis, corrected to 7 percent oxygen, and reported as propane;

(6) Hydrogen chloride and chlorine gas (total chlorine) in excess of 32 parts per million by volume, combined emissions, expressed as a chloride (Cl^-) equivalent, dry basis and corrected to 7 percent oxygen; and

(7) Except as provided by paragraph (e) of this section, particulate matter in excess of 0.013 gr/dscf corrected to 7 percent oxygen.

(b) *Emission limits for new sources.* You must not discharge or cause combustion gases to be emitted into the atmosphere that contain:

(1)(i) Dioxins and furans in excess of 0.11 ng TEQ/dscm corrected to 7 percent oxygen for incinerators equipped with either a waste heat boiler or dry air pollution control system; or

(ii) Dioxins and furans in excess of 0.20 ng TEQ/dscm corrected to 7 percent oxygen for sources not equipped with either a waste heat boiler or dry air pollution control system;

(iii) A source equipped with a wet air pollution control system followed by a dry air pollution control system is not considered to be a dry air pollution control system, and a source equipped with a dry air pollution control system followed by a wet air pollution control system is considered to be a dry air pollution control system for purposes of this standard;

(2) Mercury in excess of 8.1 $\mu\text{g}/\text{dscm}$, corrected to 7 percent oxygen;

(3) Cadmium and lead in excess of 10 $\mu\text{g}/\text{dscm}$, combined emissions, corrected to 7 percent oxygen;

(4) Arsenic, beryllium, and chromium in excess of 23 $\mu\text{g}/\text{dscm}$, combined emissions, corrected to 7 percent oxygen;

(5) For carbon monoxide and hydrocarbons, either:

(i) Carbon monoxide in excess of 100 parts per million by volume, over an hourly rolling average (monitored continuously with a continuous emissions monitoring system), dry basis and corrected to 7 percent oxygen. If you elect to comply with this carbon monoxide standard rather than the hydrocarbon standard under paragraph (b)(5)(ii) of this section, you must also document that, during the destruction and removal efficiency (DRE) test runs or their equivalent as provided by §63.1206(b)(7), hydrocarbons do not exceed 10 parts per million by volume during those runs, over an hourly rolling average (monitored continuously with a continuous emissions monitoring system), dry basis, corrected to 7 percent oxygen, and reported as propane; or

(ii) Hydrocarbons in excess of 10 parts per million by volume, over an hourly rolling average (monitored continuously with a continuous emissions monitoring system), dry basis, corrected to 7 percent oxygen, and reported as propane;

(6) Hydrogen chloride and chlorine gas in excess of 21 parts per million by volume, combined emissions, expressed as a chloride (Cl⁻) equivalent, dry basis and corrected to 7 percent oxygen; and

(7) Except as provided by paragraph (e) of this section, particulate matter emissions in excess of 0.0016 gr/dscf corrected to 7 percent oxygen.

(c) *Destruction and removal efficiency (DRE) standard*—(1) *99.99% DRE*. Except as provided in paragraph (c)(2) of this section, you must achieve a destruction and removal efficiency (DRE) of 99.99% for each principle organic hazardous constituent (POHC) designated under paragraph (c)(3) of this section. You must calculate DRE for each POHC from the following equation:

$$\text{DRE} = [1 - (W_{\text{out}} / W_{\text{in}})] \times 100\%$$

Where:

W_{in} = mass feedrate of one POHC in a waste feedstream; and

W_{out} = mass emission rate of the same POHC present in exhaust emissions prior to release to the atmosphere.

(2) *99.9999% DRE*. If you burn the dioxin-listed hazardous wastes F020, F021, F022, F023, F026, or F027 (see §261.31 of this chapter), you must achieve a DRE of 99.9999% for each POHC that you designate under paragraph (c)(3) of this section. You must demonstrate this DRE performance on POHCs that are more difficult to incinerate than tetra-, penta-, and hexachlorodibenzo-*p*-dioxins and dibenzofurans. You must use the equation in paragraph (c)(1) of this section to calculate DRE for each POHC. In addition, you must notify the Administrator of your intent to incinerate hazardous wastes F020, F021, F022, F023, F026, or F027.

(3) *Principal organic hazardous constituent (POHC)*. (i) You must treat each POHC in the waste feed that you specify under paragraph (c)(3)(ii) of this section to the extent required by paragraphs (c)(1) and (c)(2) of this section.

(ii) You must specify one or more POHCs that are representative of the most difficult to destroy organic compounds in your hazardous waste feedstream. You must base this specification on the degree of difficulty of incineration of the organic constituents in the hazardous waste and on their concentration or mass in the hazardous waste feed, considering the results of hazardous waste analyses or other data and information.

(d) *Significant figures*. The emission limits provided by paragraphs (a) and (b) of this section are presented with two significant figures. Although you must perform intermediate calculations using at least three significant figures, you may round the resultant emission levels to two significant figures to document compliance.

(e) *Alternative to the particulate matter standard*—(1) *General*. In lieu of complying with the particulate matter standards of this section, you may elect to comply with the following alternative metal emission control requirement:

(2) *Alternative metal emission control requirements for existing incinerators*. (i) You must not discharge or cause combustion gases to be emitted into the atmosphere that contain cadmium, lead, and selenium in excess of 230 µgm/dscm, combined emissions, corrected to 7 percent oxygen; and,

(ii) You must not discharge or cause combustion gases to be emitted into the atmosphere that contain antimony, arsenic, beryllium, chromium, cobalt, manganese, and nickel in excess of 92 µgm/dscm, combined emissions, corrected to 7 percent oxygen.

(3) *Alternative metal emission control requirements for new incinerators.* (i) You must not discharge or cause combustion gases to be emitted into the atmosphere that contain cadmium, lead, and selenium in excess of 10 µgm/dscm, combined emissions, corrected to 7 percent oxygen; and,

(ii) You must not discharge or cause combustion gases to be emitted into the atmosphere that contain antimony, arsenic, beryllium, chromium, cobalt, manganese, and nickel in excess of 23 µgm/dscm, combined emissions, corrected to 7 percent oxygen.

(4) *Operating limits.* Semivolatile and low volatile metal operating parameter limits must be established to ensure compliance with the alternative emission limitations described in paragraphs (e)(2) and (e)(3) of this section pursuant to §63.1209(n), except that semivolatile metal feedrate limits apply to lead, cadmium, and selenium, combined, and low volatile metal feedrate limits apply to arsenic, beryllium, chromium, antimony, cobalt, manganese, and nickel, combined.

[70 FR 59570, Oct. 12, 2005, as amended at 73 FR 64097, Oct. 28, 2008]

 [Back to Top](#)

§63.1220 What are the replacement standards for hazardous waste burning cement kilns?

(a) *Emission and hazardous waste feed limits for existing sources.* You must not discharge or cause combustion gases to be emitted into the atmosphere or feed hazardous waste that contain:

(1) For dioxins and furans, either:

(i) Emissions in excess of 0.20 ng TEQ/dscm corrected to 7 percent oxygen; or

(ii) Emissions in excess of 0.40 ng TEQ/dscm corrected to 7 percent oxygen provided that the combustion gas temperature at the inlet to the initial dry particulate matter control device is 400 °F or lower based on the average of the test run average temperatures;

(2) For mercury, both:

(i) An average as-fired concentration of mercury in all hazardous waste feedstreams in excess of 3.0 parts per million by weight; and

(ii) Either:

(A) Emissions in excess of 120 µg/dscm, corrected to 7 percent oxygen, or

(B) A hazardous waste feed maximum theoretical emission concentration (MTEC) in excess of 120 µg/dscm;

(3) For cadmium and lead, both:

(i) Emissions in excess of 7.6×10^{-4} lbs combined emissions of cadmium and lead attributable to the hazardous waste per million Btu heat input from the hazardous waste; and

(ii) Emissions in excess of 330 µgm/dscm, combined emissions, corrected to 7 percent oxygen;

(4) For arsenic, beryllium, and chromium, both:

(i) Emissions in excess of 2.1×10^{-5} lbs combined emissions of arsenic, beryllium, and chromium attributable to the hazardous waste per million Btu heat input from the hazardous waste; and

(ii) Emissions in excess of 56 $\mu\text{gm/dscm}$, combined emissions, corrected to 7 percent oxygen;

(5) *Carbon monoxide and hydrocarbons.* (i) For kilns equipped with a by-pass duct or midkiln gas sampling system, either:

(A) Carbon monoxide in the by-pass duct or mid-kiln gas sampling system in excess of 100 parts per million by volume, over an hourly rolling average (monitored continuously with a continuous emissions monitoring system), dry basis and corrected to 7 percent oxygen. If you elect to comply with this carbon monoxide standard rather than the hydrocarbon standard under paragraph (a)(5)(i)(B) of this section, you must also document that, during the destruction and removal efficiency (DRE) test runs or their equivalent as provided by §63.1206(b)(7), hydrocarbons in the by-pass duct or mid-kiln gas sampling system do not exceed 10 parts per million by volume during those runs, over an hourly rolling average (monitored continuously with a continuous emissions monitoring system), dry basis, corrected to 7 percent oxygen, and reported as propane; or

(B) Hydrocarbons in the by-pass duct or midkiln gas sampling system in excess of 10 parts per million by volume, over an hourly rolling average (monitored continuously with a continuous emissions monitoring system), dry basis, corrected to 7 percent oxygen, and reported as propane;

(ii) For kilns not equipped with a by-pass duct or midkiln gas sampling system, either:

(A) Hydrocarbons in the main stack in excess of 20 parts per million by volume, over an hourly rolling average (monitored continuously with a continuous emissions monitoring system), dry basis, corrected to 7 percent oxygen, and reported as propane; or

(B) Carbon monoxide in the main stack in excess of 100 parts per million by volume, over an hourly rolling average (monitored continuously with a continuous emissions monitoring system), dry basis and corrected to 7 percent oxygen. If you elect to comply with this carbon monoxide standard rather than the hydrocarbon standard under paragraph (a)(5)(ii)(A) of this section, you also must document that, during the destruction and removal efficiency (DRE) test runs or their equivalent as provided by §63.1206(b)(7), hydrocarbons in the main stack do not exceed 20 parts per million by volume during those runs, over an hourly rolling average (monitored continuously with a continuous emissions monitoring system), dry basis, corrected to 7 percent oxygen, and reported as propane.

(6) Hydrogen chloride and chlorine gas in excess of 120 parts per million by volume, combined emissions, expressed as a chloride (Cl^-) equivalent, dry basis, corrected to 7 percent oxygen; and

(7) For particulate matter, both:

(i) Emissions in excess of 0.028 gr/dscf corrected to 7 percent oxygen; and

(ii) Opacity greater than 20 percent, unless your source is equipped with a bag leak detection system under §63.1206(c)(8) or a particulate matter detection system under §63.1206(c)(9).

(b) *Emission and hazardous waste feed limits for new sources.* You must not discharge or cause combustion gases to be emitted into the atmosphere or feed hazardous waste that contain:

(1) For dioxins and furans, either:

(i) Emissions in excess of 0.20 ng TEQ/dscm corrected to 7 percent oxygen; or

(ii) Emissions in excess of 0.40 ng TEQ/dscm corrected to 7 percent oxygen provided that the combustion gas temperature at the inlet to the initial dry particulate matter control device is 400 °F or lower based on the average of the test run average temperatures;

(2) For mercury, both:

(i) An average as-fired concentration of mercury in all hazardous waste feedstreams in excess of 1.9 parts per million by weight; and

(ii) Either:

(A) Emissions in excess of 120 µg/dscm, corrected to 7 percent oxygen, or

(B) A hazardous waste feed maximum theoretical emission concentration (MTEC) in excess of 120 µg/dscm;

(3) For cadmium and lead, both:

(i) Emissions in excess of 6.2×10^{-5} lbs combined emissions of cadmium and lead attributable to the hazardous waste per million Btu heat input from the hazardous waste; and

(ii) Emissions in excess of 180 µgm/dscm, combined emissions, corrected to 7 percent oxygen;

(4) For arsenic, beryllium, and chromium, both:

(i) Emissions in excess of 1.5×10^{-5} lbs combined emissions of arsenic, beryllium, and chromium attributable to the hazardous waste per million Btu heat input from the hazardous waste; and

(ii) Emissions in excess of 54 µgm/dscm, combined emissions, corrected to 7 percent oxygen;

(5) *Carbon monoxide and hydrocarbons.* (i) For kilns equipped with a by-pass duct or midkiln gas sampling system, carbon monoxide and hydrocarbons emissions are limited in both the bypass duct or midkiln gas sampling system and the main stack as follows:

(A) Emissions in the by-pass or midkiln gas sampling system are limited to either:

(1) Carbon monoxide in excess of 100 parts per million by volume, over an hourly rolling average (monitored continuously with a continuous emissions monitoring system), dry basis and corrected to 7 percent oxygen. If you elect to comply with this carbon monoxide standard rather than the hydrocarbon standard under paragraph (b)(5)(i)(A)(2) of this section, you also must document that, during the destruction and removal efficiency (DRE) test runs or their equivalent as provided by §63.1206(b)(7), hydrocarbons do not exceed 10 parts per million by volume during those runs, over an hourly rolling average (monitored continuously with a continuous emissions monitoring system), dry basis, corrected to 7 percent oxygen, and reported as propane; or

(2) Hydrocarbons in the by-pass duct or midkiln gas sampling system in excess of 10 parts per million by volume, over an hourly rolling average (monitored continuously with a continuous emissions monitoring system), dry basis, corrected to 7 percent oxygen, and reported as propane; and

(B) Hydrocarbons in the main stack are limited, if construction of the kiln commenced after April 19, 1996 at a plant site where a cement kiln (whether burning hazardous waste or not) did not previously

exist, to 50 parts per million by volume, over a 30-day block average (monitored continuously with a continuous monitoring system), dry basis, corrected to 7 percent oxygen, and reported as propane.

(ii) For kilns not equipped with a by-pass duct or midkiln gas sampling system, hydrocarbons and carbon monoxide are limited in the main stack to either:

(A) Hydrocarbons not exceeding 20 parts per million by volume, over an hourly rolling average (monitored continuously with a continuous emissions monitoring system), dry basis, corrected to 7 percent oxygen, and reported as propane; or

(B)(1) Carbon monoxide not exceeding 100 parts per million by volume, over an hourly rolling average (monitored continuously with a continuous emissions monitoring system), dry basis, corrected to 7 percent oxygen; and

(2) Hydrocarbons not exceeding 20 parts per million by volume, over an hourly rolling average (monitored continuously with a continuous monitoring system), dry basis, corrected to 7 percent oxygen, and reported as propane at any time during the destruction and removal efficiency (DRE) test runs or their equivalent as provided by §63.1206(b)(7); and

(3) If construction of the kiln commenced after April 19, 1996 at a plant site where a cement kiln (whether burning hazardous waste or not) did not previously exist, hydrocarbons are limited to 50 parts per million by volume, over a 30-day block average (monitored continuously with a continuous monitoring system), dry basis, corrected to 7 percent oxygen, and reported as propane.

(6) Hydrogen chloride and chlorine gas in excess of 86 parts per million by volume, combined emissions, expressed as a chloride (Cl^-) equivalent, dry basis and corrected to 7 percent oxygen; and

(7) For particulate matter, both:

(i) Emissions in excess of 0.0069 gr/dscf corrected to 7 percent oxygen; and

(ii) Opacity greater than 20 percent, unless your source is equipped with a bag leak detection system under §63.1206(c)(8) or a particulate matter detection system under §63.1206(c)(9).

(c) *Destruction and removal efficiency (DRE) standard*—(1) *99.99% DRE*. Except as provided in paragraph (c)(2) of this section, you must achieve a destruction and removal efficiency (DRE) of 99.99% for each principle organic hazardous constituent (POHC) designated under paragraph (c)(3) of this section. You must calculate DRE for each POHC from the following equation:

$$\text{DRE} = [1 - (W_{\text{out}} / W_{\text{in}})] \times 100\%$$

Where:

W_{in} = mass feedrate of one POHC in a waste feedstream; and

W_{out} = mass emission rate of the same POHC present in exhaust emissions prior to release to the atmosphere.

(2) *99.9999% DRE*. If you burn the dioxin-listed hazardous wastes F020, F021, F022, F023, F026, or F027 (see §261.31 of this chapter), you must achieve a DRE of 99.9999% for each POHC that you designate under paragraph (c)(3) of this section. You must demonstrate this DRE performance on POHCs that are more difficult to incinerate than tetra-, penta-, and hexachlorodibenzo-*p*-dioxins and dibenzofurans. You must use the equation in paragraph (c)(1) of this section to calculate DRE for each POHC. In addition, you must notify the Administrator of your intent to incinerate hazardous wastes F020, F021, F022, F023, F026, or F027.

(3) *Principal organic hazardous constituent (POHC)*. (i) You must treat each POHC in the waste feed that you specify under paragraph (c)(3)(ii) of this section to the extent required by paragraphs (c)(1) and (c)(2) of this section.

(ii) You must specify one or more POHCs that are representative of the most difficult to destroy organic compounds in your hazardous waste feedstream. You must base this specification on the degree of difficulty of incineration of the organic constituents in the hazardous waste and on their concentration or mass in the hazardous waste feed, considering the results of hazardous waste analyses or other data and information.

(d) *Cement kilns with in-line kiln raw mills*—(1) *General*. (i) You must conduct performance testing when the raw mill is on-line and when the mill is off-line to demonstrate compliance with the emission standards, and you must establish separate operating parameter limits under §63.1209 for each mode of operation, except as provided by paragraphs (d)(1)(iv) and (d)(1)(v) of this section.

(ii) You must document in the operating record each time you change from one mode of operation to the alternate mode and begin complying with the operating parameter limits for that alternate mode of operation.

(iii) You must calculate rolling averages for operating parameter limits as provided by §63.1209(q)(2).

(iv) If your in-line kiln raw mill has dual stacks, you may assume that the dioxin/furan emission levels in the by-pass stack and the operating parameter limits determined during performance testing of the by-pass stack when the raw mill is off-line are the same as when the mill is on-line.

(v) In lieu of conducting a performance test to demonstrate compliance with the dioxin/furan emission standards for the mode of operation when the raw mill is on-line, you may specify in the performance test workplan and Notification of Compliance the same operating parameter limits required under §63.1209(k) for the mode of operation when the raw mill is on-line as you establish during performance testing for the mode of operation when the raw mill is off-line.

(2) *Emissions averaging*. You may comply with the mercury, semivolatile metal, low volatile metal, and hydrogen chloride/chlorine gas emission standards on a time-weighted average basis under the following procedures:

(i) *Averaging methodology*. You must calculate the time-weighted average emission concentration with the following equation:

$$C_{\text{total}} = \{C_{\text{mill-off}} \times (T_{\text{mill-off}} / (T_{\text{mill-off}} + T_{\text{mill-on}}))\} + \{C_{\text{mill-on}} \times (T_{\text{mill-on}} / (T_{\text{mill-off}} + T_{\text{mill-on}}))\}$$

Where:

C_{total} = time-weighted average concentration of a regulated constituent considering both raw mill on time and off time;

$C_{\text{mill-off}}$ = average performance test concentration of regulated constituent with the raw mill off-line;

$C_{\text{mill-on}}$ = average performance test concentration of regulated constituent with the raw mill on-line;

$T_{\text{mill-off}}$ = time when kiln gases are not routed through the raw mill; and

$T_{\text{mill-on}}$ = time when kiln gases are routed through the raw mill.

(ii) *Compliance.* (A) If you use this emission averaging provision, you must document in the operating record compliance with the emission standards on an annual basis by using the equation provided by paragraph (d)(2) of this section.

(B) Compliance is based on one-year block averages beginning on the day you submit the initial notification of compliance.

(iii) *Notification.* (A) If you elect to document compliance with one or more emission standards using this emission averaging provision, you must notify the Administrator in the initial comprehensive performance test plan submitted under §63.1207(e).

(B) You must include historical raw mill operation data in the performance test plan to estimate future raw mill down-time and document in the performance test plan that estimated emissions and estimated raw mill down-time will not result in an exceedance of an emission standard on an annual basis.

(C) You must document in the notification of compliance submitted under §63.1207(j) that an emission standard will not be exceeded based on the documented emissions from the performance test and predicted raw mill down-time.

(e) *Preheater or preheater/precalciner kilns with dual stacks—(1) General.* You must conduct performance testing on each stack to demonstrate compliance with the emission standards, and you must establish operating parameter limits under §63.1209 for each stack, except as provided by paragraph (d)(1)(iv) of this section for dioxin/furan emissions testing and operating parameter limits for the by-pass stack of in-line raw mills.

(2) *Emissions averaging.* You may comply with the mercury, semivolatile metal, low volatile metal, and hydrogen chloride/chlorine gas emission standards specified in this section on a gas flowrate-weighted average basis under the following procedures:

(i) *Averaging methodology.* You must calculate the gas flowrate-weighted average emission concentration using the following equation:

$$C_{\text{tot}} = \{C_{\text{main}} \times (Q_{\text{main}} / (Q_{\text{main}} + Q_{\text{bypass}}))\} + \{C_{\text{bypass}} \times (Q_{\text{bypass}} / (Q_{\text{main}} + Q_{\text{bypass}}))\}$$

Where:

C_{tot} = gas flowrate-weighted average concentration of the regulated constituent;

C_{main} = average performance test concentration demonstrated in the main stack;

C_{bypass} = average performance test concentration demonstrated in the bypass stack;

Q_{main} = volumetric flowrate of main stack effluent gas; and

Q_{bypass} = volumetric flowrate of bypass effluent gas.

(ii) *Compliance.* (A) You must demonstrate compliance with the emission standard(s) using the emission concentrations determined from the performance tests and the equation provided by paragraph (e)(1) of this section; and

(B) You must develop operating parameter limits for bypass stack and main stack flowrates that ensure the emission concentrations calculated with the equation in paragraph (e)(1) of this section do not exceed the emission standards on a 12-hour rolling average basis. You must include these flowrate limits in the Notification of Compliance.

(iii) *Notification*. If you elect to document compliance under this emissions averaging provision, you must:

(A) Notify the Administrator in the initial comprehensive performance test plan submitted under §63.1207(e). The performance test plan must include, at a minimum, information describing the flowrate limits established under paragraph (e)(2)(ii)(B) of this section; and

(B) Document in the Notification of Compliance submitted under §63.1207(j) the demonstrated gas flowrate-weighted average emissions that you calculate with the equation provided by paragraph (e)(2) of this section.

(f) *Significant figures*. The emission limits provided by paragraphs (a) and (b) of this section are presented with two significant figures. Although you must perform intermediate calculations using at least three significant figures, you may round the resultant emission levels to two significant figures to document compliance.

(g) [Reserved]

(h) When you comply with the particulate matter requirements of paragraphs (a)(7) or (b)(7) of this section, you are exempt from the New Source Performance Standard for particulate matter and opacity under §60.60 of this chapter.

[70 FR 59571, Oct. 12, 2005, as amended at 71 FR 62394, Oct. 25, 2006; 73 FR 18983, Apr. 8, 2008; 73 FR 64097, Oct. 28, 2008]

 [Back to Top](#)

§63.1221 What are the replacement standards for hazardous waste burning lightweight aggregate kilns?

(a) *Emission and hazardous waste feed limits for existing sources*. You must not discharge or cause combustion gases to be emitted into the atmosphere or feed hazardous waste that contain:

(1) For dioxins and furans, either:

(i) Emissions in excess of 0.20 ng TEQ/dscm corrected to 7 percent oxygen; or

(ii) Rapid quench of the combustion gas temperature at the exit of the (last) combustion chamber (or exit of any waste heat recovery system that immediately follows the last combustion chamber) to 400 °F or lower based on the average of the test run average temperatures. You must also notify in writing the RCRA authority that you are complying with this option;

(2) For mercury, either:

(i) Emissions in excess of 120 µgm/dscm, corrected to 7 percent oxygen; or

(ii) A hazardous waste feedrate corresponding to a maximum theoretical emission concentration (MTEC) in excess of 120 µgm/dscm;

(3) For cadmium and lead, both:

(i) Emissions in excess of 3.0×10^{-4} lbs combined emissions of cadmium and lead attributable to the hazardous waste per million Btu heat input from the hazardous waste; and

(ii) Emissions in excess of 250 $\mu\text{gm/dscm}$, combined emissions, corrected to 7 percent oxygen;

(4) For arsenic, beryllium, and chromium, both:

(i) In excess of 9.5×10^{-5} lbs combined emissions of arsenic, beryllium, and chromium attributable to the hazardous waste per million Btu heat input from the hazardous waste;

(ii) Emissions in excess of 110 $\mu\text{gm/dscm}$, combined emissions, corrected to 7 percent oxygen;

(5) *Carbon monoxide and hydrocarbons.* (i) Carbon monoxide in excess of 100 parts per million by volume, over an hourly rolling average (monitored continuously with a continuous emissions monitoring system), dry basis and corrected to 7 percent oxygen. If you elect to comply with this carbon monoxide standard rather than the hydrocarbon standard under paragraph (a)(5)(ii) of this section, you also must document that, during the destruction and removal efficiency (DRE) test runs or their equivalent as provided by §63.1206(b)(7), hydrocarbons do not exceed 20 parts per million by volume during those runs, over an hourly rolling average (monitored continuously with a continuous emissions monitoring system), dry basis, corrected to 7 percent oxygen, and reported as propane; or

(ii) Hydrocarbons in excess of 20 parts per million by volume, over an hourly rolling average, dry basis, corrected to 7 percent oxygen, and reported as propane;

(6) Hydrogen chloride and chlorine gas in excess of 600 parts per million by volume, combined emissions, expressed as a chloride (Cl^{-}) equivalent, dry basis and corrected to 7 percent oxygen; and

(7) Particulate matter emissions in excess of 0.025 gr/dscf, corrected to 7 percent oxygen.

(b) *Emission and hazardous waste feed limits for new sources.* You must not discharge or cause combustion gases to be emitted into the atmosphere or feed hazardous waste that contain:

(1) For dioxins and furans, either:

(i) Emissions in excess of 0.20 ng TEQ/dscm corrected to 7 percent oxygen; or

(ii) Rapid quench of the combustion gas temperature at the exit of the (last) combustion chamber (or exit of any waste heat recovery system that immediately follows the last combustion chamber) to 400 °F or lower based on the average of the test run average temperatures. You must also notify in writing the RCRA authority that you are complying with this option;

(2) For mercury, either:

(i) Emissions in excess of 120 $\mu\text{gm/dscm}$, corrected to 7 percent oxygen; or

(ii) A hazardous waste feedrate corresponding to a maximum theoretical emission concentration (MTEC) in excess of 120 $\mu\text{gm/dscm}$;

(3) For cadmium and lead, both:

(i) Emissions in excess of 3.7×10^{-5} lbs combined emissions of cadmium and lead attributable to the hazardous waste per million Btu heat input from the hazardous waste; and

(ii) Emissions in excess of 43 µgm/dscm, combined emissions, corrected to 7 percent oxygen;

(4) For arsenic, beryllium, and chromium, both:

(i) In excess of 3.3×10^{-5} lbs combined emissions of arsenic, beryllium, and chromium attributable to the hazardous waste per million Btu heat input from the hazardous waste;

(ii) Emissions in excess of 110 µgm/dscm, combined emissions, corrected to 7 percent oxygen;

(5) *Carbon monoxide and hydrocarbons.* (i) Carbon monoxide in excess of 100 parts per million by volume, over an hourly rolling average (monitored continuously with a continuous emissions monitoring system), dry basis and corrected to 7 percent oxygen. If you elect to comply with this carbon monoxide standard rather than the hydrocarbon standard under paragraph (b)(5)(ii) of this section, you also must document that, during the destruction and removal efficiency (DRE) test runs or their equivalent as provided by §63.1206(b)(7), hydrocarbons do not exceed 20 parts per million by volume during those runs, over an hourly rolling average (monitored continuously with a continuous emissions monitoring system), dry basis, corrected to 7 percent oxygen, and reported as propane; or

(ii) Hydrocarbons in excess of 20 parts per million by volume, over an hourly rolling average, dry basis, corrected to 7 percent oxygen, and reported as propane;

(6) Hydrogen chloride and chlorine gas in excess of 600 parts per million by volume, combined emissions, expressed as a chloride (Cl⁻) equivalent, dry basis and corrected to 7 percent oxygen; and

(7) Particulate matter emissions in excess of 0.0098 gr/dscf corrected to 7 percent oxygen.

(c) *Destruction and removal efficiency (DRE) standard—(1) 99.99% DRE.* Except as provided in paragraph (c)(2) of this section, you must achieve a destruction and removal efficiency (DRE) of 99.99% for each principal organic hazardous constituent (POHC) designated under paragraph (c)(3) of this section. You must calculate DRE for each POHC from the following equation:

$$\text{DRE} = [1 - (W_{\text{out}} / W_{\text{in}})] \times 100\%$$

Where:

W_{in} = mass feedrate of one POHC in a waste feedstream; and

W_{out} = mass emission rate of the same POHC present in exhaust emissions prior to release to the atmosphere.

(2) *99.9999% DRE.* If you burn the dioxin-listed hazardous wastes F020, F021, F022, F023, F026, or F027 (see §261.31 of this chapter), you must achieve a destruction and removal efficiency (DRE) of 99.9999% for each POHC that you designate under paragraph (c)(3) of this section. You must demonstrate this DRE performance on POHCs that are more difficult to incinerate than tetra-, penta-, and hexachlorodibenzo-dioxins and dibenzofurans. You must use the equation in paragraph (c)(1) of this section to calculate DRE for each POHC. In addition, you must notify the Administrator of your intent to burn hazardous wastes F020, F021, F022, F023, F026, or F027.

(3) *Principal organic hazardous constituents (POHCs).* (i) You must treat each POHC in the waste feed that you specify under paragraph (c)(3)(ii) of this section to the extent required by paragraphs (c)(1) and (c)(2) of this section.

(ii) You must specify one or more POHCs that are representative of the most difficult to destroy organic compounds in your hazardous waste feedstream. You must base this specification on the degree of difficulty of incineration of the organic constituents in the hazardous waste and on their concentration or

mass in the hazardous waste feed, considering the results of hazardous waste analyses or other data and information.

(d) *Significant figures.* The emission limits provided by paragraphs (a) and (b) of this section are presented with two significant figures. Although you must perform intermediate calculations using at least three significant figures, you may round the resultant emission levels to two significant figures to document compliance.

[70 FR 59574, Oct. 12, 2005]

[↑ Back to Top](#)

Table 1 to Subpart EEE of Part 63—General Provisions Applicable to Subpart EEE

Reference	Applies to subpart EEE	Explanation
63.1	Yes.	
63.2	Yes.	
63.3	Yes.	
63.4	Yes.	
63.5	Yes.	
63.6(a), (b), (c), (d), and (e)	Yes.	
63.6(f)	Yes	Except that the performance test requirements of Sec. 63.1207 apply instead of §63.6(f)(2)(iii)(B).
63.6(g) and (h)	Yes.	
63.6(i)	Yes	Section 63.1213 specifies that the compliance date may also be extended for inability to install necessary emission control equipment by the compliance date because of implementation of pollution prevention or waste minimization controls.
63.6(j)	Yes.	
63.7(a)	Yes	Except §63.1207(e)(3) allows you to petition the Administrator under §63.7(h) to provide an extension of time to conduct a performance test.
63.7(b)	Yes	Except §63.1207(e) requires you to submit the site-specific test plan for approval at least one year before the comprehensive performance test is scheduled to begin.
63.7(c)	Yes	Except §63.1207(e) requires you to submit the site-specific test plan (including the quality assurance provisions under §63.7(c)) for approval

		at least one year before the comprehensive performance test is scheduled to begin.
63.7(d)	Yes.	
63.7(e)	Yes	Except §63.1207 prescribes operations during performance testing and §63.1209 specifies operating limits that will be established during performance testing (such that testing is likely to be representative of the extreme range of normal performance).
63.7(f)	Yes.	
63.7(g)	Yes	Except §63.1207(j) requiring that you submit the results of the performance test (and the notification of compliance) within 90 days of completing the test, unless the Administrator grants a time extension, applies instead of §63.7(g)(1).
63.7(h)	Yes	Except §63.1207(c)(2) allows data in lieu of the initial comprehensive performance test, and §63.1207(m) provides a waiver of certain performance tests. You must submit requests for these waivers with the site-specific test plan.
63.8(a) and (b)	Yes.	
63.8(c)	Yes	Except: (1) §63.1211(c) that requires you to install, calibrate, and operate CMS by the compliance date applies instead of §63.8(c)(3); and (2) the performance specifications for CO, HC, and O ₂ CEMS in subpart B, of this chapter requiring that the detectors measure the sample concentration at least once every 15 seconds for calculating an average emission level once every 60 seconds apply instead of §63.8(c)(4)(ii).
63.8(d)	Yes.	
63.8(e)	Yes	Except §63.1207(e) requiring you to submit the site-specific comprehensive performance test plan and the CMS performance evaluation test plan for approval at least one year prior to the planned test date applies instead of §§63.8(e)(2) and (3)(iii).
63.8(f) and (g)	Yes.	
63.9(a)	Yes.	
63.9(b)	Yes	<i>Note:</i> Section 63.9(b)(1)(ii) pertains to notification requirements for area sources that become a major source, and §63.9(b)(2)(v) requires a major source determination. Although area sources are subject to all provisions of this subpart (Subpart EEE), these sections nonetheless apply because the major source determination may affect the applicability of part 63 standards or title V permit requirements to other

		sources (i.e., other than a hazardous waste combustor) of hazardous air pollutants at the facility.
63.9(c) and (d)	Yes.	
63.9(e)	Yes	Except §63.1207(e) which requires you to submit the comprehensive performance test plan for approval one year prior to the planned performance test date applies instead of §63.9(e).
63.9(f)	Yes	Section 63.9(f) applies if you are allowed under §63.1209(a)(1)(v) to use visible determination of opacity for compliance in lieu of a COMS.
63.9(g)	Yes	Except §63.9(g)(2) pertaining to COMS does not apply.
63.9(h)	Yes	Except §63.1207(j) requiring you to submit the notification of compliance within 90 days of completing a performance test unless the Administrator grants a time extension applies instead of §63.9(h)(2)(iii). Note: Even though area sources are subject to this subpart, the major source determination required by §63.9(h)(2)(i)(E) is applicable to hazardous waste combustors for the reasons discussed above.
63.9(i) and (j)	Yes.	
63.10	Yes	Except reports of performance test results required under §63.10(d)(2) may be submitted up to 90 days after completion of the test.
63.11	No.	
63.12-63.15	Yes.	

[67 FR 6994, Feb. 14, 2002]

[↑ Back to Top](#)

Appendix to Subpart EEE of Part 63—Quality Assurance Procedures for Continuous Emissions Monitors Used for Hazardous Waste Combustors

1. Applicability and Principle

1.1 **Applicability.** These quality assurance requirements are used to evaluate the effectiveness of quality control (QC) and quality assurance (QA) procedures and the quality of data produced by continuous emission monitoring systems (CEMS) that are used for determining compliance with the emission standards on a continuous basis as specified in the applicable regulation. The QA procedures specified by these requirements represent the minimum requirements necessary for the control and assessment of the quality of CEMS data used to demonstrate compliance with the emission standards provided under this subpart EEE of part 63. Owners and operators must meet these minimum requirements and are encouraged to develop and implement a more extensive QA program. These requirements supersede those found in part 60, Appendix F, of this chapter. Appendix F does not apply to hazardous waste-burning devices.

1.2 Principle. The QA procedures consist of two distinct and equally important functions. One function is the assessment of the quality of the CEMS data by estimating accuracy. The other function is the control and improvement of the quality of the CEMS data by implementing QC policies and corrective actions. These two functions form a control loop. When the assessment function indicates that the data quality is inadequate, the source must immediately stop burning hazardous waste. The CEM data control effort must be increased until the data quality is acceptable before hazardous waste burning can resume.

a. In order to provide uniformity in the assessment and reporting of data quality, this procedure explicitly specifies the assessment methods for response drift and accuracy. The methods are based on procedures included in the applicable performance specifications provided in appendix B to part 60 of this chapter. These procedures also require the analysis of the EPA audit samples concurrent with certain reference method (RM) analyses as specified in the applicable RM's.

b. Because the control and corrective action function encompasses a variety of policies, specifications, standards, and corrective measures, this procedure treats QC requirements in general terms to allow each source owner or operator to develop a QC system that is most effective and efficient for the circumstances.

2. Definitions

2.1 *Continuous Emission Monitoring System (CEMS)*. The total equipment required for the determination of a pollutant concentration. The system consists of the following major subsystems:

2.1.1 *Sample Interface*. That portion of the CEMS used for one or more of the following: sample acquisition, sample transport, and sample conditioning, or protection of the monitor from the effects of the stack effluent.

2.1.2 *Pollutant Analyzer*. That portion of the CEMS that senses the pollutant concentration and generates a proportional output.

2.1.3 *Diluent Analyzer*. That portion of the CEMS that senses the diluent gas (O₂) and generates an output proportional to the gas concentration.

2.1.4 *Data Recorder*. That portion of the CEMS that provides a permanent record of the analyzer output. The data recorder may provide automatic data reduction and CEMS control capabilities.

2.2 *Relative Accuracy (RA)*. The absolute mean difference between the pollutant concentration determined by the CEMS and the value determined by the reference method (RM) plus the 2.5 percent error confidence coefficient of a series of test divided by the mean of the RM tests or the applicable emission limit.

2.3 *Calibration Drift (CD)*. The difference in the CEMS output readings from the established reference value after a stated period of operation during which no unscheduled maintenance, repair, or adjustment took place.

2.4 *Zero Drift (ZD)*. The difference in CEMS output readings at the zero pollutant level after a stated period of operation during which no unscheduled maintenance, repair, or adjustment took place.

2.5 *Calibration Standard*. Calibration standards produce a known and unchanging response when presented to the pollutant analyzer portion of the CEMS, and are used to calibrate the drift or response of the analyzer.

2.6 *Relative Accuracy Test Audit (RATA)*. Comparison of CEMS measurements to reference method measurements in order to evaluate relative accuracy following procedures and specification given in the appropriate performance specification.

2.7 *Absolute Calibration Audit (ACA)*. Equivalent to calibration error (CE) test defined in the appropriate performance specification using NIST traceable calibration standards to challenge the CEMS and assess accuracy.

2.8 *Rolling Average*. The average emissions, based on some (specified) time period, calculated every minute from a one-minute average of four measurements taken at 15-second intervals.

3. QA/QC Requirements

3.1 QC Requirements. a. Each owner or operator must develop and implement a QC program. At a minimum, each QC program must include written procedures describing in detail complete, step-by-step procedures and operations for the following activities.

1. Checks for component failures, leaks, and other abnormal conditions.
2. Calibration of CEMS.
3. CD determination and adjustment of CEMS.
4. Integration of CEMS with the automatic waste feed cutoff (AWFCO) system.
5. Preventive Maintenance of CEMS (including spare parts inventory).
6. Data recording, calculations, and reporting.
7. Checks of record keeping.
8. Accuracy audit procedures, including sampling and analysis methods.
9. Program of corrective action for malfunctioning CEMS.
10. Operator training and certification.
11. Maintaining and ensuring current certification or naming of cylinder gasses, metal solutions, and particulate samples used for audit and accuracy tests, daily checks, and calibrations.

b. Whenever excessive inaccuracies occur for two consecutive quarters, the current written procedures must be revised or the CEMS modified or replaced to correct the deficiency causing the excessive inaccuracies. These written procedures must be kept on record and available for inspection by the enforcement agency.

3.2 QA Requirements. Each source owner or operator must develop and implement a QA plan that includes, at a minimum, the following.

1. QA responsibilities (including maintaining records, preparing reports, reviewing reports).
2. Schedules for the daily checks, periodic audits, and preventive maintenance.

3. Check lists and data sheets.
4. Preventive maintenance procedures.
5. Description of the media, format, and location of all records and reports.
6. Provisions for a review of the CEMS data at least once a year. Based on the results of the review, the owner or operator must revise or update the QA plan, if necessary.

4. CD and ZD Assessment and Daily System Audit

4.1 *CD and ZD Requirement.* Owners and operators must check, record, and quantify the ZD and the CD at least once daily (approximately 24 hours) in accordance with the method prescribed by the manufacturer. The CEMS calibration must, at a minimum, be adjusted whenever the daily ZD or CD exceeds the limits in the Performance Specifications. If, on any given ZD and/or CD check the ZD and/or CD exceed(s) two times the limits in the Performance Specifications, or if the cumulative adjustment to the ZD and/or CD (see Section 4.2) exceed(s) three times the limits in the Performance Specifications, hazardous waste burning must immediately cease and the CEMS must be serviced and recalibrated. Hazardous waste burning cannot resume until the owner or operator documents that the CEMS is in compliance with the Performance Specifications by carrying out an ACA.

4.2 *Recording Requirements for Automatic ZD and CD Adjusting Monitors.* Monitors that automatically adjust the data to the corrected calibration values must record the unadjusted concentration measurement prior to resetting the calibration, if performed, or record the amount of the adjustment.

4.3 *Daily System Audit.* The audit must include a review of the calibration check data, an inspection of the recording system, an inspection of the control panel warning lights, and an inspection of the sample transport and interface system (e.g., flowmeters, filters, etc.) as appropriate.

4.4 *Data Recording and Reporting.* All measurements from the CEMS must be retained in the operating record for at least 5 years.

5. Performance Evaluation for CO, O₂, and HC CEMS

Carbon Monoxide (CO), Oxygen (O₂), and Hydrocarbon (HC) CEMS. An Absolute Calibration Audit (ACA) must be conducted quarterly, and a Relative Accuracy Test Audit (RATA) (if applicable, see sections 5.1 and 5.2) must be conducted yearly. An Interference Response Tests must be performed whenever an ACA or a RATA is conducted. When a performance test is also required under §63.1207 to document compliance with emission standards, the RATA must coincide with the performance test. The audits must be conducted as follows.

5.1 *Relative Accuracy Test Audit (RATA).* This requirement applies to O₂ and CO CEMS. The RATA must be conducted at least yearly. Conduct the RATA as described in the RA test procedure (or alternate procedures section) described in the applicable Performance Specifications. In addition, analyze the appropriate performance audit samples received from the EPA as described in the applicable sampling methods.

5.2 *Absolute Calibration Audit (ACA).* The ACA must be conducted at least quarterly except in a quarter when a RATA (if applicable, see section 5.1) is conducted instead. Conduct an ACA as described in the calibration error (CE) test procedure described in the applicable Performance Specifications.

5.3 *Interference Response Test.* The interference response test must be conducted whenever an ACA or RATA is conducted. Conduct an interference response test as described in the applicable Performance Specifications.

5.4 *Excessive Audit Inaccuracy.* If the RA from the RATA or the CE from the ACA exceeds the criteria in the applicable Performance Specifications, hazardous waste burning must cease immediately. Hazardous waste burning cannot resume until the owner or operator takes corrective measures and audit the CEMS with a RATA to document that the CEMS is operating within the specifications.

6. Other Requirements

6.1 *Performance Specifications.* CEMS used by owners and operators of HWCs must comply with the following performance specifications in appendix B to part 60 of this chapter:

TABLE I: PERFORMANCE SPECIFICATIONS FOR CEMS

CEMS	Performance specification
Carbon monoxide	4B
Oxygen	4B
Total hydrocarbons	8A

6.2 *Downtime due to Calibration.* Facilities may continue to burn hazardous waste for a maximum of 20 minutes while calibrating the CEMS. If all CEMS are calibrated at once, the facility must have twenty minutes to calibrate all the CEMS. If CEMS are calibrated individually, the facility must have twenty minutes to calibrate each CEMS. If the CEMS are calibrated individually, other CEMS must be operational while the individual CEMS is being calibrated.

6.3 Span of the CEMS.

6.3.1 *CO CEMS.* The CO CEM must have two ranges, a low range with a span of 200 ppmv and a high range with a span of 3000 ppmv at an oxygen correction factor of 1. A one-range CEM may be used, but it must meet the performance specifications for the low range in the specified span of the low range.

6.3.2 *O₂ CEMS.* The O₂ CEM must have a span of 25 percent. The span may be higher than 25 percent if the O₂ concentration at the sampling point is greater than 25 percent.

6.3.3 *HC CEMS.* The HC CEM must have a span of 100 ppmv, expressed as propane, at an oxygen correction factor of 1.

6.3.4 *CEMS Span Values.* When the Oxygen Correction Factor is Greater than 2. When an owner or operator installs a CEMS at a location of high ambient air dilution, i.e., where the maximum oxygen correction factor as determined by the permitting agency is greater than 2, the owner or operator must install a CEM with a lower span(s), proportionate to the larger oxygen correction factor, than those specified above.

6.3.5 *Use of Alternative Spans.* Owner or operators may request approval to use alternative spans and ranges to those specified. Alternate spans must be approved in writing in advance by the Administrator. In considering approval of alternative spans and ranges, the Administrator will consider that measurements beyond the span will be recorded as values at the maximum span for purposes of calculating rolling averages.

6.3.6 *Documentation of Span Values.* The span value must be documented by the CEMS manufacturer with laboratory data.

6.4.1 *Moisture Correction.* Method 4 of appendix A, part 60 of this chapter, must be used to determine moisture content of the stack gasses.

6.4.2 *Oxygen Correction Factor.* Measured pollutant levels must be corrected for the amount of oxygen in the stack according to the following formula:

$$P_c = P_m \times 14 / (E - Y)$$

[View or download PDF](#)

Where:

P_c = concentration of the pollutant or standard corrected to 7 percent oxygen, dry basis;

P_m = measured concentration of the pollutant, dry basis;

E = volume fraction of oxygen in the combustion air fed into the device, on a dry basis (normally 21 percent or 0.21 if only air is fed);

Y = measured fraction of oxygen on a dry basis at the sampling point.

The oxygen correction factor is:

$$OCF = 14 / (E - Y)$$

[View or download PDF](#)

6.4.3 *Temperature Correction.* Correction values for temperature are obtainable from standard reference materials.

6.5 *Rolling Average.* A rolling average is the arithmetic average of all one-minute averages over the averaging period.

6.5.1 *One-Minute Average for CO and HHC CEMS.* One-minute averages are the arithmetic average of the four most recent 15-second observations and must be calculated using the following equation:

$$\bar{c} = \sum_{i=1}^4 \frac{c_i}{4}$$

[View or download PDF](#)

Where:

\bar{c} = the one minute average

c_i = a fifteen-second observation from the CEM

Fifteen second observations must not be rounded or smoothed. Fifteen-second observations may be disregarded only as a result of a failure in the CEMS and allowed in the source's quality assurance plan at the time of the CEMS failure. One-minute averages must not be rounded, smoothed, or disregarded.

6.5.2 Ten Minute Rolling Average Equation. The ten minute rolling average must be calculated using the following equation:

$$C_{RA} = \sum_{i=1}^{10} \frac{\bar{c}_i}{10}$$

[View or download PDF](#)

Where:

C_{RA} = The concentration of the standard, expressed as a rolling average

\bar{c}_i = a one minute average

6.5.3 *Hourly Rolling Average Equation for CO and THC CEMS and Operating Parameter Limits.* The rolling average, based on a specific number integer of hours, must be calculated using the following equation:

$$C_{RA} = \sum_{i=1}^{60} \frac{\bar{c}_i}{60}$$

[View or download PDF](#)

Where:

C_{RA} = The concentration of the standard, expressed as a rolling average

\bar{c}_i = a one minute average

6.5.4 Averaging Periods for CEMS other than CO and THC. The averaging period for CEMS other than CO and THC CEMS must be calculated as a rolling average of all one-hour values over the averaging period. An hourly average is comprised of 4 measurements taken at equally spaced time intervals, or at most every 15 minutes. Fewer than 4 measurements might be available within an hour for reasons such as facility downtime or CEMS calibration. If at least two measurements (30 minutes of data) are available, an hourly average must be calculated. The n -hour rolling average is calculated by averaging the n most recent hourly averages.

6.6 Units of the Standards for the Purposes of Recording and Reporting Emissions. Emissions must be recorded and reported expressed after correcting for oxygen, temperature, and moisture. Emissions must be reported in metric, but may also be reported in the English system of units, at 7 percent oxygen, 20 °C, and on a dry basis.

6.7 Rounding and Significant Figures. Emissions must be rounded to two significant figures using ASTM procedure E-29-90 or its successor. Rounding must be avoided prior to rounding for the reported value.

7. Bibliography

1. 40 CFR part 60, appendix F, "Quality Assurance Procedures: Procedure 1. Quality Assurance Requirements for Gas continuous Emission Monitoring Systems Used For Compliance Determination".

[64 FR 53038, Sept. 30, 1999, as amended at 65 FR 42301, July 10, 2000]

 [Back to Top](#)

Appendix M

Title 40: Protection of Environment

PART 63—NATIONAL EMISSION STANDARDS FOR HAZARDOUS AIR POLLUTANTS FOR SOURCE CATEGORIES
(CONTINUED)

Subpart FFFF—National Emission Standards for Hazardous Air Pollutants: Miscellaneous Organic Chemical Manufacturing

Contents

WHAT THIS SUBPART COVERS

- [§63.2430 What is the purpose of this subpart?](#)
- [§63.2435 Am I subject to the requirements in this subpart?](#)
- [§63.2440 What parts of my plant does this subpart cover?](#)

COMPLIANCE DATES

- [§63.2445 When do I have to comply with this subpart?](#)

EMISSION LIMITS, WORK PRACTICE STANDARDS, AND COMPLIANCE REQUIREMENTS

- [§63.2450 What are my general requirements for complying with this subpart?](#)
- [§63.2455 What requirements must I meet for continuous process vents?](#)
- [§63.2460 What requirements must I meet for batch process vents?](#)
- [§63.2465 What requirements must I meet for process vents that emit hydrogen halide and halogen HAP or HAP metals?](#)
- [§63.2470 What requirements must I meet for storage tanks?](#)
- [§63.2475 What requirements must I meet for transfer racks?](#)
- [§63.2480 What requirements must I meet for equipment leaks?](#)
- [§63.2485 What requirements must I meet for wastewater streams and liquid streams in open systems within an MCPU?](#)
- [§63.2490 What requirements must I meet for heat exchange systems?](#)

ALTERNATIVE MEANS OF COMPLIANCE

- [§63.2495 How do I comply with the pollution prevention standard?](#)
- [§63.2500 How do I comply with emissions averaging?](#)
- [§63.2505 How do I comply with the alternative standard?](#)

NOTIFICATION, REPORTS, AND RECORDS

- [§63.2515 What notifications must I submit and when?](#)
- [§63.2520 What reports must I submit and when?](#)
- [§63.2525 What records must I keep?](#)

OTHER REQUIREMENTS AND INFORMATION

- [§63.2535 What compliance options do I have if part of my plant is subject to both this subpart and another subpart?](#)
- [§63.2540 What parts of the General Provisions apply to me?](#)
- [§63.2545 Who implements and enforces this subpart?](#)
- [§63.2550 What definitions apply to this subpart?](#)
- [Table 1 to Subpart FFFF of Part 63—Emission Limits and Work Practice Standards for Continuous Process Vents](#)
- [Table 2 to Subpart FFFF of Part 63—Emission Limits and Work Practice Standards for Batch Process Vents](#)
- [Table 3 to Subpart FFFF of Part 63—Emission Limits for Hydrogen Halide and Halogen HAP Emissions or HAP Metals Emissions From Process Vents](#)

[Table 4 to Subpart FFFF of Part 63—Emission Limits for Storage Tanks](#)
[Table 5 to Subpart FFFF of Part 63—Emission Limits and Work Practice Standards for Transfer Racks](#)
[Table 6 to Subpart FFFF of Part 63—Requirements for Equipment Leaks](#)
[Table 7 to Subpart FFFF of Part 63—Requirements for Wastewater Streams and Liquid Streams in Open Systems Within an MCPU](#)
[Table 8 to Subpart FFFF of Part 63—Partially Soluble Hazardous Air Pollutants](#)
[Table 9 to Subpart FFFF of Part 63—Soluble Hazardous Air Pollutants](#)
[Table 10 to Subpart FFFF of Part 63—Work Practice Standards for Heat Exchange Systems](#)
[Table 11 to Subpart FFFF of Part 63—Requirements for Reports](#)
[Table 12 to Subpart FFFF of Part 63—Applicability of General Provisions to Subpart FFFF](#)

SOURCE: 68 FR 63888, Nov. 10, 2003, unless otherwise noted.

[↑ Back to Top](#)

WHAT THIS SUBPART COVERS

[↑ Back to Top](#)

§63.2430 What is the purpose of this subpart?

This subpart establishes national emission standards for hazardous air pollutants (NESHAP) for miscellaneous organic chemical manufacturing. This subpart also establishes requirements to demonstrate initial and continuous compliance with the emission limits, operating limits, and work practice standards.

[↑ Back to Top](#)

§63.2435 Am I subject to the requirements in this subpart?

(a) You are subject to the requirements in this subpart if you own or operate miscellaneous organic chemical manufacturing process units (MCPU) that are located at, or are part of, a major source of hazardous air pollutants (HAP) emissions as defined in section 112(a) of the Clean Air Act (CAA).

(b) An MCPU includes equipment necessary to operate a miscellaneous organic chemical manufacturing process, as defined in §63.2550, that satisfies all of the conditions specified in paragraphs (b)(1) through (3) of this section. An MCPU also includes any assigned storage tanks and transfer racks; equipment in open systems that is used to convey or store water having the same concentration and flow characteristics as wastewater; and components such as pumps, compressors, agitators, pressure relief devices, sampling connection systems, open-ended valves or lines, valves, connectors, and instrumentation systems that are used to manufacture any material or family of materials described in paragraphs (b)(1)(i) through (v) of this section.

(1) The MCPU produces material or family of materials that is described in paragraph (b)(1)(i), (ii), (iii), (iv), or (v) of this section.

(i) An organic chemical(s) classified using the 1987 version of SIC code 282, 283, 284, 285, 286, 287, 289, or 386, except as provided in paragraph (c)(5) of this section.

(ii) An organic chemical(s) classified using the 1997 version of NAICS code 325, except as provided in paragraph (c)(5) of this section.

(iii) Quaternary ammonium compounds and ammonium sulfate produced with caprolactam.

(iv) Hydrazine.

(v) Organic solvents classified in any of the SIC or NAICS codes listed in paragraph (b)(1)(i) or (ii) of this section that are recovered using nondedicated solvent recovery operations.

(2) The MCPU processes, uses, or generates any of the organic HAP listed in section 112(b) of the CAA or hydrogen halide and halogen HAP, as defined in §63.2550.

(3) The MCPU is not an affected source or part of an affected source under another subpart of this part 63, except for process vents from batch operations within a chemical manufacturing process unit (CMPU), as identified in §63.100(j)(4). For this situation, the MCPU is the same as the CMPU as defined in §63.100, and you are subject only to the requirements for batch process vents in this subpart.

(c) The requirements in this subpart do not apply to the operations specified in paragraphs (c)(1) through (7) of this section.

(1) Research and development facilities, as defined in section 112(c)(7) of the CAA.

(2) The manufacture of ammonium sulfate as a by-product, if the slurry entering the by-product manufacturing process contains 50 parts per million by weight (ppmw) HAP or less or 10 ppmw benzene or less. You must retain information, data, and analysis to document the HAP concentration in the entering slurry in order to claim this exemption.

(3) The affiliated operations located at an affected source under subparts GG (National Emission Standards for Aerospace Manufacturing and Rework Facilities), KK (National Emission Standards for the Printing and Publishing Industry), JJJJ (NESHAP: Paper and Other Web Coating), future MMMM (NESHAP: Surface Coating of Miscellaneous Metal Parts and Products), and SSSS (NESHAP: Surface Coating of Metal Coil) of this part 63. Affiliated operations include, but are not limited to, mixing or dissolving of coating ingredients; coating mixing for viscosity adjustment, color tint or additive blending, or pH adjustment; cleaning of coating lines and coating line parts; handling and storage of coatings and solvent; and conveyance and treatment of wastewater.

(4) Fabricating operations (such as spinning or compressing a solid polymer into its end use); compounding operations (in which blending, melting, and resolidification of a solid polymer product occur for the purpose of incorporating additives, colorants, or stabilizers); and extrusion and drawing operations (converting an already produced solid polymer into a different shape by melting or mixing the polymer and then forcing it or pulling it through an orifice to create an extruded product). An operation is not exempt if it involves processing with HAP solvent or if an intended purpose of the operation is to remove residual HAP monomer.

(5) Production activities described using the 1997 version of NAICS codes 325131, 325181, 325188 (except the requirements do apply to hydrazine), 325314, 325991 (except the requirements do apply to reformulating plastics resins from recycled plastics products), and 325992 (except the requirements do apply to photographic chemicals).

(6) Tall oil recovery systems.

(7) Carbon monoxide production.

(d) If the predominant use of a transfer rack loading arm or storage tank (including storage tanks in series) is associated with a miscellaneous organic chemical manufacturing process, and the loading arm or storage tank is not part of an affected source under a subpart of this part 63, then you must assign the loading arm or storage tank to the MCPU for that miscellaneous organic chemical manufacturing process.

If the predominant use cannot be determined, then you may assign the loading arm or storage tank to any MCPU that shares it and is subject to this subpart. If the use varies from year to year, then you must base the determination on the utilization that occurred during the year preceding November 10, 2003 or, if the loading arm or storage tank was not in operation during that year, you must base the use on the expected use for the first 5-year period after startup. You must include the determination in the notification of compliance status report specified in §63.2520(d). You must redetermine the primary use at least once every 5 years, or any time you implement emissions averaging or pollution prevention after the compliance date.

(e) For nondedicated equipment used to create at least one MCPU, you may elect to develop process unit groups (PUG), determine the primary product of each PUG, and comply with the requirements of the subpart in 40 CFR part 63 that applies to that primary product as specified in §63.2535(l).

[68 FR 63888, Nov. 10, 2003, as amended at 71 FR 40331, July 14, 2006]

 [Back to Top](#)

§63.2440 What parts of my plant does this subpart cover?

(a) This subpart applies to each miscellaneous organic chemical manufacturing affected source.

(b) The miscellaneous organic chemical manufacturing affected source is the facilitywide collection of MCPU and heat exchange systems, wastewater, and waste management units that are associated with manufacturing materials described in §63.2435(b)(1).

(c) A new affected source is described by either paragraph (c)(1) or (2) of this section.

(1) Each affected source defined in paragraph (b) of this section for which you commenced construction or reconstruction after April 4, 2002, and you meet the applicability criteria at the time you commenced construction or reconstruction.

(2) Each dedicated MCPU that has the potential to emit 10 tons per year (tpy) of any one HAP or 25 tpy of combined HAP, and you commenced construction or reconstruction of the MCPU after April 4, 2002. For the purposes of this paragraph, an MCPU is an affected source in the definition of the term "reconstruction" in §63.2.

(d) An MCPU that is also a CMPU under §63.100 is reconstructed for the purposes of this subpart if, and only if, the CMPU meets the requirements for reconstruction in §63.100(l)(2).

 [Back to Top](#)

COMPLIANCE DATES

 [Back to Top](#)

§63.2445 When do I have to comply with this subpart?

(a) If you have a new affected source, you must comply with this subpart according to the requirements in paragraphs (a)(1) and (2) of this section.

(1) If you startup your new affected source before November 10, 2003, then you must comply with the requirements for new sources in this subpart no later than November 10, 2003.

(2) If you startup your new affected source after November 10, 2003, then you must comply with the requirements for new sources in this subpart upon startup of your affected source.

(b) If you have an existing source on November 10, 2003, you must comply with the requirements for existing sources in this subpart no later than May 10, 2008.

(c) You must meet the notification requirements in §63.2515 according to the dates specified in that section and in subpart A of this part 63. Some of the notifications must be submitted before you are required to comply with the emission limits, operating limits, and work practice standards in this subpart.

(d) If you have a Group 2 emission point that becomes a Group 1 emission point after the compliance date for your affected source, you must comply with the Group 1 requirements beginning on the date the switch occurs. An initial compliance demonstration as specified in this subpart must be conducted within 150 days after the switch occurs.

(e) If, after the compliance date for your affected source, hydrogen halide and halogen HAP emissions from process vents in a process increase to more than 1,000 lb/yr, or HAP metals emissions from a process at a new affected source increase to more than 150 lb/yr, you must comply with the applicable emission limits specified in Table 3 to this subpart and the associated compliance requirements beginning on the date the emissions exceed the applicable threshold. An initial compliance demonstration as specified in this subpart must be conducted within 150 days after the switch occurs.

(f) If you have a small control device for process vent or transfer rack emissions that becomes a large control device, as defined in §63.2550(i), you must comply with monitoring and associated recordkeeping and reporting requirements for large control devices beginning on the date the switch occurs. An initial compliance demonstration as specified in this subpart must be conducted within 150 days after the switch occurs.

[68 FR 63888, Nov. 10, 2003, as amended at 71 FR 10442, Mar. 1, 2006; 71 FR 40332, July 14, 2006]

[↑ Back to Top](#)

EMISSION LIMITS, WORK PRACTICE STANDARDS, AND COMPLIANCE REQUIREMENTS

[↑ Back to Top](#)

§63.2450 What are my general requirements for complying with this subpart?

(a) You must be in compliance with the emission limits and work practice standards in tables 1 through 7 to this subpart at all times, except during periods of startup, shutdown, and malfunction (SSM), and you must meet the requirements specified in §§63.2455 through 63.2490 (or the alternative means of compliance in §63.2495, §63.2500, or §63.2505), except as specified in paragraphs (b) through (s) of this section. You must meet the notification, reporting, and recordkeeping requirements specified in §§63.2515, 63.2520, and 63.2525.

(b) *Determine halogenated vent streams.* You must determine if an emission stream is a halogenated vent stream, as defined in §63.2550, by calculating the mass emission rate of halogen

atoms in accordance with §63.115(d)(2)(v). Alternatively, you may elect to designate the emission stream as halogenated.

(c) *Requirements for combined emission streams.* When organic HAP emissions from different emission types (e.g., continuous process vents, batch process vents, storage tanks, transfer operations, and waste management units) are combined, you must comply with the requirements of either paragraph (c)(1) or (2) of this section.

(1) Comply with the applicable requirements of this subpart for each kind of organic HAP emissions in the stream (e.g., the requirements of table 1 to this subpart for continuous process vents and the requirements of table 4 to this subpart for emissions from storage tanks).

(2) Determine the applicable requirements based on the hierarchy presented in paragraphs (c)(2)(i) through (vi) of this section. For a combined stream, the applicable requirements are specified in the highest-listed paragraph in the hierarchy that applies to any of the individual streams that make up the combined stream. For example, if a combined stream consists of emissions from Group 1 batch process vents and any other type of emission stream, then you must comply with the requirements in paragraph (c)(2)(i) of this section for the combined stream; compliance with the requirements in paragraph (c)(2)(i) of this section constitutes compliance for the other emission streams in the combined stream. Two exceptions are that you must comply with the requirements in table 3 to this subpart and §63.2465 for all process vents with hydrogen halide and halogen HAP emissions, and recordkeeping requirements for Group 2 applicability or compliance are still required (e.g., the requirement in §63.2525(f) to track the number of batches produced and calculate rolling annual emissions for processes with Group 2 batch process vents).

(i) The requirements of table 2 to this subpart and §63.2460 for Group 1 batch process vents, including applicable monitoring, recordkeeping, and reporting.

(ii) The requirements of table 1 to this subpart and §63.2455 for continuous process vents that are routed to a control device, as defined in §63.981, including applicable monitoring, recordkeeping, and reporting.

(iii) The requirements of table 5 to this subpart and §63.2475 for transfer operations, including applicable monitoring, recordkeeping, and reporting.

(iv) The requirements of table 7 to this subpart and §63.2485 for emissions from waste management units that are used to manage and treat Group 1 wastewater streams and residuals from Group 1 wastewater streams, including applicable monitoring, recordkeeping, and reporting.

(v) The requirements of table 4 to this subpart and §63.2470 for control of emissions from storage tanks, including applicable monitoring, recordkeeping, and reporting.

(vi) The requirements of table 1 to this subpart and §63.2455 for continuous process vents after a recovery device including applicable monitoring, recordkeeping, and reporting.

(d) [Reserved]

(e) *Requirements for control devices.* (1) Except when complying with §63.2485, if you reduce organic HAP emissions by venting emissions through a closed-vent system to any combination of control devices (except a flare) or recovery devices, you must meet the requirements of §63.982(c) and the requirements referenced therein.

(2) Except when complying with §63.2485, if you reduce organic HAP emissions by venting emissions through a closed-vent system to a flare, you must meet the requirements of §63.982(b) and the requirements referenced therein.

(3) If you use a halogen reduction device to reduce hydrogen halide and halogen HAP emissions from halogenated vent streams, you must meet the requirements of §63.994 and the requirements referenced therein. If you use a halogen reduction device before a combustion device, you must determine the halogen atom emission rate prior to the combustion device according to the procedures in §63.115(d)(2)(v).

(f) *Requirements for flare compliance assessments.* (1) As part of a flare compliance assessment required in §63.987(b), you have the option of demonstrating compliance with the requirements of §63.11(b) by complying with the requirements in either §63.11(b)(6)(i) or §63.987(b)(3)(ii).

(2) If you elect to meet the requirements in §63.11(b)(6)(i), you must keep flare compliance assessment records as specified in paragraphs (f)(2)(i) and (ii) of this section.

(i) Keep records as specified in §63.998(a)(1)(i), except that a record of the heat content determination is not required.

(ii) Keep records of the flare diameter, hydrogen content, exit velocity, and maximum permitted velocity. Include these records in the flare compliance report required in §63.999(a)(2).

(g) *Requirements for performance tests.* The requirements specified in paragraphs (g)(1) through (5) of this section apply instead of or in addition to the requirements specified in subpart SS of this part 63.

(1) Conduct gas molecular weight analysis using Method 3, 3A, or 3B in appendix A to part 60 of this chapter.

(2) Measure moisture content of the stack gas using Method 4 in appendix A to part 60 of this chapter.

(3) If the uncontrolled or inlet gas stream to the control device contains carbon disulfide, you must conduct emissions testing according to paragraph (g)(3)(i) or (ii) of this section.

(i) If you elect to comply with the percent reduction emission limits in tables 1 through 7 to this subpart, and carbon disulfide is the principal organic HAP component (*i.e.*, greater than 50 percent of the HAP in the stream by volume), then you must use Method 18, or Method 15 (40 CFR part 60, appendix A) to measure carbon disulfide at the inlet and outlet of the control device. Use the percent reduction in carbon disulfide as a surrogate for the percent reduction in total organic HAP emissions.

(ii) If you elect to comply with the outlet total organic compound (TOC) concentration emission limits in tables 1 through 7 to this subpart, and the uncontrolled or inlet gas stream to the control device contains greater than 10 percent (volume concentration) carbon disulfide, you must use Method 18 or Method 15 to separately determine the carbon disulfide concentration. Calculate the total HAP or TOC emissions by totaling the carbon disulfide emissions measured using Method 18 or 15 and the other HAP emissions measured using Method 18 or 25A.

(4) As an alternative to using Method 18, Method 25/25A, or Method 26/26A of 40 CFR part 60, appendix A, to comply with any of the emission limits specified in tables 1 through 7 to this subpart, you may use Method 320 of 40 CFR part 60, appendix A. When using Method 320, you must follow the analyte spiking procedures of section 13 of Method 320, unless you demonstrate that the complete spiking procedure has been conducted at a similar source.

(5) Section 63.997(c)(1) does not apply. For the purposes of this subpart, results of all initial compliance demonstrations must be included in the notification of compliance status report, which is due 150 days after the compliance date, as specified in §63.2520(d)(1).

(h) *Design evaluation.* To determine the percent reduction of a small control device that is used to comply with an emission limit specified in table 1, 2, 3, or 5 to this subpart, you may elect to conduct a design evaluation as specified in §63.1257(a)(1) instead of a performance test as specified in subpart SS of this part 63. You must establish the value(s) and basis for the operating limits as part of the design evaluation. For continuous process vents, the design evaluation must be conducted at maximum representative operating conditions for the process, unless the Administrator specifies or approves alternate operating conditions. For transfer racks, the design evaluation must demonstrate that the control device achieves the required control efficiency during the reasonably expected maximum transfer loading rate.

(i) *Outlet concentration correction for combustion devices.* When §63.997(e)(2)(iii)(C) requires you to correct the measured concentration at the outlet of a combustion device to 3 percent oxygen if you add supplemental combustion air, the requirements in either paragraph (i)(1) or (2) of this section apply for the purposes of this subpart.

(1) You must correct the concentration in the gas stream at the outlet of the combustion device to 3 percent oxygen if you add supplemental gases, as defined in §63.2550, to the vent stream, or;

(2) You must correct the measured concentration for supplemental gases using Equation 1 of §63.2460; you may use process knowledge and representative operating data to determine the fraction of the total flow due to supplemental gas.

(j) *Continuous emissions monitoring systems.* Each continuous emissions monitoring system (CEMS) must be installed, operated, and maintained according to the requirements in §63.8 and paragraphs (j)(1) through (5) of this section.

(1) Each CEMS must be installed, operated, and maintained according to the applicable Performance Specification of 40 CFR part 60, appendix B, and according to paragraph (j)(2) of this section, except as specified in paragraph (j)(1)(i) of this section. For any CEMS meeting Performance Specification 8, you must also comply with appendix F, procedure 1 of 40 CFR part 60.

(i) If you wish to use a CEMS other than an Fourier Transform Infrared Spectroscopy (FTIR) meeting the requirements of Performance Specification 15 to measure hydrogen halide and halogen HAP before we promulgate a Performance Specification for such CEMS, you must prepare a monitoring plan and submit it for approval in accordance with the procedures specified in §63.8.

(ii) [Reserved]

(2) You must determine the calibration gases and reporting units for TOC CEMS in accordance with paragraph (j)(2)(i), (ii), or (iii) of this section.

(i) For CEMS meeting Performance Specification 9 or 15 requirements, determine the target analyte(s) for calibration using either process knowledge of the control device inlet stream or the screening procedures of Method 18 on the control device inlet stream.

(ii) For CEMS meeting Performance Specification 8 used to monitor performance of a combustion device, calibrate the instrument on the predominant organic HAP and report the results as carbon (C1), and use Method 25A or any approved alternative as the reference method for the relative accuracy tests.

(iii) For CEMS meeting Performance Specification 8 used to monitor performance of a noncombustion device, determine the predominant organic HAP using either process knowledge or the screening procedures of Method 18 on the control device inlet stream, calibrate the monitor on the predominant organic HAP, and report the results as C_1 . Use Method 18, ASTM D6420-99, or any approved alternative as the reference method for the relative accuracy tests, and report the results as C_1 .

(3) You must conduct a performance evaluation of each CEMS according to the requirements in 40 CFR 63.8 and according to the applicable Performance Specification of 40 CFR part 60, appendix B, except that the schedule in §63.8(e)(4) does not apply, and the results of the performance evaluation must be included in the notification of compliance status report.

(4) The CEMS data must be reduced to operating day or operating block averages computed using valid data consistent with the data availability requirements specified in §63.999(c)(6)(i)(B) through (D), except monitoring data also are sufficient to constitute a valid hour of data if measured values are available for at least two of the 15-minute periods during an hour when calibration, quality assurance, or maintenance activities are being performed. An operating block is a period of time from the beginning to end of batch operations within a process. Operating block averages may be used only for batch process vent data.

(5) If you add supplemental gases, you must correct the measured concentrations in accordance with paragraph (i) of this section and §63.2460(c)(6).

(k) *Continuous parameter monitoring.* The provisions in paragraphs (k)(1) through (6) of this section apply in addition to the requirements for continuous parameter monitoring system (CPMS) in subpart SS of this part 63.

(1) You must record the results of each calibration check and all maintenance performed on the CPMS as specified in §63.998(c)(1)(ii)(A).

(2) When subpart SS of this part 63 uses the term “a range” or “operating range” of a monitored parameter, it means an “operating limit” for a monitored parameter for the purposes of this subpart.

(3) As an alternative to continuously measuring and recording pH as specified in §§63.994(c)(1)(i) and 63.998(a)(2)(ii)(D), you may elect to continuously monitor and record the caustic strength of the effluent. For halogen scrubbers used to control only batch process vents you may elect to monitor and record either the pH or the caustic strength of the scrubber effluent at least once per day.

(4) As an alternative to the inlet and outlet temperature monitoring requirements for catalytic incinerators as specified in §63.988(c)(2) and the related recordkeeping requirements specified in §63.998(a)(2)(ii)(B)(2) and (c)(2)(ii), you may elect to comply with the requirements specified in paragraphs (k)(4)(i) through (iv) of this section.

(i) Monitor and record the inlet temperature as specified in subpart SS of this part 63.

(ii) Check the activity level of the catalyst at least every 12 months and take any necessary corrective action, such as replacing the catalyst to ensure that the catalyst is performing as designed.

(iii) Maintain records of the annual checks of catalyst activity levels and the subsequent corrective actions.

(iv) Recording the downstream temperature and temperature difference across the catalyst bed as specified in §63.998(a)(2)(ii)(B)(2) and (b)(2)(ii) is not required.

(5) For absorbers that control organic compounds and use water as the scrubbing fluid, you must conduct monitoring and recordkeeping as specified in paragraphs (k)(5)(i) through (iii) of this section instead of the monitoring and recordkeeping requirements specified in §§63.990(c)(1), 63.993(c)(1), and 63.998(a)(2)(ii)(C).

(i) You must use a flow meter capable of providing a continuous record of the absorber influent liquid flow.

(ii) You must determine gas stream flow using one of the procedures specified in §63.994(c)(1)(ii)(A) through (D).

(iii) You must record the absorber liquid-to-gas ratio averaged over the time period of any performance test.

(6) For a control device with total inlet HAP emissions less than 1 tpy, you must establish an operating limit(s) for a parameter(s) that you will measure and record at least once per averaging period (i.e., daily or block) to verify that the control device is operating properly. You may elect to measure the same parameter(s) that is required for control devices that control inlet HAP emissions equal to or greater than 1 tpy. If the parameter will not be measured continuously, you must request approval of your proposed procedure in the precompliance report. You must identify the operating limit(s) and the measurement frequency, and you must provide rationale to support how these measurements demonstrate the control device is operating properly.

(l) *Startup, shutdown, and malfunction.* Sections 63.152(f)(7)(ii) through (iv) and 63.998(b)(2)(iii) and (b)(6)(i)(A), which apply to the exclusion of monitoring data collected during periods of SSM from daily averages, do not apply for the purposes of this subpart.

(m) *Reporting.* (1) When §§63.2455 through 63.2490 reference other subparts in this part 63 that use the term “periodic report,” it means “compliance report” for the purposes of this subpart. The compliance report must include the information specified in §63.2520(e), as well as the information specified in referenced subparts.

(2) When there are conflicts between this subpart and referenced subparts for the due dates of reports required by this subpart, reports must be submitted according to the due dates presented in this subpart.

(3) Excused excursions, as defined in subparts G and SS of this part 63, are not allowed.

(n) [Reserved]

(o) You may not use a flare to control halogenated vent streams or hydrogen halide and halogen HAP emissions.

(p) Opening a safety device, as defined in §63.2550, is allowed at any time conditions require it to avoid unsafe conditions.

(q) If an emission stream contains energetics or organic peroxides that, for safety reasons, cannot meet an applicable emission limit specified in Tables 1 through 7 to this subpart, then you must submit documentation in your precompliance report explaining why an undue safety hazard would be created if the air emission controls were installed, and you must describe the procedures that you will implement to minimize HAP emissions from these vent streams.

(r) *Surge control vessels and bottoms receivers.* For each surge control vessel or bottoms receiver that meets the capacity and vapor pressure thresholds for a Group 1 storage tank, you must meet emission limits and work practice standards specified in Table 4 to this subpart.

(s) For the purposes of determining Group status for continuous process vents, batch process vents, and storage tanks in §§63.2455, 63.2460, and 63.2470, hydrazine is to be considered an organic HAP.

[68 FR 63888, Nov. 10, 2003, as amended at 70 FR 38559, July 1, 2005; 71 FR 40332, July 14, 2006]

 [Back to Top](#)

§63.2455 What requirements must I meet for continuous process vents?

(a) You must meet each emission limit in Table 1 to this subpart that applies to your continuous process vents, and you must meet each applicable requirement specified in paragraphs (b) through (c) of this section.

(b) For each continuous process vent, you must either designate the vent as a Group 1 continuous process vent or determine the total resource effectiveness (TRE) index value as specified in §63.115(d), except as specified in paragraphs (b)(1) through (3) of this section.

(1) You are not required to determine the Group status or the TRE index value for any continuous process vent that is combined with Group 1 batch process vents before a control device or recovery device because the requirements of §63.2450(c)(2)(i) apply to the combined stream.

(2) When a TRE index value of 4.0 is referred to in §63.115(d), TRE index values of 5.0 for existing affected sources and 8.0 for new and reconstructed affected sources apply for the purposes of this subpart.

(3) When §63.115(d) refers to “emission reductions specified in §63.113(a),” the reductions specified in Table 1 to this subpart apply for the purposes of this subpart.

(c) If you use a recovery device to maintain the TRE above a specified threshold, you must meet the requirements of §63.982(e) and the requirements referenced therein, except as specified in §63.2450 and paragraph (c)(1) of this section.

(1) When §63.993 uses the phrase “the TRE index value is between the level specified in a referencing subpart and 4.0,” the phrase “the TRE index value is >1.9 but ≤5.0” applies for an existing affected source, and the phrase “the TRE index value is >5.0 but ≤8.0” applies for a new and reconstructed affected source, for the purposes of this subpart.

(2) [Reserved]

 [Back to Top](#)

§63.2460 What requirements must I meet for batch process vents?

(a) You must meet each emission limit in Table 2 to this subpart that applies to you, and you must meet each applicable requirement specified in paragraphs (b) and (c) of this section.

(b) *Group status.* If a process has batch process vents, as defined in §63.2550, you must determine the group status of the batch process vents by determining and summing the uncontrolled organic HAP

emissions from each of the batch process vents within the process using the procedures specified in §63.1257(d)(2)(i) and (ii), except as specified in paragraphs (b)(1) through (7) of this section.

(1) To calculate emissions caused by the heating of a vessel without a process condenser to a temperature lower than the boiling point, you must use the procedures in §63.1257(d)(2)(i)(C)(3).

(2) To calculate emissions from depressurization of a vessel without a process condenser, you must use the procedures in §63.1257(d)(2)(i)(D)(10).

(3) To calculate emissions from vacuum systems for the purposes of this subpart, the receiving vessel is part of the vacuum system, and terms used in Equation 33 to 40 CFR part 63, subpart GGG, are defined as follows:

P_{system} = absolute pressure of the receiving vessel;

P_i = partial pressure of the HAP determined at the exit temperature and exit pressure conditions of the condenser or at the conditions of the dedicated receiver;

P_j = partial pressure of condensables (including HAP) determined at the exit temperature and exit pressure conditions of the condenser or at the conditions of the dedicated receiver;

MW_{HAP} = molecular weight of the HAP determined at the exit temperature and exit pressure conditions of the condenser or at the conditions of the dedicated receiver.

(4) To calculate uncontrolled emissions when a vessel is equipped with a process condenser, you must use the procedures in §63.1257(d)(3)(i)(B), except as specified in paragraphs (b)(4)(i) through (vii) of this section.

(i) You must determine the flowrate of gas (or volume of gas), partial pressures of condensables, temperature (T), and HAP molecular weight (MW_{HAP}) at the exit temperature and exit pressure conditions of the condenser or at the conditions of the dedicated receiver.

(ii) You must assume that all of the components contained in the condenser exit vent stream are in equilibrium with the same components in the exit condensate stream (except for noncondensables).

(iii) You must perform a material balance for each component.

(iv) For the emissions from gas evolution, the term for time, t, must be used in Equation 12 to 40 CFR part 63, subpart GGG.

(v) Emissions from empty vessel purging shall be calculated using Equation 36 to 40 CFR part 63, subpart GGG and the exit temperature and exit pressure conditions of the condenser or the conditions of the dedicated receiver.

(vi) You must conduct an engineering assessment as specified in §63.1257(d)(2)(ii) for each emission episode that is not due to vapor displacement, purging, heating, depressurization, vacuum operations, gas evolution, air drying, or empty vessel purging. The requirements of paragraphs (b)(3) through (4) of this section shall apply.

(vii) You may elect to conduct an engineering assessment if you can demonstrate to the Administrator that the methods in §63.1257(d)(3)(i)(B) are not appropriate.

(5) You may elect to designate the batch process vents within a process as Group 1 and not calculate uncontrolled emissions under either of the situations in paragraph (b)(5)(i), (ii), or (iii) of this section.

(i) If you comply with the alternative standard specified in §63.2505.

(ii) If all Group 1 batch process vents within a process are controlled; you conduct the performance test under hypothetical worst case conditions, as defined in §63.1257(b)(8)(i)(B); and the emission profile is based on capture and control system limitations as specified in §63.1257(b)(8)(ii)(C).

(iii) If you comply with an emission limit using a flare that meets the requirements specified in §63.987.

(6) You may change from Group 2 to Group 1 in accordance with either paragraph (b)(6)(i) or (ii) of this section. You must comply with the requirements of this section and submit the test report in the next Compliance report.

(i) You may switch at any time after operating as Group 2 for at least 1 year so that you can show compliance with the 10,000 pounds per year (lb/yr) threshold for Group 2 batch process vents for at least 365 days before the switch. You may elect to start keeping records of emissions from Group 2 batch process vents before the compliance date. Report a switch based on this provision in your next compliance report in accordance with §63.2520(e)(10)(i).

(ii) If the conditions in paragraph (b)(6)(i) of this section are not applicable, you must provide a 60-day advance notice in accordance with §63.2520(e)(10)(ii) before switching.

(7) As an alternative to determining the uncontrolled organic HAP emissions as specified in §63.1257(d)(2)(i) and (ii), you may elect to demonstrate that non-reactive organic HAP are the only HAP used in the process and non-reactive HAP usage in the process is less than 10,000 lb/yr. You must provide data and supporting rationale in your notification of compliance status report explaining why the non-reactive organic HAP usage will be less than 10,000 lb/yr. You must keep records of the non-reactive organic HAP usage as specified in §63.2525(e)(2) and include information in compliance reports as specified in §63.2520(e)(5)(iv).

(c) Exceptions to the requirements in subparts SS and WW of this part 63 are specified in paragraphs (c)(1) through (9) of this section.

(1) *Process condensers.* Process condensers, as defined in §63.2550(i), are not considered to be control devices for batch process vents. You must determine whether a condenser is a control device for a batch process vent or a process condenser from which the uncontrolled HAP emissions are evaluated as part of the initial compliance demonstration for each MCPU and report the results with supporting rationale in your notification of compliance status report.

(2) *Initial compliance.* (i) To demonstrate initial compliance with a percent reduction emission limit in Table 2 to this subpart FFFF, you must compare the sums of the controlled and uncontrolled emissions for the applicable Group 1 batch process vents within the process, and show that the specified reduction is met. This requirement does not apply if you comply with the emission limits of Table 2 to this subpart FFFF by using a flare that meets the requirements of §63.987.

(ii) When you conduct a performance test or design evaluation for a non-flare control device used to control emissions from batch process vents, you must establish emission profiles and conduct the test under worst-case conditions according to §63.1257(b)(8) instead of under normal operating conditions as specified in §63.7(e)(1). The requirements in §63.997(e)(1)(i) and (iii) also do not apply for performance

tests conducted to determine compliance with the emission limits for batch process vents. For purposes of this subpart FFFF, references in §63.997(b)(1) to “methods specified in §63.997(e)” include the methods specified in §63.1257(b)(8).

(iii) As an alternative to conducting a performance test or design evaluation to demonstrate initial compliance with a percent reduction requirement for a condenser, you may determine controlled emissions using the procedures specified in §63.1257(d)(3)(i)(B) and paragraphs (b)(3) through (4) of this section.

(iv) When §63.1257(d)(3)(i)(B)(7) specifies that condenser-controlled emissions from an air dryer must be calculated using Equation 11 of 40 CFR part 63, subpart GGG, with “V equal to the air flow rate,” it means “V equal to the dryer outlet gas flow rate,” for the purposes of this subpart. Alternatively, you may use Equation 12 of 40 CFR part 63, subpart GGG, with V equal to the dryer inlet air flow rate. Account for time as appropriate in either equation.

(v) If a process condenser is used for any boiling operations, you must demonstrate that it is properly operated according to the procedures specified in §63.1257(d)(2)(i)(C)(4)(ii) and (d)(3)(iii)(B), and the demonstration must occur only during the boiling operation. The reference in §63.1257(d)(3)(iii)(B) to the alternative standard in §63.1254(c) means §63.2505 for the purposes of this subpart. As an alternative to measuring the exhaust gas temperature, as required by §63.1257(d)(3)(iii)(B), you may elect to measure the liquid temperature in the receiver.

(vi) You must conduct a subsequent performance test or compliance demonstration equivalent to an initial compliance demonstration within 180 days of a change in the worst-case conditions.

(3) *Establishing operating limits.* You must establish operating limits under the conditions required for your initial compliance demonstration, except you may elect to establish operating limit(s) for conditions other than those under which a performance test was conducted as specified in paragraph (c)(3)(i) of this section and, if applicable, paragraph (c)(3)(ii) of this section.

(i) The operating limits may be based on the results of the performance test and supplementary information such as engineering assessments and manufacturer's recommendations. These limits may be established for conditions as unique as individual emission episodes for a batch process. You must provide rationale in the precompliance report for the specific level for each operating limit, including any data and calculations used to develop the limit and a description of why the limit indicates proper operation of the control device. The procedures provided in this paragraph (c)(3)(i) have not been approved by the Administrator and determination of the operating limit using these procedures is subject to review and approval by the Administrator.

(ii) If you elect to establish separate monitoring levels for different emission episodes within a batch process, you must maintain records in your daily schedule or log of processes indicating each point at which you change from one operating limit to another, even if the duration of the monitoring for an operating limit is less than 15 minutes. You must maintain a daily schedule or log of processes according to §63.2525(c).

(4) *Averaging periods.* As an alternative to the requirement for daily averages in §63.998(b)(3), you may determine averages for operating blocks. An operating block is a period of time that is equal to the time from the beginning to end of batch process operations within a process.

(5) [Reserved]

(6) *Outlet concentration correction for supplemental gases.* If you use a control device other than a combustion device to comply with a TOC, organic HAP, or hydrogen halide and halogen HAP outlet concentration emission limit for batch process vents, you must correct the actual concentration for

supplemental gases using Equation 1 of this section; you may use process knowledge and representative operating data to determine the fraction of the total flow due to supplemental gas.

$$C_a = C_m \left(\frac{Q_s + Q_a}{Q_a} \right) \quad (\text{Eq. 1})$$

[View or download PDF](#)

Where:

C_a = corrected outlet TOC, organic HAP, or hydrogen halide and halogen HAP concentration, dry basis, ppmv;

C_m = actual TOC, organic HAP, or hydrogen halide and halogen HAP concentration measured at control device outlet, dry basis, ppmv;

Q_a = total volumetric flowrate of all gas streams vented to the control device, except supplemental gases;

Q_s = total volumetric flowrate of supplemental gases.

(7) If flow to a control device could be intermittent, you must install, calibrate, and operate a flow indicator at the inlet or outlet of the control device to identify periods of no flow. Periods of no flow may not be used in daily or block averages, and it may not be used in fulfilling a minimum data availability requirement.

(8) *Terminology.* When the term “storage vessel” is used in subpart WW of this part 63, the term “process tank,” as defined in §63.2550(i), applies for the purposes of this section.

(9) *Requirements for a biofilter.* If you use a biofilter to meet either the 95 percent reduction requirement or outlet concentration requirement specified in Table 2 to this subpart, you must meet the requirements specified in paragraphs (c)(9)(i) through (iv) of this section.

(i) *Operational requirements.* The biofilter must be operated at all times when emissions are vented to it.

(ii) *Performance tests.* To demonstrate initial compliance, you must conduct a performance test according to the procedures in §63.997 and paragraphs (c)(9)(ii)(A) through (D) of this section. The design evaluation option for small control devices is not applicable if you use a biofilter.

(A) Keep up-to-date, readily accessible continuous records of either the biofilter bed temperature averaged over the full period of the performance test or the outlet total organic HAP or TOC concentration averaged over the full period of the performance test. Include these data in your notification of compliance status report as required by §63.999(b)(3)(ii).

(B) Record either the percent reduction of total organic HAP achieved by the biofilter determined as specified in §63.997(e)(2)(iv) or the concentration of TOC or total organic HAP determined as specified in §63.997(e)(2)(iii) at the outlet of the biofilter, as applicable.

(C) If you monitor the biofilter bed temperature, you may elect to use multiple thermocouples in representative locations throughout the biofilter bed and calculate the average biofilter bed temperature across these thermocouples prior to reducing the temperature data to 15 minute (or shorter) averages for purposes of establishing operating limits for the biofilter. If you use multiple thermocouples, include your rationale for their site selection in your notification of compliance status report.

(D) Submit a performance test report as specified in §63.999(a)(2)(i) and (ii). Include the records from paragraph (c)(9)(ii)(B) of this section in your performance test report.

(iii) *Monitoring requirements.* Use either a biofilter bed temperature monitoring device (or multiple devices) capable of providing a continuous record or an organic monitoring device capable of providing a continuous record. Keep records of temperature or other parameter monitoring results as specified in §63.998(b) and (c), as applicable. General requirements for monitoring are contained in §63.996. If you monitor temperature, the operating temperature range must be based on only the temperatures measured during the performance test; these data may not be supplemented by engineering assessments or manufacturer's recommendations as otherwise allowed in §63.999(b)(3)(ii)(A). If you establish the operating range (minimum and maximum temperatures) using data from previous performance tests in accordance with §63.996(c)(6), replacement of the biofilter media with the same type of media is not considered a process change under §63.997(b)(1). You may expand your biofilter bed temperature operating range by conducting a repeat performance test that demonstrates compliance with the 95 percent reduction requirement or outlet concentration limit, as applicable.

(iv) *Repeat performance tests.* You must conduct a repeat performance test using the applicable methods specified in §63.997 within 2 years following the previous performance test and within 150 days after each replacement of any portion of the biofilter bed media with a different type of media or each replacement of more than 50 percent (by volume) of the biofilter bed media with the same type of media.

[68 FR 63888, Nov. 10, 2003, as amended at 70 FR 38559, July 1, 2005; 71 FR 40333, July 14, 2006]

[↑ Back to Top](#)

§63.2465 What requirements must I meet for process vents that emit hydrogen halide and halogen HAP or HAP metals?

(a) You must meet each emission limit in Table 3 to this subpart that applies to you, and you must meet each applicable requirement in paragraphs (b) through (d) of this section.

(b) If any process vents within a process emit hydrogen halide and halogen HAP, you must determine and sum the uncontrolled hydrogen halide and halogen HAP emissions from each of the process vents within the process using the procedures specified in §63.1257(d)(2)(i) and/or (ii), as appropriate. When §63.1257(d)(2)(ii)(E) requires documentation to be submitted in the precompliance report, it means the notification of compliance status report for the purposes of this paragraph.

(c) If collective uncontrolled hydrogen halide and halogen HAP emissions from the process vents within a process are greater than or equal to 1,000 pounds per year (lb/yr), you must comply with §63.994 and the requirements referenced therein, except as specified in paragraphs (c)(1) through (3) of this section.

(1) When §63.994(b)(1) requires a performance test, you may elect to conduct a design evaluation in accordance with §63.1257(a)(1).

(2) When §63.994(b)(1) refers to "a combustion device followed by a halogen scrubber or other halogen reduction device," it means any combination of control devices used to meet the emission limits specified in Table 3 to this subpart.

(3) Section 63.994(b)(2) does not apply for the purposes of this section.

(d) To demonstrate compliance with the emission limit in Table 3 to this subpart for HAP metals at a new source, you must comply with paragraphs (d)(1) through (3) of this section.

(1) Determine the mass emission rate of HAP metals based on process knowledge, engineering assessment, or test data.

(2) Conduct an initial performance test of each control device that is used to comply with the emission limit for HAP metals specified in Table 3 to this subpart. Conduct the performance test according to the procedures in §63.997. Use Method 29 of appendix A of 40 CFR part 60 to determine the HAP metals at the inlet and outlet of each control device, or use Method 5 of appendix A of 40 CFR part 60 to determine the total particulate matter (PM) at the inlet and outlet of each control device. You have demonstrated initial compliance if the overall reduction of either HAP metals or total PM from the process is greater than or equal to 97 percent by weight.

(3) Comply with the monitoring requirements specified in §63.1366(b)(1)(xi) for each fabric filter used to control HAP metals.

[68 FR 63888, Nov. 10, 2003, as amended at 71 FR 40334, July 14, 2006]

 [Back to Top](#)

§63.2470 What requirements must I meet for storage tanks?

(a) You must meet each emission limit in Table 4 to this subpart that applies to your storage tanks, and you must meet each applicable requirement specified in paragraphs (b) through (e) of this section.

(b) [Reserved]

(c) *Exceptions to subparts SS and WW of this part 63.* (1) If you conduct a performance test or design evaluation for a control device used to control emissions only from storage tanks, you must establish operating limits, conduct monitoring, and keep records using the same procedures as required in subpart SS of this part 63 for control devices used to reduce emissions from process vents instead of the procedures specified in §§63.985(c), 63.998(d)(2)(i), and 63.999(b)(2).

(2) When the term “storage vessel” is used in subparts SS and WW of this part 63, the term “storage tank,” as defined in §63.2550 applies for the purposes of this subpart.

(d) *Planned routine maintenance.* The emission limits in Table 4 to this subpart for control devices used to control emissions from storage tanks do not apply during periods of planned routine maintenance. Periods of planned routine maintenance of each control device, during which the control device does not meet the emission limit specified in Table 4 to this subpart, must not exceed 240 hours per year (hr/yr). You may submit an application to the Administrator requesting an extension of this time limit to a total of 360 hr/yr. The application must explain why the extension is needed, it must indicate that no material will be added to the storage tank between the time the 240-hr limit is exceeded and the control device is again operational, and it must be submitted at least 60 days before the 240-hr limit will be exceeded.

(e) *Vapor balancing alternative.* As an alternative to the emission limits specified in Table 4 to this subpart, you may elect to implement vapor balancing in accordance with §63.1253(f), except as specified in paragraphs (e)(1) through (3) of this section.

(1) When §63.1253(f)(6)(i) refers to a 90 percent reduction, 95 percent applies for the purposes of this subpart.

(2) To comply with §63.1253(f)(6)(i), the owner or operator of an offsite cleaning or reloading facility must comply with §§63.2445 through 63.2550 instead of complying with §63.1253(f)(7)(ii), except as specified in paragraph (e)(2)(i) or (ii) of this section.

(i) The reporting requirements in §63.2520 do not apply to the owner or operator of the offsite cleaning or reloading facility.

(ii) As an alternative to complying with the monitoring, recordkeeping, and reporting provisions in §§63.2445 through 63.2550, the owner or operator of an offsite cleaning or reloading facility may comply as specified in §63.2535(a)(2) with any other subpart of this part 63 which has monitoring, recordkeeping, and reporting provisions as specified in §63.2535(a)(2).

(3) You may elect to set a pressure relief device to a value less than the 2.5 pounds per square inch gage pressure (psig) required in §63.1253(f)(5) if you provide rationale in your notification of compliance status report explaining why the alternative value is sufficient to prevent breathing losses at all times.

(4) You may comply with the vapor balancing alternative in §63.1253(f) when your storage tank is filled from a barge. All requirements for tank trucks and railcars specified in §63.1253(f) also apply to barges, except as specified in §63.2470(e)(4)(i).

(i) When §63.1253(f)(2) refers to pressure testing certifications, the requirements in 40 CFR 61.304(f) apply for barges.

(ii) [Reserved]

[68 FR 63888, Nov. 10, 2003, as amended at 70 FR 38559, July 1, 2005; 71 FR 40335, July 14, 2006]

 [Back to Top](#)

§63.2475 What requirements must I meet for transfer racks?

(a) You must comply with each emission limit and work practice standard in table 5 to this subpart that applies to your transfer racks, and you must meet each applicable requirement in paragraphs (b) and (c) of this section.

(b) When the term “high throughput transfer rack” is used in subpart SS of this part 63, the term “Group 1 transfer rack,” as defined in §63.2550, applies for the purposes of this subpart.

[68 FR 63888, Nov. 10, 2003, as amended at 71 FR 40335, July 14, 2006]

 [Back to Top](#)

§63.2480 What requirements must I meet for equipment leaks?

(a) You must meet each requirement in table 6 to this subpart that applies to your equipment leaks, except as specified in paragraphs (b) through (d) of this section.

(b) If you comply with either subpart H or subpart UU of this part 63, you may elect to comply with the provisions in paragraphs (b)(1) through (5) of this section as an alternative to the referenced provisions in subpart H or subpart UU of this part.

(1) The requirements for pressure testing in §63.179(b) or §63.1036(b) may be applied to all processes, not just batch processes.

(2) For the purposes of this subpart, pressure testing for leaks in accordance with §63.179(b) or §63.1036(b) is not required after reconfiguration of an equipment train if flexible hose connections are the only disturbed equipment.

(3) For an existing source, you are not required to develop an initial list of identification numbers for connectors as would otherwise be required under §63.1022(b)(1) or §63.181(b)(1)(i).

(4) For connectors in gas/vapor and light liquid service at an existing source, you may elect to comply with the requirements in §63.169 or §63.1029 for connectors in heavy liquid service, including all associated recordkeeping and reporting requirements, rather than the requirements of §63.174 or §63.1027.

(5) For pumps in light liquid service in an MCPU that has no continuous process vents and is part of an existing source, you may elect to consider the leak definition that defines a leak to be 10,000 parts per million (ppm) or greater as an alternative to the values specified in §63.1026(b)(2)(i) through (iii) or §63.163(b)(2).

(c) If you comply with 40 CFR part 65, subpart F, you may elect to comply with the provisions in paragraphs (c)(1) through (9) of this section as an alternative to the referenced provisions in 40 CFR part 65, subpart F.

(1) The requirements for pressure testing in §65.117(b) may be applied to all processes, not just batch processes.

(2) For the purposes of this subpart, pressure testing for leaks in accordance with §65.117(b) is not required after reconfiguration of an equipment train if flexible hose connections are the only disturbed equipment.

(3) For an existing source, you are not required to develop an initial list of identification numbers for connectors as would otherwise be required under §65.103(b)(1).

(4) You may elect to comply with the monitoring and repair requirements specified in §65.108(e)(3) as an alternative to the requirements specified in §65.108(a) through (d) for any connectors at your affected source.

(5) For pumps in light liquid service in an MCPU that has no continuous process vents and is part of an existing source, you may elect to consider the leak definition that defines a leak to be 10,000 ppm or greater as an alternative to the values specified in §65.107(b)(2)(i) through (iii).

(6) When 40 CFR part 65, subpart F refers to the implementation date specified in §65.1(f), it means the compliance date specified in §63.2445.

(7) When §§65.105(f) and 65.117(d)(3) refer to §65.4, it means §63.2525.

(8) When §65.120(a) refers to §65.5(d), it means §63.2515.

(9) When §65.120(b) refers to §65.5(e), it means §63.2520.

(d) The provisions of this section do not apply to bench-scale processes, regardless of whether the processes are located at the same plant site as a process subject to the provisions of this subpart.

[↑ Back to Top](#)

§63.2485 What requirements must I meet for wastewater streams and liquid streams in open systems within an MCPU?

(a) You must meet each requirement in table 7 to this subpart that applies to your wastewater streams and liquid streams in open systems within an MCPU, except as specified in paragraphs (b) through (o) of this section.

(b) *Wastewater HAP.* Where §63.105 and §§63.132 through 63.148 refer to compounds in table 9 of subpart G of this part 63, the compounds in tables 8 and 9 to this subpart apply for the purposes of this subpart.

(c) *Group 1 wastewater.* Section 63.132(c)(1) (i) and (ii) do not apply. For the purposes of this subpart, a process wastewater stream is Group 1 for compounds in tables 8 and 9 to this subpart if any of the conditions specified in paragraphs (c) (1) through (3) of this section are met.

(1) The total annual average concentration of compounds in table 8 to this subpart is greater than or equal to 10,000 ppmw at any flowrate, and the total annual load of compounds in table 8 to this subpart is greater than or equal to 200 lb/yr.

(2) The total annual average concentration of compounds in table 8 to this subpart is greater than or equal to 1,000 ppmw, and the annual average flowrate is greater than or equal to 1 l/min.

(3) The combined total annual average concentration of compounds in tables 8 and 9 to this subpart is greater than or equal to 30,000 ppmw, and the combined total annual load of compounds in tables 8 and 9 to this subpart is greater than or equal to 1 tpy.

(d) *Wastewater tank requirements.* (1) When §§63.133 and 63.147 reference floating roof requirements in §§63.119 and 63.120, the corresponding requirements in subpart WW of this part 63 may be applied for the purposes of this subpart.

(2) When §63.133(a) refers to table 10 of subpart G of this part 63, the maximum true vapor pressure in the table shall be limited to the HAP listed in tables 8 and 9 of this subpart FFFF.

(3) For the purposes of this subpart, the requirements of §63.133(a)(2) are satisfied by operating and maintaining a fixed roof if you demonstrate that the total soluble and partially soluble HAP emissions from the wastewater tank are no more than 5 percent higher than the emissions would be if the contents of the wastewater tank were not heated, treated by an exothermic reaction, or sparged.

(4) The emission limits specified in §§63.133(b)(2) and 63.139 for control devices used to control emissions from wastewater tanks do not apply during periods of planned routine maintenance of the control device(s) of no more than 240 hr/yr. You may request an extension to a total of 360 hr/yr in accordance with the procedures specified in §63.2470(d).

(e) *Individual drain systems.* The provisions of §63.136(e)(3) apply except as specified in paragraph (e)(1) of this section.

(1) A sewer line connected to drains that are in compliance with §63.136(e)(1) may be vented to the atmosphere, provided that the sewer line entrance to the first downstream junction box is water sealed and the sewer line vent pipe is designed as specified in §63.136(e)(2)(ii)(A).

(2) [Reserved]

(f) *Closed-vent system requirements.* When §63.148(k) refers to closed vent systems that are subject to the requirements of §63.172, the requirements of either §63.172 or §63.1034 apply for the purposes of this subpart.

(g) *Halogenated vent stream requirements.* For each halogenated vent stream from a Group 1 wastewater stream or residual removed from a Group 1 wastewater stream that is vented through a closed-vent system to a combustion device to reduce organic HAP emissions, you must meet the same emission limits as specified for batch process vents in item 2 of table 2 to this subpart.

(h) *Alternative test methods.* (1) As an alternative to the test methods specified in §63.144(b)(5)(i), you may use Method 8260 or 8270 as specified in §63.1257(b)(10)(iii).

(2) As an alternative to using the methods specified in §63.144(b)(5)(i), you may conduct wastewater analyses using Method 1666 or 1671 of 40 CFR part 136 and comply with the sampling protocol requirements specified in §63.144(b)(5)(ii). The validation requirements specified in §63.144(b)(5)(iii) do not apply if you use Method 1666 or 1671 of 40 CFR part 136.

(3) As an alternative to using Method 18 of 40 CFR part 60, as specified in §§63.139(c)(1)(ii) and 63.145(i)(2), you may elect to use Method 25A of 40 CFR part 60 as specified in §63.997.

(i) *Offsite management and treatment option.* (1) If you ship wastewater to an offsite treatment facility that meets the requirements of §63.138(h), you may elect to document in your notification of compliance status report that the wastewater will be treated as hazardous waste at a facility that meets the requirements of §63.138(h) as an alternative to having the offsite facility submit the certification specified in §63.132(g)(2).

(2) As an alternative to the management and treatment options specified in §63.132(g)(2), any affected wastewater stream (or residual removed from an affected wastewater stream) with a total annual average concentration of compounds in Table 8 to this subpart less than 50 ppmw may be transferred offsite in accordance with paragraphs (i)(2) (i) and (ii) of this section.

(i) The transferee (or you) must demonstrate that less than 5 percent of the HAP in Table 9 to this subpart is emitted from the waste management units up to the activated sludge unit.

(ii) The transferee must treat the wastewater stream or residual in a biological treatment unit in accordance with §§63.138 and 63.145 and the requirements referenced therein.

(j) You must determine the annual average concentration and annual average flowrate for wastewater streams for each MCPU. The procedures for flexible operation units specified in §63.144 (b) and (c) do not apply for the purposes of this subpart.

(k) The requirement to correct outlet concentrations from combustion devices to 3 percent oxygen in §§63.139(c)(1)(ii) and 63.146(i)(6) applies only if supplemental gases are combined with a vent stream from a Group 1 wastewater stream. If emissions are controlled with a vapor recovery system as specified in §63.139(c)(2), you must correct for supplemental gases as specified in §63.2460(c)(6).

(l) *Requirements for liquid streams in open systems.* (1) References in §63.149 to §63.100(b) mean §63.2435(b) for the purposes of this subpart.

(2) When §63.149(e) refers to 40 CFR 63.100(l) (1) or (2), §63.2445(a) applies for the purposes of this subpart.

(3) When §63.149 uses the term “chemical manufacturing process unit,” the term “MCPU” applies for the purposes of this subpart.

(4) When §63.149(e)(1) refers to characteristics of water that contain compounds in Table 9 to 40 CFR part 63, subpart G, the characteristics specified in paragraphs (c) (1) through (3) of this section apply for the purposes of this subpart.

(5) When §63.149(e)(2) refers to characteristics of water that contain compounds in Table 9 to 40 CFR part 63, subpart G, the characteristics specified in paragraph (c)(2) of this section apply for the purposes of this subpart.

(m) When §63.132(f) refers to “a concentration of greater than 10,000 ppmw of table 9 compounds,” the phrase “a concentration of greater than 30,000 ppmw of total partially soluble HAP (PSHAP) and soluble HAP (SHAP) or greater than 10,000 ppmw of PSHAP” shall apply for the purposes of this subpart.

(n) *Alternative requirements for wastewater that is Group 1 for soluble HAP only.* The option specified in this paragraph (n) applies to wastewater that is Group 1 for soluble HAP in accordance with paragraph (c)(3) of this section and is discharged to biological treatment. Except as provided in paragraph (n)(4) of this section, this option does not apply to wastewater that is Group 1 for partially soluble HAP in accordance with paragraph (c)(1), (c)(2), or (c)(4) of this section. For wastewater that is Group 1 for SHAP, you need not comply with §§63.133 through 63.137 for any equalization unit, neutralization unit, and/or clarifier prior to the activated sludge unit, and you need not comply with the venting requirements in §63.136(e)(2)(ii)(A) for lift stations with a volume larger than 10,000 gal, provided you comply with the requirements specified in paragraphs (n)(1) through (3) of this section and all otherwise applicable requirements specified in table 7 to this subpart. For this option, the treatment requirements in §63.138 and the performance testing requirements in §63.145 do not apply to the biological treatment unit, except as specified in paragraphs (n)(2)(i) through (iv) of this section.

(1) Wastewater must be hard-piped between the equalization unit, clarifier, and activated sludge unit. This requirement does not apply to the transfer between any of these types of units that are part of the same structure and one unit overflows into the next.

(2) Calculate the destruction efficiency of the biological treatment unit using Equation 1 of this section in accordance with the procedures described in paragraphs (n)(2)(i) through (vi) of this section. You have demonstrated initial compliance if E is greater than or equal to 90 percent.

$$E = \frac{(QMW_a - QMG_a - QMG_n - QMG_c)(F_{bio})}{QMW_a} \times 100 \quad (\text{Eq. 1})$$

[View or download PDF](#)

Where:

E = destruction efficiency of total PSHAP and SHAP for the biological treatment unit including the equalization unit, neutralization unit, and/or clarifier, percent;

QMW_a = mass flow rate of total PSHAP and SHAP compounds entering the equalization unit (or whichever of the three types of units is first), kilograms per hour (kg/hr);

QMG_a = mass flow rate of total PSHAP and SHAP compounds emitted from the equalization unit, kg/hr;

QMG_n = mass flow rate of total PSHAP and SHAP compounds emitted from the neutralization unit, kg/hr;

QMG_c = mass flow rate of total PSHAP and SHAP compounds emitted from the clarifier, kg/hr

F_{bio} = site-specific fraction of PSHAP and SHAP compounds biodegraded in the biological treatment unit.

(i) Include all PSHAP and SHAP compounds in both Group 1 and Group 2 wastewater streams from all MCPU, except you may exclude any compounds that meet the criteria specified in §63.145(a)(6)(ii) or (iii).

(ii) Conduct the demonstration under representative process unit and treatment unit operating conditions in accordance with §63.145(a)(3) and (4).

(iii) Determine PSHAP and SHAP concentrations and the total wastewater flow rate at the inlet to the equalization unit in accordance with §63.145(f)(1) and (2). References in §63.145(f)(1) and (2) to required mass removal and actual mass removal do not apply for the purposes of this section.

(iv) Determine F_{bio} for the activated sludge unit as specified in §63.145(h), except as specified in paragraph (n)(2)(iv)(A) or paragraph (n)(2)(iv)(B) of this section.

(A) If the biological treatment process meets both of the requirements specified in §63.145(h)(1)(i) and (ii), you may elect to replace the F_{bio} term in Equation 1 of this section with the numeral "1."

(B) You may elect to assume f_{bio} is zero for any compounds on List 2 of table 36 in subpart G.

(v) Determine QMG_e , QMG_n , and QMG_c using EPA's WATER9 model or the most recent update to this model, and conduct testing or use other procedures to validate the modeling results.

(vi) Submit the data and results of your demonstration, including both a description of and the results of your WATER9 modeling validation procedures, in your notification of compliance status report as specified in §63.2520(d)(2)(ii).

(3) As an alternative to the venting requirements in §63.136(e)(2)(ii)(A), a lift station with a volume larger than 10,000 gal may have openings necessary for proper venting of the lift station. The size and other design characteristics of these openings may be established based on manufacturer recommendations or engineering judgment for venting under normal operating conditions. You must describe the design of such openings and your supporting calculations and other rationale in your notification of compliance status report.

(4) For any wastewater streams that are Group 1 for both PSHAP and SHAP, you may elect to meet the requirements specified in table 7 to this subpart for the PSHAP and then comply with paragraphs (n)(1) through (3) of this section for the SHAP in the wastewater system. You may determine the SHAP mass removal rate, in kg/hr, in treatment units that are used to meet the requirements for PSHAP and add this amount to both the numerator and denominator in Equation 1 of this section.

(o) *Compliance records.* For each CPMS used to monitor a nonflare control device for wastewater emissions, you must keep records as specified in §63.998(c)(1) in addition to the records required in §63.147(d).

[68 FR 63888, Nov. 10, 2003, as amended at 70 FR 38559, July 1, 2005; 71 FR 40335, July 14, 2006]

 [Back to Top](#)

§63.2490 What requirements must I meet for heat exchange systems?

(a) You must comply with each requirement in Table 10 to this subpart that applies to your heat exchange systems, except as specified in paragraphs (b) and (c) of this section.

(b) The phrase “a chemical manufacturing process unit meeting the conditions of §63.100 (b)(1) through (b)(3) of this section” in §63.104(a) means “an MCPU meeting the conditions of §63.2435” for the purposes of this subpart.

(c) The reference to §63.100(c) in §63.104(a) does not apply for the purposes of this subpart.

[↑ Back to Top](#)

ALTERNATIVE MEANS OF COMPLIANCE

[↑ Back to Top](#)

§63.2495 How do I comply with the pollution prevention standard?

(a) You may elect to comply with the pollution prevention alternative requirements specified in paragraphs (a) (1) and (2) of this section in lieu of the emission limitations and work practice standards contained in Tables 1 through 7 to this subpart for any MCPU for which initial startup occurred before April 4, 2002.

(1) You must reduce the production-indexed HAP consumption factor (HAP factor) by at least 65 percent from a 3-year average baseline beginning no earlier than the 1994 through 1996 calendar years. For any reduction in the HAP factor that you achieve by reducing HAP that are also volatile organic compounds (VOC), you must demonstrate an equivalent reduction in the production-indexed VOC consumption factor (VOC factor) on a mass basis. For any reduction in the HAP factor that you achieve by reducing a HAP that is not a VOC, you may not increase the VOC factor.

(2) Any MCPU for which you seek to comply by using the pollution prevention alternative must begin with the same starting material(s) and end with the same product(s). You may not comply by eliminating any steps of a process by transferring the step offsite (to another manufacturing location). You may also not merge a solvent recovery step conducted offsite to onsite and as part of an existing process as a method of reducing consumption.

(3) You may comply with the requirements of paragraph (a)(1) of this section for a series of processes, including situations where multiple processes are merged, if you demonstrate to the satisfaction of the Administrator that the multiple processes were merged after the baseline period into an existing process or processes.

(b) *Exclusions.* (1) You must comply with the emission limitations and work practice standards contained in tables 1 through 7 of this subpart for all HAP that are generated in the MCPU and that are not included in consumption, as defined in §63.2550. If any vent stream routed to the combustion control is a halogenated vent stream, as defined in §63.2550, then hydrogen halides that are generated as a result of combustion control must be controlled according to the requirements of §63.994 and the requirements referenced therein.

(2) You may not merge nondedicated formulation or nondedicated solvent recovery processes with any other processes.

(c) *Initial compliance procedures.* To demonstrate initial compliance with paragraph (a) of this section, you must prepare a demonstration summary in accordance with paragraph (c) (1) of this section and calculate baseline and target annual HAP and VOC factors in accordance with paragraphs (c) (2) and (3) of this section.

(1) *Demonstration plan.* You must prepare a pollution prevention demonstration plan that contains, at a minimum, the information in paragraphs (c)(1) (i) through (iii) of this section for each MCPU for which you comply with paragraph (a) of this section.

(i) Descriptions of the methodologies and forms used to measure and record consumption of HAP and VOC compounds.

(ii) Descriptions of the methodologies and forms used to measure and record production of the product(s).

(iii) Supporting documentation for the descriptions provided in accordance with paragraphs (c)(1) (i) and (ii) of this section including, but not limited to, samples of operator log sheets and daily, monthly, and/or annual inventories of materials and products. You must describe how this documentation will be used to calculate the annual factors required in paragraph (d) of this section.

(2) *Baseline factors.* You must calculate baseline HAP and VOC factors by dividing the consumption of total HAP and total VOC by the production rate, per process, for the first 3-year period in which the process was operational, beginning no earlier than the period consisting of the 1994 through 1996 calendar years.

(3) *Target annual factors.* You must calculate target annual HAP and VOC factors. The target annual HAP factor must be equal to 35 percent of the baseline HAP factor. The target annual VOC factor must be lower than the baseline VOC factor by an amount equivalent to the reduction in any HAP that is also a VOC, on a mass basis. The target annual VOC factor may be the same as the baseline VOC factor if the only HAP you reduce is not a VOC.

(d) *Continuous compliance requirements.* You must calculate annual rolling average values of the HAP and VOC factors (annual factors) in accordance with the procedures specified in paragraphs (d) (1) through (3) of this section. To show continuous compliance, the annual factors must be equal to or less than the target annual factors calculated according to paragraph (c)(3) of this section.

(1) To calculate the annual factors, you must divide the consumption of both total HAP and total VOC by the production rate, per process, for 12-month periods at the frequency specified in either paragraph (d) (2) or (3) of this section, as applicable.

(2) For continuous processes, you must calculate the annual factors every 30 days for the 12-month period preceding the 30th day (i.e., annual rolling average calculated every 30 days). A process with both batch and continuous operations is considered a continuous process for the purposes of this section.

(3) For batch processes, you must calculate the annual factors every 10 batches for the 12-month period preceding the 10th batch (i.e., annual rolling average calculated every 10 batches), except as specified in paragraphs (d)(3) (i) and (ii) of this section.

(i) If you produce more than 10 batches during a month, you must calculate the annual factors at least once during that month.

(ii) If you produce less than 10 batches in a 12-month period, you must calculate the annual factors for the number of batches in the 12-month period since the previous calculations.

(e) *Records.* You must keep records of HAP and VOC consumption, production, and the rolling annual HAP and VOC factors for each MCPU for which you are complying with paragraph (a) of this section.

(f) *Reporting.* (1) You must include the pollution prevention demonstration plan in the precompliance report required by §63.2520(c).

(2) You must identify all days when the annual factors were above the target factors in the compliance reports.

[68 FR 63888, Nov. 10, 2003, as amended at 71 FR 40336, July 14, 2006]

[↑ Back to Top](#)

§63.2500 How do I comply with emissions averaging?

(a) For an existing source, you may elect to comply with the percent reduction emission limitations in Tables 1, 2, 4, 5, and 7 to this subpart by complying with the emissions averaging provisions specified in §63.150, except as specified in paragraphs (b) through (f) of this section.

(b) The batch process vents in an MCPU collectively are considered one individual emission point for the purposes of emissions averaging, except that only individual batch process vents must be excluded to meet the requirements of §63.150(d)(5).

(c) References in §63.150 to §§63.112 through 63.130 mean the corresponding requirements in §§63.2450 through 63.2490, including applicable monitoring, recordkeeping, and reporting.

(d) References to “periodic reports” in §63.150 mean “compliance report” for the purposes of this subpart.

(e) For batch process vents, estimate uncontrolled emissions for a standard batch using the procedures in §63.1257(d)(2)(i) and (ii) instead of the procedures in §63.150(g)(2). Multiply the calculated emissions per batch by the number of batches per month when calculating the monthly emissions for use in calculating debits and credits.

(f) References to “storage vessels” in §63.150 mean “storage tank” as defined in §63.2550 for the purposes of this subpart.

[↑ Back to Top](#)

§63.2505 How do I comply with the alternative standard?

As an alternative to complying with the emission limits and work practice standards for process vents and storage tanks in Tables 1 through 4 to this subpart and the requirements in §§63.2455 through 63.2470, you may comply with the emission limits in paragraph (a) of this section and demonstrate compliance in accordance with the requirements in paragraph (b) of this section.

(a) *Emission limits and work practice standards.* (1) You must route vent streams through a closed-vent system to a control device that reduces HAP emissions as specified in either paragraph (a)(1)(i) or (ii) of this section.

(i) If you use a combustion control device, it must reduce HAP emissions as specified in paragraphs (a)(1)(i)(A), (B), and (C) of this section.

(A) To an outlet TOC concentration of 20 parts per million by volume (ppmv) or less.

(B) To an outlet concentration of hydrogen halide and halogen HAP of 20 ppmv or less.

(C) As an alternative to paragraph (a)(1)(i)(B) of this section, if you control halogenated vent streams emitted from a combustion device followed by a scrubber, reduce the hydrogen halide and halogen HAP generated in the combustion device by greater than or equal to 95 percent by weight in the scrubber.

(ii) If you use a noncombustion control device(s), it must reduce HAP emissions to an outlet total organic HAP concentration of 50 ppmv or less, and an outlet concentration of hydrogen halide and halogen HAP of 50 ppmv or less.

(2) Any Group 1 process vents within a process that are not controlled according to this alternative standard must be controlled according to the emission limits in tables 1 through 3 to this subpart.

(b) *Compliance requirements.* To demonstrate compliance with paragraph (a) of this section, you must meet the requirements of §63.1258(b)(5) beginning no later than the initial compliance date specified in §63.2445, except as specified in paragraphs (b)(1) through (9) of this section.

(1) You must comply with the requirements in §63.983 and the requirements referenced therein for closed-vent systems.

(2) When §63.1258(b)(5)(i) refers to §§63.1253(d) and 63.1254(c), the requirements in paragraph (a) of this section apply for the purposes of this subpart FFFF.

(3) When §63.1258(b)(5)(i)(B) refers to "HCl," it means "total hydrogen halide and halogen HAP" for the purposes of this subpart FFFF.

(4) When §63.1258(b)(5)(ii) refers to §63.1257(a)(3), it means §63.2450(j)(5) for the purposes of this subpart FFFF.

(5) You must submit the results of any determination of the target analytes of predominant HAP in the notification of compliance status report.

(6) If you elect to comply with the requirement to reduce hydrogen halide and halogen HAP by greater than or equal to 95 percent by weight in paragraph (a)(1)(i)(C) of this section, you must meet the requirements in paragraphs (b)(6)(i) and (ii) of this section.

(i) Demonstrate initial compliance with the 95 percent reduction by conducting a performance test and setting a site-specific operating limit(s) for the scrubber in accordance with §63.994 and the requirements referenced therein. You must submit the results of the initial compliance demonstration in the notification of compliance status report.

(ii) Install, operate, and maintain CPMS for the scrubber as specified in §§63.994(c) and 63.2450(k), instead of as specified in §63.1258(b)(5)(i)(C).

(7) If flow to the scrubber could be intermittent, you must install, calibrate, and operate a flow indicator as specified in §63.2460(c)(7).

(8) Use the operating day as the averaging period for CEMS data and scrubber parameter monitoring data.

(9) The requirements in paragraph (a) of this section do not apply to emissions from storage tanks during periods of planned routine maintenance of the control device that do not exceed 240 hr/yr. You

may submit an application to the Administrator requesting an extension of this time limit to a total of 360 hr/yr in accordance with the procedures specified in §63.2470(d). You must comply with the recordkeeping and reporting specified in §§63.998(d)(2)(ii) and 63.999(c)(4) for periods of planned routine maintenance.

[68 FR 63888, Nov. 10, 2003, as amended at 70 FR 38559, July 1, 2005]

[↑ Back to Top](#)

NOTIFICATION, REPORTS, AND RECORDS

[↑ Back to Top](#)

§63.2515 What notifications must I submit and when?

(a) You must submit all of the notifications in §§63.6(h)(4) and (5), 63.7(b) and (c), 63.8(e), (f)(4) and (6), and 63.9(b) through (h) that apply to you by the dates specified.

(b) *Initial notification.* As specified in §63.9(b)(2), if you startup your affected source before November 10, 2003, you must submit an initial notification not later than 120 calendar days after November 10, 2003.

(2) As specified in §63.9(b)(3), if you startup your new affected source on or after November 10, 2003, you must submit an initial notification not later than 120 calendar days after you become subject to this subpart.

(c) *Notification of performance test.* If you are required to conduct a performance test, you must submit a notification of intent to conduct a performance test at least 60 calendar days before the performance test is scheduled to begin as required in §63.7(b)(1). For any performance test required as part of the initial compliance procedures for batch process vents in table 2 to this subpart, you must also submit the test plan required by §63.7(c) and the emission profile with the notification of the performance test.

[↑ Back to Top](#)

§63.2520 What reports must I submit and when?

(a) You must submit each report in Table 11 to this subpart that applies to you.

(b) Unless the Administrator has approved a different schedule for submission of reports under §63.10(a), you must submit each report by the date in table 11 to this subpart and according to paragraphs (b)(1) through (5) of this section.

(1) The first compliance report must cover the period beginning on the compliance date that is specified for your affected source in §63.2445 and ending on June 30 or December 31, whichever date is the first date following the end of the first 6 months after the compliance date that is specified for your affected source in §63.2445.

(2) The first compliance report must be postmarked or delivered no later than August 31 or February 28, whichever date is the first date following the end of the first reporting period specified in paragraph (b)(1) of this section.

(3) Each subsequent compliance report must cover the semiannual reporting period from January 1 through June 30 or the semiannual reporting period from July 1 through December 31.

(4) Each subsequent compliance report must be postmarked or delivered no later than August 31 or February 28, whichever date is the first date following the end of the semiannual reporting period.

(5) For each affected source that is subject to permitting regulations pursuant to 40 CFR part 70 or 40 CFR part 71, and if the permitting authority has established dates for submitting semiannual reports pursuant to 40 CFR 70.6(a)(3)(iii)(A) or 40 CFR 71.6(a)(3)(iii)(A), you may submit the first and subsequent compliance reports according to the dates the permitting authority has established instead of according to the dates in paragraphs (b)(1) through (4) of this section.

(c) *Precompliance report.* You must submit a precompliance report to request approval for any of the items in paragraphs (c)(1) through (7) of this section. We will either approve or disapprove the report within 90 days after we receive it. If we disapprove the report, you must still be in compliance with the emission limitations and work practice standards in this subpart by the compliance date. To change any of the information submitted in the report, you must notify us 60 days before the planned change is to be implemented.

(1) Requests for approval to set operating limits for parameters other than those specified in §§63.2455 through 63.2485 and referenced therein. Alternatively, you may make these requests according to §63.8(f).

(2) Descriptions of daily or per batch demonstrations to verify that control devices subject to §63.2460(c)(5) are operating as designed.

(3) A description of the test conditions, data, calculations, and other information used to establish operating limits according to §63.2460(c)(3).

(4) Data and rationale used to support an engineering assessment to calculate uncontrolled emissions in accordance with §63.1257(d)(2)(ii). This requirement does not apply to calculations of hydrogen halide and halogen HAP emissions as specified in §63.2465(b), to determinations that the total HAP concentration is less than 50 ppmv, or if you use previous test data to establish the uncontrolled emissions.

(5) The pollution prevention demonstration plan required in §63.2495(c)(1), if you are complying with the pollution prevention alternative.

(6) Documentation of the practices that you will implement to minimize HAP emissions from streams that contain energetics and organic peroxides, and rationale for why meeting the emission limit specified in tables 1 through 7 to this subpart would create an undue safety hazard.

(7) For fabric filters that are monitored with bag leak detectors, an operation and maintenance plan that describes proper operation and maintenance procedures, and a corrective action plan that describes corrective actions to be taken, and the timing of those actions, when the PM concentration exceeds the set point and activates the alarm.

(d) *Notification of compliance status report.* You must submit a notification of compliance status report according to the schedule in paragraph (d)(1) of this section, and the notification of compliance status report must contain the information specified in paragraph (d)(2) of this section.

(1) You must submit the notification of compliance status report no later than 150 days after the applicable compliance date specified in §63.2445.

(2) The notification of compliance status report must include the information in paragraphs (d)(2)(i) through (ix) of this section.

(i) The results of any applicability determinations, emission calculations, or analyses used to identify and quantify HAP usage or HAP emissions from the affected source.

(ii) The results of emissions profiles, performance tests, engineering analyses, design evaluations, flare compliance assessments, inspections and repairs, and calculations used to demonstrate initial compliance according to §§63.2455 through 63.2485. For performance tests, results must include descriptions of sampling and analysis procedures and quality assurance procedures.

(iii) Descriptions of monitoring devices, monitoring frequencies, and the operating limits established during the initial compliance demonstrations, including data and calculations to support the levels you establish.

(iv) All operating scenarios.

(v) Descriptions of worst-case operating and/or testing conditions for control devices.

(vi) Identification of parts of the affected source subject to overlapping requirements described in §63.2535 and the authority under which you will comply.

(vii) The information specified in §63.1039(a)(1) through (3) for each process subject to the work practice standards for equipment leaks in Table 6 to this subpart.

(viii) Identify storage tanks for which you are complying with the vapor balancing alternative in §63.2470(e).

(ix) Records as specified in §63.2535(l)(1) through (3) of process units used to create a PUG and calculations of the initial primary product of the PUG.

(e) *Compliance report.* The compliance report must contain the information specified in paragraphs (e)(1) through (10) of this section.

(1) Company name and address.

(2) Statement by a responsible official with that official's name, title, and signature, certifying the accuracy of the content of the report.

(3) Date of report and beginning and ending dates of the reporting period.

(4) For each SSM during which excess emissions occur, the compliance report must include records that the procedures specified in your startup, shutdown, and malfunction plan (SSMP) were followed or documentation of actions taken that are not consistent with the SSMP, and include a brief description of each malfunction.

(5) The compliance report must contain the information on deviations, as defined in §63.2550, according to paragraphs (e)(5)(i), (ii), (iii), and (iv) of this section.

(i) If there are no deviations from any emission limit, operating limit or work practice standard specified in this subpart, include a statement that there were no deviations from the emission limits, operating limits, or work practice standards during the reporting period.

(ii) For each deviation from an emission limit, operating limit, and work practice standard that occurs at an affected source where you are not using a continuous monitoring system (CMS) to comply with the emission limit or work practice standard in this subpart, you must include the information in paragraphs (e)(5)(ii)(A) through (C) of this section. This includes periods of SSM.

(A) The total operating time of the affected source during the reporting period.

(B) Information on the number, duration, and cause of deviations (including unknown cause, if applicable), as applicable, and the corrective action taken.

(C) Operating logs of processes with batch vents from batch operations for the day(s) during which the deviation occurred, except operating logs are not required for deviations of the work practice standards for equipment leaks.

(iii) For each deviation from an emission limit or operating limit occurring at an affected source where you are using a CMS to comply with an emission limit in this subpart, you must include the information in paragraphs (e)(5)(iii)(A) through (L) of this section. This includes periods of SSM.

(A) The date and time that each CMS was inoperative, except for zero (low-level) and high-level checks.

(B) The date, time, and duration that each CEMS was out-of-control, including the information in §63.8(c)(8).

(C) The date and time that each deviation started and stopped, and whether each deviation occurred during a period of startup, shutdown, or malfunction or during another period.

(D) A summary of the total duration of the deviation during the reporting period, and the total duration as a percent of the total operating time of the affected source during that reporting period.

(E) A breakdown of the total duration of the deviations during the reporting period into those that are due to startup, shutdown, control equipment problems, process problems, other known causes, and other unknown causes.

(F) A summary of the total duration of CMS downtime during the reporting period, and the total duration of CMS downtime as a percent of the total operating time of the affected source during that reporting period.

(G) An identification of each HAP that is known to be in the emission stream.

(H) A brief description of the process units.

(I) A brief description of the CMS.

(J) The date of the latest CMS certification or audit.

(K) Operating logs of processes with batch vents from batch operations for each day(s) during which the deviation occurred.

(L) The operating day or operating block average values of monitored parameters for each day(s) during which the deviation occurred.

(iv) If you documented in your notification of compliance status report that an MCPU has Group 2 batch process vents because the non-reactive HAP is the only HAP and usage is less than 10,000 lb/yr, the total uncontrolled organic HAP emissions from the batch process vents in an MCPU will be less than 1,000 lb/yr for the anticipated number of standard batches, or total uncontrolled hydrogen halide and halogen HAP emissions from all batch process vents and continuous process vents in a process are less than 1,000 lb/yr, include the records associated with each calculation required by §63.2525(e) that exceeds an applicable HAP usage or emissions threshold.

(6) If you use a CEMS, and there were no periods during which it was out-of-control as specified in §63.8(c)(7), include a statement that there were no periods during which the CEMS was out-of-control during the reporting period.

(7) Include each new operating scenario which has been operated since the time period covered by the last compliance report and has not been submitted in the notification of compliance status report or a previous compliance report. For each new operating scenario, you must provide verification that the operating conditions for any associated control or treatment device have not been exceeded and that any required calculations and engineering analyses have been performed. For the purposes of this paragraph, a revised operating scenario for an existing process is considered to be a new operating scenario.

(8) Records of process units added to a PUG as specified in §63.2525(i)(4) and records of primary product redeterminations as specified in §63.2525(i)(5).

(9) Applicable records and information for periodic reports as specified in referenced subparts F, G, H, SS, UU, WW, and GGG of this part and subpart F of 40 CFR part 65.

(10) *Notification of process change.* (i) Except as specified in paragraph (e)(10)(ii) of this section, whenever you make a process change, or change any of the information submitted in the notification of compliance status report or a previous compliance report, that is not within the scope of an existing operating scenario, you must document the change in your compliance report. A process change does not include moving within a range of conditions identified in the standard batch, and a nonstandard batch does not constitute a process change. The notification must include all of the information in paragraphs (e)(10)(i)(A) through (C) of this section.

(A) A description of the process change.

(B) Revisions to any of the information reported in the original notification of compliance status report under paragraph (d) of this section.

(C) Information required by the notification of compliance status report under paragraph (d) of this section for changes involving the addition of processes or equipment at the affected source.

(ii) You must submit a report 60 days before the scheduled implementation date of any of the changes identified in paragraph (e)(10)(ii)(A), (B), or (C) of this section.

(A) Any change to the information contained in the precompliance report.

(B) A change in the status of a control device from small to large.

(C) A change from Group 2 to Group 1 for any emission point except for batch process vents that meet the conditions specified in §63.2460(b)(6)(i).

[↑ Back to Top](#)

§63.2525 What records must I keep?

You must keep the records specified in paragraphs (a) through (k) of this section.

(a) Each applicable record required by subpart A of this part 63 and in referenced subparts F, G, SS, UU, WW, and GGG of this part 63 and in referenced subpart F of 40 CFR part 65.

(b) Records of each operating scenario as specified in paragraphs (b)(1) through (8) of this section.

(1) A description of the process and the type of process equipment used.

(2) An identification of related process vents, including their associated emissions episodes if not complying with the alternative standard in §63.2505; wastewater point of determination (POD); storage tanks; and transfer racks.

(3) The applicable control requirements of this subpart, including the level of required control, and for vents, the level of control for each vent.

(4) The control device or treatment process used, as applicable, including a description of operating and/or testing conditions for any associated control device.

(5) The process vents, wastewater POD, transfer racks, and storage tanks (including those from other processes) that are simultaneously routed to the control device or treatment process(s).

(6) The applicable monitoring requirements of this subpart and any parametric level that assures compliance for all emissions routed to the control device or treatment process.

(7) Calculations and engineering analyses required to demonstrate compliance.

(8) For reporting purposes, a change to any of these elements not previously reported, except for paragraph (b)(5) of this section, constitutes a new operating scenario.

(c) A schedule or log of operating scenarios for processes with batch vents from batch operations updated each time a different operating scenario is put into effect.

(d) The information specified in paragraphs (d)(1) and (2) of this section for Group 1 batch process vents in compliance with a percent reduction emission limit in Table 2 to this subpart if some of the vents are controlled to less the percent reduction requirement.

(1) Records of whether each batch operated was considered a standard batch.

(2) The estimated uncontrolled and controlled emissions for each batch that is considered to be a nonstandard batch.

(e) The information specified in paragraph (e)(2), (3), or (4) of this section, as applicable, for each process with Group 2 batch process vents or uncontrolled hydrogen halide and halogen HAP emissions from the sum of all batch and continuous process vents less than 1,000 lb/yr. No records are required for situations described in paragraph (e)(1) of this section.

(1) No records are required if you documented in your notification of compliance status report that the MCPU meets any of the situations described in paragraph (e)(1)(i), (ii), or (iii) of this section.

(i) The MCPU does not process, use, or generate HAP.

(ii) You control the Group 2 batch process vents using a flare that meets the requirements of §63.987.

(iii) You control the Group 2 batch process vents using a control device for which your determination of worst case for initial compliance includes the contribution of all Group 2 batch process vents.

(2) If you documented in your notification of compliance status report that an MCPU has Group 2 batch process vents because the non-reactive organic HAP is the only HAP and usage is less than 10,000 lb/yr, as specified in §63.2460(b)(7), you must keep records of the amount of HAP material used, and calculate the daily rolling annual sum of the amount used no less frequently than monthly. If a record indicates usage exceeds 10,000 lb/yr, you must estimate emissions for the preceding 12 months based on the number of batches operated and the estimated emissions for a standard batch, and you must begin recordkeeping as specified in paragraph (e)(4) of this section. After 1 year, you may revert to recording only usage if the usage during the year is less than 10,000 lb.

(3) If you documented in your notification of compliance status report that total uncontrolled organic HAP emissions from the batch process vents in an MCPU will be less than 1,000 lb/yr for the anticipated number of standard batches, then you must keep records of the number of batches operated and calculate a daily rolling annual sum of batches operated no less frequently than monthly. If the number of batches operated results in organic HAP emissions that exceed 1,000 lb/yr, you must estimate emissions for the preceding 12 months based on the number of batches operated and the estimated emissions for a standard batch, and you must begin recordkeeping as specified in paragraph (e)(4) of this section. After 1 year, you may revert to recording only the number of batches if the number of batches operated during the year results in less than 1,000 lb of organic HAP emissions.

(4) If you meet none of the conditions specified in paragraphs (e)(1) through (3) of this section, you must keep records of the information specified in paragraphs (e)(4)(i) through (iv) of this section.

(i) A record of the day each batch was completed and/or the operating hours per day for continuous operations with hydrogen halide and halogen emissions.

(ii) A record of whether each batch operated was considered a standard batch.

(iii) The estimated uncontrolled and controlled emissions for each batch that is considered to be a nonstandard batch.

(iv) Records of the daily 365-day rolling summations of emissions, or alternative records that correlate to the emissions (e.g., number of batches), calculated no less frequently than monthly.

(f) A record of each time a safety device is opened to avoid unsafe conditions in accordance with §63.2450(s).

(g) Records of the results of each CPMS calibration check and the maintenance performed, as specified in §63.2450(k)(1).

(h) For each CEMS, you must keep records of the date and time that each deviation started and stopped, and whether the deviation occurred during a period of startup, shutdown, or malfunction or during another period.

(i) For each PUG, you must keep records specified in paragraphs (i)(1) through (5) of this section.

(1) Descriptions of the MCPU and other process units in the initial PUG required by §63.2535(l)(1)(v).

(2) Rationale for including each MCPU and other process unit in the initial PUG (*i.e.*, identify the overlapping equipment between process units) required by §63.2535(l)(1)(v).

(3) Calculations used to determine the primary product for the initial PUG required by §63.2535(l)(2)(iv).

(4) Descriptions of process units added to the PUG after the creation date and rationale for including the additional process units in the PUG as required by §63.2535(l)(1)(v).

(5) The calculation of each primary product redetermination required by §63.2535(l)(2)(iv).

(j) In the SSMP required by §63.6(e)(3), you are not required to include Group 2 emission points, unless those emission points are used in an emissions average. For equipment leaks, the SSMP requirement is limited to control devices and is optional for other equipment.

(k) For each bag leak detector used to monitor PM HAP emissions from a fabric filter, maintain records of any bag leak detection alarm, including the date and time, with a brief explanation of the cause of the alarm and the corrective action taken.

[68 FR 63888, Nov. 10, 2003, as amended at 70 FR 38560, July 1, 2005; 71 FR 40337, July 14, 2006]

[↑ Back to Top](#)

OTHER REQUIREMENTS AND INFORMATION

[↑ Back to Top](#)

§63.2535 What compliance options do I have if part of my plant is subject to both this subpart and another subpart?

For any equipment, emission stream, or wastewater stream subject to the provisions of both this subpart and another rule, you may elect to comply only with the provisions as specified in paragraphs (a) through (l) of this section. You also must identify the subject equipment, emission stream, or wastewater stream, and the provisions with which you will comply, in your notification of compliance status report required by §63.2520(d).

(a) *Compliance with other subparts of this part 63.* (1) If you have an MCPU that includes a batch process vent that also is part of a CMPU as defined in subparts F and G of this part 63, you must comply with the emission limits; operating limits; work practice standards; and the compliance, monitoring, reporting, and recordkeeping requirements for batch process vents in this subpart, and you must continue to comply with the requirements in subparts F, G, and H of this part 63 that are applicable to the CMPU and associated equipment.

(2) After the compliance dates specified in §63.2445, at an offsite reloading or cleaning facility subject to §63.1253(f), as referenced from §63.2470(e), compliance with the monitoring, recordkeeping, and reporting provisions of any other subpart of this part 63 constitutes compliance with the monitoring, recordkeeping, and reporting provisions of §63.1253(f)(7)(ii) or §63.1253(f)(7)(iii). You must identify in

your notification of compliance status report required by §63.2520(d) the subpart of this part 63 with which the owner or operator of the offsite reloading or cleaning facility complies.

(b) *Compliance with 40 CFR parts 264 and 265, subparts AA, BB, and/or CC.* (1) After the compliance dates specified in §63.2445, if a control device that you use to comply with this subpart is also subject to monitoring, recordkeeping, and reporting requirements in 40 CFR part 264, subpart AA, BB, or CC; or the monitoring and recordkeeping requirements in 40 CFR part 265, subpart AA, BB, or CC; and you comply with the periodic reporting requirements under 40 CFR part 264, subpart AA, BB, or CC that would apply to the device if your facility had final-permitted status, you may elect to comply either with the monitoring, recordkeeping, and reporting requirements of this subpart; or with the monitoring and recordkeeping requirements in 40 CFR part 264 or 265 and the reporting requirements in 40 CFR part 264, as described in this paragraph (b)(1), which constitute compliance with the monitoring, recordkeeping, and reporting requirements of this subpart. If you elect to comply with the monitoring, recordkeeping, and reporting requirements in 40 CFR parts 264 and/or 265, you must report the information described in §63.2520(e).

(2) After the compliance dates specified in §63.2445, if you have an affected source with equipment that is also subject to 40 CFR part 264, subpart BB, or to 40 CFR part 265, subpart BB, then compliance with the recordkeeping and reporting requirements of 40 CFR parts 264 and/or 265 may be used to comply with the recordkeeping and reporting requirements of this subpart, to the extent that the requirements of 40 CFR parts 264 and/or 265 duplicate the requirements of this subpart.

(c) *Compliance with 40 CFR part 60, subpart Kb and 40 CFR part 61, subpart Y.* After the compliance dates specified in §63.2445, you are in compliance with the provisions of this subpart FFFF for any storage tank that is assigned to an MCPU and that is both controlled with a floating roof and in compliance with the provisions of either 40 CFR part 60, subpart Kb, or 40 CFR part 61, subpart Y. You are in compliance with this subpart FFFF if you have a storage tank with a fixed roof, closed-vent system, and control device in compliance with the provisions of either 40 CFR part 60, subpart Kb, or 40 CFR part 61, subpart Y, except that you must comply with the monitoring, recordkeeping, and reporting requirements in this subpart FFFF. Alternatively, if a storage tank assigned to an MCPU is subject to control under 40 CFR part 60, subpart Kb, or 40 CFR part 61, subpart Y, you may elect to comply only with the requirements for Group 1 storage tanks in this subpart FFFF.

(d) *Compliance with subpart I, GGG, or MMM of this part 63.* After the compliance dates specified in §63.2445, if you have an affected source with equipment subject to subpart I, GGG, or MMM of this part 63, you may elect to comply with the provisions of subpart H, GGG, or MMM of this part 63, respectively, for all such equipment.

(e) *Compliance with subpart GGG of this part 63 for wastewater.* After the compliance dates specified in §63.2445, if you have an affected source subject to this subpart and you have an affected source that generates wastewater streams that meet the applicability thresholds specified in §63.1256, you may elect to comply with the provisions of this subpart FFFF for all such wastewater streams.

(f) *Compliance with subpart MMM of this part 63 for wastewater.* After the compliance dates specified in §63.2445, if you have an affected source subject to this subpart, and you have an affected source that generates wastewater streams that meet the applicability thresholds specified in §63.1362(d), you may elect to comply with the provisions of this subpart FFFF for all such wastewater streams (except that the 99 percent reduction requirement for streams subject to §63.1362(d)(10) still applies).

(g) *Compliance with other regulations for wastewater.* After the compliance dates specified in §63.2445, if you have a Group 1 wastewater stream that is also subject to provisions in 40 CFR parts 260 through 272, you may elect to determine whether this subpart or 40 CFR parts 260 through 272 contain the more stringent control requirements (e.g., design, operation, and inspection requirements for waste management units; numerical treatment standards; etc.) and the more stringent testing, monitoring,

recordkeeping, and reporting requirements. Compliance with provisions of 40 CFR parts 260 through 272 that are determined to be more stringent than the requirements of this subpart constitute compliance with this subpart. For example, provisions of 40 CFR parts 260 through 272 for treatment units that meet the conditions specified in §63.138(h) constitute compliance with this subpart. You must identify in the notification of compliance status report required by §63.2520(d) the information and procedures that you used to make any stringency determinations.

(h) *Compliance with 40 CFR part 60, subpart DDD, III, NNN, or RRR.* After the compliance dates specified in §63.2445, if you have an MCPU that contains equipment subject to the provisions of this subpart that are also subject to the provisions of 40 CFR part 60, subpart DDD, III, NNN, or RRR, you may elect to apply this subpart to all such equipment in the MCPU. If an MCPU subject to the provisions of this subpart has equipment to which this subpart does not apply but which is subject to a standard in 40 CFR part 60, subpart DDD, III, NNN, or RRR, you may elect to comply with the requirements for Group 1 process vents in this subpart for such equipment. If you elect any of these methods of compliance, you must consider all total organic compounds, minus methane and ethane, in such equipment for purposes of compliance with this subpart, as if they were organic HAP. Compliance with the provisions of this subpart, in the manner described in this paragraph (h), will constitute compliance with 40 CFR part 60, subpart DDD, III, NNN, or RRR, as applicable.

(i) *Compliance with 40 CFR part 61, subpart BB.* (1) After the compliance dates specified in §63.2445, a Group 1 transfer rack, as defined in §63.2550, that is also subject to the provisions of 40 CFR part 61, subpart BB, you are required to comply only with the provisions of this subpart.

(2) After the compliance dates specified in §63.2445, a Group 2 transfer rack, as defined in §63.2550, that is also subject to the provisions of 40 CFR part 61, subpart BB, is required to comply with the provisions of either paragraph (l)(2)(i) or (ii) of this section.

(i) If the transfer rack is subject to the control requirements specified in §61.302 of 40 CFR part 61, subpart BB, then you may elect to comply with either the requirements of 40 CFR part 61, subpart BB, or the requirements for Group 1 transfer racks under this subpart FFFF.

(ii) If the transfer rack is subject only to reporting and recordkeeping requirements under 40 CFR part 61, subpart BB, then you are required to comply only with the reporting and recordkeeping requirements specified in this subpart for Group 2 transfer racks, and you are exempt from the reporting and recordkeeping requirements in 40 CFR part 61, subpart BB.

(j) *Compliance with 40 CFR part 61, subpart FF.* After the compliance date specified in §63.2445, for a Group 1 or Group 2 wastewater stream that is also subject to the provisions of 40 CFR 61.342(c) through (h), and is not exempt under 40 CFR 61.342(c)(2) or (3), you may elect to comply only with the requirements for Group 1 wastewater streams in this subpart FFFF. If a Group 2 wastewater stream is exempted from 40 CFR 61.342(c)(1) under 40 CFR 61.342(c)(2) or (3), then you are required to comply only with the reporting and recordkeeping requirements specified in this subpart for Group 2 wastewater streams, and you are exempt from the requirements in 40 CFR part 61, subpart FF.

(k) *Compliance with 40 CFR part 60, subpart VV, and 40 CFR part 61, subpart V.* After the compliance date specified in §63.2445, if you have an affected source with equipment that is also subject to the requirements of 40 CFR part 60, subpart VV, or 40 CFR part 61, subpart V, you may elect to apply this subpart to all such equipment. After the compliance date specified in §63.2445, if you have an affected source with equipment to which this subpart does not apply, but which is subject to the requirements of 40 CFR part 60, subpart VV, or 40 CFR part 61, subpart V, you may elect to apply this subpart to all such equipment. If you elect either of these methods of compliance, you must consider all total organic compounds, minus methane and ethane, in such equipment for purposes of compliance with this subpart, as if they were organic HAP. Compliance with the provisions of this subpart, in the manner

described in this paragraph (k), will constitute compliance with 40 CFR part 60, subpart VV and 40 CFR part 61, subpart V, as applicable.

(l) *Applicability of process units included in a process unit group.* You may elect to develop and comply with the requirements for PUG in accordance with paragraphs (l)(1) through (3) of this section.

(1) *Procedures to create process unit groups.* Develop and document changes in a PUG in accordance with the procedures specified in paragraphs (l)(1)(i) through (v) of this section.

(i) Initially, identify an MCPU that is created from nondedicated equipment that will operate on or after November 10, 2003 and identify all processing equipment that is part of this MCPU, based on descriptions in operating scenarios.

(ii) Add to the group any other nondedicated MCPU and other nondedicated process units expected to be operated in the 5 years after the date specified in paragraph (l)(1)(i) of this section, provided they satisfy the criteria specified in paragraphs (l)(1)(ii)(A) through (C) of this section. Also identify all of the processing equipment used for each process unit based on information from operating scenarios and other applicable documentation.

(A) Each process unit that is added to a group must have some processing equipment that is also part of one or more process units in the group.

(B) No process unit may be part of more than one PUG.

(C) The processing equipment used to satisfy the requirement of paragraph (l)(1)(ii)(A) of this section may not be a storage tank or control device.

(iii) The initial PUG consists of all of the processing equipment for the process units identified in paragraphs (l)(1)(i) and (ii) of this section. As an alternative to the procedures specified in paragraphs (l)(1)(i) and (ii) of this section, you may use a PUG that was developed in accordance with §63.1360(h) as your initial PUG.

(iv) Add process units developed in the future in accordance with the conditions specified in paragraphs (l)(1)(ii)(A) and (B) of this section.

(v) Maintain records that describe the process units in the initial PUG, the procedure used to create the PUG, and subsequent changes to each PUG as specified in §63.2525(i). Submit the records in reports as specified in §63.2520(d)(2)(ix) and (e)(8).

(2) *Determine primary product.* You must determine the primary product of each PUG created in paragraph (l)(1) of this section according to the procedures specified in paragraphs (l)(2)(i) through (iv) of this section.

(i) The primary product is the type of product (e.g., organic chemicals subject to §63.2435(b)(1), pharmaceutical products subject to §63.1250, or pesticide active ingredients subject to §63.1360) expected to be produced for the greatest operating time in the 5-year period specified in paragraph (l)(1)(ii) of this section.

(ii) If the PUG produces multiple types of products equally based on operating time, then the primary product is the type of product with the greatest production on a mass basis over the 5-year period specified in paragraph (l)(1)(ii) of this section.

(iii) At a minimum, you must redetermine the primary product of the PUG following the procedure specified in paragraphs (I)(2)(i) and (ii) of this section every 5 years.

(iv) You must record the calculation of the initial primary product determination as specified in §63.2525(i)(3) and report the results in the notification of compliance status report as specified in §63.2520(d)(8)(ix). You must record the calculation of each redetermination of the primary product as specified in §63.2525(i)(5) and report the calculation in a compliance report submitted no later than the report covering the period for the end of the 5th year after cessation of production of the previous primary product, as specified in §63.2520(e)(8).

(3) *Compliance requirements.* (i) If the primary product of the PUG is determined according to paragraph (I)(2) of this section to be material described in §63.2435(b)(1), then you must comply with this subpart for each MCPU in the PUG. You may also elect to comply with this subpart for all other process units in the PUG, which constitutes compliance with other part 63 rules.

(ii) If the primary product of the PUG is determined according to paragraph (I)(2) of this section to be material not described in §63.2435(b)(1), then you must comply with paragraph (I)(3)(ii)(A), (B), or (C) of this section, as applicable.

(A) If the primary product is subject to subpart GGG of this part 63, then comply with the requirements of subpart GGG for each MCPU in the PUG.

(B) If the primary product is subject to subpart MMM of this part 63, then comply with the requirements of subpart MMM for each MCPU in the PUG.

(C) If the primary product is subject to any subpart in this part 63 other than subpart GGG or subpart MMM, then comply with the requirements of this subpart for each MCPU in the PUG.

(iii) The requirements for new and reconstructed sources in the alternative subpart apply to all MCPU in the PUG if and only if the affected source under the alternative subpart meets the requirements for construction or reconstruction.

[68 FR 63888, Nov. 10, 2003, as amended at 71 FR 40337, July 14, 2006]

 [Back to Top](#)

§63.2540 What parts of the General Provisions apply to me?

Table 12 to this subpart shows which parts of the General Provisions in §§63.1 through 63.15 apply to you.

 [Back to Top](#)

§63.2545 Who implements and enforces this subpart?

(a) This subpart can be implemented and enforced by us, the U.S. Environmental Protection Agency (U.S. EPA), or a delegated authority such as your State, local, or tribal agency. If the U.S. EPA Administrator has delegated authority to your State, local, or tribal agency, then that agency also has the authority to implement and enforce this subpart. You should contact your U.S. EPA Regional Office to find out if this subpart is delegated to your State, local, or tribal agency.

(b) In delegating implementation and enforcement authority of this subpart to a State, local, or tribal agency under 40 CFR part 63, subpart E, the authorities contained in paragraphs (b)(1) through (4) of this section are retained by the Administrator of U.S. EPA and are not delegated to the State, local, or tribal agency.

(1) Approval of alternatives to the non-opacity emission limits and work practice standards in §63.2450(a) under §63.6(g).

(2) Approval of major alternatives to test methods under §63.7(e)(2)(ii) and (f) and as defined in §63.90.

(3) Approval of major alternatives to monitoring under §63.8(f) and as defined in §63.90.

(4) Approval of major alternatives to recordkeeping and reporting under §63.10(f) and as defined in §63.90.

 [Back to Top](#)

§63.2550 What definitions apply to this subpart?

(a) For an affected source complying with the requirements in subpart SS of this part 63, the terms used in this subpart and in subpart SS of this part 63 have the meaning given them in §63.981, except as specified in §§63.2450(k)(2) and (m), 63.2470(c)(2), 63.2475(b), and paragraph (i) of this section.

(b) For an affected source complying with the requirements in 40 CFR part 65, subpart F, the terms used in this subpart and in 40 CFR part 65, subpart F have the meaning given to them in §65.2.

(c) For an affected source complying with the requirements in subpart UU of this part 63, the terms used in this subpart and in subpart UU of this part 63 have the meaning given them in §63.1020.

(d) For an affected source complying with the requirements in subpart WW of this part 63, the terms used in this subpart and subpart WW of this part 63 have the meaning given them in §63.1061, except as specified in §§63.2450(m), 63.2470(c)(2), and paragraph (i) of this section.

(e) For an affected source complying with the requirements in §§63.132 through 63.149, the terms used in this subpart and §§63.132 through 63.149 have the meaning given them in §§63.101 and 63.111, except as specified in §63.2450(m) and paragraph (i) of this section.

(f) For an affected source complying with the requirements in §§63.104 and 63.105, the terms used in this subpart and in §§63.104 and 63.105 of this subpart have the meaning given them in §63.101, except as specified in §§63.2450(m), 63.2490(b), and paragraph (i) of this section.

(g) For an affected source complying with requirements in §§63.1253, 63.1257, and 63.1258, the terms used in this subpart and in §§63.1253, 63.1257, and 63.1258 have the meaning given them in §63.1251, except as specified in §63.2450(m) and paragraph (i) of this section.

(h) For an affected source complying with the requirements in 40 CFR part 65, subpart F, the terms used in this subpart and in 40 CFR part 65, subpart F, have the meaning given them in 40 CFR 65.2.

(i) All other terms used in this subpart are defined in the Clean Air Act (CAA), in 40 CFR 63.2, and in this paragraph (i). If a term is defined in §63.2, §63.101, §63.111, §63.981, §63.1020, §63.1061,

§63.1251, or §65.2 and in this paragraph (i), the definition in this paragraph (i) applies for the purposes of this subpart.

Ancillary activities means boilers and incinerators (not used to comply with the emission limits in Tables 1 through 7 to this subpart), chillers and refrigeration systems, and other equipment and activities that are not directly involved (*i.e.*, they operate within a closed system and materials are not combined with process fluids) in the processing of raw materials or the manufacturing of a product or isolated intermediate.

Batch operation means a noncontinuous operation involving intermittent or discontinuous feed into equipment, and, in general, involves the emptying of the equipment after the operation ceases and prior to beginning a new operation. Addition of raw material and withdrawal of product do not occur simultaneously in a batch operation.

Batch process vent means a vent from a unit operation or vents from multiple unit operations within a process that are manifolded together into a common header, through which a HAP-containing gas stream is, or has the potential to be, released to the atmosphere. Examples of batch process vents include, but are not limited to, vents on condensers used for product recovery, reactors, filters, centrifuges, and process tanks. The following are not batch process vents for the purposes of this subpart:

- (1) Continuous process vents;
- (2) Bottoms receivers;
- (3) Surge control vessels;
- (4) Gaseous streams routed to a fuel gas system(s);
- (5) Vents on storage tanks, wastewater emission sources, or pieces of equipment subject to the emission limits and work practice standards in Tables 4, 6, and 7 to this subpart;
- (6) Drums, pails, and totes;
- (7) Flexible elephant trunk systems that draw ambient air (*i.e.*, the system is not ducted, piped, or otherwise connected to the unit operations) away from operators when vessels are opened; and
- (8) Emission streams from emission episodes that are undiluted and uncontrolled containing less than 50 ppmv HAP are not part of any batch process vent. A vent from a unit operation, or a vent from multiple unit operations that are manifolded together, from which total uncontrolled HAP emissions are less than 200 lb/yr is not a batch process vent; emissions for all emission episodes associated with the unit operation(s) must be included in the determination of the total mass emitted. The HAP concentration or mass emission rate may be determined using any of the following: process knowledge that no HAP are present in the emission stream; an engineering assessment as discussed in §63.1257(d)(2)(ii), except that you do not need to demonstrate that the equations in §63.1257(d)(2)(i) do not apply, and the precompliance reporting requirements specified in §63.1257(d)(2)(ii)(E) do not apply for the purposes of this demonstration; equations specified in §63.1257(d)(2)(i), as applicable; test data using Method 18 of 40 CFR part 60, appendix A; or any other test method that has been validated according to the procedures in Method 301 of appendix A of this part.

Biofilter means an enclosed control system such as a tank or series of tanks with a fixed roof that contact emissions with a solid media (such as bark) and use microbiological activity to transform organic pollutants in a process vent stream to innocuous compounds such as carbon dioxide, water, and

inorganic salts. Wastewater treatment processes such as aeration lagoons or activated sludge systems are not considered to be biofilters.

Bottoms receiver means a tank that collects bottoms from continuous distillation before the stream is sent for storage or for further downstream processing.

Construction means the onsite fabrication, erection, or installation of an affected source or MCPU. Addition of new equipment to an MCPU subject to existing source standards does not constitute construction, but it may constitute reconstruction of the affected source or MCPU if it satisfies the definition of reconstruction in §63.2.

Consumption means the quantity of all HAP raw materials entering a process in excess of the theoretical amount used as reactant, assuming 100 percent stoichiometric conversion. The raw materials include reactants, solvents, and any other additives. If a HAP is generated in the process as well as added as a raw material, consumption includes the quantity generated in the process.

Continuous operation means any operation that is not a batch operation.

Continuous process vent means the point of discharge to the atmosphere (or the point of entry into a control device, if any) of a gas stream if the gas stream has the characteristics specified in §63.107(b) through (h), or meets the criteria specified in §63.107(i), except:

(1) The reference in §63.107(e) to a chemical manufacturing process unit that meets the criteria of §63.100(b) means an MCPU that meets the criteria of §63.2435(b);

(2) The reference in §63.107(h)(4) to §63.113 means Table 1 to this subpart;

(3) The references in §63.107(h)(7) to §§63.119 and 63.126 mean tables 4 and 5 to this subpart;
and

(4) For the purposes of §63.2455, all references to the characteristics of a process vent (e.g., flowrate, total HAP concentration, or TRE index value) mean the characteristics of the gas stream.

(5) The reference to “total organic HAP” in §63.107(d) means “total HAP” for the purposes of this subpart FFFF.

(6) The references to an “air oxidation reactor, distillation unit, or reactor” in §63.107 mean any continuous operation for the purposes of this subpart.

(7) A separate determination is required for the emissions from each MCPU, even if emission streams from two or more MCPU are combined prior to discharge to the atmosphere or to a control device.

Dedicated MCPU means an MCPU that consists of equipment that is used exclusively for one process, except that storage tanks assigned to the process according to the procedures in §63.2435(d) also may be shared by other processes.

Deviation means any instance in which an affected source subject to this subpart, or an owner or operator of such a source:

(1) Fails to meet any requirement or obligation established by this subpart including, but not limited to, any emission limit, operating limit, or work practice standard; or

(2) Fails to meet any term or condition that is adopted to implement an applicable requirement in this subpart and that is included in the operating permit for any affected source required to obtain such a permit; or

(3) Fails to meet any emission limit, operating limit, or work practice standard in this subpart during startup, shutdown, or malfunction, regardless of whether or not such failure is permitted by this subpart.

Emission point means each continuous process vent, batch process vent, storage tank, transfer rack, and wastewater stream.

Energetics means propellants, explosives, and pyrotechnics and include materials listed at 49 CFR 172.101 as Hazard Class I Hazardous Materials, Divisions 1.1 through 1.6.

Equipment means each pump, compressor, agitator, pressure relief device, sampling connection system, open-ended valve or line, valve, connector, and instrumentation system in organic HAP service; and any control devices or systems used to comply with Table 6 to this subpart.

Excess emissions means emissions greater than those allowed by the emission limit.

Family of materials means a grouping of materials with the same basic composition or the same basic end use or functionality produced using the same basic feedstocks with essentially identical HAP emission profiles (primary constituent and relative magnitude on a pound per product basis) and manufacturing equipment configuration. Examples of families of materials include multiple grades of the same product or different variations of a product (e.g., blue, black, and red resins).

Group 1 batch process vent means each of the batch process vents in a process for which the collective uncontrolled organic HAP emissions from all of the batch process vents are greater than or equal to 10,000 lb/yr at an existing source or greater than or equal to 3,000 lb/yr at a new source.

Group 2 batch process vent means each batch process vent that does not meet the definition of Group 1 batch process vent.

Group 1 continuous process vent means a continuous process vent for which the flow rate is greater than or equal to 0.005 standard cubic meter per minute, and the total resource effectiveness index value, calculated according to §63.2455(b), is less than or equal to 1.9 at an existing source and less than or equal to 5.0 at a new source.

Group 2 continuous process vent means a continuous process vent that does not meet the definition of a Group 1 continuous process vent.

Group 1 storage tank means a storage tank with a capacity greater than or equal to 10,000 gal storing material that has a maximum true vapor pressure of total HAP greater than or equal to 6.9 kilopascals at an existing source or greater than or equal to 0.69 kilopascals at a new source.

Group 2 storage tank means a storage tank that does not meet the definition of a Group 1 storage tank.

Group 1 transfer rack means a transfer rack that loads more than 0.65 million liters/year of liquids that contain organic HAP with a rack-weighted average partial pressure, as defined in §63.111, greater than or equal to 1.5 pound per square inch absolute.

Group 2 transfer rack means a transfer rack that does not meet the definition of a Group 1 transfer rack.

Group 1 wastewater stream means a wastewater stream consisting of process wastewater at an existing or new source that meets the criteria for Group 1 status in §63.2485(c) for compounds in Tables 8 and 9 to this subpart and/or a wastewater stream consisting of process wastewater at a new source that meets the criteria for Group 1 status in §63.132(d) for compounds in Table 8 to subpart G of this part 63.

Group 2 wastewater stream means any process wastewater stream that does not meet the definition of a Group 1 wastewater stream.

Halogen atoms mean chlorine and fluorine.

Halogenated vent stream means a vent stream determined to have a mass emission rate of halogen atoms contained in organic compounds of 0.45 kilograms per hour or greater determined by the procedures presented in §63.115(d)(2)(v).

HAP metals means the metal portion of antimony compounds, arsenic compounds, beryllium compounds, cadmium compounds, chromium compounds, cobalt compounds, lead compounds, manganese compounds, mercury compounds, nickel compounds, and selenium compounds.

Hydrogen halide and halogen HAP means hydrogen chloride, hydrogen fluoride, and chlorine.

In organic HAP service means that a piece of equipment either contains or contacts a fluid (liquid or gas) that is at least 5 percent by weight of total organic HAP as determined according to the provisions of §63.180(d). The provisions of §63.180(d) also specify how to determine that a piece of equipment is not in organic HAP service.

Isolated intermediate means a product of a process that is stored before subsequent processing. An isolated intermediate is usually a product of a chemical synthesis, fermentation, or biological extraction process. Storage of an isolated intermediate marks the end of a process. Storage occurs at any time the intermediate is placed in equipment used solely for storage. The storage equipment is part of the MCPU that produces the isolated intermediate and is not assigned as specified in §63.2435(d).

Large control device means a control device that controls total HAP emissions of greater than or equal to 10 tpy, before control.

Maintenance wastewater means wastewater generated by the draining of process fluid from components in the MCPU into an individual drain system in preparation for or during maintenance activities. Maintenance wastewater can be generated during planned and unplanned shutdowns and during periods not associated with a shutdown. Examples of activities that can generate maintenance wastewater include descaling of heat exchanger tubing bundles, cleaning of distillation column traps, draining of pumps into an individual drain system, and draining of portions of the MCPU for repair. Wastewater from routine cleaning operations occurring as part of batch operations is not considered maintenance wastewater.

Maximum true vapor pressure has the meaning given in §63.111, except that it applies to all HAP rather than only organic HAP.

Miscellaneous organic chemical manufacturing process means all equipment which collectively function to produce a product or isolated intermediate that are materials described in §63.2435(b). For the purposes of this subpart, process includes any, all or a combination of reaction, recovery, separation, purification, or other activity, operation, manufacture, or treatment which are used to produce a product or isolated intermediate. A process is also defined by the following:

- (1) Routine cleaning operations conducted as part of batch operations are considered part of the process;
- (2) Each nondedicated solvent recovery operation is considered a single process;
- (3) Each nondedicated formulation operation is considered a single process that is used to formulate numerous materials and/or products;
- (4) Quality assurance/quality control laboratories are not considered part of any process; and
- (5) Ancillary activities are not considered a process or part of any process.
- (6) The end of a process that produces a solid material is either up to and including the dryer or extruder, or for a polymer production process without a dryer or extruder, it is up to and including the extruder, die plate, or solid-state reactor, except in two cases. If the dryer, extruder, die plate, or solid-state reactor is followed by an operation that is designed and operated to remove HAP solvent or residual HAP monomer from the solid, then the solvent removal operation is the last step in the process. If the dried solid is diluted or mixed with a HAP-based solvent, then the solvent removal operation is the last step in the process.

Nondedicated solvent recovery operation means a distillation unit or other purification equipment that receives used solvent from more than one MCPU.

Nonstandard batch means a batch process that is operated outside of the range of operating conditions that are documented in an existing operating scenario but is still a reasonably anticipated event. For example, a nonstandard batch occurs when additional processing or processing at different operating conditions must be conducted to produce a product that is normally produced under the conditions described by the standard batch. A nonstandard batch may be necessary as a result of a malfunction, but it is not itself a malfunction.

On-site or on site means, with respect to records required to be maintained by this subpart or required by another subpart referenced by this subpart, that records are stored at a location within a major source which encompasses the affected source. On-site includes, but is not limited to, storage at the affected source or MCPU to which the records pertain, or storage in central files elsewhere at the major source.

Operating scenario means, for the purposes of reporting and recordkeeping, any specific operation of an MCPU as described by records specified in §63.2525(b).

Organic group means structures that contain primarily carbon, hydrogen, and oxygen atoms.

Organic peroxides means organic compounds containing the bivalent -o-o-structure which may be considered to be a structural derivative of hydrogen peroxide where one or both of the hydrogen atoms has been replaced by an organic radical.

Point of determination means each point where process wastewater exits the MCPU or control device.

NOTE TO DEFINITION FOR POINT OF DETERMINATION: The regulation allows determination of the characteristics of a wastewater stream: At the point of determination; or downstream of the point of determination if corrections are made for changes in flow rate and annual average concentration of soluble HAP and partially soluble HAP compounds as determined according to procedures in §63.144 of subpart G in this part 63. Such changes include losses by air emissions; reduction of annual average concentration or changes in flow rate by mixing with other water or

wastewater streams; and reduction in flow rate or annual average concentration by treating or otherwise handling the wastewater stream to remove or destroy HAP.

Predominant HAP means as used in calibrating an analyzer, the single organic HAP that constitutes the largest percentage of the total organic HAP in the analyzed gas stream, by volume.

Process condenser means a condenser whose primary purpose is to recover material as an integral part of an MCPU. All condensers recovering condensate from an MCPU at or above the boiling point or all condensers in line prior to a vacuum source are considered process condensers. Typically, a primary condenser or condensers in series are considered to be integral to the MCPU if they are capable of and normally used for the purpose of recovering chemicals for fuel value (i.e., net positive heating value), use, reuse or for sale for fuel value, use, or reuse. This definition does not apply to a condenser that is used to remove materials that would hinder performance of a downstream recovery device as follows:

- (1) To remove water vapor that would cause icing in a downstream condenser, or
- (2) To remove water vapor that would negatively affect the adsorption capacity of carbon in a downstream carbon adsorber, or
- (3) To remove high molecular weight organic compounds or other organic compounds that would be difficult to remove during regeneration of a downstream carbon adsorber.

Process tank means a tank or vessel that is used within a process to collect material discharged from a feedstock storage tank or equipment within the process before the material is transferred to other equipment within the process or a product storage tank. A process tank has emissions that are related to the characteristics of the batch cycle, and it does not accumulate product over multiple batches. Surge control vessels and bottoms receivers are not process tanks.

Production-indexed HAP consumption factor (HAP factor) means the result of dividing the annual consumption of total HAP by the annual production rate, per process.

Production-indexed VOC consumption factor (VOC factor) means the result of dividing the annual consumption of total VOC by the annual production rate, per process.

Quaternary ammonium compounds means a type of organic nitrogen compound in which the molecular structure includes a central nitrogen atom joined to four organic groups as well as an acid radical of some sort.

Recovery device means an individual unit of equipment used for the purpose of recovering chemicals from process vent streams and from wastewater streams for fuel value (i.e., net positive heating value), use, reuse, or for sale for fuel value, use, or reuse. For the purposes of meeting requirements in table 2 to this subpart, the recovery device must not be a process condenser and must recover chemicals to be reused in a process on site. Examples of equipment that may be recovery devices include absorbers, carbon adsorbers, condensers, oil-water separators or organic-water separators, or organic removal devices such as decanters, strippers, or thin-film evaporation units. To be a recovery device for a wastewater stream, a decanter and any other equipment based on the operating principle of gravity separation must receive only multi-phase liquid streams.

Responsible official means responsible official as defined in 40 CFR 70.2.

Safety device means a closure device such as a pressure relief valve, frangible disc, fusible plug, or any other type of device which functions exclusively to prevent physical damage or permanent deformation to a unit or its air emission control equipment by venting gases or vapors directly to the

atmosphere during unsafe conditions resulting from an unplanned, accidental, or emergency event. For the purposes of this subpart, a safety device is not used for routine venting of gases or vapors from the vapor headspace underneath a cover such as during filling of the unit or to adjust the pressure in response to normal daily diurnal ambient temperature fluctuations. A safety device is designed to remain in a closed position during normal operations and open only when the internal pressure, or another relevant parameter, exceeds the device threshold setting applicable to the air emission control equipment as determined by the owner or operator based on manufacturer recommendations, applicable regulations, fire protection and prevention codes and practices, or other requirements for the safe handling of flammable, combustible, explosive, reactive, or hazardous materials.

Shutdown means the cessation of operation of a continuous operation for any purpose. Shutdown also means the cessation of a batch operation, or any related individual piece of equipment required or used to comply with this subpart, if the steps taken to cease operation differ from those described in a standard batch or nonstandard batch. Shutdown also applies to emptying and degassing storage vessels. Shutdown does not apply to cessation of batch operations at the end of a campaign or between batches within a campaign when the steps taken are routine operations.

Small control device means a control device that controls total HAP emissions of less than 10 tpy, before control.

Standard batch means a batch process operated within a range of operating conditions that are documented in an operating scenario. Emissions from a standard batch are based on the operating conditions that result in highest emissions. The standard batch defines the uncontrolled and controlled emissions for each emission episode defined under the operating scenario.

Startup means the setting in operation of a continuous operation for any purpose; the first time a new or reconstructed batch operation begins production; for new equipment added, including equipment required or used to comply with this subpart, the first time the equipment is put into operation; or for the introduction of a new product/process, the first time the product or process is run in equipment. For batch operations, startup applies to the first time the equipment is put into operation at the start of a campaign to produce a product that has been produced in the past if the steps taken to begin production differ from those specified in a standard batch or nonstandard batch. Startup does not apply when the equipment is put into operation as part of a batch within a campaign when the steps taken are routine operations.

Storage tank means a tank or other vessel that is used to store liquids that contain organic HAP and/or hydrogen halide and halogen HAP and that has been assigned to an MCPU according to the procedures in §63.2435(d). The following are not considered storage tanks for the purposes of this subpart:

- (1) Vessels permanently attached to motor vehicles such as trucks, railcars, barges, or ships;
- (2) Pressure vessels designed to operate in excess of 204.9 kilopascals and without emissions to the atmosphere;
- (3) Vessels storing organic liquids that contain HAP only as impurities;
- (4) Wastewater storage tanks;
- (5) Bottoms receivers;
- (6) Surge control vessels; and
- (7) Process tanks.

Supplemental gases means the air that is added to a vent stream after the vent stream leaves the unit operation. Air that is part of the vent stream as a result of the nature of the unit operation is not considered supplemental gases. Air required to operate combustion device burner(s) is not considered supplemental gases.

Surge control vessel means feed drums, recycle drums, and intermediate vessels as part of any continuous operation. Surge control vessels are used within an MCPU when in-process storage, mixing, or management of flowrates or volumes is needed to introduce material into continuous operations.

Total organic compounds or (TOC) means the total gaseous organic compounds (minus methane and ethane) in a vent stream.

Transfer rack means the collection of loading arms and loading hoses, at a single loading rack, that are assigned to an MCPU according to the procedures specified in §63.2435(d) and are used to fill tank trucks and/or rail cars with organic liquids that contain one or more of the organic HAP listed in section 112(b) of the CAA of this subpart. Transfer rack includes the associated pumps, meters, shutoff valves, relief valves, and other piping and valves.

Unit operation means those processing steps that occur within distinct equipment that are used, among other things, to prepare reactants, facilitate reactions, separate and purify products, and recycle materials. Equipment used for these purposes includes, but is not limited to, reactors, distillation columns, extraction columns, absorbers, decanters, dryers, condensers, and filtration equipment.

Waste management unit means the equipment, structure(s), and/or device(s) used to convey, store, treat, or dispose of wastewater streams or residuals. Examples of waste management units include wastewater tanks, air flotation units, surface impoundments, containers, oil-water or organic-water separators, individual drain systems, biological wastewater treatment units, waste incinerators, and organic removal devices such as steam and air stripper units, and thin film evaporation units. If such equipment is being operated as a recovery device, then it is part of a miscellaneous organic chemical manufacturing process and is not a waste management unit.

Wastewater means water that is discarded from an MCPU or control device through a POD and that contains either: an annual average concentration of compounds in tables 8 and 9 to this subpart of at least 5 ppmw and has an annual average flowrate of 0.02 liters per minute or greater; or an annual average concentration of compounds in tables 8 and 9 to this subpart of at least 10,000 ppmw at any flowrate. Wastewater means process wastewater or maintenance wastewater. The following are not considered wastewater for the purposes of this subpart:

- (1) Stormwater from segregated sewers;
- (2) Water from fire-fighting and deluge systems, including testing of such systems;
- (3) Spills;
- (4) Water from safety showers;
- (5) Samples of a size not greater than reasonably necessary for the method of analysis that is used;
- (6) Equipment leaks;
- (7) Wastewater drips from procedures such as disconnecting hoses after cleaning lines; and
- (8) Noncontact cooling water.

Wastewater stream means a stream that contains only wastewater as defined in this paragraph (i).

Work practice standard means any design, equipment, work practice, or operational standard, or combination thereof, that is promulgated pursuant to section 112(h) of the CAA.

[68 FR 63888, Nov. 10, 2003, as amended at 70 FR 38560, July 1, 2005; 71 FR 40338, July 14, 2006]

[↑ Back to Top](#)

Table 1 to Subpart FFFF of Part 63—Emission Limits and Work Practice Standards for Continuous Process Vents

As required in §63.2455, you must meet each emission limit and work practice standard in the following table that applies to your continuous process vents:

For each . . .	For which . . .	Then you must . . .
1. Group 1 continuous process vent	a. Not applicable	i. Reduce emissions of total organic HAP by ≥ 98 percent by weight or to an outlet process concentration ≤ 20 ppmv as organic HAP or TOC by venting emissions through a closed-vent system to any combination of control devices (except a flare); or
		ii. Reduce emissions of total organic HAP by venting emissions through a closed vent system to a flare; or
		iii. Use a recovery device to maintain the TRE above 1.9 for an existing source or above 5.0 for a new source.
2. Halogenated Group 1 continuous process vent stream	a. You use a combustion control device to control organic HAP emissions	i. Use a halogen reduction device after the combustion device to reduce emissions of hydrogen halide and halogen HAP by ≥ 99 percent by weight, or to ≤ 0.45 kg/hr, or to ≤ 20 ppmv; or ii. Use a halogen reduction device before the combustion device to reduce the halogen atom mass emission rate to ≤ 0.45 kg/hr or to a concentration ≤ 20 ppmv.
3. Group 2 continuous process vent at an existing source	You use a recovery device to maintain the TRE level > 1.9 but ≤ 5.0	Comply with the requirements in §63.993 and the requirements referenced therein.
4. Group 2 continuous process vent at a new source	You use a recovery device to maintain the TRE level > 5.0 but ≤ 8.0	Comply with the requirements in §63.993 and the requirements referenced therein.

Table 2 to Subpart FFFF of Part 63—Emission Limits and Work Practice Standards for Batch Process Vents

As required in §63.2460, you must meet each emission limit and work practice standard in the following table that applies to your batch process vents:

For each . . .	Then you must . . .	And you must . . .
1. Process with Group 1 batch process vents	a. Reduce collective uncontrolled organic HAP emissions from the sum of all batch process vents within the process by ≥ 98 percent by weight by venting emissions from a sufficient number of the vents through one or more closed-vent systems to any combination of control devices (except a flare); or	Not applicable.
	b. Reduce collective uncontrolled organic HAP emissions from the sum of all batch process vents within the process by ≥ 95 percent by weight by venting emissions from a sufficient number of the vents through one or more closed-vent systems to any combination of recovery devices or a biofilter, except you may elect to comply with the requirements of subpart WW of this part for any process tank; or	Not applicable.
	c. Reduce uncontrolled organic HAP emissions from one or more batch process vents within the process by venting through a closed-vent system to a flare or by venting through one or more closed-vent systems to any combination of control devices (excluding a flare) that reduce organic HAP to an outlet concentration ≤ 20 ppmv as TOC or total organic HAP.	For all other batch process vents within the process, reduce collective organic HAP emissions as specified in item 1.a and/or item 1.b of this table.
2. Halogenated Group 1 batch process vent for which you use a combustion device to control organic HAP emissions	a. Use a halogen reduction device after the combustion control device; or	i. Reduce overall emissions of hydrogen halide and halogen HAP by ≥ 99 percent; or ii. Reduce overall emissions of hydrogen halide and halogen HAP to ≤ 0.45 kg/hr; or

		iii. Reduce overall emissions of hydrogen halide and halogen HAP to a concentration ≤ 20 ppmv.
	b. Use a halogen reduction device before the combustion control device	Reduce the halogen atom mass emission rate to ≤ 0.45 kg/hr or to a concentration ≤ 20 ppmv.

[68 FR 63888, Nov. 10, 2003, as amended at 71 FR 40339, July 14, 2006]

[↑ Back to Top](#)

Table 3 to Subpart FFFF of Part 63—Emission Limits for Hydrogen Halide and Halogen HAP Emissions or HAP Metals Emissions From Process Vents

As required in §63.2465, you must meet each emission limit in the following table that applies to your process vents that contain hydrogen halide and halogen HAP emissions or PM HAP emissions:

For each . . .	You must . . .
1. Process with uncontrolled hydrogen halide and halogen HAP emissions from process vents $\geq 1,000$ lb/yr	a. Reduce collective hydrogen halide and halogen HAP emissions by ≥ 99 percent by weight or to an outlet concentration ≤ 20 ppmv by venting through one or more closed-vent systems to any combination of control devices, or
	b. Reduce the halogen atom mass emission rate from the sum of all batch process vents and each individual continuous process vent to ≤ 0.45 kg/hr by venting through one or more closed-vent systems to a halogen reduction device.
2. Process at a new source with uncontrolled emissions from process vents ≥ 150 lb/yr of HAP metals	Reduce overall emissions of HAP metals by ≥ 97 percent by weight.

[68 FR 63888, Nov. 10, 2003, as amended at 71 FR 40340, July 14, 2006]

[↑ Back to Top](#)

Table 4 to Subpart FFFF of Part 63—Emission Limits for Storage Tanks

As required in §63.2470, you must meet each emission limit in the following table that applies to your storage tanks:

For each . . .	For which . . .	Then you must . . .
1. Group 1 storage	a. The maximum true	i. Reduce total HAP emissions by ≥ 95 percent by

tank	vapor pressure of total HAP at the storage temperature is ≥ 76.6 kilopascals	weight or to ≤ 20 ppmv of TOC or organic HAP and ≤ 20 ppmv of hydrogen halide and halogen HAP by venting emissions through a closed vent system to any combination of control devices (excluding a flare); or
		ii. Reduce total organic HAP emissions by venting emissions through a closed vent system to a flare; or
		iii. Reduce total HAP emissions by venting emissions to a fuel gas system or process in accordance with §63.982(d) and the requirements referenced therein.
	b. The maximum true vapor pressure of total HAP at the storage temperature is < 76.6 kilopascals	i. Comply with the requirements of subpart WW of this part, except as specified in §63.2470; or
		ii. Reduce total HAP emissions by ≥ 95 percent by weight or to ≤ 20 ppmv of TOC or organic HAP and ≤ 20 ppmv of hydrogen halide and halogen HAP by venting emissions through a closed vent system to any combination of control devices (excluding a flare); or
		iii. Reduce total organic HAP emissions by venting emissions through a closed vent system to a flare; or
		iv. Reduce total HAP emissions by venting emissions to a fuel gas system or process in accordance with §63.982(d) and the requirements referenced therein.
2. Halogenated vent stream from a Group 1 storage tank	You use a combustion control device to control organic HAP emissions	Meet one of the emission limit options specified in Item 2.a.i or ii. in Table 1 to this subpart.

[68 FR 63888, Nov. 10, 2003, as amended at 71 FR 40340, July 14, 2006]

[↑ Back to Top](#)

Table 5 to Subpart FFFF of Part 63—Emission Limits and Work Practice Standards for Transfer Racks

As required in §63.2475, you must meet each emission limit and work practice standard in the following table that applies to your transfer racks:

For each . . .	You must . . .
1. Group 1 transfer rack	a. Reduce emissions of total organic HAP by ≥ 98 percent by weight or to an outlet concentration ≤ 20 ppmv as organic HAP or TOC by venting emissions through a closed-vent system to any combination of control devices (except a flare); or
	b. Reduce emissions of total organic HAP by venting emissions through a closed-vent system to a flare; or
	c. Reduce emissions of total organic HAP by venting emissions to a fuel gas system or process in accordance with §63.982(d) and the requirements referenced therein; or
	d. Use a vapor balancing system designed and operated to collect organic HAP vapors displaced from tank trucks and railcars during loading and route the collected HAP vapors to the storage tank from which the liquid being loaded originated or to another storage tank connected by a common header.
2. Halogenated Group 1 transfer rack vent stream for which you use a combustion device to control organic HAP emissions	<p>a. Use a halogen reduction device after the combustion device to reduce emissions of hydrogen halide and halogen HAP by ≥ 99 percent by weight, to ≤ 0.45 kg/hr, or to ≤ 20 ppmv; or</p> <p>b. Use a halogen reduction device before the combustion device to reduce the halogen atom mass emission rate to ≤ 0.45 kg/hr or to a concentration ≤ 20 ppmv.</p>

[68 FR 63888, Nov. 10, 2003, as amended at 71 FR 40341, July 14, 2006]

[↑ Back to Top](#)

Table 6 to Subpart FFFF of Part 63—Requirements for Equipment Leaks

As required in §63.2480, you must meet each requirement in the following table that applies to your equipment leaks:

For all . . .	And that is part of . . .	You must . . .
1. Equipment that is in organic HAP service	a. Comply with the requirements of subpart UU of this part 63 and the requirements referenced therein, except as specified in §63.2480(b) and (d); or	
	b. Comply with the requirements of subpart H of this part 63 and the requirements referenced therein, except as specified in §63.2480(b) and (d); or	

	c. Comply with the requirements of 40 CFR part 65, subpart F and the requirements referenced therein, except as specified in §63.2480(c) and (d).	
2. Equipment that is in organic HAP service at a new source	a. Any MCPU	i. Comply with the requirements of subpart UU of this part 63 and the requirements referenced therein; or ii. Comply with the requirements of 40 CFR part 65, subpart F.

[68 FR 63888, Nov. 10, 2003, as amended at 71 FR 40341, July 14, 2006]

[↑ Back to Top](#)

Table 7 to Subpart FFFF of Part 63—Requirements for Wastewater Streams and Liquid Streams in Open Systems Within an MCPU

As required in §63.2485, you must meet each requirement in the following table that applies to your wastewater streams and liquid streams in open systems within an MCPU:

For each . . .	You must . . .
1. Process wastewater stream	Comply with the requirements in §§63.132 through 63.148 and the requirements referenced therein, except as specified in §63.2485.
2. Maintenance wastewater stream	Comply with the requirements in §63.105 and the requirements referenced therein, except as specified in §63.2485.
3. Liquid streams in an open system within an MCPU	Comply with the requirements in §63.149 and the requirements referenced therein, except as specified in §63.2485.

[↑ Back to Top](#)

Table 8 to Subpart FFFF of Part 63—Partially Soluble Hazardous Air Pollutants

As specified in §63.2485, the partially soluble HAP in wastewater that are subject to management and treatment requirements in this subpart FFFF are listed in the following table:

Chemical name . . .	CAS No.
1. 1,1,1-Trichloroethane (methyl chloroform)	71556
2. 1,1,2,2-Tetrachloroethane	79345
3. 1,1,2-Trichloroethane	79005

4. 1,1-Dichloroethylene (vinylidene chloride)	75354
5. 1,2-Dibromoethane	106934
6. 1,2-Dichloroethane (ethylene dichloride)	107062
7. 1,2-Dichloropropane	78875
8. 1,3-Dichloropropene	542756
9. 2,4,5-Trichlorophenol	95954
10. 1,4-Dichlorobenzene	106467
11. 2-Nitropropane	79469
12. 4-Methyl-2-pentanone (MIBK)	108101
13. Acetaldehyde	75070
14. Acrolein	107028
15. Acrylonitrile	107131
16. Allyl chloride	107051
17. Benzene	71432
18. Benzyl chloride	100447
19. Biphenyl	92524
20. Bromoform (tribromomethane)	75252
21. Bromomethane	74839
22. Butadiene	106990
23. Carbon disulfide	75150
24. Chlorobenzene	108907
25. Chloroethane (ethyl chloride)	75003
26. Chloroform	67663
27. Chloromethane	74873
28. Chloroprene	126998
29. Cumene	98828
30. Dichloroethyl ether	111444
31. Dinitrophenol	51285
32. Epichlorohydrin	106898
33. Ethyl acrylate	140885

34. Ethylbenzene	100414
35. Ethylene oxide	75218
36. Ethylidene dichloride	75343
37. Hexachlorobenzene	118741
38. Hexachlorobutadiene	87683
39. Hexachloroethane	67721
40. Methyl methacrylate	80626
41. Methyl-t-butyl ether	1634044
42. Methylene chloride	75092
43. N-hexane	110543
44. N,N-dimethylaniline	121697
45. Naphthalene	91203
46. Phosgene	75445
47. Propionaldehyde	123386
48. Propylene oxide	75569
49. Styrene	100425
50. Tetrachloroethylene (perchloroethylene)	127184
51. Tetrachloromethane (carbon tetrachloride)	56235
52. Toluene	108883
53. Trichlorobenzene (1,2,4-)	120821
54. Trichloroethylene	79016
55. Trimethylpentane	540841
56. Vinyl acetate	108054
57. Vinyl chloride	75014
58. Xylene (m)	108383
59. Xylene (o)	95476
60. Xylene (p)	106423

[68 FR 63888, Nov. 10, 2003, as amended at 70 FR 38560, July 1, 2005; 71 FR 40341, July 14, 2006]

[↑ Back to Top](#)

Table 9 to Subpart FFFF of Part 63—Soluble Hazardous Air Pollutants

As specified in §63.2485, the soluble HAP in wastewater that are subject to management and treatment requirements of this subpart FFFF are listed in the following table:

Chemical name . . .	CAS No.
1. Acetonitrile	75058
2. Acetophenone	98862
3. Diethyl sulfate	64675
4. Dimethyl hydrazine (1,1)	57147
5. Dimethyl sulfate	77781
6. Dinitrotoluene (2,4)	121142
7. Dioxane (1,4)	123911
8. Ethylene glycol dimethyl ether	110714
9. Ethylene glycol monobutyl ether acetate	112072
10. Ethylene glycol monomethyl ether acetate	110496
11. Isophorone	78591
12. Methanol	67561
13. Nitrobenzene	98953
14. Tolidine (o-)	95534
15. Triethylamine	121448

[68 FR 63888, Nov. 10, 2003, as amended at 70 FR 38561, July 1, 2005]

[↑ Back to Top](#)

Table 10 to Subpart FFFF of Part 63—Work Practice Standards for Heat Exchange Systems

As required in §63.2490, you must meet each requirement in the following table that applies to your heat exchange systems:

For each . . .	You must . . .
Heat exchange system, as defined in §63.101	Comply with the requirements of §63.104 and the requirements referenced therein, except as specified in §63.2490.

[↑ Back to Top](#)

Table 11 to Subpart FFFF of Part 63—Requirements for Reports

As required in §63.2520(a) and (b), you must submit each report that applies to you on the schedule shown in the following table:

You must submit a(n)	The report must contain . . .	You must submit the report . . .
1. Precompliance report	The information specified in §63.2520(c)	At least 6 months prior to the compliance date; or for new sources, with the application for approval of construction or reconstruction.
2. Notification of compliance status report	The information specified in §63.2520(d)	No later than 150 days after the compliance date specified in §63.2445.
3. Compliance report	The information specified in §63.2520(e)	Semiannually according to the requirements in §63.2520(b).

[↑ Back to Top](#)

Table 12 to Subpart FFFF of Part 63—Applicability of General Provisions to Subpart FFFF

As specified in §63.2540, the parts of the General Provisions that apply to you are shown in the following table:

Citation	Subject	Explanation
§63.1	Applicability	Yes.
§63.2	Definitions	Yes.
§63.3	Units and Abbreviations	Yes.
§63.4	Prohibited Activities	Yes.
§63.5	Construction/Reconstruction	Yes.
§63.6(a)	Applicability	Yes.
§63.6(b)(1)-(4)	Compliance Dates for New and Reconstructed sources	Yes.
§63.6(b)(5)	Notification	Yes.
§63.6(b)(6)	[Reserved]	
§63.6(b)(7)	Compliance Dates for New and Reconstructed Area Sources That Become Major	Yes.
§63.6(c)(1)-(2)	Compliance Dates for Existing Sources	Yes.
§63.6(c)(3)-(4)	[Reserved]	
§63.6(c)(5)	Compliance Dates for Existing	Yes

	Area Sources That Become Major	
§63.6(d)	[Reserved]	
§63.6(e)(1)-(2)	Operation & Maintenance	Yes.
§63.6(e)(3)(i), (ii), and (v) through (viii)	Startup, Shutdown, Malfunction Plan (SSMP)	Yes, except information regarding Group 2 emission points and equipment leaks is not required in the SSMP, as specified in §63.2525(j).
§63.6(e)(3)(iii) and (iv)	Recordkeeping and Reporting During SSM	No, §63.998(d)(3) and 63.998(c)(1)(ii)(D) through (G) specify the recordkeeping requirement for SSM events, and §63.2520(e)(4) specifies reporting requirements.
§63.6(e)(3)(ix)	SSMP incorporation into title V permit	Yes.
§63.6(f)(1)	Compliance Except During SSM	Yes.
§63.6(f)(2)-(3)	Methods for Determining Compliance	Yes.
§63.6(g)(1)-(3)	Alternative Standard	Yes.
§63.6(h)	Opacity/Visible Emission (VE) Standards	Only for flares for which Method 22 observations are required as part of a flare compliance assessment.
§63.6(i)(1)-(14)	Compliance Extension	Yes.
§63.6(j)	Presidential Compliance Exemption	Yes.
§63.7(a)(1)-(2)	Performance Test Dates	Yes, except substitute 150 days for 180 days.
§63.7(a)(3)	Section 114 Authority	Yes, and this paragraph also applies to flare compliance assessments as specified under §63.997(b)(2).
§63.7(b)(1)	Notification of Performance Test	Yes.
§63.7(b)(2)	Notification of Rescheduling	Yes.
§63.7(c)	Quality Assurance/Test Plan	Yes, except the test plan must be submitted with the notification of the performance test if the control device controls batch process vents.
§63.7(d)	Testing Facilities	Yes.

§63.7(e)(1)	Conditions for Conducting Performance Tests	Yes, except that performance tests for batch process vents must be conducted under worst-case conditions as specified in §63.2460.
§63.7(e)(2)	Conditions for Conducting Performance Tests	Yes.
§63.7(e)(3)	Test Run Duration	Yes.
§63.7(f)	Alternative Test Method	Yes.
§63.7(g)	Performance Test Data Analysis	Yes.
§63.7(h)	Waiver of Tests	Yes.
§63.8(a)(1)	Applicability of Monitoring Requirements	Yes.
§63.8(a)(2)	Performance Specifications	Yes.
§63.8(a)(3)	[Reserved]	
§63.8(a)(4)	Monitoring with Flares	Yes.
§63.8(b)(1)	Monitoring	Yes.
§63.8(b)(2)-(3)	Multiple Effluents and Multiple Monitoring Systems	Yes.
§63.8(c)(1)	Monitoring System Operation and Maintenance	Yes.
§63.8(c)(1)(i)	Routine and Predictable SSM	Yes.
§63.8(c)(1)(ii)	SSM not in SSMP	Yes.
§63.8(c)(1)(iii)	Compliance with Operation and Maintenance Requirements	Yes.
§63.8(c)(2)-(3)	Monitoring System Installation	Yes.
§63.8(c)(4)	CMS Requirements	Only for CEMS. Requirements for CPMS are specified in referenced subparts G and SS of part 63. Requirements for COMS do not apply because subpart FFFF does not require continuous opacity monitoring systems (COMS).
§63.8(c)(4)(i)	COMS Measurement and Recording Frequency	No; subpart FFFF does not require COMS.
§63.8(c)(4)(ii)	CEMS Measurement and Recording Frequency	Yes.

§63.8(c)(5)	COMS Minimum Procedures	No. Subpart FFFF does not contain opacity or VE limits.
§63.8(c)(6)	CMS Requirements	Only for CEMS; requirements for CPMS are specified in referenced subparts G and SS of this part 63. Requirements for COMS do not apply because subpart FFFF does not require COMS.
§63.8(c)(7)-(8)	CMS Requirements	Only for CEMS. Requirements for CPMS are specified in referenced subparts G and SS of part 63. Requirements for COMS do not apply because subpart FFFF does not require COMS.
§63.8(d)	CMS Quality Control	Only for CEMS.
§63.8(e)	CMS Performance Evaluation	Only for CEMS. Section 63.8(e)(5)(ii) does not apply because subpart FFFF does not require COMS.
§63.8(f)(1)-(5)	Alternative Monitoring Method	Yes, except you may also request approval using the precompliance report.
§63.8(f)(6)	Alternative to Relative Accuracy Test	Only applicable when using CEMS to demonstrate compliance, including the alternative standard in §63.2505.
§63.8(g)(1)-(4)	Data Reduction	Only when using CEMS, including for the alternative standard in §63.2505, except that the requirements for COMS do not apply because subpart FFFF has no opacity or VE limits, and §63.8(g)(2) does not apply because data reduction requirements for CEMS are specified in §63.2450(j).
§63.8(g)(5)	Data Reduction	No. Requirements for CEMS are specified in §63.2450(j). Requirements for CPMS are specified in referenced subparts G and SS of this part 63.
§63.9(a)	Notification Requirements	Yes.
§63.9(b)(1)-(5)	Initial Notifications	Yes.
§63.9(c)	Request for Compliance Extension	Yes.
§63.9(d)	Notification of Special Compliance Requirements for	Yes.

	New Source	
§63.9(e)	Notification of Performance Test	Yes.
§63.9(f)	Notification of VE/Opacity Test	No. Subpart FFFF does not contain opacity or VE limits.
§63.9(g)	Additional Notifications When Using CMS	Only for CEMS. Section 63.9(g)(2) does not apply because subpart FFFF does not require COMS.
63.9(h)(1)-(6)	Notification of Compliance Status	Yes, except subpart FFFF has no opacity or VE limits, and 63.9(h)(2)(i)(A) through (G) and (ii) do not apply because 63.2520(d) specifies the required contents and due date of the notification of compliance status report.
§63.9(i)	Adjustment of Submittal Deadlines	Yes.
§63.9(j)	Change in Previous Information	No, §63.2520(e) specifies reporting requirements for process changes.
§63.10(a)	Recordkeeping/Reporting	Yes.
§63.10(b)(1)	Recordkeeping/Reporting	Yes.
§63.10(b)(2)(i)-(ii), (iv), (v)	Records related to SSM	No, §§63.998(d)(3) and 63.998(c)(1)(ii)(D) through (G) specify recordkeeping requirements for periods of SSM.
§63.10(b)(2)(iii)	Records related to maintenance of air pollution control equipment	Yes.
§63.10(b)(2)(vi), (x), and (xi)	CMS Records	Only for CEMS; requirements for CPMS are specified in referenced subparts G and SS of this part 63.
§63.10(b)(2)(vii)-(ix)	Records	Yes.
§63.10(b)(2)(xii)	Records	Yes.
§63.10(b)(2)(xiii)	Records	Only for CEMS.
§63.10(b)(2)(xiv)	Records	Yes.
§63.10(b)(3)	Records	Yes.
§63.10(c)(1)-(6),(9)-(15)	Records	Only for CEMS. Recordkeeping requirements for CPMS are specified in referenced subparts G and SS of this part

		63.
§63.10(c)(7)-(8)	Records	No. Recordkeeping requirements are specified in §63.2525.
§63.10(d)(1)	General Reporting Requirements	Yes.
§63.10(d)(2)	Report of Performance Test Results	Yes.
§63.10(d)(3)	Reporting Opacity or VE Observations	No. Subpart FFFF does not contain opacity or VE limits.
§63.10(d)(4)	Progress Reports	Yes.
§63.10(d)(5)(i)	Periodic Startup, Shutdown, and Malfunction Reports	No, §63.2520(e)(4) and (5) specify the SSM reporting requirements.
§63.10(d)(5)(ii)	Immediate SSM Reports	No.
§63.10(e)(1)	Additional CEMS Reports	Yes.
§63.10(e)(2)(i)	Additional CMS Reports	Only for CEMS.
§63.10(e)(2)(ii)	Additional COMS Reports	No. Subpart FFFF does not require COMS.
§63.10(e)(3)	Reports	No. Reporting requirements are specified in §63.2520.
§63.10(e)(3)(i)-(iii)	Reports	No. Reporting requirements are specified in §63.2520.
§63.10(e)(3)(iv)-(v)	Excess Emissions Reports	No. Reporting requirements are specified in §63.2520.
§63.10(e)(3)(iv)-(v)	Excess Emissions Reports	No. Reporting requirements are specified in §63.2520.
§63.10(e)(3)(vi)-(viii)	Excess Emissions Report and Summary Report	No. Reporting requirements are specified in §63.2520.
§63.10(e)(4)	Reporting COMS data	No. Subpart FFFF does not contain opacity or VE limits.
§63.10(f)	Waiver for Recordkeeping/Reporting	Yes.
§63.11	Control device requirements for flares and work practice requirements for equipment leaks	Yes.
§63.12	Delegation	Yes.
§63.13	Addresses	Yes.

§63.14	Incorporation by Reference	Yes.
§63.15	Availability of Information	Yes.

[68 FR 63888, Nov. 10, 2003, as amended at 70 FR 38561, July 1, 2005; 71 FR 20463, Apr. 20, 2006; 71 FR 40341, July 14, 2006; 73 FR 72816, Dec. 22, 2008]

 [Back to Top](#)

Appendix N

Appendix N

NOTIFICATION OF COMPLIANCE

Revision 0

Pursuant to

**NESHAP: Standards for Hazardous Air Pollutants for Hazardous Waste
Combustors (40 CFR 63 Subpart EEE, Phase II)**

Prepared by

FUTUREFUEL CHEMICAL COMPANY

P.O. Box 2357

Batesville, AR 72503

ARD089234884

and

RISK MANAGEMENT AND ENGINEERING, LTD.

9206 Briarcrest, Ste. 102

Rowlett, TX 75089

September 01, 2010

EXECUTIVE SUMMARY

FutureFuel Chemical Company (FFCC) owns and operates an organic chemical manufacturing plant located southeast of Batesville, Arkansas, that was formerly owned and operated by Eastman Chemical Company. As part of plant operations, FFCC (EPA ID# ARD089234884) generates wastes regulated under the Resource Conservation and Recovery Act (RCRA) and burns some of this waste in its three coal-fired boilers for energy recovery. FFCC is currently operating these boilers under Arkansas Department of Environmental Quality (ADEQ) Hazardous Waste Permit Number 11H-RN1-M005. FFCC also destroys waste in its on-site incinerator currently operating under its Title V Permit (1085-AOP-R8).

The documentation of compliance (DOC) was developed in order to certify that the boilers are designed and will be operated in a manner that ensures compliance with the emission standards of 40 CFR 63.1216. This documentation of compliance was prepared in accordance with 40 CFR 63.1211(d) and was placed in the operating record on October 14, 2008. FFCC placed the DOC in its facility operating record as specified in the NESHAP: Final Standards for Hazardous Air Pollutants for Waste Combustors; Final Rule, effective October 12, 2005.

FFCC submitted the boiler Comprehensive Performance Test (CPT) plan for approval on April 11, 2008. The plan was conditionally approved by EPA Region 6 on April 13, 2010. FFCC began the CPT on April 14, 2010 and concluded the testing on June 4, 2010. The results of this test are being submitted as the Notice of Compliance (NOC) to the EPA and ADEQ. FFCC will begin complying with the operational parameters and limits established within this NOC immediately upon submittal.

CONCLUSIONS ON MEETING CPT OBJECTIVES

The overall objectives of the Comprehensive Performance Test were to demonstrate that the boilers are capable of meeting the solid fuel-fired emission standards established in the MACT Combustion Rule (40 CFR 63 Subpart EEE) and to establish operating parameter limits that are equivalent with that demonstration. Table ES-1 summarizes the specific objectives demonstrated during the CPT.

FFCC was successful in meeting the overall CPT objective, and this NOC establishes the operating conditions that reflect the results of this successful test.

NOTIFICATION OF COMPLIANCE

Revision 0

Pursuant to

**NESHAP: Standards for Hazardous Air Pollutants for Hazardous Waste
Combustors (40 CFR 63 Subpart EEE, Phase II)**

Prepared by

FUTUREFUEL CHEMICAL COMPANY

P.O. Box 2357

Batesville, AR 72503

ARD089234884

and

RISK MANAGEMENT AND ENGINEERING, LTD.

9206 Briarcrest, Ste. 102

Rowlett, TX 75089

September 01, 2010

EXECUTIVE SUMMARY

FutureFuel Chemical Company (FFCC) owns and operates an organic chemical manufacturing plant located southeast of Batesville, Arkansas, that was formerly owned and operated by Eastman Chemical Company. As part of plant operations, FFCC (EPA ID# ARD089234884) generates wastes regulated under the Resource Conservation and Recovery Act (RCRA) and burns some of this waste in its three coal-fired boilers for energy recovery. FFCC is currently operating these boilers under Arkansas Department of Environmental Quality (ADEQ) Hazardous Waste Permit Number 11H-RN1-M005. FFCC also destroys waste in its on-site incinerator currently operating under its Title V Permit (1085-AOP-R8).

The documentation of compliance (DOC) was developed in order to certify that the boilers are designed and will be operated in a manner that ensures compliance with the emission standards of 40 CFR 63.1216. This documentation of compliance was prepared in accordance with 40 CFR 63.1211(d) and was placed in the operating record on October 14, 2008. FFCC placed the DOC in its facility operating record as specified in the NESHAP: Final Standards for Hazardous Air Pollutants for Waste Combustors; Final Rule, effective October 12, 2005.

FFCC submitted the boiler Comprehensive Performance Test (CPT) plan for approval on April 11, 2008. The plan was conditionally approved by EPA Region 6 on April 13, 2010. FFCC began the CPT on April 14, 2010 and concluded the testing on June 4, 2010. The results of this test are being submitted as the Notice of Compliance (NOC) to the EPA and ADEQ. FFCC will begin complying with the operational parameters and limits established within this NOC immediately upon submittal.

CONCLUSIONS ON MEETING CPT OBJECTIVES

The overall objectives of the Comprehensive Performance Test were to demonstrate that the boilers are capable of meeting the solid fuel-fired emission standards established in the MACT Combustion Rule (40 CFR 63 Subpart EEE) and to establish operating parameter limits that are equivalent with that demonstration. Table ES-1 summarizes the specific objectives demonstrated during the CPT.

FFCC was successful in meeting the overall CPT objective, and this NOC establishes the operating conditions that reflect the results of this successful test.

Table ES-1

Specific Objective	CPT Result
Demonstrate 99.99 % DRE of the designated POHC Chlorobenzene	≥ 99.9991 %
Demonstrate control of hydrocarbon emissions to less than 10 parts per million dry volume (ppmv), corrected 7 percent oxygen, on a hourly rolling average.	≤ 0.4 ppmv (a 7% O ₂)
Conduct a one time emission test for Dioxin/Furan or submit adequate data in lieu of testing, and Demonstrate control of hydrocarbon emissions to less than 10 parts per million dry volume (ppmv), corrected 7 percent oxygen, on a hourly rolling average (as shown above)	Agency approved data in lieu of D/F test located in Appendix F of the CPT Plan. One time D/F test results were 0.092 ng TEQ/dscm (a 7% O₂)
Demonstrate control of particulate emissions to less than 68 micrograms per dry standard cubic meter (ug/dscm) at to 7 percent oxygen.	26.2 ug/dscm (a 7% O ₂)
Demonstrate that control of HCl and free chlorine emissions are equal to or less than limit established using the health-based alternative compliance demonstration described in Appendix D of the CPT Plan (< 1,886.8 lb/hr chloride feed rate)	494 lb/hr
Demonstrate that control of mercury emissions are equal to or less than 11 micrograms per dry standard cubic meter (ug/dscm) corrected to 7 percent oxygen. During Test 2.	3.9 ug/dscm (a 7% O ₂)
Demonstrate that control of Semi-Volatile metals (SVM) emissions are equal to or less than 180 micrograms per dry standard cubic meter (ug/dscm) corrected to 7 percent oxygen during Test 2.	158.8 ug/dscm (a 7% O ₂)
Demonstrate that control of Low-Volatile metals (LVM) emissions are equal to or less than 380 micrograms per dry standard cubic meter (ug/dscm) corrected to 7 percent oxygen during Test 2.	117.3 ug/dscm (a 7% O ₂)
Gather data regarding waste feed characteristics and process operating conditions that will be used to develop operational permit limits that will ensure compliance with regulatory performance standards.	FFCC obtained all the necessary information to establish permit limits and demonstrate performance standards during the CPT.

DEVIATIONS FROM THE CPT PLAN

There were several operational related deviations from the approved CPT plan that were made prior to conducting the CPT. Table ES-2 details the changes made after formal EPA approval of the CPT plan.

Table ES-2

Change to the CPT Plan	Explanation of Change
Coal Sampling Location	The original plan called for FFCC to sample the coal and diatomaceous earth as fed; however, the Agency directed us to modify the original sampling plan to obtain the coal samples prior to the addition of the diatomaceous earth. The coal samples were then taken from a sample point at the exit of the coal silo which is approximately 8 feet before the area where the ash (diatomaceous earth) was spiked into the coal.
VOST Sampling Rate	The original plan called for FFCC to obtain 4 VOST tube pairs over 120 minute sampling period. The Agency directed us to obtain samples at a rate of 0.5 liters per minute, which increased the sampling time to 160 minutes.
Chloride Analysis	The CPT plan called for the commercial lab to use SW-846 Method 9076 or other approved method. The Laboratory used SW-846 Method 9057, which is an EPA approved method for measuring chloride. The Independent QA Reviewer examined this issue in detail (see Section 4) and determined that the use of Method 9057 rather than 9076 did not compromise the data.
Maximum Hazardous Waste Feed Rate Limit, Maximum Combustion Air Flow Rate Limit, and Maximum Percent Stack Gas Oxygen Limit	FFCC will set the maximum hazardous waste feed rate, the maximum combustion air flow rate limit, and the maximum percent stack gas oxygen limit based on the average of the test run averages, instead the average of the maximum hourly rolling averages as specified in the CPT plan. This is a more conservative approach.

Table ES-2, continued

Change to the CPT Plan	Explanation of Change
Maximum Mercury Feed Rate Limit	<p>FFCC plans to use the Maximum Theoretical Emission Calculation (MTEC) to establish the maximum mercury feed rate limit. FFCC had planned to use the average of the test run averages to establish a maximum mercury feed rate limit; however the mercury present in the coal was uncharacteristically low. As seen in Table 2.0 of the CPT plan, the average mercury in FFCC's coal is 0.15 ppm. The mercury in the coal used during the CPT was 0.044 ppm. The MTEC assumes zero percent removal efficiency for mercury. To further alleviate concerns, FFCC will set the feed rate limit at just 90% of the MTEC Calculated limit to ensure it stays well below the MACT EEE standard for solid fuel-fired boilers.</p>
Laboratory Analytical Methods	<p>The CPT plan stated that certain analytical methods or other approved methods would be used by the laboratory. The laboratory used EPA approved scientific methods for all analytical results, but some of those methods were not specifically mentioned in the plan. The methods used, that were not specifically listed, were evaluated by the independent third party QA/QC officer and determined to be approved and viable EPA methods. This evaluation is discussed in section 4.0 of the NOC.</p>

CPT ISSUES AND SOLUTIONS

The boilers met all CPT objectives; however, the following issues were encountered during the CPT:

- 1) THC CEMS Malfunction
- 2) VOST Audit Process
- 3) Coal Feed Rate

Issue 1 – THC CEMS Malfunction

We began stabilizing the boiler for Test 2, Run 1 at 05:00 am. At 06:11 am we encountered a mechanical malfunction on the THC CEMS which initiated an AWFCO. The control system mechanic for the CEMS did not arrive at the plant site until 08:00 am. He repaired the malfunction and we were back on line by 09:00 am stabilizing again. Test 2, Run 1 began at 10:04 am instead of the planned 07:00 am start.

Issue 2 – VOST Audit Process

The Agency did not ship the VOST audit materials with fittings that would work with the stack sampling crew's equipment, and did not provide a means to measure the temperature of the audit stack. FFCC initiated an extensive search for fittings at its plant site, but none were found that would provide leak free flow from the audit cylinder. In the end, the stack sampling crew was forced to break one of its sampling probes so that the VOST audit process could be completed.

Issue 3 – Coal Feed Rate

During Test 2, Run 3, the process operators failed to select the correct analytical data for waste tank WB01. FFCC was burning the test waste from WB01 but the computer was using analytical data entered for tank WB02. This did not impact the test results but it did cause the coal feed rate to read artificially low because the heating value for the waste in tank WB02 was higher than that of the test waste. They discovered this error at the end of Run 3 when they were switching the system back to burn from waste tank WB02. We informed agency oversight personnel of the mistake and demonstrated that that we were indeed burning from the CPT waste tank (WB01), during the test, by showing him the valve positions in the plant information system.

As shown in Section 1.2.1.1, the coal feed rate is not a direct measurement, but it is calculated indirectly based on various analytical and process data. It uses the heating value of the waste, the heating value of the coal, the feed rate of the waste, the steam production rate, various

temperature measurements, and the boiler efficiency to calculate the coal feed rate. Because the analytical for tank WB02 was selected, the computer used an artificially high heating value for the waste, which caused it to calculate an incorrect low coal feed rate. This explains the difference in the coal feed rate that was displayed on the computer screen between run 3 (Friday, June 4th) and runs 1 and 2 (Thursday, June 3rd).

In order to get a true and accurate coal feed rate, FFCC recalculated the coal feed rate based on the true Btu analysis of both the coal and the waste obtained from the sampling completed during the CPT. Appendix E-6 provides the process data for the coal feed rate correction that was used along with the correct Btu to obtain the true and accurate coal feed rate during the CPT.

PERMIT RELATED OPERATIONAL DATA

Table ES-3 provides a summary of the permit related operational data derived from the CPT.

Table ES-3

Parameter	Basis	Result
Maximum total hazardous waste feed (lb/hr-12HRA)	Average of the test run averages recorded during each run of Test 2	2,518 lb/hr
Maximum Chloride Feed Rate (lb/hr-12HRA)	Average of the test run average feed rates recorded during each run of Test 2	494 lb/hr
Maximum Ash Feed Rate (lb/hr-12HRA)	Average of the test run average feed rates recorded during each run of Test 2	791 lb/hr
Maximum Mercury Feed Rate (lb/hr-12HRA)	Based on 90% of the MACT Standard using the maximum theoretical emissions calculation (MTEC)	0.00083 lb/hr
Maximum Semi-Volatile Metal Feed Rate (lb/hr-12HRA)	Average of the test run average feed rates recorded during each run of Test 2 with extrapolation	0.64 lb/hr
Maximum Low-Volatile Metal Feed Rate (lb/hr-12 HRA)	Average of the test run average feed rates recorded during each run of Test 2 with extrapolation	4.58 lb/hr

Table ES-3, continued

Parameter	Basis	Result
Minimum Combustion temperature (degrees F)	Average of the test run averages of Test 1	1,061 deg F
Maximum Combustion Air Flow Rate (scfm)	Average of the test run averages recorded during each run of Test 2	21,130 scfm
Maximum Stack Gas Oxygen Content (%)	Average of the test run averages recorded during each run of Test 1	12.2 %
Maximum ESP Inlet Temperature	Average of the test run averages of Test 2	515 deg F
Minimum ESP Power (kW)	Average of the test run averages of Test 2	8 kW
Minimum Atomization Pressure (psig)	Manufacturer's Recommendation	30 psig
Maximum Combustion Chamber Pressure (in. w.c.)	Negative Pressure System	< 0

FINAL PERMIT LIMITS

The final limits adopted pursuant to this NOC are described in Table ES-3. All parameters will be continuously monitored process parameters that will be tied to automatic waste feed cutoffs (AWFCO).

TABLE OF CONTENTS

	Page
Executive Summary	i
Table of Contents	x
1.0 – Notification of Compliance	1
1.1 – Facility Information and List of Key Project Personnel	1
1.1.1 – Facility Information	1
1.1.2 – List of Key Project Personnel	1
1.2 – Detailed Engineering Description of the Boiler System.....	4
1.2.1 – Combustion and Fuel Feed Systems	6
1.2.1.1 – Primary Fuel Feed Systems	6
1.2.1.2 – Liquid Waste Feed Systems	7
1.2.1.3 – Sludge Feed Systems.....	8
1.2.1.4 – Alternative Solid Fuel Feed System.....	8
1.2.1.5 – Waste Vent Gases.....	9
1.2.2 – Prime Mover	10
1.2.3 – Waste Liquid Injection Nozzles	11
1.2.5 – Automatic Waste Feed Cutoff System	12
1.2.6 – Description of Air Pollution Control Equipment	13
1.2.7 – Ash Handling System	15

TABLE OF CONTENTS, continued

	Page
1.2.8 – Boiler Stack.....	16
1.2.9 – Location and Description of Temperature, Pressure, And Flow Indicating and Control Devices	16
1.2.10 – Stack Gas Monitoring System	17
1.3 – Boiler Operator Training and Certification	19
2.0 – Sampling and Analysis Program	20
2.1 – Sampling Program.....	20
2.1.1 – Waste Feed Preparation	20
2.1.2 – Sampling and Monitoring Procedures	21
2.1.2.1 – Solid Fuel Feed	21
2.1.2.1.1 – Coal Samples	21
2.1.2.1.2 – Ash Spiking	21
2.1.2.2 – Organic Waste Feed	22
2.1.2.2.1 – Volatile Organic Analysis Samples	22
2.1.2.2.2 – Organic Waste Samples.....	22
2.1.2.3 – Metals Spiking Solution.....	22
2.1.3 – Combustion Gas	22
2.1.3.1 – Combustion Gas Temperature	22
2.1.3.2 – Combustion Gas Monitoring.....	23

TABLE OF CONTENTS, continued

	Page
2.1.4 – Stack Gas	25
2.1.4.1 – Hydrogen Chloride and Chlorine Train	25
2.1.4.2 – Multi-Metals Train	26
2.1.4.3 – Volatile Organic Sampling Train.....	26
2.1.4.4 – Dioxin/Furan Sampling Train	26
2.2 – Analytical Program	27
2.2.1 – Analytical Methods	27
2.2.2 – Analytical Results	27
3.0 – Description of the Test Program	28
3.1 – CPT Objectives	28
3.2 – CPT Approach	29
3.2.1 – POHC Selection	29
3.3 – CPT Program.....	30
3.3.1 – Comprehensive Performance Test 1.....	30
3.3.2 – Comprehensive Performance Test 2.....	31

TABLE OF CONTENTS, continued

	Page
3.4 – CPT Sampling and Analytical Protocols	31
4.0 – Comparison of Actual Test Conditions versus Planned Conditions and Independent QA Review	33
4.1 – Combustion Device Parameters	33
4.2 – Feed Rate Parameters	34
4.3 – Constituent Feed Rate Parameters	34
4.4 – Stack Gas Parameters	34
4.5 – Independent QA Review	35
4.5.1 – Stack Testing Equipment	35
4.5.2 – Stack Gas-Particulate Analysis.....	35
4.5.3 – Stack Gas – Metals Analysis	35
4.5.4 – Stack Gas – Volatile Organics Analysis	36
4.5.5 – Stack Gas – Continuous Emissions Monitoring Data	36
4.5.6 – Waste-Volatile Organics	36
4.5.7 – Feed-Metals and Chloride	37
4.5.8 – Feed – General Chemistry.....	37
4.5.9 – Analytical Method Deviations.....	38
4.5.10 – Conclusion	40

TABLE OF CONTENTS, continued

	Page
5.0 – Comparison of Test Results with Regulatory Compliance Limits.....	41
5.1 – Regulatory Requirements for the CPT	41
5.1.1 – Destruction Removal Efficiency	41
5.1.2 – Particulate Emissions	41
5.1.3 – HCl / Cl ₂ Emissions	42
5.1.4 – Mercury Emissions	42
5.1.5 – Semi-Volatile Metals Emissions	42
5.1.6 – Low-Volatile Metals Emissions	42
5.1.7 – Dioxin/Furan Emissions	43
5.1.8 – Total Hydrocarbon Emissions	43
6.0 – Procedures and Limitations for Operating Parameters	44
6.1 – Waste Feed Rate Limitations	44
6.1.1 – Maximum Hazardous Waste Feed Rate Limit.....	44
6.1.2 – Maximum Chloride Feed Rate Limit.....	44
6.1.3 – Maximum Ash Feed Rate Limit.....	44
6.1.4 – Maximum Metals Feed Rate Limits.....	44
6.1.4.1 – Maximum Mercury Feed Rate	45

TABLE OF CONTENTS, continued

	Page
6.1.4.2 – Maximum Semi-Volatile Metals Feed Rate.....	45
6.1.4.3 – Maximum Low-Volatile Metals Feed Rate.....	45
6.1.4.4 – Metals Feed Rate Extrapolation	45
6.2 – Combustion Chamber Limitations	46
6.2.1 – Minimum Combustion Chamber Temperature Limit.....	46
6.2.2 – Minimum Atomization Pressure Limit.....	46
6.2.3 – Maximum Furnace Pressure Limit.....	47
6.2.4 – Maximum Combustion Air Flow Rate Limit.....	47
6.3 – Air Pollution Control Limitations.....	47
6.3.1 – Minimum ESP Power Limit.....	47
6.3.2 – Maximum Inlet Temperature to the ESP.....	48
6.4 – Stack Gas Limitations.....	48
6.4.1 – Maximum Total Hydrocarbon Limit.....	48
6.4.2 – Maximum Percent Oxygen Limit.....	48
7.0 – Statement of Compliance.....	49
END OF TEXT.....	49

LIST OF TABLES

Table 1.0 – Feed Stream Analysis Data

Table 2.0 – Feed Stream Characteristics

Table 3.0 – Process Monitoring Instruments

Table 4.0 – Process Monitoring Instruments, Calibration, and Maintenance

Table 5.0 – CPT Process Feed Analytical Results

Table 6.0 – CPT Spiking Information

Table 7.0 – CPT Stack Gas Analytical Results

Table 8.0 – CPT Test 1 Averages

Table 9.0 – CPT Test 2 Averages

Table 10.0 – CPT Comparison of Planned Conditions to Actual Conditions -
Test 1, Run 1

Table 11.0 – CPT Comparison of Planned Conditions to Actual Conditions -
Test 1, Run 2

Table 12.0 – CPT Comparison of Planned Conditions to Actual Conditions -
Test 1, Run 3

Table 13.0 – CPT Comparison of Planned Conditions to Actual Conditions -
Test 2, Run 1

Table 14.0 – CPT Comparison of Planned Conditions to Actual Conditions -
Test 2, Run 2

Table 15.0 – CPT Comparison of Planned Conditions to Actual Conditions -
Test 2, Run 3

LIST OF TABLES, continued

Table 16.0 – Demonstration of Compliance

Table 17.0 – Boiler Removal Efficiency

Table 18.0 – Summary of Operating Parameter Limits

Table 19.0 – Metal Extrapolation

Table 20.0 – Mercury MTEC Feed Rate Limit

Table 21.0 – Summary of Sampling and Analysis Program

LIST OF ATTACHMENTS

Attachment A – Alliance Source Testing – CPT Report

Attachment B – Quality Assurance Project Plan

Attachment C – Instrument Calibration Records

Attachment D – CPT Field Logs

Attachment E – Other Information

Attachment E-1 – Metals Spiking Certificate of Analysis

Attachment E-2 – Field Sampling and Spiking Logs

Attachment E-3 – Combustion Air Correlation Curve

Attachment E-4 – Relative Accuracy Test Audit

Attachment E-5 – Process Test Data

Attachment E-6 – Coal Feed Rate Data

LIST OF DRAWINGS

Process Flow Diagram Coal Fired Boiler.....	Figure 1.0
Boiler House Operating Floor Plan.....	6M01-1A-021
Boiler Sectional Side View.....	6M01-4V-014
APCD and Ductwork Arrangement.....	6M01-4V-016
Waste Liquid Injection Nozzle.....	6M01-4E-554
Boiler and Instrument Block Diagram Boiler 1.....	6M01-9T-024
Boiler and Instrument Block Diagram Boiler 2.....	6M01-9T-025
Boiler and Instrument Block Diagram Boiler 3.....	6M01-9T-026
I.D. Fan	6M01-5-048
F.D. Fan	6M01-5-049
Overfire Fan.....	6M01-5-093
Waste Feed Piping and Instrumentation Boiler 1.....	6M01-9T-031
Waste Feed Piping and Instrumentation Boiler 2.....	6M01-9T-032
Waste Feed Piping and Instrumentation Boiler 3.....	6M01-9T-089
CEMS Piping and Instrumentation.....	6M01-9T-005

1.0 Notice of Compliance

The following notification of compliance summarizes the activities associated with the comprehensive performance test (CPT), documents the results of the CPT, and serves as the basis for the development of permit conditions. The CPT was generally conducted in accordance with the CPT plan as approved April 11, 2008 as revised May 14, 2010.

1.1 Facility Information and List of Key Project Personnel

The following section gives background facility information and provides a list of key project personnel.

1.1.1 Facility Information

Background facility information is listed below:

Facility Name:	FutureFuel Chemical Company
Contact:	Thomas L Floyd
Address:	P.O. Box 2357 2800 Gap Rd. Hwy 394-S Batesville, Arkansas 72503
Telephone Number:	(870) 698-1811
U.S. EPA Identification No.	ARD089234884
Permitting Agencies:	Environmental Protection Agency, Region 6 Arkansas Department of Environmental Quality, Air Division Arkansas Department of Environmental Quality, Hazardous Waste Division

1.1.2 List of Key Project Personnel

A list of key project personnel is shown below:

Project Manager	Name	Steve Case, P.E.
	Company	FutureFuel Chemical Company
	Title	Technical Associate
	Address	P.O. Box 2357 Batesville, Arkansas 72503
	Telephone No.	(870) 698-1811
	Responsibility:	Responsible for all aspects of the CPT

CPT Manager	Name	Thomas L Floyd
	Company	FutureFuel Chemical Company
	Title	Senior Environmental Biologist
	Address	P.O. Box 2357 Batesville, Arkansas 72503
	Telephone No.	(870) 698-1811
	Responsibility:	Responsible for implementing and coordinating the CPT

Independent Third Party Quality Assurance Auditor	Name	David Weeks
	Company	Risk Management & Engineering, LTD.
	Title	Senior Environmental Engineer
	Address	Dallas, TX
	Telephone No.	(972) 412-6819
	Responsibility:	Independent third party quality assurance auditor for all aspects of the CPT

Stack Sampling Project Director	Name	Jeremy Hutchens
	Company	Alliance Source Testing
	Title	Environmental Scientist
	Address	214 Central Circle SW Decatur, Alabama 25603
	Telephone No.	(256)260-3974
	Responsibility:	QA/QC assurance of stack gas sampling to ensure integrity of emissions data.

Process Spiking Coordinator	Name	Mike Gillihan
	Company	FutureFuel Chemical Company
	Title	Process Assistant
	Address	P.O. Box 2357 Batesville, Arkansas 72503
	Telephone No.	(870) 698-1811
	Responsibility:	Coordinating process spiking

Process Sampling Coordinator	Name	Marshel Bray
	Company	FutureFuel Chemical Company
	Title	Environmental Process Assistant
	Address	P.O. Box 2357 Batesville, Arkansas 72503
	Telephone No.	(870) 698-1811
	Responsibility:	Coordinating process sampling

Stack Sampling Field Supervisor	Name	Ryan O'Dea
	Company	Alliance Source Testing
	Title	
	Address	
	Telephone No.	
	Responsibility:	Coordinating the collection of stack gas emissions

Laboratory Coordinator & QA/QC Manager	Name	Michael D. Challis
	Company	Maxxam
	Title	Laboratory QA/QC Manager
	Address	P.O. Box 598 Addison, Texas 75001
	Telephone No.	(972) 931-7127
	Responsibility:	Coordinating the laboratory analysis of all samples and ensuring QA/QC procedures on sampling and analysis.

EPA Oversight Personnel	Name	Harry Shah
	Company	EPA, Region 6
	Title	Project Engineer
	Address	1445 Ross Ave, Dallas, TX
	Telephone No.	
	Responsibility:	EPA Oversight of the CPT

Agency Oversight Personnel	Name	Larissa Brown
	Agency	Arkansas Department of Environmental Quality
	Address	1141 E. Main St, Suite #315 Batesville, AR 72501
	Telephone No.	(870) 793-4762
	Responsibility:	ADEQ oversight of the CPT

1.2 Detailed Engineering Description of Boiler System

FFCC operates three hazardous-waste-burning coal-fired boilers (Nos. 1, 2 and 3) at its Batesville, Arkansas plant. These boilers generate steam for plant operations by burning coal, non-hazardous and hazardous liquid process wastes, biomass fuel, bio-sludge and non-hazardous solid waste for energy recovery.

The boilers and associated coal feeding systems, liquid waste feed systems, ash handling equipment, and air pollution control equipment are housed in FFCC's B-6M01 boiler area.

The three coal-fired boilers are Model MKB units built by E. Keeler Co. The boilers are identical in design, capacity, and operation. Preventive maintenance programs are also identical for each boiler. The boilers were installed at the FFCC site between October 1975 and December 1976. The practice of third party engineer construction certification was not prevalent at the time the boilers were installed. However, construction supervisors from E. Keeler were hired and present onsite as the boilers were installed and taken through start-up. At the time of construction, the E. Keeler construction supervisor ensured that the boilers were field erected within manufacturer design tolerances.

The boilers are balanced, draft, power generation, water-tube type units that have been fitted with atomizing nozzles to facilitate burning of liquid wastes. Each boiler consists of a combustion air fan, a traveling grate stoker, a steam drum, a mud drum, a super-heater, an economizer, an induced draft fan, an over-fire air fan, a soot blower system and a computerized boiler control system. The current design criteria for the boilers are as follows:

Design Criteria

- Pounds of Steam per Hour (continuous) — 50,000
- Pounds of Steam per Hour (4-hour peak) — 57,500
- Operating Pressure (psig) — 610
- Design Pressure (psig) — 675
- Steam Temperature (°F) — 700
- Feedwater Temperature (°F) — 270
- Total Heating Surface (ft²) — 4,839

- Radiant Heating Surface (ft²) — 689
- Convection Heating Surface (ft²) — 4,150
- Furnace Volume (ft³) — 3,390
- Fuel — coal, solid refuse, gas, liquid fuels and liquid waste fuels

Drawing 6M01-1A-021 and Drawing 6M01-4V-014 show equipment arrangements and a cut-away view of the Keeler boilers. The firebox dimensions are approximately 11 feet wide by 19 feet long by 45 feet tall. The boilers are rated for a maximum heat release of 76.6 million British thermal units (Btu) per hour each and a solid processing rate of 4.2 tons per hour. A simplified block flow diagram of the boiler system is provided on Figure-1.0.

The spreader-type stoker firebox combusts coal in both suspension and via mass burning. This combustion provides all of the heat needed to maintain steady flame characteristics in the boiler combustion chamber. Waste combustion is ancillary to this primary combustion. The suspension burning takes place as the coal exits the spreader. The coal ignites and burns as it travels to the grate, where the heavier coal particles continue to burn as a mass on the grate. Combustion air is routed to the firebox, both under the grates, (which supports the mass burning and overall combustion), and as overfire air, (which provides secondary air to complete the combustion process and to add turbulence in the firebox). The combustion of waste fuels and coal produces flame temperatures inside the firebox between 2000 and 2400 °F.

Cleaning and Maintenance

Each boiler is equipped with a soot-blowing system, which blows high-pressure steam through the tubes to remove soot.

The boilers are also washed out once a year before the annual preventative maintenance is performed on the boiler. The boilers are normally shutdown one at a time during the months of June, July and August for preventative maintenance. The firebox, super heater, economizer, ash handling system and precipitator sections of the boilers are washed out. High pressure water is used during the cleaning process to ensure that the debris is removed from the grates, walls and tubes through out the boiler.

In addition, if the operators determine that boiler performance has significantly deteriorated during typical process run cycles, the unit is taken out of service, inspected, and cleaned if necessary.

1.2.1 Combustion and Fuel Feed Systems

Currently, approximately 13,000 tons per year of fuel-quality liquid waste are burned as fuels in FFCC's three coal-fired industrial boilers in addition to coal and other types of waste fuels. The fuels and waste streams that can be fed are summarized as follows:

<u>Feed Stream</u>	<u>Feed System</u>
Coal	2 Spreader Stokers per Boiler
Nonhazardous/Hazardous Liquid Waste	1 Steam-Atomized Nozzle per Boiler
Bio-Sludge	2 Air-Atomized Nozzles per Boiler
Biomass Fuels (e.g., Wood chips)	2 Spreader Stokers per Boiler

FFCC processes the feed streams described above as follows:

- The feeder stokers feed coal and biomass fuels into the boiler.
- All liquid wastes are atomized through waste nozzles by high-pressure steam into the boiler.
- The bio-sludge wastes are atomized through waste nozzles by high-pressure air into the boiler.

It is FFCC's understanding that successful performance of a CPT in accordance with this plan will constitute approval to burn the types of waste described in this section.

1.2.1.1 Primary Fuel Feed Systems

Stoker coal is the primary fuel used to maintain the Boilers at a steady state. Coal is fed to the boilers on a continuous basis (i.e., 24 hours/day, 7 days/week) to maintain the desired steam demand. The coal used by the boiler system is a solid material with a maximum particle size of 2 inches. Heating value and other characteristics are described in Tables-1.0 and 2.0.

Coal is delivered in rail cars or trucks, which are unloaded into track-hoppers. From the hoppers, the coal is conveyed on a belt conveyor system up to three separate coal bunkers inside the B-6M01 boiler area. The coal is gravity fed from the bunkers into the boilers. The coal is mechanically spread by stokers which flip it to the opposite side of the boiler, (the boilers are equipped with two spreader stokers, identical in design and operation). The coal falls onto a traveling grate that slowly moves the burning bed of coal across the boiler.

The feed rate of the coal is determined by measuring the steam flow rate, economizer water temperature outlet, waste feed rate, and the heat contents of the waste and coal. Coal feed rate is determined by the following equation:

$$Q = \frac{\left[\left[A \times \left(1,308 \frac{\text{BTU}}{\text{lb}} - 244 \frac{\text{BTU}}{\text{lb}} \right) \right] - \left[A \times (B - 274 \text{ } ^\circ\text{F}) \times \left(0.525 \frac{\text{BTU}}{\text{lb} \cdot \text{F}} \right) \right] \right]}{\left(\frac{E}{100} \right)} - (M \times F)$$

Where,

Q = Coal Feed Rate (lb/hr)

A = Steam Flow Rate (lb/hr)

B = Economizer Water Outlet Temperature (° F)

E = Boiler Efficiency (typically 70 to 80%)

F = Heat Content of Waste (BTU/lb)

G = Heat Content of Coal (BTU/lb)

M = Waste Feed Rate (lb/hr)

1.2.1.2 Liquid Waste Feed Systems

The characteristics of the FFCC wastes are described in Tables-1.0 and 2.0. The waste characteristics provided in the tables are typical of as-fired conditions; although FFCC may occasionally blend hazardous waste by moving material between tanks to meet desired waste feed characteristics and regulatory requirements. The liquid wastes burned in the boilers are normally supplied from either the No. 1 Tank Farm or the Sludge Tanks. The No. 2 Tank Farm normally does not send waste directly to the boilers, but vent gases from the No. 2 Farm are routed to the boilers. The No. 1 Tank Farm consists of three storage tanks. These tanks are permitted hazardous waste tanks referred to as WB-01, WB-02, and WB-03. Each of these tanks has a 10,000-gallon capacity and is equipped to hold liquid wastes for treatment at the RCRA facility. The tanks are equipped with high- and low-level alarms and level indicators, located in the Incinerator and Boiler Control Rooms.

The sludge tanks, WDT-01 (North Tank) and WDT-02 (South Tank), are RCRA-permitted hazardous waste tanks. Both tanks are 2,500-gallon in capacity, insulated, and externally lined

with 30 psig heat tracing. Both tanks are equipped with high- and low-level alarms and level indicators, located in the Incinerator and Boiler Control Rooms.

Liquid waste can also be burned directly in the boilers from containers. FFCC uses several 750-gallon portable containers to transfer wastes to the treatment facility. FFCC also has the ability to burn directly from a tank truck if necessary. The portable containers are used for special manufacturing situations and for waste that have the potential to be incompatible with the waste stored in FFCC storage tanks.

Centrifugal pumps are used to transfer waste from the storage tanks and containers to the boilers through a variety of lines. The flow rate of the liquid wastes is continuously monitored by mass flow meters and can be adjusted with a control valve located at each boiler. Two automatic block valves in the liquid waste line ensure proper shut-off when not burning. The liquid hazardous waste feed system has the capability of supplying up to 5,100 lb/hr of liquid waste to the boilers; however, typical waste feedrates are approximately 2,000 – 2,500 lbs/hour. The liquid waste feed line is controlled by atomizing the waste feed with 150 psig steam.

The boiler waste feed piping and instrumentation can be seen in drawing 6M09-9T-089.

1.2.1.3 Sludge Feed Systems

In addition to liquid hazardous waste, the boilers are also equipped to burn various types of sludges. Currently, only non-hazardous sludge from FFCC's biological waste water treatment plant is burned in the boilers via nozzles (separate from those used to burn liquid waste) which use high-pressure air to atomize the waste as it is introduced into the boilers. The bio-sludge feed system has a capacity of 7,000 lb/hr.

1.2.1.4 Alternative Solid Fuel Feed System

Alternative fuel is conveyed on a belt conveyor system along with the coal up to three separate coal bunkers inside the B-6M01 boiler area. It is then gravity fed from the bunkers with the coal into the boilers. The alternative fuel and coal is mechanically spread by stokers which flip it to the opposite side of the boiler, (the boilers are equipped with two spreader stokers, identical in design and operation). The alternative fuel falls onto a traveling grate that slowly moves with the burning bed of coal across the boiler.

1.2.1.5 Waste Vent Gases

Fugitive emissions from FFCC's hazardous waste storage tanks are routed to Boilers No. 1 and 2 for destruction. The P&ID diagram for the vent system is attached. Each tank vents through a detonation arrestor and pressure safety valve (PSV) into a common stainless steel header. The header is equipped with low point drains that are steam traced. The temperature of the steam tracing prevents the vapors from condensing in the header. The drains are checked periodically to ensure that vapor condensation is not occurring. The coal-fired boilers operated under negative pressure with an induced draft fan on the back end of the boiler system. This induced draft pulls the tank vapors into boiler combustion zone for destruction. The vapors pass through a flow meter, a double block and bleed valve arrangement, a manual valve, and a flame arrestor, before entering the liquid waste feed injection nozzle. The vent system is controlled by the boiler operators.

The vent system ductwork is constructed of 316L stainless steel from the tanks up to the point where the duct enters building 6M01. The ductwork construction material then changes to carbon steel. Carbon steel is used because the ductwork from the edge of building 6M01 to the boilers was present prior to installation of the vent gas feed system. This existing carbon steel ductwork was not being used for another purpose at the time the vent system was designed and constructed.

Detailed information about the vent system can be obtained from FFCC's Title V permit application. Emissions from each of the 11 tanks are included in the volatile organic compound emission estimates. EPA's TANKs program was used to derive the VOC emission rate estimates. These calculations resulted in an estimate of 3.9 lb/hr VOCs vented to the boilers (this amount of VOCs is negligible when compared to the trial burn liquid waste feed rates of 1,350 and 3,672 lb/hr). Although the waste vent gases are currently routed only to boilers 1 and 2, as noted above, the impact from these VOCs is negligible. Given this negligible impact, boiler 3 is representative of the operational conditions and performance of all units. Based on the 3.9 lb/hr emission rate, the worst case chlorine emission is 0.6 lb/hr chlorine assuming all the VOCs in the tanks is monochlorobenzene.

1.2.2 Prime Mover

The induced draft fan will provide motive force to transport the combustion gas through the unit where it is expected to exit the boilers at temperatures between 375 and 515 °F. The fan is a Model 6,000 Radial Tip type assembly manufactured by Chicago Blower (see drawing 6M01-5-048). The flue gas flow rate is expected to range between 20,000 to 40,000 actual cubic feet per minute (acfm) when producing steam. The maximum flue gas flow rate capacity was set at 49,827 acfm during 1999 trial burn. We plan to target 42,000 acfm during the CPT. Specific design criteria for the prime mover are provided below and are based on a specific static pressure.

The forced draft fan will provide the majority of the combustion air to the boiler system (see drawing 6M01-5-049). The forced draft (FD) fan is the only variable combustion air input. Combustion air is also supplied by the overfire fan (shown in drawing 6M01-5-093) and waste chemical fan (shown in drawing 6M01-9T-089), but these two combustion air inputs are fixed at 3,050 scfm and 1,800 scfm respectively. These two fixed air supplies will be on when burning waste and their respective total combustion air input (4,850 scfm) will be added to the combustion air provided by the FD fans. The FD fans provide 21,456 scfm combustion air at 100% of design. The amount of combustion air provided by these identical fans is measured the same on all three boilers. The measurement is the square root of a differential pressure across an annular ring. This measurement is recorded as 0 to 100% of measured flow. The % measured flow will be converted to scfm based on the design of the FD Fans.

1.2.3 Waste Liquid Injection Nozzles

Each boiler has one waste liquid injection nozzle located above the coal fuel bed. Each nozzle is designed to atomize liquid waste using 150 pounds per square inch gauge (psig) high pressure steam for atomization which helps to prevent blockage. The waste liquid injection nozzle can be seen in drawing 6M01-4E-554. The steam atomization pressure is maintained at a minimum of 40 psig. The liquid waste pressure is maintained at a minimum of 20 psig when burning waste. The burner is also equipped with piping to facilitate burning of waste vent gases and a separate blower to provide combustion air that facilitates waste burning.

Even though the waste injection system is composed of traditional burner elements that combine fuel and air, the system does not function as a primary fuel burner. Rather, the liquid waste injection system is merely designed to facilitate the combustion of the waste by the primary coal fed combustion system. The temperature and turbulence needed to ensure waste combustion is provided by the coal fuel bed. The coal fuel bed supplies the flame stability for the system. For example, FFCC procedures establish a minimum steam production and minimum temperature before waste is introduced to the boiler. Hence, traditional burner design criteria are not totally applicable to the liquid waste injection system.

Design Criteria

- Size — 100 million BTU/hour
- Viscosity — The liquid waste injection nozzle does not function as a stand-alone burner that is solely responsible for waste combustion performance. Rather combustion inside the boiler firebox is controlled and effectuated by the combustion of the coal-fuel bed. The liquid waste injection nozzle serves only to introduce waste into the boiler firebox. Therefore, viscosity is not a design concern for this nozzle because the nozzle does not function as a burner and combustion stability is maintained by the coal fuel bed. For informational purposes, the nozzle as a burner is designed to maintain a stable flame with liquids ranging from No. 2 to No. 6 fuel oil. No. 6 fuel oil at 100°F has a viscosity of 310 centipoise. If the nozzle was used as a main waste burner, then a design viscosity to ensure stable flame conditions might be appropriate. However, the nozzle is not being used as a burner in this boiler design and thus, should not be a limiting parameter of the permit.
- Minimum Heating Value — None.
- Excess Air — The liquid waste injection nozzle and boiler forced draft fan jointly supply excess air to the boiler firebox.
- Burner Pressure — The pressure range for the liquid waste injection nozzle is 10 to 125 psig. The pressure range for the steam atomization pressure is 3 – 50 psig.

1.2.5 Automatic Waste Feed Cutoff System

The primary function of the AWFCO system is to prevent the feeding of hazardous waste if combustion conditions are outside notification of compliance (NOC) limits. The AWFCO system is implemented in the boiler distributive control system (DCS).

FFCC boilers are equipped with a central control system paired with a Data Acquisition System (DAS) to provide the necessary monitoring and control. The control system is comprised of a DCS (MOD 300), and the DAS is a separate, interfaced data historian (OSISoft PI System). The DCS is linked to the Continuous Emission Monitoring System (CEMS) and other process instrumentation necessary to properly control boiler combustion and the fuel feed systems and to monitor permit parameters.

The DCS is equipped with operator interfaces so that boiler operation can be monitored and modified, if necessary, by the operator when the boiler is in use. The DCS receives as inputs the operating variables from the CEMS and other system monitoring devices and transmits their values to the operator interfaces and the DAS system. The values are also stored within the DCS for short-term recordkeeping. The DCS receives new input readings of each required variable at least every 15 seconds and writes the value to the DAS. The DCS also computes a number of calculated values that are necessary to ensure permit compliance. Periodic and hourly rolling averages are also calculated in the DCS as required and where not already calculated in the CEMS. The DCS is capable of short-term recordkeeping and the PI system provides the long-term historical record. Industry standard data compression techniques are used to minimize the storage space required for the long-term historical data.

The 60-minute rolling averages for the CEMS (THC and O₂) are computed by an ESC data logger. The ESC uses the data measured by the CEMS at least every 15 seconds to compute 1-minute periodic averages. The ESC then calculates hourly rolling averages once a minute based on the previous sixty 1-minute periodic averages for each parameter. The hourly rolling averages computed by the ESC data logger are sent directly to the DCS before being forwarded to the DAS. The DCS uses the hourly rolling average CEMS data to activate interlocks if necessary.

The DCS monitors the boiler operation including all the required permit operating parameters. If any parameter exceeds its regulatory limit, the DCS initiates an automatic waste feed cutoff by transmitting a digital signal which immediately closes the dual block valves that prohibit waste from entering the unit. Simultaneously, the DCS initiates an increase in the coal feed rate to maintain boiler load and temperature. The radiant heat in the boiler will not allow the chamber temperature to drop significantly during the cutoff of liquid hazardous waste. Therefore, any residual liquid hazardous waste fuel in the boiler will be burned. In accordance with regulatory requirements, FFCC will test the waste feed cutoff system, for each boiler, once each week during normal operation. This test includes all associated alarms.

In order to minimize the number of waste feed cutoffs, the DCS will annunciate the appropriate alarm when any of the monitored variables reach a high percentage of their limits. This early warning permits the boiler operator to take necessary corrective action before established limits are exceeded. The early alarm does not activate the AWFCO system. The AWFCO system is activated immediately whenever a permit related parameter reaches its limit. The DAS records all automatic waste feed cutoffs, either tests or actual.

The final AWFCO parameter values will be based on the operating limits established during the DPT and will be identified in the notification of compliance.

1.2.6 Description of Air Pollution Control Equipment

Combustion gases from the boilers are treated by individual electrostatic precipitators (ESPs) to remove the flyash and other contaminants. Drawing 6M01-4V-016 provides a cut out view of the boiler pollution control equipment arrangement. The design criteria for the ESP are as follows.

Design Criteria

- Manufacturer Name: Research-Cottrell, Inc.
- Model No: IP3280
- Removal Efficiency: 99.6% (based on 1999 Trial Burn)
- Performance Monitoring: Power Input (KW)
- Nucendorfer Precipitation Controls

Each section of the three ESPs has fifteen 9-inch wide ducts, formed by sixteen vertically aligned collecting plates, 15 feet high. The collecting plates are arranged in two banks of eight plates, and each bank of plates is supported at its upper leading and trailing edges by individual anvil beams. There are 48 collecting plates in each ESP. Suspended in the center of the ducts of each ESP section are 120 discharge electrode wires. These wires are formed by 0.1055" diameter, hard-drawn basic wire without coating, with a capped shroud at the top and bottom. Each wire supports a 15 or 25 pound cast iron weight, in plumb bob suspension, except four wire frames, which support the steadying bars. There are 360 discharge electrodes in each ESP. To provide for more uniform gas distribution, perforated distribution plates are located at the inlet end of each ESP. A 3/16" -thick, mild-steel shell encloses the collecting plates and discharge electrodes. Two pyramidal-type hoppers are located at the bottom of each ESP and three insulator compartments are located on the roof. Each insulator compartment serves one unit section in each ESP.

Transformer-Rectifier Sets

High voltage, uni-directional power for energizing wire supporting frames in each ESP is supplied by three, 45 kv and 250 ma transformer-rectifier sets (silicon). The three transformers on each ESP are located on the ESP roof. Connections to the interior of each unit section are made with one run of pipe and guard. Each transformer-rectifier energizes one wire frame in one unit section with full-wave voltage. The high voltage transformer and silicon rectifier of each set are submerged in an oil-filled tank, which is equipped with two high-voltage output bushings.

An advanced microprocessor energization system, designed to maintain maximum usable ESP power by monitoring and automatically controlling electrical variables, is provided. It continuously and automatically adjusts to conditions such as changing boiler loads, variable fuel supplies, and upset situations without readjustment.

The control units for the transformer rectifier sets (silicon) are free standing, metal cabinets for indoor installation. Manual and automatic controls are provided. Each control unit contains all of the components required to control and protect one transformer-rectifier set except for a resistor board, which is located in the rectifier ground switch enclosure.

Collecting Plate Rappers

The collecting plates of each ESP are cleaned of collected material by the action of seven magnetic-impulse, gravity impact (MIGI) rappers. There are two rappers in each unit section and one in the inlet flues.

Discharge Electrode Vibrator

The discharge electrode wires of each ESP are cleaned of collected material by the action of three vibrators. There is one vibrator in each unit section.

Collecting Plate Rapper Control

The control for the MIGI rappers is installed in a single cabinet for each ESP. The control for each ESP is a Neundorfer MicroRap microprocessor-based rapper control system. The system energizes a rapper on a custom frequency. The rappers can be managed controlled in groups or individually. This allows the rapping intensity of each group or rapper to be adjusted independently of the other groups.

Discharge Electrode Vibrator Controls

The controls for the vibrators are installed in a single cabinet for each ESP. Each control includes one vibration period controller and one cam timer. The cam timer has a synchronous gear-motor, cam shaft, cams and switches. The motor drives the camshaft at a constant speed and the rotating cams actuate eight load switches. A vibrator is energized each time a load switch closes. A multi-notch cam and switch on each cam timer is used to actuate the vibration period controller which limits the period of vibration of each vibrator to a maximum of six seconds. The cam timer is adjusted so that the vibrators are energized in consecutive order without overlapping. The cam timer has a time cycle of 30 minutes.

1.2.7 Ash Handling System

The ash handling system is composed of two subsystems; the bottom ash hopper sluicing system and the fly ash system. The bottom ash hopper sluicing system removes clinkers (bottom ash) from the three firebox bottom ash hoppers and flushes them out of the plant to an ash management area. Each bottom ash hopper is equipped with a clinker crusher and Jetpulsion pump. The crusher grinds the clinker material down to a size suitable for sluicing out of the plant by the Jetpulsion pump using high pressure ash service water. The Jetpulsion pumps are controlled by valves in the supply line to each pump. The three bottom ash hoppers are normally emptied one after the other in sequence manually or by an automatic control system. The control panel also contains controls to operate the sluice gate associated with the precipitator hopper washdown drain sump.

The fly ash system removes stored fly ash from six precipitator hoppers, three economizer hoppers and three siftings hoppers, mixes it with water and sluices it out of the plant to the ash management area. The hopper sections are equipped with self-feeding fly ash intakes, which control the flow of ash from the collecting hoppers to the ash transport lines. The ash is conveyed pneumatically through the transport lines to a Hydroveyor exhaustor. The ash/air/water mixture then passes through an air separator where the air is bled off. The

ash/water slurry continues down the sluicing line to the management area under pressure from the Hydroveyor exhauster. The fly ash intakes are operated as a programmed sequence by an automatic control system. This automatic sequence is initiated by push-button from the fly ash system mimic control panel and proceeds to completion.

1.2.8 Boiler Stack

The three boilers share a common 200-foot tall by 108-inch (at exit) diameter stack. The stack interior is constructed of gunnite and red brick. The external part of the stack is made from 10-inch thick reinforced concrete. The base of the stack is 232 inches in diameter. During the trial burn, combustion gases will bypass the main stack and be sampled from a "stub" stack especially designed to facilitate sampling of stack gases. The main stack cannot be used for sampling because the emissions from Boiler No. 3 cannot be differentiated from the non-sampled coal fired boilers. The agency has approved use of the "stub" stack in all previous testing. The "stub" stack is constructed such that cyclonic flow is controlled.

1.2.9 Location and Description of Temperature, Pressure, and Flow Indicating and Control Devices

FFCC uses a variety of devices to control the operation of the boiler system. A list of the instruments important to the combustion of hazardous waste including their description and location can be seen in Tables-3.0 and 4.0.

1.2.10 Stack Gas Monitoring System

FFCC continuously monitors oxygen (O₂) and total hydrocarbon (THC) levels in the combustion stack gases. The continuous emission monitoring system (CEMS) presently utilized by FFCC is an extractive system. The CEMS and other process instrumentation are summarized in Tables 3.0 and 4.0. The CEMS piping and instrumentation diagram can be seen in drawing 6M09-9T-005.

The CEMS is divided into three parts: a sample probe (installed directly on the dedicated breech to a common stack); a sampling gas conditioning and analysis cabinet (SGC&AC); and a heated sample line (HSL) connecting these two parts. The probe/primary filter assembly is a sample extractive device, which is placed in direct contact with the flue gas environment. It is used to draw in and filter a representative sample of the flue gas stream to be processed by the SGC&AC. A clam shell designed heating jacket, which surrounds the probe body, heats the sample probe.

A sample pump located in the SGC&AC, universal gas conditioning system, is used to draw in a continuous gas sample from the Extractive Probe Assembly via the HSL. The main function of the SGC&AC is to dry the sample gas by means of lowering the dew point of the gas sample, thus removing the moisture. Then, the dried gas sample is delivered to the O₂ and THC analyzers. The SGC&AC conditions the sample for analysis by the analyzers. This SGC&AC system can be divided into four basic sections: the gas sample drying section, dried sample distribution sections, the analysis section and auto-calibration/data collection. The first point of contact for the gas sample after being transported via the HSL is the pre-cooler. From here, the partially dried gas sample and the condensed moisture flow into the secondary Condensate Collector. Next, the gas sample flows on to the Sample Conditioner to have the remaining moisture removed. From the sample conditioner (Universal), the dried gas sample flows through the Instrument Plate, through a set of rotometers which control the flows and into the Analyzer Solenoid Plates (ASPs) via a distribution manifold. From the ASPs, the gas sample is valved again and then flows into the analyzers for measurement. Lastly, the gas sample is dumped into an exhaust manifold and vented.

The Heated Sample Line (HSL) is the device used to transport the gas sample from the Extraction Probe to the SGC&AC. The HSL will also maintain the gas sample temperature to ensure that the moisture in the gas sample does not condense within the HSL. The sample temperature is set between 250 °F to 300 °F. The HSL consists of the following items: one 240 VAC heating cable, three 1/4" Teflon tubes, one twisted pair cable to be used for the RTD signal from the probe RTD, one RTD to sense the temperature of the sample line, and three 14 American Wire Gauge (AWG) wires for the probe power.

The CEMS system (sample conditioning equipment, analyzers, and data collection equipment) is located in a separate building just south of Boiler No. 3. When a malfunction occurs with this system, an AWFCO will occur, a local alarm light inside the building will be displayed, and an audible alarm will sound in the Boiler control room area. The Boiler Operator stationed in the

area will acknowledge the alarm and determine the why a problem occurred. Maintenance personnel will then be dispatched to fix the problem. The following conditions will cause the alarms mentions above.

- Sample probe/sample line temperature low
- Moisture in sample
- Sample flow low
- Sample pump off
- Condensate trap level high
- Total Hydrocarbon analyzer flame out condition

The O2 analyzer is a stack gas analyzer. The O2 analyzer has the following characteristics:

Principle	Paramagnetic
Operation:	
Range:	0-25% O2
Response Time:	90% of full scale, 20 seconds
Repeatability:	0.01% O2 or $\pm 1\%$ of full scale, whichever is greater
Zero Drift:	$\pm 1\%$ full scale per day, ambient temperature does not change more than 20 degree F $\pm 2\%$ full scale per eek, ambient temperature change over entire range
Span Drift:	$\pm 1\%$ full scale per week

The THC analyzer is a standard stack gas analyzer and has the following characteristics:

Principle	Flame Ionization
Operation:	
Range:	Range switch has eight positions: 1, 2.5, 10, 25, 100, 250, 1000 and REMOTE. SPAN control provides continuously variable adjustment within a dynamic range of 1:4
Response Speed:	90% of full scale within 0.6 seconds with sample bypass flow at 3 liters/minutes
Repeatability:	1% of full scale for successive identical samples
Zero Drift:	$\pm 1\%$ of full scale per 24 hours
Span Drift:	$\pm 1\%$ of full scale per 24 hours

Raw data collected by the CEMS is delivered to the Odessa control unit and the DCS. The Odessa control unit also computes 60-minute rolling averages for each CEMS variable. The 60-minute rolling average is then delivered to the DCS and logged into the DAS. The Odessa control unit also initiates, through a timer, the daily calibration of the CEMS. This calibration is sequenced automatically.

1.3 Boiler Operator Training and Certification

All boiler operators receive initial training by completing the Utilities Operator Apprentice Program. This is a site-specific procedure based training program that has been reviewed and certified by the state Department of Labor. The training includes written materials, hands-on-labs, and on-the-job training. Once an apprentice operator has received training for a task or course and has completed that section of the Apprenticeship Program the operator is then allowed to do that task by their self.

A certified operator will instruct the apprentice until they have successfully completed the program and passed a written examination administered by the instructor. The completions are recorded in an on-site training management system called TEDS.

An annual review is administered to the operators and critical staff that include both Title V/MACT and RCRA updates along with pertinent operational training, including but not limited to the SSM plan. The Utilities Operator Apprentice Program, including the Boiler Operator Training, is reviewed and updated whenever changes have been made that could improve the training or make the existing training obsolete.

A certified control room operator will be on duty at the site when the boiler is operating.

2.0 Sampling and Analysis Program

This section summarizes the sampling and analysis programs conducted during the CPT.

2.1 Sampling Program

FFCC fed the following streams during the CPT:

1. Coal
2. Ash Spiking
3. Organic Waste
4. Metals Spiking Solution

The characteristics of the hazardous waste feed during the CPT are summarized in Table 5.0, and CPT spiking information is summarized in Table 6.0.

2.1.1 Waste Feed Preparation

Coal – Coal is the primary fuel used to produce steam at the coal-fired boilers. The coal is a high Btu fuel that contains no POHCs. Diatomaceous earth was spiked into the coal to maximize the ash feed rate during the CPT.

Organic Waste - The organic waste used in both Test 1 and Test 2 was prepared by using waste from FFCC's manufacturing units. Acetic Acid, chlorobenzene and perchloroethylene were transferred from manufacturing to a permitted waste tank at Utilities. The stream used in Test 1 was prepared as a 96% Acetic Acid, and 4% chlorobenzene solution. The purpose of the stream was to provide a low Btu waste feed that contained a primary organic hazardous constituent (POHC) to demonstrate DRE at low temperatures. The stream used in Test 2 was prepared as an 87% Acetic Acid, 4% chlorobenzene, and 6% perchloroethylene solution. The purpose of this stream was to provide a waste containing a POHC, as well as, chlorine to support the metals removal efficiency of the system with chlorine present.

Metals Spiking Solution – The metals spiking solution was prepared by Blue Ridge Chemicals, Inc. headquartered in Bala Cynwyd, Pennsylvania. This solution was prepared in order to establish MACT EEE feed limits for semi-volatile (cadmium and lead) and low-volatile (arsenic, beryllium, and chromium) metals. Lead was chosen to represent the semi-volatile metals and chromium was chosen to represent the low volatile metals. The solution was ordered to exact specifications and certified by Blue Ridge Chemicals as to its composition (certificate of analysis is located in Attachment E-1). The high volatile metal, mercury, was not spiked in to the feed

stream. Mercury is not expected to be in FFCC waste but is expected to be present in the coal feed.

2.1.2 Sampling and Monitoring Procedures

The CPT involved two different tests (Test 1 and Test 2) consisting of three replicate runs at the extreme range of normal conditions. Each test involved stack emission sampling for POHC destruction to ensure 99.99% DRE and to demonstrate compliance with THC emissions. Test 2 also involved stack sampling to ensure particulate matter, mercury, semi-volatile metal, and low-volatile metal emission standards. Waste feed and coal samples were obtained during each run of the CPT.

The procedures for collecting samples are summarized in Table 7.0. Sampling frequency and reference methods also are included in Table 7.0. Additional details regarding sampling frequencies and methods follow.

2.1.2.1 Solid Fuel Feed

2.1.2.1.1 Coal Samples

The coal feed was sampled at 30-minute intervals during each trial burn run under both test conditions. The original plan called for FFCC to sample the coal and diatomaceous earth as fed; however, the Agency directed us to modify the original sampling plan to obtain the coal samples prior to the addition of the diatomaceous earth. The coal samples were then taken from a sample point at the exit of the coal silo which is approximately 8 feet before the area where the ash (diatomaceous earth) was spiked into the coal.

2.1.2.1.2 Ash Spiking

The diatomaceous earth was added to the coal just before the bucket elevator takes the coal up the 100-ton coal bunker. The diatomaceous earth was added to the coal at a rate of 7.5 lbs of diatomaceous earth to every 100 lbs of coal. A summary of the ash spiking information can be found in Table 6.0 and the field spiking logs can be seen in Attachment E-3.

2.1.2.2 Organic Waste Feed

2.1.2.2.1 Volatile Organic Analysis Samples

The volatile organic analysis (VOA) samples were collected from a tap in the waste feed line prior to the metals solution injection point. Grab samples for the VOA were taken every 30 minutes, packaged separately in 40ml vials, and then placed in ice and cooled to 4 degrees C. These samples were composited by the laboratory immediately before analysis.

2.1.2.2.2 Organic Waste Samples

The organic waste samples were also collected from a tap in the waste feed line for analysis other than volatile organics. These grab samples were taken every 30 minutes and were composited into 4oz jars at the sampling sight in an ice cooled environment. The composites were maintained in an ice cooled environment and transported to the designated analytical laboratory for analysis.

2.1.2.3 Metals Spiking Solution

The metals spiking solution was not sampled as a separate waste stream. It was prepared off-site by a third party who certified the composition. Attachment E-1 contains a copy of that certification. The solution was fed to the liquid waste feed line upstream of the combustion chamber injection point, and downstream of where the hazardous waste samples were taken. The feed rate of the metals solution was controlled using a chemical metering pump and a scale. The feed rate was maintained by calculating the weight loss of the container holding the metals solution. The scale calibration documentation can be found in attachment E -2.

2.1.3 Combustion Gas

2.1.3.1 Combustion Gas Temperature

The combustion gas temperature was measured in the combustion chamber by thermocouple with an instrument range of 0 – 2200 degrees Fahrenheit. The exact location of the thermocouple can be seen in drawing 6M01-4V-016, and is described in drawing 6M01-9T-026.

2.1.3.2 Combustion Gas Monitoring

FFCC continuously monitors oxygen (O₂) and total hydrocarbon (THC) levels in the combustion stack gases. The continuous emission monitoring system (CEMS) presently utilized by FFCC is an extractive system. (The CEMS and other process instrumentation are summarized in Tables-3.0 and 4.0). This system was calibrated and a RATA was performed on the system just prior to the CPT. The results of the RATA can be reviewed in Attachment E-4.

The CEMS is divided into three parts: a sample probe (installed directly on the dedicated breech to a common stack); a sampling gas conditioning and analysis cabinet (SGC&AC); and a heated sample line (HSL) connecting these two parts. The probe/primary filter assembly is a sample extractive device, which is placed in direct contact with the flue gas environment. It is used to draw in and filter a representative sample of the flue gas stream to be processed by the SGC&AC. A clam shell designed heating jacket, which surrounds the probe body, heats the sample probe.

A sample pump located in the SGC&AC, universal gas conditioning system, is used to draw in a continuous gas sample from the Extractive Probe Assembly via a heated sample line (HSL). The main function of the SGC&AC is to dry the sample gas by means of lowering the dew point of the gas sample, thus removing the moisture. Then, the dried gas sample is delivered to the O₂ and THC analyzers. The SGC&AC conditions the sample for analysis by the analyzers. This SGC&AC system can be divided into four basic sections: the gas sample drying section, dried sample distribution sections, the analysis section and auto-calibration/data collection. The first point of contact for the gas sample after being transported via the HSL is the pre-cooler. From here, the partially dried gas sample and the condensed moisture flow into the secondary Condensate Collector. Next, the gas sample flows on to the Sample Conditioner to have the remaining moisture removed. From the sample conditioner (Universal), the dried gas sample flows through the Instrument Plate, through a set of rotometers which control the flows and into the Analyzer Solenoid Plates (ASPs) via a distribution manifold. From the ASPs, the gas sample then flows into the analyzers for measurement. Lastly, the gas sample is dumped into an exhaust manifold and vented.

The HSL transports the gas sample from the Extraction Probe to the SGC&AC. The HSL will also maintain the gas sample temperature to ensure that the moisture in the gas sample does not condense within the HSL. The sample temperature is set between 250 °F to 300 °F. The HSL consists of the following items: one 240 VAC heating cable, three 1/4" Teflon tubes, one twisted pair cable to be used for the RTD signal from the probe RTD, one RTD to sense the temperature of the sample line, and three 14 American Wire Gauge (AWG) wires for the probe power.

The CEMS system (sample conditioning equipment, analyzers, and data collection equipment) is located in a separate building just south of Boiler No. 3. When a malfunction occurs with this system, an AWFCO will occur, a local alarm light inside the building will be displayed, and an audible alarm will sound in the Boiler control room area. The Boiler Operator stationed in the area will acknowledge the alarm and determine the why a problem occurred. Maintenance personnel will then be dispatched to fix the problem. The following conditions will cause the alarms mentions above.

- Sample probe/sample line temperature low
- Moisture in sample
- Sample flow low
- Sample pump off
- Condensate trap level high
- Total Hydrocarbon analyzer flame out condition

The O2 analyzer is a stack gas analyzer. The O2 analyzer has the following characteristics:

Principle	Paramagnetic
Operation:	
Range:	0-25% O2
Response Time:	90% of full scale, 20 seconds
Repeatability:	0.01% O2 or ± 1% of full scale, whichever is greater
Zero Drift:	± 1% full scale per 24 hours, ambient temperature does not change more than 20 degree F± 2.5% full scale per 24 hours, ambient temperature change over entire range
Span Drift:	± 1% full scale per 24 hours ± 2.5% full scale per 24 hours

The THC analyzer is a standard stack gas analyzer and has the following characteristics:

Principle	Flame Ionization
Operation:	
Range:	Range switch has eight positions: 1, 2.5, 10, 25, 100, 250, 1000 and REMOTE. SPAN control provides continuously variable adjustment within a dynamic range of 1:4
Response Speed:	90% of full scale within 0.6 seconds with sample bypass flow at 3 liters/minutes
Repeatability:	1% of full scale for successive identical samples
Zero Drift:	± 1% of full scale per 24 hours
Span Drift:	± 1% of full scale per 24 hours

Raw data collected by the CEMS is delivered to the Odessa control unit and the DCS. The Odessa control unit also computes 60-minute rolling averages for each CEMS variable. The 60-minute rolling average is then delivered to the DCS and logged into the DAS. The Odessa control unit also initiates, through a timer, the daily calibration of the CEMS. This calibration is sequenced automatically.

2.1.4 Stack Gas

During the trial burn, combustion gases was diverted from the main stack and sampled from a “stub” stack especially designed to facilitate sampling of stack gases. The main stack cannot be used for sampling because the emissions from Boiler No. 3 cannot be differentiated from the other two identical coal fired boilers. The agency has approved use of the “stub” stack in all previous testing. The “stub” stack is constructed such that cyclonic flow is controlled.

2.1.4.1 Hydrogen Chloride and Chlorine Train (Method 26A)

FFCC demonstrated compliance with the alternative risk based standard for total chlorine by measuring the chlorine feed rate and using MTEC to determine stack emissions. The Alternative Risk Based Standard for Chlorine was provided in Appendix D of the FFCC CPT Plan.

2.1.4.2 Multi-Metals Train (Method 29)

An MMT (multi-metals train) (EPA Method 29) was used for collection of metals and particulate from the stack gas during the CPT. The sampling train impingers were be charged with a solution of 5 percent nitric acid and 10 percent hydrogen peroxide to capture metals (i.e., arsenic, beryllium, cadmium, chromium, lead, and mercury) and acidified potassium permanganate (composed of 4 percent potassium permanganate and 10 percent sulfuric acid) to capture any mercury that will not be captured by the nitric acid and hydrogen peroxide solution. The total sampling time was about 2 hours during each replicate sampling run. The MMT was operated concurrently with the other sampling train(s) and sampled approximately 3 cubic meters of stack gas. The MMT procedure included measurement of the stack gas flow rate and temperature according to EPA Methods 1 and 2. Total hydrocarbon and oxygen determinations were made by the FFCC CEMS and Method 3A. Stack gas moisture was sampled in accordance with EPA Method 4.

2.1.4.3 Volatile Organic Sampling Train (Method 0030)

A volatile organic sampling train (VOST) was used during the CPT to collect the POHC chlorobenzene from the stack gas on sorbent resin. The VOST was configured in accordance with SW-846 Method 0030 with two Tenax® resin tubes and one Anasorb® tube in series. Because the VOST was a non-isokinetic sampling train, it could share a sampling port with any of the isokinetic sampling trains with no impact to the operation of either sampling train. The VOST was operated concurrently with the other sampling trains to collect a total of four sets of VOST cartridges for each test run. Three sets were targeted for analysis. The fourth set served as a backup in the event of tube hreakage or damage during sbipment and laboratory handling. About 20 liters of stack gas were sampled per set of VOST cartridges at 0.5 liters per minute for 40 minutes (slow-VOST conditions). The VOST cartridges were capped immediately upon removal from the train, wrapped in aluminum foil, placed in glass tubes, and sealed. The Method 26A stack parameter measurements were used for the VOST calculations.

2.1.4.4 Dioxin/Furan Sampling Train (Method 23A)

FFCC demonstrated compliance with the dioxin and furan standard through the use of data "in lieu of" testing. The data used by FFCC and documentation of its quality was provided in Appendix F of the FFCC CPT Plan.

2.2 Analytical Program

Maxxam Analytics, Inc. is located in Mississauga, Ontario. This laboratory was used to perform the analytical testing on both the process feed samples and the stack gas samples collected during the CPT.

2.2.1 Analytical Methods

Analytical methods and procedures are summarized in Table 21.0. Detailed analytical methods and procedures can be found in Attachment A. Quality Assurance evaluation of methods used are discussed in section 4.0.

2.2.2 Analytical Results

A summary of analytical results are located in Table 5.0 and complete analytical reports can be seen in Attachment A.

3.0 Description of the Test Program

This section summarizes the comprehensive performance test. The CPT plan contains the detailed plans of the test that was conducted June 2 – 4, 2010. The Executive Summary in this NOC discusses those deviations from the plan that were necessary to address unexpected conditions.

3.1 CPT Objectives

The overall objective of this Comprehensive Performance Test is to demonstrate that the boilers are capable of meeting the emission standards for solid fuel-fired boilers that burn hazardous waste as established in the MACT Combustion Rule (40 CFR 63 Subpart EEE) and to establish operating conditions and parameters that are equivalent with that demonstration.

The specific objectives for the FFCC comprehensive performance test are listed below. Each emissions parameter was reported with concentration corrected to 7% Oxygen.

- Demonstrate 99.99 percent DRE of the designated POHC (chlorobenzene).
- Demonstrate control of particulate emissions to less than or equal to 68 milligram/dry standard cubic meter (mg/dscm) at maximum ash feed rates.
- Demonstrate that hydrogen chloride/chlorine emissions are less than or equal to than the health-based compliance alternative established in FFCC's eligibility demonstration.
- Demonstrate that mercury emissions are less than or equal to 11 micrograms per dry standard cubic meter (ug/dscm).
- Demonstrate that semi-volatile metal (cadmium and lead) emissions are less than or equal to 180 micrograms per dry standard cubic meter (ug/dscm) at maximum semi-volatile metal feed rates.
- Demonstrate that low-volatile metal (arsenic, beryllium, and chromium) emissions are less than or equal to 380 micrograms per dry standard cubic meter (ug/dscm) at maximum low-volatile metal feed rates.
- Demonstrate that total hydrocarbon emissions are less than 10 ppmv (dry) on an hourly rolling average basis.

- Meet THC limits to demonstrate that dioxin/furan emissions are less than or equal to 0.20 nanograms total equivalent quotient per dry standard cubic meter (ng TEQ/dscm).
- Gather data regarding waste feed characteristics and process operating conditions to be used to develop operational permit limits that will ensure compliance with regulatory performance standard.

3.2 CPT Approach

The proposed CPT is based upon 40 CFR 63 Subpart EEE. 40 CFR 63.1207 establishes the requirements for conducting a comprehensive performance test. The universal approach establishes one set of permit conditions or limits applicable to all modes of operation. This approach, as proposed in the following section, will allow FFCC to treat the complete variety of hazardous wastes produced by the FFCC facility under one well-defined set of operating limits.

3.2.1 POHC Selection

FFCC has based its selection of POHC on two primary factors: (1) the University of Dayton thermal stability ranking, and (2) the composition of the actual wastes to be burned. Consistent with these factors, FFCC used the following criteria to select the POHC for this CPT:

- The POHC should be present as an Appendix VIII constituent in the actual wastes to the maximum extent practicable,
- The POHC should be considered an organic hazardous air pollutant under 42 U.S.C. 7412(b)(1), and
- The POHC should have a high ranking on the University of Dayton thermal stability-ranking list.

The constituents and hazardous air pollutants identified at 42 U.S.C. 7412(b)(1) that are likely to be found in FFCC's liquid waste based on testing and process knowledge are listed in Table-2.0 along with the historical ranges of these feed streams. Many of these compounds are included on the University of Dayton thermal stability ranking including acetonitrile, benzene, chlorobenzene, and toluene. Chlorobenzene was selected as the POHC because it is a Class I compound, it is typically present in greater quantities in the waste than the other Class I compounds, and it is readily available.

3.3 CPT Program

The CPT program consisted of one test of six runs. Three of the runs are identified as Test 1 and three of the runs are identified as Test 2. The target operating conditions from both tests were designed to establish operating limits for the boiler that would ensure all MACT combustion standards were met for one hazardous waste operating mode. Pursuant to Alternative Monitoring Request No. 1, all testing was done on Boiler No. 3 with data from this test to be used in lieu of testing Boilers Nos. 1 and 2 (as previously approved via letter from U.S. EPA Region 6 dated July 2, 1992). Boiler 3 was chosen because it affords better accessibility to the unit by the stack testing contractor. Alternative Monitoring Request No. 1 was provided as Appendix A of the FFCC CPT Plan.

3.3.1 Comprehensive Performance Test 1

The Test 1 operating conditions were designed to demonstrate worst case conditions for POHC destruction at the lower range of normal by testing the boiler's performance under minimum combustion chamber temperatures. The liquid hazardous waste feed was not maximized in order to keep operating temperatures less than typical operations. Specifically, liquid hazardous waste feed rates were not maximized during the low temperature test conditions (as opposed the approach typically used in incinerator performance tests) because the boilers can not operate at reduced temperatures when the waste feed rate is maximized. The operating temperature of the boiler is in direct relationship with the BTU input of the fuel. In addition, liquid hazardous waste feed rate cannot be maximized while the feed rate of coal is minimized because this condition would compromise the Bevill requirement to burn at least 50 percent coal when burning hazardous waste.

The Test 1 waste was a blend of acetic acid spiked with chlorobenzene (4 – 5 % of hazardous waste feed.) The justification for this waste feed selection has already been presented.

The following operating conditions were established during Test 1:

- Minimum Furnace Temperature
- Maximum % O₂

3.3.2 Comprehensive Performance Test 2

Test 2 is designed to establish permit conditions for minimum residence time which occurs at maximum feed and flue gas flow rates. DRE was measured to demonstrate that DRE is not affected at combustion gas residence times that are less than those demonstrated in Test 1 (i.e. the stack gas flowrate will be greater due to higher temperatures, thus leading to shorter residence times in the combustion chamber). Test 2 was also used to demonstrate compliance with the MACT EEE standards for solid-fuel fired boilers except low combustion chamber temperature.

The following operating conditions were demonstrated during Test 2:

- Maximum metals feed rates
- Maximum chlorine feed rates (as an operating parameter limit for SVM)
- Maximum liquid waste feed rates
- Maximum ash feed rate
- Maximum ESP inlet temperature
- Minimum Power to the ESP
- Maximum combustion air flow rate

Test 2 represented worst-case conditions for metals removal efficiency. FFCC will maximize the liquid hazardous waste feed rate during Test 2 in order to maximize steam production, which maximizes combustion chamber temperature and flue gas flow rate. The waste used during the minimum residence time test was a solution (i.e., acetic acid, methanol, or other solvent) spiked with chlorobenzene (4% of total waste feed) and perchloroethylene (6% of total waste feed). The justification for this waste feed selection has already been presented.

3.4 CPT Sampling and Analytical Program

The CPT sampling and analysis program is summarized in Table 21.0 and can be seen in the Alliance Source Testing Report found in Attachment A. The structure of this CPT was based on the previously stated objectives.

The stack was sampled during the CPT as follows:

- The volatile POHC chlorobenzene was sampled using the VOST train (SW-846 Method 0030).
- Metals using multi-metals train (40 CFR Part 60, EPA Method 29).
- Particulate matter using Method 5 procedures in conjunction with the multi-metals train (40 CFR Part 60, Method 0029)
- Total Hydrocarbon (THC) testing using in-house CEM (40 CFR Part 60, Method 25A).
- Total Oxygen (O₂) testing using in-house CEM and Contractor Method 3A)

In addition to stack sampling, the feed materials (coal and liquid wastes) were sampled and analyzed for a number of physical and chemical parameters.

4.0 Comparison of Actual Test Conditions versus Planned Conditions and Independent QA Review

A comparison of the actual test conditions experienced during the CPT with the planned (target) test conditions documented in the CPT plan is provided below. Tables 8 through 15 provide a summary of the various operating parameter data with respect to the target conditions for each run. A detailed discussion of the operating parameter limits and the run-by-run data can be found in Section 6.0 of this report.

Comparisons were made on three sets of parameters:

- Combustion Device Parameters
- Feed Rate Parameters
- Constituent Feed Rate Parameters
- Stack Gas Parameters

4.1 Combustion Device Parameters

These parameters were used to establish limits for ensuring proper combustion and pollution control device operation. They include:

- Combustion chamber temperature – In general, the average combustion chamber temperature exceeded the target by approximately 10 °F.
- Combustion Air Flow Rate – The combustion air flow rate is a fairly new parameter. The flue gas flow rate was measured at the stack was consistent with the correlation equation discussed in Attachment E-5.
- ESP Power – The average kW of the ESP was in line with the target value of 8 kW. Just prior to Test 2, the CPT manager revised the original target from 7 kW to 8 kW.
- ESP Inlet Temperature – The average temperature to the inlet of the dry pollution control device was in line with the target temperature.
- Percent O₂ – The Percent O₂ measured in the stack was in line with expectations.
- Total Hydrocarbons – The THC concentration was in line with expectations.

- Atomization Pressure - The atomization pressure limit of 30 psig is based on manufacturer's recommendations.

4.2 Feed Rate Parameters

These parameters were used to establish constituent and POHC feed rates. They include:

- Total Waste Feed Rate – The waste feed rate during the CPT was in line with the target value.
- Total Coal Feed Rate – The coal feed rate is based on steam demand and waste feed characteristics. The process control logic determines how much coal is needed to make the steam production rate. The system did not need as much coal as estimated to meet the steam demand during the high temperature portion of the test.

4.3 Constituent Feed Rate Parameters

These parameters were calculated from the fuel feed rate parameters and the constituent concentrations in the fuel feed for the CPT Test. They include:

- Total Chloride Feed Rate – In general, the total chloride feed rate was 17% lower than the target value.
- Total Ash Feed Rate – In general, the total ash feed rate was 12% lower than the target value.
- Total Mercury Feed Rate – Mercury was not detected in the waste feed. The mercury in the coal was well below the normal concentration seen in coal.
- Total Semi-Volatile Metal Feed Rate – In general, the total SVM feed rate was in line with target value.
- Total Low-Volatile Metal Feed Rate – In general, the LVM feed rate was in line with the target value.

4.4 Stack Gas Parameters

These parameters were monitored by a continuous emission monitor. They include:

- Total Hydrocarbon Concentration – Emissions were well below the standard as expected.
- Oxygen Concentration – Oxygen concentrations were consistent with expectations.

4.5 Independent QA Review

Mr. David A. Weeks, P.E., BCEE, CIH (Risk Management and Engineering, Ltd.) provided independent oversight of the CPT and conducted an independent review of the quality assurance and quality control (QA/QC) performed by the stack testing company and laboratories during the test.

4.5.1 Stack Testing Equipment

Mr. Weeks was present during the entire CPT and inspected the stack sampling calibration records including the dry gas meter calibration records, pitot tube calibration records, and temperature indicator calibration records at the time of the test. Mr. Weeks observed the leak checks of the sampling equipment during the tests and found them to be in good order. The post calibration records were in order and showed that the stack gas sampling equipment functioned properly and provided data that were in accordance with the U.S. EPA methods used to collect the data.

4.5.2 Stack Gas - Particulate Analysis

Mr. Weeks conducted an independent review of the analytical data. The balance calibration data is summarized on page 339 of Attachment A. The results showed no deviation at a standard weight of 0.0000 grams, and deviations ranging from 0 to 0.0002 grams at a standard weight of 3.000 gram. The maximum deviation is less than 0.5 mg. Mr. Weeks' independent review of the data confirms the results reported by Alliance in their report.

4.5.3 Stack Gas - Metals Analysis

Mr. Weeks conducted an independent review of the analytical data. The stack sampling contractor's QA/QC summary is contained on pages 14 and 15 of Attachment A. The laboratory QC data is contained on pages 319 – 323 of Appendix C. The matrix spike and matrix spike duplicate recoveries were within the 70 – 130 % accuracy objective as defined in the QAPP. Matrix spikes were performed for mercury with recoveries that ranged from 93 to 103%, showing that metals were not lost during the digestion process. The recoveries for semi- and low-volatile metals ranged from 95 to 106%. The RPD between the matrix spike and matrix spike duplicate analyses were less than the 25% objective established in the QAPP, with results ranging between 0.3 to 3% RPD for all metals. Thus, laboratory analyses were not biased high or low. Mr. Weeks' independent review of the data confirms the results reported by Alliance.

4.5.4 Stack Gas - Volatile Organics Analysis

Mr. Weeks conducted an independent review of the analytical data. The laboratory's QC discussion is contained on pages 72 and 73 of Attachment A, the surrogate spike recoveries are reported with the analytical results on pages 63 - 65. Alliance reported, and Mr. Weeks confirmed by inspection of the laboratory data sheets, that surrogate recoveries ranged from 81 to 110 percent as compared to the target objective of 50 - 150%. The surrogate recovery for the spiked blanks and method blanks 99 to 102%. The RSD for the recoveries of the surrogate toluene-d8 ranged from 4 to 13 % as compared to the QAPP target of less than 35% RSD. Mr. Weeks' independent review of the data confirms the results reported by Alliance.

4.5.5 Stack Gas - Continuous Emissions Monitoring Data

Mr. Weeks conducted an independent review of the calibration data for continuous emissions monitoring (CEM) data contained in the Alliance report. The Alliance data was used to measure the oxygen and carbon monoxide concentration in the stack gas for the purpose of emission calculations. The calibration data is contained on pages 638 to 643. All of the calibration measurements for the oxygen analyzer were less than 2% of the span value, which is consistent with the calibration requirements contained in Section 13 of Method 3.

Mr. Weeks conducted an independent review of the calibration data for continuous emissions monitoring (CEM) data for the FFCC CEMs. The FFCC data was used to measure the oxygen and THC concentration in the stack gas for the purpose of THC emission calculations. For the FFCC THC analyzer, the mean difference between the CEMS and reference values for the daily calibrations ranged between 0.1 and 0.6 ppm for all runs, which is less than the 5 ppm requirement of Performance Specification 8A. The O2 daily calibrations reported a difference that ranged from 0.1 to 0.3 ppm for all runs, which is less than 2% of the span value, which is consistent with the calibration requirements contained in Section 13 of Method 3. The problem which resulted in a status of "out of control" on June 3 was corrected before the CPT runs were started.

The data from the April 14, 2010 RATA was also reviewed. The RATA data showed that the THC CEMs demonstrated a 3% difference between the reference method data and the FFCC CEMs, which is within the performance criterion of $\leq 10\%$. The O2 CEMs demonstrated a 0.1% difference, which is less than the performance criterion of $\pm 1\%$.

4.5.6 Waste-Volatile Organics

The QAPP does not identify specific QA/QC objectives for the wastes and spiking materials. However, the laboratory reported the results of the QC measurements collected during the analysis of these samples. Mr. Weeks reviewed this data in order to ensure the overall quality of the project. The laboratory's QC report for the waste analysis is contained on page 586 of

Attachment A. The spiked blank recovery for the organic waste was 108 %. This is consistent with standard QC limits of 70 – 130%.

Finally, the laboratory reported that it did not analyze the waste feed samples for volatile organics within the 14-day holding time because of the need to dilute the samples. As a result, it might be argued that the volatile organic analytical results for the waste feed samples are biased low. If this is the case, the DRE calculations presented in this CPT report are more conservative than actually reported because a lower mass of POHC into the combustion system biases the DRE calculation on the low side. Hence, the DRE values provided in the report may be greater than was reported.

4.5.7 Feed-Metals and Chloride

The QAPP does not identify specific QA/QC objectives for the wastes and spiking materials. However, the laboratory reported the results of the QC measurements collected during the analysis of these samples. Mr. Weeks reviewed this data in order to ensure the overall quality of the project data. The laboratory's QC discussion for semi- and low-volatile metals is contained on page 586; and page 593 provides the quality assurance discussion related to chloride and mercury.

The matrix spike recovery for semi- and low-volatile metals in the waste samples ranged between 102 to 108%; and the laboratory's QC standard recoveries ranged between 79 and 92%. Both QC measurements are consistent with the laboratory's recovery limits of 80 – 120. The mercury recoveries were 79 and 92% for the QC standard and the QC standard duplicate. The RPD between the standard and its duplicate was 15.4% compared to the laboratory criteria of 35%. The chloride QC standard recovery was 95% compared to the laboratory performance criterion of 90 – 100%, and the spiked blank recovery was 100% compared to the laboratory performance criterion of 80 – 120%.

Thus, the waste feed analytical results are not biased either high or low for metals and chloride.

4.5.8 Feed – General Chemistry

The analysis of certain process parameters such as heating value and ash do not have any specific QC requirements. Field duplicate samples were collected in order to evaluate the quality associated with this data. For higher heating value, the difference between the sample and its duplicate ranged between 0.02 and 0.3% for both the waste and coal. For ash content, the difference between the sample and its duplicate for coal was 4.9%. For the waste, the difference was found to be 50% (0.04% ash compared to 0.02% ash). However, the total ash content of the waste was very low (0.01 to 0.04% ash for all samples in all runs). Because the ash content of the waste is very low, the percent difference value of 50% does not materially affect the overall conclusions of this report.

4.5.9 Analytical Method Deviations

A review of the analytical reports provided in Attachment A revealed that the laboratory used methods that were equivalent to those identified in the CPT Plan, but were different in name. A summary of the differences and impacts follows.

CPT PLAN METHOD	METHOD USED	DISCUSSION OF IMPACTS
S.G. of Waste: ASTM D-891 or other approved method	ASTM D-1298	None; the two methods provide similar data.
Ash Content of Coal: ASTM D-482 or other approved method	ASTM D-3174	None; the method used by the laboratory is more appropriate for the matrix that was analyzed.
Chlorine Content of Waste and Coal: SW-846 9076 or other approved method	ASTM E776 / SW-846 9056	None; the two methods provide similar data.
Heat Content of Coal: ASTM-D-240 or other approved method	ASTM D-5865	None; the method used by the laboratory is more appropriate for the matrix that was analyzed.
LVM and SVM Concentration in Waste: ICP-AES (Method 200.7 or 200.8)	SW-846 6020	None; the two methods provide similar data.
LVM and SVM Concentration in Coal: ICP-AES (Method 200.7 or 200.8)	SW-846 6010B	None; the two methods provide similar data.
Mercury Concentration in Waste and Coal: EPA Method SW-7470A	ASTM D-3684-01	None; the two methods use the same technique and provide similar data.
Stack Gas Metals: SW-846 6010b and 7470a	SW-846 6020 and 7470a	None; the two methods provide similar data.

Specific Gravity of Waste

The two test methods are ASTM D891 - 09 Standard Test Methods for Specific Gravity, Apparent, of Liquid Industrial Chemicals; and ASTM D1298 - 99(2005) Standard Test Method for Density, Relative Density (Specific Gravity), or API Gravity of Crude Petroleum and Liquid Petroleum Products by Hydrometer Method. The two methods provide similar data for liquid substances in an organic matrix. No significant difference in results is expected between the two methods.

Ash Content of Coal

The two test methods are ASTM D482 - 07 Standard Test Method for Ash from Petroleum Products; and ASTM D3174 - 04 Standard Test Method for Ash in the Analysis Sample of Coal and Coke from Coal. The method used by the laboratory is more appropriate for the sample matrix that was analyzed, which is coal.

Chlorine Content of Waste and Coal

The CPT Plan specified SW-846 Method 9076 - Test Method for Total Chlorine in New and Used Petroleum Products by Oxidative Combustion and Microcoulometry. The laboratory used ASTM E776 - 87(2009) Standard Test Method for Forms of Chlorine in Refuse-Derived Fuel, followed by SW-846 Method 9056A - Determination of Inorganic Anions by Ion Chromatography. The ASTM method is essentially an extraction method. The two analytical methods are essentially equivalent. This issue is not substantive because SW-846 Method 9057 is also an EPA approved method.

EPA SW-846 Method 9057 describes the use of liquid anion chromatography to separate the chloride anions from the sample matrix. The chloride ions are then detected by a conductivity detector that uses coulometry to measure the flow of electrons between two electrodes.

EPA SW-846 Method 9076 describes a process in which the material is heated, and the resulting gas is reacted with silver cations to form silver chloride. The chloride ions are determined quantitatively by the use of coulometry based on the stoichiometry of the reaction and the flow of silver cations that is detected by the electrodes. The detection method is the essentially the same between the two methods; it is the separation mechanism that is different.

SW-846 Method 9057 has a within-laboratory relative standard deviation of 6.2 percent and 3.2 percent at HCl concentrations of 3.9 and 15.3 ppm, respectively. Similar statistics are not provided for Method 9076, but the statistics that are provided in SW-846 state that the method is biased low by up to 9% for relatively low concentrations, reproducibility in the range of 1,400 ppm, and repeatability in the range of 400 ppm for higher concentrations. It is the conclusion of the independent QA reviewer that the two methods provide equal performance for chloride concentrations that are in the range of 50,000 ppm; such as this case.

Heat Content of Coal

The CPT Plan specified the use of ASTM D240 - 09 Standard Test Method for Heat of Combustion of Liquid Hydrocarbon Fuels by Bomb Calorimeter, whereas the laboratory used ASTM D5865 - 10a Standard Test Method for Gross Calorific Value of Coal and Coke. The method used by the laboratory is more appropriate for analysis of coal than the method specified in the Plan.

LVM and SVM Concentration in Waste and Coal

The CPT Plan specified either EPA Method 200.7-Determination of Metals and Trace Elements in Water and Wastes by Inductively Coupled Plasma-Atomic Spectrometry, or EPA Method 200.8-Determination of Trace Elements in Waters and Wastes by ICP-MS.

The laboratory used SW-846 6010C-Inductively Coupled Plasma-Atomic Emission Spectrometry for the coal, and SW-846 6020A- Inductively Coupled Plasma-Mass Spectrometry for the waste. EPA Method 200.7 is essentially equivalent to SW-846 Method 6010 except that EPA Method 200.7 is more commonly used for aqueous materials (although it can also be used for waste materials.) EPA Method 200.8 is essentially equivalent to SW-846 Method 6020 although is more commonly used for aqueous materials. All of these methods provide equivalent results for metals in the range of concentrations that are indicative of the waste and coal.

Mercury Concentration in Waste and Coal

The CPT Plan specified EPA Method SW-846 Method 7470A - Mercury in Liquid Waste (Manual Cold-Vapor Atomic Absorption Technique) whereas the laboratory used ASTM D3684 - 01(2006) Standard Test Method for Total Mercury in Coal by the Oxygen Bomb Combustion/Atomic Absorption Method. Both methods are essentially equivalent because they both use cold vapor atomic absorption for the analysis.

Stack Gas Metals

The CPT Plan specified SW-846 6010C-Inductively Coupled Plasma-Atomic Emission Spectrometry whereas the laboratory used SW-846 6020A- Inductively Coupled Plasma-Mass Spectrometry. SW-846 Method 6020 has lower detection limits. However, detection limits were not an issue for this project and since Method 6020 has lower detection limits, it provides equivalent data to the specified method.

4.5.10 Conclusion

The Independent QA Review determined that the sampling and analysis was completed in accordance with the data quality objectives established for the project. Mr. Weeks opined that the data is of sufficient quality to demonstrate compliance with the standards and develop operating parameter limits.

5.0 Comparison of Test Results with Regulatory Compliance Limits

This section compares the test results of the CPT, conducted June 1 - 4, 2010, with regulatory compliance limits established by the MACT Combustion Rule for Solid Fuel-Fired boilers. Table 16.0 demonstrates that FFCC hazardous waste boiler is in full compliance with the emission standards of 40 CFR 63, Subpart EEE.

5.1 Regulatory Requirements for the CPT

The regulatory requirements to discuss from the CPT are:

- Destruction Removal Efficiency (DRE)
- Particulate Emissions
- HCl / Cl₂ Emissions
- Mercury Emissions
- Semi-Volatile Metals Emissions
- Low-Volatile Metals Emissions
- Dioxin/Furan Emissions
- Total Hydrocarbon Emissions

5.1.1 Destruction Removal Efficiency

40 CFR 63.1216(c) requires solid fuel boilers to achieve a destruction removal efficiency (DRE) of 99.99% during the CPT for each principal organic hazardous constituent (POHC) designated in the waste feed. FFCC was able to make this demonstration during the CPT. The average DRE measured during Test 1 was >99.9991%. The average DRE measured during Test 2 was >99.9995%.

5.1.2 Particulate Emissions

40 CFR 63.1216(a)(7) requires existing solid fuel boilers to not emit particulate matter in excess of 68 mg/dscm after correction to a stack gas concentration of 7% oxygen. FFCC's boiler emitted an average of 26.2 mg/dscm at 7% oxygen during Test 2.

5.1.3 HCl / Cl₂ Emissions

The hydrogen chloride/chlorine feed rate during the CPT was less than the health-based compliance alternative feed rate limit for total chlorine developed under the procedures prescribed in 40 CFR 63.1215. Appendix F of the CPT Plan calculates the HCl/Cl₂ alternative feed rate limit as 1886.8 lb/hr. An average feed rate equivalent to 508 lb/hr HCl was demonstrated during the CPT.

5.1.4 Mercury Emissions

40 CFR 63.1216 (a)(2) requires existing solid fuel boilers to not emit mercury in excess of 11 micrograms per dry standard cubic meter (ug/dscm) after correction to a stack gas concentration of 7% oxygen. The average mercury emission during the CPT was 3.9 ug/dscm at 7% oxygen.

5.1.5 Semi-Volatile Metals Emissions

40 CFR 63.1216(a)(3) requires existing solid fuel boilers to not emit semi-volatile metals in excess of 180 micrograms per dry standard cubic meter (ug/dscm) after correction to a stack gas concentration of 7% oxygen. FFCC's boiler emitted an average of 158.8 ug/dscm at 7% oxygen during the CPT.

5.1.6 Low-Volatile Metals Emissions

40 CFR 63.1203(a)(4) requires existing solid fuel boilers to not emit low-volatile metals in excess of 380 micrograms per dry standard cubic meter (ug/dscm) after correction to a stack gas concentration of 7% oxygen. FFCC's boiler emitted an average of 117.3 ug/dscm at 7% oxygen during the CPT.

5.1.7 Dioxin/Furan Emissions

40 CFR 63.1216(a)(1)(ii) requires existing solid fuel boilers to not emit total hydrocarbons (THC) in excess of 10 parts per million by volume (ppmv) after correction to a stack gas concentration of 7% oxygen. FFCC's boiler emitted an average 0.4 ppmv at 7% oxygen during the Test 1 of the CPT, and emitted an average 0.3 ppmv at 7% oxygen during the Test 2 of the CPT. FFCC submitted data in lieu of Dioxin/Furan testing in Appendix F of the CPT Plan. This data in lieu of was obtained from a 1999 test where Dioxin/Furan emissions from FFCC boilers were 0.092 ng TEQ/dscm at 7% oxygen.

5.1.8 Total Hydrocarbon Emissions

40 CFR 63.1216(a)(5)(ii) requires existing solid fuel boilers to not emit total hydrocarbons (THC) in excess of 10 parts per million by volume (ppmv) after correction to a stack gas concentration of 7% oxygen. FFCC's boiler emitted an average 0.4 ppmv at 7% oxygen during the Test 1 of the CPT, and emitted an average 0.3 ppmv at 7% oxygen during the Test 2 of the CPT.

6.0 Procedures and Limitations for Operating Parameters

This section describes the operating parameter limits (OPL) and how they were established. This section also describes waste, chloride, ash and metal feed rate limits and how they are determined, including extrapolation.

6.1 Waste Feed Rate Limitations

The waste feed rate limits are summarized in Table 18.0. All feed rate limits are 12-hour HRAs. Tables 8 - 15 summarize the waste feed rate data by run. The process data upon which Tables 8 - 15 are based can be found in Attachment E-5.

6.1.1 Maximum Hazardous Waste Feed Rate Limit

FFCC established a maximum hazardous waste feed rate limit based on the average of the test run averages from Test 2.

6.1.2 Maximum Chloride Feed Rate Limit

The maximum chloride feed rate limit for LVM and SVM control was determined as average of the test run averages from Test 2. The concentration of chloride in both the waste and coal were used to determine the limit.

6.1.3 Maximum Ash Feed Rate Limit

The maximum ash feed rate limit was determined as average of the test run averages from Test 2. The amount of ash spiked (diatomaceous earth) and the ash content of the coal and waste was used to determine the limit.

6.1.4 Metals Feed Rate Limits

Metals feed rate limits were also determined during the CPT. A combination of methods was used to develop the metal feed rate limits. The final feed rate limits determined from the CPT are summarized in Table 18.0.

6.1.4.1 Maximum Mercury Feed Rate

The maximum mercury feed rate limit is based on the maximum theoretical emission concentration (MTEC). MTEC was chosen to develop this feed rate limit because mercury was not spiked into the system, and the concentration of mercury in the coal was significantly lower than anticipated based on historical analysis.

To develop the MTEC feed rate limit, FFCC used the combustion air correlation curve to determine the stack gas flow rate at the maximum combustion air flow rate demonstrated during the CPT. The MACT EEE mercury emission standard was used to calculate the maximum mercury feed rate limit. FFCC used only 90% of the feed rate calculated using MTEC in order to establish the maximum feed rate limit. This calculation is shown in Table 20.0.

6.1.4.2 Maximum Semi-Volatile Metals Feed Rate

The maximum SVM feed rate limit was determined using the average of the test run averages from Test 2. The amount of SVM spiked and the SVM content of the coal and waste was used to determine the limit. The limit was further extrapolated as described in Section 6.2.3.4 and shown in Table 19.0.

6.1.4.3 Maximum Low Volatile Metals Feed Rate

The maximum LVM feed rate limit was determined using the average of the test run averages from Test 2. The amount of LVM spiked and the LVM content of the coal and waste was used to determine the limit. The limit was further extrapolated as described in Section 6.2.3.4 and shown in Table 19.0.

6.1.4.4 Metals Feed Rate Extrapolation

FFCC used the analytical results from the process feed analysis to extrapolate up to higher metal feed rate limits. The extrapolation was minimized by using only 90% of the MACT Standard.

The extrapolation was done by a simple algebraic calculation:

$$\frac{\text{Metal feed - CPT}}{\text{Emission level - CPT}} = \frac{\text{Metal feed - Permit}}{\text{MACT Standard}}$$

- Metal feed – CPT refers to the metals feed rate derived from Table 9.0.

- Emission level – CPT: Refers to the average measured concentration, in ug/dscm corrected to 7% oxygen, of the metals from the three corresponding stack test runs of Test 2. This can be found in Table 16.0.
- Metal feed – Permit: This will be the calculated feed limit for the metals.
- MACT Standard: These are 180 ug/dscm for LVM and 380 ug/dscm for SVM at 7% oxygen.

The extrapolated metal feed rate calculations are shown below:

$$\text{SVM feed rate (lb/hr)} = [(0.633 \text{ lb/hr SVM}) \times (180 \text{ ug/dscm SVM}) \times (0.90)] / [158.8 \text{ ug/dscm}]$$

$$\text{Maximum SVM feed rate (lb/hr)} = \underline{0.65 \text{ lb/hr}}$$

$$\text{LVM feed rate (lb/hr)} = [(1.58 \text{ lb/hr LVM}) \times (380 \text{ ug/dscm LVM}) \times (0.90)] / [117.3 \text{ ug/dscm LVM}]$$

$$\text{Maximum LVM feed rate (lb/hr)} = \underline{4.61 \text{ lb/hr}}$$

6.2 Combustion Chamber Limitations

The operating parameter limits are summarized in Table 18.0. Tables 8 - 15 summarizes the OPL data by run. The limits are calculated as the average of the test run average measurements collected from each of the process monitoring instruments. The limits were established as either maximums or minimums depending on the parameter. The minimum temperature limit and maximum percent O₂ was established from the Test 1 data. All other combustion chamber limits were established from the Test 2 data. The process data from each run are provided in Attachment E-5.

6.2.1 Minimum Combustion Chamber Temperature Limit

FFCC established a minimum combustion chamber temperature of 1,061 deg F. during the CPT while demonstrating satisfactory DRE. The minimum combustion chamber temperature was established as the average of the test run averages from Test 1.

6.2.2 Minimum Atomization Pressure Limit

The minimum atomization pressure is based on the manufacturer's specification of 30 psig as an instantaneous limit for the liquid hazardous waste feed system.

6.2.3 Maximum Furnace Pressure Limit

The boiler system is an induced draft system that operates under a constant negative pressure. A limit of 0 psig will be established and will be monitored on an instantaneous basis.

6.2.4 Maximum Combustion Air Flow Rate Limit

A maximum combustion air flow rate of 21,130 scfm was established during Test 2. This limit was an average of the test run average total combustion air flow measured during the three runs of Test 2. It will be established as an hourly rolling average limit.

6.3 Air Pollution Control Limitations

The operating parameter limits are summarized in Table 18.0. Tables 8 - 15 summarize the OPL data by run. The limits are calculated as the average of the test run average measurements collected from each of the process monitoring instruments during Test 2. The limits were established as either maximums or minimums depending on the parameter. The process data from each run are provided in Attachment E-5.

6.3.1 Minimum ESP Power Limit

FFCC established a minimum electrostatic precipitator (ESP) power limit of 8 kilowatts (kW). This limit was established as the average of the test run averages recorded during Test 2. This limit will be monitored as an hourly rolling average limit.

6.3.2 Maximum Inlet Temperature to the ESP

FFCC established a maximum inlet temperature to the ESP of 515 deg F. This limit was established as the average of the test run averages recorded during Test 2. This limit will be monitored as an hourly rolling average limit.

6.4 Stack Gas Limitations

The only stack gas measurement data from which an OPL is derived is oxygen. (The THC OPL is a regulatory standard.) The stack gas OPL limits are summarized in Table 18.0. Tables 8 - 15 summarizes the OPL data by run. For O₂, the limits are calculated as the average of the test run average measurements during Test 1. The process data from each run are provided in Attachment E-5.

6.4.1 Maximum Total Hydrocarbon Limit

FFCC demonstrated compliance with the total hydrocarbon (THC) limit standard of 10 ppmv established in the MACT EEE regulations. This limit will be continuously monitored as an hourly rolling average.

6.4.2 Maximum Percent Oxygen Limit

EPA Region 6 requested FFCC to establish a maximum percent oxygen limit in conjunction with their request to use combustion air flow rate as a surrogate for flue gas flow rate. This limit was set as 12.2 % oxygen in the stack gas during the CPT. The maximum percent oxygen in the stack gas limit was established as an average of the test run average percent oxygen recorded during the three runs of Test 1. This limit will be continuously monitored as an hourly rolling average.

7.0 Statement of Compliance

Based on my inquiry of the person or persons who manage the system, or those persons directly responsible for gathering the information, the information submitted is, to the best of my knowledge and belief, true, accurate, and complete.

The information contained in the notification establishes the operating controls and limits that ensure that the solid fuel boilers located at the FutureFuel Chemical Company in Batesville, Arkansas is in compliance with all the applicable emission standards of 40 CFR 63, Subpart EEE for Phase II units.

Signed this 2nd day of September 2010.

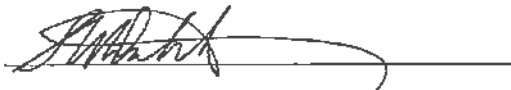

Sam Dortch
Executive Vice President, General Manager, FutureFuel Chemical Company

Tables

Table 1.0 – Feed Stream Analysis Data

Table 2.0 – Feed Stream Characteristics

Table 3.0 – Process Monitoring Instruments

Table 4.0 – Process Monitoring Instruments, Calibration, and Maintenance

Table 5.0 – CPT Process Feed Analytical Results

Table 6.0 – CPT Spiking Information

Table 7.0 – CPT Stack Gas Analytical Results

Table 8.0 – CPT Test 1 Averages

Table 9.0 – CPT Test 2 Averages

Table 10.0 – CPT Comparison of Planned Conditions to Actual Conditions - Test 1, Run 1

Table 11.0 – CPT Comparison of Planned Conditions to Actual Conditions - Test 1, Run 2

Table 12.0 – CPT Comparison of Planned Conditions to Actual Conditions - Test 1, Run 3

Table 13.0 – CPT Comparison of Planned Conditions to Actual Conditions - Test 2, Run 1

Table 14.0 – CPT Comparison of Planned Conditions to Actual Conditions - Test 2, Run 2

Table 15.0 – CPT Comparison of Planned Conditions to Actual Conditions - Test 2, Run 3

Table 16.0 – Demonstration of Compliance

Table 17.0 – Boiler Removal Efficiency

Table 18.0 – Summary of Operating Parameter Limits

Table 19.0 – Metal Extrapolation

Table 20.0 – Mercury MTEC Feed Rate Limit

Table 21.0 – Summary of Sampling and Analysis Program

TABLE 1.0
FEED STREAM ANALYSIS DATA

Feed Stream *	Average Heat Value (Btu/lb)	Low-Volatile Metals (Avg)			Semi-Volatile Metals (Avg)		Mercury (Avg)	Other Metals (Avg)				Avg Cl %	Avg Ash %	Physical Form	
		As ppm	Be ppm	Cr ppm	Cd ppm	Pb ppm		Hg ppm	Sb ppm	Ba ppm	Ag ppm				Tl ppm
Process Intermediate Waste	12,000	BDL	BDL	5	BDL	BDL	BDL	BDL	BDL	BDL	BDL	BDL	4	<1	Liquid
Fatty Acid Waste	12,000	BDL	BDL	106	BDL	BDL	BDL	BDL	BDL	BDL	BDL	BDL	0	<2	Liquid
Organic Process Waste	9,000	BDL	BDL	2	BDL	BDL	<0.1	BDL	BDL	<0.5	BDL	BDL	<1	<3	Liquid
Spent Solvent Waste	11,000	BDL	BDL	1	BDL	1	BDL	BDL	BDL	BDL	BDL	BDL	<1	<2	Liquid
DIPB Auxiliary Fuel	18,600	BDL	BDL	BDL	BDL	BDL	BDL	BDL	BDL	BDL	BDL	BDL	0	<1	Liquid
Biomass Fuel	11,800	BDL	BDL	BDL	BDL	BDL	BDL	BDL	BDL	BDL	BDL	BDL	0	3	Solid
Vapor Recovery Vent Gas	< 1000	BDL	BDL	BDL	BDL	BDL	BDL	BDL	BDL	BDL	BDL	BDL	<0.02	0	Gas
WWT Sludge	724	0.13	BDL	16	0.4	2.5	BDL	BDL	BDL	14	BDL	BDL	0	5.6	Semi-Solid
Coal	12,300	9	1	13	1	8	0.15	3	43	<1	BDL	BDL	0.1	10	Solid

BDL = Below Detection Limit

TABLE 2.0
FEED STREAM CHARACTERISTICS

Feed Stream	Constituents and Other Characteristics	Avg %	Max %	Organic Hazardous Air Pollutants	Quantity Burned per Year (lbs)	Waste Codes			
Organic Process Waste	Toluene	15	30	Acetonitrile	500,000 to 2,500,000	F003 D001, D021			
	Water	8	15	Chlorobenzene					
	Methanol	15	50	Phenol					
	Heptane	10	40	Triethylamine					
	TXIB	10	20	Toluene					
	DMAIP	2	5	Xylene					
	Acetone	10	40	Formaldehyde					
	Isopropanol	5	30	Methanol					
	Xylene	10	40	MIBK					
	MIBK	2	5	Ethyl Benzene					
	Other Organics	13	20						
	Spent Solvent Waste	Chlorobenzene	10	40			Acetonitrile	15,000,000 to 20,000,000	F002, F003, F005, D001, D002, D021
		Water	8	20			Chlorobenzene		
Toluene		20	50	Triethylamine					
Methanol		10	40	Toluene					
IFT Product		3	6	Formaldehyde					
Tars from organic process		14	30	MIBK					
Acetic Acid		25	50	Methanol					
Triethylene Glycol		2	5	Xylene					
o-Dichlorobenzene		5	20	Ethyl Benzene					
Other Organics		8	20						

TABLE 2.0 (Continued)
FEED STREAM CHARACTERISTICS

Feed Stream	Constituents and Other Characteristics	Avg %	Max. %	Organic Hazardous Air Pollutants	Quantity Burned per Year (lbs)	Waste Codes
Process Intermediate Waste	Chlorobenzene	10	30	Chlorobenzene	1,500,000 to 2,500,000	F002, F003, F005, D001, D021
	Acetone	15	40	Toluene		
	Isopropanol	15	30	Xylene		
	Heptane	15	30			
	Xylene	10	30			
	Toluene	15	30			
	Other organics	5	10			
Fatty Acid Waste	Nonanoic Acid	98	100	None	1,000,000 to 1,500,000	D007
	Octanoic Acid	0	1			
	TXIB	0	1			
Biomass Fuels	Woody Biomass	100	100	None	0 to 100,000	None

TABLE 2.0 (Continued)
 FEED STREAM CHARACTERISTICS

Feed Stream	Constituents and Other Characteristics	Avg %	Max. %	Organic Hazardous Air Pollutants	Quantity Burned per Year (lbs)	Waste Codes
Vapor Recovery Vent Gas	Nitrogen (Inert N2 Gas)	99.5	99.9	Methanol	1,500,000 to 2,000,000	None
	Acetone	0	0.1	Chlorobenzene		
	Methanol	0	0.08	Heptane		
	Water	0	0.05	Toluene		
	Chlorobenzene	0	0.04	Xylene		
	Heptane	0	.02	MIBK		
	Toluene	0	.02	Ethyl Benzene		
	Acetic Acid	0	.02			
	Isopropanol	0	.01			
	Xylene	0	.01			
WWT Sludge	Water	70	90	None	0 to 500,000	None
	Organic Microorganisms	15	25			
	Inorganic Solids	00	5			
Coal	Bituminous Coal	100	100	None	70,000,000 to 100,000,000	None

Notes:

- Btu = British Thermal Unit
- Btu/lb = British Thermal Unit per pound
- ppm = Parts per million
- wt.% = Weight production

• Only those organic HAPs that may be potentially present in the waste are reported in Table D-5.3. All other organic HAPs are not present based on on-site material use and process chemistry evaluations.

TABLE 3.0
PROCESS MONITORING INSTRUMENTS

Parameter	Location	Instrument Number(s)	Type of Instrument	Instrument Range	Expected Operating Range	Accuracy	Drawing Location Reference
Liquid Waste Feed Flow Monitor	2 nd floor liquid waste feed lines	FT-6M01-100 FT-6M01-200 FT-6M01-300	Micromotion Flow Meter	0 – 100 lb/min	0 – 65 lb/min	+/- 2 % rate	6M01-9T-031 6M01-9T-032 6M01-9T-089
Steam Atomization Pressure	2 nd floor steam feed lines	PSL-6M01-WCB-112A PSL-6M01-WCB-124A PSL-6M01-WCB-1164	Low Pressure Switch	Set at 40 psig (Falling)	50 – 90 psig	Repeatability < 2.5% Full scale	6M01-9T-031 6M01-9T-032 6M01-9T-089
Boiler Combustion Temperature	4 th floor superheater section	TE-6M01-9195 TE-6M01-9196 TE-6M01-9197	Type K Thermocouple	0 – 2200 degrees F	900 – 1500 degrees F	+/- 1 % Temperature	6M01-9T-024 6M01-9T-025 6M01-9T-026
ESP Power Input	3 rd floor precipitator panel	AI-PPTR-1 AI-PPTR-2 AI-PPTR-3	Neundorfer Precipitator Controls	0 – 50 kW	10 – 24 kW	+/- 5 %	6M01-9T-024 6M01-9T-025 6M01-9T-026
ESP Inlet Temperature	Precipitator Inlet	TE-6M01-FAS-608 TE-6M01-FAS-616 TE-6M01-FAS-624	Type J Thermocouple	0 – 1000 degrees F	420 – 510 degrees F	+/- 1% of Temperature	6M01-9T-024 6M01-9T-025 6M01-9T-026
Air Control Flow	Forced Draft Fan Outlet	FT-6M01-FAS-713 FT-6M01-FAS-714 FT-6M01-FAS-715	Pressure Transmitter	-6 to 6 in. w.c.	-3 to 3 in. w.c.	+/- 1 %	6M01-9T-024 6M01-9T-025 6M01-9T-026
Total Hydrocarbon	ID fan outlet duct	AT-6M09-116 AT-6M09-216 AT-6M09-316	Rosemount Mod. 400A	0 – 100 ppm	0 – 10 ppm	+/- 3%	6M01-9T-005 6M01-9T-026
Oxygen	ID fan outlet duct	AT-6M09-118 AT-6M09-218 AT-6M09-318	Rosemount Mod. X-Stream X2GP	0 – 25 %	0 – 25 %	+/- 2%	6M01-9T-005 6M01-9T-026

TABLE 4.0
PROCESS MONITORING INSTRUMENTS, CALIBRATION, and MAINTENANCE

Parameter	Location	Instrument Number(s)	Inspection/ Calibration Procedure	Calibration Frequency	Preventive Maintenance Procedure	Preventive Maintenance Frequency
Liquid Waste Feed Rate	Liquid Waste Feed Flow Monitor	FT-6M01-100 FT-6M01-200 FT-6M01-300	Check against ISO 9000 Standard	Annual	Check against ISO 9000 Standard	Annual
Steam Atomization Pressure	Steam Line	PSL-6M01-WCB-112A PSL-6M01-WCB-124A PSL-6M01-WCB-1164	Operator reviews for inconsistency with other process parameters.	As necessary	Calibrate or Replace	Annual
Combustion Temperature	Boiler Combustion Temperature	TE-6M01-9195 TE-6M01-9196 TE-6M01-9197	Visual Inspection with a density test against known material.	Annual	Check Accuracy or Replace	Annual
ESP Power Input	3rd floor precipitator panel	AI-PPTR-1 AI-PPTR-2 AI-PPTR-3	Primary Current. Secondary Current and Voltage are checked for accuracy	Annual	Calibrate	Annual
ESP Inlet Temperature	Precipitator Inlet	TE-6M01-FAS-608 TE-6M01-FAS-616 TE-6M01-FAS-624	Visual Inspection with a density test against known material.	Annual	Check Accuracy or Replace	Annual
Air Flow Control	Forced Draft Fan Outlet	FT-6M01-FAS-713 FT-6M01-FAS-714 FT-6M01-FAS-715	Calibrate against a known standard	Annual	Check and blow clear the circular annular ring	Annual
Total Hydrocarbon	I.D. Fan Outlet Duct	AT-6M09-116 AT-6M09-216 AT-6M09-316	Calibrate with known calibration gas +/- 2 % accuracy	Daily	PM is on call From daily check clean and calibrate	Annual
Oxygen	I.D. Fan Outlet Duct	AT-6M09-118 AT-6M09-218 AT-6M09-318	Calibrate with known calibration gas +/- 2 % accuracy	Daily	PM is on call From daily check clean and calibrate	Annual

Table 5.0 - CPT Process Feed Analytical Results

Process Waste Analytical Results						
Constituent	Test 1 Run 1	Test 1 Run 2	Test 1 Run 3	Test 2 Run 1	Test 2 Run 2	Test 2 Run 3
Chlorobenzene (%)	4.83	5.05	4.89	4.38	4.74	4.86
Heating Value (btu/lb)	6460	6482	6622	6254	6319	6333
Specific Gravity	1.036	1.032	1.044	1.052	1.056	1.052
Chloride (%)	NA	NA	NA	5.4	5.4	5.5
Ash (%)	0.03	0.03	0.02	0.04	0.03	0.01
Mercury (ug/g)	NA	NA	NA	0.004	0.002	0.003
SVM (ug/g)	0.034	0.034	0.034	0.033	0.033	0.033
Cadmium	0.005	0.005	0.005	0.005	0.005	0.005
Lead	0.029	0.029	0.029	0.029	0.028	0.029
LVM (ug/g)	18.450	18.521	18.308	17.217	17.152	16.265
Arsenic	0.048	0.049	0.048	0.048	0.047	0.048
Beryllium	0.029	0.029	0.029	0.029	0.028	0.029
Chromium	18.372	18.443	18.232	17.141	17.076	16.188
Primary Fuel Analytical Results						
Constituent	Test 1 Run 1	Test 1 Run 2	Test 1 Run 3	Test 2 Run 1	Test 2 Run 2	Test 2 Run 3
Chlorobenzene (%)	0	0	0	0	0	0
Heating Value (btu/lb)	10890	11090	11070	10630	10630	10600
Specific Gravity	NA	NA	NA	NA	NA	NA
Chloride (%)	NA	NA	NA	0.08	0.08	0.07
Ash (%)	10.4	8.45	8.44	9.26	9.26	9.79
Mercury (ug/g)	0.063	0.037	0.042	0.048	0.048	0.040
SVM (ug/g)	NA	NA	NA	4.98	4.98	5.09
Cadmium	NA	NA	NA	1.01	1.01	1.28
Lead	NA	NA	NA	3.97	3.97	3.81
LVM (ug/g)	NA	NA	NA	23.663	23.663	22.432
Arsenic	NA	NA	NA	1.33	1.33	1.4
Beryllium	NA	NA	NA	0.933	0.933	0.832
Chromium	NA	NA	NA	21.4	21.4	20.2

Table 6.0 - CPT Spiking Information

Ash Spiking - Test 2			
Test 2 (Run #)	Coal Added (lbs)	Diatomaceous Earth Added (lbs)	Ash Spike (%)
Run 1	100000	7500	7.5%
Run 2	100000	7500	7.5%
Run 3	50000	3750	7.5%

Metals Spiking Information - Test 2				Metals Spiking Information - Test 2				Metals Spiking Information							
6/3/2010				6/3/2010				6/4/2010							
Run 1	Time	Scale Weight	Solution Avg lb/hr	Avg Pb lb/hr	Avg Cr lb/hr	Time	Scale Weight	Solution Avg lb/hr	Pb lb/hr	Cr lb/hr	Time	Scale Weight	Solution Avg lb/hr	Pb lb/hr	Cr lb/hr
	10:00	312.30	64.8	0.60	1.41	14:12	466.0	62.1	0.58	1.35	7:00	335.7	68.5	0.64	1.49
	10:19	283.90	28.40			14:27	444.6	21.4			7:15	322.9	12.8		
	10:34	251.30	32.60			14:42	431.5	13.1			7:30	308.1	14.8		
	10:49	240.60	10.70			14:57	416.5	15.0			7:45	288.8	19.3		
	11:04	226.00	14.60			15:12	404.3	12.2			8:00	267.6	21.2		
	11:19	211.30	14.70			15:27	391.5	12.8			8:15	255.2	12.4		
	11:34	196.20	15.10			15:42	373.9	17.6			8:30	241.8	13.4		
	11:49	183.50	12.70			15:57	355.5	18.4			8:45	228.2	13.6		
	12:04	169.90	13.60			16:12	341.0	14.5			9:00	211.1	17.1		
	12:19	155.00	14.90			16:27	326.0	15.0			9:15	197.2	13.9		
	12:34	142.70	12.30			16:42	310.7	15.3			9:30	181.4	15.8		
	12:49	128.40	14.30								9:45	163.9	17.5		
	13:04	113.60	14.80								10:00	147.2	16.7		

Spike Solution Concentration = 0.933% Pb and 2.18% Cr

Table 7.0 - CPT Stack Gas Analytical Results

Test Run	Emission Constituent	Stack Flow DSCFM	Concentration ug/dscm	O2 %	Concentration @ 7% O2 ug/dscm	Emission Rate lb/hr
Test 1 Run 1	POHC	19728	7.76	12.1	NA	0.000478
Test 1 Run 2	POHC	19786	6.33	12.2	NA	0.000391
Test 1 Run 3	POHC	19575	7.69	12.3	NA	0.000470
Test 2 Run 1	POHC	22225	9.47	9.8	NA	0.000657
	Particulate	22222	14640	9.8	18300	1.015602
	Mercury	22222	4.08	9.8	5.1	0.000283
	SVM	22222	103.04	9.8	128.8	0.007148
	Cd	22222	0.8	9.8	1	0.000055
	Pb	22222	102.24	9.8	127.8	0.007093
	LVM	22222	63.68	9.8	79.6	0.004418
	As	22222	15.36	9.8	19.2	0.001066
	Be	22222	0.48	9.8	0.6	0.000033
Cr	22222	47.84	9.8	59.8	0.003319	
Test 2 Run 2	POHC	23078	7.83	9.8	NA	0.000564
	Particulate	23043	24160	9.8	30200	1.737942
	Mercury	23043	2.8	9.8	3.5	0.000201
	SVM	23043	141.36	9.8	176.7	0.010169
	Cd	23043	1.04	9.8	1.3	0.000075
	Pb	23043	140.32	9.8	175.4	0.010094
	LVM	23043	90.08	9.8	112.6	0.006480
	As	23043	16.32	9.8	20.4	0.001174
	Be	23043	0.48	9.8	0.6	0.000035
Cr	23043	73.28	9.8	91.6	0.005271	
Test 2 Run 3	POHC	21781	8.64	9.9	NA	0.000587
	Particulate	21749	23865	9.9	30100	1.620317
	Mercury	21749	2.54	9.9	3.2	0.000172
	SVM	21749	135.50	9.9	170.9	0.009200
	Cd	21749	1.98	9.9	2.5	0.000135
	Pb	21749	133.52	9.9	168.4	0.009065
	LVM	21749	126.70	9.9	159.8	0.008602
	As	21749	13.16	9.9	16.6	0.000894
	Be	21749	0.48	9.9	0.6	0.000032
Cr	21749	113.06	9.9	142.6	0.007676	

Table 8.0 - CPT Test 1 Averages

Test Parameters		Planned Conditions	Test 1	Test 1 Run Averages		
Description	Units			Target	Run 1	Run 2
Total Waste Feed Rate	lb/hr	1000	960	959	965	956
Total Coal Feed Rate	lb/hr	2500	3221	3266	3249	3148
Total POHC Feed Rate	lb/hr	25	47	46	49	47
Combustion Chamber Temperature	°F	1050	1061	1061	1059	1064
Combustion Chamber Pressure	psig	< 0	-0.3	-0.3	-0.3	-0.3
Combustion Air Flow Rate – FD Fan	scfm	NA	11270	11281	11253	11275
Combustion Air Flow Rate – Overfire	scfm	3050	3050	3050	3050	3050
Combustion Air Flow Rate – Atomizing	scfm	1800	1800	1800	1800	1800
Total Combustion Air Flow Rate	scfm	NA	16120	16131	16103	16125
THC Concentration	ppmv	< 10	0.4	0.5	0.5	0.4
O2 Concentration	%	13	12.2	12.2	12.3	12.0
Gun Atomization Pressure	psig	30	30	30	30	30

Table 9.0 - CPT Test 2 Averages

Test Parameters		Planned Conditions	Test 2 Average	Test 2 Run Averages		
Description	Units			Target	Run 1	Run 2
Total Waste Feed Rate	lb/hr	2500	2518	2509	2509	2535
Total Coal Feed Rate	lb/hr	6000	4664	4603	4603	4787
Total POHC Feed Rate	lb/hr	75	117	109.9	119.0	123.1
Total Chloride Feed Rate	lb/hr	150	494	504	504	474
Total Ash Feed Rate	lb/hr	1050	791	772	772	828
Total Mercury Feed Rate	lb/hr	0.0008	0.00019	0.00023	0.00013	0.00020
Total SVM Feed Rate	lb/hr	0.61	0.63	0.63	0.60	0.66
Total LVM Feed Rate	lb/hr	1.45	1.57	1.56	1.51	1.64
Combustion Chamber Temperature	°F	NA	1304	1304	1301	1308
Combustion Chamber Pressure	psig	< 0	-0.5	-0.5	-0.5	-0.4
Combustion Air Flow Rate – FD Fan	scfm	NA	16280	16190	16178	16471
Combustion Air Flow Rate – Overfire	scfm	3050	3050	3050	3050	3050
Combustion Air Flow Rate – Atomizing	scfm	1800	1800	1800	1800	1800
Total Combustion Air Flow Rate	scfm	NA	21130	21040	21028	21321
ESP Power	kW	7	8	8	8	8
ESP Inlet Temperature	°F	510	515	514	518	514
THC Concentration	ppmv	< 10	0.3	0.3	0.4	0.4
O2 Concentration	%	NA	10.1	10.0	10.1	10.3
Gun Atomization Pressure	psig	30	30	30	30	30

Table 10.0 - CPT Comparison of Planned Conditions to Actual Conditions
Test 1 Run 1

Test Parameters Description	Units	Planned Conditions		Actual Conditions			Comparison* Comment
		Target	Average	Minimum	Maximum	Comment	
Total Waste Feed Rate	lb/hr	1000	959	359	1470		
Total Coal Feed Rate	lb/hr	2500	3266	2950	3933	Decided to target higher temp requiring more coal	
Total POHC Feed Rate	lb/hr	25	46	17	71	Waste was 4.83% POHC rather than 4% target	
Total Chloride Feed Rate	lb/hr	NA	NA	NA	NA		
Total Ash Feed Rate	lb/hr	NA	NA	NA	NA		
Total Mercury Feed Rate	lb/hr	NA	NA	NA	NA		
Total SVM Feed Rate	lb/hr	NA	NA	NA	NA		
Total LVM Feed Rate	lb/hr	NA	NA	NA	NA		
Combustion Chamber Temperature	°F	1050	1061	1048	1071		
Combustion Chamber Pressure	psig	< 0	-0.3	-0.3	-0.3		
Combustion Air Flow Rate – FD Fan	scfm	NA	11281	10861	11803		
Combustion Air Flow Rate – Overfire	scfm	3050	3050	3050	3050		
Combustion Air Flow Rate – Atomizing	scfm	1800	1800	1800	1800		
Total Combustion Air Flow Rate	scfm	NA	16131	15711	16653		
ESP Power	kW	NA	20.4	16.9	24.0		
ESP Inlet Temperature	°F	NA	463	462	464		
THC Concentration	ppmv	< 10	0.5	0.2	0.7		
O2 Concentration	%	13	12.2	11.7	17.8		
Gun Atomization Pressure	psig	30	30	30	30		

* No comment means the difference between the planned and actual conditions were not significant (e.g., < 10%)

Table 11.0 - CPT Comparison of Planned Conditions to Actual Conditions
Test 1 Run 2

Test Parameters		Planned Conditions		Actual Conditions			Comparison*
Description	Units	Target	Average	Minimum	Maximum	Comment	
Total Waste Feed Rate	lb/hr	1000	965	723	1265		
Total Coal Feed Rate	lb/hr	2500	3249	3006	3881	Decided to target higher temp requiring more coal	
Total POHC Feed Rate	lb/hr	25	49	37	64	Waste was 5.05% POHC rather than 4% target	
Total Chloride Feed Rate	lb/hr	NA	NA	NA	NA		
Total Ash Feed Rate	lb/hr	NA	NA	NA	NA		
Total Mercury Feed Rate	lb/hr	NA	NA	NA	NA		
Total SVM Feed Rate	lb/hr	NA	NA	NA	NA		
Total LVM Feed Rate	lb/hr	NA	NA	NA	NA		
Combustion Chamber Temperature	°F	1050	1059	1054	1073		
Combustion Chamber Pressure	psig	< 0	-0.3	-0.3	-0.3		
Combustion Air Flow Rate – FD Fan	scfm	NA	11253	10795	11705		
Combustion Air Flow Rate – Overfire	scfm	3050	3050	3050	3050		
Combustion Air Flow Rate – Atomizing	scfm	1800	1800	1800	1800		
Total Combustion Air Flow Rate	scfm	NA	16103	15645	16555		
ESP Power	kW	NA	22.8	21.0	24.4		
ESP Inlet Temperature	°F	NA	460	459	461		
THC Concentration	ppmv	< 10	0.5	0.3	0.6		
O2 Concentration	%	13	12.3	11.7	17.9		
Gun Atomization Pressure	psig	30	30	30	30		

* No comment means the difference between the planned and actual conditions were not significant (e.g., < 10%)

**Table 12.0 - CPT Comparison of Planned Conditions to Actual Conditions
Test 1 Run 3**

Test Parameters		Units	Planned Conditions		Actual Conditions			Comparison* Comment
Description			Target	Average	Minimum	Maximum	Comment	
Total Waste Feed Rate		lb/hr	1000	956	563	1319		
Total Coal Feed Rate		lb/hr	2500	3148	2849	3573	Decided to target higher temp requiring more coal	
Total POHC Feed Rate		lb/hr	25	47	28	65	Waste was 4.89% POHC rather than 4% target	
Total Chloride Feed Rate		lb/hr	NA	NA	NA	NA		
Total Ash Feed Rate		lb/hr	NA	NA	NA	NA		
Total Mercury Feed Rate		lb/hr	NA	NA	NA	NA		
Total SVM Feed Rate		lb/hr	NA	NA	NA	NA		
Total LVM Feed Rate		lb/hr	NA	NA	NA	NA		
Combustion Chamber Temperature		°F	1050	1064	1054	1075		
Combustion Chamber Pressure		psig	< 0	-0.3	-0.3	-0.3		
Combustion Air Flow Rate – FD Fan		scfm	NA	11275	10813	11788		
Combustion Air Flow Rate – Overfire		scfm	3050	3050	3050	3050		
Combustion Air Flow Rate – Atomizing		scfm	1800	1800	1800	1800		
Total Combustion Air Flow Rate		scfm	NA	16125	15663	16638		
ESP Power		KW	NA	22.7	20.7	24.8		
ESP Inlet Temperature		°F	NA	458	458	459		
THC Concentration		ppmv	< 10	0.4	0.3	0.7		
O2 Concentration		%	13	12.0	10.5	17.4		
Gun Atomization Pressure		psig	30	30	30	30		

* No comment means the difference between the planned and actual conditions were not significant (e.g., < 10%)

Table 13.0 - CPT Comparison of Planned Conditions to Actual Conditions
Test 2 Run 1

Test Parameters Description	Units	Planned Conditions		Actual Conditions			Comparison Comment
		Target	Maximum	Average	Minimum	Maximum	
Total Waste Feed Rate	lb/hr	2500		2509	261	3054	
Total Coal Feed Rate	lb/hr	6000		4603	4236	5677	Less coal was need to make Steam Production Target
Total POHC Feed Rate	lb/hr	75		110	11	134	Waste was 4.38% POHC rather than 4% target
Total Chloride Feed Rate	lb/hr	150		504	353	619	Chloride concentration was 5.4% and target was 6%
Total Ash Feed Rate	lb/hr	1050		772	710	953	Less coal was need to make Steam Production Target
Total Mercury Feed Rate	lb/hr	0.0008		0.00023	NA	NA	Mercury content in coal was much less than normal
Total SVM Feed Rate	lb/hr	0.61		0.62753	NA	NA	
Total LVM Feed Rate	lb/hr	1.45		1.56461	NA	NA	
Combustion Chamber Temperature	°F	NA		1304	1237	1318	
Combustion Chamber Pressure	psig	< 0		-0.5	-0.5	-0.4	
Combustion Air Flow Rate – FD Fan	scfm	NA		16190	15671	17349	
Combustion Air Flow Rate – Overfire	scfm	3050		3050	3050	3050	
Combustion Air Flow Rate – Atomizing	scfm	1800		1800	1800	1800	
Total Combustion Air Flow Rate	scfm	NA		21040	20521	22199	
ESP Power	kW	8		8.4	7.3	8.6	
ESP Inlet Temperature	°F	510		514	511	516	
THC Concentration	ppmv	< 10		0.3	0.0	1.1	
O2 Concentration	%	NA		10.0	9.2	16.5	
Gun Atomization Pressure	psig	30					

* No comment means the difference between the planned and actual conditions were not significant (e.g., < 10%)

Table 14.0 - CPT Comparison of Planned Conditions to Actual Conditions
Test 2 Run 2

Test Parameters Description	Units	Planned Conditions		Actual Conditions			Comparison* Comment
		Target		Average	Minimum	Maximum	
Total Waste Feed Rate	lb/hr	2500		2509	2502	2518	
Total Coal Feed Rate	lb/hr	6000		4603	4507	5619	Less coal was need to make Steam Production Target
Total POHC Feed Rate	lb/hr	75		119	119	119	Waste was 4.74% POHC rather than 4% target
Total Chloride Feed Rate	lb/hr	150		504	496	586	Chloride concentration was 5.4% and target was 6%
Total Ash Feed Rate	lb/hr	1050		772	756	943	Less coal was need to make Steam Production Target
Total Mercury Feed Rate	lb/hr	0.0008		0.00013	NA	NA	Mercury content in coal was much less than normal
Total SVM Feed Rate	lb/hr	0.61		0.60	NA	NA	
Total LVM Feed Rate	lb/hr	1.45		1.51	NA	NA	
Combustion Chamber Temperature	°F	NA		1301	1284	1318	
Combustion Chamber Pressure	psig	< 0		-0.5	-0.5	-0.5	
Combustion Air Flow Rate – FD Fan	scfm	NA		16178	15793	16582	
Combustion Air Flow Rate – Overfire	scfm	3050		3050	3050	3050	
Combustion Air Flow Rate – Atomizing	scfm	1800		1800	1800	1800	
Total Combustion Air Flow Rate	scfm	NA		21028	20643	21432	
ESP Power	kW	8		8.2	7.5	8.3	
ESP Inlet Temperature	°F	510		518	516	519	
THC Concentration	ppmv	< 10		0.4	0.2	0.5	
O2 Concentration	%	NA		10.1	9.7	16.8	
Gun Atomization Pressure	psig	30		30	30	30	

* No comment means the difference between the planned and actual conditions were not significant (e.g., < 10%)

**Table 15.0 - CPT Comparison of Planned Conditions to Actual Conditions
Test 2 Run 3**

Test Parameters Description	Units	Planned Conditions		Actual Conditions			Comparison Comment
		Target	Average	Minimum	Maximum		
Total Waste Feed Rate	lb/hr	2500	2535	2521	2548		
Total Coal Feed Rate	lb/hr	6000	4787	4605	6047	Less coal was need to make Steam Production Target	
Total POHC Feed Rate	lb/hr	75	123	122	124	Waste was 4.74% POHC rather than 4% target	
Total Chloride Feed Rate	lb/hr	150	474	461	563	Chloride concentration was 5.4% and target was 6%	
Total Ash Feed Rate	lb/hr	1050	828	796	1046	Less coal was need to make Steam Production Target	
Total Mercury Feed Rate	lb/hr	0.0008	0.00020	NA	NA	Mercury content in coal was much less than normal	
Total SVM Feed Rate	lb/hr	0.61	0.66	NA	NA		
Total LVM Feed Rate	lb/hr	1.45	1.64	NA	NA	Spike team fed a little more than planned	
Combustion Chamber Temperature	°F	NA	1308	1291	1315		
Combustion Chamber Pressure	psig	< 0	-0.4	-0.4	-0.4		
Combustion Air Flow Rate – FD Fan	scfm	NA	16471	16127	16940		
Combustion Air Flow Rate – Overfire	scfm	3050	3050	3050	3050		
Combustion Air Flow Rate – Atomizing	scfm	1800	1800	1800	1800		
Total Combustion Air Flow Rate	scfm	NA	21321	20977	21790		
ESP Power	kW	8	7.9	7.3	8.2		
ESP Inlet Temperature	°F	510	514	514	514		
THC Concentration	ppmv	< 10	0.4	0.3	1.0		
O2 Concentration	%	NA	10.3	9.8	17.2		
Gun Atomization Pressure	psig	30	30	30	30		

* No comment means the difference between the planned and actual conditions were not significant (e.g., < 10%)

Table 16.0 - Demonstration of Compliance

Emission Results Compared to MACT EEE Standards for Solid Fuel-Fired Boilers			
Test	Units	Standard	CPT Result
Test 1 - Minimum Temperature Test			
Destruction Removal Efficiency	%	≥ 99.99%	99.9991%
Total Hydrocarbon Emissions ³	ppmv	≤ 10	0.4
Test 2 - Minimum Residence Time Test			
Destruction Removal Efficiency	%	≥ 99.99%	99.9995%
Particulate Emission ³	mg/dscm	≤ 68	26.2
HCl/Chlorine Emissions ¹	lb/hr	1886.8	508
Mercury Emissions ³	ug/dscm	≤ 11	3.9
Semi-Volatile Metal Emissions ³	ug/dscm	≤ 180	158.8
Low-Volatile Metal Emissions ³	ug/dscm	≤ 380	117.3
Dioxin/Furan ^{2 and 3} (as demonstrated by THC emissions)	ppmv	≤ 10	0.3
Total Hydrocarbon Emissions ³	ppmv	≤ 10	0.3

¹ Limit established using Health-based Alternative Compliance Demonstration described in Appendix D of the CPT Plan

² Requirement to conduct one time D/F test fulfilled by submittal of data in lieu of test. See Appendix F of CPT Plan.

³ Results corrected to 7% O₂

Table 17.0 - Boiler Removal Efficiency

Test Run	DRE POHC	SRE Particulate	SRE SVM	SRE LVM
Test 1 Run 1	99.9990%	NA	NA	NA
Test 1 Run 2	99.9992%	NA	NA	NA
Test 1 Run3	99.9990%	NA	NA	NA
Test 1 Average	99.9991%	NA	NA	NA
Test 2 Run 1	99.9994%	99.8685%	98.8609%	99.7177%
Test 2 Run 2	99.9995%	99.8685%	98.8138%	99.7067%
Test 2 Run 3	99.9995%	99.8773%	98.9235%	99.7311%
Test 2 Average	99.9995%	99.8714%	98.8660%	99.7185%

Table 18.0 - Summary of Operating Parameter Limits

Operating Parameters		Final Operating Limit	Comment
Waste Feed Limitations			
Maximum Hazardous Waste Feed Rate	lb/hr	2518	Obtained as the Average of the Test Run Average from Test 2
Maximum Chloride Feed Rate	lb/hr	494	Obtained as the Average of the Test Run Average from Test 2
Maximum Ash Feed Rate	lb/hr	791	Obtained as the Average of the Test Run Average from Test 2
Maximum Mercury Feed Rate	lb/hr	0.00083	Obtained as the Average of the Test Run Average from Test 2
Maximum Semi-Volatile Feed Rate	lb/hr	0.64	Obtained as the Average of the Test Run Average from Test 2
Maximum Low-Volatile Feed Rate	lb/hr	4.58	Obtained as the Average of the Test Run Average from Test 2
Combustion Chamber Limitations			
Minimum Combustion Chamber Temperature	°F	1061	Obtained as the Average of the Test Run Average from Test 1
Minimum Atomization Pressure	psig	30	Manufacturer's recommendation
Maximum Furnace Pressure	in.wc.	< 0	Induced draft system, must maintain negative furnace pressure
Maximum Combustion Air Flow Rate	scfm	21130	Obtained as the Average of the Test Run Average from Test 2
Air Pollution Control Limitations			
Minimum ESP Power	kW	8	Obtained as the Average of the Test Run Average from Test 2
Maximum ESP Inlet Temperature	°F	515	Obtained as the Average of the Test Run Average from Test 2
Stack Gas Limitations			
Maximum THC Concentration	ppmv	10	MACT Emission Standard
Maximum O ₂ Concentration	%	12.2	Obtained as the Average of the Test Run Average from Test 1

Table 19.0 - Metal Extrapolation

Metal Group	CPT Feed Rate (lb/hr)	CPT Emission Concentration @ 7% O2 (ug/DSCM)	90% of MACT Standard (ug/DSCM)	Extrapolated Operating Limit (lb/hr)
SVM	0.631	158.8	162	0.64
LVM	1.571	117.3	342	4.58

Table 20.0 - Mercury MTEC Feed Rate Limit

Hg Feed Rate Limit =	$(\text{MACT Limit ug/dscm}) \times (2.204586\text{E-}9 \text{ lb/ug}) \times (\text{Stack Flow dscm/min}) \times (60 \text{ min/hr}) / (1\text{-SRE})$
Hg Feed Rate Limit =	$(11 \text{ ug/dscm}) \times (2.204586\text{E-}9 \text{ lb/ug}) \times (22499 \text{ dscf/min} / 35.31 \text{ dscf/dscm}) \times (60 \text{ min/hr}) / (1\text{-}0)$
Hg Feed Rate Limit =	0.00093
90% Hg Feed Rate Limit =	0.00083

TABLE 21.0
SUMMARY OF SAMPLING AND ANALYSIS PROGRAM

Sample Type	Parameters	Sampling Method	Sample Frequency	Field QA/QC Samples	Analytical Methods
1) Liquid Organic Waste	Specific Gravity	Grab, 4 oz. collected at each sample interval (Two composites prepared for each run)	Initially and every 30 minutes; each run	None	ASTM D-1298
	Ash				ASTM D-482
	Chlorine				ASTM E:776 / SW-846 9056
	Heat Value				ASTM D-240
	SVM				SW-846 6020
	LVM				SW-846 6020
	Mercury				ASTM D-3684-01
2) Coal Feed	POHC	Grab, 40ml collected at each sample interval	Every 30 minutes; each run	None	SW-846, 8260
	Ash	Grab, 4 oz. collected at each sample interval (Two composites prepared for each run)	Initially and every 30 minutes; each run	None	ASTM D-3174
	Chlorine				ASTM E:776 / SW-846 9056
	Heat Value				ASTM D-5865
	SVM				SW-846 6010B
	LVM				SW-846 6010B
	Mercury				ASTM D-3684-01

TABLE 21.0 (Continued)
SUMMARY OF SAMPLING AND ANALYSIS PROGRAM

Sample Type	Parameters	Sampling Method	Sample Frequency	Field QA/QC Samples	Analytical Methods
3) Stack gas metals and particulate	As, Be, Cd, Cr, Hg, and Pb	Method 5 and 29, MMT, isokinetic sample	120 minutes each run	Reagent Blanks	SW-846 6020 and 7470a
4) Stack gas hydrogen chloride and Chlorine	Compliance with Alternative Chloride Limit based on feed rate and zero removal efficiency. No stack testing will be performed.				
6) Stack gas volatile organics - VOST	Volatile Organics	Method 0030, VOST train, 4 tube pairs	120 minutes each run	One condensate trip blank One pair VOST tube trip blank One set field blank tubes (four pairs each) per test condition	SW-0030, 5041
7) Stack gas PCDDs/PCDFs - MM5	Compliance will be demonstrated as data in lieu of testing based on trial burn completed in 1999.				

TABLE 21.0
SUMMARY OF SAMPLING AND ANALYSIS PROGRAM

Sample No./Type	Parameters	Sampling Method	Sample Frequency	Field QA/QC Samples	Analytical Methods
	Carbon Dioxide	ORSAT (EPA Method 3)	Each run	None	ORSAT Analyzer
	Total Hydrocarbon (from in-house CEMS)	EPA Method 25A	Each Run	None	Continuous, Extractive, Flame Ionization Analyzer
	Oxygen (from in-house CEMS & Stack Team)	Continuous, extractive, 3B	Each run	None	Continuous Extractive, 3B
	Stack Moisture	EPA Method 4	Each run	None	Measure volume to 0.5 ml
	Stack Velocity and Flowrate	EPA Method 2	Each run	None	Measure temperature, pressure, and volume

Notes to Table 5.0:

- = PAH
- = ASTM
- = POHC
- = CVAA
- = QA/QC
- = GC/MS
- = GC/FID
- = VOST
- = ICP
- = ICP-AES
- = Polynuclear aromatic hydrocarbon
- = American Society for Testing and Materials
- = Principal organic hazardous constituents
- = Cold vapor atomic absorption
- = Quality assurance and quality control
- = Gas chromatography and mass spectroscopy
- = Gas chromatography and flame ionization detector
- = Volatile organic sampling train
- = Inductively coupled argon plasma spectroscopy
- = Inductively coupled plasma-atomic emission spectrometry
- = LVM
- = ML
- = M0011
- = MM5
- = MMT
- = NaOH
- = NDIR
- = SVM
- = PCDD
- = PCDF
- = Low-Volatile Metals
- = Milliliter
- = EPA Method 0011
- = Modified Method 5
- = Multi-metals train
- = Sodium hydroxide
- = Nondispersive infrared
- = Semi-Volatile Metals
- = Dioxin
- = Furan
- = As
- = Be
- = Cd
- = Cr
- = Hg
- = H2SO4
- = KOH
- = gm
- = Btu
- = Pb
- = Arsenic
- = Beryllium
- = Cadmium
- = Chromium
- = Mercury
- = Sulfuric acid
- = Potassium hydroxide
- = Gallons per minute
- = British thermal units
- = Lead

NOTIFICATION OF COMPLIANCE

FutureFuel Chemical Company

Hazardous Waste Incinerator

Revision 0

Pursuant to

**NESHAP: Standards for Hazardous Air Pollutants for Hazardous Waste
Combustors (40 CFR 63 Subpart EEE)**

Prepared by

**FUTUREFUEL CHEMICAL COMPANY
ARKANSAS OPERATIONS
P.O. Box 2357
Batesville, AR 72503
ARD089234884**

**RISK MANAGEMENT & ENGINEERING, LTD.
705 W. Avenue B, Suite 400
Garland, TX 75040**

January 12, 2011

EXECUTIVE SUMMARY

FutureFuel Chemical Company (FFCC) owns and operates an organic chemical manufacturing plant located southeast of Batesville, Arkansas. As part of plant operations, FFCC generates wastes regulated under the Resource Conservation and Recovery Act (RCRA) and destroys waste in a MACT EEE compliant phase I incinerator currently operating under Title V permit # 1088-AOP-R8. FFCC also burns waste for energy recovery in three coal-fired boilers. Those boilers are currently operating under an NOC submitted September 1, 2010, as well as, Arkansas Department of Environmental Quality (ADEQ) Waste Permit Number 11H-M005

FFCC submitted a Comprehensive Performance Test (CPT) plan for approval on August 1, 2008. The plan was not reviewed by EPA Region VI until August 2010. On October 5, 2010, EPA Region VI submitted a letter of conditional approval to FFCC. FFCC then conducted the Comprehensive Performance Test (CPT) the week of October 11, 2010. The results of this test are being submitted as the Notice of Compliance (NOC) to the EPA and ADEQ. FFCC will begin complying with the operational parameters and limits established within this NOC immediately upon submittal.

CONCLUSIONS ON MEETING CPT OBJECTIVES

The overall objective of the Comprehensive Performance Test was to demonstrate that the incinerator is capable of meeting the incinerator emission standards established in the MACT Combustion Rule (40 CFR 63 Subpart EEE) and to establish operating conditions and parameters that are equivalent with that demonstration. Table ES-1 summarizes the specific objectives demonstrated during the CPT.

FFCC was successful in meeting the overall CPT objective, and this NOC establishes the operating conditions that reflect the results of this successful test.

Table ES-1

Specific Objective	CPT Result
Demonstrate 99.99 % DRE of the designated POHC Chlorobenzene	Run 1 DRE = > 99.99996 % Run 2 DRE = > 99.99997 % Run 3 DRE = > 99.99995 %
Demonstrate control of carbon monoxide (CO) emissions to less than 100 parts per million dry volume (ppmv), corrected to 7 percent oxygen, on a 60-minute rolling average basis.	The average CO demonstrated during all three runs of the CPT was <u>1.2 ppmv</u>
Demonstrate control of hydrocarbon emissions to less than 10 parts per million dry volume (ppmv), corrected to 7 percent oxygen, on a 60-minute rolling average basis.	The average THC demonstrated during all three runs of the CPT was <u>2.2 ppmv</u>
Demonstrate control of particulate emissions to less than 0.013 grains per dry standard cubic foot (gr/dscf) corrected to 7 percent oxygen.	The average particulate emission demonstrated during three runs of the CPT was <u>0.0042 gr/dscf</u>
Demonstrate that control of HCl and free chlorine emissions are equal to or less than 32 ppmv corrected to 7 percent oxygen.	The average HCl/Cl ₂ emission demonstrated during the three runs of the CPT was <u>10.0 ppmv</u>
Demonstrate that control of mercury emissions are equal to or less than 130 micrograms per dry standard cubic meter (ug/dscm) corrected to 7 percent oxygen.	The average mercury emission demonstrated during the three runs of the CPT was <u>1.3 ug/dscm</u>
Demonstrate that control of Semi-Volatile metals (SVM) emissions are equal to or less than 230 micrograms per dry standard cubic meter (ug/dscm) corrected to 7 percent oxygen.	The average SVM emission, demonstrated during the three runs of the CPT was <u>224.8 ug/dscm</u>
Demonstrate that control of Low-Volatile metals (LVM) emissions are equal to or less than 92 micrograms per dry standard cubic meter (ug/dscm) corrected to 7 percent oxygen.	The average LVM emission, demonstrated during the three runs of the CPT was <u>65.5 ug/dscm</u>
Demonstrate that control of Dioxin/Furan (D/F) emissions are equal to or less than 0.4 nanograms TEQ per dry standard cubic meter (ng TEQ/dscm) corrected to 7 percent oxygen.	The average D/F emission, demonstrated during the three runs of the CPT was <u>0.0032 ng/dscm</u>

DEVIATIONS FROM THE CPT PLAN

There were a few deviations from the approved CPT plan. Table ES-2 details the changes made after formal EPA and ADEQ approval of the CPT plan.

Table ES-2

Change to the CPT Plan	Explanation of Change
The heat content, POHC content, and chloride content of Run 2 was higher than planned.	When FFCC began pumping the low-btu waste to the incinerator for stabilization for Run 2, a valve was not closed all the way at a transfer station and approximately 2000 gallons of low-btu aqueous waste slipped into the high-btu waste tank. This caused phase separation in the high-btu waste tank. The heavy chlorinated waste migrated to the bottom taking most of the toluene with it, and the water phase migrated to the top taking most of the methanol with it. Our feed to the incinerator was coming from the lower portion of the tank, and this section had a higher concentration of perchloroethylene, chlorobenzene, and toluene than planned.
FFCC added small amounts of sulfuric acid to the scrubber recirculation tank during runs 1 and 3 to maintain the pH target submitted in the CPT Plan. Approximately 5 lbs an hour was introduced into the system.	FFCC set the target scrubber pH during the CPT for a pH of 4. In order to demonstrate the system was capable of removing HCl/Cl ₂ at low pH, FFCC found it necessary to add a small quantity of sulfuric acid into the scrubber recirculation tank during Run 1 and Run 3 in order to lower the scrubber pH into the desired target range. This issue is discussed in more detail in the following "Issues and Solutions" section of the executive summary.

CPT ISSUES AND SOLUTIONS

The incinerator performed well. Two issues were encountered during the CPT. One involved the high-btu waste feed composition, and the other involved the pH of the scrubber water.

Issue 1 – Waste Feed Composition

When FFCC began pumping the low-btu waste to the incinerator for stabilization for Run 2, a transfer line valve was not closed all the way and approximately 2000 gallons of low-btu aqueous waste slipped out of the feed line into the high-btu waste tank before it was discovered. When we were stabilizing we knew that something was different because the waste appeared to have higher-Btu than in Run 1 and the scrubbing system was behaving as though there were more chlorides present than in Run 1. However, the differences did not appear to be so significant that Run 2 could not be completed and we moved forward with Run 2. We continued to notice the differences throughout Run 2. We theorized that the water caused some phase separation in the tank. At the end of the run we pulled samples from different layers in the tank and determined that phase separation did indeed occur. The heavy chlorinated organics (perchloroethylene and chlorobenzene) migrated to the bottom of the tank taking most of the toluene and a little methanol with it. The low-btu aqueous phase migrated to the top taking most of the methanol with it and a little toluene. This told us we probably fed way more chloride in Run 2 than we had planned, because we were burning from the lower portion of the tank. That night we decanted off the top water contaminated methanol layer and replaced the methanol. This worked very well and got us back close to our target composition for Run 3. Since the Run 2 chloride feed rate was greater than the feed rates where we had historically demonstrated compliance, we were concerned with HCl/Cl₂ emissions for Run 2. We believed the unit was capable of removing the HCl/Cl₂ but we did not have any historical data to support that hypothesis. For insurance, FFCC actually conducted a Run 4 for HCl/Cl₂ only in case Run 2 had a detrimental effect on the CPT. It turned out the unit performed well in Run 2 and the data from Run 4 was not needed, and thus not used.

Issue 2 – Scrubber pH

During stabilization prior to Run 1, the pH of the scrubber did not drop into the target range (pH = 4). In order to demonstrate the performance of the scrubber to remove HCl/Cl₂ at a low pH, it was decided to use a small pump to meter sulfuric acid into the scrubber water on the suction side of the scrubber water recirculation pump. This lowered the pH of the scrubber water well before the scrubber pH probes. We were able to keep the pH around 4 with a spike rate of approximately 2.4 lb every 15 minutes of sulfuric acid. This was done on both Run 1 and Run 3.

PERMIT RELATED OPERATIONAL DATA

Table ES-3 provides a summary of the permit related operational data derived from the CPT.

Table ES-3

Parameter Limit	Basis	Result
Maximum total hazardous waste feed (lb/hr-HRA)	Average of the test run averages	15,348
Maximum Chloride Feed Rate (lb/hr-12HRA)	Average of the test run averages	1.428
Maximum Ash Feed Rate (lb/hr-12HRA)	Average of the test run averages	1.453
Maximum Mercury Feed Rate (lb/hr-12HRA)	The mercury feed rate is established by 90% of the Maximum Theoretical Emission Calculation (MTEC). The MTEC is based on the maximum flue gas flow rate limit, MACT EEE mercury emission limit, and zero percent mercury removal efficiency.	0.01
Maximum Semi-Volatile Metal Feed Rate (lb/hr-12HRA)	Average of the test run averages	0.84
Maximum Low-Volatile Metal Feed Rate (lb/hr-12 HRA)	Average of the test run averages	1.62
Maximum Flue Gas Flow Rate (scfm - HRA)	Correlated from the Average of the Combustion Air Flow Rate Test Run Averages	23,602
Minimum Combustion temperature (degrees F - HRA)	Average of the test run averages	1,558

Table ES-3, continued

Parameter	Basis	Result
Minimum Scrubber dP (in. w.c. - HRA)	Average of the test run averages	71
Minimum Scrubber Water pH (HRA)	Average of the test run averages	4.4
Minimum Quench Tank pH (HRA)	Average of the test run averages	0.6
Minimum 1 st Stage Scrubber Water Flow Rate (gpm - HRA)	Average of the test run averages	477
Minimum 2 nd Stage Scrubber Water Flow Rate (gpm - HRA)	Average of the test run averages	301
Minimum Scrubber Water Blowdown Rate (gpm - HRA)	Average of the test run averages	100
Minimum Scrubber Tank Level (% - HRA)	Average of the test run averages	72
Minimum Atomization Pressure (psig - Instantaneous)	Manufacturer's Recommendation	30
Maximum Combustion Chamber Pressure (in. w.c. - Instantaneous)	90% of the Maximum System Design Pressure	200

FINAL PERMIT LIMITS

The final limits adopted pursuant to this NOC are described in Table ES-3. All parameters will be continuously monitored process parameters that will be tied to automatic waste feed cutoffs (AWFCO).

TABLE OF CONTENTS

	Page
Executive Summary	i
Table of Contents	viii
1.0 – Notification of Compliance	1
1.1 – Facility Information and List of Key Project Personnel	1
1.1.1 – Facility Information	1
1.1.2 – List of Key Project Personnel	1
1.2 – Detailed Engineering Description of the Incinerator.....	5
1.2.1 – Combustion and Fuel Feed Systems	5
1.2.1.1 – Auxiliary Fuel Feed Systems	6
1.2.1.2 – Liquid Waste Feed Systems	6
1.2.2 – Prime Mover	7
1.2.3 – Waste Liquid Injection Nozzles	7
1.2.4 – Description of Rapid Quench System	7
1.2.5 – Automatic Waste Feed Cutoff System	8
1.2.6 – Description of Air Pollution Control Equipment	9
1.2.7 – Incinerator Stack	9

TABLE OF CONTENTS, continued

	Page
1.2.8 – Location and Description of Temperature, Pressure, And Flow Indicating and Control Devices	9
1.2.9 – Stack Gas Monitoring System	10
1.3 – Incinerator Operator Training and Certification	10
2.0 – Sampling and Analysis Program	11
2.1 – Sampling Program.....	11
2.1.1 – Waste Feed Preparation	11
2.1.2 – Sampling and Monitoring Procedures	12
2.1.3 – Volatile Organic Analysis Samples	12
2.1.4 – Organic Waste Samples	12
2.1.5 – Aqueous Waste Samples	13
2.1.6 – Metals Spiking Solution	13
2.1.7 – Combustion Gas	13
2.1.7.1 – Combustion Gas Temperature.....	13
2.1.7.2 – Combustion Gas Monitoring	13
2.1.8 – Stack Gas	14
2.1.8.1 – Hydrogen Chloride, Chlorine, and Particulate Train	14
2.1.8.2 – Multi-Metals Train	14

TABLE OF CONTENTS, continued

	Page
2.1.8.3 – Volatile Organic Sampling Train.....	15
2.1.8.4 – Dioxin/Furan Sampling Train	15
2.2 – Analytical Program	16
2.2.1 – Analytical Methods	16
2.2.2 – Analytical Results	16
3.0 – Description of the Test Program	17
3.1 – CPT Objectives	17
3.2 – CPT Approach	18
3.2.1 – POHC Selection	18
3.3 – CPT Program.....	19
3.3.1 – Comprehensive Performance Test	19
3.4 – CPT Sampling and Analytical Protocols	19
4.0 – Comparison of Actual Test Conditions versus Planned Conditions and Independent QA Review	21
4.1 – Combustion Device Parameters	21

TABLE OF CONTENTS, continued

	Page
4.2 – Waste Feed Rate Parameters	22
4.3 – Constituent Feed Rate Parameters	22
4.4 – Stack Gas Parameters	23
4.5 – Independent QA Review	23
4.5.1 – Stack Testing Equipment	23
4.5.2 – Stack Gas-Particulate Analysis.....	23
4.5.3 – Stack Gas – HCl/Cl ₂ Analysis	24
4.5.4 – Stack Gas – Metal Analysis	24
4.5.5 – Stack Gas – Volatile Organics Analysis	25
4.5.6 – Stack Gas – PCDD/PCDF	25
4.5.7 – Stack Gas – Continuous Emissions Monitoring Data.....	26
4.5.8 – Waste - Volatile Organics.....	26
4.5.9 – Waste – Non-Organics.....	27
4.5.10 – Process Instruments	28
4.5.11 – Conclusion	29

TABLE OF CONTENTS, continued

	Page
5.0 – Comparison of Test Results with Regulatory Compliance Limits.....	30
5.1 – Regulatory Requirements for the CPT	30
5.1.1 – Destruction Removal Efficiency	30
5.1.2 – Particulate Emissions	31
5.1.3 – HCl / Cl ₂ Emissions	31
5.1.4 – Mercury Emissions	31
5.1.5 – Semi-Volatile Metals Emissions	31
5.1.6 – Low-Volatile Metals Emissions	32
5.1.7 – Dioxin/Furan Emissions	32
5.1.8 – Carbon Monoxide Emissions	32
5.1.9 – Total Hydrocarbon Emissions	32
6.0 – Procedures and Limits for Operating Parameters	33
6.1 – Waste Feed Rate Limitations	33
6.1.1 – Maximum Hazardous Waste Feed Rate Limit	33
6.1.2 – Maximum Chloride Feed Rate Limit	33
6.1.3 – Maximum Ash Feed Rate Limit.....	33
6.1.4 – Metals Feed Rate Limits	34

TABLE OF CONTENTS, continued

	Page
6.1.4.1 – Maximum Mercury Feed Rate Limit	34
6.1.4.2 – Maximum Semi-Volatile Metals Feed Rate	34
6.1.4.3 – Maximum Low Volatile Metals Feed Rate	34
6.2 – Combustion Chamber Limitations	35
6.2.1 – Minimum Combustion Chamber Temperature Limitation	35
6.2.2 – Minimum Atomization Pressure Limitation	35
6.2.3 – Maximum Furnace Pressure Limitation	35
6.2.4 – Maximum Flue Gas Flow Rate Limitation	35
6.3 – Air Pollution Control Limitations	36
6.3.1 – Minimum Pressure Drop Across the Scrubber	36
6.3.2 – Minimum Scrubber pH	36
6.3.3 – Minimum Quench Tank pH	36
6.3.4 – Minimum Water Flow Rate to 1 st Stage Scrubber	37
6.3.5 – Minimum Water Flow Rate to 2 nd Stage Scrubber	37
6.3.6 – Minimum Scrubber Blowdown Flow Rate	37
6.3.7 – Minimum Scrubber Recirculation Tank Volume	37
6.4 – Stack Gas Limitations	38

TABLE OF CONTENTS, continued

	Page
7.0 – CPT Conditional Approval Items	39
7.1 – Quality Assurance Project Plan (QAPP)	39
7.1.1 – Signature Page	39
7.1.2 – Hazardous Waste Combustion Table	39
7.2 – Combustion Zone Pressure	39
7.2.1 – Combustion Zone Design and Maintenance	39
7.2.1.1 – Manufacturer's Design	39
7.2.1.2 – Maintenance Process for Seals	40
7.2.1.3 – Maintenance / Replacement History for Seals	40
7.2.2 – Combustion Zone Inspection Program	40
7.2.3 – Recordkeeping	40
7.2.4 – Response to Leaks	40
7.3 – General Pending Comments	41
7.3.1 – Feed Stream Analysis Plan	41
7.3.2 – CO CEMS Range	41
7.3.4 – Combustion Air and Flue Gas Flow Correlation	41
8.0 – Statement of Compliance	42

LIST OF TABLES

Table 1 – Feed Stream Analysis Data

Table 2 – Feed Stream Characteristics

Table 3 – Summary of Sampling and Analysis Program

Table 4 – Process Monitoring Instruments

Table 5 – Process Monitoring Instruments, Calibration, and Maintenance

Table 6 – CPT Process Feed Analytical Results

Table 7 – CPT Spiking Information

Table 8 – CPT Stack Gas Analytical Results

Table 9 – CPT Test Averages

Table 10 – CPT Comparison of Planned Conditions to Actual Conditions - Run 1

Table 11 – CPT Comparison of Planned Conditions to Actual Conditions - Run 2

Table 12 – CPT Comparison of Planned Conditions to Actual Conditions - Run 3

Table 13 – Demonstration of Compliance

Table 14 – Summary of Operating Parameter Limits

Table 15 – Mercury MTEC Feed Rate Limit

Table 16 – Destruction Removal Efficiency

Table 17 – CPT Operational Data Summary

LIST OF ATTACHMENTS

Attachment A – Alliance Source Testing - Stack Test Report

Attachment B – Quality Assurance Project Plan

Attachment C – Instrument Calibration Records

Attachment D – Feed Stream Analytical Results

Attachment E – Other Information

Attachment E-1 – Metals Spiking Certificate of Analysis

Attachment E-2 – Field Sampling and Spiking Logs

Attachment E-3 – Combustion Air Correlation Curve

Attachment E-4 – Relative Accuracy Test Audit

Attachment E-5 – Process Test Data

Attachment F – Destructor Flue-Gas Scan

Attachment G – Description of Revisions

LIST OF DRAWINGS

P&I Diagram Burner and Controls CD-201	6M10-9T-001
P&I Diagram Burner and Controls CD-200R	6M10-9T-002
P&I Diagram Weir Tank CD-220	6M10-9T-003
P&I Diagram Quench Separator CD-236	6M10-9T-004
P&I Diagram Scrubber and Separator CD-223 & CD-227	6M10-9T-005
P&I Diagram Scrubber Recirculation Tank CD-224	6M10-9T-006
P&I Diagram Combustion Air Blower Item CD-207R	6M10-9T-007
P&I Diagram Fuel Guns and Waste Guns	6M10-9T-009
P&I Diagram Continuous Emission Monitoring System	6M10-9T-012
T-Thermal Destructor Steel Outline CD-200R1	6M10-4V-032
T-Thermal Destructor Steel Outline CD-200R1	6M10-4V-033
American Boa Non-Metallic Ducting Expansion Joints	6M10-4E-050

1.0 Notice of Compliance

The following notification of compliance summarizes the activities associated with the comprehensive performance test (CPT), documents the results of the CPT, and serves as the basis for the development of operating conditions. The CPT was generally conducted in accordance with the CPT plan as approved August 1, 2008 and adjusted based on EPA Region VI "conditional approval" letter received October 5, 2010.

1.1 Facility Information and List of Key Project Personnel

The following section gives background facility information and provides a list of key project personnel.

1.1.1 Facility Information

Background facility information is listed below:

Facility Name:	FutureFuel Chemical Company
Contact:	Thomas L Floyd
Address:	P.O. Box 2357 2800 Gap Rd. Hwy 394-S Batesville, Arkansas 72503
Telephone Number:	(870) 698-1811
U.S. EPA Identification No.	ARD089234884
Regulatory Agencies:	Environmental Protection Agency, Region VI Arkansas Department of Environmental Quality, Air Division

1.1.2 List of Key Project Personnel

A list of key project personnel is shown below:

CPT Manager	Name	Thomas L Floyd
	Company	FutureFuel Chemical Company
	Title	Senior Environmental Biologist
	Address	P.O. Box 2357 Batesville, Arkansas 72503
	Telephone No.	(870) 698-1811
	Responsibility:	Responsible for implementing and coordinating the CPT

Independent Third Party Quality Assurance Auditor	Name	David Weeks
	Company	Risk Management & Engineering, LTD.
	Title	Senior Environmental Engineer
	Address	Dallas, TX
	Telephone No.	(972) 412-6819
	Responsibility:	Independent third party quality assurance auditor for all aspects of the CPT

Stack Sampling Project Director	Name	Jeremy Hutchens
	Company	Alliance Source Testing
	Title	Environmental Scientist
	Address	214 Central Circle SW Decatur, Alabama 25603
	Telephone No.	(256)260-3974
	Responsibility:	QA/QC assurance of stack gas sampling to ensure integrity of emissions data, as well as reporting coordinator.

Stack Sampling Field Supervisor	Name	Ryan O'Dea
	Company	Alliance Source Testing
	Title	Stack Sampling Supervisor
	Address	8020 Counts Massie Road N. Little Rock, AR 72113
	Telephone No.	(501) 771-9969
	Responsibility:	Coordinating the collection of stack gas emissions

Laboratory Coordinator & QA/QC Manager	Name	Michael D. Challis
	Company	Maxxam
	Title	Laboratory QA/QC Manager
	Address	P.O. Box 598 Addison, Texas 75001
	Telephone No.	(972) 931-7127
	Responsibility:	Coordinating the laboratory analysis of all stack samples and ensuring QA/QC procedures on sampling and analysis.

Process Sampling Laboratory Manager	Name	John Overbey
	Company	American Interplex
	Title	Laboratory Director
	Address	8600 Kanis Road Little Rock, AR 72204
	Telephone No.	(501) 224-5060
	Responsibility:	Coordinating the laboratory analysis of all process samples and ensuring QA/QC procedures on sampling and analysis.

Incinerator Operations Supervisor	Name	Eddie Brown
	Company	FutureFuel Chemical Company
	Title	Operations Supervisor
	Address	P.O. Box 2357 Batesville, Arkansas 72503
	Telephone No.	(870) 698-1811
	Responsibility:	Supervisor of Incinerator Operations

Process Spiking Coordinator	Name	Mike Gillihan
	Company	FutureFuel Chemical Company
	Title	Process Assistant
	Address	P.O. Box 2357 Batesville, Arkansas 72503
	Telephone No.	(870) 698-1811
	Responsibility:	Coordinating process spiking

Process Sampling Coordinator	Name	Marshel Bray
	Company	FutureFuel Chemical Company
	Title	Environmental Process Assistant
	Address	P.O. Box 2357 Batesville, Arkansas 72503
	Telephone No.	(870) 698-1811
	Responsibility:	Coordinating process sampling

Process Sample Laboratory Coordinator	Name	Lynn Cornelius
	Company	FutureFuel
	Title	Senior Environmental Technologist
	Address	P.O. Box 2357 Batesville, Arkansas 72503
	Telephone No.	(870) 698-1811
	Responsibility:	Coordinating the sampling and analysis of all process samples.

Agency Oversight Personnel	Name	Larissa Brown
	Agency	Arkansas Department of Environmental Quality
	Address	1141 E. Main St, Suite #315 Batesville, AR 72501
	Telephone No.	(870) 793-4762
	Responsibility:	ADEQ oversight of the CPT

1.2 Detailed Engineering Description of Incinerator System

FFCC operates one waste-burning incinerator at its Batesville, Arkansas plant. The incinerator is a John Zink HI-50, with a rapid quench and a Hydrosonic scrubbing system, which burns liquid process wastes for destruction.

1.2.1 Combustion and Fuel Feed Systems

The primary combustion chamber or burner is a small vertical refractory lined cylinder with five main guns mounted at the top in the burner. Natural gas can be fed through a gun located in the center of the burner at the upper level. There are four air-atomized guns on the burner as well. One of the air-atomized guns is used to feed liquid auxiliary fuels; the other three air-atomized guns are used to feed liquid waste.

The secondary level, just below the upper level, utilizes six additional air-atomized guns fed from one or two feed lines for combustion of low-Btu waste or injection of water.

The secondary combustion chamber is a vertical down-fired John Zink designed unit that measures 12'-0" outside diameter and 10'-5" inside diameter. It has a straight side height of 33'-5". The cross-sectional area of the primary chamber is 17 square feet, and the cross-sectional area of the secondary chamber is 86 square feet. The unit is constructed of refractory-lined carbon steel.

After leaving the combustion chamber, waste gases enter the rapid quench system. The system is described in section 1.2.4

Next, the waste gases pass through the air pollution control system (APCS) described in Section 1.2.6 before exiting out the stack.

Design Criteria

- Furnace Residence Time — 2.2 – 3 seconds at 1900 degree F
- Design Firing Rate — 50 MM BTU/hr
- Design Pressure — 8 psig
- Fuel — liquid waste, fuel oil, and natural gas

The fuel used for the incinerator is liquid waste, fuel oil, and natural gas with the liquid waste serving as the primary fuel.

1.2.1.1 Auxiliary Fuel Feed Systems

The auxiliary fuel feed system consists of fuel oil storage tanks, pumps, supply piping and valves, natural gas pilots, electric igniters, atomizing air, and flame detectors, as well as the burner itself. The fuel supply is interlocked with combustion control and automatic shutdown systems. The main auxiliary fuel burner is equipped to use fuel oil and/or natural gas and to also use high heating value non-regulated waste liquids. The auxiliary fuel system is used only for start-ups or when necessary to maintain the desired temperature in the combustion chamber. The capacity of the auxiliary fuel system is 1,500 lb/hr for fuel oil, and 36,000 SCFM for natural gas.

1.2.1.2 Liquid Waste Feed Systems

The characteristics of the liquid waste are described in Tables 1 and 2. The waste characteristics provided in the tables are typical of "as-fired" conditions; although FFCC may occasionally blend waste by moving material between tanks to meet desired waste feed characteristics and regulatory requirements. Wastes are generally fed from the tanks permitted under RCRA Permit 11H-M005.

Liquid waste can also be burned directly in the incinerator from containers. FFCC uses various portable containers to transfer wastes to the treatment facility (e.g., 750-gallon portable dumpsters, tankers, etc.). The portable containers are used for special manufacturing situations and for wastes that have the potential to be incompatible with the waste stored in FFCC feed tanks.

Centrifugal pumps are used to transfer waste from the storage tanks and containers to the incinerator through a variety of lines. The waste is segregated and fed based on Btu value (liquid aqueous waste and liquid organic waste). The flow rate of the liquid wastes is continuously monitored by mass flow meters and can be adjusted from the control room by control valves located at the incinerator.

The feed rate design capacity of the liquid aqueous waste feed is 13,500 lb/hr. The design capacity of the liquid organic waste feed is 4,500 lb/hr.

1.2.2 Prime Mover

The combustion air blower is a Model 67103A centrifugal fan manufactured by Hoffman. The design conditions for the blower are 15,300 standard cubic feet per minute at 100 degree F, at 14.55 PSIA, 144 in. w.c., with a 500-horsepower motor. The incinerator is operated as a forced draft system. The system will be maintained sealed to prevent fugitive emissions.

1.2.3 Waste Liquid Injection Nozzles

The incinerator uses a total of 10 nozzles. The three nozzles used to burn liquid organic waste are Turbotak air-atomized nozzles. The six aqueous waste nozzles are John Zink type with Delavan tip air-atomized nozzles. The auxiliary fuel nozzle is a Turbotak air atomized nozzle. A minimum atomizing air pressure of 30 psig was specified by the manufacturer.

1.2.4 Description of Rapid Quench System

Combustion gases leave the combustion chamber and enter a T-Thermal SUB-X® quench system. The hot gases enter a weir tank through a water-washed downcomer. The weir tank is a carbon steel tank that is FRP (Derakane 510A Resin with 5% antimony trioxide) lined. The dimensions of the weir tank will be 7'-6" I.D. x 13'-9" overall height (OAH). Salts dripping down from the incinerator outlet drop into and are dissolved in the water bath. The downcomer directs the flow of hot gases approximately 24" below the surface of the water bath in the weir tank. The downcomer is constructed of alloy C-22 and has a 64" I.D. The gases are then forced into the water bath as they pass through openings near the bottom of the downcomer. As the gases mix with the water, they transfer heat to the water bath. The saturated gases then rise between the downcomer and the weir tank wall, carrying some of the quench water into the quench separator.

The quench separator is constructed of FRP. The dimensions of the quench separator are 10'-6" I.D. x 28'-2" OAH. It takes the liquid laden gases and reduces the velocity of those gases. As the velocity is dropped, the entrained liquid disengages and drops into the quench separator sump. The exit temperature of the combustion gases leaving the rapid quench system will be approximately 190 deg F. Makeup water to this system is primarily the blowdown from the Hydrosonics scrubber. Blowdown from the quench is pumped to the plant permitted wastewater treatment facility.

1.2.5 Automatic Waste Feed Cutoff System

The primary function of the Automatic Waste Feed Cutoff (AWFCO) system interlocks is to prevent the feeding of waste if operating conditions are outside the permit limits. The AWFCO system is controlled by the incinerator facility Programmable Logic Controller (PLC).

The FFCC incinerator is equipped with a PLC-based control system and a central data acquisition system (DAS) which provide the necessary monitoring and control. The control system is composed of a Siemens Simatic 505 series controller and four operator interface terminals. The operator interfaces are personal computers running the Tecnomatix FactoryLink[®] human/machine interface (HMI) software. The two primary operator interfaces are independently connected to the PLC. Two additional stations are located in the site powerhouse. These stations are connected to the primary operator interfaces in a client/server arrangement via the plant Ethernet network. The primary operator interfaces continually poll the PLC for the current values of all system monitoring devices. The operator can use the operator interfaces to modify the incinerator operation within defined operating parameters if necessary. A thirty day historical dataset of one minute samples is maintained on the operator interfaces connected to the PLC. This data can be used to back-populate data into the central data acquisition system in the event that the central data acquisition system becomes unavailable for an extended period of time.

The central data acquisition system (DAS) is composed of a local data gathering node and a remote data archiving node. This system uses the OSIsoft PI[®] software. The local data gathering node is implemented using the PI[®] OPC interface software on the two PCs that are connected directly to the PLC. Whichever of these two PCs is currently designated as the primary server will function as the local data gathering node. This node is connected to the remote data archiving node via the plant Ethernet network. The remote data archiving node is implemented using the PI[®] server software. The local data gathering node is referred to as a PI-API Node, and the remote data archiving node is referred to as the PI Home Node. The PI Home Node is the primary data repository. In the event that the PI Home Node is unavailable, data is buffered on the PI-API Node until the PI Home Node is again available. The PI-API Node polls the HMI software for the analog operating variables at least every 15 seconds. This data is transmitted to the PI Home Node on an exception basis and is stored in a compressed format.

The PLC monitors and controls the incinerator operations including all required permit operating parameters. If any parameter exceeds a shutoff limit that is set at a high percentage of its regulatory limit, the PLC initiates an automatic waste feed cutoff by de-energizing the signal that allows the waste feed dual block valves to open. This loss of signal immediately closes the waste feed dual block valves and prohibits waste from entering the incinerator. Radiant heat in the incinerator will not allow the combustion chamber temperature to drop significantly during the cutoff of liquid waste. Therefore, any residual liquid waste fuel in the incinerator will be burned. In accordance with regulatory requirements, FFCC will test the waste feed cutoff system once each week during normal operation.

In order to minimize the number of waste feed cutoffs, the operator interface will also alarm when any of the variables reach a high percentage of their shutoff limits. This early warning will permit the incinerator operator to take necessary corrective action before the shutoff limits are exceeded. The early alarm does not activate the AWFCO system. The AWFCO system is activated immediately whenever a permit related parameter that is tied to the AWFCO system is exceeded. A first-out system implemented in the PLC software will indicate which parameter caused the automatic waste feed cutoff, either tests or actual. A numerical code indicating the trip condition is recorded in the DAS.

1.2.6 Description of Air Pollution Control Equipment

A Hydrosonics two-stage high-energy scrubber treats the combustion gases from the incinerator. The saturated gases are introduced into the scrubber first stage via a sub-sonic nozzle forming a free jet. Scrubbing liquor is sprayed into the periphery of the exhaust of the free jet. This forms a water curtain of fine high-speed water droplets through which the gases must pass, thereby removing the particulate from the gas. Acids in the gas stream are simultaneously removed by the scrubbing liquor. Addition of caustic to the scrubber liquor maintains its pH at a level high enough to maintain acid-scrubbing capability. Large droplets formed fall and are drained from the first stage, while gases pass through to the second stage. The second stage operates in the same manner as that of the first. Gases leaving the second stage then pass through a vane demister prior to exhausting through the Stack to the atmosphere. The design liquid flow rate of the scrubber is 500 gallons per minute in the first stage and 300 gallons per minute in the second stage. Plant process water is used as makeup to this recirculating system, which is blown down to the rapid quench weir tank.

1.2.7 Incinerator Stack

The new exhaust stack has a 48" I.D. and is 84 feet in height. The top of the stack will be 20 ft higher than the top of the combustion chamber. The stack will be constructed of FRP and will have 4 different sample ports located at three different levels on the stack, for total of 12 sample ports. At each level there will be four 6" sample ports at 90-degree angles in a horizontal plane.

1.2.8 Location and Description of Temperature, Pressure, and Flow Indicating and Control Devices

FFCC uses a variety of devices to control the operation of the incinerator system. A complete list of the instruments including their description and location can be seen in Tables 4 and 5.

1.2.9 Stack Gas Monitoring System

FFCC continuously monitors carbon monoxide (CO) and oxygen (O₂) levels in the combustion stack gases. The gas analyzer will be a high performance multiple gas analyzer. The gas analyzer's carbon monoxide (CO) monitor will be an IR adsorption device capable of measuring CO at levels from 40 ppb to 3,000 ppm. The oxygen monitor operates using paramagnetic transduction and is capable of measuring oxygen concentrations ranging from 0% – 25% in the flue gas.

1.3 Incinerator Operator Training and Certification

All incinerator operators receive initial training by completing the Utilities Operator Apprentice Program. This is a site-specific procedure based training program that has been reviewed and certified by the state Department of Labor. The training includes written materials, hands-on-labs, and on-the-job training. Once an apprentice operator has received training for a task or course and has completed that section of the Apprenticeship Program the operator is then allowed to do that task by their self.

A certified operator will instruct the apprentice until they have successfully completed the program and passed a written examination administered by the instructor. The completions are recorded in an on-site training management system.

An annual review is administered to the operators and critical staff that include both Title V, MACT and RCRA updates along with pertinent operational training, including but not limited to the SSM plan. The Utilities Operator Apprentice Program, including the Incinerator Operator Training, is reviewed and updated whenever changes have been made that could improve the training or make the existing training obsolete.

A certified control room operator will be on duty at the site when the incinerator is operating.

2.0 Sampling and Analysis Program

This section summarizes the sampling and analysis programs conducted during the CPT.

2.1 Sampling Program

FFCC fed the following streams during the CPT:

1. Hazardous waste
 - a. High-Btu Organic Waste
 - b. Low-Btu Aqueous Waste
2. Metals Spiking Solution
3. Natural Gas

2.1.1 Waste Feed Preparation

Organic Waste - The organic waste was prepared by FFCC's manufacturing unit in a 2,000-gallon reactor. The stream was prepared as a 40% toluene, 36% methanol, 2% chlorobenzene, and 22% perchloroethylene solution. The purpose of the stream was to provide a high Btu waste feed that contained a primary organic hazardous constituent (POHC) and as well as significant amount of chlorides.

Aqueous Waste - The aqueous waste was prepared in FFCC's waste feed tank. The stream was prepared to provide an 87% water and 13% sodium chloride solution. The purpose of the stream was to provide a low Btu waste feed that consisted of 13% total ash content.

Metals Spiking Solution - The metals spiking solution was prepared by Blue Ridge Chemicals, Inc. headquartered in Bala Cynwyd, Pennsylvania. This solution was prepared in order to establish MACT EEE feed limits for semi-volatile (cadmium and lead) and low-volatile (arsenic, beryllium, and chromium) metals. Lead was chosen to represent the semi-volatile metals and chromium was chosen to represent the low volatile metals. The solution was ordered to exact specifications and certified by Blue Ridge Chemicals as to its composition (certificate of analysis is located in Attachment E-1). The high volatile metal, mercury, was not spiked in to the feed stream. Mercury is not expected to be found in FFCC's waste and the feedrate limit will be based on the maximum theoretical emission concentration (MTEC).

Natural Gas – The natural gas, used as auxiliary fuel support during the testing, and is supplied by CenterPoint Energy Arkla. The natural gas is a high Btu process stream that is absent of ash, chlorine and POHCs.

2.1.2 Sampling and Monitoring Procedures

The CPT consisted of three replicate runs at the extreme range of normal conditions. Each run involved stack emission sampling for POHC destruction to ensure 99.99% DRE and to demonstrate compliance with the THC, CO, particulate matter, hydrogen chloride/chlorine, mercury, semi-volatile metal, low-volatile metal and D/F emission standards. Waste feed and process samples were obtained during each run of the CPT.

The procedures for collecting samples are summarized in Table 3.0. Sampling frequency and reference methods also are included in Table 3.0. Additional details regarding sampling frequencies and methods follow.

2.1.3 Volatile Organic Analysis Samples

The volatile organic analysis (VOA) samples of the high-btu wastes were collected from a tap in the waste feed line prior to combustion. The VOA samples of the low-btu wastes were collected from a tank outlet upstream from the metals spiking point. Grab samples for the VOA were taken every 30 minutes, packaged separately in 40ml vials, and then placed in ice and cooled to 4 degrees C. These samples were composited by the laboratory before analysis.

2.1.4 Organic Waste Samples

The organic waste samples were also collected from a tap in the waste feed line for analysis of non-organic constituents. These grab samples were taken every 30 minutes in 8-oz jars and then placed in an ice cooled environment and transported to the designated analytical laboratory for analysis. These samples were composited by the laboratory prior to analysis.

2.1.5 Aqueous Waste Samples

The aqueous waste samples were also collected from a tank outlet, upstream from the metals spiking point, for analysis organic and non-organic constituents. These grab samples were taken every 30 minutes in 8-oz jars and then placed in an ice cooled environment and transported to the designated analytical laboratory for analysis. These samples were composited by the laboratory prior to analysis.

2.1.6 Metals Spiking Solution

The metals spiking solution was not sampled as a separate waste stream. It was prepared off-site by a third party who certified the composition. Attachment E-1 contains a copy of that certification. The solution was fed to the liquid waste feed line upstream of the combustion chamber injection point, and down-stream of the point where the organic and aqueous waste samples were taken. The feed rate of the metals solution was controlled using a chemical metering pump and a scale. The feed rate was maintained by calculating the weight loss of the container holding the metals solution. The scale calibration documentation can be found in Attachment C.

2.1.7 Combustion Gas

2.1.7.1 Combustion Gas Temperature

The combustion gas temperature was measured in the combustion chamber by thermocouple with an instrument range of 0 – 2200 degrees Fahrenheit. This thermocouple is located about 18 inches above the bottom of the cylindrical section of the oxidizer.

2.1.7.2 Combustion Gas Monitoring

A stack gas monitoring system was used to monitor the carbon monoxide and oxygen content of the flue gas. The carbon monoxide (CO) monitor was an IR adsorption device capable of measuring CO at levels from 40 ppb to 3,000 ppm. The oxygen monitor operates using paramagnetic transduction and is capable of measuring oxygen concentrations ranging from 0% – 25% in the flue gas. A contractor-supplied total hydrocarbon (THC) monitor was utilized in parallel with these instruments.

2.1.8 Stack Gas

Stack gas was collected from the incinerator stack. The stack's sampling ports were designed to meet all stack gas sampling needs (e.g., isokinetic sampling, etc.).

2.1.8.1 Hydrogen Chloride, Chlorine, and Particulate Train (Method 26A)

The Method 26A hydrogen Halide and Halogen isokinetic sampling train was used to collect hydrogen chloride and chlorine samples during the three runs of the CPT. The total sampling time was about 3 hours during each replicate sampling run. The Method 26A train was operated concurrently with the other sampling train(s) to sample stack gas. Gaseous and particulate pollutants were withdrawn isokinetically from the source and collected on a filter, and in absorbing solutions. The Method 26A procedure includes measurement of the stack gas flow rate and temperature according to EPA Methods 1 and 2. EPA Method 3A was used to determine oxygen and carbon monoxide concentration in the stack. EPA Method 4 was used to determine the stack gas moisture content.

2.1.8.2 Multi-Metals Train (Method 29)

An MMT (multi-metals train) was used for collection of metals from the stack gas during the CPT. The sampling train impingers were charged with a solution of 5 percent nitric acid and 10 percent hydrogen peroxide to capture metals (i.e., arsenic, beryllium, cadmium, chromium, lead, and mercury) and acidified potassium permanganate (composed of 4 percent potassium permanganate and 10 percent sulfuric acid) to capture any mercury that was not captured by the nitric acid and hydrogen peroxide solution. The total sampling time was about 3 hours during each replicate sampling run. The MMT was operated concurrently with the other sampling train(s) to sample about 3 cubic meters of stack gas. The MMT procedure includes measurement of the stack gas flow rate and temperature according to EPA Methods 1 and 2. Carbon monoxide and oxygen determinations were made by Method 3A. Stack gas moisture was sampled in accordance with EPA Method 4. The Method 26A stack measurement of these parameters was used for the MMT calculations.

2.1.8.3 Volatile Organic Sampling Train (Method 0030)

A volatile organic sampling train (VOST) was used during the CPT to collect the POHC chlorobenzene from the stack gas on sorbent resin. The VOST was configured in accordance with SW-846 Method 0030 with two Tenax® resin tubes and one Anasorb® tube in series. The VOST was operated concurrently with the other sampling trains to collect a total of four sets of VOST cartridges for each test run. Three sets were targeted for analysis. The fourth set served as a backup in the event of tube breakage or damage during shipment and laboratory handling. About 20 liters of stack gas were sampled per set of VOST cartridges at 0.5 liters per minute for 40 minutes (slow-VOST conditions). The VOST cartridges were capped immediately upon removal from the train, wrapped in aluminum foil, placed in glass tubes, and sealed. The Method 23A stack parameter measurements were used for the VOST calculations.

2.1.8.4 Dioxin/Furan Sampling Train (Method 23A)

An MM5 sampling train was used for collecting PCDDs and PCDFs during the CPT. The sorbent trap contained XAD-2 resin to capture organics, and the impingers were filled with water. The total sampling time for this train was about 3 hours during each replicate sampling run. The sampling train was operated to sample approximately 4 cubic meters of stack gas. The sampling train was operated and recovered according to the procedures described in Method 0023A for PCDDs and PCDFs.

2.2 Analytical Program

Maxxam Analytics laboratory headquartered in Mississauga, Ontario. This laboratory was used for all stack sampling analysis.

American Interplex is located in Little Rock, Arkansas and was used for all process feed stream analysis conducted during the CPT.

2.2.1 Analytical Methods

A summary of the analytical methods and procedures are summarized in Table 3.0 Detailed analytical methods and procedures for the stack samples are described in Attachment A. Analytical methods and procedures for the feed stream analysis can be found in Attachment D

2.2.2 Analytical Results

The stack sample analytical results are located in Attachment A. The process feed analytical results are summarized in Table 6.0. The actual feed stream analysis can be found in Attachment D.

3.0 Description of the Test Program

This section summarizes the comprehensive performance test plan. The plan¹ contains the details of the test that was conducted October 12 – 14, 2010. The Executive Summary in this NOC discusses those deviations from the plan that were necessary to address unexpected or unplanned conditions.

3.1 CPT Objectives

The overall objective of this Comprehensive Performance Test is to demonstrate that the incinerator is capable of meeting the incinerator emission standards established in the MACT Combustion Rule (40 CFR 63 Subpart EEE) and to establish operating conditions and parameters that are equivalent with that demonstration.

The specific objectives for the FFCC comprehensive performance test are listed below. Each emissions parameter will be reported with concentration corrected to 7% Oxygen.

- Demonstrate 99.99 percent DRE of the designated POHC (chlorobenzene).
- Demonstrate control of particulate emissions to less than or equal to 0.013 grains per dry standard cubic foot (gr/dscf) at maximum ash feed rates.
- Demonstrate that hydrogen chloride/chlorine emissions are less than or equal to 32 ppmv at maximum chloride feed rates.
- Demonstrate that mercury emissions are less than or equal to 130 micrograms per dry standard cubic meter (ug/dscm).
- Demonstrate that semi-volatile metal (cadmium and lead) emissions are less than or equal to 230 micrograms per dry standard cubic meter (ug/dscm) at maximum semi-volatile metal feed rates.
- Demonstrate that low-volatile metal (arsenic, beryllium, and chromium) emissions are less than or equal to 92 micrograms per dry standard cubic meter (ug/dscm) at maximum low-volatile metal feed rates.
- Demonstrate that carbon monoxide (CO) emissions are less than 100 ppmv (dry) on an hourly rolling average basis.

¹ Submitted August 1, 2008.

- Demonstrate that total hydrocarbon emissions are less than 10 ppmv (dry) on an hourly rolling average basis.
- Demonstrate that dioxin/furan emissions are less than or equal to 0.40 nanograms total equivalent quotient per dry standard cubic meter (ng TEQ/dscm).
- Gather data regarding waste feed characteristics and process operating conditions that will be used to develop operational permit limits that will ensure compliance with regulatory performance standard.

3.2 CPT Approach

The CPT is based upon 40 CFR 63 Subpart EEE. 40 CFR 63.1207 establishes the requirements for conducting a comprehensive performance test. The universal approach establishes one set of permit conditions or limits applicable to all modes of operation. This approach allows FFCC to treat the complete variety of wastes produced by the FFCC facility under one well-defined set of operating limits. Operating limits have been derived from data assembled during the CPT.

3.2.1 POHC Selection

FFCC has based its selection of POHC on two primary factors: (1) the University of Dayton thermal stability ranking, and (2) the composition of the actual wastes to be burned. Consistent with these factors, FFCC used the following criteria to select the POHC for this CPT:

- The POHC should be present as an Appendix VIII constituent in the actual wastes to the maximum extent practicable.
- The POHC should be considered an organic hazardous air pollutant under 42 U.S.C. 7412(b)(1), and
- The POHC should have a high ranking on the University of Dayton thermal stability-ranking list.

The constituents that are likely to be found in FFCC's liquid waste are listed in Table 2. Many of these compounds are included on the University of Dayton thermal stability ranking including acetonitrile, benzene, chlorobenzene, and toluene. Chlorobenzene was selected as the POHC because it is a Class I compound, it is typically present in greater quantities in the waste than the other Class I compounds, and it is readily available.

3.3 CPT Program

The proposed CPT program consists of one test of three replicate runs. The target operating conditions are designed to establish operating limits for the incinerator that will ensure all MACT combustion standards are met.

3.3.1 Comprehensive Performance Test

The CPT was conducted at the extreme range of normal conditions as prescribed in 40 CFR 63.1207. It was conducted at low combustion chamber temperature to demonstrate DRE of the designated POHC at extreme conditions for organic hazardous constituent destruction. In addition, the incinerator combustion gas velocity was maximized in order to decrease gas residence time. The liquid waste feed was maximized in order to show the DRE performance can be met at maximum allowable feed rates. Other operating conditions were set at extremes as above to assure that normal emissions are less than what is measured herein. This test condition was also used to demonstrate that Dioxin/Furan, carbon monoxide, total hydrocarbon, mercury, semi-volatile metal, low-volatile metal, hydrogen chloride/chlorine, and particulate emission standards are being met.

The aqueous waste feed was a solution of waste, metal salts, and sodium chloride designed to represent low Btu waste feed, as well as provide ash and chlorides during the CPT. The organic waste feed was a mixture of chlorobenzene, perchloroethylene, methanol, and toluene designed to represent high Btu waste feed, as well as provide POHC (chlorobenzene) and organic chlorides (chlorobenzene, perchloroethylene).

3.4 CPT Sampling and Analytical Protocols

The CPT sampling and analysis program is summarized in Table 3. The structure of this CPT is based on the previously stated objectives.

The stack was sampled during the CPT as follows:

- The volatile POHC chlorobenzene were sampled using the VOST train (SW-846 Method 0030).
- Hydrogen chloride, chlorine, and particulate emissions combined, were sampled using the EPA Reference Test Method 5/26A.
- PCDD/PCDFs were sampled using the SW-846 Method 0023A.
- Metals, including Mercury, were sampled using EPA Referenced Test Method 29.

- CO testing was done with the facility's permanent CEM system.
- Total Hydrocarbon (THC) testing was conducted using EPA Reference Test Method 25A.

In addition to stack sampling, the feed material (liquid wastes), and process water was sampled and analyzed for a number of physical and chemical parameters. These methods are summarized in Table 3.0. The actual waste analytical results and QA/QC can be found in Attachment D. A summary of the waste feed results can be seen in Table 6.0.

4.0 Comparison of Actual Test Conditions versus Planned Conditions and Independent QA Review

A comparison of the actual test conditions experienced during the CPT with the planned (target) test conditions documented in the CPT plan is provided below. Tables 10.0, 11.0, and 12.0 provide a summary of the various operating parameter data with respect to the target conditions for each run.

Comparisons were made on three sets of parameters:

- Combustion Device Parameters
- Feed Rate Parameters
- Constituent Feed Rate Parameters
- Stack Gas Parameters

4.1 Combustion Device Parameters

These parameters were used to establish limits for ensuring proper combustion and pollution control device operation. They include:

- Combustion chamber temperature – In general, the average combustion chamber temperature exceeded the target by approximately 58 °F due to higher than anticipated waste heating values.
- Gun Atomization Pressure – This parameter is based on manufacturer's recommendations. The atomization pressure during the CPT is consistent with those recommendations.
- Combustion Air Flow Rate – The combustion air flow rate is consistent with the target operating conditions.
- Scrubber Pressure Drop – The pressure drop across the scrubber is consistent with the target conditions.
- Scrubber Water pH – The pH of the scrubber water is consistent with the target conditions.
- Quench Tank pH – This is a new parameter that was established during the CPT based on FFCC's observation that chloride scrubbing efficiency is affected by this parameter. The values demonstrated during the CPT are consistent with FFCC's anticipated operations.

- 1st Stage Scrubber Flow - The 1st Stage scrubber flow rate is consistent with the target conditions.
- 2nd Stage Scrubber Flow - The 2nd Stage scrubber flow rate is less than target operating conditions by approximately 49 gpm.
- Scrubber Blowdown Rate - The scrubber blowdown rate is consistent with the target conditions.
- Scrubber Recirculation Tank Level – The scrubber recirculation tank level is consistent with the target conditions.

4.2 Feed Rate Parameters

These parameters were used to establish constituent and POHC feed rates. They include:

- Total Waste Feed Rate – The feed rate demonstrated during the test, although less than described in the CPT Plan, should be sufficient for continued operation.
- Low BTU Aqueous Waste Feed Rate – The feed rate demonstrated during the test, although less than described in the CPT Plan, should be sufficient for continued operation.
- High BTU Organic Waste Feed Rate – The feed rate demonstrated during the test, although less than described in the CPT Plan, should be sufficient for continued operation.

4.3 Constituent Feed Rate Parameters

These parameters were calculated from the fuel feed rate parameters and the constituent concentrations in the fuel feed for the CPT Test. They include:

- Total Chloride Feed Rate – In general, the overall average total chloride feed rate was 13% lower than the target value.
- Total Ash Feed Rate – In general, the overall average total ash feed rate was 12% lower than the target value.
- Total Mercury Feed Rate – Mercury was not detected in the waste feed, but the detection limits were slightly better than anticipated, resulting in a lower mercury feed rate than the target value.

- Total Semi-Volatile Metal Feed Rate – The overall average SVM feed rate was higher than the target conditions due to increased spiking rates.
- Total Low-Volatile Metal Feed Rate – The overall average LVM feed rate was higher than the target conditions due to increased spiking rates.

4.4 Stack Gas Parameters

These parameters were monitored by a continuous emission monitor. They include:

- Total Hydrocarbon Concentration – Emissions were well below the standard as expected.
- Carbon Monoxide Concentration – Emissions were well below the standard as expected.

4.5 Independent QA Review

Mr. David A. Weeks, P.E., BCEE, CIH (Risk Management and Engineering, Ltd.) provided independent oversight of the CPT and conducted an independent review of the quality assurance and quality control (QA/QC) performed by the stack testing company and laboratories during the test. A summary of the stack testing QC measurements is included in Section 4 of the stack test report (provided as Attachment A) in addition to the discussion contained in this section.

4.5.1 Stack Testing Equipment

Mr. Weeks was present during the entire CPT and inspected the stack sampling calibration records including the dry gas meter calibration records, pitot tube calibration records, and temperature indicator calibration records at the time of the test. Mr. Weeks observed the leak checks of the sampling equipment during the tests and found them to be in good order. The post calibration records were in order and showed that the stack gas sampling equipment functioned properly and provided data that were in accordance with the U.S. EPA methods used to collect the data. The calibration records are provided in Appendix D to Attachment A.

4.5.2 Stack Gas - Particulate Analysis

Mr. Weeks conducted an independent review of the analytical data. The balance calibration data is summarized on Appendix D of Attachment A. The results showed no deviation at a standard weight of 0.5000, 10, and 50 grams, and deviations ranging from 0.0001 to 0.0002 grams at standard weights of 100 and 1 grams, respectively. The maximum deviation (0.2 mg) is less than the 0.5 mg performance criterion. The particulate quantity stated on the laboratory certificate (see Appendix C of Attachment A) matches the particulate quantity used by Alliance to calculate

the particulate concentration. Mr. Weeks' independent review of the data confirms the results reported by Alliance in their report.

4.5.3 Stack Gas – HCl/Cl₂ Analysis

Mr. Weeks conducted an independent review of the analytical data. The available QA/QC data is summarized in Appendix C to Attachment A. The results show that the recovery of HCl from matrix spikes and spiked blanks was 99%. The recovery of Chlorine from matrix spikes and spiked blanks was 102 and 101% respectively. The QA/QC Plan does not provide specific performance criteria for this method because the method itself is very limited on QA/QC requirements. The Method states that the results of audit samples are the primary means of quality assurance/control other than the sampling checks that are prescribed by Method 5. The Method recommends that the difference between the known value of an audit sample and the measured value be less than 10%. As demonstrated above, recoveries of matrix and spiked blanks were within 1 to 2 percent of the known spiked quantity. Thus, the available QC data for this method demonstrate that the laboratory is generally performing within the QC limits specified by the method. Further, the laboratory did analyze a laboratory duplicate using the Run 1 impinger solutions. The analysis shows that the relative percent difference between the mass of HCl and Chlorine in the sample and the duplicate sample is 4.5% and -3.0%, respectively, which shows good precision in the analysis. HCl and chlorine were not detected in the laboratory blanks. The HCl and chlorine mass stated on the laboratory certificate matches the HCl and chlorine mass used by Alliance to calculate the total chloride concentration. Mr. Weeks' independent review of the data confirms the results reported by Alliance in their report.

4.5.4 Stack Gas - Metals Analysis

Mr. Weeks conducted an independent review of the analytical data. The stack sampling contractor's QA/QC summary is contained in Section 4 of Attachment A. The laboratory QC data is contained on pages in Appendix C to Attachment A. The matrix spike and matrix spike duplicate recoveries were within the 70 – 130 % accuracy objective as defined in the QAPP. Matrix spikes were performed for mercury on all the components of the blank train and portions of the Run 1 samples. (The QAPP required at least one matrix spike per test.) The mercury recoveries from the matrix spikes ranged from 87 to 112%, showing that metals were not lost during the digestion process. The recoveries for semi- and low-volatile metals ranged from 87 to 107%. The RPD between the matrix spike and matrix spike duplicate analyses were less than the 25% objective established in the QAPP, with the results ranging between 0 to 4% RPD for all metals. Thus, laboratory analyses were not biased high or low. The mass of metals stated on the laboratory certificate matches the mass of metals used by Alliance to calculate the concentration of metals in the stack gas. Mr. Weeks' independent review of the data confirms the results reported by Alliance.

4.5.5 Stack Gas - Volatile Organics Analysis

Mr. Weeks conducted an independent review of the analytical data. The laboratory's QC discussion and surrogate spike recovery data is contained in Appendix C to Attachment A. Alliance reports, and Mr. Weeks confirmed by inspection of the laboratory data sheets, that surrogate recoveries ranged from 86 to 106 percent as compared to the target objective of 50 – 150%. The surrogate recovery for the spiked blanks and method blanks was 94 to 116%. The RSD for the recoveries of the surrogate toluene-d8 calculated as 5.4% as compared to the QAPP target of less than 35% RSD. The mass of chlorobenzene stated on the laboratory certificate matches the mass of chlorobenzene used by Alliance to calculate the concentration of chlorobenzene in the stack gas. Mr. Weeks' independent review of the data confirms the results reported by Alliance.

4.5.6 Stack Gas – PCDD/PCDF

Mr. Weeks conducted an independent review of the analytical data. The laboratory's QC discussion and the surrogate spike recoveries are reported with the analytical results on pages in Appendix C to Attachment A. Alliance reports, and Mr. Weeks confirmed by inspection of the laboratory data sheets, that internal standard surrogate recoveries for tetra to hexa-substituted congeners ranged from 50 to 123 percent as compared to the target objective of 40 – 130%. The internal standard surrogate recoveries for hepta to octa-substituted congeners ranged from 88 to 116 percent as compared to the target objective of 25 – 130%.

Further, the sampling surrogate recoveries for tetra, penta, hexa, and hepta-substituted ranged from 101 to 141% as compared to the target QC criteria of 40 – 130%. The Run 2 backhalf sampling surrogate C13-2,3,4,7,8-Penta CDF was the sole sampling surrogate that exceeded the target QC criteria at 141%. The laboratory reported that the excessive recovery was due to a matrix interference. Thus, the mass of penta-CDF reported by the laboratory may be biased high by a minor quantity. This exception to the QC target criterion does not compromise the results because although the recovery of penta-CDF is biased high, the stack concentrations are still below the regulatory standard.

The precision QC criterion (<50%) was met for the internal standards with the precision of the front half (FH) internal standards demonstrating a 21% relative standard deviation (RSD) and the back half internal standards demonstrating a 26% RSD. Likewise, the precision of the sampling surrogates met the QC criterion of < 50% with a 10% RSD. (Recall that sampling surrogates are not added to the front half of the dioxin/furan sampling train.)

Finally, the mass of dioxin and furan stated on the laboratory certificate matches the mass of dioxin and furan used by Alliance to calculate the concentration of dioxin and furan in the stack gas. Mr. Weeks' independent review of the data confirms the results reported by Alliance.

4.5.7 Stack Gas – Continuous Emissions Monitoring Data

Mr. Weeks conducted an independent review of the calibration data for continuous emissions monitoring (CEM) data contained in the Alliance report and those records that demonstrate calibration of the Future Fuel CEMs. The Alliance data was used to measure the oxygen and carbon dioxide concentration in the stack gas for the purpose of emission calculations and THC concentration. The calibration data is contained Appendix D to Attachment A.

Mr. Weeks also conducted an independent review of the calibration data for continuous emissions monitoring (CEM) data for the FFCC CEMs. The FFCC CEMs analyzers were used to demonstrate compliance with the CO standard. The FFCC calibration records are contained in Attachment C to the CPT Report.

The Alliance O₂/CO₂ CEMs was calibrated daily and demonstrated values ranging from 0.0 to 0.5% of span. This difference is less than the 2% criterion required by the method. Likewise, the bias ranged from 0.0 to 0.8% of span (which is less than the 5% criterion required by the method) and the drift ranged from 0.0 to 0.3% of span (which is less than the 3% criterion required by the method.) The Alliance THC analyzer demonstrated daily calibration ranging from 0.0 to 1.3% of the Protocol gas concentration, which is less than 5% criterion; and the drift was measured at 0.0 to 0.1% which is less than the 3% of span required by the method.

The data from the October 15, 2010 RATA for the FFCC CEMs was also reviewed. The RATA data showed that the CO CEMs demonstrated a 0% difference between the reference method data and the FFCC CEMs, which is within the performance criterion of $\leq 5\%$. The O₂ CEMs demonstrated a 0.1% difference, which is less than the performance criterion of $\pm 1\%$. The CO daily calibration drift during the test ranged from 0 to 2.5% of span, which is less than the 5% criterion in the performance specification, and the O₂ monitor demonstrated no difference between the reference gas and the monitor response. Thus, the FFCC CEMs provided good data that can be used to evaluate compliance with the CO standard. (The daily calibration drift data for the FFCC CEMs is provided in Attachment C to the CPT report.)

4.5.8 Waste-Volatile Organics

The QAPP does not identify specific QA/QC objectives for the waste sampling and analytical procedures. However, the laboratory reported the results of the QC measurements collected during the analysis of these samples. Mr. Weeks reviewed this data in order to ensure the overall quality of the project data. The laboratory's analytical data and QC report for the waste analyses is contained in Attachment D. No anomalies were identified from the review of the data. One QA test that was implemented for the test was the collection of duplicate field samples during Run 2. The sample results for the high-BTU organic waste exhibited a chlorobenzene

concentration of 3.7% whereas the field duplicate exhibited a concentration of 3.9%. The relative percent difference (RPD) between the two values is -5.4%, which demonstrates good agreement. Likewise, the sample results for the low-BTU aqueous waste demonstrated a concentration of 1.0 mg/kg whereas the field duplicate exhibited a concentration of 1.1 mg/kg, which shows a RPD of -10%.

The laboratory also ran an internal batch duplicate analyses using the Run 1 sample material for the organic waste and Run 2 sample material for the aqueous waste. The laboratory RPD for the organic waste and aqueous waste was 6.04% and 8.05%, respectively. The toluene-d8 surrogate recoveries for these laboratory quality control samples ranged from 102 to 106%. Thus, RME concludes from this review that the concentration of chlorobenzene in the waste samples used to calculate DRE are accurate and precise.

4.5.9 Waste Feed-Non-Organics

Similar to the volatile organics, the QAPP does not identify specific QA/QC objectives for the metals, chloride, and other non-organic waste sampling and analytical procedures. However, the laboratory reported the results of the QC measurements collected during the analysis of these samples. Mr. Weeks reviewed this data in order to ensure the overall quality of the project data. The laboratory's analytical data and QC report for the waste analyses is contained in Attachment D. No anomalies were identified from the review of the data. One QA test that was implemented for the test was the collection of duplicate field samples during Run 2. The results of the field duplicate analysis are summarized in the following chart.

Parameter	Chromium	Lead	Mercury	Chloride	Specific Gravity	Heat Content	Ash
Organic Waste							
	mg/kg	mg/kg	mg/kg	%	NA	BTU/lb	%
R2 Sample	<0.7	<4	<0.1	25	1.02	13,000	0.006
Field Dup.	<0.7	<4	<0.1	24	1.01	13,000	<0.001
RPD	0%	0%	0%	4%	0.98%	0%	83.3%
Matrix Spike Recovery	95.8%	87.9%	NA	NA	NA	NA	NA
Matrix Spike Dup. Recovery	95.5%	87.6%	NA	NA	NA	NA	NA
RPD	-0.256%	-0.479%	NA	NA	NA	NA	NA
Aqueous Waste							
	mg/L	mg/L	mg/L	mg/L		BTU/lb	%
R2 Sample	<0.007	<0.04	<0.1	78,000	1.09	<200	12
Field Dup.	<0.007	<0.04	<0.1	78,000	1.09	<200	12
RPD	0%	0%	0%	0%	0%	0%	0%
Lab Sample	NA	NA	<0.1	15	1.09	3,800	12
Lab Dup.	NA	NA	<0.1	14	1.09	3,800	12

Parameter	Chromium	Lead	Mercury	Chloride	Specific Gravity	Heat Content	Ash
RPD	NA	NA	0%	6.7%	0%	0%	0%
Matrix Spike Recovery	101%	98.9%	86.0%	NA	NA	NA	NA
Matrix Spike Dup. Recovery	103%	100%	88.0%	NA	NA	NA	NA
RPD	1.84%	1.08%	2.30%	NA	NA	NA	NA

The results show that there is little to no difference between the sample and the field duplicate sample results with the exception of the ash content of the organic waste. However, given the minor amounts of ash present in the organic waste, this difference is not significant as the preponderance of the ash in the waste feed was derived from the aqueous waste. The ash content in the aqueous waste (12%) is thousands of times greater than the ash content in the organic waste (<0.001 to 0.006%). Thus, the analytical difference does not affect the feed rate limits derived from the CPT.

The MS/MSD recoveries for the metals are good and consistent with the internal laboratory QC limits, and the RPD between the MS/MSD recoveries is very small. The laboratory's QC measurements demonstrate good accuracy and precision in the waste feed sampling. Thus, the waste feed analytical results are not biased either high or low for metals other non-organic waste feed constituents.

4.5.10 Process Instruments

The process instrumentation was calibrated or checked prior to the CPT. The result of the calibrations and checks is summarized in the chart below.

Instrument	Tag No.	Difference Between Reference Value and Measured Value	FFCC Performance Standard (±)
Organic Waste Feed Gun Flow Monitor	FT-20153	0.87565%	2%
Organic Waste Feed Gun Flow Monitor	FT-20155	0.50175%	2%
Organic Waste Feed Gun Flow Monitor	FT-20156	1.95508%	2%
Aqueous Waste Feed Ring Flow Monitor	FT-20157	-1.28320%	2%
Aqueous Waste Feed Ring Flow Monitor	FT-20355	1.27455%	2%
Combustion Air Flow Rate Pressure	FT-20180	0 – 0.3%	2%
Atomization Air Pressure	PSL-20270	0.67 – 1.0%	2.5%

Instrument	Tag No.	Difference Between Reference Value and Measured Value	FFCC Performance Standard (±)
to Organic Waste Feed Gun			
Atomization Air Pressure to Organic Waste Feed Gun	PSL-20271	0%	2.5%
Atomization Air Pressure to Organic Waste Feed Gun	PSL-20272	0%	2.5%
Atomization Air Pressure to Aqueous Waste Ring Nozzles	PSL-20137	0.34%	2.5%
Combustion Chamber Temperature Thermocouple	TT-20182	0 – 0.06%	3%
Combustion Chamber Temperature Transmitter	TT-20183	0.02 – 0.05%	3%
Scrubber Differential Pressure	PT-20036	-0.06 – 0.25%	0.5%
Scrubber Differential Pressure	PT-20114	0%	0.5%
Scrubber Water pH	AIT-20043	-0.4 – 1.25%	3%
Scrubber Water pH	AIT-20044	0%	3%
Scrubber Water Blow down Flow Transmitter	FT-20012	0 – 0.25%	3%
Scrubber Tank Level Monitor	LT-20049	0.86 – 1.6%	2%
Scrubber First Stage Flowrate	FT-20034	-0.6 – 1.8%	3%
Scrubber Second Stage Flowrate	FT-20032	0%	3%

The calibration of all the process monitoring instruments was consistent with the FFCC performance specifications and the data can be used to develop quality operating parameter limits.

4.5.11 Conclusion

The Independent QA Review determined that the sampling and analysis was completed in accordance with the data quality objectives established for the project. Mr. Weeks opined that the data is of sufficient quality to demonstrate compliance with the standards and develop operating parameter limits.

5.0 Comparison of Test Results with Regulatory Compliance Limits

This section compares the test results of the CPT, conducted October 12-14, 2010, with regulatory compliance limits established by the MACT Combustion Rule. Table 13.0 demonstrates that FFCC hazardous waste incinerator is in full compliance with the 40 CFR 63, Subpart EEE revised emission standards for hazardous waste incinerators.

5.1 Regulatory Requirements for the CPT

The regulatory requirements to discuss from the CPT are:

- Destruction Removal Efficiency (DRE)
- Particulate Emissions
- HCl / Cl₂ Emissions
- Mercury Emissions
- Semi-Volatile Metals Emissions
- Low-Volatile Metals Emissions
- Dioxin/Furan Emissions
- Carbon Monoxide Emissions
- Total Hydrocarbon Emissions

5.1.1 Destruction Removal Efficiency

40 CFR 63.1203(c) requires existing hazardous waste incinerators to achieve a destruction removal efficiency (DRE) of 99.99% during the CPT for each principal organic hazardous constituent (POHC) designated in the waste feed. FFCC was able to make this demonstration during the CPT. The average DRE measured e CPT was 99.99996%.

Table 16.0 summarizes the DRE during each run of the CPT. Additional quantitative and qualitative analysis can be found in Attachment A – Stack Test Report. The POHC emission rate and feed rates can be seen in Table 8.0 and Table 9.0.

5.1.2 Particulate Emissions

40 CFR 63.1203(a)(7) requires existing hazardous waste incinerators to not emit particulate matter in excess of 0.013 grains per dry standard cubic foot (gr/dscf) after correction to a stack gas concentration of 7% oxygen. FFCC's incinerator emitted an average of 0.0042 gr/dscf at 7% oxygen during the compliance test. A summary of the particulate emission results can be found in Table 8.0 and in Attachment A.

5.1.3 HCl/Cl₂ Emissions

40 CFR 63.1203(a)(6) requires existing hazardous waste incinerators to not emit hydrogen chloride and chlorine gas (HCl/Cl₂) in excess of 32 parts per million by volume (ppmv) after correction to a stack gas concentration of 7% oxygen. FFCC's incinerator emitted an average 10.0 ppmv HCl/Cl₂ at 7% oxygen during the CPT. A summary of the HCl/Cl₂ emission results can be found in Table 8.0 and in Attachment A.

5.1.4 Mercury Emissions

40 CFR 63.1203 (a)(2) requires existing hazardous waste incinerators to not emit mercury in excess of 130 micrograms per dry standard cubic meter (ug/dscm) after correction to a stack gas concentration of 7% oxygen. FFCC's incinerator mercury emissions were nondetect. The average detection limit was 1.3 ug/dscm at 7% oxygen during the CPT. A summary of the mercury emission results can be found in Table 8.0 and in Attachment A.

5.1.5 Semi-Volatile Metals Emissions

40 CFR 63.1203(a)(3) requires existing hazardous waste incinerators to not emit semi-volatile metals in excess of 230 micrograms per dry standard cubic meter (ug/dscm) after correction to a stack gas concentration of 7% oxygen. FFCC's incinerator emitted an average of 224.8 ug/dscm at 7% oxygen during the CPT. A summary of the semi-volatile metal emission results can be found in Table 8.0 and in Attachment A.

5.1.6 Low-Volatile Metals Emissions

40 CFR 63.1203(a)(4) requires existing hazardous waste incinerators to not emit low-volatile metals in excess of 92 micrograms per dry standard cubic meter (ug/dscm) after correction to a stack gas concentration of 7% oxygen. FFCC's incinerator low-volatile emissions were non-detect in the stack gas. The average detection limit was 65.5 ug/dscm at 7% oxygen during the CPT. A summary of the low-volatile metal emission results can be found in Table 8.0 and in Attachment A.

5.1.7 Dioxin/Furan Emissions

40 CFR 63.1203(a)(1)(ii) requires existing hazardous waste incinerators to not emit dioxin and furans in excess of 0.40 toxicity equivalents per dry standard cubic meter (TEQ/dscm) after correction to a stack gas concentration of 7% oxygen. FFCC's incinerator emitted an average of 0.0032 TEQ/dscm at 7% oxygen during the CPT. A summary of the dioxin/furan emission results can be found in Table 8.0 and in Attachment A.

5.1.8 Carbon Monoxide Emissions

40 CFR 63.1203(b)(5)(i) requires existing hazardous waste incinerators to not emit carbon monoxide (CO) in excess of 100 parts per million by volume (ppmv) after correction to a stack gas concentration of 7% oxygen. FFCC's incinerator emitted an average 1.2 ppmv at 7% oxygen during the CPT. A summary of the CO emission results can be found in Table 9.0.

5.1.9 Total Hydrocarbon Emissions

40 CFR 63.1203(b)(5)(i) requires existing hazardous waste incinerators to not emit total hydrocarbons (THC) in excess of 10 parts per million by volume (ppmv) after correction to a stack gas concentration of 7% oxygen. FFCC's incinerator emitted an average 2.2 ppmv at 7% oxygen during the CPT. A summary of the THC emission results can be found in Table 8.0 and the average THC emission result can be seen in Table 9.0.

6.0 Procedures and Limitations for Operating Parameters

This section describes the operating parameter limits (OPL) and how they were established. This section also describes waste, chloride, ash and metal feed rate limits and how they are determined. Table 14.0 summarizes the operating limits established by the CPT.

6.1 Waste Feed Rate Limitations

The maximum hazardous waste feed rate will be based on an hourly rolling average (HRA). All constituent specific feed rate limits (e.g. chloride, LVM) will be based on a 12-hour HRA. Table 17.0 summarizes the waste feed rate data by run. The process data upon which Table 17.0 is based can be found in Attachment E-5.

6.1.1 Maximum Hazardous Waste Feed Rate Limit

FFCC established a maximum hazardous waste feed rate limit based on the average of the test run averages from the CPT. This limit will be an hourly rolling average (HRA) limit of 15,348 lb/hr. The test run averages can be seen in Table 9.0.

6.1.2 Maximum Chloride Feed Rate Limit

FFCC established a maximum chloride feed rate limit based on the average of the test run averages from the CPT. The concentration of chloride in the waste, along with the waste feed rate, was used to determine the limit. This limit will be a 12-hour hourly rolling average (HRA) limit of 1,428 lb/hr. The test run averages can be seen in Table 9.0.

6.1.3 Maximum Ash Feed Rate Limit

FFCC established a maximum ash feed rate limit based on the average of the test run averages from the CPT. The concentration of ash in the waste, along with the waste feed rate, was used to determine the limit. This limit will be a 12-hour hourly rolling average (HRA) limit of 1,453 lb/hr. The test run averages can be seen in Table 9.0.

6.1.4 Metals Feed Rate Limits

Metals feed rate limits were also determined during the CPT. A combination of methods was used to develop the metal feed rate limits. The final feed rate limits determined from the CPT are summarized in Table 14.0.

6.1.4.1 Maximum Mercury Feed Rate

The maximum mercury feed rate limit is based on the maximum theoretical emission concentration (MTEC). MTEC was chosen to develop this feed rate limit because mercury was not present in the waste.

To develop the MTEC feed rate limit, FFCC used the combustion air correlation curve to determine the stack gas flow rate at the maximum combustion air flow rate demonstrated during the CPT. The MACT EEE mercury emission standard was used to calculate the maximum mercury feed rate limit. FFCC used only 90% of the feed rate calculated using MTEC in order to establish the maximum feed rate limit. This calculation is shown in Table 15.0.

6.1.4.2 Maximum Semi-Volatile Metals Feed Rate

FFCC established a maximum semi-volatile metal (SVM) feed rate limit based on the average of the test run averages from the CPT. The amount of SVM spiked and the SVM content of the waste was used to determine the limit. This limit will be a 12-hour hourly rolling average (HRA) limit of 0.84 lb/hr. The test run averages can be seen in Table 9.0.

6.1.4.3 Maximum Low Volatile Metals Feed Rate

FFCC established a maximum low-volatile metal (LVM) feed rate limit based on the average of the test run averages from the CPT. The amount of LVM spiked and the LVM content of the waste was used to determine the limit. This limit will be a 12-hour hourly rolling average (HRA) limit of 1.62 lb/hr. The test run averages can be seen in Table 9.0.

6.2 Combustion Chamber Limitations

The operating parameter limits are summarized in Table 14.0. Table 17.0 summarizes the OPL data by run. A combination of methods was used to develop the combustion chamber limits. The limits were established as either maximums or minimums depending on the parameter. Process data was used when required and manufacturing and design data was used when necessary. The process data from each run is provided in Attachment E-5.

6.2.1 Minimum Combustion Chamber Temperature Limitation

FFCC established a minimum combustion chamber temperature limit based on the average of the test run averages from the CPT. This limit will be an hourly rolling average (HRA) limit of 1,558 deg F. The test run averages can be seen in Table 9.0.

6.2.2 Minimum Atomization Pressure Limitation

FFCC established a minimum atomization pressure limit based on the manufacturer's design of the atomization nozzles. The nozzles for the high-btu waste are referred to as the "main guns", and the nozzles for the low-btu waste are referred to as the "ring nozzles". The limit for the main guns will be an instantaneous limit of 30 psig, and the limit for the ring nozzles will be an instantaneous limit of 30 psig. These are based on system design.

6.2.3 Maximum Furnace Pressure Limitation

FFCC established a maximum furnace pressure limit at 90% of the system's combustion zone design pressure. The design pressure of the oxidizer is 222 inches water column (in. w.c.). This can be seen in drawing 6M10-4V-033. Ninety percent of this design pressure is 200 in. w.c., so the limit for the furnace pressure will be an instantaneous limit of 200 in. w.c.

6.2.4 Maximum Flue Gas Flow Rate Limitation

FFCC established a maximum flue gas flow rate limit based on a correlation of flue gas flow rate to the average of the test run average combustion air flow rate recorded during the CPT. The correlation can be seen in Attachment E-3. This limit will be an hourly rolling average (HRA) limit of 21,106 scfm. The test run average combustion air flow rate can be seen in Table 9.0.

6.3 Air Pollution Control Limitations

The operating parameter limits for the air pollution control devices are summarized in Table 14.0, and Table 17.0 summarizes the OPL data by run. The limits are calculated as the average of the test run average measurements collected from each of the process monitoring instruments during the CPT. The limits were established as either maximums or minimums depending on the parameter. The process data from each run are provided in Attachment E-5.

6.3.1 Minimum Pressure Drop Across the Scrubber

FFCC established a minimum pressure drop across the scrubber limit based on the average of the test run averages from the CPT. The minimum differential pressure measurement was established due to its relationship to particulate, metals and HCl/Cl₂ removal efficiency. This parameter indirectly measures gas/liquid contact, which controls removal of sub-micron particulate and acid gases. This limit will be an HRA limit of 71 in. w.c. The test run averages can be seen in Table 9.0

6.3.2 Minimum Scrubber pH

FFCC established a minimum scrubber pH limit based on the average of the test run averages from the CPT. The minimum scrubber water pH was established to ensure the scrubbing system's ability to neutralize acid gases and meet the HCl/Cl₂ MACT EEE emission standard. This limit will be an HRA limit of 4.4 pH. The test run averages can be seen in Table 9.0

6.3.3 Minimum Quench Tank pH

Originally FFCC did not plan any quench tank limitations, but during the CPT FFCC decided that the pH of the Quench tank could have an impact on the system's ability to remove HCl/Cl₂ from the stack gas. Therefore FFCC decided to establish a minimum pH on the rapid quench water. The limit is established as the average of the test run average measurements collected during the CPT. This limit will be an HRA limit of 0.6 pH. The test run averages can be seen in Table 9.0

6.3.4 Minimum Water Flow Rate to 1st Stage Scrubber

FFCC established a minimum water flow rate to 1st stage scrubber limit based on the average of the test run averages from the CPT. The minimum scrubber water flow rate measurement, to the 1st stage scrubber, is established as an alternative to feed pressure, which is preferred in the MACT standard. Flow is more crucial to the performance of the specific scrubber to be operated at FFCC. This limit will be an HRA limit of 477 gpm. The test run averages can be seen in Table 9.0

6.3.5 Minimum Water Flow Rate to 2nd Stage Scrubber

FFCC established a minimum water flow rate to 2nd stage scrubber limit based on the average of the test run averages from the CPT. The minimum scrubber water flow rate measurement, to the 2nd stage scrubber, is established as an alternative to feed pressure, which is preferred in the MACT standard. Flow is more crucial to the performance of the specific scrubber to be operated at FFCC. This limit will be an HRA limit of 301 gpm. The test run averages can be seen in Table 9.0

6.3.6 Minimum Scrubber Blowdown Flow Rate

FFCC established a minimum scrubber blowdown rate limit based on the average of the test run averages from the CPT. The minimum scrubber blowdown rate measurement is established as the parameter to control solids build up in the scrubbing medium. This limit will be an HRA limit of 100 gpm. The test run averages can be seen in Table 9.0

6.3.7 Minimum Scrubber Recirculation Tank Volume

FFCC established a minimum scrubber recirculation tank volume limit based on the average of the test run averages from the CPT. The minimum scrubber tank volume will be proposed in conjunction with the minimum scrubber blowdown rate to control solids build up in the scrubbing medium. This limit will be an HRA limit of 72%. The test run averages can be seen in Table 9.0

6.4 Stack Gas Limitations

The only stack gas OPL is carbon monoxide and that limit is set by regulation. The regulatory limit for CO in the stack gas is 100 ppmv corrected to 7% oxygen. The test run average CO can be seen in Table 9.0.

7.0 CPT Conditional Approval Items

This section discusses the issues the agency requested be addressed as part of their approval to conduct the CPT.

7.1 Quality Assurance Project Plan (QAPP)

The agency requested two additions to the QAPP. A signature page and a HW Combustion table summary.

7.1.1 Signature Page

FFCC created a QAPP Signature page and distributed to all key personnel for signatures. It is located in the QAPP which can be found in Attachment B.

7.1.2 Hazardous Waste Combustion Table

FFCC created and added a table to the QAPP in the format requested by the EPA. This table is located in the QAPP, and the QAPP is located in Attachment B.

7.2 Combustion Zone Pressure

The agency requested several additional requirements for positive pressure units. Since the incinerator is a positive pressure unit, FFCC will address these requests.

7.2.1 Combustion Zone Design and Maintenance

7.2.1.1 Manufacturer's Design

The manufacturer's design combustion zone pressure is 222 in. w.c. or 8 psig. This is shown in Drawing 6M10-4V-033. The maximum design pressure of the seal between the combustion zone and the rapid quench is 276 in. w.c. or 10 psig. This is shown in Drawing 6M10-4E-050.

7.2.1.2 Maintenance Process for Seals

The manufacturer provided no recommendation for maintenance or replacement of the seals in the combustion zone. FFCC maintains all of the equipment in its area. The incinerator is inspected daily for signs of corrosion, leaks and other concerns. The incinerator is also inspected monthly for potential flue gas leaks using an infrared camera. Most of the seals are not readily accessible when the unit is operating. Any time the incinerator is taken down and cooled, maintenance inspects all seals for functionality. If any seal or gasket appears to need repair, then FFCC will replace the seal.

7.2.1.3 Maintenance/Replacement History for Seals

FFCC has not maintained a historical documentation of seals that it has replaced in the past. FFCC will begin maintaining a history of seal repairs and maintain that documentation in the operating record.

7.2.2 Combustion Zone Inspection Program

FFCC currently visually inspects the incinerator daily to identify leaks, spills, fugitive emissions, and /or signs of deterioration that could lead to any of those events. FFCC has added a monthly inspection using an infrared camera to inspect the combustion zone for potential flue gas leaks. An infrared inspection record can be seen in Attachment F. The inspection in Attachment F was conducted during the CPT.

7.2.3 Recordkeeping

FFCC maintains records of its daily visual inspection, including leaks and corrective actions, in its operating record for a minimum of three years. FFCC will also maintain the results of the monthly infrared camera flue gas inspection as well.

7.2.4 Response to Leaks

If any inspection reveals a leak of combustion gases from the combustion zone, FFCC will cutoff the hazardous waste feed and repair the leak before burning hazardous waste again. A flue gas leak will be considered any leak of combustion gases from the combustion zone with a carbon monoxide (CO) concentration greater than 100 ppm, or volatile organic compound (VOC) emissions greater than 500 ppm above background.

7.3 General Pending Comments

The agency made several general comments on various issues involving the combustion facility.

7.3.1 Feedstream Analysis Plan

The agency was concerned with the frequency of analysis for the fatty acid stream due to its concentration of chromium. FFCC will not combust the Fatty Acid stream shown in Table 1.0 in its onsite incinerator, until FFCC demonstrates to its Title V permitting authority that its sampling frequency has sufficient confidence and power to ensure that emission standards are not exceeded.

7.3.2 CO CEMS Range

The facility CO CEMS has two ranges, a low range with a span of 200 ppmv and a high range with a span of 3000 ppmv at an oxygen correction factor of 1.

7.3.3 Combustion Air and Flue Gas Flow Correlation

See Attachment E-3 for the flue gas flow correlation and its discussion.

8.0 Statement of Compliance

Based on my inquiry of the person or persons who manage the system, or those persons directly responsible for gathering the information, the information submitted is, to the best of my knowledge and belief, true, accurate, and complete.

The information contained in the notification establishes the operating controls and limits that ensure that the waste incinerator located at the FutureFuel Chemical Company located in Batesville, Arkansas is in compliance with all the applicable emission standards of 40 CFR 63, Subpart EEE.

Signed this 11th day of January 2011.



Sam Dortch
Senior Vice President and General Manager
FutureFuel Chemical Company

Tables

Table 1 – Feed Stream Analysis Data

Table 2 – Feed Stream Characteristics

Table 3 – Summary of Sampling and Analysis Program

Table 4 – Process Monitoring Instruments

Table 5 – Process Monitoring Instruments, Calibration, and Maintenance

Table 6 – CPT Process Feed Analytical Results

Table 7 – CPT Spiking Information

Table 8 – CPT Stack Gas Analytical Results

Table 9 – CPT Test Averages

Table 10 – CPT Comparison of Planned Conditions to Actual Conditions - Run 1

Table 11 – CPT Comparison of Planned Conditions to Actual Conditions - Run 2

Table 12 – CPT Comparison of Planned Conditions to Actual Conditions - Run 3

Table 13 – Demonstration of Compliance

Table 14 – Summary of Operating Parameter Limits

Table 15 – Mercury MTEC Feed Rate Limit

Table 16 – Destruction Removal Efficiency

Table 17 – CPT Operational Data Summary

TABLE - 1.0
FEED STREAM ANALYSIS DATA

40 CFR 63.1207(f)(1)(i)

Feed Stream *	Average Heat Value (Btu/lb)	Low-Volatile Metals (Avg)			Semi-Volatile Metals (Avg)		Mercury (Avg)	Other Metals (Avg)				Avg Cl %	Avg Ash %	Physical Form	
		As ppm	Be ppm	Cr ppm	Cd ppm	Pb ppm		Hg ppm	Sb ppm	Ba ppm	Ag ppm				Tl ppm
Process Intermediate Waste	12,000	BDL	BDL	5	BDL	BDL	BDL	BDL	BDL	BDL	BDL	BDL	BDL	<1	Liquid
Fatty Acid Waste	12,000	BDL	BDL	106	BDL	BDL	BDL	BDL	BDL	BDL	BDL	BDL	BDL	<2	Liquid
Organic Process Waste	9,500	BDL	BDL	2	BDL	BDL	<0.1	BDL	<0.5	BDL	BDL	BDL	BDL	<3	Liquid
Spent Solvent Waste	11,000	BDL	BDL	1	BDL	1	BDL	BDL	BDL	BDL	BDL	BDL	BDL	<2	Liquid
Aqueous Waste	1,500	BDL	BDL	BDL	BDL	BDL	BDL	BDL	0.26	BDL	BDL	BDL	BDL	12	Liquid
Liquid Auxiliary Fuel	18,600	BDL	BDL	BDL	BDL	BDL	BDL	BDL	BDL	BDL	BDL	BDL	BDL	<1	Liquid
River Water	0	BDL	BDL	BDL	BDL	BDL	BDL	BDL	BDL	BDL	BDL	BDL	BDL	<0.001	Liquid
Combustion Air	0	0	0	0	0	0	0	0	0	0	0	0	0	0	Air
Natural Gas Fuel	23,000	0	0	0	0	0	0	0	0	0	0	0	0	0	Gas

BDL = Below Detection Limit (for constituents that are BDL, detection limits are input into the process control system for purposes of compliance monitoring pursuant to 40 CFR 63.1209)

* Fatty Acid Waste will not be burned in the incinerator without Agency approval of the sampling frequency.

TABLE - 2.0
FEED STREAM CHARACTERISTICS

40 CFR 63.1207(f)(1)(ii)

Feed Stream	Constituents and Other Characteristics	Avg %	Max %	Organic Hazardous Air Pollutants ¹	Quantity Burned per Year (lbs)	Waste Codes			
Organic Process Waste	Toluene	12	30	Acetonitrile	500,000 to 2,500,000	F003, D001, D021			
	Water	8	15	Chlorobenzene					
	Methanol	15	50	Phenol					
	Heptane	7	40	Triethylamine					
	IXIB	7	20	Toluene					
	DMAP	2	5	Xylene					
	Acetone	10	40	Formaldehyde					
	Isopropanol	5	30	Methanol					
	Xylene	10	40	MIBK					
	Glycerin	12	40	Ethyl Benzene					
	Other Organics	10	20						
	Spent Solvent Waste	Chlorobenzene	10	40			Acetonitrile	15,000,000 to 20,000,000	F002, F003, F005, D001, D002, D021
		Water	8	20			Chlorobenzene		
		Toluene	20	50			Triethylamine		
Methanol		10	40	Toluene					
IFT Product		2	6	Formaldehyde					
Tars from organic process		14	30	MIBK					
Acetic Acid		25	50	Methanol					
Triethylene Glycol		2	5	Xylene					
o-Dichlorobenzene		1	10	Ethyl Benzene					
Other Organics		8	20						

TABLE - 2.0 (Continued)
FEED STREAM CHARACTERISTICS

40 CFR 63.1207(f)(1)

Feed Stream	Constituents and Other Characteristics	Avg %	Max. %	Organic Hazardous Air Pollutants	Quantity Burned per Year (lbs)	Waste Codes
Process Intermediate Waste	Chlorobenzene	10	30	Chlorobenzene	1,500,000 to 2,500,000	F002, F003, F005, D001, D021
	Acetone	25	50	Toluene		
	Isopropanol	15	30	Xylene		
	Heptane	15	30			
	Xylene	10	30			
	Toluene	15	30			
	Other organics	10	15			
Fatty Acid Waste ²	Nonanoic Acid	98	100	None	1,000,000 to 1,500,000	D007
	Octanoic Acid	1	2			
	TXIB	1	2			
Natural Gas Auxiliary Fuel	Natural Gas	100	100	Methane	0 to 100,000	None
1,4 Dioxane Waste	Water	98.9	99.5	Benzene	2,000 to 5,000	D018
	NaOH	1	2	1,4-Dioxane		
	1,4-Dioxane	0.04	0.1			
	Benzene	0.04	0.1			

TABLE -2.0 (Continued)

FEED STREAM CHARACTERISTICS

40 CFR 63.1207(f)(1)

Feed Stream	Heat Value (Btu/lb)	Constituents and Other Characteristics	Avg %	Max %	Organic Hazardous Air Pollutants	Quantity Burned per Year (lbs)	Waste Codes
Aqueous Waste	1,000 to 4,000	Water	65	95	Acetonitrile	35,000,000 lbs	D001, D002, D021
		Sodium Chloride	4	10	Chlorobenzene		
		Sodium Sulfate	3	5	Toluene		
		Methanol	4	8	Phenol		
		Acetone	4	8	Hydrogen Chloride		
		Propionic Acid	3	6	Phenol		
		Dimethyl Sulfoxide	2	5			
		N,N-dimethylacetamide	1	4			
		Glycerin	5	20			
		Ethyl Acetate	<1	1			
		Isopropanol	2	5			
		Toluene	<1	1			
		Chlorobenzene	<1	1			
		TXIB (CAS# 6846-50-0)	<1	1			
		Hydrogen Chloride	<1	1			
Potassium Chloride	<1	1					
Sulfuric Acid	<1	1					
Liquid Auxiliary Fuel	13,000 to 16,000	Diesel	30	95	Benzene	50,000 to 700,000	None
		Diisopropyl Benzene Derivatives	65	95			
		Triisopropyl Benzene Derivatives	5	15			

TABLE -2.0 (Continued)
FEED STREAM CHARACTERISTICS

40 CFR 63.1207(f)(1)

Feed Stream	Heat Value (Btu/lb)	Constituents and Other Characteristics	Avg %	Max %	Organic Hazardous Air Pollutants	Quantity Burned per Year (lbs)	Waste Codes
River Water	0	Water	100	100	None	1,000,000 to 10,000,000	None

Notes:

- Btu = British Thermal Unit
- Btu/lb = British Thermal Unit per pound
- ppm = Parts per million
- wt.% = Weight production

¹ Only those organic HAPs that may be potentially present in the waste are reported in Table 3.0. All other organic HAPs are not present based on on-site material use and process chemistry evaluations.

² Fatty Acid Waste will not be combusted in the incinerator without Agency approval of the sampling frequency.

TABLE – 3.0
SUMMARY OF SAMPLING AND ANALYSIS PROGRAM

40 CFR 63.1207(D)(1)(iv)

Sample No./Type	Parameters	Sampling Method	Sample Frequency	Field QA/QC Samples	Analytical Methods
1) Liquid Organic and Aqueous Waste	Specific Gravity	Grab, 4 oz. collected at each sample interval (Two composites prepared for each run)	Every 30 minutes, each run	None	ASTM D-891 or other approved method
	Ash			None	ASTM D-482 or other approved method
	Chlorine			None	SW-846 9076 or other approved method
	Heat Value			None	ASTM-D-240 or other approved method
	SVM – Lead			None	ICP-AES (Method 200.7 or 200.8)
	LVM - Chromium			None	ICP-AES (Method 200.7 or 200.8)
	Mercury			None	EPA Method SW-7470A
2) Stack gas metals – MMT	POHC	Grab, 40ml collected at each sample interval	Every 30 minutes, each run	None	Volatile POHC by SW-846 5030b, 8260b
	As, Be, Cd, Cr, Hg, and Pb	Method 29, MMT, isokinetic sample	160 minutes each run	Reagent blanks (filter, probe rinse solution)	SW-846 6010b and 7470a
3) Stack gas hydrogen chloride, chlorine, and particulate matter – Method 26A sampling train	HCl and Chlorine	Method 26A, isokinetic sample	160 minutes each run	Reagent blanks (H ₂ SO ₄ and NaOH impinger solutions)	Ion Chromatography (SW-9056/9057)
	Particulate matter			None	Gravimetric

TABLE -3.0 (Continued)

SUMMARY OF SAMPLING AND ANALYSIS PROGRAM

40 CFR 63.1207(f)(1)(iv)

Sample No./Type	Parameters	Sampling Method	Sample Frequency	Field QA/QC Samples	Analytical Methods
4) Stack gas volatile organics - VOST	Volatile Organics	Method 0030, VOST train, 4 tube pairs	160 minutes each run	One condensate trip blank One pair VOST tube trip blank One set field blank tubes (four pairs each) per test condition	Purge and trap (SW-0030, 8260/5041); only three tube pairs analyzed. Fourth tube pair archived in case of breakage, etc.
5) Stack gas PCDDs/PCDFs - MM5	PCDDs/PCDFs	Method 0023A	240 minutes each run	One field blank per test condition One train blank per test condition One trip blank resin tube One deionized water reagent blank	Soxhlet extraction, GC/MS (PCDDs/PCDFs by SW-8290, 3540., 0023A.) Lowest detection limits practicable should be achieved.

TABLE – 3.0 (Continued)
SUMMARY OF SAMPLING AND ANALYSIS PROGRAM

40 CFR 63.1207(f)(1)(iv)

Sample No./Type	Parameters	Sampling Method	Sample Frequency	Field QA/QC Samples	Analytical Methods
6) Stack gas	Carbon Monoxide	Continuous, extractive, ORSAT (EPA Method 3)	Each run	None	Continuous Extractive-NDIR, ORSAT Analyzer
	Carbon Dioxide	ORSAT (EPA Method 3)	Each run	None	ORSAT Analyzer
	Total Hydrocarbon	EPA Method 25A	Each Run	None	Continuous, Extractive, Flame Ionization Analyzer
	Oxygen	Continuous, extractive, ORSAT	Each run	None	Continuous Extractive-Paramagnetic; ORSAT Analyzer
	Stack Moisture	EPA Method 4	Each run	None	Measure volume to 0.5 ml
	Stack Velocity and Flowrate	EPA Method 2	Each run	None	Measure temperature, pressure, and volume

TABLE – 3.0 (Continued)

SUMMARY OF SAMPLING AND ANALYSIS PROGRAM

40 CFR 63.1207(f)(1)(iv)

Notes to Table D-5.5:

As	= Arsenic	LVM	= Low-Volatile Metals
ASTM	= American Society for Testing and Materials	ML	= Milliliter
Bc	= Beryllium	M0011	= EPA Method 0011
Btu	= British thermal units	MM5	= Modified Method 5
CVAA	= Cold vapor atomic absorption	MMT	= Multi-metals train
Cd	= Cadmium	NaOH	= Sodium hydroxide
Cr	= Chromium	NDIR	= Nondispersive infrared
GC/MS	= Gas chromatography and mass spectroscopy	PAH	= Polynuclear aromatic hydrocarbon
GC/FID	= Gas chromatography and flame ionization detector	Pb	= Lead
gpm	= Gallons per minute	PCDD	= Dioxin
Hg	= Mercury	PCDF	= Furan
H2SO4	= Sulfuric acid	POHC	= Principal organic hazardous constituents
ICP	= Inductively coupled argon plasma spectroscopy	QA/QC	= Quality assurance and quality control
ICP-AES	= Inductively coupled plasma-atomic emission spectrometry	SVM	= Semi-Volatile Metals
KOH	= Potassium hydroxide	VOST	= Volatile organic sampling train

TABLE – 4.0
PROCESS MONITORING INSTRUMENTS

40 CFR 62.1207(D)(1)(iv)

Parameter	Location	Instrument Number(s)	Type of Instrument	Instrument Range	Expected Operating Range	Accuracy	Drawing Location Reference
Liquid Waste Feed to Organic Waste Guns Flow Monitor	Liquid Waste Lines to Gun Numbers 2, 3, & 4	FT-6M10-20153 FT-6M10-20155 FT-6M10-20156	Coriolis Mass Flow Meter	0 - 100 lb/min	5 - 75 lb/min	+/-2% of calibrated range	6M10-9T-001 6M10-9T-001 6M10-9T-001
Liquid Waste Feed to Aqueous Waste Guns Flow Monitor	Liquid Waste Lines to Ring Nozzles	FT-6M10-20157 FT-6M10-20355	Coriolis Mass Flow Meter	0 - 300 lb/min	30 - 225 lb/min	+/-2% of calibrated range	6M10-9T-002 6M10-9T-002
Combustion Air Flow Rate	Combustion Air Line	FT-6M10-20180	Diff. Pressure w/ Averaging Pitot Array	0 - 17,125 scfm	0 - 15,300 scfm	+/-2% of calibrated range	6M10-9T-007
Atomization Air Pressure to Organic Waste Guns	Plant Air Lines to Organic Waste Guns	PSL-6M10-20270 PSL-6M10-20271 PSL-6M10-20272	Welded Diaphragm Pressure Switch	2 - 50 psig	> 30 psig	Repeatability of +/- 2.5% of Adjustable Range	6M10-9T-009 6M10-9T-009 6M10-9T-009
Atomization Air Pressure to Aqueous Waste Guns	Plant Air Lines to Aqueous Waste Guns	PSL-6M10-20137	Welded Diaphragm Pressure Switch	12 - 100 psig	> 30 psig	Repeatability of +/- 2.5% of Adjustable Range	6M10-9T-002
Combustion Chamber Temperature	Combustion Chamber	TT-6M10-20182 TT-6M10-20183	Thermocouple and Transmitter	0-2200 Deg. F	1500 - 1900 deg. F	Transmitter: +/- 3% of calibrated range Thermocouple: +/- 3% of calibrated range	6M10-9T-002 6M10-9T-002
Carbon Monoxide	CEMS Building	AT-6M10-3269	CEMS Analyzer	0 - 500 ppm 0 - 3000 ppm	20 - 100 ppm	+/- 3 % of calibrated range	6M10-9T-012
Oxygen	CEMS Building	AT-6M10-3270	CEMS Analyzer	0 - 25 %	0 - 25 %	+/- 2% of calibrated range	6M10-9T-012

TABLE – 4.0 (continued)

PROCESS MONITORING INSTRUMENTS

40 CFR 62.1207(D)(1)(iv)

Parameter	Location	Instrument Number(s)	Type of Instrument	Instrument Range	Expected Operating Range	Accuracy	Drawing Location Reference
Scrubber Differential Pressure	Top of Scrubber	PT-6M110-20036 PT-6M110-20114	Pressure Transmitter	0 – 100 " WC	70 – 90 " WC	+/- 0.5 % of calibrated range	6M110-9T-005
Scrubber Water pH Measurement	Scrubber Re-circulation Pump Line to Scrubbers	AT-6M110-20043 AT-6M110-20044	pH Transmitter	0 – 14 pH	4 – 9 pH	+/- 3% of calibrated range	6M110-9T-005
Quench Water pH Measurement	Rapid Quench Weir Tank	AIT-6M110-20016 AIT-6M110-20017	pH Transmitter	0 – 14 pH	0 – 8 pH	+/- 3% of calibrated range	6M110-9T-004
Scrubber Water Blowdown Flow Monitor	Destructor Pad Near Weir Tank Circulation Pumps	FT-6M110-20012	Magnetic Flow Meter	0 – 150 gpm	60-150 gpm	+/- 3% of calibrated range	6M110-9T-004
Scrubber Tank Level Monitor	CD-224 Scrubber Re-circulation Tank	LT-6M110-20049	Pressure Transmitter	0 – 116 " WC	4 – 10 feet	+/- 2% of calibrated range	6M110-9T-006
Scrubber 1 st Stage Flow Rate	CD-223A Scrubber	FT-6M110-20034	Magnetic Flow Meter	0 – 600 gpm	500 – 600 gpm	+/- 3% of calibrated range	6M110-9T-005
Scrubber 2 nd Stage Flow Rate	CD-223B Scrubber	FT-6M110-20032	Magnetic Flow Meter	0 – 450 gpm	300 – 400 gpm	+/- 3% of calibrated range	6M110-9T-005

TABLE – 5.0

PROCESS MONITORING INSTRUMENTS, CALIBRATION, and MAINTENANCE

40 CFR 63.1207(f)(1)(iv)

Parameter	Location	Instrument Number(s)	Inspection/ Calibration Procedure	Calibration Frequency	Preventive Maintenance Procedure	Preventive Maintenance Frequency
Liquid Waste Feed to Organic Waste Guns Flow Monitor	Liquid Waste Lines to Gun Numbers 2, 3, & 4	FT-6M10-20153 FT-6M10-20155 FT-6M10-20156	Calibrate using certified electronic scales	Annual	Inspect During Calibration	Annual, During Calibration
Liquid Waste Feed to Aqueous Waste Guns Flow Monitor	Liquid Waste Lines to Ring Nozzles	FT-6M10-20157 FT-6M10-20355	Calibrate using certified electronic scales	Annual	Inspect During Calibration	Annual, During Calibration
Combustion Air Flow Rate	Combustion Air Line	FT-6M10-20180	Calibrate against standard	Annual	Clean During Calibration	Annual
Atomization Air Pressure to Organic Waste Guns	Plant Air Lines to Organic Waste Guns	PSL-6M10-20270 PSL-6M10-20271 PSL-6M10-20272	Calibrated using a certified pressure standard	Annual	Inspect and Clean During Calibration	Annual
Atomization Air Pressure to Aqueous Waste Guns	Plant Air Lines to Aqueous Waste Guns	PSL-6M10-20137	Calibrated using a certified pressure standard	Annual	Inspect and Check Actuation on Loss of Air Pressure	Annual
Combustion Chamber Temperature	Combustion Chamber	TT-6M10-20182 TT-6M10-20183	Calibrated using certified temperature standard	Annual	Inspect During Calibration	Annual, During Calibration
Scrubber Differential Pressure	Top of Scrubber	PT-6M10-20036 PT-6M10-20114	Calibrated using certified pressure standard	Annual	Inspect During Calibration	Annual, During Calibration
Scrubber Water pH Measurement	Scrubber Recirculation Pump Line to Scrubbers	AT-6M10-20043 AT-6M10-20044	Calibrated using standard pH buffer solution	Quarterly	Inspect During Calibration	Quarterly, During Calibration
Quench Water pH Measurement	Scrubber Recirculation Pump Line to Scrubbers	AIT-6M10-20016 AIT-6M10-20017	Calibrated using standard pH buffer solution	Quarterly	Inspect During Calibration	Quarterly, During Calibration

TABLE – 5.0

PROCESS MONITORING INSTRUMENTS, CALIBRATION, and MAINTENANCE

40 CFR 63.1207(D)(1)(iv)

Parameter	Location	Instrument Number(s)	Inspection/ Calibration Procedure	Calibration Frequency	Preventive Maintenance Procedure	Preventive Maintenance Frequency
Scrubber Water Blowdown Flow Monitor	Destructor Pad Near Weir Tank Circulation Pumps	FT-6M10-20012	Calibrate using certified standard	Annual	Inspect During Calibration	Annual during Calibration
Scrubber Tank Level Monitor	CD-224 Scrubber Recirculation Tank	LT-6M10-20049	Calibrate using certified pressure standard	Annual	Visual Inspection During Calibration	Annual
Scrubber 1 st Stage Flow Rate	CD-223A Scrubber	FT-6M10-20034	Calibrate using certified standard	Annual	Inspect During Calibration	Annual
Scrubber 2 nd Stage Flow Rate	CD-223B Scrubber	FT-6M10-20032	Calibrate using certified standard	Annual	Inspect During Calibration	Annual
Carbon Monoxide	CEMS Building	AT-6M10-3269	Calibrate with known Calibration Gas $\pm 2\%$ Accuracy	Daily Calibration Check with Calibration when Calibration Check Indicates an Error of 15 PPM	Visual Inspection Daily, Clean and Calibrate as Necessary	Daily
Oxygen	CEMS Building	AT-6M10-3270	Calibrate with known Calibration Gas $\pm 2\%$ Accuracy	Daily Calibration Check with Calibration when Calibration Check Indicates an Error of 0.5%	Visual Inspection Daily, Clean and Calibrate as Necessary	Daily

Table 6.0 - CPT Process Feed Analytical Results

Low-Btu Waste Analytical Results			
Constituent	Run 1	Run 2	Run 3
Chlorobenzene (%)	0.00014	0.00010	0.00011
Heating Value (btu/lb)	<200	<200	<200
Specific Gravity	1.09	1.09	1.09
Chloride (mg/L)	80000	78000	79000
Ash (%)	12	12	12
Mercury (mg/L)	0.1	0.1	0.1
SVM (mg/L)	0.040	0.040	0.040
Lead	0.040	0.040	0.040
LVM (mg/L)	0.007	0.007	0.007
Chromium	0.007	0.007	0.007
High-Btu Waste Analytical Results			
Constituent	Run 1	Run 2	Run 3
Chlorobenzene (%)	2.1	3.7	1.7
Heating Value (btu/lb)	11000	13000	10000
Specific Gravity	0.917	1.02	0.905
Chloride (%)	15	25	11
Ash (%)	0.023	0.006	0.48
Mercury (mg/kg)	0.1	0.1	0.100
SVM (mg/kg)	4	4	4
Lead	4	4	4
LVM (mg/kg)	0.7	0.7	0.7
Chromium	0.7	0.7	0.7

Table 8.0 - CPT Stack Gas Analytical Results

Test	Emission	Stack Flow	Concentration Converted to	O2	Concentration Corrected to	Corrected Concentration	Emission Rate
Run	Constituent	DSCFM	ug/dscm	%	at 7% O2	Units	lb/hr
Run 1	POHC	12179	0.61	7.7	NA	ug/dscm	0.000028
	HCl/Cl ₂	12018	8786.51	7.7	6.1	ppmvd	0.395575
	Particulate	12018	7181.22	7.7	0.0034	gr/dscf	0.323304
	Mercury	12288	2.95	7.7	3.1	ug/dscm	0.000136
	SVM	12288	115.26	7.7	121.33	ug/dscm	0.005306
	Cd	12288	0.31	7.7	0.33	ug/dscm	0.000014
	Pb	12288	114.95	7.7	121	ug/dscm	0.005291
	LVM	12288	39.33	7.7	41.4037	ug/dscm	0.001811
	As	12288	0.00	7.7	0	ug/dscm	0.000000
	Be	12288	0.00	7.7	0	ug/dscm	0.000000
	Cr	12288	36.29	7.7	38.2	ug/dscm	0.001671
	DF	12179	0.0000035	7.7	0.0037	ng/dscm	1.60E-10
THC	12179	NA	7.7	3.2	ppmvd	NA	
Run 2	POHC	12064	0.77	6.7	NA	ug/dscm	0.000035
	HCl/Cl ₂	12151	26173.26	6.7	16.9	ppmvd	1.191380
	Particulate	12151	12490.11	6.7	0.0055	gr/dscf	0.568537
	Mercury	12406	0.61	6.7	0.6	ug/dscm	0.000028
	SVM	12406	297.24	6.7	291.0	ug/dscm	0.013814
	Cd	12406	0.00	6.7	0.0	ug/dscm	0.000000
	Pb	12406	297.24	6.7	291	ug/dscm	0.013814
	LVM	12406	77.53	6.7	75.9	ug/dscm	0.003603
	As	12406	0.00	6.7	0	ug/dscm	0.000000
	Be	12406	0.00	6.7	0	ug/dscm	0.000000
	Cr	12288	77.53	6.7	75.9	ug/dscm	0.003569
	DF	12179	0.0000043	6.7	0.0042	ng/dscm	1.96E-10
THC	12179	NA	6.7	1.8	ppmvd	NA	
Run 3	POHC	12092	0.63	7.3	NA	ug/dscm	0.000029
	HCl/Cl ₂	12229	10534.50	7.3	7.1	ppmvd	0.482598
	Particulate	12229	8049.89	7.3	0.0037	gr/dscf	0.368775
	Mercury	12252	0.10	7.3	0.1	ug/dscm	0.000004
	SVM	12252	256.39	7.3	262.0	ug/dscm	0.011767
	Cd	12252	0.00	7.3	0.0	ug/dscm	0.000000
	Pb	12252	256.39	7.3	262	ug/dscm	0.011767
	LVM	12252	77.60	7.3	79.3	ug/dscm	0.003562
	As	12252	0.00	7.3	0	ug/dscm	0.000000
	Be	12252	0.00	7.3	0	ug/dscm	0.000000
	Cr	12288	77.60	7.3	79.3	ug/dscm	0.003572
	DF	12179	0.0000016	7.3	0.0016	ng/dscm	7.14E-11
THC	12179	NA	7.3	1.6	ppmvd	NA	

$$\text{lb/hr Emission Rate} = (\text{Stack Flow dscf/min}) \times (\text{Conc. ug/dscm}) \times (60 \text{ min/hr}) \times (1 \text{ m}^3 = 35.31 \text{ ft}^3) \times (1 \text{ g} = 1,000,000 \text{ ug}) \times (1 \text{ lb} = 453.6 \text{ g})$$

$$\text{ug/dscm} = (11.10 \times 10^6 \text{ L}) \times (\text{g/g-mole}) \times (1,000 \text{ L} = \text{m}^3) \times (1,000,000 \text{ ug/g}) \times (1 \text{ g-mole} = 24.04 \text{ L})$$

$$\text{ug/dscm} = (\text{gr/ft}^3) \times (64.8 \text{ mg/gr}) \times (1,000 \text{ ug/mg}) \times (34.31 \text{ ft}^3 = \text{m}^3) \qquad \text{ug/dscm} = (\text{ng/m}^3) \times (1 \text{ ug} = 1,000 \text{ ng})$$

Table 9.0 - CPT Run Averages

Test Parameters		Planned Conditions	CPT	CPT Run Averages		
Description	Units	Target	Average	Run 1	Run 2	Run 3
Total Waste Feed Rate	lb/hr	16500	15348	14704	15699	15642
Low-Btu Waste Feed Rate	lb/hr	12500	12059	11346	12527	12303
High-Btu Waste Feed Rate	lb/hr	4000	3289	3358	3171	3339
Total POHC Feed Rate	lb/hr	85	82	71	117	57
Total Chloride Feed Rate	lb/hr	1650	1428	1336	1689	1259
Total Ash Feed Rate	lb/hr	1650	1453	1362	1503	1492
Total Mercury Feed Rate	lb/hr	0.002	0.0014	0.0014	0.0015	0.0015
Total SVM Feed Rate	lb/hr	0.65	0.84	0.59	0.96	0.95
Total LVM Feed Rate	lb/hr	1.25	1.62	1.15	1.86	1.84
Combustion Air Flow Rate	scfm	10000	9994	9996	9989	9998
Combustion Temperature	deg F	1500	1558	1544	1588	1544
Scrubber Pressure Drop	in.wc.	70	71	72	72	71
Scrubber Water pH	pH	4	4.3	4.4	4.4	4.2
Quency Tank pH	pH	< 1	0.5	0.6	0.3	0.6
1st Stage Scrubber Flow	gpm	475	476	477	475	475
2nd Stage Scrubber Flow	gpm	350	301	301	300	301
Scrubber Blowdown	gpm	100	100	100	100	101
Recirc Tank Level	%	70%	72	72	71	71
CO Concentration	ppmv	≤ 100	1.2	0	1	3
THC Concentration	ppmv	≤ 10	2.2	3.2	1.8	1.6
Low-Btu Gun Atomization Pressure	psig	30	30	30	30	30
High-Btu Gun Atomization Pressure	psig	20	20	20	20	20

Table 10.0 - CPT Comparison of Planned Conditions to Actual Conditions
Run 1

Test Parameters		Planned Conditions		Actual Conditions			Comparison*
Description	Units	Target	Average	Minimum	Maximum	Comment	
Total Waste Feed Rate	lb/hr	16500	14704	14601	14807	Feed rates not as high as planned	
Low-Btu Waste Feed Rate	lb/hr	12500	11346	11243	11450	Was comfortable with low-btu feed rate during test	
High-Btu Waste Feed Rate	lb/hr	4000	3358	3358	3358	Heating value limited High-btu waste feed rate	
Total POHC Feed Rate	lb/hr	85	71	71	71	Feed rates not as high as planned	
Total Chloride Feed Rate	lb/hr	1650	1336	1329	1344	Feed rates not as high as planned	
Total Ash Feed Rate	lb/hr	1650	1362	1350	1375	Feed rates not as high as planned	
Total Mercury Feed Rate	lb/hr	0.002	0.0014	NA	NA	Feed rates not as high as planned	
Total SVM Feed Rate	lb/hr	0.65	0.59	NA	NA		
Total LVM Feed Rate	lb/hr	1.25	1.15	NA	NA		
Combustion Air Flow Rate	scfm	10000	9996	9751	10223		
Combustion Temperature	deg F	1500	1544	1531	1564	Heating value of high-btu waste created a higher temp	
Scrubber Pressure Drop	in.wc.	70	72	70	75		
Scrubber Water pH	pH	4	4.4	1.7	5.9		
Quench Tank pH	pH	< 1	0.6	0.6	0.6		
1st Stage Scrubber Flow	gpm	475	477	460	535		
2nd Stage Scrubber Flow	gpm	300	301	259	339		
Scrubber Blowdown	gpm	100	100	99	104		
Recirc Tank Level	%	70	72	70	74		
CO Concentration	ppmv	≤ 100	0	0	0		
THC Concentration	ppmv	≤ 10	3.2	NA	NA		
Low-Btu Gun Atomization Pressure	psig	30	30	30	30		
High-Btu Gun Atomization Pressure	psig	20	20	20	20		

* No comment means the difference between the planned and actual conditions were not significant (e.g., < 20%)

Table 11.0 - CPT Comparison of Planned Conditions to Actual Conditions
Run 2

Test Parameters		Planned Conditions		Actual Conditions			Comparison*
Description	Units	Target	Average	Minimum	Maximum	Comment	
Total Waste Feed Rate	lb/hr	16500	15699	15589	15792		
Low-Btu Waste Feed Rate	lb/hr	12500	12527	12426	12629		
High-Btu Waste Feed Rate	lb/hr	4000	3171	3123	3204		
Total POHC Feed Rate	lb/hr	85	117	116	119	See Significant Issues	
Total Chloride Feed Rate	lb/hr	1650	1689	1670	1705		
Total Ash Feed Rate	lb/hr	1650	1503	1491	1516		
Total Mercury Feed Rate	lb/hr	0.002	0.0015	NA	NA		
Total SVM Feed Rate	lb/hr	0.65	0.96	NA	NA	Lead feed rate increased because of need to maximize chromium feed rate.	
Total LVM Feed Rate	lb/hr	1.25	1.86	NA	NA	Adjusted spike rate to maximize chromium feed rate.	
Combustion Air Flow Rate	scfm	10500	9989	9791	10117		
Combustion Temperature	deg F	1500	1588	1546	1601	Higher than anticipated heating value of waste	
Scrubber Pressure Drop	in.wc.	70	72	71	76		
Scrubber Water pH	pH	4	4.4	2.4	5.8		
Quench Tank pH	pH	< 1	0.3	0.2	0.4		
1st Stage Scrubber Flow	gpm	475	475	469	553		
2nd Stage Scrubber Flow	gpm	300	300	291	307		
Scrubber Blowdown	gpm	100	100	92	110		
Recirc Tank Level	%	70%	71	69	73		
CO Concentration	ppmv	≤ 100	0.8	0.0	1.7		
THC Concentration	ppmv	≤ 10	1.8	NA	NA		
Low-Btu Gun Atomization Pressure	psig	30	30	30	30		
High-Btu Gun Atomization Pressure	psig	20	20	20	20		

* No comment means the difference between the planned and actual conditions were not significant (e.g., < 20%)

Table 12.0 - CPT Comparison of Planned Conditions to Actual Conditions
Run 3

Test Parameters		Units	Planned Conditions		Actual Conditions			Comparison* Comment
Description	Target		Average	Minimum	Maximum			
Total Waste Feed Rate	16500	lb/hr	15642	15642	15643			
Low-Btu Waste Feed Rate	12500	lb/hr	12303	12300	12306			
High-Btu Waste Feed Rate	4000	lb/hr	3339	3337	3342			
Total POHC Feed Rate	85	lb/hr	57	57	57		See significant issues	
Total Chloride Feed Rate	1650	lb/hr	1259	1259	1259		See significant issues	
Total Ash Feed Rate	1650	lb/hr	1492	1492	1493			
Total Mercury Feed Rate	0.002	lb/hr	0.0015	NA	NA			
Total SVM Feed Rate	0.65	lb/hr	0.95	NA	NA		Lead feed rate increased because of need to maximize chromium feed rate.	
Total LVM Feed Rate	1.25	lb/hr	1.84	NA	NA		Adjusted spike rate to maximize chromium feed rate.	
Combustion Air Flow Rate	10000	scfm	9998	9837	10264			
Combustion Temperature	1500	deg F	1544	1527	1555			
Scrubber Pressure Drop	70	in.wc.	71	69	74			
Scrubber Water pH	4	pH	4.2	1.5	5.8			
Quench Tank pH	< 1	pH	0.6	0.5	0.6			
1st Stage Scrubber Flow	475	gpm	475	445	516			
2nd Stage Scrubber Flow	300	gpm	301	273	347			
Scrubber Blowdown	100	gpm	101	89	115			
Recirc Tank Level	70%	%	71	70	73			
CO Concentration	≤ 100	ppmv	2.7	1.2	4.2			
THC Concentration	≤ 10	ppmv	1.6	NA	NA			
Low-Btu Gun Atomization Pressure	30	psig	30	30	30			
High-Btu Gun Atomization Pressure	20	psig	20	20	20			

* No comment means the difference between the planned and actual conditions were not significant (e.g., < 20%)

Table 13.0 - Demonstration of Compliance

Test	Units	Standard	CPT Result ²
Destruction Removal Efficiency	%	≥ 99.99%	99.999996%
Particulate Emission ¹	gr/dscf	≤ 0.013	0.0042
HCl/Chlorine Emissions ¹	ppmv	32	10
Mercury Emissions ¹	ug/dscm	≤ 130	1.3
Semi-Volatile Metal Emissions ¹	ug/dscm	≤ 230	224.8
Low-Volatile Metal Emissions ¹	ug/dscm	≤ 92	65.5
Dioxin/Furan ¹	ng/dscm TEQ	0.40	0.0032
Carbon Monoxide Emissions ¹	ppmv	≤ 100	1.2
Total Hydrocarbon Emissions ¹	ppmv	≤ 10	2.2

¹ Results corrected to 7% O₂

² CPT Results are shown as the average of the three runs

Table 14.0 - Summary of Operating Parameter Limits

Operating Parameters	Final Operating Limit	Comment
Waste Feed Limitations		
Maximum Hazardous Waste Feed Rate	lb/hr 15,348	Average of the Test Run Averages
Maximum Chloride Feed Rate	lb/hr 1,428	Average of the Test Run Averages
Maximum Ash Feed Rate	lb/hr 1,453	Average of the Test Run Averages
Maximum Mercury Feed Rate	lb/hr 0.011	90% of MTEC Feedrate based on Maximum Flue Gas Flow Rate
Maximum Semi-Volatile Feed Rate	lb/hr 0.84	Average of the Test Run Averages
Maximum Low-Volatile Feed Rate	lb/hr 1.62	Average of the Test Run Averages
Combustion Chamber Limitations		
Minimum Combustion Chamber Temperature	°F 1,558	Average of the Test Run Averages
Minimum Atomization Pressure (High-Btu)	psig 30	Manufacturer's recommendation for main guns
Minimum Atomization Pressure (Low-Btu)	psig 30	Manufacturer's recommendation for ring nozzles
Maximum Furnace Pressure	in. wc. ≤200	Set at 90% of the system design pressure
Maximum Flue Gas Air Flow Rate	scfm 25,106	Correlated from the Average of the Combustion Air Flow Rate Test Run Averages (See Attachment E-3)
Air Pollution Control Limitations		
Minimum Pressure Drop across Scrubber	in. wc. 71	Average of the Test Run Averages
Minimum Scrubber pH	pH 4.4	Average of the Test Run Averages
Minimum Quench Tank pH	pH 0.6	Average of the Test Run Averages
Minimum 1st Stage Scrubber Flow Rate	gpm 477	Average of the Test Run Averages
Minimum 2nd Stage Scrubber Flow Rate	gpm 301	Average of the Test Run Averages
Minimum Scrubber Blowdown Rate	gpm 100	Average of the Test Run Averages
Minimum Scrubber Recirculation Tank Level	% 72	Average of the Test Run Averages
Stack Gas Limitations		
Maximum Carbon Monoxide Concentration	ppmv 100	MACT Emission Standard

Table 15.0 - Mercury MTEC Feed Rate Limit

Hg Feed Rate Limit (lb/hr) =	$(\text{MACT Limit ug/dscm}) \times (2.204586\text{E-}9 \text{ lb/ug}) \times (\text{Stack Flow dscm/min}) \times (60 \text{ min/hr}) / (1\text{-SRE})$
Hg Feed Rate Limit (lb/hr) =	$(1.30 \text{ ug/dscm}) \times (2.204586\text{E-}9 \text{ lb/ug}) \times (25106 \text{ dscf/min} / 35.31 \text{ dscf/dscm}) \times (60 \text{ min/hr}) / (1-0)$
Hg MTEC Feed Rate Limit (lb/hr) =	0.01223
90% Hg MTEC Feed Rate Limit (lb/hr) =	0.01100

Table 16.0 - Destruction Removal Efficiency

CPT Run	POHC IN lb/hr	POHC OUT lb/hr	DRE POHC
Run 1	71	0.0000278	99.99996%
Run 2	117	0.0000348	99.99997%
Run 3	57	0.00002854	99.99995%
CPT Average			99.99996%

Table 17.0 - CPT Operational Data Summary

CPT Run 1 Summary													
Calculation	Total Waste Feed	Low Btu Waste Feed	High Btu Waste Feed	Combustion Air Flow	Combustion Temperature	Scrubber Pressure Drop	Scrubber Water pH	Quench Tank pH	1st Stage Scrubber Flow	2nd Stage Scrubber Flow	Scrubber Blowdown Flow	Recirc Tank Level	CO Conc.
	lb/hr	lb/hr	lb/hr	scfm	deg F	in.w.c.	pH	pH	gpm	gpm	gpm	%	ppmv
Run 1 Average	14704	11346	3358	9996	1544	72	4.4	0.6	477	301	100	72	0.0
Run 1 Minimum	14601	11243	3358	9751	1531	70	1.7	0.6	460	259	99	70	0.0
Run 1 Maximum	14807	11450	3358	10223	1564	75	6	1	535	339	104	74	0

CPT Run 2 Summary													
Calculation	Total Waste Feed	Low Btu Waste Feed	High Btu Waste Feed	Combustion Air Flow	Combustion Temperature	Scrubber Pressure Drop	Scrubber Water pH	Quench Tank pH	1st Stage Scrubber Flow	2nd Stage Scrubber Flow	Scrubber Blowdown Flow	Recirc Tank Level	CO Conc.
	lb/hr	lb/hr	lb/hr	scfm	deg F	in.w.c.	pH	pH	gal/min	gal/min	gal/min	%	ppmv
Run 2 Average	15699	12527	3171	9989	1588	72	4.2	0.3	475	300	100	71	0.8
Run 2 Minimum	15589	12426	3123	9791	1546	71	2.4	0.2	469	291	92	69	0.0
Run 2 Maximum	15792	12629	3204	10117	1601	76	5.8	0.4	553	307	110	73	1.7

CPT Run 3 Summary													
Calculation	Total Waste Feed	Low Btu Waste Feed	High Btu Waste Feed	Combustion Air Flow	Combustion Temperature	Scrubber Pressure Drop	Scrubber Water pH	Quench Tank pH	1st Stage Scrubber Flow	2nd Stage Scrubber Flow	Scrubber Blowdown Flow	Recirc Tank Level	CO Conc.
	lb/hr	lb/hr	lb/hr	scfm	deg F	in.w.c.	pH	pH	gal/min	gal/min	gal/min	%	ppmv
Run 3 Average	15642	12303	3339	9998	1544	71	4.2	0.6	475	301	101	71	2.7
Run 3 Minimum	15642	12300	3337	9837	1527	69	1.5	0.5	445	273	89	70	1.2
Run 3 Maximum	15643	12306	3342	10264	1555	74	5.8	0.6	516	347	115	73	4.2

Appendix O

Subpart ZZZZ—National Emissions Standards for Hazardous Air Pollutants for Stationary Reciprocating Internal Combustion Engines

WHAT THIS SUBPART COVERS

§63.6580 What is the purpose of subpart ZZZZ?

Subpart ZZZZ establishes national emission limitations and operating limitations for hazardous air pollutants (HAP) emitted from stationary reciprocating internal combustion engines (RICE) located at major and area sources of HAP emissions. This subpart also establishes requirements to demonstrate initial and continuous compliance with the emission limitations and operating limitations.

§63.6585 Am I subject to this subpart?

You are subject to this subpart if you own or operate a stationary RICE at a major or area source of HAP emissions, except if the stationary RICE is being tested at a stationary RICE test cell/stand.

(a) A stationary RICE is any internal combustion engine which uses reciprocating motion to convert heat energy into mechanical work and which is not mobile. Stationary RICE differ from mobile RICE in that a stationary RICE is not a non-road engine as defined at 40 CFR 1068.30, and is not used to propel a motor vehicle or a vehicle used solely for competition.

(b) A major source of HAP emissions is a plant site that emits or has the potential to emit any single HAP at a rate of 10 tons (9.07 megagrams) or more per year or any combination of HAP at a rate of 25 tons (22.68 megagrams) or more per year, except that for oil and gas production facilities, a major source of HAP emissions is determined for each surface site.

(c) An area source of HAP emissions is a source that is not a major source.

(d) If you are an owner or operator of an area source subject to this subpart, your status as an entity subject to a standard or other requirements under this subpart does not subject you to the obligation to obtain a permit under 40 CFR part 70 or 71, provided you are not required to obtain a permit under 40 CFR 70.3(a) or 40 CFR 71.3(a) for a reason other than your status as an area source under this subpart. Notwithstanding the previous sentence, you must continue to comply with the provisions of this subpart as applicable.

(e) If you are an owner or operator of a stationary RICE used for national security purposes, you may be eligible to request an exemption from the requirements of this subpart as described in 40 CFR part 1068, subpart C.

(f) The emergency stationary RICE listed in paragraphs (f)(1) through (3) of this section are not subject to this subpart. The stationary RICE must meet the definition of an emergency stationary RICE in §63.6675, which includes operating according to the provisions specified in §63.6640(f).

(1) Existing residential emergency stationary RICE located at an area source of HAP emissions that do not operate or are not contractually obligated to be available for more than 15 hours per calendar year for the purposes specified in §63.6640(f)(2)(ii) and (iii) and that do not operate for the purpose specified in §63.6640(f)(4)(ii).

(2) Existing commercial emergency stationary RICE located at an area source of HAP emissions that do not operate or are not contractually obligated to be available for more than 15 hours per calendar year for the purposes specified in §63.6640(f)(2)(ii) and (iii) and that do not operate for the purpose specified in §63.6640(f)(4)(ii).

(3) Existing institutional emergency stationary RICE located at an area source of HAP emissions that do not operate or are not contractually obligated to be available for more than 15 hours per calendar year for the purposes specified in §63.6640(f)(2)(ii) and (iii) and that do not operate for the purpose specified in §63.6640(f)(4)(ii).

§63.6590 What parts of my plant does this subpart cover?

This subpart applies to each affected source.

(a) *Affected source.* An affected source is any existing, new, or reconstructed stationary RICE located at a major or area source of HAP emissions, excluding stationary RICE being tested at a stationary RICE test cell/stand.

(1) *Existing stationary RICE.*

(i) For stationary RICE with a site rating of more than 500 brake horsepower (HP) located at a major source of HAP emissions, a stationary RICE is existing if you commenced construction or reconstruction of the stationary RICE before December 19, 2002.

(ii) For stationary RICE with a site rating of less than or equal to 500 brake HP located at a major source of HAP emissions, a stationary RICE is existing if you commenced construction or reconstruction of the stationary RICE before June 12, 2006.

(iii) For stationary RICE located at an area source of HAP emissions, a stationary RICE is existing if you commenced construction or reconstruction of the stationary RICE before June 12, 2006.

(iv) A change in ownership of an existing stationary RICE does not make that stationary RICE a new or reconstructed stationary RICE.

(2) *New stationary RICE.* (i) A stationary RICE with a site rating of more than 500 brake HP located at a major source of HAP emissions is new if you commenced construction of the stationary RICE on or after December 19, 2002.

(ii) A stationary RICE with a site rating of equal to or less than 500 brake HP located at a major source of HAP emissions is new if you commenced construction of the stationary RICE on or after June 12, 2006.

(iii) A stationary RICE located at an area source of HAP emissions is new if you commenced construction of the stationary RICE on or after June 12, 2006.

(3) *Reconstructed stationary RICE.* (i) A stationary RICE with a site rating of more than 500 brake HP located at a major source of HAP emissions is reconstructed if you meet the definition of reconstruction in §63.2 and reconstruction is commenced on or after December 19, 2002.

(ii) A stationary RICE with a site rating of equal to or less than 500 brake HP located at a major source of HAP emissions is reconstructed if you meet the definition of reconstruction in §63.2 and reconstruction is commenced on or after June 12, 2006.

(iii) A stationary RICE located at an area source of HAP emissions is reconstructed if you meet the definition of reconstruction in §63.2 and reconstruction is commenced on or after June 12, 2006.

(b) *Stationary RICE subject to limited requirements.* (1) An affected source which meets either of the criteria in paragraphs (b)(1)(i) through (ii) of this section does not have to meet the requirements of this subpart and of subpart A of this part except for the initial notification requirements of §63.6645(f).

(i) The stationary RICE is a new or reconstructed emergency stationary RICE with a site rating of more than 500 brake HP located at a major source of HAP emissions that does not operate or is not contractually obligated to be available for more than 15 hours per calendar year for the purposes specified in §63.6640(f)(2)(ii) and (iii).

(ii) The stationary RICE is a new or reconstructed limited use stationary RICE with a site rating of more than 500 brake HP located at a major source of HAP emissions.

(2) A new or reconstructed stationary RICE with a site rating of more than 500 brake HP located at a major source of HAP emissions which combusts landfill or digester gas equivalent to 10 percent or more of the gross heat input on an annual basis must meet the initial notification requirements of §63.6645(f) and the requirements of §§63.6625(c), 63.6650(g), and 63.6655(c). These stationary RICE do not have to meet the emission limitations and operating limitations of this subpart.

(3) The following stationary RICE do not have to meet the requirements of this subpart and of subpart A of this part, including initial notification requirements:

(i) Existing spark ignition 2 stroke lean burn (2SLB) stationary RICE with a site rating of more than 500 brake HP located at a major source of HAP emissions;

(ii) Existing spark ignition 4 stroke lean burn (4SLB) stationary RICE with a site rating of more than 500 brake HP located at a major source of HAP emissions;

(iii) Existing emergency stationary RICE with a site rating of more than 500 brake HP located at a major source of HAP emissions that does not operate or is not contractually obligated to be available for more than 15 hours per calendar year for the purposes specified in §63.6640(f)(2)(ii) and (iii).

(iv) Existing limited use stationary RICE with a site rating of more than 500 brake HP located at a major source of HAP emissions;

(v) Existing stationary RICE with a site rating of more than 500 brake HP located at a major source of HAP emissions that combusts landfill gas or digester gas equivalent to 10 percent or more of the gross heat input on an annual basis;

(c) *Stationary RICE subject to Regulations under 40 CFR Part 60.* An affected source that meets any of the criteria in paragraphs (c)(1) through (7) of this section must meet the requirements of this part by meeting the requirements of 40 CFR part 60 subpart IIII, for compression ignition engines or 40 CFR part 60 subpart JJJJ, for spark ignition engines. No further requirements apply for such engines under this part.

(1) A new or reconstructed stationary RICE located at an area source;

(2) A new or reconstructed 2SLB stationary RICE with a site rating of less than or equal to 500 brake HP located at a major source of HAP emissions;

(3) A new or reconstructed 4SLB stationary RICE with a site rating of less than 250 brake HP located at a major source of HAP emissions;

(4) A new or reconstructed spark ignition 4 stroke rich burn (4SRB) stationary RICE with a site rating of less than or equal to 500 brake HP located at a major source of HAP emissions;

(5) A new or reconstructed stationary RICE with a site rating of less than or equal to 500 brake HP located at a major source of HAP emissions which combusts landfill or digester gas equivalent to 10 percent or more of the gross heat input on an annual basis;

(6) A new or reconstructed emergency or limited use stationary RICE with a site rating of less than or equal to 500 brake HP located at a major source of HAP emissions;

(7) A new or reconstructed compression ignition (CI) stationary RICE with a site rating of less than or equal to 500 brake HP located at a major source of HAP emissions.

§63.6595 When do I have to comply with this subpart?

(a) *Affected sources.* (1) If you have an existing stationary RICE, excluding existing non-emergency CI stationary RICE, with a site rating of more than 500 brake HP located at a major source of HAP emissions, you must comply with the applicable emission limitations, operating limitations and other requirements no later than June 15, 2007. If you have an existing non-emergency CI stationary RICE with a site rating of more than 500 brake HP located at a major source of HAP emissions, an existing stationary CI RICE with a site rating of less than or equal to 500 brake HP located at a major source of HAP emissions, or an existing stationary CI RICE located at an area source of HAP emissions, you must comply with the applicable emission limitations, operating limitations, and other requirements no later than May 3, 2013. If you have an existing stationary SI RICE with a site rating of less than or equal to 500 brake HP located at a major source of HAP emissions, or an existing stationary SI RICE located at an area source of HAP emissions, you must comply with the applicable emission limitations, operating limitations, and other requirements no later than October 19, 2013.

(2) If you start up your new or reconstructed stationary RICE with a site rating of more than 500 brake HP located at a major source of HAP emissions before August 16, 2004, you must comply with the applicable emission limitations and operating limitations in this subpart no later than August 16, 2004.

(3) If you start up your new or reconstructed stationary RICE with a site rating of more than 500 brake HP located at a major source of HAP emissions after August 16, 2004, you must comply with the applicable emission limitations and operating limitations in this subpart upon startup of your affected source.

(4) If you start up your new or reconstructed stationary RICE with a site rating of less than or equal to 500 brake HP located at a major source of HAP emissions before January 18, 2008, you must comply with the applicable emission limitations and operating limitations in this subpart no later than January 18, 2008.

(5) If you start up your new or reconstructed stationary RICE with a site rating of less than or equal to 500 brake HP located at a major source of HAP emissions after January 18, 2008, you must comply with the applicable emission limitations and operating limitations in this subpart upon startup of your affected source.

(6) If you start up your new or reconstructed stationary RICE located at an area source of HAP emissions before January 18, 2008, you must comply with the applicable emission limitations and operating limitations in this subpart no later than January 18, 2008.

(7) If you start up your new or reconstructed stationary RICE located at an area source of HAP emissions after January 18, 2008, you must comply with the applicable emission limitations and operating limitations in this subpart upon startup of your affected source.

(b) *Area sources that become major sources.* If you have an area source that increases its emissions or its potential to emit such that it becomes a major source of HAP, the compliance dates in paragraphs (b)(1) and (2) of this section apply to you.

(1) Any stationary RICE for which construction or reconstruction is commenced after the date when your area source becomes a major source of HAP must be in compliance with this subpart upon startup of your affected source.

(2) Any stationary RICE for which construction or reconstruction is commenced before your area source becomes a major source of HAP must be in compliance with the provisions of this subpart that are applicable to RICE located at major sources within 3 years after your area source becomes a major source of HAP.

(c) If you own or operate an affected source, you must meet the applicable notification requirements in §63.6645 and in 40 CFR part 63, subpart A.

EMISSION AND OPERATING LIMITATIONS

§63.6600 What emission limitations and operating limitations must I meet if I own or operate a stationary RICE with a site rating of more than 500 brake HP located at a major source of HAP emissions?

Compliance with the numerical emission limitations established in this subpart is based on the results of testing the average of three 1-hour runs using the testing requirements and procedures in §63.6620 and Table 4 to this subpart.

(a) If you own or operate an existing, new, or reconstructed spark ignition 4SRB stationary RICE with a site rating of more than 500 brake HP located at a major source of HAP emissions, you must comply with the emission limitations in Table 1a to this subpart and the operating limitations in Table 1b to this subpart which apply to you.

(b) If you own or operate a new or reconstructed 2SLB stationary RICE with a site rating of more than 500 brake HP located at major source of HAP emissions, a new or reconstructed 4SLB stationary RICE with a site rating of more than 500 brake HP located at major source of HAP emissions, or a new or reconstructed CI stationary RICE with a site rating of more than 500 brake HP located at a major source of HAP emissions, you must comply with the emission limitations in Table 2a to this subpart and the operating limitations in Table 2b to this subpart which apply to you.

(c) If you own or operate any of the following stationary RICE with a site rating of more than 500 brake HP located at a major source of HAP emissions, you do not need to comply with the emission limitations in Tables 1a, 2a, 2c, and 2d to this subpart or operating limitations in Tables 1b and 2b to this subpart: an existing 2SLB stationary RICE; an existing 4SLB stationary RICE; a stationary RICE that combusts landfill gas or digester gas equivalent to 10 percent or more of the gross heat input on an annual basis; an emergency stationary RICE; or a limited use stationary RICE.

(d) If you own or operate an existing non-emergency stationary CI RICE with a site rating of more than 500 brake HP located at a major source of HAP emissions, you must comply with the emission limitations in Table 2c to this subpart and the operating limitations in Table 2b to this subpart which apply to you.

§63.6601 What emission limitations must I meet if I own or operate a new or reconstructed 4SLB stationary RICE with a site rating of greater than or equal to 250 brake HP and less than or equal to 500 brake HP located at a major source of HAP emissions?

Compliance with the numerical emission limitations established in this subpart is based on the results of testing the average of three 1-hour runs using the testing requirements and procedures in §63.6620 and Table 4 to this subpart. If you own or operate a new or reconstructed 4SLB stationary RICE with a site rating of greater than or equal to 250 and less than or equal to 500 brake HP located at major source of HAP emissions manufactured on or after January 1, 2008, you must comply with the emission limitations in Table 2a to this subpart and the operating limitations in Table 2b to this subpart which apply to you.

§63.6602 What emission limitations and other requirements must I meet if I own or operate an existing stationary RICE with a site rating of equal to or less than 500 brake HP located at a major source of HAP emissions?

If you own or operate an existing stationary RICE with a site rating of equal to or less than 500 brake HP located at a major source of HAP emissions, you must comply with the emission limitations and other requirements in Table 2c to this subpart which apply to you. Compliance with the numerical emission limitations established in this subpart is based on the results of testing the average of three 1-hour runs using the testing requirements and procedures in §63.6620 and Table 4 to this subpart.

§63.6603 What emission limitations, operating limitations, and other requirements must I meet if I own or operate an existing stationary RICE located at an area source of HAP emissions?

Compliance with the numerical emission limitations established in this subpart is based on the results of testing the average of three 1-hour runs using the testing requirements and procedures in §63.6620 and Table 4 to this subpart.

(a) If you own or operate an existing stationary RICE located at an area source of HAP emissions, you must comply with the requirements in Table 2d to this subpart and the operating limitations in Table 2b to this subpart that apply to you.

(b) If you own or operate an existing stationary non-emergency CI RICE with a site rating of more than 300 HP located at an area source of HAP that meets either paragraph (b)(1) or (2) of this section, you do not have to meet the numerical CO emission limitations specified in Table 2d of this subpart. Existing stationary non-emergency CI RICE with a site rating of more than 300 HP located at an area source of HAP that meet either paragraph (b)(1) or (2) of this section must meet the management practices that are shown for stationary non-emergency CI RICE with a site rating of less than or equal to 300 HP in Table 2d of this subpart.

(1) The area source is located in an area of Alaska that is not accessible by the Federal Aid Highway System (FAHS).

(2) The stationary RICE is located at an area source that meets paragraphs (b)(2)(i), (ii), and (iii) of this section.

(i) The only connection to the FAHS is through the Alaska Marine Highway System (AMHS), or the stationary RICE operation is within an isolated grid in Alaska that is not connected to the statewide electrical grid referred to as the Alaska Railbelt Grid.

(ii) At least 10 percent of the power generated by the stationary RICE on an annual basis is used for residential purposes.

(iii) The generating capacity of the area source is less than 12 megawatts, or the stationary RICE is used exclusively for backup power for renewable energy.

(c) If you own or operate an existing stationary non-emergency CI RICE with a site rating of more than 300 HP located on an offshore vessel that is an area source of HAP and is a nonroad vehicle that is an Outer Continental Shelf (OCS) source as defined in 40 CFR 55.2, you do not have to meet the numerical CO emission limitations specified in Table 2d of this subpart. You must meet all of the following management practices:

(1) Change oil every 1,000 hours of operation or annually, whichever comes first. Sources have the option to utilize an oil analysis program as described in §63.6625(i) in order to extend the specified oil change requirement.

(2) Inspect and clean air filters every 750 hours of operation or annually, whichever comes first, and replace as necessary.

(3) Inspect fuel filters and belts, if installed, every 750 hours of operation or annually, whichever comes first, and replace as necessary.

(4) Inspect all flexible hoses every 1,000 hours of operation or annually, whichever comes first, and replace as necessary.

(d) If you own or operate an existing non-emergency CI RICE with a site rating of more than 300 HP located at an area source of HAP emissions that is certified to the Tier 1 or Tier 2 emission standards in Table 1 of 40 CFR 89.112 and that is subject to an enforceable state or local standard that requires the engine to be replaced no later than June 1, 2018, you may until January 1, 2015, or 12 years after the installation date of the engine (whichever is later), but not later than June 1, 2018, choose to comply with the management practices that are shown for stationary non-emergency CI RICE with a site rating of less than or equal to 300 HP in Table 2d of this subpart instead of the applicable emission limitations in Table 2d, operating limitations in Table 2b, and crankcase ventilation system requirements in §63.6625(g). You must comply with the emission limitations in Table 2d and operating limitations in Table 2b that apply for non-emergency CI RICE with a site rating of more than 300 HP located at an area source of HAP emissions by January 1, 2015, or 12 years after the installation date of the engine (whichever is later), but not later than June 1, 2018. You must also comply with the crankcase ventilation system requirements in §63.6625(g) by January 1, 2015, or 12 years after the installation date of the engine (whichever is later), but not later than June 1, 2018.

(e) If you own or operate an existing non-emergency CI RICE with a site rating of more than 300 HP located at an area source of HAP emissions that is certified to the Tier 3 (Tier 2 for engines above 560 kilowatt (kW)) emission standards in Table 1 of 40 CFR 89.112, you may comply with the requirements under this part by meeting the requirements for Tier 3 engines (Tier 2 for engines above 560 kW) in 40 CFR part 60 subpart IIII instead of the emission limitations and other requirements that would otherwise apply under this part for existing non-emergency CI RICE with a site rating of more than 300 HP located at an area source of HAP emissions.

(f) An existing non-emergency SI 4SLB and 4SRB stationary RICE with a site rating of more than 500 HP located at area sources of HAP must meet the definition of remote stationary RICE in §63.6675 on the initial compliance date for the engine, October 19, 2013, in order to be considered a remote stationary RICE under this subpart. Owners and operators of existing non-emergency SI 4SLB and 4SRB stationary RICE with a site rating of more than 500 HP located at area sources of HAP that meet the definition of remote stationary RICE in §63.6675 of this subpart as of October 19, 2013 must evaluate the status of their stationary RICE every 12 months. Owners and operators must keep records of the initial and annual evaluation of the status of the engine. If the evaluation indicates that the stationary RICE no longer meets the definition of remote stationary RICE in §63.6675 of this subpart, the owner or operator must comply with all of the requirements for existing non-emergency SI 4SLB and

4SRB stationary RICE with a site rating of more than 500 HP located at area sources of HAP that are not remote stationary RICE within 1 year of the evaluation.

§63.6604 What fuel requirements must I meet if I own or operate a stationary CI RICE?

(a) If you own or operate an existing non-emergency, non-black start CI stationary RICE with a site rating of more than 300 brake HP with a displacement of less than 30 liters per cylinder that uses diesel fuel, you must use diesel fuel that meets the requirements in 40 CFR 80.510(b) for nonroad diesel fuel.

(b) Beginning January 1, 2015, if you own or operate an existing emergency CI stationary RICE with a site rating of more than 100 brake HP and a displacement of less than 30 liters per cylinder that uses diesel fuel and operates or is contractually obligated to be available for more than 15 hours per calendar year for the purposes specified in §63.6640(f)(2)(ii) and (iii) or that operates for the purpose specified in §63.6640(f)(4)(ii), you must use diesel fuel that meets the requirements in 40 CFR 80.510(b) for nonroad diesel fuel, except that any existing diesel fuel purchased (or otherwise obtained) prior to January 1, 2015, may be used until depleted.

(c) Beginning January 1, 2015, if you own or operate a new emergency CI stationary RICE with a site rating of more than 500 brake HP and a displacement of less than 30 liters per cylinder located at a major source of HAP that uses diesel fuel and operates or is contractually obligated to be available for more than 15 hours per calendar year for the purposes specified in §63.6640(f)(2)(ii) and (iii), you must use diesel fuel that meets the requirements in 40 CFR 80.510(b) for nonroad diesel fuel, except that any existing diesel fuel purchased (or otherwise obtained) prior to January 1, 2015, may be used until depleted.

(d) Existing CI stationary RICE located in Guam, American Samoa, the Commonwealth of the Northern Mariana Islands, at area sources in areas of Alaska that meet either §63.6603(b)(1) or §63.6603(b)(2), or are on offshore vessels that meet §63.6603(c) are exempt from the requirements of this section.

GENERAL COMPLIANCE REQUIREMENTS

§63.6605 What are my general requirements for complying with this subpart?

(a) You must be in compliance with the emission limitations, operating limitations, and other requirements in this subpart that apply to you at all times.

(b) At all times you must operate and maintain any affected source, including associated air pollution control equipment and monitoring equipment, in a manner consistent with safety and good air pollution control practices for minimizing emissions. The general duty to minimize emissions does not require you to make any further efforts to reduce emissions if levels required by this standard have been achieved. Determination of whether such operation and maintenance procedures are being used will be based on information available to the Administrator which may include, but is not limited to, monitoring results, review of operation and maintenance procedures, review of operation and maintenance records, and inspection of the source.

TESTING AND INITIAL COMPLIANCE REQUIREMENTS

§63.6610 By what date must I conduct the initial performance tests or other initial compliance demonstrations if I own or operate a stationary RICE with a site rating of more than 500 brake HP located at a major source of HAP emissions?

If you own or operate a stationary RICE with a site rating of more than 500 brake HP located at a major source of HAP emissions you are subject to the requirements of this section.

(a) You must conduct the initial performance test or other initial compliance demonstrations in Table 4 to this subpart that apply to you within 180 days after the compliance date that is specified for your stationary RICE in §63.6595 and according to the provisions in §63.7(a)(2).

(b) If you commenced construction or reconstruction between December 19, 2002 and June 15, 2004 and own or operate stationary RICE with a site rating of more than 500 brake HP located at a major source of HAP emissions, you must demonstrate initial compliance with either the proposed emission limitations or the promulgated emission limitations no later than February 10, 2005 or no later than 180 days after startup of the source, whichever is later, according to §63.7(a)(2)(ix).

(c) If you commenced construction or reconstruction between December 19, 2002 and June 15, 2004 and own or operate stationary RICE with a site rating of more than 500 brake HP located at a major source of HAP emissions, and you chose to comply with the proposed emission limitations when demonstrating initial compliance, you must conduct a second performance test to demonstrate compliance with the promulgated emission limitations by December 13, 2007 or after startup of the source, whichever is later, according to §63.7(a)(2)(ix).

(d) An owner or operator is not required to conduct an initial performance test on units for which a performance test has been previously conducted, but the test must meet all of the conditions described in paragraphs (d)(1) through (5) of this section.

(1) The test must have been conducted using the same methods specified in this subpart, and these methods must have been followed correctly.

(2) The test must not be older than 2 years.

(3) The test must be reviewed and accepted by the Administrator.

(4) Either no process or equipment changes must have been made since the test was performed, or the owner or operator must be able to demonstrate that the results of the performance test, with or without adjustments, reliably demonstrate compliance despite process or equipment changes.

(5) The test must be conducted at any load condition within plus or minus 10 percent of 100 percent load.

§63.6611 By what date must I conduct the initial performance tests or other initial compliance demonstrations if I own or operate a new or reconstructed 4SLB SI stationary RICE with a site rating of greater than or equal to 250 and less than or equal to 500 brake HP located at a major source of HAP emissions?

If you own or operate a new or reconstructed 4SLB stationary RICE with a site rating of greater than or equal to 250 and less than or equal to 500 brake HP located at a major source of HAP emissions, you must conduct an initial performance test within 240 days after the compliance date that is specified for your stationary RICE in §63.6595 and according to the provisions specified in Table 4 to this subpart, as appropriate.

§63.6612 By what date must I conduct the initial performance tests or other initial compliance demonstrations if I own or operate an existing stationary RICE with a site rating of less than or equal to 500 brake HP located at a major source of HAP emissions or an existing stationary RICE located at an area source of HAP emissions?

If you own or operate an existing stationary RICE with a site rating of less than or equal to 500 brake HP located at a major source of HAP emissions or an existing stationary RICE located at an area source of HAP emissions you are subject to the requirements of this section.

(a) You must conduct any initial performance test or other initial compliance demonstration according to Tables 4 and 5 to this subpart that apply to you within 180 days after the compliance date that is specified for your stationary RICE in §63.6595 and according to the provisions in §63.7(a)(2).

(b) An owner or operator is not required to conduct an initial performance test on a unit for which a performance test has been previously conducted, but the test must meet all of the conditions described in paragraphs (b)(1) through (4) of this section.

(1) The test must have been conducted using the same methods specified in this subpart, and these methods must have been followed correctly.

(2) The test must not be older than 2 years.

(3) The test must be reviewed and accepted by the Administrator.

(4) Either no process or equipment changes must have been made since the test was performed, or the owner or operator must be able to demonstrate that the results of the performance test, with or without adjustments, reliably demonstrate compliance despite process or equipment changes.

§63.6615 When must I conduct subsequent performance tests?

If you must comply with the emission limitations and operating limitations, you must conduct subsequent performance tests as specified in Table 3 of this subpart.

§63.6620 What performance tests and other procedures must I use?

(a) You must conduct each performance test in Tables 3 and 4 of this subpart that applies to you.

(b) Each performance test must be conducted according to the requirements that this subpart specifies in Table 4 to this subpart. If you own or operate a non-operational stationary RICE that is subject to performance testing, you do not need to start up the engine solely to conduct the performance test. Owners and operators of a non-operational engine can conduct the performance test when the engine is started up again. The test must be conducted at any load condition within plus or minus 10 percent of 100 percent load for the stationary RICE listed in paragraphs (b)(1) through (4) of this section.

(1) Non-emergency 4SRB stationary RICE with a site rating of greater than 500 brake HP located at a major source of HAP emissions.

(2) New non-emergency 4SLB stationary RICE with a site rating of greater than or equal to 250 brake HP located at a major source of HAP emissions.

(3) New non-emergency 2SLB stationary RICE with a site rating of greater than 500 brake HP located at a major source of HAP emissions.

(4) New non-emergency CI stationary RICE with a site rating of greater than 500 brake HP located at a major source of HAP emissions.

(c) [Reserved]

(d) You must conduct three separate test runs for each performance test required in this section, as specified in §63.7(e)(3). Each test run must last at least 1 hour, unless otherwise specified in this subpart.

(e)(1) You must use Equation 1 of this section to determine compliance with the percent reduction requirement:

$$\frac{C_i - C_o}{C_i} \times 100 = R \quad (\text{Eq. 1})$$

Where:

C_i = concentration of carbon monoxide (CO), total hydrocarbons (THC), or formaldehyde at the control device inlet,

C_o = concentration of CO, THC, or formaldehyde at the control device outlet, and

R = percent reduction of CO, THC, or formaldehyde emissions.

(2) You must normalize the CO, THC, or formaldehyde concentrations at the inlet and outlet of the control device to a dry basis and to 15 percent oxygen, or an equivalent percent carbon dioxide (CO₂). If pollutant concentrations are to be corrected to 15 percent oxygen and CO₂ concentration is measured in lieu of oxygen concentration measurement, a CO₂ correction factor is needed. Calculate the CO₂ correction factor as described in paragraphs (e)(2)(i) through (iii) of this section.

(i) Calculate the fuel-specific F_o value for the fuel burned during the test using values obtained from Method 19, Section 5.2, and the following equation:

$$F_o = \frac{0.209 F_d}{F_c} \quad (\text{Eq. 2})$$

Where:

F_o = Fuel factor based on the ratio of oxygen volume to the ultimate CO₂ volume produced by the fuel at zero percent excess air.

0.209 = Fraction of air that is oxygen, percent/100.

F_d = Ratio of the volume of dry effluent gas to the gross calorific value of the fuel from Method 19, dsm³/J (dscf/10⁶ Btu).

F_c = Ratio of the volume of CO₂ produced to the gross calorific value of the fuel from Method 19, dsm³/J (dscf/10⁶ Btu)

(ii) Calculate the CO₂ correction factor for correcting measurement data to 15 percent O₂, as follows:

$$X_{CO2} = \frac{5.9}{F_o} \quad (\text{Eq. 3})$$

Where:

X_{CO_2} = CO₂ correction factor, percent.

5.9 = 20.9 percent O₂—15 percent O₂, the defined O₂ correction value, percent.

(iii) Calculate the CO, THC, and formaldehyde gas concentrations adjusted to 15 percent O₂ using CO₂ as follows:

$$C_{adj} = C_d \frac{X_{CO_2}}{\%CO_2} \quad (\text{Eq. 4})$$

Where:

C_{adj} = Calculated concentration of CO, THC, or formaldehyde adjusted to 15 percent O₂.

C_d = Measured concentration of CO, THC, or formaldehyde, uncorrected.

X_{CO_2} = CO₂ correction factor, percent.

%CO₂ = Measured CO₂ concentration measured, dry basis, percent.

(f) If you comply with the emission limitation to reduce CO and you are not using an oxidation catalyst, if you comply with the emission limitation to reduce formaldehyde and you are not using NSCR, or if you comply with the emission limitation to limit the concentration of formaldehyde in the stationary RICE exhaust and you are not using an oxidation catalyst or NSCR, you must petition the Administrator for operating limitations to be established during the initial performance test and continuously monitored thereafter; or for approval of no operating limitations. You must not conduct the initial performance test until after the petition has been approved by the Administrator.

(g) If you petition the Administrator for approval of operating limitations, your petition must include the information described in paragraphs (g)(1) through (5) of this section.

(1) Identification of the specific parameters you propose to use as operating limitations;

(2) A discussion of the relationship between these parameters and HAP emissions, identifying how HAP emissions change with changes in these parameters, and how limitations on these parameters will serve to limit HAP emissions;

(3) A discussion of how you will establish the upper and/or lower values for these parameters which will establish the limits on these parameters in the operating limitations;

(4) A discussion identifying the methods you will use to measure and the instruments you will use to monitor these parameters, as well as the relative accuracy and precision of these methods and instruments; and

(5) A discussion identifying the frequency and methods for recalibrating the instruments you will use for monitoring these parameters.

(h) If you petition the Administrator for approval of no operating limitations, your petition must include the information described in paragraphs (h)(1) through (7) of this section.

(1) Identification of the parameters associated with operation of the stationary RICE and any emission control device which could change intentionally (*e.g.*, operator adjustment, automatic controller adjustment, etc.) or unintentionally (*e.g.*, wear and tear, error, etc.) on a routine basis or over time;

(2) A discussion of the relationship, if any, between changes in the parameters and changes in HAP emissions;

(3) For the parameters which could change in such a way as to increase HAP emissions, a discussion of whether establishing limitations on the parameters would serve to limit HAP emissions;

(4) For the parameters which could change in such a way as to increase HAP emissions, a discussion of how you could establish upper and/or lower values for the parameters which would establish limits on the parameters in operating limitations;

(5) For the parameters, a discussion identifying the methods you could use to measure them and the instruments you could use to monitor them, as well as the relative accuracy and precision of the methods and instruments;

(6) For the parameters, a discussion identifying the frequency and methods for recalibrating the instruments you could use to monitor them; and

(7) A discussion of why, from your point of view, it is infeasible or unreasonable to adopt the parameters as operating limitations.

(i) The engine percent load during a performance test must be determined by documenting the calculations, assumptions, and measurement devices used to measure or estimate the percent load in a specific application. A written report of the average percent load determination must be included in the notification of compliance status. The following information must be included in the written report: the engine model number, the engine manufacturer, the year of purchase, the manufacturer's site-rated brake horsepower, the ambient temperature, pressure, and humidity during the performance test, and all assumptions that were made to estimate or calculate percent load during the performance test must be clearly explained. If measurement devices such as flow meters, kilowatt meters, beta analyzers, stain gauges, etc. are used, the model number of the measurement device, and an estimate of its accurate in percentage of true value must be provided.

§63.6625 What are my monitoring, installation, collection, operation, and maintenance requirements?

(a) If you elect to install a CEMS as specified in Table 5 of this subpart, you must install, operate, and maintain a CEMS to monitor CO and either O₂ or CO₂ according to the requirements in paragraphs (a)(1) through (4) of this section. If you are meeting a requirement to reduce CO emissions, the CEMS must be installed at both the inlet and outlet of the control device. If you are meeting a requirement to limit the concentration of CO, the CEMS must be installed at the outlet of the control device.

(1) Each CEMS must be installed, operated, and maintained according to the applicable performance specifications of 40 CFR part 60, appendix B.

(2) You must conduct an initial performance evaluation and an annual relative accuracy test audit (RATA) of each CEMS according to the requirements in §63.8 and according to the applicable performance specifications of 40 CFR part 60, appendix B as well as daily and periodic data quality checks in accordance with 40 CFR part 60, appendix F, procedure 1.

(3) As specified in §63.8(c)(4)(ii), each CEMS must complete a minimum of one cycle of operation (sampling, analyzing, and data recording) for each successive 15-minute period. You must have at least two data points, with each representing a different 15-minute period, to have a valid hour of data.

(4) The CEMS data must be reduced as specified in §63.8(g)(2) and recorded in parts per million or parts per billion (as appropriate for the applicable limitation) at 15 percent oxygen or the equivalent CO₂ concentration.

(b) If you are required to install a continuous parameter monitoring system (CPMS) as specified in Table 5 of this subpart, you must install, operate, and maintain each CPMS according to the requirements in paragraphs (b)(1) through (6) of this section. For an affected source that is complying with the emission limitations and operating limitations on March 9, 2011, the requirements in paragraph (b) of this section are applicable September 6, 2011.

(1) You must prepare a site-specific monitoring plan that addresses the monitoring system design, data collection, and the quality assurance and quality control elements outlined in paragraphs (b)(1)(i) through (v) of this section and in §63.8(d). As specified in §63.8(f)(4), you may request approval of monitoring system quality assurance and quality control procedures alternative to those specified in paragraphs (b)(1) through (5) of this section in your site-specific monitoring plan.

(i) The performance criteria and design specifications for the monitoring system equipment, including the sample interface, detector signal analyzer, and data acquisition and calculations;

(ii) Sampling interface (*e.g.*, thermocouple) location such that the monitoring system will provide representative measurements;

(iii) Equipment performance evaluations, system accuracy audits, or other audit procedures;

(iv) Ongoing operation and maintenance procedures in accordance with provisions in §63.8(c)(1)(ii) and (c)(3); and

(v) Ongoing reporting and recordkeeping procedures in accordance with provisions in §63.10(c), (e)(1), and (e)(2)(i).

(2) You must install, operate, and maintain each CPMS in continuous operation according to the procedures in your site-specific monitoring plan.

(3) The CPMS must collect data at least once every 15 minutes (see also §63.6635).

(4) For a CPMS for measuring temperature range, the temperature sensor must have a minimum tolerance of 2.8 degrees Celsius (5 degrees Fahrenheit) or 1 percent of the measurement range, whichever is larger.

(5) You must conduct the CPMS equipment performance evaluation, system accuracy audits, or other audit procedures specified in your site-specific monitoring plan at least annually.

(6) You must conduct a performance evaluation of each CPMS in accordance with your site-specific monitoring plan.

(c) If you are operating a new or reconstructed stationary RICE which fires landfill gas or digester gas equivalent to 10 percent or more of the gross heat input on an annual basis, you must monitor and record your fuel usage daily with separate fuel meters to measure the volumetric flow rate of each fuel. In addition, you must operate your stationary RICE in a manner which reasonably minimizes HAP emissions.

(d) If you are operating a new or reconstructed emergency 4SLB stationary RICE with a site rating of greater than or equal to 250 and less than or equal to 500 brake HP located at a major source of HAP emissions, you must install a non-resettable hour meter prior to the startup of the engine.

(e) If you own or operate any of the following stationary RICE, you must operate and maintain the stationary RICE and after-treatment control device (if any) according to the manufacturer's emission-related written instructions or develop your own maintenance plan which must provide to the extent practicable for the maintenance and operation of the engine in a manner consistent with good air pollution control practice for minimizing emissions:

(1) An existing stationary RICE with a site rating of less than 100 HP located at a major source of HAP emissions;

(2) An existing emergency or black start stationary RICE with a site rating of less than or equal to 500 HP located at a major source of HAP emissions;

(3) An existing emergency or black start stationary RICE located at an area source of HAP emissions;

(4) An existing non-emergency, non-black start stationary CI RICE with a site rating less than or equal to 300 HP located at an area source of HAP emissions;

(5) An existing non-emergency, non-black start 2SLB stationary RICE located at an area source of HAP emissions;

(6) An existing non-emergency, non-black start stationary RICE located at an area source of HAP emissions which combusts landfill or digester gas equivalent to 10 percent or more of the gross heat input on an annual basis.

(7) An existing non-emergency, non-black start 4SLB stationary RICE with a site rating less than or equal to 500 HP located at an area source of HAP emissions;

(8) An existing non-emergency, non-black start 4SRB stationary RICE with a site rating less than or equal to 500 HP located at an area source of HAP emissions;

(9) An existing, non-emergency, non-black start 4SLB stationary RICE with a site rating greater than 500 HP located at an area source of HAP emissions that is operated 24 hours or less per calendar year; and

(10) An existing, non-emergency, non-black start 4SRB stationary RICE with a site rating greater than 500 HP located at an area source of HAP emissions that is operated 24 hours or less per calendar year.

(f) If you own or operate an existing emergency stationary RICE with a site rating of less than or equal to 500 brake HP located at a major source of HAP emissions or an existing emergency stationary RICE located at an area source of HAP emissions, you must install a non-resettable hour meter if one is not already installed.

(g) If you own or operate an existing non-emergency, non-black start CI engine greater than or equal to 300 HP that is not equipped with a closed crankcase ventilation system, you must comply with either paragraph (g)(1) or paragraph (2) of this section. Owners and operators must follow the manufacturer's specified maintenance requirements for operating and maintaining the open or closed crankcase ventilation systems and replacing the crankcase filters, or can request the Administrator to approve different maintenance requirements that are as protective as manufacturer requirements. Existing CI engines located at area sources in areas of Alaska that meet either §63.6603(b)(1) or §63.6603(b)(2) do not have to meet the requirements of this paragraph (g). Existing CI engines located on offshore vessels that meet §63.6603(c) do not have to meet the requirements of this paragraph (g).

(1) Install a closed crankcase ventilation system that prevents crankcase emissions from being emitted to the atmosphere, or

(2) Install an open crankcase filtration emission control system that reduces emissions from the crankcase by filtering the exhaust stream to remove oil mist, particulates and metals.

(h) If you operate a new, reconstructed, or existing stationary engine, you must minimize the engine's time spent at idle during startup and minimize the engine's startup time to a period needed for appropriate and safe loading of the engine, not to exceed 30 minutes, after which time the emission standards applicable to all times other than startup in Tables 1a, 2a, 2c, and 2d to this subpart apply.

(i) If you own or operate a stationary CI engine that is subject to the work, operation or management practices in items 1 or 2 of Table 2c to this subpart or in items 1 or 4 of Table 2d to this subpart, you have the option of utilizing an oil analysis program in order to extend the specified oil change requirement in Tables 2c and 2d to this subpart. The oil analysis must be performed at the same frequency specified for changing the oil in Table 2c or 2d to this subpart. The analysis program must at a minimum analyze the following three parameters: Total Base Number, viscosity, and percent water content. The condemning limits for these parameters are as follows: Total Base Number is less than 30 percent of the Total Base Number of the oil when new; viscosity of the oil has changed by more than 20 percent from the viscosity of the oil when new; or percent water content (by volume) is greater than 0.5. If all of these condemning limits are not exceeded, the engine owner or operator is not required to change the oil. If any of the limits are exceeded, the engine owner or operator must change the oil within 2 business days of receiving the results of the analysis; if the engine is not in operation when the results of the analysis are received, the engine owner or operator must change the oil within 2 business days or before commencing operation, whichever is later. The owner or operator must keep records of the parameters that are analyzed as part of the program, the results of the analysis, and the oil changes for the engine. The analysis program must be part of the maintenance plan for the engine.

(j) If you own or operate a stationary SI engine that is subject to the work, operation or management practices in items 6, 7, or 8 of Table 2c to this subpart or in items 5, 6, 7, 9, or 11 of Table 2d to this subpart, you have the option of utilizing an oil analysis program in order to extend the specified oil change requirement in Tables 2c and 2d to this subpart. The oil analysis must be performed at the same frequency specified for changing the oil in Table 2c or 2d to this subpart. The analysis program must at a minimum analyze the following three parameters: Total Acid Number, viscosity, and percent water content. The condemning limits for these parameters are as follows: Total Acid Number increases by more than 3.0 milligrams of potassium hydroxide (KOH) per gram from Total Acid Number of the oil when new; viscosity of the oil has changed by more than 20 percent from the viscosity of the oil when new; or percent water content (by volume) is greater than 0.5. If all of these condemning limits are not exceeded, the engine owner or operator is not required to change the oil. If any of the limits are exceeded, the engine owner or operator must change the oil within 2 business days of receiving the results of the analysis; if the engine is not in operation when the results of the analysis are received, the engine owner or operator must change the oil within 2 business days or before commencing operation, whichever is later. The owner or operator must keep records of the parameters that are analyzed as part of the program, the results of the analysis, and the oil changes for the engine. The analysis program must be part of the maintenance plan for the engine.

§63.6630 How do I demonstrate initial compliance with the emission limitations, operating limitations, and other requirements?

(a) You must demonstrate initial compliance with each emission limitation, operating limitation, and other requirement that applies to you according to Table 5 of this subpart.

(b) During the initial performance test, you must establish each operating limitation in Tables 1b and 2b of this subpart that applies to you.

(c) You must submit the Notification of Compliance Status containing the results of the initial compliance demonstration according to the requirements in §63.6645.

(d) Non-emergency 4SRB stationary RICE complying with the requirement to reduce formaldehyde emissions by 76 percent or more can demonstrate initial compliance with the formaldehyde emission limit by testing for THC instead of formaldehyde. The testing must be conducted according to the requirements in Table 4 of this subpart. The average reduction of emissions of THC determined from the performance test must be equal to or greater than 30 percent.

(e) The initial compliance demonstration required for existing non-emergency 4SLB and 4SRB stationary RICE with a site rating of more than 500 HP located at an area source of HAP that are not remote stationary RICE

and that are operated more than 24 hours per calendar year must be conducted according to the following requirements:

- (1) The compliance demonstration must consist of at least three test runs.
- (2) Each test run must be of at least 15 minute duration, except that each test conducted using the method in appendix A to this subpart must consist of at least one measurement cycle and include at least 2 minutes of test data phase measurement.
- (3) If you are demonstrating compliance with the CO concentration or CO percent reduction requirement, you must measure CO emissions using one of the CO measurement methods specified in Table 4 of this subpart, or using appendix A to this subpart.
- (4) If you are demonstrating compliance with the THC percent reduction requirement, you must measure THC emissions using Method 25A, reported as propane, of 40 CFR part 60, appendix A.
- (5) You must measure O₂ using one of the O₂ measurement methods specified in Table 4 of this subpart. Measurements to determine O₂ concentration must be made at the same time as the measurements for CO or THC concentration.
- (6) If you are demonstrating compliance with the CO or THC percent reduction requirement, you must measure CO or THC emissions and O₂ emissions simultaneously at the inlet and outlet of the control device.

CONTINUOUS COMPLIANCE REQUIREMENTS

§63.6635 How do I monitor and collect data to demonstrate continuous compliance?

- (a) If you must comply with emission and operating limitations, you must monitor and collect data according to this section.
- (b) Except for monitor malfunctions, associated repairs, required performance evaluations, and required quality assurance or control activities, you must monitor continuously at all times that the stationary RICE is operating. A monitoring malfunction is any sudden, infrequent, not reasonably preventable failure of the monitoring to provide valid data. Monitoring failures that are caused in part by poor maintenance or careless operation are not malfunctions.
- (c) You may not use data recorded during monitoring malfunctions, associated repairs, and required quality assurance or control activities in data averages and calculations used to report emission or operating levels. You must, however, use all the valid data collected during all other periods.

§63.6640 How do I demonstrate continuous compliance with the emission limitations, operating limitations, and other requirements?

- (a) You must demonstrate continuous compliance with each emission limitation, operating limitation, and other requirements in Tables 1a and 1b, Tables 2a and 2b, Table 2c, and Table 2d to this subpart that apply to you according to methods specified in Table 6 to this subpart.

(b) You must report each instance in which you did not meet each emission limitation or operating limitation in Tables 1a and 1b, Tables 2a and 2b, Table 2c, and Table 2d to this subpart that apply to you. These instances are deviations from the emission and operating limitations in this subpart. These deviations must be reported according to the requirements in §63.6650. If you change your catalyst, you must reestablish the values of the operating parameters measured during the initial performance test. When you reestablish the values of your operating parameters, you must also conduct a performance test to demonstrate that you are meeting the required emission limitation applicable to your stationary RICE.

(c) The annual compliance demonstration required for existing non-emergency 4SLB and 4SRB stationary RICE with a site rating of more than 500 HP located at an area source of HAP that are not remote stationary RICE and that are operated more than 24 hours per calendar year must be conducted according to the following requirements:

(1) The compliance demonstration must consist of at least one test run.

(2) Each test run must be of at least 15 minute duration, except that each test conducted using the method in appendix A to this subpart must consist of at least one measurement cycle and include at least 2 minutes of test data phase measurement.

(3) If you are demonstrating compliance with the CO concentration or CO percent reduction requirement, you must measure CO emissions using one of the CO measurement methods specified in Table 4 of this subpart, or using appendix A to this subpart.

(4) If you are demonstrating compliance with the THC percent reduction requirement, you must measure THC emissions using Method 25A, reported as propane, of 40 CFR part 60, appendix A.

(5) You must measure O₂ using one of the O₂ measurement methods specified in Table 4 of this subpart. Measurements to determine O₂ concentration must be made at the same time as the measurements for CO or THC concentration.

(6) If you are demonstrating compliance with the CO or THC percent reduction requirement, you must measure CO or THC emissions and O₂ emissions simultaneously at the inlet and outlet of the control device.

(7) If the results of the annual compliance demonstration show that the emissions exceed the levels specified in Table 6 of this subpart, the stationary RICE must be shut down as soon as safely possible, and appropriate corrective action must be taken (e.g., repairs, catalyst cleaning, catalyst replacement). The stationary RICE must be retested within 7 days of being restarted and the emissions must meet the levels specified in Table 6 of this subpart. If the retest shows that the emissions continue to exceed the specified levels, the stationary RICE must again be shut down as soon as safely possible, and the stationary RICE may not operate, except for purposes of startup and testing, until the owner/operator demonstrates through testing that the emissions do not exceed the levels specified in Table 6 of this subpart.

(d) For new, reconstructed, and rebuilt stationary RICE, deviations from the emission or operating limitations that occur during the first 200 hours of operation from engine startup (engine burn-in period) are not violations. Rebuilt stationary RICE means a stationary RICE that has been rebuilt as that term is defined in 40 CFR 94.11(a).

(e) You must also report each instance in which you did not meet the requirements in Table 8 to this subpart that apply to you. If you own or operate a new or reconstructed stationary RICE with a site rating of less than or equal to 500 brake HP located at a major source of HAP emissions (except new or reconstructed 4SLB engines greater than or equal to 250 and less than or equal to 500 brake HP), a new or reconstructed stationary RICE located at an area source of HAP emissions, or any of the following RICE with a site rating of more than 500 brake HP located at a major source of HAP emissions, you do not need to comply with the requirements in Table 8 to this subpart: An existing 2SLB stationary RICE, an existing 4SLB stationary RICE, an existing emergency stationary RICE, an existing limited use stationary RICE, or an existing stationary RICE which fires landfill gas or digester gas

equivalent to 10 percent or more of the gross heat input on an annual basis. If you own or operate any of the following RICE with a site rating of more than 500 brake HP located at a major source of HAP emissions, you do not need to comply with the requirements in Table 8 to this subpart, except for the initial notification requirements: a new or reconstructed stationary RICE that combusts landfill gas or digester gas equivalent to 10 percent or more of the gross heat input on an annual basis, a new or reconstructed emergency stationary RICE, or a new or reconstructed limited use stationary RICE.

(f) If you own or operate an emergency stationary RICE, you must operate the emergency stationary RICE according to the requirements in paragraphs (f)(1) through (4) of this section. In order for the engine to be considered an emergency stationary RICE under this subpart, any operation other than emergency operation, maintenance and testing, emergency demand response, and operation in non-emergency situations for 50 hours per year, as described in paragraphs (f)(1) through (4) of this section, is prohibited. If you do not operate the engine according to the requirements in paragraphs (f)(1) through (4) of this section, the engine will not be considered an emergency engine under this subpart and must meet all requirements for non-emergency engines.

(1) There is no time limit on the use of emergency stationary RICE in emergency situations.

(2) You may operate your emergency stationary RICE for any combination of the purposes specified in paragraphs (f)(2)(i) through (iii) of this section for a maximum of 100 hours per calendar year. Any operation for non-emergency situations as allowed by paragraphs (f)(3) and (4) of this section counts as part of the 100 hours per calendar year allowed by this paragraph (f)(2).

(i) Emergency stationary RICE may be operated for maintenance checks and readiness testing, provided that the tests are recommended by federal, state or local government, the manufacturer, the vendor, the regional transmission organization or equivalent balancing authority and transmission operator, or the insurance company associated with the engine. The owner or operator may petition the Administrator for approval of additional hours to be used for maintenance checks and readiness testing, but a petition is not required if the owner or operator maintains records indicating that federal, state, or local standards require maintenance and testing of emergency RICE beyond 100 hours per calendar year.

(ii) Emergency stationary RICE may be operated for emergency demand response for periods in which the Reliability Coordinator under the North American Electric Reliability Corporation (NERC) Reliability Standard EOP-002-3, Capacity and Energy Emergencies (incorporated by reference, see §63.14), or other authorized entity as determined by the Reliability Coordinator, has declared an Energy Emergency Alert Level 2 as defined in the NERC Reliability Standard EOP-002-3.

(iii) Emergency stationary RICE may be operated for periods where there is a deviation of voltage or frequency of 5 percent or greater below standard voltage or frequency.

(3) Emergency stationary RICE located at major sources of HAP may be operated for up to 50 hours per calendar year in non-emergency situations. The 50 hours of operation in non-emergency situations are counted as part of the 100 hours per calendar year for maintenance and testing and emergency demand response provided in paragraph (f)(2) of this section. The 50 hours per year for non-emergency situations cannot be used for peak shaving or non-emergency demand response, or to generate income for a facility to supply power to an electric grid or otherwise supply power as part of a financial arrangement with another entity.

(4) Emergency stationary RICE located at area sources of HAP may be operated for up to 50 hours per calendar year in non-emergency situations. The 50 hours of operation in non-emergency situations are counted as part of the 100 hours per calendar year for maintenance and testing and emergency demand response provided in paragraph (f)(2) of this section. Except as provided in paragraphs (f)(4)(i) and (ii) of this section, the 50 hours per year for non-emergency situations cannot be used for peak shaving or non-emergency demand response, or to generate income for a facility to an electric grid or otherwise supply power as part of a financial arrangement with another entity.

(i) Prior to May 3, 2014, the 50 hours per year for non-emergency situations can be used for peak shaving or non-emergency demand response to generate income for a facility, or to otherwise supply power as part of a financial arrangement with another entity if the engine is operated as part of a peak shaving (load management program) with the local distribution system operator and the power is provided only to the facility itself or to support the local distribution system.

(ii) The 50 hours per year for non-emergency situations can be used to supply power as part of a financial arrangement with another entity if all of the following conditions are met:

(A) The engine is dispatched by the local balancing authority or local transmission and distribution system operator.

(B) The dispatch is intended to mitigate local transmission and/or distribution limitations so as to avert potential voltage collapse or line overloads that could lead to the interruption of power supply in a local area or region.

(C) The dispatch follows reliability, emergency operation or similar protocols that follow specific NERC, regional, state, public utility commission or local standards or guidelines.

(D) The power is provided only to the facility itself or to support the local transmission and distribution system.

(E) The owner or operator identifies and records the entity that dispatches the engine and the specific NERC, regional, state, public utility commission or local standards or guidelines that are being followed for dispatching the engine. The local balancing authority or local transmission and distribution system operator may keep these records on behalf of the engine owner or operator.

NOTIFICATIONS, REPORTS, AND RECORDS

§63.6645 What notifications must I submit and when?

(a) You must submit all of the notifications in §§63.7(b) and (c), 63.8(e), (f)(4) and (f)(6), 63.9(b) through (e), and (g) and (h) that apply to you by the dates specified if you own or operate any of the following;

(1) An existing stationary RICE with a site rating of less than or equal to 500 brake HP located at a major source of HAP emissions.

(2) An existing stationary RICE located at an area source of HAP emissions.

(3) A stationary RICE with a site rating of more than 500 brake HP located at a major source of HAP emissions.

(4) A new or reconstructed 4SLB stationary RICE with a site rating of greater than or equal to 250 HP located at a major source of HAP emissions.

(5) This requirement does not apply if you own or operate an existing stationary RICE less than 100 HP, an existing stationary emergency RICE, or an existing stationary RICE that is not subject to any numerical emission standards.

(b) As specified in §63.9(b)(2), if you start up your stationary RICE with a site rating of more than 500 brake HP located at a major source of HAP emissions before the effective date of this subpart, you must submit an Initial Notification not later than December 13, 2004.

(c) If you start up your new or reconstructed stationary RICE with a site rating of more than 500 brake HP located at a major source of HAP emissions on or after August 16, 2004, you must submit an Initial Notification not later than 120 days after you become subject to this subpart.

(d) As specified in §63.9(b)(2), if you start up your stationary RICE with a site rating of equal to or less than 500 brake HP located at a major source of HAP emissions before the effective date of this subpart and you are required to submit an initial notification, you must submit an Initial Notification not later than July 16, 2008.

(e) If you start up your new or reconstructed stationary RICE with a site rating of equal to or less than 500 brake HP located at a major source of HAP emissions on or after March 18, 2008 and you are required to submit an initial notification, you must submit an Initial Notification not later than 120 days after you become subject to this subpart.

(f) If you are required to submit an Initial Notification but are otherwise not affected by the requirements of this subpart, in accordance with §63.6590(b), your notification should include the information in §63.9(b)(2)(i) through (v), and a statement that your stationary RICE has no additional requirements and explain the basis of the exclusion (for example, that it operates exclusively as an emergency stationary RICE if it has a site rating of more than 500 brake HP located at a major source of HAP emissions).

(g) If you are required to conduct a performance test, you must submit a Notification of Intent to conduct a performance test at least 60 days before the performance test is scheduled to begin as required in §63.7(b)(1).

(h) If you are required to conduct a performance test or other initial compliance demonstration as specified in Tables 4 and 5 to this subpart, you must submit a Notification of Compliance Status according to §63.9(h)(2)(ii).

(1) For each initial compliance demonstration required in Table 5 to this subpart that does not include a performance test, you must submit the Notification of Compliance Status before the close of business on the 30th day following the completion of the initial compliance demonstration.

(2) For each initial compliance demonstration required in Table 5 to this subpart that includes a performance test conducted according to the requirements in Table 3 to this subpart, you must submit the Notification of Compliance Status, including the performance test results, before the close of business on the 60th day following the completion of the performance test according to §63.10(d)(2).

(i) If you own or operate an existing non-emergency CI RICE with a site rating of more than 300 HP located at an area source of HAP emissions that is certified to the Tier 1 or Tier 2 emission standards in Table 1 of 40 CFR 89.112 and subject to an enforceable state or local standard requiring engine replacement and you intend to meet management practices rather than emission limits, as specified in §63.6603(d), you must submit a notification by March 3, 2013, stating that you intend to use the provision in §63.6603(d) and identifying the state or local regulation that the engine is subject to.

§63.6650 What reports must I submit and when?

(a) You must submit each report in Table 7 of this subpart that applies to you.

(b) Unless the Administrator has approved a different schedule for submission of reports under §63.10(a), you must submit each report by the date in Table 7 of this subpart and according to the requirements in paragraphs (b)(1) through (b)(9) of this section.

(1) For semiannual Compliance reports, the first Compliance report must cover the period beginning on the compliance date that is specified for your affected source in §63.6595 and ending on June 30 or December 31, whichever date is the first date following the end of the first calendar half after the compliance date that is specified for your source in §63.6595.

(2) For semiannual Compliance reports, the first Compliance report must be postmarked or delivered no later than July 31 or January 31, whichever date follows the end of the first calendar half after the compliance date that is specified for your affected source in §63.6595.

(3) For semiannual Compliance reports, each subsequent Compliance report must cover the semiannual reporting period from January 1 through June 30 or the semiannual reporting period from July 1 through December 31.

(4) For semiannual Compliance reports, each subsequent Compliance report must be postmarked or delivered no later than July 31 or January 31, whichever date is the first date following the end of the semiannual reporting period.

(5) For each stationary RICE that is subject to permitting regulations pursuant to 40 CFR part 70 or 71, and if the permitting authority has established dates for submitting semiannual reports pursuant to 40 CFR 70.6(a)(3)(iii)(A) or 40 CFR 71.6 (a)(3)(iii)(A), you may submit the first and subsequent Compliance reports according to the dates the permitting authority has established instead of according to the dates in paragraphs (b)(1) through (b)(4) of this section.

(6) For annual Compliance reports, the first Compliance report must cover the period beginning on the compliance date that is specified for your affected source in §63.6595 and ending on December 31.

(7) For annual Compliance reports, the first Compliance report must be postmarked or delivered no later than January 31 following the end of the first calendar year after the compliance date that is specified for your affected source in §63.6595.

(8) For annual Compliance reports, each subsequent Compliance report must cover the annual reporting period from January 1 through December 31.

(9) For annual Compliance reports, each subsequent Compliance report must be postmarked or delivered no later than January 31.

(c) The Compliance report must contain the information in paragraphs (c)(1) through (6) of this section.

(1) Company name and address.

(2) Statement by a responsible official, with that official's name, title, and signature, certifying the accuracy of the content of the report.

(3) Date of report and beginning and ending dates of the reporting period.

(4) If you had a malfunction during the reporting period, the compliance report must include the number, duration, and a brief description for each type of malfunction which occurred during the reporting period and which caused or may have caused any applicable emission limitation to be exceeded. The report must also include a

description of actions taken by an owner or operator during a malfunction of an affected source to minimize emissions in accordance with §63.6605(b), including actions taken to correct a malfunction.

(5) If there are no deviations from any emission or operating limitations that apply to you, a statement that there were no deviations from the emission or operating limitations during the reporting period.

(6) If there were no periods during which the continuous monitoring system (CMS), including CEMS and CPMS, was out-of-control, as specified in §63.8(c)(7), a statement that there were no periods during which the CMS was out-of-control during the reporting period.

(d) For each deviation from an emission or operating limitation that occurs for a stationary RICE where you are not using a CMS to comply with the emission or operating limitations in this subpart, the Compliance report must contain the information in paragraphs (c)(1) through (4) of this section and the information in paragraphs (d)(1) and (2) of this section.

(1) The total operating time of the stationary RICE at which the deviation occurred during the reporting period.

(2) Information on the number, duration, and cause of deviations (including unknown cause, if applicable), as applicable, and the corrective action taken.

(e) For each deviation from an emission or operating limitation occurring for a stationary RICE where you are using a CMS to comply with the emission and operating limitations in this subpart, you must include information in paragraphs (c)(1) through (4) and (e)(1) through (12) of this section.

(1) The date and time that each malfunction started and stopped.

(2) The date, time, and duration that each CMS was inoperative, except for zero (low-level) and high-level checks.

(3) The date, time, and duration that each CMS was out-of-control, including the information in §63.8(c)(8).

(4) The date and time that each deviation started and stopped, and whether each deviation occurred during a period of malfunction or during another period.

(5) A summary of the total duration of the deviation during the reporting period, and the total duration as a percent of the total source operating time during that reporting period.

(6) A breakdown of the total duration of the deviations during the reporting period into those that are due to control equipment problems, process problems, other known causes, and other unknown causes.

(7) A summary of the total duration of CMS downtime during the reporting period, and the total duration of CMS downtime as a percent of the total operating time of the stationary RICE at which the CMS downtime occurred during that reporting period.

(8) An identification of each parameter and pollutant (CO or formaldehyde) that was monitored at the stationary RICE.

(9) A brief description of the stationary RICE.

(10) A brief description of the CMS.

(11) The date of the latest CMS certification or audit.

(12) A description of any changes in CMS, processes, or controls since the last reporting period.

(f) Each affected source that has obtained a title V operating permit pursuant to 40 CFR part 70 or 71 must report all deviations as defined in this subpart in the semiannual monitoring report required by 40 CFR 70.6(a)(3)(iii)(A) or 40 CFR 71.6(a)(3)(iii)(A). If an affected source submits a Compliance report pursuant to Table 7 of this subpart along with, or as part of, the semiannual monitoring report required by 40 CFR 70.6(a)(3)(iii)(A) or 40 CFR 71.6(a)(3)(iii)(A), and the Compliance report includes all required information concerning deviations from any emission or operating limitation in this subpart, submission of the Compliance report shall be deemed to satisfy any obligation to report the same deviations in the semiannual monitoring report. However, submission of a Compliance report shall not otherwise affect any obligation the affected source may have to report deviations from permit requirements to the permit authority.

(g) If you are operating as a new or reconstructed stationary RICE which fires landfill gas or digester gas equivalent to 10 percent or more of the gross heat input on an annual basis, you must submit an annual report according to Table 7 of this subpart by the date specified unless the Administrator has approved a different schedule, according to the information described in paragraphs (b)(1) through (b)(5) of this section. You must report the data specified in (g)(1) through (g)(3) of this section.

(1) Fuel flow rate of each fuel and the heating values that were used in your calculations. You must also demonstrate that the percentage of heat input provided by landfill gas or digester gas is equivalent to 10 percent or more of the total fuel consumption on an annual basis.

(2) The operating limits provided in your federally enforceable permit, and any deviations from these limits.

(3) Any problems or errors suspected with the meters.

(h) If you own or operate an emergency stationary RICE with a site rating of more than 100 brake HP that operates or is contractually obligated to be available for more than 15 hours per calendar year for the purposes specified in §63.6640(f)(2)(ii) and (iii) or that operates for the purpose specified in §63.6640(f)(4)(ii), you must submit an annual report according to the requirements in paragraphs (h)(1) through (3) of this section.

(1) The report must contain the following information:

(i) Company name and address where the engine is located.

(ii) Date of the report and beginning and ending dates of the reporting period.

(iii) Engine site rating and model year.

(iv) Latitude and longitude of the engine in decimal degrees reported to the fifth decimal place.

(v) Hours operated for the purposes specified in §63.6640(f)(2)(ii) and (iii), including the date, start time, and end time for engine operation for the purposes specified in §63.6640(f)(2)(ii) and (iii).

(vi) Number of hours the engine is contractually obligated to be available for the purposes specified in §63.6640(f)(2)(ii) and (iii).

(vii) Hours spent for operation for the purpose specified in §63.6640(f)(4)(ii), including the date, start time, and end time for engine operation for the purposes specified in §63.6640(f)(4)(ii). The report must also identify the entity that dispatched the engine and the situation that necessitated the dispatch of the engine.

(viii) If there were no deviations from the fuel requirements in §63.6604 that apply to the engine (if any), a statement that there were no deviations from the fuel requirements during the reporting period.

(ix) If there were deviations from the fuel requirements in §63.6604 that apply to the engine (if any), information on the number, duration, and cause of deviations, and the corrective action taken.

(2) The first annual report must cover the calendar year 2015 and must be submitted no later than March 31, 2016. Subsequent annual reports for each calendar year must be submitted no later than March 31 of the following calendar year.

(3) The annual report must be submitted electronically using the subpart specific reporting form in the Compliance and Emissions Data Reporting Interface (CEDRI) that is accessed through EPA's Central Data Exchange (CDX) (www.epa.gov/cdx). However, if the reporting form specific to this subpart is not available in CEDRI at the time that the report is due, the written report must be submitted to the Administrator at the appropriate address listed in §63.13.

§63.6655 What records must I keep?

(a) If you must comply with the emission and operating limitations, you must keep the records described in paragraphs (a)(1) through (a)(5), (b)(1) through (b)(3) and (c) of this section.

(1) A copy of each notification and report that you submitted to comply with this subpart, including all documentation supporting any Initial Notification or Notification of Compliance Status that you submitted, according to the requirement in §63.10(b)(2)(xiv).

(2) Records of the occurrence and duration of each malfunction of operation (*i.e.*, process equipment) or the air pollution control and monitoring equipment.

(3) Records of performance tests and performance evaluations as required in §63.10(b)(2)(viii).

(4) Records of all required maintenance performed on the air pollution control and monitoring equipment.

(5) Records of actions taken during periods of malfunction to minimize emissions in accordance with §63.6605(b), including corrective actions to restore malfunctioning process and air pollution control and monitoring equipment to its normal or usual manner of operation.

(b) For each CEMS or CPMS, you must keep the records listed in paragraphs (b)(1) through (3) of this section.

(1) Records described in §63.10(b)(2)(vi) through (xi).

(2) Previous (*i.e.*, superseded) versions of the performance evaluation plan as required in §63.8(d)(3).

(3) Requests for alternatives to the relative accuracy test for CEMS or CPMS as required in §63.8(f)(6)(i), if applicable.

(c) If you are operating a new or reconstructed stationary RICE which fires landfill gas or digester gas equivalent to 10 percent or more of the gross heat input on an annual basis, you must keep the records of your daily fuel usage monitors.

(d) You must keep the records required in Table 6 of this subpart to show continuous compliance with each emission or operating limitation that applies to you.

(e) You must keep records of the maintenance conducted on the stationary RICE in order to demonstrate that you operated and maintained the stationary RICE and after-treatment control device (if any) according to your own maintenance plan if you own or operate any of the following stationary RICE;

(1) An existing stationary RICE with a site rating of less than 100 brake HP located at a major source of HAP emissions.

(2) An existing stationary emergency RICE.

(3) An existing stationary RICE located at an area source of HAP emissions subject to management practices as shown in Table 2d to this subpart.

(f) If you own or operate any of the stationary RICE in paragraphs (f)(1) through (2) of this section, you must keep records of the hours of operation of the engine that is recorded through the non-resettable hour meter. The owner or operator must document how many hours are spent for emergency operation, including what classified the operation as emergency and how many hours are spent for non-emergency operation. If the engine is used for the purposes specified in §63.6640(f)(2)(ii) or (iii) or §63.6640(f)(4)(ii), the owner or operator must keep records of the notification of the emergency situation, and the date, start time, and end time of engine operation for these purposes.

(1) An existing emergency stationary RICE with a site rating of less than or equal to 500 brake HP located at a major source of HAP emissions that does not meet the standards applicable to non-emergency engines.

(2) An existing emergency stationary RICE located at an area source of HAP emissions that does not meet the standards applicable to non-emergency engines.

§63.6660 In what form and how long must I keep my records?

(a) Your records must be in a form suitable and readily available for expeditious review according to §63.10(b)(1).

(b) As specified in §63.10(b)(1), you must keep each record for 5 years following the date of each occurrence, measurement, maintenance, corrective action, report, or record.

(c) You must keep each record readily accessible in hard copy or electronic form for at least 5 years after the date of each occurrence, measurement, maintenance, corrective action, report, or record, according to §63.10(b)(1).

OTHER REQUIREMENTS AND INFORMATION

§63.6665 What parts of the General Provisions apply to me?

Table 8 to this subpart shows which parts of the General Provisions in §§63.1 through 63.15 apply to you. If you own or operate a new or reconstructed stationary RICE with a site rating of less than or equal to 500 brake HP located at a major source of HAP emissions (except new or reconstructed 4SLB engines greater than or equal to 250 and less than or equal to 500 brake HP), a new or reconstructed stationary RICE located at an area source of HAP emissions, or any of the following RICE with a site rating of more than 500 brake HP located at a major source of HAP emissions, you do not need to comply with any of the requirements of the General Provisions specified in

Table 8: An existing 2SLB stationary RICE, an existing 4SLB stationary RICE, an existing stationary RICE that combusts landfill or digester gas equivalent to 10 percent or more of the gross heat input on an annual basis, an existing emergency stationary RICE, or an existing limited use stationary RICE. If you own or operate any of the following RICE with a site rating of more than 500 brake HP located at a major source of HAP emissions, you do not need to comply with the requirements in the General Provisions specified in Table 8 except for the initial notification requirements: A new stationary RICE that combusts landfill gas or digester gas equivalent to 10 percent or more of the gross heat input on an annual basis, a new emergency stationary RICE, or a new limited use stationary RICE.

§63.6670 Who implements and enforces this subpart?

(a) This subpart is implemented and enforced by the U.S. EPA, or a delegated authority such as your State, local, or tribal agency. If the U.S. EPA Administrator has delegated authority to your State, local, or tribal agency, then that agency (as well as the U.S. EPA) has the authority to implement and enforce this subpart. You should contact your U.S. EPA Regional Office to find out whether this subpart is delegated to your State, local, or tribal agency.

(b) In delegating implementation and enforcement authority of this subpart to a State, local, or tribal agency under 40 CFR part 63, subpart E, the authorities contained in paragraph (c) of this section are retained by the Administrator of the U.S. EPA and are not transferred to the State, local, or tribal agency.

(c) The authorities that will not be delegated to State, local, or tribal agencies are:

(1) Approval of alternatives to the non-opacity emission limitations and operating limitations in §63.6600 under §63.6(g).

(2) Approval of major alternatives to test methods under §63.7(e)(2)(ii) and (f) and as defined in §63.90.

(3) Approval of major alternatives to monitoring under §63.8(f) and as defined in §63.90.

(4) Approval of major alternatives to recordkeeping and reporting under §63.10(f) and as defined in §63.90.

(5) Approval of a performance test which was conducted prior to the effective date of the rule, as specified in §63.6610(b).

§63.6675 What definitions apply to this subpart?

Terms used in this subpart are defined in the Clean Air Act (CAA); in 40 CFR 63.2, the General Provisions of this part; and in this section as follows:

Alaska Railbelt Grid means the service areas of the six regulated public utilities that extend from Fairbanks to Anchorage and the Kenai Peninsula. These utilities are Golden Valley Electric Association; Chugach Electric Association; Matanuska Electric Association; Homer Electric Association; Anchorage Municipal Light & Power; and the City of Seward Electric System.

Area source means any stationary source of HAP that is not a major source as defined in part 63.

Associated equipment as used in this subpart and as referred to in section 112(n)(4) of the CAA, means equipment associated with an oil or natural gas exploration or production well, and includes all equipment from the

well bore to the point of custody transfer, except glycol dehydration units, storage vessels with potential for flash emissions, combustion turbines, and stationary RICE.

Backup power for renewable energy means an engine that provides backup power to a facility that generates electricity from renewable energy resources, as that term is defined in Alaska Statute 42.45.045(1)(5) (incorporated by reference, see §63.14).

Black start engine means an engine whose only purpose is to start up a combustion turbine.

CAA means the Clean Air Act (42 U.S.C. 7401 *et seq.*, as amended by Public Law 101-549, 104 Stat. 2399).

Commercial emergency stationary RICE means an emergency stationary RICE used in commercial establishments such as office buildings, hotels, stores, telecommunications facilities, restaurants, financial institutions such as banks, doctor's offices, and sports and performing arts facilities.

Compression ignition means relating to a type of stationary internal combustion engine that is not a spark ignition engine.

Custody transfer means the transfer of hydrocarbon liquids or natural gas: After processing and/or treatment in the producing operations, or from storage vessels or automatic transfer facilities or other such equipment, including product loading racks, to pipelines or any other forms of transportation. For the purposes of this subpart, the point at which such liquids or natural gas enters a natural gas processing plant is a point of custody transfer.

Deviation means any instance in which an affected source subject to this subpart, or an owner or operator of such a source:

(1) Fails to meet any requirement or obligation established by this subpart, including but not limited to any emission limitation or operating limitation;

(2) Fails to meet any term or condition that is adopted to implement an applicable requirement in this subpart and that is included in the operating permit for any affected source required to obtain such a permit; or

(3) Fails to meet any emission limitation or operating limitation in this subpart during malfunction, regardless of whether or not such failure is permitted by this subpart.

(4) Fails to satisfy the general duty to minimize emissions established by §63.6(e)(1)(i).

Diesel engine means any stationary RICE in which a high boiling point liquid fuel injected into the combustion chamber ignites when the air charge has been compressed to a temperature sufficiently high for auto-ignition. This process is also known as compression ignition.

Diesel fuel means any liquid obtained from the distillation of petroleum with a boiling point of approximately 150 to 360 degrees Celsius. One commonly used form is fuel oil number 2. Diesel fuel also includes any non-distillate fuel with comparable physical and chemical properties (*e.g.* biodiesel) that is suitable for use in compression ignition engines.

Digester gas means any gaseous by-product of wastewater treatment typically formed through the anaerobic decomposition of organic waste materials and composed principally of methane and CO₂.

Dual-fuel engine means any stationary RICE in which a liquid fuel (typically diesel fuel) is used for compression ignition and gaseous fuel (typically natural gas) is used as the primary fuel.

Emergency stationary RICE means any stationary reciprocating internal combustion engine that meets all of the criteria in paragraphs (1) through (3) of this definition. All emergency stationary RICE must comply with the requirements specified in §63.6640(f) in order to be considered emergency stationary RICE. If the engine does not comply with the requirements specified in §63.6640(f), then it is not considered to be an emergency stationary RICE under this subpart.

(1) The stationary RICE is operated to provide electrical power or mechanical work during an emergency situation. Examples include stationary RICE used to produce power for critical networks or equipment (including power supplied to portions of a facility) when electric power from the local utility (or the normal power source, if the facility runs on its own power production) is interrupted, or stationary RICE used to pump water in the case of fire or flood, etc.

(2) The stationary RICE is operated under limited circumstances for situations not included in paragraph (1) of this definition, as specified in §63.6640(f).

(3) The stationary RICE operates as part of a financial arrangement with another entity in situations not included in paragraph (1) of this definition only as allowed in §63.6640(f)(2)(ii) or (iii) and §63.6640(f)(4)(i) or (ii).

Engine startup means the time from initial start until applied load and engine and associated equipment reaches steady state or normal operation. For stationary engine with catalytic controls, engine startup means the time from initial start until applied load and engine and associated equipment, including the catalyst, reaches steady state or normal operation.

Four-stroke engine means any type of engine which completes the power cycle in two crankshaft revolutions, with intake and compression strokes in the first revolution and power and exhaust strokes in the second revolution.

Gaseous fuel means a material used for combustion which is in the gaseous state at standard atmospheric temperature and pressure conditions.

Gasoline means any fuel sold in any State for use in motor vehicles and motor vehicle engines, or nonroad or stationary engines, and commonly or commercially known or sold as gasoline.

Glycol dehydration unit means a device in which a liquid glycol (including, but not limited to, ethylene glycol, diethylene glycol, or triethylene glycol) absorbent directly contacts a natural gas stream and absorbs water in a contact tower or absorption column (absorber). The glycol contacts and absorbs water vapor and other gas stream constituents from the natural gas and becomes "rich" glycol. This glycol is then regenerated in the glycol dehydration unit reboiler. The "lean" glycol is then recycled.

Hazardous air pollutants (HAP) means any air pollutants listed in or pursuant to section 112(b) of the CAA.

Institutional emergency stationary RICE means an emergency stationary RICE used in institutional establishments such as medical centers, nursing homes, research centers, institutions of higher education, correctional facilities, elementary and secondary schools, libraries, religious establishments, police stations, and fire stations.

ISO standard day conditions means 288 degrees Kelvin (15 degrees Celsius), 60 percent relative humidity and 101.3 kilopascals pressure.

Landfill gas means a gaseous by-product of the land application of municipal refuse typically formed through the anaerobic decomposition of waste materials and composed principally of methane and CO₂.

Lean burn engine means any two-stroke or four-stroke spark ignited engine that does not meet the definition of a rich burn engine.

Limited use stationary RICE means any stationary RICE that operates less than 100 hours per year.

Liquefied petroleum gas means any liquefied hydrocarbon gas obtained as a by-product in petroleum refining of natural gas production.

Liquid fuel means any fuel in liquid form at standard temperature and pressure, including but not limited to diesel, residual/crude oil, kerosene/naphtha (jet fuel), and gasoline.

Major Source, as used in this subpart, shall have the same meaning as in §63.2, except that:

(1) Emissions from any oil or gas exploration or production well (with its associated equipment (as defined in this section)) and emissions from any pipeline compressor station or pump station shall not be aggregated with emissions from other similar units, to determine whether such emission points or stations are major sources, even when emission points are in a contiguous area or under common control;

(2) For oil and gas production facilities, emissions from processes, operations, or equipment that are not part of the same oil and gas production facility, as defined in §63.1271 of subpart HHH of this part, shall not be aggregated;

(3) For production field facilities, only HAP emissions from glycol dehydration units, storage vessel with the potential for flash emissions, combustion turbines and reciprocating internal combustion engines shall be aggregated for a major source determination; and

(4) Emissions from processes, operations, and equipment that are not part of the same natural gas transmission and storage facility, as defined in §63.1271 of subpart HHH of this part, shall not be aggregated.

Malfunction means any sudden, infrequent, and not reasonably preventable failure of air pollution control equipment, process equipment, or a process to operate in a normal or usual manner which causes, or has the potential to cause, the emission limitations in an applicable standard to be exceeded. Failures that are caused in part by poor maintenance or careless operation are not malfunctions.

Natural gas means a naturally occurring mixture of hydrocarbon and non-hydrocarbon gases found in geologic formations beneath the Earth's surface, of which the principal constituent is methane. Natural gas may be field or pipeline quality.

Non-selective catalytic reduction (NSCR) means an add-on catalytic nitrogen oxides (NO_x) control device for rich burn engines that, in a two-step reaction, promotes the conversion of excess oxygen, NO_x, CO, and volatile organic compounds (VOC) into CO₂, nitrogen, and water.

Oil and gas production facility as used in this subpart means any grouping of equipment where hydrocarbon liquids are processed, upgraded (*i.e.*, remove impurities or other constituents to meet contract specifications), or stored prior to the point of custody transfer; or where natural gas is processed, upgraded, or stored prior to entering the natural gas transmission and storage source category. For purposes of a major source determination, facility (including a building, structure, or installation) means oil and natural gas production and processing equipment that is located within the boundaries of an individual surface site as defined in this section. Equipment that is part of a facility will typically be located within close proximity to other equipment located at the same facility. Pieces of production equipment or groupings of equipment located on different oil and gas leases, mineral fee tracts, lease tracts, subsurface or surface unit areas, surface fee tracts, surface lease tracts, or separate surface sites, whether or not connected by a road, waterway, power line or pipeline, shall not be considered part of the same facility. Examples of facilities in the oil and natural gas production source category include, but are not limited to, well sites, satellite tank batteries, central tank batteries, a compressor station that transports natural gas to a natural gas processing plant, and natural gas processing plants.

Oxidation catalyst means an add-on catalytic control device that controls CO and VOC by oxidation.

Peaking unit or engine means any standby engine intended for use during periods of high demand that are not emergencies.

Percent load means the fractional power of an engine compared to its maximum manufacturer's design capacity at engine site conditions. Percent load may range between 0 percent to above 100 percent.

Potential to emit means the maximum capacity of a stationary source to emit a pollutant under its physical and operational design. Any physical or operational limitation on the capacity of the stationary source to emit a pollutant, including air pollution control equipment and restrictions on hours of operation or on the type or amount of material combusted, stored, or processed, shall be treated as part of its design if the limitation or the effect it would have on emissions is federally enforceable. For oil and natural gas production facilities subject to subpart HH of this part, the potential to emit provisions in §63.760(a) may be used. For natural gas transmission and storage facilities subject to subpart HHH of this part, the maximum annual facility gas throughput for storage facilities may be determined according to §63.1270(a)(1) and the maximum annual throughput for transmission facilities may be determined according to §63.1270(a)(2).

Production field facility means those oil and gas production facilities located prior to the point of custody transfer.

Production well means any hole drilled in the earth from which crude oil, condensate, or field natural gas is extracted.

Propane means a colorless gas derived from petroleum and natural gas, with the molecular structure C_3H_8 .

Remote stationary RICE means stationary RICE meeting any of the following criteria:

(1) Stationary RICE located in an offshore area that is beyond the line of ordinary low water along that portion of the coast of the United States that is in direct contact with the open seas and beyond the line marking the seaward limit of inland waters.

(2) Stationary RICE located on a pipeline segment that meets both of the criteria in paragraphs (2)(i) and (ii) of this definition.

(i) A pipeline segment with 10 or fewer buildings intended for human occupancy and no buildings with four or more stories within 220 yards (200 meters) on either side of the centerline of any continuous 1-mile (1.6 kilometers) length of pipeline. Each separate dwelling unit in a multiple dwelling unit building is counted as a separate building intended for human occupancy.

(ii) The pipeline segment does not lie within 100 yards (91 meters) of either a building or a small, well-defined outside area (such as a playground, recreation area, outdoor theater, or other place of public assembly) that is occupied by 20 or more persons on at least 5 days a week for 10 weeks in any 12-month period. The days and weeks need not be consecutive. The building or area is considered occupied for a full day if it is occupied for any portion of the day.

(iii) For purposes of this paragraph (2), the term pipeline segment means all parts of those physical facilities through which gas moves in transportation, including but not limited to pipe, valves, and other appurtenance attached to pipe, compressor units, metering stations, regulator stations, delivery stations, holders, and fabricated assemblies. Stationary RICE located within 50 yards (46 meters) of the pipeline segment providing power for equipment on a pipeline segment are part of the pipeline segment. Transportation of gas means the gathering, transmission, or distribution of gas by pipeline, or the storage of gas. A building is intended for human occupancy if its primary use is for a purpose involving the presence of humans.

(3) Stationary RICE that are not located on gas pipelines and that have 5 or fewer buildings intended for human occupancy and no buildings with four or more stories within a 0.25 mile radius around the engine. A building is intended for human occupancy if its primary use is for a purpose involving the presence of humans.

Residential emergency stationary RICE means an emergency stationary RICE used in residential establishments such as homes or apartment buildings.

Responsible official means responsible official as defined in 40 CFR 70.2.

Rich burn engine means any four-stroke spark ignited engine where the manufacturer's recommended operating air/fuel ratio divided by the stoichiometric air/fuel ratio at full load conditions is less than or equal to 1.1. Engines originally manufactured as rich burn engines, but modified prior to December 19, 2002 with passive emission control technology for NO_x (such as pre-combustion chambers) will be considered lean burn engines. Also, existing engines where there are no manufacturer's recommendations regarding air/fuel ratio will be considered a rich burn engine if the excess oxygen content of the exhaust at full load conditions is less than or equal to 2 percent.

Site-rated HP means the maximum manufacturer's design capacity at engine site conditions.

Spark ignition means relating to either: A gasoline-fueled engine; or any other type of engine with a spark plug (or other sparking device) and with operating characteristics significantly similar to the theoretical Otto combustion cycle. Spark ignition engines usually use a throttle to regulate intake air flow to control power during normal operation. Dual-fuel engines in which a liquid fuel (typically diesel fuel) is used for CI and gaseous fuel (typically natural gas) is used as the primary fuel at an annual average ratio of less than 2 parts diesel fuel to 100 parts total fuel on an energy equivalent basis are spark ignition engines.

Stationary reciprocating internal combustion engine (RICE) means any reciprocating internal combustion engine which uses reciprocating motion to convert heat energy into mechanical work and which is not mobile. Stationary RICE differ from mobile RICE in that a stationary RICE is not a non-road engine as defined at 40 CFR 1068.30, and is not used to propel a motor vehicle or a vehicle used solely for competition.

Stationary RICE test cell/stand means an engine test cell/stand, as defined in subpart P of this part, that tests stationary RICE.

Stoichiometric means the theoretical air-to-fuel ratio required for complete combustion.

Storage vessel with the potential for flash emissions means any storage vessel that contains a hydrocarbon liquid with a stock tank gas-to-oil ratio equal to or greater than 0.31 cubic meters per liter and an American Petroleum Institute gravity equal to or greater than 40 degrees and an actual annual average hydrocarbon liquid throughput equal to or greater than 79,500 liters per day. Flash emissions occur when dissolved hydrocarbons in the fluid evolve from solution when the fluid pressure is reduced.

Subpart means 40 CFR part 63, subpart ZZZZ.

Surface site means any combination of one or more graded pad sites, gravel pad sites, foundations, platforms, or the immediate physical location upon which equipment is physically affixed.

Two-stroke engine means a type of engine which completes the power cycle in single crankshaft revolution by combining the intake and compression operations into one stroke and the power and exhaust operations into a second stroke. This system requires auxiliary scavenging and inherently runs lean of stoichiometric.

Table 1a to Subpart ZZZZ of Part 63—Emission Limitations for Existing, New, and Reconstructed Spark Ignition, 4SRB Stationary RICE >500 HP Located at a Major Source of HAP Emissions

As stated in §§63.6600 and 63.6640, you must comply with the following emission limitations at 100 percent load plus or minus 10 percent for existing, new and reconstructed 4SRB stationary RICE >500 HP located at a major source of HAP emissions:

For each . . .	You must meet the following emission limitation, except during periods of startup . . .	During periods of startup you must . . .
1. 4SRB stationary RICE	a. Reduce formaldehyde emissions by 76 percent or more. If you commenced construction or reconstruction between December 19, 2002 and June 15, 2004, you may reduce formaldehyde emissions by 75 percent or more until June 15, 2007 or	Minimize the engine's time spent at idle and minimize the engine's startup time at startup to a period needed for appropriate and safe loading of the engine, not to exceed 30 minutes, after which time the non-startup emission limitations apply. ¹
	b. Limit the concentration of formaldehyde in the stationary RICE exhaust to 350 ppbvd or less at 15 percent O ₂	

¹ Sources can petition the Administrator pursuant to the requirements of 40 CFR 63.6(g) for alternative work practices.

Table 1b to Subpart ZZZZ of Part 63—Operating Limitations for Existing, New, and Reconstructed SI 4SRB Stationary RICE >500 HP Located at a Major Source of HAP Emissions

As stated in §§63.6600, 63.6603, 63.6630 and 63.6640, you must comply with the following operating limitations for existing, new and reconstructed 4SRB stationary RICE >500 HP located at a major source of HAP emissions:

For each . . .	You must meet the following operating limitation, except during periods of startup . . .
1. existing, new and reconstructed 4SRB stationary RICE >500 HP located at a major source of HAP emissions complying with the requirement to reduce formaldehyde emissions by 76 percent or more (or by 75 percent or more, if applicable) and using NSCR; or existing, new and reconstructed 4SRB stationary RICE >500 HP located at a major source of HAP emissions complying with the requirement to limit the concentration of formaldehyde in the stationary RICE exhaust to 350 ppbvd or less at 15 percent O ₂ and using NSCR;	a. maintain your catalyst so that the pressure drop across the catalyst does not change by more than 2 inches of water at 100 percent load plus or minus 10 percent from the pressure drop across the catalyst measured during the initial performance test; and b. maintain the temperature of your stationary RICE exhaust so that the catalyst inlet temperature is greater than or equal to 750 °F and less than or equal to 1250 °F. ¹
2. existing, new and reconstructed 4SRB stationary RICE >500 HP located at a major source of HAP emissions complying with the requirement to reduce formaldehyde emissions by 76 percent or more (or by 75 percent or more, if applicable) and not using NSCR; or	Comply with any operating limitations approved by the Administrator.
existing, new and reconstructed 4SRB stationary RICE >500 HP located at a major source of HAP emissions complying with the requirement to limit the concentration	

of formaldehyde in the stationary RICE exhaust to 350 ppbvd or less at 15 percent O ₂ and not using NSCR.	
----------------------------------------------------------------------------------------------------------------------	--

¹Sources can petition the Administrator pursuant to the requirements of 40 CFR 63.8(f) for a different temperature range.

Table 2a to Subpart ZZZZ of Part 63—Emission Limitations for New and Reconstructed 2SLB and Compression Ignition Stationary RICE >500 HP and New and Reconstructed 4SLB Stationary RICE ≥250 HP Located at a Major Source of HAP Emissions

As stated in §§63.6600 and 63.6640, you must comply with the following emission limitations for new and reconstructed lean burn and new and reconstructed compression ignition stationary RICE at 100 percent load plus or minus 10 percent:

For each . . .	You must meet the following emission limitation, except during periods of startup . . .	During periods of startup you must . . .
1. 2SLB stationary RICE	a. Reduce CO emissions by 58 percent or more; or b. Limit concentration of formaldehyde in the stationary RICE exhaust to 12 ppmvd or less at 15 percent O ₂ . If you commenced construction or reconstruction between December 19, 2002 and June 15, 2004, you may limit concentration of formaldehyde to 17 ppmvd or less at 15 percent O ₂ until June 15, 2007	Minimize the engine's time spent at idle and minimize the engine's startup time at startup to a period needed for appropriate and safe loading of the engine, not to exceed 30 minutes, after which time the non-startup emission limitations apply. ¹
2. 4SLB stationary RICE	a. Reduce CO emissions by 93 percent or more; or	
	b. Limit concentration of formaldehyde in the stationary RICE exhaust to 14 ppmvd or less at 15 percent O ₂	
3. CI stationary RICE	a. Reduce CO emissions by 70 percent or more; or	
	b. Limit concentration of formaldehyde in the stationary RICE exhaust to 580 ppbvd or less at 15 percent O ₂	

¹Sources can petition the Administrator pursuant to the requirements of 40 CFR 63.6(g) for alternative work practices.

Table 2b to Subpart ZZZZ of Part 63—Operating Limitations for New and Reconstructed 2SLB and CI Stationary RICE >500 HP Located at a Major Source of HAP Emissions, New and Reconstructed 4SLB Stationary RICE ≥250 HP Located at a Major Source of HAP Emissions, Existing CI Stationary RICE >500 HP

As stated in §§63.6600, 63.6601, 63.6603, 63.6630, and 63.6640, you must comply with the following operating limitations for new and reconstructed 2SLB and CI stationary RICE >500 HP located at a major source of HAP emissions; new and reconstructed 4SLB stationary RICE ≥250 HP located at a major source of HAP emissions; and existing CI stationary RICE >500 HP:

For each . . .	You must meet the following operating limitation, except during periods of startup . . .
1. New and reconstructed 2SLB and CI stationary RICE >500 HP located at a major source of HAP emissions and new and reconstructed 4SLB stationary RICE \geq 250 HP located at a major source of HAP emissions complying with the requirement to reduce CO emissions and using an oxidation catalyst; and New and reconstructed 2SLB and CI stationary RICE >500 HP located at a major source of HAP emissions and new and reconstructed 4SLB stationary RICE \geq 250 HP located at a major source of HAP emissions complying with the requirement to limit the concentration of formaldehyde in the stationary RICE exhaust and using an oxidation catalyst.	a. maintain your catalyst so that the pressure drop across the catalyst does not change by more than 2 inches of water at 100 percent load plus or minus 10 percent from the pressure drop across the catalyst that was measured during the initial performance test; and b. maintain the temperature of your stationary RICE exhaust so that the catalyst inlet temperature is greater than or equal to 450 °F and less than or equal to 1350 °F. ¹
2. Existing CI stationary RICE >500 HP complying with the requirement to limit or reduce the concentration of CO in the stationary RICE exhaust and using an oxidation catalyst	a. maintain your catalyst so that the pressure drop across the catalyst does not change by more than 2 inches of water from the pressure drop across the catalyst that was measured during the initial performance test; and
	b. maintain the temperature of your stationary RICE exhaust so that the catalyst inlet temperature is greater than or equal to 450 °F and less than or equal to 1350 °F. ¹
3. New and reconstructed 2SLB and CI stationary RICE >500 HP located at a major source of HAP emissions and new and reconstructed 4SLB stationary RICE \geq 250 HP located at a major source of HAP emissions complying with the requirement to reduce CO emissions and not using an oxidation catalyst; and	Comply with any operating limitations approved by the Administrator.
New and reconstructed 2SLB and CI stationary RICE >500 HP located at a major source of HAP emissions and new and reconstructed 4SLB stationary RICE \geq 250 HP located at a major source of HAP emissions complying with the requirement to limit the concentration of formaldehyde in the stationary RICE exhaust and not using an oxidation catalyst; and	
existing CI stationary RICE >500 HP complying with the requirement to limit or reduce the concentration of CO in the stationary RICE exhaust and not using an oxidation catalyst.	

¹Sources can petition the Administrator pursuant to the requirements of 40 CFR 63.8(f) for a different temperature range.

Table 2c to Subpart ZZZZ of Part 63—Requirements for Existing Compression Ignition Stationary RICE Located at a Major Source of HAP Emissions and Existing Spark Ignition Stationary RICE \leq 500 HP Located at a Major Source of HAP Emissions

As stated in §§63.6600, 63.6602, and 63.6640, you must comply with the following requirements for existing compression ignition stationary RICE located at a major source of HAP emissions and existing spark ignition stationary RICE \leq 500 HP located at a major source of HAP emissions:

For each . . .	You must meet the following requirement, except during periods of startup . . .	During periods of startup you must . . .
1. Emergency stationary CI RICE and black start stationary CI RICE ¹	a. Change oil and filter every 500 hours of operation or annually, whichever comes first. ² b. Inspect air cleaner every 1,000 hours of operation or annually, whichever comes first, and replace as necessary; c. Inspect all hoses and belts every 500 hours of operation or annually, whichever comes first, and replace as necessary. ³	Minimize the engine's time spent at idle and minimize the engine's startup time at startup to a period needed for appropriate and safe loading of the engine, not to exceed 30 minutes, after which time the non-startup emission limitations apply. ³
2. Non-Emergency, non-black start stationary CI RICE <100 HP	a. Change oil and filter every 1,000 hours of operation or annually, whichever comes first. ² b. Inspect air cleaner every 1,000 hours of operation or annually, whichever comes first, and replace as necessary; c. Inspect all hoses and belts every 500 hours of operation or annually, whichever comes first, and replace as necessary. ³	
3. Non-Emergency, non-black start CI stationary RICE 100≤HP≤300 HP	Limit concentration of CO in the stationary RICE exhaust to 230 ppmvd or less at 15 percent O ₂ .	
4. Non-Emergency, non-black start CI stationary RICE 300<HP≤500	a. Limit concentration of CO in the stationary RICE exhaust to 49 ppmvd or less at 15 percent O ₂ ; or b. Reduce CO emissions by 70 percent or more.	
5. Non-Emergency, non-black start stationary CI RICE >500 HP	a. Limit concentration of CO in the stationary RICE exhaust to 23 ppmvd or less at 15 percent O ₂ ; or b. Reduce CO emissions by 70 percent or more.	
6. Emergency stationary SI RICE and black start stationary SI RICE. ¹	a. Change oil and filter every 500 hours of operation or annually, whichever comes first; ² b. Inspect spark plugs every	

	1,000 hours of operation or annually, whichever comes first, and replace as necessary; c. Inspect all hoses and belts every 500 hours of operation or annually, whichever comes first, and replace as necessary. ³	
7. Non-Emergency, non-black start stationary SI RICE <100 HP that are not 2SLB stationary RICE	a. Change oil and filter every 1,440 hours of operation or annually, whichever comes first; ² b. Inspect spark plugs every 1,440 hours of operation or annually, whichever comes first, and replace as necessary;	
	c. Inspect all hoses and belts every 1,440 hours of operation or annually, whichever comes first, and replace as necessary. ³	
8. Non-Emergency, non-black start 2SLB stationary SI RICE <100 HP	a. Change oil and filter every 4,320 hours of operation or annually, whichever comes first; ² b. Inspect spark plugs every 4,320 hours of operation or annually, whichever comes first, and replace as necessary;	
	c. Inspect all hoses and belts every 4,320 hours of operation or annually, whichever comes first, and replace as necessary. ³	
9. Non-emergency, non-black start 2SLB stationary RICE $100 \leq \text{HP} \leq 500$	Limit concentration of CO in the stationary RICE exhaust to 225 ppmvd or less at 15 percent O ₂ .	
10. Non-emergency, non-black start 4SLB stationary RICE $100 \leq \text{HP} \leq 500$	Limit concentration of CO in the stationary RICE exhaust to 47 ppmvd or less at 15 percent O ₂ .	
11. Non-emergency, non-black start 4SRB stationary RICE $100 \leq \text{HP} \leq 500$	Limit concentration of formaldehyde in the stationary RICE exhaust to 10.3 ppmvd or less at 15 percent O ₂ .	
12. Non-emergency, non-black start stationary RICE $100 \leq \text{HP} \leq 500$ which combusts landfill or digester gas	Limit concentration of CO in the stationary RICE exhaust to 177 ppmvd or less at 15	

equivalent to 10 percent or more of the gross heat input on an annual basis	percent O ₂ .	
-----------------------------------------------------------------------------	--------------------------	--

¹If an emergency engine is operating during an emergency and it is not possible to shut down the engine in order to perform the work practice requirements on the schedule required in Table 2c of this subpart, or if performing the work practice on the required schedule would otherwise pose an unacceptable risk under federal, state, or local law, the work practice can be delayed until the emergency is over or the unacceptable risk under federal, state, or local law has abated. The work practice should be performed as soon as practicable after the emergency has ended or the unacceptable risk under federal, state, or local law has abated. Sources must report any failure to perform the work practice on the schedule required and the federal, state or local law under which the risk was deemed unacceptable.

²Sources have the option to utilize an oil analysis program as described in §63.6625(i) or (j) in order to extend the specified oil change requirement in Table 2c of this subpart.

³Sources can petition the Administrator pursuant to the requirements of 40 CFR 63.6(g) for alternative work practices.

Table 2d to Subpart ZZZZ of Part 63—Requirements for Existing Stationary RICE Located at Area Sources of HAP Emissions

As stated in §§63.6603 and 63.6640, you must comply with the following requirements for existing stationary RICE located at area sources of HAP emissions:

For each . . .	You must meet the following requirement, except during periods of startup . . .	During periods of startup you must . . .
1. Non-Emergency, non-black start CI stationary RICE ≤300 HP	a. Change oil and filter every 1,000 hours of operation or annually, whichever comes first; ¹ b. Inspect air cleaner every 1,000 hours of operation or annually, whichever comes first, and replace as necessary; c. Inspect all hoses and belts every 500 hours of operation or annually, whichever comes first, and replace as necessary.	Minimize the engine's time spent at idle and minimize the engine's startup time at startup to a period needed for appropriate and safe loading of the engine, not to exceed 30 minutes, after which time the non-startup emission limitations apply.
2. Non-Emergency, non-black start CI stationary RICE 300<HP≤500	a. Limit concentration of CO in the stationary RICE exhaust to 49 ppmvd at 15 percent O ₂ ; or	
	b. Reduce CO emissions by 70 percent or more.	
3. Non-Emergency, non-black start CI	a. Limit concentration of	

stationary RICE >500 HP	CO in the stationary RICE exhaust to 23 ppmvd at 15 percent O ₂ ; or	
	b. Reduce CO emissions by 70 percent or more.	
4. Emergency stationary CI RICE and black start stationary CI RICE. ²	a. Change oil and filter every 500 hours of operation or annually, whichever comes first; ¹	
	b. Inspect air cleaner every 1,000 hours of operation or annually, whichever comes first, and replace as necessary; and	
	c. Inspect all hoses and belts every 500 hours of operation or annually, whichever comes first, and replace as necessary.	
5. Emergency stationary SI RICE; black start stationary SI RICE; non-emergency, non-black start 4SLB stationary RICE >500 HP that operate 24 hours or less per calendar year; non-emergency, non-black start 4SRB stationary RICE >500 HP that operate 24 hours or less per calendar year. ²	a. Change oil and filter every 500 hours of operation or annually, whichever comes first; ¹ ; b. Inspect spark plugs every 1,000 hours of operation or annually, whichever comes first, and replace as necessary; and c. Inspect all hoses and belts every 500 hours of operation or annually, whichever comes first, and replace as necessary.	
6. Non-emergency, non-black start 2SLB stationary RICE	a. Change oil and filter every 4,320 hours of operation or annually, whichever comes first; ¹	
	b. Inspect spark plugs every 4,320 hours of operation or annually, whichever comes first, and replace as necessary; and	
	c. Inspect all hoses and belts every 4,320 hours of operation or annually, whichever comes first, and replace as necessary.	
7. Non-emergency, non-black start 4SLB stationary RICE ≤500 HP	a. Change oil and filter every 1,440 hours of	

	operation or annually, whichever comes first; ¹	
	b. Inspect spark plugs every 1,440 hours of operation or annually, whichever comes first, and replace as necessary; and	
	c. Inspect all hoses and belts every 1,440 hours of operation or annually, whichever comes first, and replace as necessary.	
8. Non-emergency, non-black start 4SLB remote stationary RICE >500 HP	a. Change oil and filter every 2,160 hours of operation or annually, whichever comes first; ¹	
	b. Inspect spark plugs every 2,160 hours of operation or annually, whichever comes first, and replace as necessary; and	
	c. Inspect all hoses and belts every 2,160 hours of operation or annually, whichever comes first, and replace as necessary.	
9. Non-emergency, non-black start 4SLB stationary RICE >500 HP that are not remote stationary RICE and that operate more than 24 hours per calendar year	Install an oxidation catalyst to reduce HAP emissions from the stationary RICE.	
10. Non-emergency, non-black start 4SRB stationary RICE ≤500 HP	a. Change oil and filter every 1,440 hours of operation or annually, whichever comes first; ¹	
	b. Inspect spark plugs every 1,440 hours of operation or annually, whichever comes first, and replace as necessary; and	
	c. Inspect all hoses and belts every 1,440 hours of operation or annually, whichever comes first, and replace as necessary.	
11. Non-emergency, non-black start 4SRB remote stationary RICE >500 HP	a. Change oil and filter every 2,160 hours of operation or annually, whichever comes first; ¹	

	b. Inspect spark plugs every 2,160 hours of operation or annually, whichever comes first, and replace as necessary; and	
	c. Inspect all hoses and belts every 2,160 hours of operation or annually, whichever comes first, and replace as necessary.	
12. Non-emergency, non-black start 4SRB stationary RICE >500 HP that are not remote stationary RICE and that operate more than 24 hours per calendar year	Install NSCR to reduce HAP emissions from the stationary RICE.	
13. Non-emergency, non-black start stationary RICE which combusts landfill or digester gas equivalent to 10 percent or more of the gross heat input on an annual basis	a. Change oil and filter every 1,440 hours of operation or annually, whichever comes first; ¹ b. Inspect spark plugs every 1,440 hours of operation or annually, whichever comes first, and replace as necessary; and	
	c. Inspect all hoses and belts every 1,440 hours of operation or annually, whichever comes first, and replace as necessary.	

¹Sources have the option to utilize an oil analysis program as described in §63.6625(i) or (j) in order to extend the specified oil change requirement in Table 2d of this subpart.

²If an emergency engine is operating during an emergency and it is not possible to shut down the engine in order to perform the management practice requirements on the schedule required in Table 2d of this subpart, or if performing the management practice on the required schedule would otherwise pose an unacceptable risk under federal, state, or local law, the management practice can be delayed until the emergency is over or the unacceptable risk under federal, state, or local law has abated. The management practice should be performed as soon as practicable after the emergency has ended or the unacceptable risk under federal, state, or local law has abated. Sources must report any failure to perform the management practice on the schedule required and the federal, state or local law under which the risk was deemed unacceptable.

Table 3 to Subpart ZZZZ of Part 63—Subsequent Performance Tests

As stated in §§63.6615 and 63.6620, you must comply with the following subsequent performance test requirements:

For each . . .	Complying with the requirement to . . .	You must . . .
----------------	-----------------------------------------	----------------

1. New or reconstructed 2SLB stationary RICE >500 HP located at major sources; new or reconstructed 4SLB stationary RICE ≥ 250 HP located at major sources; and new or reconstructed CI stationary RICE >500 HP located at major sources	Reduce CO emissions and not using a CEMS	Conduct subsequent performance tests semiannually. ¹
2. 4SRB stationary RICE $\geq 5,000$ HP located at major sources	Reduce formaldehyde emissions	Conduct subsequent performance tests semiannually. ¹
3. Stationary RICE >500 HP located at major sources and new or reconstructed 4SLB stationary RICE $250 \leq \text{HP} \leq 500$ located at major sources	Limit the concentration of formaldehyde in the stationary RICE exhaust	Conduct subsequent performance tests semiannually. ¹
4. Existing non-emergency, non-black start CI stationary RICE >500 HP that are not limited use stationary RICE	Limit or reduce CO emissions and not using a CEMS	Conduct subsequent performance tests every 8,760 hours or 3 years, whichever comes first.
5. Existing non-emergency, non-black start CI stationary RICE >500 HP that are limited use stationary RICE	Limit or reduce CO emissions and not using a CEMS	Conduct subsequent performance tests every 8,760 hours or 5 years, whichever comes first.

¹After you have demonstrated compliance for two consecutive tests, you may reduce the frequency of subsequent performance tests to annually. If the results of any subsequent annual performance test indicate the stationary RICE is not in compliance with the CO or formaldehyde emission limitation, or you deviate from any of your operating limitations, you must resume semiannual performance tests.

Table 4 to Subpart ZZZZ of Part 63—Requirements for Performance Tests

As stated in §§63.6610, 63.6611, 63.6620, and 63.6640, you must comply with the following requirements for performance tests for stationary RICE:

TABLE 4 TO SUBPART ZZZZ OF PART 63—REQUIREMENTS FOR PERFORMANCE TESTS

For each . . .	Complying with the requirement to . . .	You must . . .	Using . . .	According to the following requirements . . .
1. 2SLB, 4SLB, and CI stationary RICE	a. reduce CO emissions	i. Select the sampling port location and the number/location of traverse points at the inlet and outlet of the control device; and		(a) For CO and O ₂ measurement ducts ≤ 6 inches in diameter may be sampled at a single point located at the duct centroid and ducts >6 and ≤ 12 inches in diameter may be sampled at 3 traverse points located at 16.7, 50.0, and 83.3% of the measurement line ('3-point long line'). If the duct is >12 inches in diameter <i>and</i> the sampling port location meets the two and half-diameter criterion of Section 11.1.1

				of Method 1 of 40 CFR part 60, appendix A-1, the duct may be sampled at '3-point long line'; otherwise, conduct the stratification testing and select sampling points according to Section 8.1.2 of Method 7E of 40 CFR part 60, appendix A-4.
		ii. Measure the O ₂ at the inlet and outlet of the control device; and	(1) Method 3 or 3A or 3B of 40 CFR part 60, appendix A-2, or ASTM Method D6522-00 (Reapproved 2005) ^{bc} (heated probe not necessary)	(b) Measurements to determine O ₂ must be made at the same time as the measurements for CO concentration.
		iii. Measure the CO at the inlet and the outlet of the control device	(1) ASTM D6522-00 (Reapproved 2005) ^{abc} (heated probe not necessary) or Method 10 of 40 CFR part 60, appendix A-4	(c) The CO concentration must be at 15 percent O ₂ , dry basis.
2. 4SRB stationary RICE	a. reduce formaldehyde emissions	i. Select the sampling port location and the number/location of traverse points at the inlet and outlet of the control device; and		(a) For formaldehyde, O ₂ , and moisture measurement, ducts ≤6 inches in diameter may be sampled at a single point located at the duct centroid and ducts >6 and ≤12 inches in diameter may be sampled at 3 traverse points located at 16.7, 50.0, and 83.3% of the measurement line ('3-point long line'). If the duct is >12 inches in diameter <i>and</i> the sampling port location meets the two and half-diameter criterion of Section 11.1.1 of Method 1 of 40 CFR part 60, appendix A, the duct may be sampled at '3-point long line'; otherwise, conduct the stratification testing and select sampling points according to Section 8.1.2 of Method 7E of 40 CFR part 60, appendix A.
		ii. Measure O ₂ at the inlet and outlet of the control device; and	(1) Method 3 or 3A or 3B of 40 CFR part 60, appendix A-2, or ASTM Method D6522-00 (Reapproved 2005) ^a (heated probe not necessary)	(a) Measurements to determine O ₂ concentration must be made at the same time as the measurements for formaldehyde or THC concentration.
		iii. Measure moisture content at the inlet and outlet of the control	(1) Method 4 of 40 CFR part 60, appendix A-3, or Method 320 of 40	(a) Measurements to determine moisture content must be made at the same time and location as the

		device; and	CFR part 63, appendix A, or ASTM D 6348-03 ^a	measurements for formaldehyde or THC concentration.
		iv. If demonstrating compliance with the formaldehyde percent reduction requirement, measure formaldehyde at the inlet and the outlet of the control device	(1) Method 320 or 323 of 40 CFR part 63, appendix A; or ASTM D6348-03 ^a , provided in ASTM D6348-03 Annex A5 (Analyte Spiking Technique), the percent R must be greater than or equal to 70 and less than or equal to 130	(a) Formaldehyde concentration must be at 15 percent O ₂ , dry basis. Results of this test consist of the average of the three 1-hour or longer runs.
		v. If demonstrating compliance with the THC percent reduction requirement, measure THC at the inlet and the outlet of the control device	(1) Method 25A, reported as propane, of 40 CFR part 60, appendix A-7	(a) THC concentration must be at 15 percent O ₂ , dry basis. Results of this test consist of the average of the three 1-hour or longer runs.
3. Stationary RICE	a. limit the concentration of formaldehyde or CO in the stationary RICE exhaust	i. Select the sampling port location and the number/location of traverse points at the exhaust of the stationary RICE; and		(a) For formaldehyde, CO, O ₂ , and moisture measurement ducts ≤6 inches in diameter may be sampled at a single point located at the duct centroid and ducts >6 and ≤12 inches in diameter may be sampled at 3 traverse points located at 16.7, 50.0, and 83.3% of the measurement line ('3-point long line'). If the duct is >12 inches in diameter <i>and</i> the sampling port location meets the two and half-diameter criterion of Section 11.1.1 of Method 1 of 40 CFR part 60, appendix A, the duct may be sampled at '3-point long line'; otherwise, conduct the stratification testing and select sampling points according to Section 8.1.2 of Method 7E of 40 CFR part 60, appendix A. If using a control device, the sampling site must be located at the outlet of the control device.
		ii. Determine the O ₂ concentration of the stationary RICE exhaust at the sampling port location; and	(1) Method 3 or 3A or 3B of 40 CFR part 60, appendix A-2, or ASTM Method D6522-00 (Reapproved 2005) ^a (heated probe not necessary)	(a) Measurements to determine O ₂ concentration must be made at the same time and location as the measurements for formaldehyde or CO concentration.
		iii. Measure moisture content of the station-	(1) Method 4 of 40 CFR part 60, appendix A-3,	(a) Measurements to determine moisture content must be made at

		ary RICE exhaust at the sampling port location; and	or Method 320 of 40 CFR part 63, appendix A, or ASTM D 6348-03 ^a	the same time and location as the measurements for formaldehyde or CO concentration.
		iv. Measure formaldehyde at the exhaust of the station-ary RICE; or	(1) Method 320 or 323 of 40 CFR part 63, appendix A; or ASTM D6348-03 ^a , provided in ASTM D6348-03 Annex A5 (Analyte Spiking Technique), the percent R must be greater than or equal to 70 and less than or equal to 130	(a) Formaldehyde concentration must be at 15 percent O ₂ , dry basis. Results of this test consist of the average of the three 1-hour or longer runs.
		v. measure CO at the exhaust of the station-ary RICE	(1) Method 10 of 40 CFR part 60, appendix A-4, ASTM Method D6522-00 (2005) ^c , Method 320 of 40 CFR part 63, appendix A, or ASTM D6348-03 ^a	(a) CO concentration must be at 15 percent O ₂ , dry basis. Results of this test consist of the average of the three 1-hour or longer runs.

^aYou may also use Methods 3A and 10 as options to ASTM-D6522-00 (2005). You may obtain a copy of ASTM-D6522-00 (2005) from at least one of the following addresses: American Society for Testing and Materials, 100 Barr Harbor Drive, West Conshohocken, PA 19428-2959, or University Microfilms International, 300 North Zeeb Road, Ann Arbor, MI 48106.

^bYou may obtain a copy of ASTM-D6348-03 from at least one of the following addresses: American Society for Testing and Materials, 100 Barr Harbor Drive, West Conshohocken, PA 19428-2959, or University Microfilms International, 300 North Zeeb Road, Ann Arbor, MI 48106.

Table 5 to Subpart ZZZZ of Part 63—Initial Compliance With Emission Limitations, Operating Limitations, and Other Requirements

As stated in §§63.6612, 63.6625 and 63.6630, you must initially comply with the emission and operating limitations as required by the following:

For each . . .	Complying with the requirement to . . .	You have demonstrated initial compliance if . . .
1. New or reconstructed non-emergency 2SLB stationary RICE >500 HP located at a major source of HAP, new or reconstructed non-emergency 4SLB stationary RICE ≥250 HP located at a major source of HAP, non-emergency stationary CI RICE >500 HP located at a major source of HAP, and existing non-emergency stationary CI RICE >500 HP located at an area source of HAP	a. Reduce CO emissions and using oxidation catalyst, and using a CPMS	i. The average reduction of emissions of CO determined from the initial performance test achieves the required CO percent reduction; and ii. You have installed a CPMS to continuously monitor catalyst inlet temperature according to the requirements in §63.6625(b); and iii. You have recorded the catalyst pressure drop and catalyst inlet temperature during the initial performance test.

<p>2. Non-emergency stationary CI RICE >500 HP located at a major source of HAP, and existing non-emergency stationary CI RICE >500 HP located at an area source of HAP</p>	<p>a. Limit the concentration of CO, using oxidation catalyst, and using a CPMS</p>	<p>i. The average CO concentration determined from the initial performance test is less than or equal to the CO emission limitation; and</p>
		<p>ii. You have installed a CPMS to continuously monitor catalyst inlet temperature according to the requirements in §63.6625(b); and</p>
		<p>iii. You have recorded the catalyst pressure drop and catalyst inlet temperature during the initial performance test.</p>
<p>3. New or reconstructed non-emergency 2SLB stationary RICE >500 HP located at a major source of HAP, new or reconstructed non-emergency 4SLB stationary RICE ≥250 HP located at a major source of HAP, non-emergency stationary CI RICE >500 HP located at a major source of HAP, and existing non-emergency stationary CI RICE >500 HP located at an area source of HAP</p>	<p>a. Reduce CO emissions and not using oxidation catalyst</p>	<p>i. The average reduction of emissions of CO determined from the initial performance test achieves the required CO percent reduction; and ii. You have installed a CPMS to continuously monitor operating parameters approved by the Administrator (if any) according to the requirements in §63.6625(b); and iii. You have recorded the approved operating parameters (if any) during the initial performance test.</p>
<p>4. Non-emergency stationary CI RICE >500 HP located at a major source of HAP, and existing non-emergency stationary CI RICE >500 HP located at an area source of HAP</p>	<p>a. Limit the concentration of CO, and not using oxidation catalyst</p>	<p>i. The average CO concentration determined from the initial performance test is less than or equal to the CO emission limitation; and ii. You have installed a CPMS to continuously monitor operating parameters approved by the Administrator (if any) according to the requirements in §63.6625(b); and</p>
		<p>iii. You have recorded the approved operating parameters (if any) during the initial performance test.</p>
<p>5. New or reconstructed non-emergency 2SLB stationary RICE >500 HP located at a major source of HAP, new or reconstructed non-emergency 4SLB stationary RICE ≥250 HP located at a major source of HAP, non-emergency stationary CI RICE >500 HP located at a major source of HAP, and existing non-emergency stationary CI RICE >500 HP located at an area source of HAP</p>	<p>a. Reduce CO emissions, and using a CEMS</p>	<p>i. You have installed a CEMS to continuously monitor CO and either O₂ or CO₂ at both the inlet and outlet of the oxidation catalyst according to the requirements in §63.6625(a); and ii. You have conducted a performance evaluation of your CEMS using PS 3 and 4A of 40 CFR part 60, appendix B; and</p>
		<p>iii. The average reduction of CO calculated using §63.6620 equals or exceeds the required percent reduction. The initial test comprises the first 4-hour period after successful validation of the CEMS. Compliance is based on the average</p>

		percent reduction achieved during the 4-hour period.
6. Non-emergency stationary CI RICE >500 HP located at a major source of HAP, and existing non-emergency stationary CI RICE >500 HP located at an area source of HAP	a. Limit the concentration of CO, and using a CEMS	i. You have installed a CEMS to continuously monitor CO and either O ₂ or CO ₂ at the outlet of the oxidation catalyst according to the requirements in §63.6625(a); and
		ii. You have conducted a performance evaluation of your CEMS using PS 3 and 4A of 40 CFR part 60, appendix B; and
		iii. The average concentration of CO calculated using §63.6620 is less than or equal to the CO emission limitation. The initial test comprises the first 4-hour period after successful validation of the CEMS. Compliance is based on the average concentration measured during the 4-hour period.
7. Non-emergency 4SRB stationary RICE >500 HP located at a major source of HAP	a. Reduce formaldehyde emissions and using NSCR	i. The average reduction of emissions of formaldehyde determined from the initial performance test is equal to or greater than the required formaldehyde percent reduction, or the average reduction of emissions of THC determined from the initial performance test is equal to or greater than 30 percent; and
		ii. You have installed a CPMS to continuously monitor catalyst inlet temperature according to the requirements in §63.6625(b); and
		iii. You have recorded the catalyst pressure drop and catalyst inlet temperature during the initial performance test.
8. Non-emergency 4SRB stationary RICE >500 HP located at a major source of HAP	a. Reduce formaldehyde emissions and not using NSCR	i. The average reduction of emissions of formaldehyde determined from the initial performance test is equal to or greater than the required formaldehyde percent reduction or the average reduction of emissions of THC determined from the initial performance test is equal to or greater than 30 percent; and
		ii. You have installed a CPMS to continuously monitor operating parameters approved by the Administrator (if any) according to the requirements in §63.6625(b); and
		iii. You have recorded the approved operating parameters (if any) during the initial performance test.

<p>9. New or reconstructed non-emergency stationary RICE >500 HP located at a major source of HAP, new or reconstructed non-emergency 4SLB stationary RICE 250≤HP≤500 located at a major source of HAP, and existing non-emergency 4SRB stationary RICE >500 HP located at a major source of HAP</p>	<p>a. Limit the concentration of formaldehyde in the stationary RICE exhaust and using oxidation catalyst or NSCR</p>	<p>i. The average formaldehyde concentration, corrected to 15 percent O₂, dry basis, from the three test runs is less than or equal to the formaldehyde emission limitation; and ii. You have installed a CPMS to continuously monitor catalyst inlet temperature according to the requirements in §63.6625(b); and</p>
		<p>iii. You have recorded the catalyst pressure drop and catalyst inlet temperature during the initial performance test.</p>
<p>10. New or reconstructed non-emergency stationary RICE >500 HP located at a major source of HAP, new or reconstructed non-emergency 4SLB stationary RICE 250≤HP≤500 located at a major source of HAP, and existing non-emergency 4SRB stationary RICE >500 HP located at a major source of HAP</p>	<p>a. Limit the concentration of formaldehyde in the stationary RICE exhaust and not using oxidation catalyst or NSCR</p>	<p>i. The average formaldehyde concentration, corrected to 15 percent O₂, dry basis, from the three test runs is less than or equal to the formaldehyde emission limitation; and ii. You have installed a CPMS to continuously monitor operating parameters approved by the Administrator (if any) according to the requirements in §63.6625(b); and</p>
		<p>iii. You have recorded the approved operating parameters (if any) during the initial performance test.</p>
<p>11. Existing non-emergency stationary RICE 100≤HP≤500 located at a major source of HAP, and existing non-emergency stationary CI RICE 300<HP≤500 located at an area source of HAP</p>	<p>a. Reduce CO emissions</p>	<p>i. The average reduction of emissions of CO or formaldehyde, as applicable determined from the initial performance test is equal to or greater than the required CO or formaldehyde, as applicable, percent reduction.</p>
<p>12. Existing non-emergency stationary RICE 100≤HP≤500 located at a major source of HAP, and existing non-emergency stationary CI RICE 300<HP≤500 located at an area source of HAP</p>	<p>a. Limit the concentration of formaldehyde or CO in the stationary RICE exhaust</p>	<p>i. The average formaldehyde or CO concentration, as applicable, corrected to 15 percent O₂, dry basis, from the three test runs is less than or equal to the formaldehyde or CO emission limitation, as applicable.</p>
<p>13. Existing non-emergency 4SLB stationary RICE >500 HP located at an area source of HAP that are not remote stationary RICE and that are operated more than 24 hours per calendar year</p>	<p>a. Install an oxidation catalyst</p>	<p>i. You have conducted an initial compliance demonstration as specified in §63.6630(e) to show that the average reduction of emissions of CO is 93 percent or more, or the average CO concentration is less than or equal to 47 ppmvd at 15 percent O₂;</p>
		<p>ii. You have installed a CPMS to continuously monitor catalyst inlet temperature according to the requirements in §63.6625(b), or you have installed equipment to automatically shut down the engine if the catalyst inlet temperature exceeds 1350 °F.</p>

14. Existing non-emergency 4SRB stationary RICE >500 HP located at an area source of HAP that are not remote stationary RICE and that are operated more than 24 hours per calendar year	a. Install NSCR	i. You have conducted an initial compliance demonstration as specified in §63.6630(e) to show that the average reduction of emissions of CO is 75 percent or more, the average CO concentration is less than or equal to 270 ppmvd at 15 percent O ₂ , or the average reduction of emissions of THC is 30 percent or more;
		ii. You have installed a CPMS to continuously monitor catalyst inlet temperature according to the requirements in §63.6625(b), or you have installed equipment to automatically shut down the engine if the catalyst inlet temperature exceeds 1250 °F.

Table 6 to Subpart ZZZZ of Part 63—Continuous Compliance With Emission Limitations, and Other Requirements

As stated in §63.6640, you must continuously comply with the emissions and operating limitations and work or management practices as required by the following:

For each . . .	Complying with the requirement to . . .	You must demonstrate continuous compliance by . . .
1. New or reconstructed non-emergency 2SLB stationary RICE >500 HP located at a major source of HAP, new or reconstructed non-emergency 4SLB stationary RICE ≥250 HP located at a major source of HAP, and new or reconstructed non-emergency CI stationary RICE >500 HP located at a major source of HAP	a. Reduce CO emissions and using an oxidation catalyst, and using a CPMS	i. Conducting semiannual performance tests for CO to demonstrate that the required CO percent reduction is achieved ^a ; and ii. Collecting the catalyst inlet temperature data according to §63.6625(b); and iii. Reducing these data to 4-hour rolling averages; and
		iv. Maintaining the 4-hour rolling averages within the operating limitations for the catalyst inlet temperature; and
		v. Measuring the pressure drop across the catalyst once per month and demonstrating that the pressure drop across the catalyst is within the operating limitation established during the performance test.
2. New or reconstructed non-emergency 2SLB stationary RICE >500 HP located at a major source of HAP, new or reconstructed non-emergency 4SLB stationary RICE ≥250 HP located at a major source of HAP, and new or reconstructed non-emergency CI stationary RICE >500 HP located at a major source of HAP	a. Reduce CO emissions and not using an oxidation catalyst, and using a CPMS	i. Conducting semiannual performance tests for CO to demonstrate that the required CO percent reduction is achieved ^a ; and ii. Collecting the approved operating parameter (if any) data according to §63.6625(b); and iii. Reducing these data to 4-hour rolling averages; and

		iv. Maintaining the 4-hour rolling averages within the operating limitations for the operating parameters established during the performance test.
3. New or reconstructed non-emergency 2SLB stationary RICE >500 HP located at a major source of HAP, new or reconstructed non-emergency 4SLB stationary RICE ≥250 HP located at a major source of HAP, new or reconstructed non-emergency stationary CI RICE >500 HP located at a major source of HAP, and existing non-emergency stationary CI RICE >500 HP	a. Reduce CO emissions or limit the concentration of CO in the stationary RICE exhaust, and using a CEMS	i. Collecting the monitoring data according to §63.6625(a), reducing the measurements to 1-hour averages, calculating the percent reduction or concentration of CO emissions according to §63.6620; and ii. Demonstrating that the catalyst achieves the required percent reduction of CO emissions over the 4-hour averaging period, or that the emission remain at or below the CO concentration limit; and
		iii. Conducting an annual RATA of your CEMS using PS 3 and 4A of 40 CFR part 60, appendix B, as well as daily and periodic data quality checks in accordance with 40 CFR part 60, appendix F, procedure 1.
4. Non-emergency 4SRB stationary RICE >500 HP located at a major source of HAP	a. Reduce formaldehyde emissions and using NSCR	i. Collecting the catalyst inlet temperature data according to §63.6625(b); and
		ii. Reducing these data to 4-hour rolling averages; and
		iii. Maintaining the 4-hour rolling averages within the operating limitations for the catalyst inlet temperature; and
		iv. Measuring the pressure drop across the catalyst once per month and demonstrating that the pressure drop across the catalyst is within the operating limitation established during the performance test.
5. Non-emergency 4SRB stationary RICE >500 HP located at a major source of HAP	a. Reduce formaldehyde emissions and not using NSCR	i. Collecting the approved operating parameter (if any) data according to §63.6625(b); and
		ii. Reducing these data to 4-hour rolling averages; and
		iii. Maintaining the 4-hour rolling averages within the operating limitations for the operating parameters established during the performance test.
6. Non-emergency 4SRB stationary RICE with a brake HP ≥5,000 located at a major source of HAP	a. Reduce formaldehyde emissions	Conducting semiannual performance tests for formaldehyde to demonstrate that the required formaldehyde percent reduction is achieved, or to demonstrate that the

		average reduction of emissions of THC determined from the performance test is equal to or greater than 30 percent. ^a
7. New or reconstructed non-emergency stationary RICE >500 HP located at a major source of HAP and new or reconstructed non-emergency 4SLB stationary RICE 250≤HP≤500 located at a major source of HAP	a. Limit the concentration of formaldehyde in the stationary RICE exhaust and using oxidation catalyst or NSCR	i. Conducting semiannual performance tests for formaldehyde to demonstrate that your emissions remain at or below the formaldehyde concentration limit ^a ; and ii. Collecting the catalyst inlet temperature data according to §63.6625(b); and
		iii. Reducing these data to 4-hour rolling averages; and
		iv. Maintaining the 4-hour rolling averages within the operating limitations for the catalyst inlet temperature; and
		v. Measuring the pressure drop across the catalyst once per month and demonstrating that the pressure drop across the catalyst is within the operating limitation established during the performance test.
8. New or reconstructed non-emergency stationary RICE >500 HP located at a major source of HAP and new or reconstructed non-emergency 4SLB stationary RICE 250≤HP≤500 located at a major source of HAP	a. Limit the concentration of formaldehyde in the stationary RICE exhaust and not using oxidation catalyst or NSCR	i. Conducting semiannual performance tests for formaldehyde to demonstrate that your emissions remain at or below the formaldehyde concentration limit ^a ; and ii. Collecting the approved operating parameter (if any) data according to §63.6625(b); and
		iii. Reducing these data to 4-hour rolling averages; and
		iv. Maintaining the 4-hour rolling averages within the operating limitations for the operating parameters established during the performance test.
9. Existing emergency and black start stationary RICE ≤500 HP located at a major source of HAP, existing non-emergency stationary RICE <100 HP located at a major source of HAP, existing emergency and black start stationary RICE located at an area source of HAP, existing non-emergency stationary CI RICE ≤300 HP located at an area source of HAP, existing non-emergency 2SLB stationary RICE located at an area source of HAP, existing non-emergency stationary SI RICE located at an area source of HAP which combusts landfill or digester gas equivalent to 10 percent or more of the gross heat input on an annual basis, existing non-emergency 4SLB and 4SRB stationary RICE ≤500 HP located at an area source of HAP, existing non-emergency 4SLB and 4SRB	a. Work or Management practices	i. Operating and maintaining the stationary RICE according to the manufacturer's emission-related operation and maintenance instructions; or ii. Develop and follow your own maintenance plan which must provide to the extent practicable for the maintenance and operation of the engine in a manner consistent with good air pollution control practice for minimizing emissions.

stationary RICE >500 HP located at an area source of HAP that operate 24 hours or less per calendar year, and existing non-emergency 4SLB and 4SRB stationary RICE >500 HP located at an area source of HAP that are remote stationary RICE		
10. Existing stationary CI RICE >500 HP that are not limited use stationary RICE	a. Reduce CO emissions, or limit the concentration of CO in the stationary RICE exhaust, and using oxidation catalyst	i. Conducting performance tests every 8,760 hours or 3 years, whichever comes first, for CO or formaldehyde, as appropriate, to demonstrate that the required CO or formaldehyde, as appropriate, percent reduction is achieved or that your emissions remain at or below the CO or formaldehyde concentration limit; and
		ii. Collecting the catalyst inlet temperature data according to §63.6625(b); and
		iii. Reducing these data to 4-hour rolling averages; and
		iv. Maintaining the 4-hour rolling averages within the operating limitations for the catalyst inlet temperature; and
		v. Measuring the pressure drop across the catalyst once per month and demonstrating that the pressure drop across the catalyst is within the operating limitation established during the performance test.
11. Existing stationary CI RICE >500 HP that are not limited use stationary RICE	a. Reduce CO emissions, or limit the concentration of CO in the stationary RICE exhaust, and not using oxidation catalyst	i. Conducting performance tests every 8,760 hours or 3 years, whichever comes first, for CO or formaldehyde, as appropriate, to demonstrate that the required CO or formaldehyde, as appropriate, percent reduction is achieved or that your emissions remain at or below the CO or formaldehyde concentration limit; and
		ii. Collecting the approved operating parameter (if any) data according to §63.6625(b); and
		iii. Reducing these data to 4-hour rolling averages; and
		iv. Maintaining the 4-hour rolling averages within the operating limitations for the operating parameters established during the performance test.
12. Existing limited use CI stationary RICE >500 HP	a. Reduce CO emissions or limit the concentration of CO in the stationary RICE	i. Conducting performance tests every 8,760 hours or 5 years, whichever comes first, for CO or formaldehyde, as appropriate, to demonstrate that the

	exhaust, and using an oxidation catalyst	required CO or formaldehyde, as appropriate, percent reduction is achieved or that your emissions remain at or below the CO or formaldehyde concentration limit; and
		ii. Collecting the catalyst inlet temperature data according to §63.6625(b); and
		iii. Reducing these data to 4-hour rolling averages; and
		iv. Maintaining the 4-hour rolling averages within the operating limitations for the catalyst inlet temperature; and
		v. Measuring the pressure drop across the catalyst once per month and demonstrating that the pressure drop across the catalyst is within the operating limitation established during the performance test.
13. Existing limited use CI stationary RICE >500 HP	a. Reduce CO emissions or limit the concentration of CO in the stationary RICE exhaust, and not using an oxidation catalyst	i. Conducting performance tests every 8,760 hours or 5 years, whichever comes first, for CO or formaldehyde, as appropriate, to demonstrate that the required CO or formaldehyde, as appropriate, percent reduction is achieved or that your emissions remain at or below the CO or formaldehyde concentration limit; and
		ii. Collecting the approved operating parameter (if any) data according to §63.6625(b); and
		iii. Reducing these data to 4-hour rolling averages; and
		iv. Maintaining the 4-hour rolling averages within the operating limitations for the operating parameters established during the performance test.
14. Existing non-emergency 4SLB stationary RICE >500 HP located at an area source of HAP that are not remote stationary RICE and that are operated more than 24 hours per calendar year	a. Install an oxidation catalyst	i. Conducting annual compliance demonstrations as specified in §63.6640(c) to show that the average reduction of emissions of CO is 93 percent or more, or the average CO concentration is less than or equal to 47 ppmvd at 15 percent O ₂ ; and either ii. Collecting the catalyst inlet temperature data according to §63.6625(b), reducing these data to 4-hour rolling averages; and maintaining the 4-hour rolling averages within the limitation of greater than 450 °F and less than or equal to 1350 °F for the catalyst inlet temperature; or

		iii. Immediately shutting down the engine if the catalyst inlet temperature exceeds 1350 °F.
15. Existing non-emergency 4SRB stationary RICE >500 HP located at an area source of HAP that are not remote stationary RICE and that are operated more than 24 hours per calendar year	a. Install NSCR	i. Conducting annual compliance demonstrations as specified in §63.6640(c) to show that the average reduction of emissions of CO is 75 percent or more, the average CO concentration is less than or equal to 270 ppmvd at 15 percent O ₂ , or the average reduction of emissions of THC is 30 percent or more; and either ii. Collecting the catalyst inlet temperature data according to §63.6625(b), reducing these data to 4-hour rolling averages; and maintaining the 4-hour rolling averages within the limitation of greater than or equal to 750 °F and less than or equal to 1250 °F for the catalyst inlet temperature; or iii. Immediately shutting down the engine if the catalyst inlet temperature exceeds 1250 °F.

^aAfter you have demonstrated compliance for two consecutive tests, you may reduce the frequency of subsequent performance tests to annually. If the results of any subsequent annual performance test indicate the stationary RICE is not in compliance with the CO or formaldehyde emission limitation, or you deviate from any of your operating limitations, you must resume semiannual performance tests.

Table 7 to Subpart ZZZZ of Part 63—Requirements for Reports

As stated in §63.6650, you must comply with the following requirements for reports:

For each . . .	You must submit a . . .	The report must contain . . .	You must submit the report . . .
1. Existing non-emergency, non-black start stationary RICE $100 \leq \text{HP} \leq 500$ located at a major source of HAP; existing non-emergency, non-black start stationary CI RICE >500 HP located at a major source of HAP; existing non-emergency 4SRB stationary RICE >500 HP located at a major source of HAP; existing non-emergency, non-black start stationary CI RICE >300 HP located at an area source of HAP; new or reconstructed non-emergency stationary RICE >500 HP located at a major source of HAP; and new or reconstructed non-	Compliance report	a. If there are no deviations from any emission limitations or operating limitations that apply to you, a statement that there were no deviations from the emission limitations or operating limitations during the reporting period. If there were no periods during which the CMS, including CEMS and CPMS, was out-of-control, as specified in §63.8(c)(7), a statement that there were not periods during which the CMS was out-of-control during the reporting period; or	i. Semiannually according to the requirements in §63.6650(b)(1)-(5) for engines that are not limited use stationary RICE subject to numerical emission limitations; and ii. Annually according to the requirements in §63.6650(b)(6)-(9) for engines that are limited use stationary RICE subject to numerical

emergency 4SLB stationary RICE 250≤HP≤500 located at a major source of HAP			emission limitations.
		b. If you had a deviation from any emission limitation or operating limitation during the reporting period, the information in §63.6650(d). If there were periods during which the CMS, including CEMS and CPMS, was out-of-control, as specified in §63.8(c)(7), the information in §63.6650(e); or	i. Semiannually according to the requirements in §63.6650(b).
		c. If you had a malfunction during the reporting period, the information in §63.6650(c)(4).	i. Semiannually according to the requirements in §63.6650(b).
2. New or reconstructed non-emergency stationary RICE that combusts landfill gas or digester gas equivalent to 10 percent or more of the gross heat input on an annual basis	Report	a. The fuel flow rate of each fuel and the heating values that were used in your calculations, and you must demonstrate that the percentage of heat input provided by landfill gas or digester gas, is equivalent to 10 percent or more of the gross heat input on an annual basis; and	i. Annually, according to the requirements in §63.6650.
		b. The operating limits provided in your federally enforceable permit, and any deviations from these limits; and	i. See item 2.a.i.
		c. Any problems or errors suspected with the meters.	i. See item 2.a.i.
3. Existing non-emergency, non-black start 4SLB and 4SRB stationary RICE >500 HP located at an area source of HAP that are not remote stationary RICE and that operate more than 24 hours per calendar year	Compliance report	a. The results of the annual compliance demonstration, if conducted during the reporting period.	i. Semiannually according to the requirements in §63.6650(b)(1)-(5).
4. Emergency stationary RICE that operate or are contractually obligated to be available for more than 15 hours per year for the purposes specified in §63.6640(f)(2)(ii) and (iii) or that operate for the purposes specified in §63.6640(f)(4)(ii)	Report	a. The information in §63.6650(h)(1)	i. annually according to the requirements in §63.6650(h)(2)-(3).

Table 8 to Subpart ZZZZ of Part 63—Applicability of General Provisions to Subpart ZZZZ.

As stated in §63.6665, you must comply with the following applicable general provisions.

General provisions citation	Subject of citation	Applies to subpart	Explanation
§63.1	General applicability of the General Provisions	Yes.	
§63.2	Definitions	Yes	Additional terms defined in §63.6675.
§63.3	Units and abbreviations	Yes.	
§63.4	Prohibited activities and circumvention	Yes.	
§63.5	Construction and reconstruction	Yes.	
§63.6(a)	Applicability	Yes.	
§63.6(b)(1)-(4)	Compliance dates for new and reconstructed sources	Yes.	
§63.6(b)(5)	Notification	Yes.	
§63.6(b)(6)	[Reserved]		
§63.6(b)(7)	Compliance dates for new and reconstructed area sources that become major sources	Yes.	
§63.6(c)(1)-(2)	Compliance dates for existing sources	Yes.	
§63.6(c)(3)-(4)	[Reserved]		
§63.6(c)(5)	Compliance dates for existing area sources that become major sources	Yes.	
§63.6(d)	[Reserved]		
§63.6(e)	Operation and maintenance	No.	
§63.6(f)(1)	Applicability of standards	No.	
§63.6(f)(2)	Methods for determining compliance	Yes.	
§63.6(f)(3)	Finding of compliance	Yes.	
§63.6(g)(1)-(3)	Use of alternate standard	Yes.	
§63.6(h)	Opacity and visible emission standards	No	Subpart ZZZZ does not contain opacity or visible emission standards.
§63.6(i)	Compliance extension procedures and criteria	Yes.	
§63.6(j)	Presidential compliance exemption	Yes.	
§63.7(a)(1)-(2)	Performance test dates	Yes	Subpart ZZZZ contains performance test dates at §§63.6610, 63.6611, and 63.6612.
§63.7(a)(3)	CAA section 114 authority	Yes.	
§63.7(b)(1)	Notification of performance test	Yes	Except that §63.7(b)(1) only applies as

			specified in §63.6645.
§63.7(b)(2)	Notification of rescheduling	Yes	Except that §63.7(b)(2) only applies as specified in §63.6645.
§63.7(c)	Quality assurance/test plan	Yes	Except that §63.7(c) only applies as specified in §63.6645.
§63.7(d)	Testing facilities	Yes.	
§63.7(e)(1)	Conditions for conducting performance tests	No.	Subpart ZZZZ specifies conditions for conducting performance tests at §63.6620.
§63.7(e)(2)	Conduct of performance tests and reduction of data	Yes	Subpart ZZZZ specifies test methods at §63.6620.
§63.7(e)(3)	Test run duration	Yes.	
§63.7(e)(4)	Administrator may require other testing under section 114 of the CAA	Yes.	
§63.7(f)	Alternative test method provisions	Yes.	
§63.7(g)	Performance test data analysis, recordkeeping, and reporting	Yes.	
§63.7(h)	Waiver of tests	Yes.	
§63.8(a)(1)	Applicability of monitoring requirements	Yes	Subpart ZZZZ contains specific requirements for monitoring at §63.6625.
§63.8(a)(2)	Performance specifications	Yes.	
§63.8(a)(3)	[Reserved]		
§63.8(a)(4)	Monitoring for control devices	No.	
§63.8(b)(1)	Monitoring	Yes.	
§63.8(b)(2)-(3)	Multiple effluents and multiple monitoring systems	Yes.	
§63.8(c)(1)	Monitoring system operation and maintenance	Yes.	
§63.8(c)(1)(i)	Routine and predictable SSM	No	
§63.8(c)(1)(ii)	SSM not in Startup Shutdown Malfunction Plan	Yes.	
§63.8(c)(1)(iii)	Compliance with operation and maintenance requirements	No	
§63.8(c)(2)-(3)	Monitoring system installation	Yes.	
§63.8(c)(4)	Continuous monitoring system (CMS) requirements	Yes	Except that subpart ZZZZ does not require Continuous Opacity Monitoring System (COMS).
§63.8(c)(5)	COMS minimum procedures	No	Subpart ZZZZ does not require COMS.

§63.8(c)(6)-(8)	CMS requirements	Yes	Except that subpart ZZZZ does not require COMS.
§63.8(d)	CMS quality control	Yes.	
§63.8(e)	CMS performance evaluation	Yes	Except for §63.8(e)(5)(ii), which applies to COMS.
		Except that §63.8(e) only applies as specified in §63.6645.	
§63.8(f)(1)-(5)	Alternative monitoring method	Yes	Except that §63.8(f)(4) only applies as specified in §63.6645.
§63.8(f)(6)	Alternative to relative accuracy test	Yes	Except that §63.8(f)(6) only applies as specified in §63.6645.
§63.8(g)	Data reduction	Yes	Except that provisions for COMS are not applicable. Averaging periods for demonstrating compliance are specified at §§63.6635 and 63.6640.
§63.9(a)	Applicability and State delegation of notification requirements	Yes.	
§63.9(b)(1)-(5)	Initial notifications	Yes	Except that §63.9(b)(3) is reserved.
		Except that §63.9(b) only applies as specified in §63.6645.	
§63.9(c)	Request for compliance extension	Yes	Except that §63.9(c) only applies as specified in §63.6645.
§63.9(d)	Notification of special compliance requirements for new sources	Yes	Except that §63.9(d) only applies as specified in §63.6645.
§63.9(e)	Notification of performance test	Yes	Except that §63.9(e) only applies as specified in §63.6645.
§63.9(f)	Notification of visible emission (VE)/opacity test	No	Subpart ZZZZ does not contain opacity or VE standards.
§63.9(g)(1)	Notification of performance evaluation	Yes	Except that §63.9(g) only applies as specified in §63.6645.
§63.9(g)(2)	Notification of use of COMS data	No	Subpart ZZZZ does not contain opacity or VE standards.
§63.9(g)(3)	Notification that criterion for alternative to RATA is exceeded	Yes	If alternative is in use.
		Except that §63.9(g) only applies as specified in §63.6645.	
§63.9(h)(1)-(6)	Notification of compliance status	Yes	Except that notifications for sources

			using a CEMS are due 30 days after completion of performance evaluations. §63.9(h)(4) is reserved.
			Except that §63.9(h) only applies as specified in §63.6645.
§63.9(i)	Adjustment of submittal deadlines	Yes.	
§63.9(j)	Change in previous information	Yes.	
§63.10(a)	Administrative provisions for recordkeeping/reporting	Yes.	
§63.10(b)(1)	Record retention	Yes	Except that the most recent 2 years of data do not have to be retained on site.
§63.10(b)(2)(i)-(v)	Records related to SSM	No.	
§63.10(b)(2)(vi)-(xi)	Records	Yes.	
§63.10(b)(2)(xii)	Record when under waiver	Yes.	
§63.10(b)(2)(xiii)	Records when using alternative to RATA	Yes	For CO standard if using RATA alternative.
§63.10(b)(2)(xiv)	Records of supporting documentation	Yes.	
§63.10(b)(3)	Records of applicability determination	Yes.	
§63.10(c)	Additional records for sources using CEMS	Yes	Except that §63.10(c)(2)-(4) and (9) are reserved.
§63.10(d)(1)	General reporting requirements	Yes.	
§63.10(d)(2)	Report of performance test results	Yes.	
§63.10(d)(3)	Reporting opacity or VE observations	No	Subpart ZZZZ does not contain opacity or VE standards.
§63.10(d)(4)	Progress reports	Yes.	
§63.10(d)(5)	Startup, shutdown, and malfunction reports	No.	
§63.10(e)(1) and (2)(i)	Additional CMS Reports	Yes.	
§63.10(e)(2)(ii)	COMS-related report	No	Subpart ZZZZ does not require COMS.
§63.10(e)(3)	Excess emission and parameter exceedances reports	Yes.	Except that §63.10(e)(3)(i) (C) is reserved.
§63.10(e)(4)	Reporting COMS data	No	Subpart ZZZZ does not require COMS.
§63.10(f)	Waiver for recordkeeping/reporting	Yes.	
§63.11	Flares	No.	
§63.12	State authority and delegations	Yes.	

§63.13	Addresses	Yes.	
§63.14	Incorporation by reference	Yes.	
§63.15	Availability of information	Yes.	

[75 FR 9688, Mar. 3, 2010, as amended at 78 FR 6720, Jan. 30, 2013]

 Back to Top

Appendix A—Protocol for Using an Electrochemical Analyzer to Determine Oxygen and Carbon Monoxide Concentrations From Certain Engines

1.0 SCOPE AND APPLICATION. WHAT IS THIS PROTOCOL?

This protocol is a procedure for using portable electrochemical (EC) cells for measuring carbon monoxide (CO) and oxygen (O₂) concentrations in controlled and uncontrolled emissions from existing stationary 4-stroke lean burn and 4-stroke rich burn reciprocating internal combustion engines as specified in the applicable rule.

1.1 Analytes. What does this protocol determine?

This protocol measures the engine exhaust gas concentrations of carbon monoxide (CO) and oxygen (O₂).

Analyte	CAS No.	Sensitivity
Carbon monoxide (CO)	630-08-0	Minimum detectable limit should be 2 percent of the nominal range or 1 ppm, whichever is less restrictive.
Oxygen (O ₂)	7782-44-7	

1.2 Applicability. When is this protocol acceptable?

This protocol is applicable to 40 CFR part 63, subpart ZZZZ. Because of inherent cross sensitivities of EC cells, you must not apply this protocol to other emissions sources without specific instruction to that effect.

1.3 Data Quality Objectives. How good must my collected data be?

Refer to Section 13 to verify and document acceptable analyzer performance.

1.4 Range. What is the targeted analytical range for this protocol?

The measurement system and EC cell design(s) conforming to this protocol will determine the analytical range for each gas component. The nominal ranges are defined by choosing up-scale calibration gas concentrations near the maximum anticipated flue gas concentrations for CO and O₂, or no more than twice the permitted CO level.

1.5 Sensitivity. What minimum detectable limit will this protocol yield for a particular gas component?

The minimum detectable limit depends on the nominal range and resolution of the specific EC cell used, and the signal to noise ratio of the measurement system. The minimum detectable limit should be 2 percent of the nominal range or 1 ppm, whichever is less restrictive.

2.0 SUMMARY OF PROTOCOL

In this protocol, a gas sample is extracted from an engine exhaust system and then conveyed to a portable EC analyzer for measurement of CO and O₂ gas concentrations. This method provides measurement system performance specifications and sampling protocols to ensure reliable data. You may use additions to, or modifications of vendor supplied measurement systems (e.g., heated or unheated sample lines, thermocouples, flow meters, selective gas scrubbers, etc.) to meet the design specifications of this protocol. Do not make changes to the measurement system from the as-verified configuration (Section 3.12).

3.0 DEFINITIONS

3.1 Measurement System. The total equipment required for the measurement of CO and O₂ concentrations. The measurement system consists of the following major subsystems:

3.1.1 Data Recorder. A strip chart recorder, computer or digital recorder for logging measurement data from the analyzer output. You may record measurement data from the digital data display manually or electronically.

3.1.2 Electrochemical (EC) Cell. A device, similar to a fuel cell, used to sense the presence of a specific analyte and generate an electrical current output proportional to the analyte concentration.

3.1.3 Interference Gas Scrubber. A device used to remove or neutralize chemical compounds that may interfere with the selective operation of an EC cell.

3.1.4 Moisture Removal System. Any device used to reduce the concentration of moisture in the sample stream so as to protect the EC cells from the damaging effects of condensation and to minimize errors in measurements caused by the scrubbing of soluble gases.

3.1.5 Sample Interface. The portion of the system used for one or more of the following: sample acquisition; sample transport; sample conditioning or protection of the EC cell from any degrading effects of the engine exhaust effluent; removal of particulate matter and condensed moisture.

3.2 Nominal Range. The range of analyte concentrations over which each EC cell is operated (normally 25 percent to 150 percent of up-scale calibration gas value). Several nominal ranges can be used for any given cell so long as the calibration and repeatability checks for that range remain within specifications.

3.3 Calibration Gas. A vendor certified concentration of a specific analyte in an appropriate balance gas.

3.4 Zero Calibration Error. The analyte concentration output exhibited by the EC cell in response to zero-level calibration gas.

3.5 Up-Scale Calibration Error. The mean of the difference between the analyte concentration exhibited by the EC cell and the certified concentration of the up-scale calibration gas.

3.6 Interference Check. A procedure for quantifying analytical interference from components in the engine exhaust gas other than the targeted analytes.

3.7 Repeatability Check. A protocol for demonstrating that an EC cell operated over a given nominal analyte concentration range provides a stable and consistent response and is not significantly affected by repeated exposure to that gas.

3.8 Sample Flow Rate. The flow rate of the gas sample as it passes through the EC cell. In some situations, EC cells can experience drift with changes in flow rate. The flow rate must be monitored and documented during all phases of a sampling run.

3.9 Sampling Run. A timed three-phase event whereby an EC cell's response rises and plateaus in a sample conditioning phase, remains relatively constant during a measurement data phase, then declines during a refresh phase. The sample conditioning phase exposes the EC cell to the gas sample for a length of time sufficient to reach a constant response. The measurement data phase is the time interval during which gas sample measurements can be made that meet the acceptance criteria of this protocol. The refresh phase then purges the EC cells with CO-free air. The refresh phase replenishes requisite O₂ and moisture in the electrolyte reserve and provides a mechanism to degas or desorb any interference gas scrubbers or filters so as to enable a stable CO EC cell response. There are four primary types of sampling runs: pre-sampling calibrations; stack gas sampling; post-sampling calibration checks; and measurement system repeatability checks. Stack gas sampling runs can be chained together for extended evaluations, providing all other procedural specifications are met.

3.10 Sampling Day. A time not to exceed twelve hours from the time of the pre-sampling calibration to the post-sampling calibration check. During this time, stack gas sampling runs can be repeated without repeated recalibrations, providing all other sampling specifications have been met.

3.11 Pre-Sampling Calibration/Post-Sampling Calibration Check. The protocols executed at the beginning and end of each sampling day to bracket measurement readings with controlled performance checks.

3.12 Performance-Established Configuration. The EC cell and sampling system configuration that existed at the time that it initially met the performance requirements of this protocol.

4.0 INTERFERENCES.

When present in sufficient concentrations, NO and NO₂ are two gas species that have been reported to interfere with CO concentration measurements. In the likelihood of this occurrence, it is the protocol user's responsibility to employ and properly maintain an appropriate CO EC cell filter or scrubber for removal of these gases, as described in Section 6.2.12.

5.0 SAFETY. [RESERVED]

6.0 EQUIPMENT AND SUPPLIES.

6.1 What equipment do I need for the measurement system?

The system must maintain the gas sample at conditions that will prevent moisture condensation in the sample transport lines, both before and as the sample gas contacts the EC cells. The essential components of the measurement system are described below.

6.2 Measurement System Components.

6.2.1 Sample Probe. A single extraction-point probe constructed of glass, stainless steel or other non-reactive material, and of length sufficient to reach any designated sampling point. The sample probe must be designed to prevent plugging due to condensation or particulate matter.

6.2.2 Sample Line. Non-reactive tubing to transport the effluent from the sample probe to the EC cell.

6.2.3 Calibration Assembly (optional). A three-way valve assembly or equivalent to introduce calibration gases at ambient pressure at the exit end of the sample probe during calibration checks. The assembly must be designed such that only stack gas or calibration gas flows in the sample line and all gases flow through any gas path filters.

6.2.4 Particulate Filter (optional). Filters before the inlet of the EC cell to prevent accumulation of particulate material in the measurement system and extend the useful life of the components. All filters must be fabricated of materials that are non-reactive to the gas mixtures being sampled.

6.2.5 Sample Pump. A leak-free pump to provide undiluted sample gas to the system at a flow rate sufficient to minimize the response time of the measurement system. If located upstream of the EC cells, the pump must be constructed of a material that is non-reactive to the gas mixtures being sampled.

6.2.8 Sample Flow Rate Monitoring. An adjustable rotameter or equivalent device used to adjust and maintain the sample flow rate through the analyzer as prescribed.

6.2.9 Sample Gas Manifold (optional). A manifold to divert a portion of the sample gas stream to the analyzer and the remainder to a by-pass discharge vent. The sample gas manifold may also include provisions for introducing calibration gases directly to the analyzer. The manifold must be constructed of a material that is non-reactive to the gas mixtures being sampled.

6.2.10 EC cell. A device containing one or more EC cells to determine the CO and O₂ concentrations in the sample gas stream. The EC cell(s) must meet the applicable performance specifications of Section 13 of this protocol.

6.2.11 Data Recorder. A strip chart recorder, computer or digital recorder to make a record of analyzer output data. The data recorder resolution (i.e., readability) must be no greater than 1 ppm for CO; 0.1 percent for O₂; and one degree (either °C or °F) for temperature. Alternatively, you may use a digital or analog meter having the same resolution to observe and manually record the analyzer responses.

6.2.12 Interference Gas Filter or Scrubber. A device to remove interfering compounds upstream of the CO EC cell. Specific interference gas filters or scrubbers used in the performance-established configuration of the analyzer must continue to be used. Such a filter or scrubber must have a means to determine when the removal agent is exhausted. Periodically replace or replenish it in accordance with the manufacturer's recommendations.

7.0 REAGENTS AND STANDARDS. WHAT CALIBRATION GASES ARE NEEDED?

7.1 Calibration Gases. CO calibration gases for the EC cell must be CO in nitrogen or CO in a mixture of nitrogen and O₂. Use CO calibration gases with labeled concentration values certified by the manufacturer to be within ±5 percent of the label value. Dry ambient air (20.9 percent O₂) is acceptable for calibration of the O₂ cell. If needed, any lower percentage O₂ calibration gas must be a mixture of O₂ in nitrogen.

7.1.1 Up-Scale CO Calibration Gas Concentration. Choose one or more up-scale gas concentrations such that the average of the stack gas measurements for each stack gas sampling run are between 25 and 150 percent of those concentrations. Alternatively, choose an up-scale gas that does not exceed twice the concentration of the applicable outlet standard. If a measured gas value exceeds 150 percent of the up-scale CO calibration gas value at any time during the stack gas sampling run, the run must be discarded and repeated.

7.1.2 Up-Scale O₂ Calibration Gas Concentration.

Select an O₂ gas concentration such that the difference between the gas concentration and the average stack gas measurement or reading for each sample run is less than 15 percent O₂. When the average exhaust gas O₂ readings are above 6 percent, you may use dry ambient air (20.9 percent O₂) for the up-scale O₂ calibration gas.

7.1.3 Zero Gas. Use an inert gas that contains less than 0.25 percent of the up-scale CO calibration gas concentration. You may use dry air that is free from ambient CO and other combustion gas products (e.g., CO₂).

8.0 SAMPLE COLLECTION AND ANALYSIS

8.1 Selection of Sampling Sites.

8.1.1 Control Device Inlet. Select a sampling site sufficiently downstream of the engine so that the combustion gases should be well mixed. Use a single sampling extraction point near the center of the duct (e.g., within the 10 percent centroidal area), unless instructed otherwise.

8.1.2 Exhaust Gas Outlet. Select a sampling site located at least two stack diameters downstream of any disturbance (e.g., turbocharger exhaust, crossover junction or recirculation take-off) and at least one-half stack diameter upstream of the gas discharge to the atmosphere. Use a single sampling extraction point near the center of the duct (e.g., within the 10 percent centroidal area), unless instructed otherwise.

8.2 Stack Gas Collection and Analysis. Prior to the first stack gas sampling run, conduct that the pre-sampling calibration in accordance with Section 10.1. Use Figure 1 to record all data. Zero the analyzer with zero gas. Confirm and record that the scrubber media color is correct and not exhausted. Then position the probe at the sampling point and begin the sampling run at the same flow rate used during the up-scale calibration. Record the start time. Record all EC cell output responses and the flow rate during the “sample conditioning phase” once per minute until constant readings are obtained. Then begin the “measurement data phase” and record readings every 15 seconds for at least two minutes (or eight readings), or as otherwise required to achieve two continuous minutes of data that meet the specification given in Section 13.1. Finally, perform the “refresh phase” by introducing dry air, free from CO and other combustion gases, until several minute-to-minute readings of consistent value have been obtained. For each run use the “measurement data phase” readings to calculate the average stack gas CO and O₂ concentrations.

8.3 EC Cell Rate. Maintain the EC cell sample flow rate so that it does not vary by more than ± 10 percent throughout the pre-sampling calibration, stack gas sampling and post-sampling calibration check. Alternatively, the EC cell sample flow rate can be maintained within a tolerance range that does not affect the gas concentration readings by more than ± 3 percent, as instructed by the EC cell manufacturer.

9.0 QUALITY CONTROL (RESERVED)

10.0 CALIBRATION AND STANDARDIZATION

10.1 Pre-Sampling Calibration. Conduct the following protocol once for each nominal range to be used on each EC cell before performing a stack gas sampling run on each field sampling day. Repeat the calibration if you replace an EC cell before completing all of the sampling runs. There is no prescribed order for calibration of the EC cells; however, each cell must complete the measurement data phase during calibration. Assemble the measurement system by following the manufacturer's recommended protocols including for preparing and preconditioning the EC cell. Assure the measurement system has no leaks and verify the gas scrubbing agent is not depleted. Use Figure 1 to record all data.

10.1.1 Zero Calibration. For both the O₂ and CO cells, introduce zero gas to the measurement system (e.g., at the calibration assembly) and record the concentration reading every minute until readings are constant for at least two consecutive minutes. Include the time and sample flow rate. Repeat the steps in this section at least once to verify the zero calibration for each component gas.

10.1.2 Zero Calibration Tolerance. For each zero gas introduction, the zero level output must be less than or equal to ± 3 percent of the up-scale gas value or ± 1 ppm, whichever is less restrictive, for the CO channel and less than or equal to ± 0.3 percent O₂ for the O₂ channel.

10.1.3 Up-Scale Calibration. Individually introduce each calibration gas to the measurement system (e.g., at the calibration assembly) and record the start time. Record all EC cell output responses and the flow rate during this “sample conditioning phase” once per minute until readings are constant for at least two minutes. Then begin the “measurement data phase” and record readings every 15 seconds for a total of two minutes, or as otherwise required. Finally, perform the “refresh phase” by introducing dry air, free from CO and other combustion gases, until readings are constant for at least two consecutive minutes. Then repeat the steps in this section at least once to verify the

calibration for each component gas. Introduce all gases to flow through the entire sample handling system (i.e., at the exit end of the sampling probe or the calibration assembly).

10.1.4 Up-Scale Calibration Error. The mean of the difference of the “measurement data phase” readings from the reported standard gas value must be less than or equal to ± 5 percent or ± 1 ppm for CO or ± 0.5 percent O₂, whichever is less restrictive, respectively. The maximum allowable deviation from the mean measured value of any single “measurement data phase” reading must be less than or equal to ± 2 percent or ± 1 ppm for CO or ± 0.5 percent O₂, whichever is less restrictive, respectively.

10.2 Post-Sampling Calibration Check. Conduct a stack gas post-sampling calibration check after the stack gas sampling run or set of runs and within 12 hours of the initial calibration. Conduct up-scale and zero calibration checks using the protocol in Section 10.1. Make no changes to the sampling system or EC cell calibration until all post-sampling calibration checks have been recorded. If either the zero or up-scale calibration error exceeds the respective specification in Sections 10.1.2 and 10.1.4 then all measurement data collected since the previous successful calibrations are invalid and re-calibration and re-sampling are required. If the sampling system is disassembled or the EC cell calibration is adjusted, repeat the calibration check before conducting the next analyzer sampling run.

11.0 ANALYTICAL PROCEDURE

The analytical procedure is fully discussed in Section 8.

12.0 CALCULATIONS AND DATA ANALYSIS

Determine the CO and O₂ concentrations for each stack gas sampling run by calculating the mean gas concentrations of the data recorded during the “measurement data phase”.

13.0 PROTOCOL PERFORMANCE

Use the following protocols to verify consistent analyzer performance during each field sampling day.

13.1 Measurement Data Phase Performance Check. Calculate the mean of the readings from the “measurement data phase”. The maximum allowable deviation from the mean for each of the individual readings is ± 2 percent, or ± 1 ppm, whichever is less restrictive. Record the mean value and maximum deviation for each gas monitored. Data must conform to Section 10.1.4. The EC cell flow rate must conform to the specification in Section 8.3.

Example: A measurement data phase is invalid if the maximum deviation of any single reading comprising that mean is greater than ± 2 percent or ± 1 ppm (the default criteria). For example, if the mean = 30 ppm, single readings of below 29 ppm and above 31 ppm are disallowed).

13.2 Interference Check. Before the initial use of the EC cell and interference gas scrubber in the field, and semi-annually thereafter, challenge the interference gas scrubber with NO and NO₂ gas standards that are generally recognized as representative of diesel-fueled engine NO and NO₂ emission values. Record the responses displayed by the CO EC cell and other pertinent data on Figure 1 or a similar form.

13.2.1 Interference Response. The combined NO and NO₂ interference response should be less than or equal to ± 5 percent of the up-scale CO calibration gas concentration.

13.3 Repeatability Check. Conduct the following check once for each nominal range that is to be used on the CO EC cell within 5 days prior to each field sampling program. If a field sampling program lasts longer than 5 days, repeat this check every 5 days. Immediately repeat the check if the EC cell is replaced or if the EC cell is exposed to gas concentrations greater than 150 percent of the highest up-scale gas concentration.

Appendix P

Subpart DDDDD—National Emission Standards for Hazardous Air Pollutants for Major Sources: Industrial, Commercial, and Institutional Boilers and Process Heaters

Contents

WHAT THIS SUBPART COVERS

- [§63.7480 What is the purpose of this subpart?](#)
- [§63.7485 Am I subject to this subpart?](#)
- [§63.7490 What is the affected source of this subpart?](#)
- [§63.7491 Are any boilers or process heaters not subject to this subpart?](#)
- [§63.7495 When do I have to comply with this subpart?](#)

EMISSION LIMITATIONS AND WORK PRACTICE STANDARDS

- [§63.7499 What are the subcategories of boilers and process heaters?](#)
- [§63.7500 What emission limitations, work practice standards, and operating limits must I meet?](#)
- [§63.7501 Affirmative Defense for Violation of Emission Standards During Malfunction.](#)

GENERAL COMPLIANCE REQUIREMENTS

- [§63.7505 What are my general requirements for complying with this subpart?](#)

TESTING, FUEL ANALYSES, AND INITIAL COMPLIANCE REQUIREMENTS

- [§63.7510 What are my initial compliance requirements and by what date must I conduct them?](#)
- [§63.7515 When must I conduct subsequent performance tests, fuel analyses, or tune-ups?](#)
- [§63.7520 What stack tests and procedures must I use?](#)
- [§63.7521 What fuel analyses, fuel specification, and procedures must I use?](#)
- [§63.7522 Can I use emissions averaging to comply with this subpart?](#)
- [§63.7525 What are my monitoring, installation, operation, and maintenance requirements?](#)
- [§63.7530 How do I demonstrate initial compliance with the emission limitations, fuel specifications and work practice standards?](#)
- [§63.7533 Can I use efficiency credits earned from implementation of energy conservation measures to comply with this subpart?](#)

CONTINUOUS COMPLIANCE REQUIREMENTS

- [§63.7535 Is there a minimum amount of monitoring data I must obtain?](#)
- [§63.7540 How do I demonstrate continuous compliance with the emission limitations, fuel specifications and work practice standards?](#)
- [§63.7541 How do I demonstrate continuous compliance under the emissions averaging provision?](#)

NOTIFICATION, REPORTS, AND RECORDS

- [§63.7545 What notifications must I submit and when?](#)
- [§63.7550 What reports must I submit and when?](#)
- [§63.7555 What records must I keep?](#)

[§63.7560 In what form and how long must I keep my records?](#)

OTHER REQUIREMENTS AND INFORMATION

[§63.7565 What parts of the General Provisions apply to me?](#)

[§63.7570 Who implements and enforces this subpart?](#)

[§63.7575 What definitions apply to this subpart?](#)

[Table 1 to Subpart DDDDD of Part 63—Emission Limits for New or Reconstructed Boilers and Process Heaters](#)

[Table 2 to Subpart DDDDD of Part 63—Emission Limits for Existing Boilers and Process Heaters](#)

[Table 3 to Subpart DDDDD of Part 63—Work Practice Standards](#)

[Table 4 to Subpart DDDDD of Part 63—Operating Limits for Boilers and Process Heaters](#)

[Table 5 to Subpart DDDDD of Part 63—Performance Testing Requirements](#)

[Table 6 to Subpart DDDDD of Part 63—Fuel Analysis Requirements](#)

[Table 7 to Subpart DDDDD of Part 63—Establishing Operating Limits](#)

[Table 8 to Subpart DDDDD of Part 63—Demonstrating Continuous Compliance](#)

[Table 9 to Subpart DDDDD of Part 63—Reporting Requirements](#)

[Table 10 to Subpart DDDDD of Part 63—Applicability of General Provisions to Subpart DDDDD](#)

[Table 11 to Subpart DDDDD of Part 63—Toxic Equivalency Factors for Dioxins/Furans](#)

[Table 12 to Subpart DDDDD of Part 63—Alternative Emission Limits for New or Reconstructed Boilers and Process Heaters That Commenced Construction or Reconstruction After June 4, 2010, and Before May 20, 2011](#)

[Table 13 to Subpart DDDDD of Part 63—Alternative Emission Limits for New or Reconstructed Boilers and Process Heaters That Commenced Construction or Reconstruction After December 23, 2011, and Before January 31, 2013](#)

SOURCE: 76 FR 15664, Mar. 21, 2011, unless otherwise noted.

WHAT THIS SUBPART COVERS

§63.7480 What is the purpose of this subpart?

This subpart establishes national emission limitations and work practice standards for hazardous air pollutants (HAP) emitted from industrial, commercial, and institutional boilers and process heaters located at major sources of HAP. This subpart also establishes requirements to demonstrate initial and continuous compliance with the emission limitations and work practice standards.

§63.7485 Am I subject to this subpart?

You are subject to this subpart if you own or operate an industrial, commercial, or institutional boiler or process heater as defined in §63.7575 that is located at, or is part of, a major source of HAP, except as specified in §63.7491. For purposes of this subpart, a major source of HAP is as defined in §63.2, except that for oil and natural gas production facilities, a major source of HAP is as defined in §63.7575.

[78 FR 7162, Jan. 31, 2013]

§63.7490 What is the affected source of this subpart?

(a) This subpart applies to new, reconstructed, and existing affected sources as described in paragraphs (a)(1) and (2) of this section.

(1) The affected source of this subpart is the collection at a major source of all existing industrial, commercial, and institutional boilers and process heaters within a subcategory as defined in §63.7575.

(2) The affected source of this subpart is each new or reconstructed industrial, commercial, or institutional boiler or process heater, as defined in §63.7575, located at a major source.

(b) A boiler or process heater is new if you commence construction of the boiler or process heater after June 4, 2010, and you meet the applicability criteria at the time you commence construction.

(c) A boiler or process heater is reconstructed if you meet the reconstruction criteria as defined in §63.2, you commence reconstruction after June 4, 2010, and you meet the applicability criteria at the time you commence reconstruction.

(d) A boiler or process heater is existing if it is not new or reconstructed.

(e) An existing electric utility steam generating unit (EGU) that meets the applicability requirements of this subpart after the effective date of this final rule due to a change (e.g., fuel switch) is considered to be an existing source under this subpart.

[76 FR 15664, Mar. 21, 2011, as amended at 78 FR 7162, Jan. 31, 2013]

§63.7491 Are any boilers or process heaters not subject to this subpart?

The types of boilers and process heaters listed in paragraphs (a) through (n) of this section are not subject to this subpart.

(a) An electric utility steam generating unit (EGU) covered by subpart UUUUU of this part.

(b) A recovery boiler or furnace covered by subpart MM of this part.

(c) A boiler or process heater that is used specifically for research and development, including test steam boilers used to provide steam for testing the propulsion systems on military vessels. This does not include units that provide heat or steam to a process at a research and development facility.

(d) A hot water heater as defined in this subpart.

(e) A refining kettle covered by subpart X of this part.

(f) An ethylene cracking furnace covered by subpart YY of this part.

(g) Blast furnace stoves as described in EPA-453/R-01-005 (incorporated by reference, see §63.14).

(h) Any boiler or process heater that is part of the affected source subject to another subpart of this part, such as boilers and process heaters used as control devices to comply with subparts JJJ, OOO, PPP, and U of this part.

(i) Any boiler or process heater that is used as a control device to comply with another subpart of this part, or part 60, part 61, or part 65 of this chapter provided that at least 50 percent of the average annual heat input during any 3 consecutive calendar years to the boiler or process heater is provided by regulated gas streams that are subject to another standard.

(j) Temporary boilers as defined in this subpart.

(k) Blast furnace gas fuel-fired boilers and process heaters as defined in this subpart.

(l) Any boiler specifically listed as an affected source in any standard(s) established under section 129 of the Clean Air Act.

(m) A unit that burns hazardous waste covered by Subpart EEE of this part. A unit that is exempt from Subpart EEE as specified in §63.1200(b) is not covered by Subpart EEE.

[76 FR 15664, Mar. 21, 2011, as amended at 78 FR 7162, Jan. 31, 2013]

EDITORIAL NOTE: At 78 FR 7162, Jan. 31, 2013, §63.7491 was amended by revising paragraph (n). However, there is no paragraph (n) to be revised.

§63.7495 When do I have to comply with this subpart?

(a) If you have a new or reconstructed boiler or process heater, you must comply with this subpart by January 31, 2013, or upon startup of your boiler or process heater, whichever is later.

(b) If you have an existing boiler or process heater, you must comply with this subpart no later than January 31, 2016, except as provided in §63.6(i).

(c) If you have an area source that increases its emissions or its potential to emit such that it becomes a major source of HAP, paragraphs (c)(1) and (2) of this section apply to you.

(1) Any new or reconstructed boiler or process heater at the existing source must be in compliance with this subpart upon startup.

(2) Any existing boiler or process heater at the existing source must be in compliance with this subpart within 3 years after the source becomes a major source.

(d) You must meet the notification requirements in §63.7545 according to the schedule in §63.7545 and in subpart A of this part. Some of the notifications must be submitted before you are required to comply with the emission limits and work practice standards in this subpart.

(e) If you own or operate an industrial, commercial, or institutional boiler or process heater and would be subject to this subpart except for the exemption in §63.7491(l) for commercial and industrial solid waste incineration units covered by part 60, subpart CCCC or subpart DDDD, and you cease combusting solid waste, you must be in compliance with this subpart on the effective date of the switch from waste to fuel.

(f) If you own or operate an existing EGU that becomes subject to this subpart after January 31, 2013, you must be in compliance with the applicable existing source provisions of this subpart on the effective date such unit becomes subject to this subpart.

(g) If you own or operate an existing industrial, commercial, or institutional boiler or process heater and would be subject to this subpart except for a exemption in §63.7491(i) that becomes subject to this subpart after January 31, 2013, you must be in compliance with the applicable existing source provisions of this subpart within 3 years after such unit becomes subject to this subpart.

[76 FR 15664, Mar. 21, 2011, as amended at 78 FR 7162, Jan. 31, 2013]

EDITORIAL NOTE: At 78 FR 7162, Jan. 31, 2013, §63.7495 was amended by adding paragraph (e). However, there is already a paragraph (e).

EMISSION LIMITATIONS AND WORK PRACTICE STANDARDS

§63.7499 What are the subcategories of boilers and process heaters?

The subcategories of boilers and process heaters, as defined in §63.7575 are:

- (a) Pulverized coal/solid fossil fuel units.
- (b) Stokers designed to burn coal/solid fossil fuel.
- (c) Fluidized bed units designed to burn coal/solid fossil fuel.
- (d) Stokers/sloped grate/other units designed to burn kiln dried biomass/bio-based solid.
- (e) Fluidized bed units designed to burn biomass/bio-based solid.
- (f) Suspension burners designed to burn biomass/bio-based solid.
- (g) Fuel cells designed to burn biomass/bio-based solid.
- (h) Hybrid suspension/grate burners designed to burn wet biomass/bio-based solid.
- (i) Stokers/sloped grate/other units designed to burn wet biomass/bio-based solid.
- (j) Dutch ovens/pile burners designed to burn biomass/bio-based solid.
- (k) Units designed to burn liquid fuel that are non-continental units.
- (l) Units designed to burn gas 1 fuels.
- (m) Units designed to burn gas 2 (other) gases.
- (n) Metal process furnaces.
- (o) Limited-use boilers and process heaters.
- (p) Units designed to burn solid fuel.
- (q) Units designed to burn liquid fuel.
- (r) Units designed to burn coal/solid fossil fuel.
- (s) Fluidized bed units with an integrated fluidized bed heat exchanger designed to burn coal/solid fossil fuel.
- (t) Units designed to burn heavy liquid fuel.
- (u) Units designed to burn light liquid fuel.

§63.7500 What emission limitations, work practice standards, and operating limits must I meet?

(a) You must meet the requirements in paragraphs (a)(1) through (3) of this section, except as provided in paragraphs (b), through (e) of this section. You must meet these requirements at all times the affected unit is operating, except as provided in paragraph (f) of this section.

(1) You must meet each emission limit and work practice standard in Tables 1 through 3, and 11 through 13 to this subpart that applies to your boiler or process heater, for each boiler or process heater at your source, except as provided under §63.7522. The output-based emission limits, in units of pounds per million Btu of steam output, in Tables 1 or 2 to this subpart are an alternative applicable only to boilers and process heaters that generate steam. The output-based emission limits, in units of pounds per megawatt-hour, in Tables 1 or 2 to this subpart are an alternative applicable only to boilers that generate electricity. If you operate a new boiler or process heater, you can choose to comply with alternative limits as discussed in paragraphs (a)(1)(i) through (a)(1)(iii) of this section, but on or after January 31, 2016, you must comply with the emission limits in Table 1 to this subpart.

(i) If your boiler or process heater commenced construction or reconstruction after June 4, 2010 and before May 20, 2011, you may comply with the emission limits in Table 1 or 11 to this subpart until January 31, 2016.

(ii) If your boiler or process heater commenced construction or reconstruction after May 20, 2011 and before December 23, 2011, you may comply with the emission limits in Table 1 or 12 to this subpart until January 31, 2016.

(iii) If your boiler or process heater commenced construction or reconstruction after December 23, 2011 and before January 31, 2013, you may comply with the emission limits in Table 1 or 13 to this subpart until January 31, 2016.

(2) You must meet each operating limit in Table 4 to this subpart that applies to your boiler or process heater. If you use a control device or combination of control devices not covered in Table 4 to this subpart, or you wish to establish and monitor an alternative operating limit or an alternative monitoring parameter, you must apply to the EPA Administrator for approval of alternative monitoring under §63.8(f).

(3) At all times, you must operate and maintain any affected source (as defined in §63.7490), including associated air pollution control equipment and monitoring equipment, in a manner consistent with safety and good air pollution control practices for minimizing emissions. Determination of whether such operation and maintenance procedures are being used will be based on information available to the Administrator that may include, but is not limited to, monitoring results, review of operation and maintenance procedures, review of operation and maintenance records, and inspection of the source.

(b) As provided in §63.6(g), EPA may approve use of an alternative to the work practice standards in this section.

(c) Limited-use boilers and process heaters must complete a tune-up every 5 years as specified in §63.7540. They are not subject to the emission limits in Tables 1 and 2 or 11 through 13 to this subpart, the annual tune-up, or the energy assessment requirements in Table 3 to this subpart, or the operating limits in Table 4 to this subpart.

(d) Boilers and process heaters with a heat input capacity of less than or equal to 5 million Btu per hour in the units designed to burn gas 2 (other) fuels subcategory or units designed to burn light liquid fuels subcategory must complete a tune-up every 5 years as specified in §63.7540.

(e) Boilers and process heaters in the units designed to burn gas 1 fuels subcategory with a heat input capacity of less than or equal to 5 million Btu per hour must complete a tune-up every 5 years as specified in §63.7540. Boilers and process heaters in the units designed to burn gas 1 fuels subcategory with a heat input capacity greater than 5 million Btu per hour and less than 10 million Btu per hour must complete a tune-up every 2 years as specified in §63.7540. Boilers and process heaters in the units designed to burn gas 1 fuels subcategory are not subject to the emission limits in Tables 1 and 2 or 11 through 13 to this subpart, or the operating limits in Table 4 to this subpart.

(f) These standards apply at all times the affected unit is operating, except during periods of startup and shutdown during which time you must comply only with Table 3 to this subpart.

[76 FR 15664, Mar. 21, 2011, as amended at 78 FR 7163, Jan. 31, 2013]

§63.7501 Affirmative Defense for Violation of Emission Standards During Malfunction.

In response to an action to enforce the standards set forth in §63.7500 you may assert an affirmative defense to a claim for civil penalties for violations of such standards that are caused by malfunction, as defined at §63.2. Appropriate penalties may be assessed if you fail to meet your burden of proving all of the requirements in the affirmative defense. The affirmative defense shall not be available for claims for injunctive relief.

(a) *Assertion of affirmative defense.* To establish the affirmative defense in any action to enforce such a standard, you must timely meet the reporting requirements in paragraph (b) of this section, and must prove by a preponderance of evidence that:

(1) The violation:

(i) Was caused by a sudden, infrequent, and unavoidable failure of air pollution control equipment, process equipment, or a process to operate in a normal or usual manner; and

(ii) Could not have been prevented through careful planning, proper design, or better operation and maintenance practices; and

(iii) Did not stem from any activity or event that could have been foreseen and avoided, or planned for; and

(iv) Was not part of a recurring pattern indicative of inadequate design, operation, or maintenance; and

(2) Repairs were made as expeditiously as possible when a violation occurred; and

(3) The frequency, amount, and duration of the violation (including any bypass) were minimized to the maximum extent practicable; and

(4) If the violation resulted from a bypass of control equipment or a process, then the bypass was unavoidable to prevent loss of life, personal injury, or severe property damage; and

(5) All possible steps were taken to minimize the impact of the violation on ambient air quality, the environment, and human health; and

(6) All emissions monitoring and control systems were kept in operation if at all possible, consistent with safety and good air pollution control practices; and

(7) All of the actions in response to the violation were documented by properly signed, contemporaneous operating logs; and

(8) At all times, the affected source was operated in a manner consistent with good practices for minimizing emissions; and

(9) A written root cause analysis has been prepared, the purpose of which is to determine, correct, and eliminate the primary causes of the malfunction and the violation resulting from the malfunction event at issue. The analysis shall also specify, using best monitoring methods and engineering judgment, the amount of any emissions that were the result of the malfunction.

(b) *Report.* The owner or operator seeking to assert an affirmative defense shall submit a written report to the Administrator with all necessary supporting documentation, that it has met the requirements set forth in §63.7500 of this section. This affirmative defense report shall be included in the first periodic compliance, deviation report or excess emission report otherwise required after the initial occurrence of the violation of the relevant standard (which may be the end of any applicable averaging period). If such compliance, deviation report or excess emission report is due less than 45 days after the initial occurrence of the violation, the affirmative defense report may be included in the second compliance, deviation report or excess emission report due after the initial occurrence of the violation of the relevant standard.

[78 FR 7163, Jan. 31, 2013]

GENERAL COMPLIANCE REQUIREMENTS

§63.7505 What are my general requirements for complying with this subpart?

(a) You must be in compliance with the emission limits, work practice standards, and operating limits in this subpart. These limits apply to you at all times the affected unit is operating except for the periods noted in §63.7500(f).

(b) [Reserved]

(c) You must demonstrate compliance with all applicable emission limits using performance stack testing, fuel analysis, or continuous monitoring systems (CMS), including a continuous emission monitoring system (CEMS), continuous opacity monitoring system (COMS), continuous parameter monitoring system (CPMS), or particulate matter continuous parameter monitoring system (PM CPMS), where applicable. You may demonstrate compliance with the applicable emission limit for hydrogen chloride (HCl), mercury, or total selected metals (TSM) using fuel analysis if the emission rate calculated according to §63.7530(c) is less than the applicable emission limit. (For gaseous fuels, you may not use fuel analyses to comply with the TSM alternative standard or the HCl standard.) Otherwise, you must demonstrate compliance for HCl, mercury, or TSM using performance testing, if subject to an applicable emission limit listed in Tables 1, 2, or 11 through 13 to this subpart.

(d) If you demonstrate compliance with any applicable emission limit through performance testing and subsequent compliance with operating limits (including the use of CPMS), or with a CEMS, or COMS, you must develop a site-specific monitoring plan according to the requirements in paragraphs (d)(1) through (4) of this section for the use of any CEMS, COMS, or CPMS. This requirement also applies to you if you petition the EPA Administrator for alternative monitoring parameters under §63.8(f).

(1) For each CMS required in this section (including CEMS, COMS, or CPMS), you must develop, and submit to the Administrator for approval upon request, a site-specific monitoring plan that addresses design, data collection, and the quality assurance and quality control elements outlined in §63.8(d) and the elements described in paragraphs (d)(1)(i) through (iii) of this section. You must submit this site-

specific monitoring plan, if requested, at least 60 days before your initial performance evaluation of your CMS. This requirement to develop and submit a site specific monitoring plan does not apply to affected sources with existing CEMS or COMS operated according to the performance specifications under appendix B to part 60 of this chapter and that meet the requirements of §63.7525. Using the process described in §63.8(f)(4), you may request approval of alternative monitoring system quality assurance and quality control procedures in place of those specified in this paragraph and, if approved, include the alternatives in your site-specific monitoring plan.

(i) Installation of the CMS sampling probe or other interface at a measurement location relative to each affected process unit such that the measurement is representative of control of the exhaust emissions (e.g., on or downstream of the last control device);

(ii) Performance and equipment specifications for the sample interface, the pollutant concentration or parametric signal analyzer, and the data collection and reduction systems; and

(iii) Performance evaluation procedures and acceptance criteria (e.g., calibrations, accuracy audits, analytical drift).

(2) In your site-specific monitoring plan, you must also address paragraphs (d)(2)(i) through (iii) of this section.

(i) Ongoing operation and maintenance procedures in accordance with the general requirements of §63.8(c)(1)(ii), (c)(3), and (c)(4)(ii);

(ii) Ongoing data quality assurance procedures in accordance with the general requirements of §63.8(d); and

(iii) Ongoing recordkeeping and reporting procedures in accordance with the general requirements of §63.10(c) (as applicable in Table 10 to this subpart), (e)(1), and (e)(2)(i).

(3) You must conduct a performance evaluation of each CMS in accordance with your site-specific monitoring plan.

(4) You must operate and maintain the CMS in continuous operation according to the site-specific monitoring plan.

[76 FR 15664, Mar. 21, 2011, as amended at 78 FR 7164, Jan. 31, 2013]

TESTING, FUEL ANALYSES, AND INITIAL COMPLIANCE REQUIREMENTS

§63.7510 What are my initial compliance requirements and by what date must I conduct them?

(a) For each boiler or process heater that is required or that you elect to demonstrate compliance with any of the applicable emission limits in Tables 1 or 2 or 11 through 13 of this subpart through performance testing, your initial compliance requirements include all the following:

(1) Conduct performance tests according to §63.7520 and Table 5 to this subpart.

(2) Conduct a fuel analysis for each type of fuel burned in your boiler or process heater according to §63.7521 and Table 6 to this subpart, except as specified in paragraphs (a)(2)(i) through (iii) of this section.

(i) For each boiler or process heater that burns a single type of fuel, you are not required to conduct a fuel analysis for each type of fuel burned in your boiler or process heater according to §63.7521 and Table 6 to this subpart. For purposes of this subpart, units that use a supplemental fuel only for startup, unit shutdown, and transient flame stability purposes still qualify as units that burn a single type of fuel, and the supplemental fuel is not subject to the fuel analysis requirements under §63.7521 and Table 6 to this subpart.

(ii) When natural gas, refinery gas, or other gas 1 fuels are co-fired with other fuels, you are not required to conduct a fuel analysis of those fuels according to §63.7521 and Table 6 to this subpart. If gaseous fuels other than natural gas, refinery gas, or other gas 1 fuels are co-fired with other fuels and those gaseous fuels are subject to another subpart of this part, part 60, part 61, or part 65, you are not required to conduct a fuel analysis of those fuels according to §63.7521 and Table 6 to this subpart.

(iii) You are not required to conduct a chlorine fuel analysis for any gaseous fuels. You must conduct a fuel analysis for mercury on gaseous fuels unless the fuel is exempted in paragraphs (a)(2)(i) and (ii) of this section.

(3) Establish operating limits according to §63.7530 and Table 7 to this subpart.

(4) Conduct CMS performance evaluations according to §63.7525.

(b) For each boiler or process heater that you elect to demonstrate compliance with the applicable emission limits in Tables 1 or 2 or 11 through 13 to this subpart for HCl, mercury, or TSM through fuel analysis, your initial compliance requirement is to conduct a fuel analysis for each type of fuel burned in your boiler or process heater according to §63.7521 and Table 6 to this subpart and establish operating limits according to §63.7530 and Table 8 to this subpart. The fuels described in paragraph (a)(2)(i) and (ii) of this section are exempt from these fuel analysis and operating limit requirements. The fuels described in paragraph (a)(2)(ii) of this section are exempt from the chloride fuel analysis and operating limit requirements. Boilers and process heaters that use a CEMS for mercury or HCl are exempt from the performance testing and operating limit requirements specified in paragraph (a) of this section for the HAP for which CEMS are used.

(c) If your boiler or process heater is subject to a carbon monoxide (CO) limit, your initial compliance demonstration for CO is to conduct a performance test for CO according to Table 5 to this subpart or conduct a performance evaluation of your continuous CO monitor, if applicable, according to §63.7525(a). Boilers and process heaters that use a CO CEMS to comply with the applicable alternative CO CEMS emission standard listed in Tables 12, or 11 through 13 to this subpart, as specified in §63.7525(a), are exempt from the initial CO performance testing and oxygen concentration operating limit requirements specified in paragraph (a) of this section.

(d) If your boiler or process heater is subject to a PM limit, your initial compliance demonstration for PM is to conduct a performance test in accordance with §63.7520 and Table 5 to this subpart.

(e) For existing affected sources (as defined in §63.7490), you must complete the initial compliance demonstration, as specified in paragraphs (a) through (d) of this section, no later than 180 days after the compliance date that is specified for your source in §63.7495 and according to the applicable provisions in §63.7(a)(2) as cited in Table 10 to this subpart, except as specified in paragraph (j) of this section. You must complete an initial tune-up by following the procedures described in §63.7540(a)(10)(i) through (vi) no later than the compliance date specified in §63.7495, except as specified in paragraph (j) of this section. You must complete the one-time energy assessment specified in Table 3 to this subpart no later than the compliance date specified in §63.7495, except as specified in paragraph (j) of this section.

(f) For new or reconstructed affected sources (as defined in §63.7490), you must complete the initial compliance demonstration with the emission limits no later than July 30, 2013 or within 180 days after

startup of the source, whichever is later. If you are demonstrating compliance with an emission limit in Tables 11 through 13 to this subpart that is less stringent (that is, higher) than the applicable emission limit in Table 1 to this subpart, you must demonstrate compliance with the applicable emission limit in Table 1 no later than July 29, 2016.

(g) For new or reconstructed affected sources (as defined in §63.7490), you must demonstrate initial compliance with the applicable work practice standards in Table 3 to this subpart within the applicable annual, biennial, or 5-year schedule as specified in §63.7540(a) following the initial compliance date specified in §63.7495(a). Thereafter, you are required to complete the applicable annual, biennial, or 5-year tune-up as specified in §63.7540(a).

(h) For affected sources (as defined in §63.7490) that ceased burning solid waste consistent with §63.7495(e) and for which the initial compliance date has passed, you must demonstrate compliance within 60 days of the effective date of the waste-to-fuel switch. If you have not conducted your compliance demonstration for this subpart within the previous 12 months, you must complete all compliance demonstrations for this subpart before you commence or recommence combustion of solid waste.

(i) For an existing EGU that becomes subject after January 31, 2013, you must demonstrate compliance within 180 days after becoming an affected source.

(j) For existing affected sources (as defined in §63.7490) that have not operated between the effective date of the rule and the compliance date that is specified for your source in §63.7495, you must complete the initial compliance demonstration, if subject to the emission limits in Table 2 to this subpart, as specified in paragraphs (a) through (d) of this section, no later than 180 days after the re-start of the affected source and according to the applicable provisions in §63.7(a)(2) as cited in Table 10 to this subpart. You must complete an initial tune-up by following the procedures described in §63.7540(a)(10)(i) through (vi) no later than 30 days after the re-start of the affected source and, if applicable, complete the one-time energy assessment specified in Table 3 to this subpart, no later than the compliance date specified in §63.7495.

[78 FR 7164, Jan. 31, 2013]

§63.7515 When must I conduct subsequent performance tests, fuel analyses, or tune-ups?

(a) You must conduct all applicable performance tests according to §63.7520 on an annual basis, except as specified in paragraphs (b) through (e), (g), and (h) of this section. Annual performance tests must be completed no more than 13 months after the previous performance test, except as specified in paragraphs (b) through (e), (g), and (h) of this section.

(b) If your performance tests for a given pollutant for at least 2 consecutive years show that your emissions are at or below 75 percent of the emission limit (or, in limited instances as specified in Tables 1 and 2 or 11 through 13 to this subpart, at or below the emission limit) for the pollutant, and if there are no changes in the operation of the individual boiler or process heater or air pollution control equipment that could increase emissions, you may choose to conduct performance tests for the pollutant every third year. Each such performance test must be conducted no more than 37 months after the previous performance test. If you elect to demonstrate compliance using emission averaging under §63.7522, you must continue to conduct performance tests annually. The requirement to test at maximum chloride input level is waived unless the stack test is conducted for HCl. The requirement to test at maximum mercury input level is waived unless the stack test is conducted for mercury. The requirement to test at maximum TSM input level is waived unless the stack test is conducted for TSM.

(c) If a performance test shows emissions exceeded the emission limit or 75 percent of the emission limit (as specified in Tables 1 and 2 or 11 through 13 to this subpart) for a pollutant, you must conduct annual performance tests for that pollutant until all performance tests over a consecutive 2-year period

meet the required level (at or below 75 percent of the emission limit, as specified in Tables 1 and 2 or 11 through 13 to this subpart).

(d) If you are required to meet an applicable tune-up work practice standard, you must conduct an annual, biennial, or 5-year performance tune-up according to §63.7540(a)(10), (11), or (12), respectively. Each annual tune-up specified in §63.7540(a)(10) must be no more than 13 months after the previous tune-up. Each biennial tune-up specified in §63.7540(a)(11) must be conducted no more than 25 months after the previous tune-up. Each 5-year tune-up specified in §63.7540(a)(12) must be conducted no more than 61 months after the previous tune-up. For a new or reconstructed affected source (as defined in §63.7490), the first annual, biennial, or 5-year tune-up must be no later than 13 months, 25 months, or 61 months, respectively, after the initial startup of the new or reconstructed affected source.

(e) If you demonstrate compliance with the mercury, HCl, or TSM based on fuel analysis, you must conduct a monthly fuel analysis according to §63.7521 for each type of fuel burned that is subject to an emission limit in Tables 1, 2, or 11 through 13 to this subpart. You may comply with this monthly requirement by completing the fuel analysis any time within the calendar month as long as the analysis is separated from the previous analysis by at least 14 calendar days. If you burn a new type of fuel, you must conduct a fuel analysis before burning the new type of fuel in your boiler or process heater. You must still meet all applicable continuous compliance requirements in §63.7540. If each of 12 consecutive monthly fuel analyses demonstrates 75 percent or less of the compliance level, you may decrease the fuel analysis frequency to quarterly for that fuel. If any quarterly sample exceeds 75 percent of the compliance level or you begin burning a new type of fuel, you must return to monthly monitoring for that fuel, until 12 months of fuel analyses are again less than 75 percent of the compliance level.

(f) You must report the results of performance tests and the associated fuel analyses within 60 days after the completion of the performance tests. This report must also verify that the operating limits for each boiler or process heater have not changed or provide documentation of revised operating limits established according to §63.7530 and Table 7 to this subpart, as applicable. The reports for all subsequent performance tests must include all applicable information required in §63.7550.

(g) For affected sources (as defined in §63.7490) that have not operated since the previous compliance demonstration and more than one year has passed since the previous compliance demonstration, you must complete the subsequent compliance demonstration, if subject to the emission limits in Tables 1, 2, or 11 through 13 to this subpart, no later than 180 days after the re-start of the affected source and according to the applicable provisions in §63.7(a)(2) as cited in Table 10 to this subpart. You must complete a subsequent tune-up by following the procedures described in §63.7540(a)(10)(i) through (vi) and the schedule described in §63.7540(a)(13) for units that are not operating at the time of their scheduled tune-up.

(h) If your affected boiler or process heater is in the unit designed to burn light liquid subcategory and you combust ultra low sulfur liquid fuel, you do not need to conduct further performance tests if the pollutants measured during the initial compliance performance tests meet the emission limits in Tables 1 or 2 of this subpart providing you demonstrate ongoing compliance with the emissions limits by monitoring and recording the type of fuel combusted on a monthly basis. If you intend to use a fuel other than ultra low sulfur liquid fuel, natural gas, refinery gas, or other gas 1 fuel, you must conduct new performance tests within 60 days of burning the new fuel type.

(i) If you operate a CO CEMS that meets the Performance Specifications outlined in §63.7525(a)(3) of this subpart to demonstrate compliance with the applicable alternative CO CEMS emission standard listed in Tables 1, 2, or 11 through 13 to this subpart, you are not required to conduct CO performance tests and are not subject to the oxygen concentration operating limit requirement specified in §63.7510(a).

§63.7520 What stack tests and procedures must I use?

(a) You must conduct all performance tests according to §63.7(c), (d), (f), and (h). You must also develop a site-specific stack test plan according to the requirements in §63.7(c). You shall conduct all performance tests under such conditions as the Administrator specifies to you based on the representative performance of each boiler or process heater for the period being tested. Upon request, you shall make available to the Administrator such records as may be necessary to determine the conditions of the performance tests.

(b) You must conduct each performance test according to the requirements in Table 5 to this subpart.

(c) You must conduct each performance test under the specific conditions listed in Tables 5 and 7 to this subpart. You must conduct performance tests at representative operating load conditions while burning the type of fuel or mixture of fuels that has the highest content of chlorine and mercury, and TSM if you are opting to comply with the TSM alternative standard and you must demonstrate initial compliance and establish your operating limits based on these performance tests. These requirements could result in the need to conduct more than one performance test. Following each performance test and until the next performance test, you must comply with the operating limit for operating load conditions specified in Table 4 to this subpart.

(d) You must conduct a minimum of three separate test runs for each performance test required in this section, as specified in §63.7(e)(3). Each test run must comply with the minimum applicable sampling times or volumes specified in Tables 1 and 2 or 11 through 13 to this subpart.

(e) To determine compliance with the emission limits, you must use the F-Factor methodology and equations in sections 12.2 and 12.3 of EPA Method 19 at 40 CFR part 60, appendix A-7 of this chapter to convert the measured particulate matter (PM) concentrations, the measured HCl concentrations, the measured mercury concentrations, and the measured TSM concentrations that result from the performance test to pounds per million Btu heat input emission rates.

(f) Except for a 30-day rolling average based on CEMS (or sorbent trap monitoring system) data, if measurement results for any pollutant are reported as below the method detection level (e.g., laboratory analytical results for one or more sample components are below the method defined analytical detection level), you must use the method detection level as the measured emissions level for that pollutant in calculating compliance. The measured result for a multiple component analysis (e.g., analytical values for multiple Method 29 fractions both for individual HAP metals and for total HAP metals) may include a combination of method detection level data and analytical data reported above the method detection level.

[76 FR 15664, Mar. 21, 2011, as amended at 78 FR 7166, Jan. 31, 2013]

§63.7521 What fuel analyses, fuel specification, and procedures must I use?

(a) For solid and liquid fuels, you must conduct fuel analyses for chloride and mercury according to the procedures in paragraphs (b) through (e) of this section and Table 6 to this subpart, as applicable. For solid fuels and liquid fuels, you must also conduct fuel analyses for TSM if you are opting to comply with the TSM alternative standard. For gas 2 (other) fuels, you must conduct fuel analyses for mercury according to the procedures in paragraphs (b) through (e) of this section and Table 6 to this subpart, as applicable. (For gaseous fuels, you may not use fuel analyses to comply with the TSM alternative standard or the HCl standard.) For purposes of complying with this section, a fuel gas system that consists of multiple gaseous fuels collected and mixed with each other is considered a single fuel type and sampling and analysis is only required on the combined fuel gas system that will feed the boiler or process heater. Sampling and analysis of the individual gaseous streams prior to combining is not

required. You are not required to conduct fuel analyses for fuels used for only startup, unit shutdown, and transient flame stability purposes. You are required to conduct fuel analyses only for fuels and units that are subject to emission limits for mercury, HCl, or TSM in Tables 1 and 2 or 11 through 13 to this subpart. Gaseous and liquid fuels are exempt from the sampling requirements in paragraphs (c) and (d) of this section and Table 6 to this subpart.

(b) You must develop a site-specific fuel monitoring plan according to the following procedures and requirements in paragraphs (b)(1) and (2) of this section, if you are required to conduct fuel analyses as specified in §63.7510.

(1) If you intend to use an alternative analytical method other than those required by Table 6 to this subpart, you must submit the fuel analysis plan to the Administrator for review and approval no later than 60 days before the date that you intend to conduct the initial compliance demonstration described in §63.7510.

(2) You must include the information contained in paragraphs (b)(2)(i) through (vi) of this section in your fuel analysis plan.

(i) The identification of all fuel types anticipated to be burned in each boiler or process heater.

(ii) For each anticipated fuel type, the notification of whether you or a fuel supplier will be conducting the fuel analysis.

(iii) For each anticipated fuel type, a detailed description of the sample location and specific procedures to be used for collecting and preparing the composite samples if your procedures are different from paragraph (c) or (d) of this section. Samples should be collected at a location that most accurately represents the fuel type, where possible, at a point prior to mixing with other dissimilar fuel types.

(iv) For each anticipated fuel type, the analytical methods from Table 6, with the expected minimum detection levels, to be used for the measurement of chlorine or mercury.

(v) If you request to use an alternative analytical method other than those required by Table 6 to this subpart, you must also include a detailed description of the methods and procedures that you are proposing to use. Methods in Table 6 shall be used until the requested alternative is approved.

(vi) If you will be using fuel analysis from a fuel supplier in lieu of site-specific sampling and analysis, the fuel supplier must use the analytical methods required by Table 6 to this subpart.

(c) At a minimum, you must obtain three composite fuel samples for each fuel type according to the procedures in paragraph (c)(1) or (2) of this section, or the methods listed in Table 6 to this subpart, or use an automated sampling mechanism that provides representative composite fuel samples for each fuel type that includes both coarse and fine material.

(1) If sampling from a belt (or screw) feeder, collect fuel samples according to paragraphs (c)(1)(i) and (ii) of this section.

(i) Stop the belt and withdraw a 6-inch wide sample from the full cross-section of the stopped belt to obtain a minimum two pounds of sample. You must collect all the material (fines and coarse) in the full cross-section. You must transfer the sample to a clean plastic bag.

(ii) Each composite sample will consist of a minimum of three samples collected at approximately equal one-hour intervals during the testing period for sampling during performance stack testing. For

monthly sampling, each composite sample shall be collected at approximately equal 10-day intervals during the month.

(2) If sampling from a fuel pile or truck, you must collect fuel samples according to paragraphs (c)(2)(i) through (iii) of this section.

(i) For each composite sample, you must select a minimum of five sampling locations uniformly spaced over the surface of the pile.

(ii) At each sampling site, you must dig into the pile to a uniform depth of approximately 18 inches. You must insert a clean shovel into the hole and withdraw a sample, making sure that large pieces do not fall off during sampling; use the same shovel to collect all samples.

(iii) You must transfer all samples to a clean plastic bag for further processing.

(d) You must prepare each composite sample according to the procedures in paragraphs (d)(1) through (7) of this section.

(1) You must thoroughly mix and pour the entire composite sample over a clean plastic sheet.

(2) You must break large sample pieces (e.g., larger than 3 inches) into smaller sizes.

(3) You must make a pie shape with the entire composite sample and subdivide it into four equal parts.

(4) You must separate one of the quarter samples as the first subset.

(5) If this subset is too large for grinding, you must repeat the procedure in paragraph (d)(3) of this section with the quarter sample and obtain a one-quarter subset from this sample.

(6) You must grind the sample in a mill.

(7) You must use the procedure in paragraph (d)(3) of this section to obtain a one-quarter subsample for analysis. If the quarter sample is too large, subdivide it further using the same procedure.

(e) You must determine the concentration of pollutants in the fuel (mercury and/or chlorine and/or TSM) in units of pounds per million Btu of each composite sample for each fuel type according to the procedures in Table 6 to this subpart, for use in Equations 7, 8, and 9 of this subpart.

(f) To demonstrate that a gaseous fuel other than natural gas or refinery gas qualifies as an other gas 1 fuel, as defined in §63.7575, you must conduct a fuel specification analyses for mercury according to the procedures in paragraphs (g) through (i) of this section and Table 6 to this subpart, as applicable, except as specified in paragraph (f)(1) through (4) of this section.

(1) You are not required to conduct the fuel specification analyses in paragraphs (g) through (i) of this section for natural gas or refinery gas.

(2) You are not required to conduct the fuel specification analyses in paragraphs (g) through (i) of this section for gaseous fuels that are subject to another subpart of this part, part 60, part 61, or part 65.

(3) You are not required to conduct the fuel specification analyses in paragraphs (g) through (i) of this section on gaseous fuels for units that are complying with the limits for units designed to burn gas 2 (other) fuels.

(4) You are not required to conduct the fuel specification analyses in paragraphs (g) through (i) of this section for gas streams directly derived from natural gas at natural gas production sites or natural gas plants.

(g) You must develop and submit a site-specific fuel analysis plan for other gas 1 fuels to the EPA Administrator for review and approval according to the following procedures and requirements in paragraphs (g)(1) and (2) of this section.

(1) If you intend to use an alternative analytical method other than those required by Table 6 to this subpart, you must submit the fuel analysis plan to the Administrator for review and approval no later than 60 days before the date that you intend to conduct the initial compliance demonstration described in §63.7510.

(2) You must include the information contained in paragraphs (g)(2)(i) through (vi) of this section in your fuel analysis plan.

(i) The identification of all gaseous fuel types other than those exempted from fuel specification analysis under (f)(1) through (3) of this section anticipated to be burned in each boiler or process heater.

(ii) For each anticipated fuel type, the notification of whether you or a fuel supplier will be conducting the fuel specification analysis.

(iii) For each anticipated fuel type, a detailed description of the sample location and specific procedures to be used for collecting and preparing the samples if your procedures are different from the sampling methods contained in Table 6 to this subpart. Samples should be collected at a location that most accurately represents the fuel type, where possible, at a point prior to mixing with other dissimilar fuel types. If multiple boilers or process heaters are fueled by a common fuel stream it is permissible to conduct a single gas specification at the common point of gas distribution.

(iv) For each anticipated fuel type, the analytical methods from Table 6 to this subpart, with the expected minimum detection levels, to be used for the measurement of mercury.

(v) If you request to use an alternative analytical method other than those required by Table 6 to this subpart, you must also include a detailed description of the methods and procedures that you are proposing to use. Methods in Table 6 to this subpart shall be used until the requested alternative is approved.

(vi) If you will be using fuel analysis from a fuel supplier in lieu of site-specific sampling and analysis, the fuel supplier must use the analytical methods required by Table 6 to this subpart.

(h) You must obtain a single fuel sample for each fuel type according to the sampling procedures listed in Table 6 for fuel specification of gaseous fuels.

(i) You must determine the concentration in the fuel of mercury, in units of microgram per cubic meter, dry basis, of each sample for each other gas 1 fuel type according to the procedures in Table 6 to this subpart.

§63.7522 Can I use emissions averaging to comply with this subpart?

(a) As an alternative to meeting the requirements of §63.7500 for PM (or TSM), HCl, or mercury on a boiler or process heater-specific basis, if you have more than one existing boiler or process heater in any subcategories located at your facility, you may demonstrate compliance by emissions averaging, if your averaged emissions are not more than 90 percent of the applicable emission limit, according to the procedures in this section. You may not include new boilers or process heaters in an emissions average.

(b) For a group of two or more existing boilers or process heaters in the same subcategory that each vent to a separate stack, you may average PM (or TSM), HCl, or mercury emissions among existing units to demonstrate compliance with the limits in Table 2 to this subpart as specified in paragraph (b)(1) through (3) of this section, if you satisfy the requirements in paragraphs (c) through (g) of this section.

(1) You may average units using a CEMS or PM CPMS for demonstrating compliance.

(2) For mercury and HCl, averaging is allowed as follows:

(i) You may average among units in any of the solid fuel subcategories.

(ii) You may average among units in any of the liquid fuel subcategories.

(iii) You may average among units in a subcategory of units designed to burn gas 2 (other) fuels.

(iv) You may not average across the units designed to burn liquid, units designed to burn solid fuel, and units designed to burn gas 2 (other) subcategories.

(3) For PM (or TSM), averaging is only allowed between units within each of the following subcategories and you may not average across subcategories:

(i) Units designed to burn coal/solid fossil fuel.

(ii) Stokers/sloped grate/other units designed to burn kiln dried biomass/bio-based solids.

(iii) Stokers/sloped grate/other units designed to burn wet biomass/bio-based solids.

(iv) Fluidized bed units designed to burn biomass/bio-based solid.

(v) Suspension burners designed to burn biomass/bio-based solid.

(vi) Dutch ovens/pile burners designed to burn biomass/bio-based solid.

(vii) Fuel Cells designed to burn biomass/bio-based solid.

(viii) Hybrid suspension/grate burners designed to burn wet biomass/bio-based solid.

(ix) Units designed to burn heavy liquid fuel.

(x) Units designed to burn light liquid fuel.

(xi) Units designed to burn liquid fuel that are non-continental units.

(xii) Units designed to burn gas 2 (other) gases.

(c) For each existing boiler or process heater in the averaging group, the emission rate achieved during the initial compliance test for the HAP being averaged must not exceed the emission level that was being achieved on January 31, 2013 or the control technology employed during the initial compliance test must not be less effective for the HAP being averaged than the control technology employed on January 31, 2013.

(d) The averaged emissions rate from the existing boilers and process heaters participating in the emissions averaging option must not exceed 90 percent of the limits in Table 2 to this subpart at all times the affected units are operating following the compliance date specified in §63.7495.

(e) You must demonstrate initial compliance according to paragraph (e)(1) or (2) of this section using the maximum rated heat input capacity or maximum steam generation capacity of each unit and the results of the initial performance tests or fuel analysis.

(1) You must use Equation 1a or 1b or 1c of this section to demonstrate that the PM (or TSM), HCl, or mercury emissions from all existing units participating in the emissions averaging option for that pollutant do not exceed the emission limits in Table 2 to this subpart. Use Equation 1a if you are complying with the emission limits on a heat input basis, use Equation 1b if you are complying with the emission limits on a steam generation (output) basis, and use Equation 1c if you are complying with the emission limits on a electric generation (output) basis.

$$AveWeightedEmissions = 1.1 \times \sum_{i=1}^n (Er \times Hm) \div \sum_{i=1}^n Hm \quad (\text{Eq. 1a})$$

[View or download PDF](#)

Where:

AveWeightedEmissions = Average weighted emissions for PM (or TSM), HCl, or mercury, in units of pounds per million Btu of heat input.

Er = Emission rate (as determined during the initial compliance demonstration) of PM (or TSM), HCl, or mercury from unit, i, in units of pounds per million Btu of heat input. Determine the emission rate for PM (or TSM), HCl, or mercury by performance testing according to Table 5 to this subpart, or by fuel analysis for HCl or mercury or TSM using the applicable equation in §63.7530(c).

Hm = Maximum rated heat input capacity of unit, i, in units of million Btu per hour.

n = Number of units participating in the emissions averaging option.

1.1 = Required discount factor.

$$AveWeightedEmissions = 1.1 \times \sum_{i=1}^n (Er \times So) \div \sum_{i=1}^n So \quad (\text{Eq. 1b})$$

[View or download PDF](#)

Where:

AveWeightedEmissions = Average weighted emissions for PM (or TSM), HCl, or mercury, in units of pounds per million Btu of steam output.

Er = Emission rate (as determined during the initial compliance demonstration) of PM (or TSM), HCl, or mercury from unit, i, in units of pounds per million Btu of steam output. Determine the emission rate for PM (or TSM), HCl, or mercury by performance testing according to Table 5 to this subpart, or by fuel analysis for HCl or mercury or TSM using the applicable equation in §63.7530(c). If you are taking credit for energy

conservation measures from a unit according to §63.7533, use the adjusted emission level for that unit, Eadj, determined according to §63.7533 for that unit.

So = Maximum steam output capacity of unit, i, in units of million Btu per hour, as defined in §63.7575.

n = Number of units participating in the emissions averaging option.

1.1 = Required discount factor.

$$\text{AveWeightedEmissions} = 1.1 \times \sum_{j=1}^n (Er \times Eo) \div \sum_{j=1}^n Eo \quad (\text{Eq. 1c})$$

[View or download PDF](#)

Where:

AveWeightedEmissions = Average weighted emissions for PM (or TSM), HCl, or mercury, in units of pounds per megawatt hour.

Er = Emission rate (as determined during the initial compliance demonstration) of PM (or TSM), HCl, or mercury from unit, i, in units of pounds per megawatt hour. Determine the emission rate for PM (or TSM), HCl, or mercury by performance testing according to Table 5 to this subpart, or by fuel analysis for HCl or mercury or TSM using the applicable equation in §63.7530(c). If you are taking credit for energy conservation measures from a unit according to §63.7533, use the adjusted emission level for that unit, Eadj, determined according to §63.7533 for that unit.

Eo = Maximum electric generating output capacity of unit, i, in units of megawatt hour, as defined in §63.7575.

n = Number of units participating in the emissions averaging option.

1.1 = Required discount factor.

(2) If you are not capable of determining the maximum rated heat input capacity of one or more boilers that generate steam, you may use Equation 2 of this section as an alternative to using Equation 1a of this section to demonstrate that the PM (or TSM), HCl, or mercury emissions from all existing units participating in the emissions averaging option do not exceed the emission limits for that pollutant in Table 2 to this subpart that are in pounds per million Btu of heat input.

$$\text{AveWeightedEmissions} = 1.1 \times \sum_{i=1}^n (Er \times Sm \times Cfi) \div \sum_{i=1}^n (Sm \times Cfi) \quad (\text{Eq. 2})$$

[View or download PDF](#)

Where:

AveWeightedEmissions = Average weighted emission level for PM (or TSM), HCl, or mercury, in units of pounds per million Btu of heat input.

Er = Emission rate (as determined during the most recent compliance demonstration) of PM (or TSM), HCl, or mercury from unit, i, in units of pounds per million Btu of heat input. Determine the emission rate for PM (or TSM), HCl, or mercury by performance testing according to Table 5 to this subpart, or by fuel analysis for HCl or mercury or TSM using the applicable equation in §63.7530(c).

Sm = Maximum steam generation capacity by unit, i, in units of pounds per hour.

Cfi = Conversion factor, calculated from the most recent compliance test, in units of million Btu of heat input per pounds of steam generated for unit, i.

1.1 = Required discount factor.

(f) After the initial compliance demonstration described in paragraph (e) of this section, you must demonstrate compliance on a monthly basis determined at the end of every month (12 times per year) according to paragraphs (f)(1) through (3) of this section. The first monthly period begins on the compliance date specified in §63.7495. If the affected source elects to collect monthly data for up to the 11 months preceding the first monthly period, these additional data points can be used to compute the 12-month rolling average in paragraph (f)(3) of this section.

(1) For each calendar month, you must use Equation 3a or 3b or 3c of this section to calculate the average weighted emission rate for that month. Use Equation 3a and the actual heat input for the month for each existing unit participating in the emissions averaging option if you are complying with emission limits on a heat input basis. Use Equation 3b and the actual steam generation for the month if you are complying with the emission limits on a steam generation (output) basis. Use Equation 3c and the actual steam generation for the month if you are complying with the emission limits on an electrical generation (output) basis.

$$AveWeightedEmissions = 1.1 \times \sum_{i=1}^n (Er \times Hb) \div \sum_{i=1}^n Hb \quad (\text{Eq. 3a})$$

[View or download PDF](#)

Where:

AveWeightedEmissions = Average weighted emission level for PM (or TSM), HCl, or mercury, in units of pounds per million Btu of heat input, for that calendar month.

Er = Emission rate (as determined during the most recent compliance demonstration) of PM (or TSM), HCl, or mercury from unit, i, in units of pounds per million Btu of heat input. Determine the emission rate for PM (or TSM), HCl, or mercury by performance testing according to Table 5 to this subpart, or by fuel analysis for HCl or mercury or TSM according to Table 6 to this subpart.

Hb = The heat input for that calendar month to unit, i, in units of million Btu.

n = Number of units participating in the emissions averaging option.

1.1 = Required discount factor.

$$AveWeightedEmissions = 1.1 \times \sum_{i=1}^n (Er \times So) \div \sum_{i=1}^n So \quad (\text{Eq. 3b})$$

[View or download PDF](#)

Where:

AveWeightedEmissions = Average weighted emission level for PM (or TSM), HCl, or mercury, in units of pounds per million Btu of steam output, for that calendar month.

Er = Emission rate (as determined during the most recent compliance demonstration) of PM (or TSM), HCl, or mercury from unit, i, in units of pounds per million Btu of steam output. Determine the emission rate for PM (or TSM), HCl, or mercury by performance testing according to Table 5 to this subpart, or by fuel analysis for HCl or mercury or TSM according to Table 6 to this subpart. If you are taking credit for energy conservation measures from a unit according to §63.7533, use the adjusted emission level for that unit, E_{adj} , determined according to §63.7533 for that unit.

So = The steam output for that calendar month from unit, i, in units of million Btu, as defined in §63.7575.

n = Number of units participating in the emissions averaging option.

1.1 = Required discount factor.

$$AveWeightedEmissions = 1.1 \times \sum_{i=1}^n (Er \times Eo) \div \sum_{i=1}^n Eo \quad (\text{Eq. } 3c)$$

[View or download PDF](#)

Where:

AveWeightedEmissions = Average weighted emission level for PM (or TSM), HCl, or mercury, in units of pounds per megawatt hour, for that calendar month.

Er = Emission rate (as determined during the most recent compliance demonstration) of PM (or TSM), HCl, or mercury from unit, i, in units of pounds per megawatt hour. Determine the emission rate for PM (or TSM), HCl, or mercury by performance testing according to Table 5 to this subpart, or by fuel analysis for HCl or mercury or TSM according to Table 6 to this subpart. If you are taking credit for energy conservation measures from a unit according to §63.7533, use the adjusted emission level for that unit, E_{adj} , determined according to §63.7533 for that unit.

Eo = The electric generating output for that calendar month from unit, i, in units of megawatt hour, as defined in §63.7575.

n = Number of units participating in the emissions averaging option.

1.1 = Required discount factor.

(2) If you are not capable of monitoring heat input, you may use Equation 4 of this section as an alternative to using Equation 3a of this section to calculate the average weighted emission rate using the actual steam generation from the boilers participating in the emissions averaging option.

$$AveWeightedEmissions = 1.1 \times \sum_{i=1}^n (Er \times Sa \times Cfi) \div \sum_{i=1}^n (Sa \times Cfi) \quad (\text{Eq. } 4)$$

[View or download PDF](#)

Where:

AveWeightedEmissions = average weighted emission level for PM (or TSM), HCl, or mercury, in units of pounds per million Btu of heat input for that calendar month.

Er = Emission rate (as determined during the most recent compliance demonstration of PM (or TSM), HCl, or mercury from unit, i, in units of pounds per million Btu of heat input. Determine the emission rate for PM (or TSM), HCl, or mercury by performance testing according to Table 5 to this subpart, or by fuel analysis for HCl or mercury or TSM according to Table 6 to this subpart.

Sa = Actual steam generation for that calendar month by boiler, i, in units of pounds.

Cfi = Conversion factor, as calculated during the most recent compliance test, in units of million Btu of heat input per pounds of steam generated for boiler, i.

1.1 = Required discount factor.

(3) Until 12 monthly weighted average emission rates have been accumulated, calculate and report only the average weighted emission rate determined under paragraph (f)(1) or (2) of this section for each calendar month. After 12 monthly weighted average emission rates have been accumulated, for each subsequent calendar month, use Equation 5 of this section to calculate the 12-month rolling average of the monthly weighted average emission rates for the current calendar month and the previous 11 calendar months.

$$E_{avg} = \sum_{i=1}^{12} ERi \div 12 \quad (\text{Eq. } 5)$$

[View or download PDF](#)

Where:

E_{avg} = 12-month rolling average emission rate, (pounds per million Btu heat input)

ER_i = Monthly weighted average, for calendar month "i" (pounds per million Btu heat input), as calculated by paragraph (f)(1) or (2) of this section.

(g) You must develop, and submit upon request to the applicable Administrator for review and approval, an implementation plan for emission averaging according to the following procedures and requirements in paragraphs (g)(1) through (4) of this section.

(1) You must submit the implementation plan no later than 180 days before the date that the facility intends to demonstrate compliance using the emission averaging option.

(2) You must include the information contained in paragraphs (g)(2)(i) through (vii) of this section in your implementation plan for all emission sources included in an emissions average:

(i) The identification of all existing boilers and process heaters in the averaging group, including for each either the applicable HAP emission level or the control technology installed as of January 31, 2013 and the date on which you are requesting emission averaging to commence;

(ii) The process parameter (heat input or steam generated) that will be monitored for each averaging group;

(iii) The specific control technology or pollution prevention measure to be used for each emission boiler or process heater in the averaging group and the date of its installation or application. If the pollution prevention measure reduces or eliminates emissions from multiple boilers or process heaters, the owner or operator must identify each boiler or process heater;

(iv) The test plan for the measurement of PM (or TSM), HCl, or mercury emissions in accordance with the requirements in §63.7520;

(v) The operating parameters to be monitored for each control system or device consistent with §63.7500 and Table 4, and a description of how the operating limits will be determined;

(vi) If you request to monitor an alternative operating parameter pursuant to §63.7525, you must also include:

(A) A description of the parameter(s) to be monitored and an explanation of the criteria used to select the parameter(s); and

(B) A description of the methods and procedures that will be used to demonstrate that the parameter indicates proper operation of the control device; the frequency and content of monitoring, reporting, and recordkeeping requirements; and a demonstration, to the satisfaction of the Administrator, that the proposed monitoring frequency is sufficient to represent control device operating conditions; and

(vii) A demonstration that compliance with each of the applicable emission limit(s) will be achieved under representative operating load conditions. Following each compliance demonstration and until the next compliance demonstration, you must comply with the operating limit for operating load conditions specified in Table 4 to this subpart.

(3) The Administrator shall review and approve or disapprove the plan according to the following criteria:

(i) Whether the content of the plan includes all of the information specified in paragraph (g)(2) of this section; and

(ii) Whether the plan presents sufficient information to determine that compliance will be achieved and maintained.

(4) The applicable Administrator shall not approve an emission averaging implementation plan containing any of the following provisions:

(i) Any averaging between emissions of differing pollutants or between differing sources; or

(ii) The inclusion of any emission source other than an existing unit in the same subcategories.

(h) For a group of two or more existing affected units, each of which vents through a single common stack, you may average PM (or TSM), HCl, or mercury emissions to demonstrate compliance with the limits for that pollutant in Table 2 to this subpart if you satisfy the requirements in paragraph (i) or (j) of this section.

(i) For a group of two or more existing units in the same subcategories, each of which vents through a common emissions control system to a common stack, that does not receive emissions from units in other subcategories or categories, you may treat such averaging group as a single existing unit for purposes of this subpart and comply with the requirements of this subpart as if the group were a single unit.

(j) For all other groups of units subject to the common stack requirements of paragraph (h) of this section, including situations where the exhaust of affected units are each individually controlled and then sent to a common stack, the owner or operator may elect to:

(1) Conduct performance tests according to procedures specified in §63.7520 in the common stack if affected units from other subcategories vent to the common stack. The emission limits that the group must comply with are determined by the use of Equation 6 of this section.

$$En = \sum_{i=1}^n (ELi \times Hi) \div \sum_{i=1}^n Hi \quad (\text{Eq. 6})$$

[View or download PDF](#)

Where:

En = HAP emission limit, pounds per million British thermal units (lb/MMBtu), parts per million (ppm), or nanograms per dry standard cubic meter (ng/dscm).

ELi = Appropriate emission limit from Table 2 to this subpart for unit i, in units of lb/MMBtu, ppm or ng/dscm.

Hi = Heat input from unit i, MMBtu.

(2) Conduct performance tests according to procedures specified in §63.7520 in the common stack. If affected units and non-affected units vent to the common stack, the non-affected units must be shut down or vented to a different stack during the performance test unless the facility determines to demonstrate compliance with the non-affected units venting to the stack; and

(3) Meet the applicable operating limit specified in §63.7540 and Table 8 to this subpart for each emissions control system (except that, if each unit venting to the common stack has an applicable opacity operating limit, then a single continuous opacity monitoring system may be located in the common stack instead of in each duct to the common stack).

(k) The common stack of a group of two or more existing boilers or process heaters in the same subcategories subject to paragraph (h) of this section may be treated as a separate stack for purposes of paragraph (b) of this section and included in an emissions averaging group subject to paragraph (b) of this section.

[76 FR 15664, Mar. 21, 2011, as amended at 78 FR 7168, Jan. 31, 2013]

§63.7525 What are my monitoring, installation, operation, and maintenance requirements?

(a) If your boiler or process heater is subject to a CO emission limit in Tables 1, 2, or 11 through 13 to this subpart, you must install, operate, and maintain an oxygen analyzer system, as defined in §63.7575, or install, certify, operate and maintain continuous emission monitoring systems for CO and oxygen according to the procedures in paragraphs (a)(1) through (7) of this section.

(1) Install the CO CEMS and oxygen analyzer by the compliance date specified in §63.7495. The CO and oxygen levels shall be monitored at the same location at the outlet of the boiler or process heater.

(2) To demonstrate compliance with the applicable alternative CO CEMS emission standard listed in Tables 1, 2, or 11 through 13 to this subpart, you must install, certify, operate, and maintain a CO CEMS and an oxygen analyzer according to the applicable procedures under Performance Specification 4, 4A, or 4B at 40 CFR part 60, appendix B, the site-specific monitoring plan developed according to §63.7505(d), and the requirements in §63.7540(a)(8) and paragraph (a) of this section. Any boiler or process heater that has a CO CEMS that is compliant with Performance Specification 4, 4A, or 4B at 40 CFR part 60, appendix B, a site-specific monitoring plan developed according to §63.7505(d), and the requirements in §63.7540(a)(8) and paragraph (a) of this section must use the CO CEMS to comply with the applicable alternative CO CEMS emission standard listed in Tables 1, 2, or 11 through 13 to this subpart.

(i) You must conduct a performance evaluation of each CO CEMS according to the requirements in §63.8(e) and according to Performance Specification 4, 4A, or 4B at 40 CFR part 60, appendix B.

(ii) During each relative accuracy test run of the CO CEMS, you must collect emission data for CO concurrently (or within a 30- to 60-minute period) by both the CO CEMS and by Method 10, 10A, or 10B at 40 CFR part 60, appendix A-4. The relative accuracy testing must be at representative operating conditions.

(iii) You must follow the quality assurance procedures (e.g., quarterly accuracy determinations and daily calibration drift tests) of Procedure 1 of appendix F to part 60. The measurement span value of the CO CEMS must be two times the applicable CO emission limit, expressed as a concentration.

(iv) Any CO CEMS that does not comply with §63.7525(a) cannot be used to meet any requirement in this subpart to demonstrate compliance with a CO emission limit listed in Tables 1, 2, or 11 through 13 to this subpart.

(v) For a new unit, complete the initial performance evaluation no later than July 30, 2013, or 180 days after the date of initial startup, whichever is later. For an existing unit, complete the initial performance evaluation no later than July 29, 2016.

(3) Complete a minimum of one cycle of CO and oxygen CEMS operation (sampling, analyzing, and data recording) for each successive 15-minute period. Collect CO and oxygen data concurrently. Collect at least four CO and oxygen CEMS data values representing the four 15-minute periods in an hour, or at least two 15-minute data values during an hour when CEMS calibration, quality assurance, or maintenance activities are being performed.

(4) Reduce the CO CEMS data as specified in §63.8(g)(2).

(5) Calculate one-hour arithmetic averages, corrected to 3 percent oxygen from each hour of CO CEMS data in parts per million CO concentration. The one-hour arithmetic averages required shall be used to calculate the 30-day or 10-day rolling average emissions. Use Equation 19-19 in section 12.4.1 of Method 19 of 40 CFR part 60, appendix A-7 for calculating the average CO concentration from the hourly values.

(6) For purposes of collecting CO data, operate the CO CEMS as specified in §63.7535(b). You must use all the data collected during all periods in calculating data averages and assessing compliance, except that you must exclude certain data as specified in §63.7535(c). Periods when CO data are unavailable may constitute monitoring deviations as specified in §63.7535(d).

(7) Operate an oxygen trim system with the oxygen level set no lower than the lowest hourly average oxygen concentration measured during the most recent CO performance test as the operating limit for oxygen according to Table 7 to this subpart.

(b) If your boiler or process heater is in the unit designed to burn coal/solid fossil fuel subcategory or the unit designed to burn heavy liquid subcategory and has an average annual heat input rate greater than 250 MMBtu per hour from solid fossil fuel and/or heavy liquid, and you demonstrate compliance with the PM limit instead of the alternative TSM limit, you must install, certify, maintain, and operate a PM CPMS monitoring emissions discharged to the atmosphere and record the output of the system as specified in paragraphs (b)(1) through (4) of this section. As an alternative to use of a PM CPMS to demonstrate compliance with the PM limit, you may choose to use a PM CEMS. If you choose to use a PM CEMS to demonstrate compliance with the PM limit instead of the alternative TSM limit, you must install, certify, maintain, and operate a PM CEMS monitoring emissions discharged to the atmosphere and record the output of the system as specified in paragraph (b)(5) through (8) of this section. For other boilers or process heaters, you may elect to use a PM CPMS or PM CEMS operated in accordance with this section in lieu of using other CMS for monitoring PM compliance (e.g., bag leak detectors, ESP secondary power, PM scrubber pressure). Owners of boilers and process heaters who elect to comply with the alternative TSM limit are not required to install a PM CPMS.

(1) Install, certify, operate, and maintain your PM CPMS according to the procedures in your approved site-specific monitoring plan developed in accordance with §63.7505(d), the requirements in §63.7540(a)(9), and paragraphs (b)(1)(i) through (iii) of this section.

(i) The operating principle of the PM CPMS must be based on in-stack or extractive light scatter, light scintillation, beta attenuation, or mass accumulation detection of PM in the exhaust gas or representative exhaust gas sample. The reportable measurement output from the PM CPMS must be expressed as milliamps.

(ii) The PM CPMS must have a cycle time (i.e., period required to complete sampling, measurement, and reporting for each measurement) no longer than 60 minutes.

(iii) The PM CPMS must be capable of detecting and responding to PM concentrations of no greater than 0.5 milligram per actual cubic meter.

(2) For a new unit, complete the initial performance evaluation no later than July 30, 2013, or 180 days after the date of initial startup, whichever is later. For an existing unit, complete the initial performance evaluation no later than July 29, 2016.

(3) Collect PM CPMS hourly average output data for all boiler or process heater operating hours except as indicated in §63.7535(a) through (d). Express the PM CPMS output as milliamps.

(4) Calculate the arithmetic 30-day rolling average of all of the hourly average PM CPMS output data collected during all boiler or process heater operating hours (milliamps).

(5) Install, certify, operate, and maintain your PM CEMS according to the procedures in your approved site-specific monitoring plan developed in accordance with §63.7505(d), the requirements in §63.7540(a)(9), and paragraphs (b)(5)(i) through (iv) of this section.

(i) You shall conduct a performance evaluation of the PM CEMS according to the applicable requirements of §60.8(e), and Performance Specification 11 at 40 CFR part 60, appendix B of this chapter.

(ii) During each PM correlation testing run of the CEMS required by Performance Specification 11 at 40 CFR part 60, appendix B of this chapter, you shall collect PM and oxygen (or carbon dioxide) data concurrently (or within a 30-to 60-minute period) by both the CEMS and conducting performance tests using Method 5 at 40 CFR part 60, appendix A-3 or Method 17 at 40 CFR part 60, appendix A-6 of this chapter.

(iii) You shall perform quarterly accuracy determinations and daily calibration drift tests in accordance with Procedure 2 at 40 CFR part 60, appendix F of this chapter. You must perform Relative Response Audits annually and perform Response Correlation Audits every 3 years.

(iv) Within 60 days after the date of completing each CEMS relative accuracy test audit or performance test conducted to demonstrate compliance with this subpart, you must submit the relative accuracy test audit data and performance test data to the EPA by successfully submitting the data electronically into the EPA's Central Data Exchange by using the Electronic Reporting Tool (see <http://www.epa.gov/ttn/chief/ert/erttool.html>).

(6) For a new unit, complete the initial performance evaluation no later than July 30, 2013, or 180 days after the date of initial startup, whichever is later. For an existing unit, complete the initial performance evaluation no later than July 29, 2016.

(7) Collect PM CEMS hourly average output data for all boiler or process heater operating hours except as indicated in §63.7535(a) through (d).

(8) Calculate the arithmetic 30-day rolling average of all of the hourly average PM CEMS output data collected during all boiler or process heater operating hours.

(c) If you have an applicable opacity operating limit in this rule, and are not otherwise required or elect to install and operate a PM CPMS, PM CEMS, or a bag leak detection system, you must install, operate, certify and maintain each COMS according to the procedures in paragraphs (c)(1) through (7) of this section by the compliance date specified in §63.7495.

(1) Each COMS must be installed, operated, and maintained according to Performance Specification 1 at appendix B to part 60 of this chapter.

(2) You must conduct a performance evaluation of each COMS according to the requirements in §63.8(e) and according to Performance Specification 1 at appendix B to part 60 of this chapter.

(3) As specified in §63.8(c)(4)(i), each COMS must complete a minimum of one cycle of sampling and analyzing for each successive 10-second period and one cycle of data recording for each successive 6-minute period.

(4) The COMS data must be reduced as specified in §63.8(g)(2).

(5) You must include in your site-specific monitoring plan procedures and acceptance criteria for operating and maintaining each COMS according to the requirements in §63.8(d). At a minimum, the monitoring plan must include a daily calibration drift assessment, a quarterly performance audit, and an annual zero alignment audit of each COMS.

(6) You must operate and maintain each COMS according to the requirements in the monitoring plan and the requirements of §63.8(e). You must identify periods the COMS is out of control including any periods that the COMS fails to pass a daily calibration drift assessment, a quarterly performance audit, or an annual zero alignment audit. Any 6-minute period for which the monitoring system is out of control and data are not available for a required calculation constitutes a deviation from the monitoring requirements.

(7) You must determine and record all the 6-minute averages (and daily block averages as applicable) collected for periods during which the COMS is not out of control.

(d) If you have an operating limit that requires the use of a CMS other than a PM CPMS or COMS, you must install, operate, and maintain each CMS according to the procedures in paragraphs (d)(1) through (5) of this section by the compliance date specified in §63.7495.

(1) The CPMS must complete a minimum of one cycle of operation every 15-minutes. You must have a minimum of four successive cycles of operation, one representing each of the four 15-minute periods in an hour, to have a valid hour of data.

(2) You must operate the monitoring system as specified in §63.7535(b), and comply with the data calculation requirements specified in §63.7535(c).

(3) Any 15-minute period for which the monitoring system is out-of-control and data are not available for a required calculation constitutes a deviation from the monitoring requirements. Other situations that constitute a monitoring deviation are specified in §63.7535(d).

(4) You must determine the 30-day rolling average of all recorded readings, except as provided in §63.7535(c).

(5) You must record the results of each inspection, calibration, and validation check.

(e) If you have an operating limit that requires the use of a flow monitoring system, you must meet the requirements in paragraphs (d) and (e)(1) through (4) of this section.

(1) You must install the flow sensor and other necessary equipment in a position that provides a representative flow.

(2) You must use a flow sensor with a measurement sensitivity of no greater than 2 percent of the design flow rate.

(3) You must minimize, consistent with good engineering practices, the effects of swirling flow or abnormal velocity distributions due to upstream and downstream disturbances.

(4) You must conduct a flow monitoring system performance evaluation in accordance with your monitoring plan at the time of each performance test but no less frequently than annually.

(f) If you have an operating limit that requires the use of a pressure monitoring system, you must meet the requirements in paragraphs (d) and (f)(1) through (6) of this section.

(1) Install the pressure sensor(s) in a position that provides a representative measurement of the pressure (e.g., PM scrubber pressure drop).

(2) Minimize or eliminate pulsating pressure, vibration, and internal and external corrosion consistent with good engineering practices.

(3) Use a pressure sensor with a minimum tolerance of 1.27 centimeters of water or a minimum tolerance of 1 percent of the pressure monitoring system operating range, whichever is less.

(4) Perform checks at least once each process operating day to ensure pressure measurements are not obstructed (e.g., check for pressure tap pluggage daily).

(5) Conduct a performance evaluation of the pressure monitoring system in accordance with your monitoring plan at the time of each performance test but no less frequently than annually.

(6) If at any time the measured pressure exceeds the manufacturer's specified maximum operating pressure range, conduct a performance evaluation of the pressure monitoring system in accordance with your monitoring plan and confirm that the pressure monitoring system continues to meet the performance requirements in your monitoring plan. Alternatively, install and verify the operation of a new pressure sensor.

(g) If you have an operating limit that requires a pH monitoring system, you must meet the requirements in paragraphs (d) and (g)(1) through (4) of this section.

(1) Install the pH sensor in a position that provides a representative measurement of scrubber effluent pH.

(2) Ensure the sample is properly mixed and representative of the fluid to be measured.

(3) Conduct a performance evaluation of the pH monitoring system in accordance with your monitoring plan at least once each process operating day.

(4) Conduct a performance evaluation (including a two-point calibration with one of the two buffer solutions having a pH within 1 of the pH of the operating limit) of the pH monitoring system in accordance with your monitoring plan at the time of each performance test but no less frequently than quarterly.

(h) If you have an operating limit that requires a secondary electric power monitoring system for an electrostatic precipitator (ESP) operated with a wet scrubber, you must meet the requirements in paragraphs (h)(1) and (2) of this section.

(1) Install sensors to measure (secondary) voltage and current to the precipitator collection plates.

(2) Conduct a performance evaluation of the electric power monitoring system in accordance with your monitoring plan at the time of each performance test but no less frequently than annually.

(i) If you have an operating limit that requires the use of a monitoring system to measure sorbent injection rate (e.g., weigh belt, weigh hopper, or hopper flow measurement device), you must meet the requirements in paragraphs (d) and (i)(1) through (2) of this section.

(1) Install the system in a position(s) that provides a representative measurement of the total sorbent injection rate.

(2) Conduct a performance evaluation of the sorbent injection rate monitoring system in accordance with your monitoring plan at the time of each performance test but no less frequently than annually.

(j) If you are not required to use a PM CPMS and elect to use a fabric filter bag leak detection system to comply with the requirements of this subpart, you must install, calibrate, maintain, and continuously operate the bag leak detection system as specified in paragraphs (j)(1) through (6) of this section.

(1) You must install a bag leak detection sensor(s) in a position(s) that will be representative of the relative or absolute PM loadings for each exhaust stack, roof vent, or compartment (e.g., for a positive pressure fabric filter) of the fabric filter.

(2) Conduct a performance evaluation of the bag leak detection system in accordance with your monitoring plan and consistent with the guidance provided in EPA-454/R-98-015 (incorporated by reference, see §63.14).

(3) Use a bag leak detection system certified by the manufacturer to be capable of detecting PM emissions at concentrations of 10 milligrams per actual cubic meter or less.

(4) Use a bag leak detection system equipped with a device to record continuously the output signal from the sensor.

(5) Use a bag leak detection system equipped with a system that will alert plant operating personnel when an increase in relative PM emissions over a preset level is detected. The alert must easily recognizable (e.g., heard or seen) by plant operating personnel.

(6) Where multiple bag leak detectors are required, the system's instrumentation and alert may be shared among detectors.

(k) For each unit that meets the definition of limited-use boiler or process heater, you must keep fuel use records for the days the boiler or process heater was operating.

(l) For each unit for which you decide to demonstrate compliance with the mercury or HCl emissions limits in Tables 1 or 2 or 11 through 13 of this subpart by use of a CEMS for mercury or HCl, you must install, certify, maintain, and operate a CEMS measuring emissions discharged to the atmosphere and record the output of the system as specified in paragraphs (l)(1) through (8) of this section. For HCl, this option for an affected unit takes effect on the date a final performance specification for a HCl CEMS is published in the FEDERAL REGISTER or the date of approval of a site-specific monitoring plan.

(1) Notify the Administrator one month before starting use of the CEMS, and notify the Administrator one month before stopping use of the CEMS.

(2) Each CEMS shall be installed, certified, operated, and maintained according to the requirements in §63.7540(a)(14) for a mercury CEMS and §63.7540(a)(15) for a HCl CEMS.

(3) For a new unit, you must complete the initial performance evaluation of the CEMS by the latest of the dates specified in paragraph (l)(3)(i) through (iii) of this section.

(i) No later than July 30, 2013.

(ii) No later 180 days after the date of initial startup.

(iii) No later 180 days after notifying the Administrator before starting to use the CEMS in place of performance testing or fuel analysis to demonstrate compliance.

(4) For an existing unit, you must complete the initial performance evaluation by the latter of the two dates specified in paragraph (l)(4)(i) and (ii) of this section.

(i) No later than July 29, 2016.

(ii) No later 180 days after notifying the Administrator before starting to use the CEMS in place of performance testing or fuel analysis to demonstrate compliance.

(5) Compliance with the applicable emissions limit shall be determined based on the 30-day rolling average of the hourly arithmetic average emissions rates using the continuous monitoring system outlet data. The 30-day rolling arithmetic average emission rate (lb/MMBtu) shall be calculated using the equations in EPA Reference Method 19 at 40 CFR part 60, appendix A-7, but substituting the mercury or HCl concentration for the pollutant concentrations normally used in Method 19.

(6) Collect CEMS hourly averages for all operating hours on a 30-day rolling average basis. Collect at least four CMS data values representing the four 15-minute periods in an hour, or at least two 15-minute data values during an hour when CMS calibration, quality assurance, or maintenance activities are being performed.

(7) The one-hour arithmetic averages required shall be expressed in lb/MMBtu and shall be used to calculate the boiler 30-day and 10-day rolling average emissions.

(8) You are allowed to substitute the use of the PM, mercury or HCl CEMS for the applicable fuel analysis, annual performance test, and operating limits specified in Table 4 to this subpart to demonstrate compliance with the PM, mercury or HCl emissions limit, and if you are using an acid gas wet scrubber or dry sorbent injection control technology to comply with the HCl emission limit, you are allowed to substitute the use of a sulfur dioxide (SO₂) CEMS for the applicable fuel analysis, annual performance test, and operating limits specified in Table 4 to this subpart to demonstrate compliance with HCl emissions limit.

(m) If your unit is subject to a HCl emission limit in Tables 1, 2, or 11 through 13 of this subpart and you have an acid gas wet scrubber or dry sorbent injection control technology and you use an SO₂ CEMS, you must install the monitor at the outlet of the boiler or process heater, downstream of all emission control devices, and you must install, certify, operate, and maintain the CEMS according to part 75 of this chapter.

(1) The SO₂ CEMS must be installed by the compliance date specified in §63.7495.

(2) For on-going quality assurance (QA), the SO₂ CEMS must meet the applicable daily, quarterly, and semiannual or annual requirements in sections 2.1 through 2.3 of appendix B to part 75 of this

chapter, with the following addition: You must perform the linearity checks required in section 2.2 of appendix B to part 75 of this chapter if the SO₂ CEMS has a span value of 30 ppm or less.

(3) For a new unit, the initial performance evaluation shall be completed no later than July 30, 2013, or 180 days after the date of initial startup, whichever is later. For an existing unit, the initial performance evaluation shall be completed no later than July 29, 2016.

(4) For purposes of collecting SO₂ data, you must operate the SO₂ CEMS as specified in §63.7535(b). You must use all the data collected during all periods in calculating data averages and assessing compliance, except that you must exclude certain data as specified in §63.7535(c). Periods when SO₂ data are unavailable may constitute monitoring deviations as specified in §63.7535(d).

(5) Collect CEMS hourly averages for all operating hours on a 30-day rolling average basis.

(6) Use only unadjusted, quality-assured SO₂ concentration values in the emissions calculations; do not apply bias adjustment factors to the part 75 SO₂ data and do not use part 75 substitute data values.

[76 FR 15664, Mar. 21, 2011, as amended at 78 FR 7171, Jan. 31, 2013]

§63.7530 How do I demonstrate initial compliance with the emission limitations, fuel specifications and work practice standards?

(a) You must demonstrate initial compliance with each emission limit that applies to you by conducting initial performance tests and fuel analyses and establishing operating limits, as applicable, according to §63.7520, paragraphs (b) and (c) of this section, and Tables 5 and 7 to this subpart. The requirement to conduct a fuel analysis is not applicable for units that burn a single type of fuel, as specified by §63.7510(a)(2)(i). If applicable, you must also install, operate, and maintain all applicable CMS (including CEMS, COMS, and CPMS) according to §63.7525.

(b) If you demonstrate compliance through performance testing, you must establish each site-specific operating limit in Table 4 to this subpart that applies to you according to the requirements in §63.7520, Table 7 to this subpart, and paragraph (b)(4) of this section, as applicable. You must also conduct fuel analyses according to §63.7521 and establish maximum fuel pollutant input levels according to paragraphs (b)(1) through (3) of this section, as applicable, and as specified in §63.7510(a)(2). (Note that §63.7510(a)(2) exempts certain fuels from the fuel analysis requirements.) However, if you switch fuel(s) and cannot show that the new fuel(s) does (do) not increase the chlorine, mercury, or TSM input into the unit through the results of fuel analysis, then you must repeat the performance test to demonstrate compliance while burning the new fuel(s).

(1) You must establish the maximum chlorine fuel input (C_{input}) during the initial fuel analysis according to the procedures in paragraphs (b)(1)(i) through (iii) of this section.

(i) You must determine the fuel type or fuel mixture that you could burn in your boiler or process heater that has the highest content of chlorine.

(ii) During the fuel analysis for hydrogen chloride, you must determine the fraction of the total heat input for each fuel type burned (Q_i) based on the fuel mixture that has the highest content of chlorine, and the average chlorine concentration of each fuel type burned (C_i).

(iii) You must establish a maximum chlorine input level using Equation 7 of this section.

$$C_{input} = \sum_{i=1}^n (C_i \times Q_i) \quad (\text{Eq. 7})$$

[View or download PDF](#)

Where:

C_{in} = Maximum amount of chlorine entering the boiler or process heater through fuels burned in units of pounds per million Btu.

C_i = Arithmetic average concentration of chlorine in fuel type, i , analyzed according to §63.7521, in units of pounds per million Btu.

Q_i = Fraction of total heat input from fuel type, i , based on the fuel mixture that has the highest content of chlorine. If you do not burn multiple fuel types during the performance testing, it is not necessary to determine the value of this term. Insert a value of "1" for Q_i .

n = Number of different fuel types burned in your boiler or process heater for the mixture that has the highest content of chlorine.

(2) You must establish the maximum mercury fuel input level ($Mercury_{input}$) during the initial fuel analysis using the procedures in paragraphs (b)(2)(i) through (iii) of this section.

(i) You must determine the fuel type or fuel mixture that you could burn in your boiler or process heater that has the highest content of mercury.

(ii) During the compliance demonstration for mercury, you must determine the fraction of total heat input for each fuel burned (Q_i) based on the fuel mixture that has the highest content of mercury, and the average mercury concentration of each fuel type burned (HG_i).

(iii) You must establish a maximum mercury input level using Equation 8 of this section.

$$Mercury_{input} = \sum_{i=1}^n (HG_i \times Q_i) \quad (\text{Eq. 8})$$

[View or download PDF](#)

Where:

$Mercury_{input}$ = Maximum amount of mercury entering the boiler or process heater through fuels burned in units of pounds per million Btu.

HG_i = Arithmetic average concentration of mercury in fuel type, i , analyzed according to §63.7521, in units of pounds per million Btu.

Q_i = Fraction of total heat input from fuel type, i , based on the fuel mixture that has the highest mercury content. If you do not burn multiple fuel types during the performance test, it is not necessary to determine the value of this term. Insert a value of "1" for Q_i .

n = Number of different fuel types burned in your boiler or process heater for the mixture that has the highest content of mercury.

(3) If you opt to comply with the alternative TSM limit, you must establish the maximum TSM fuel input (TSM_{input}) for solid or liquid fuels during the initial fuel analysis according to the procedures in paragraphs (b)(3)(i) through (iii) of this section.

(i) You must determine the fuel type or fuel mixture that you could burn in your boiler or process heater that has the highest content of TSM.

(ii) During the fuel analysis for TSM, you must determine the fraction of the total heat input for each fuel type burned (Q_i) based on the fuel mixture that has the highest content of TSM, and the average TSM concentration of each fuel type burned (TSM_i).

(iii) You must establish a maximum TSM input level using Equation 9 of this section.

$$TSM_{input} = \sum_{i=1}^n (TSM_i \times Q_i) \quad (\text{Eq. 9})$$

[View or download PDF](#)

Where:

TSM_{input} = Maximum amount of TSM entering the boiler or process heater through fuels burned in units of pounds per million Btu.

TSM_i = Arithmetic average concentration of TSM in fuel type, i , analyzed according to §63.7521, in units of pounds per million Btu.

Q_i = Fraction of total heat input from fuel type, i , based on the fuel mixture that has the highest content of TSM. If you do not burn multiple fuel types during the performance testing, it is not necessary to determine the value of this term. Insert a value of "1" for Q_i .

n = Number of different fuel types burned in your boiler or process heater for the mixture that has the highest content of TSM.

(4) You must establish parameter operating limits according to paragraphs (b)(4)(i) through (ix) of this section. As indicated in Table 4 to this subpart, you are not required to establish and comply with the operating parameter limits when you are using a CEMS to monitor and demonstrate compliance with the applicable emission limit for that control device parameter.

(i) For a wet acid gas scrubber, you must establish the minimum scrubber effluent pH and liquid flow rate as defined in §63.7575, as your operating limits during the performance test during which you demonstrate compliance with your applicable limit. If you use a wet scrubber and you conduct separate performance tests for HCl and mercury emissions, you must establish one set of minimum scrubber effluent pH, liquid flow rate, and pressure drop operating limits. The minimum scrubber effluent pH operating limit must be established during the HCl performance test. If you conduct multiple performance tests, you must set the minimum liquid flow rate operating limit at the higher of the minimum values established during the performance tests.

(ii) For any particulate control device (e.g., ESP, particulate wet scrubber, fabric filter) for which you use a PM CPMS, you must establish your PM CPMS operating limit and determine compliance with it according to paragraphs (b)(4)(ii)(A) through (F) of this section.

(A) Determine your operating limit as the average PM CPMS output value recorded during the most recent performance test run demonstrating compliance with the filterable PM emission limit or at the PM CPMS output value corresponding to 75 percent of the emission limit if your PM performance test demonstrates compliance below 75 percent of the emission limit. You must verify an existing or establish a new operating limit after each repeated performance test. You must repeat the performance test annually and reassess and adjust the site-specific operating limit in accordance with the results of the performance test.

(1) Your PM CPMS must provide a 4-20 milliamp output and the establishment of its relationship to manual reference method measurements must be determined in units of milliamps.

(2) Your PM CPMS operating range must be capable of reading PM concentrations from zero to a level equivalent to at least two times your allowable emission limit. If your PM CPMS is an auto-ranging instrument capable of multiple scales, the primary range of the instrument must be capable of reading PM concentration from zero to a level equivalent to two times your allowable emission limit.

(3) During the initial performance test or any such subsequent performance test that demonstrates compliance with the PM limit, record and average all milliamp output values from the PM CPMS for the periods corresponding to the compliance test runs (e.g., average all your PM CPMS output values for three corresponding 2-hour Method 5I test runs).

(B) If the average of your three PM performance test runs are below 75 percent of your PM emission limit, you must calculate an operating limit by establishing a relationship of PM CPMS signal to PM concentration using the PM CPMS instrument zero, the average PM CPMS values corresponding to the three compliance test runs, and the average PM concentration from the Method 5 or performance test with the procedures in paragraphs (b)(4)(ii)(B)(1) through (4) of this section.

(1) Determine your instrument zero output with one of the following procedures:

(i) Zero point data for *in-situ* instruments should be obtained by removing the instrument from the stack and monitoring ambient air on a test bench.

(ii) Zero point data for *extractive* instruments should be obtained by removing the extractive probe from the stack and drawing in clean ambient air.

(iii) The zero point may also be established by performing manual reference method measurements when the flue gas is free of PM emissions or contains very low PM concentrations (e.g., when your process is not operating, but the fans are operating or your source is combusting only natural gas) and plotting these with the compliance data to find the zero intercept.

(iv) If none of the steps in paragraphs (b)(4)(ii)(B)(1)(i) through (iii) of this section are possible, you must use a zero output value provided by the manufacturer.

(2) Determine your PM CPMS instrument average in milliamps, and the average of your corresponding three PM compliance test runs, using equation 10.

$$\bar{X} = \frac{1}{n} \sum_{i=1}^n X_i, \bar{Y} = \frac{1}{n} \sum_{i=1}^n Y_i \quad (\text{Eq. 10})$$

[View or download PDF](#)

Where:

X_i = the PM CPMS data points for the three runs constituting the performance test,

Y_i = the PM concentration value for the three runs constituting the performance test, and

n = the number of data points.

(3) With your instrument zero expressed in milliamps, your three run average PM CPMS milliamp value, and your three run average PM concentration from your three compliance tests, determine a relationship of lb/MMBtu per milliamp with equation 11.

$$R = \frac{Y_i}{(X_i - z)} \quad (\text{Eq. 11})$$

[View or download PDF](#)

Where:

R = the relative lb/MMBtu per milliamp for your PM CPMS,

Y_i = the three run average lb/MMBtu PM concentration,

X_i = the three run average milliamp output from you PM CPMS, and

z = the milliamp equivalent of your instrument zero determined from (B)(i).

(4) Determine your source specific 30-day rolling average operating limit using the lb/MMBtu per milliamp value from Equation 11 in equation 12, below. This sets your operating limit at the PM CPMS output value corresponding to 75 percent of your emission limit.

$$O_t = z + \frac{0.75(L)}{R} \quad (\text{Eq. 12})$$

[View or download PDF](#)

Where:

O_t = the operating limit for your PM CPMS on a 30-day rolling average, in milliamps.

L = your source emission limit expressed in lb/MMBtu,

z = your instrument zero in milliamps, determined from (B)(i), and

R = the relative lb/MMBtu per milliamp for your PM CPMS, from Equation 11.

(C) If the average of your three PM compliance test runs is at or above 75 percent of your PM emission limit you must determine your 30-day rolling average operating limit by averaging the PM CPMS milliamp output corresponding to your three PM performance test runs that demonstrate compliance with the emission limit using equation 13 and you must submit all compliance test and PM CPMS data according to the reporting requirements in paragraph (b)(4)(ii)(F) of this section.

$$O_h = \frac{1}{n} \sum_{i=1}^n X_i \quad (\text{Eq. 13})$$

[View or download PDF](#)

Where:

X_i = the PM CPMS data points for all runs i,

n = the number of data points, and

O_h = your site specific operating limit, in milliamps.

(D) To determine continuous compliance, you must record the PM CPMS output data for all periods when the process is operating and the PM CPMS is not out-of-control. You must demonstrate continuous compliance by using all quality-assured hourly average data collected by the PM CPMS for all operating hours to calculate the arithmetic average operating parameter in units of the operating limit (milliamps) on a 30-day rolling average basis, updated at the end of each new operating hour. Use Equation 14 to determine the 30-day rolling average.

$$30\text{-day} = \frac{\sum_{i=1}^n H_{pvi}}{n} \quad (\text{Eq. 14})$$

[View or download PDF](#)

Where:

30-day = 30-day average.

H_{pvi} = is the hourly parameter value for hour i

n = is the number of valid hourly parameter values collected over the previous 720 operating hours.

(E) Use EPA Method 5 of appendix A to part 60 of this chapter to determine PM emissions. For each performance test, conduct three separate runs under the conditions that exist when the affected source is operating at the highest load or capacity level reasonably expected to occur. Conduct each test run to collect a minimum sample volume specified in Tables 1, 2, or 11 through 13 to this subpart, as applicable, for determining compliance with a new source limit or an existing source limit. Calculate the average of the results from three runs to determine compliance. You need not determine the PM collected in the impingers (“back half”) of the Method 5 particulate sampling train to demonstrate compliance with the PM standards of this subpart. This shall not preclude the permitting authority from requiring a determination of the “back half” for other purposes.

(F) For PM performance test reports used to set a PM CPMS operating limit, the electronic submission of the test report must also include the make and model of the PM CPMS instrument, serial number of the instrument, analytical principle of the instrument (e.g. beta attenuation), span of the instruments primary analytical range, milliamp value equivalent to the instrument zero output, technique by which this zero value was determined, and the average milliamp signals corresponding to each PM compliance test run. (iii) For a particulate wet scrubber, you must establish the minimum pressure drop and liquid flow rate as defined in §63.7575, as your operating limits during the three-run performance test during which you demonstrate compliance with your applicable limit. If you use a wet scrubber and you conduct separate performance tests for PM and TSM emissions, you must establish one set of minimum scrubber liquid flow rate and pressure drop operating limits. The minimum scrubber effluent pH operating limit must be established during the HCl performance test. If you conduct multiple performance tests, you must set the minimum liquid flow rate and pressure drop operating limits at the higher of the minimum values established during the performance tests.

(iii) For an electrostatic precipitator (ESP) operated with a wet scrubber, you must establish the minimum total secondary electric power input, as defined in §63.7575, as your operating limit during the three-run performance test during which you demonstrate compliance with your applicable limit. (These operating limits do not apply to ESP that are operated as dry controls without a wet scrubber.)

(iv) For a dry scrubber, you must establish the minimum sorbent injection rate for each sorbent, as defined in §63.7575, as your operating limit during the three-run performance test during which you demonstrate compliance with your applicable limit.

(v) For activated carbon injection, you must establish the minimum activated carbon injection rate, as defined in §63.7575, as your operating limit during the three-run performance test during which you demonstrate compliance with your applicable limit.

(vi) The operating limit for boilers or process heaters with fabric filters that demonstrate continuous compliance through bag leak detection systems is that a bag leak detection system be installed according to the requirements in §63.7525, and that each fabric filter must be operated such that the bag leak detection system alert is not activated more than 5 percent of the operating time during a 6-month period.

(vii) For a minimum oxygen level, if you conduct multiple performance tests, you must set the minimum oxygen level at the lower of the minimum values established during the performance tests.

(viii) The operating limit for boilers or process heaters that demonstrate continuous compliance with the HCl emission limit using a SO₂ CEMS is to install and operate the SO₂ according to the requirements in §63.7525(m) establish a maximum SO₂ emission rate equal to the highest hourly average SO₂ measurement during the most recent three-run performance test for HCl.

(c) If you elect to demonstrate compliance with an applicable emission limit through fuel analysis, you must conduct fuel analyses according to §63.7521 and follow the procedures in paragraphs (c)(1) through (5) of this section.

(1) If you burn more than one fuel type, you must determine the fuel mixture you could burn in your boiler or process heater that would result in the maximum emission rates of the pollutants that you elect to demonstrate compliance through fuel analysis.

(2) You must determine the 90th percentile confidence level fuel pollutant concentration of the composite samples analyzed for each fuel type using the one-sided t-statistic test described in Equation 15 of this section.

$$P90 = \text{mean} + (SD \times t) \quad (\text{Eq. 15})$$

[View or download PDF](#)

Where:

P90 = 90th percentile confidence level pollutant concentration, in pounds per million Btu.

Mean = Arithmetic average of the fuel pollutant concentration in the fuel samples analyzed according to §63.7521, in units of pounds per million Btu.

SD = Standard deviation of the mean of pollutant concentration in the fuel samples analyzed according to §63.7521, in units of pounds per million Btu. SD is calculated as the sample standard deviation divided by the square root of the number of samples.

t = t distribution critical value for 90th percentile ($t_{\alpha, n}$) probability for the appropriate degrees of freedom (number of samples minus one) as obtained from a t-Distribution Critical Value Table.

(3) To demonstrate compliance with the applicable emission limit for HCl, the HCl emission rate that you calculate for your boiler or process heater using Equation 16 of this section must not exceed the applicable emission limit for HCl.

$$HCl = \sum_{i=1}^n (Ci90 \times Qi \times 1.028) \quad (\text{Eq. 16})$$

[View or download PDF](#)

Where:

HCl = HCl emission rate from the boiler or process heater in units of pounds per million Btu.

Ci90 = 90th percentile confidence level concentration of chlorine in fuel type, i, in units of pounds per million Btu as calculated according to Equation 11 of this section.

Q_i = Fraction of total heat input from fuel type, i , based on the fuel mixture that has the highest content of chlorine. If you do not burn multiple fuel types, it is not necessary to determine the value of this term. Insert a value of "1" for Q_i .

n = Number of different fuel types burned in your boiler or process heater for the mixture that has the highest content of chlorine.

1.028 = Molecular weight ratio of HCl to chlorine.

(4) To demonstrate compliance with the applicable emission limit for mercury, the mercury emission rate that you calculate for your boiler or process heater using Equation 17 of this section must not exceed the applicable emission limit for mercury.

$$\text{Mercury} = \sum_{i=1}^n (H_{gi90} \times Q_i) \quad (\text{Eq. 17})$$

[View or download PDF](#)

Where:

Mercury = Mercury emission rate from the boiler or process heater in units of pounds per million Btu.

H_{gi90} = 90th percentile confidence level concentration of mercury in fuel, i , in units of pounds per million Btu as calculated according to Equation 11 of this section.

Q_i = Fraction of total heat input from fuel type, i , based on the fuel mixture that has the highest mercury content. If you do not burn multiple fuel types, it is not necessary to determine the value of this term. Insert a value of "1" for Q_i .

n = Number of different fuel types burned in your boiler or process heater for the mixture that has the highest mercury content.

(5) To demonstrate compliance with the applicable emission limit for TSM for solid or liquid fuels, the TSM emission rate that you calculate for your boiler or process heater from solid fuels using Equation 18 of this section must not exceed the applicable emission limit for TSM.

$$\text{Metals} = \sum_{i=1}^n (TSM_{90i} \times Q_i) \quad (\text{Eq. 18})$$

[View or download PDF](#)

Where:

Metals = TSM emission rate from the boiler or process heater in units of pounds per million Btu.

TSM_{i90} = 90th percentile confidence level concentration of TSM in fuel, i , in units of pounds per million Btu as calculated according to Equation 11 of this section.

Q_i = Fraction of total heat input from fuel type, i , based on the fuel mixture that has the highest TSM content. If you do not burn multiple fuel types, it is not necessary to determine the value of this term. Insert a value of "1" for Q_i .

n = Number of different fuel types burned in your boiler or process heater for the mixture that has the highest TSM content.

(d) If you own or operate an existing unit with a heat input capacity of less than 10 million Btu per hour or a unit in the unit designed to burn gas 1 subcategory, you must submit a signed statement in the Notification of Compliance Status report that indicates that you conducted a tune-up of the unit.

(e) You must include with the Notification of Compliance Status a signed certification that the energy assessment was completed according to Table 3 to this subpart and is an accurate depiction of your facility at the time of the assessment.

(f) You must submit the Notification of Compliance Status containing the results of the initial compliance demonstration according to the requirements in §63.7545(e).

(g) If you elect to demonstrate that a gaseous fuel meets the specifications of another gas 1 fuel as defined in §63.7575, you must conduct an initial fuel specification analyses according to §63.7521(f) through (i) and according to the frequency listed in §63.7540(c) and maintain records of the results of the testing as outlined in §63.7555(g). For samples where the initial mercury specification has not been exceeded, you will include a signed certification with the Notification of Compliance Status that the initial fuel specification test meets the gas specification outlined in the definition of other gas 1 fuels.

(h) If you own or operate a unit subject to emission limits in Tables 1 or 2 or 11 through 13 to this subpart, you must meet the work practice standard according to Table 3 of this subpart. During startup and shutdown, you must only follow the work practice standards according to item 5 of Table 3 of this subpart.

(i) If you opt to comply with the alternative SO₂ CEMS operating limit in Tables 4 and 8 to this subpart, you may do so only if your affected boiler or process heater:

(1) Has a system using wet scrubber or dry sorbent injection and SO₂ CEMS installed on the unit; and

(2) At all times, you operate the wet scrubber or dry sorbent injection for acid gas control on the unit consistent with §63.7500(a)(3); and

(3) You establish a unit-specific maximum SO₂ operating limit by collecting the minimum hourly SO₂ emission rate on the SO₂ CEMS during the paired 3-run test for HCl. The maximum SO₂ operating limit is equal to the highest hourly average SO₂ concentration measured during the most recent HCl performance test.

[76 FR 15664, Mar. 21, 2011, as amended at 78 FR 7174, Jan. 31, 2013]

§63.7533 Can I use efficiency credits earned from implementation of energy conservation measures to comply with this subpart?

(a) If you elect to comply with the alternative equivalent output-based emission limits, instead of the heat input-based limits listed in Table 2 to this subpart, and you want to take credit for implementing energy conservation measures identified in an energy assessment, you may demonstrate compliance using efficiency credits according to the procedures in this section. You may use this compliance approach for an existing affected boiler for demonstrating initial compliance according to §63.7522(e) and for demonstrating monthly compliance according to §63.7522(f). Owners or operators using this compliance approach must establish an emissions benchmark, calculate and document the efficiency credits, develop an Implementation Plan, comply with the general reporting requirements, and apply the efficiency credit according to the procedures in paragraphs (b) through (f) of this section. You cannot use this compliance approach for a new or reconstructed affected boiler. Additional guidance from the Department of Energy on efficiency credits is available at: <http://www.epa.gov/ttn/atw/boiler/boilerpg.html>.

(b) For each existing affected boiler for which you intend to apply emissions credits, establish a benchmark from which emission reduction credits may be generated by determining the actual annual fuel heat input to the affected boiler before initiation of an energy conservation activity to reduce energy demand (*i.e.*, fuel usage) according to paragraphs (b)(1) through (4) of this section. The benchmark shall be expressed in trillion Btu per year heat input.

(1) The benchmark from which efficiency credits may be generated shall be determined by using the most representative, accurate, and reliable process available for the source. The benchmark shall be established for a one-year period before the date that an energy demand reduction occurs, unless it can be demonstrated that a different time period is more representative of historical operations.

(2) Determine the starting point from which to measure progress. Inventory all fuel purchased and generated on-site (off-gases, residues) in physical units (MMBtu, million cubic feet, etc.).

(3) Document all uses of energy from the affected boiler. Use the most recent data available.

(4) Collect non-energy related facility and operational data to normalize, if necessary, the benchmark to current operations, such as building size, operating hours, etc. If possible, use actual data that are current and timely rather than estimated data.

(c) Efficiency credits can be generated if the energy conservation measures were implemented after January 1, 2008 and if sufficient information is available to determine the appropriate value of credits.

(1) The following emission points cannot be used to generate efficiency credits:

(i) Energy conservation measures implemented on or before January 1, 2008, unless the level of energy demand reduction is increased after January 1, 2008, in which case credit will be allowed only for change in demand reduction achieved after January 1, 2008.

(ii) Efficiency credits on shut-down boilers. Boilers that are shut down cannot be used to generate credits unless the facility provides documentation linking the permanent shutdown to energy conservation measures identified in the energy assessment. In this case, the bench established for the affected boiler to which the credits from the shutdown will be applied must be revised to include the benchmark established for the shutdown boiler.

(2) For all points included in calculating emissions credits, the owner or operator shall:

(i) Calculate annual credits for all energy demand points. Use Equation 19 to calculate credits. Energy conservation measures that meet the criteria of paragraph (c)(1) of this section shall not be included, except as specified in paragraph (c)(1)(i) of this section.

(3) Credits are generated by the difference between the benchmark that is established for each affected boiler, and the actual energy demand reductions from energy conservation measures implemented after January 1, 2008. Credits shall be calculated using Equation 19 of this section as follows:

(i) The overall equation for calculating credits is:

$$ECredits = \left(\sum_{i=1}^n EIS_{actual} \right) + EI_{baseline} \quad (\text{Eq. 19})$$

[View or download PDF](#)

Where:

ECredits = Energy Input Savings for all energy conservation measures implemented for an affected boiler, expressed as a decimal fraction of the baseline energy input.

EIS_{factual} = Energy Input Savings for each energy conservation measure, i, implemented for an affected boiler, million Btu per year.

EI_{baseline} = Energy Input baseline for the affected boiler, million Btu per year.

n = Number of energy conservation measures included in the efficiency credit for the affected boiler.

(ii) [Reserved]

(d) The owner or operator shall develop, and submit for approval upon request by the Administrator, an Implementation Plan containing all of the information required in this paragraph for all boilers to be included in an efficiency credit approach. The Implementation Plan shall identify all existing affected boilers to be included in applying the efficiency credits. The Implementation Plan shall include a description of the energy conservation measures implemented and the energy savings generated from each measure and an explanation of the criteria used for determining that savings. If requested, you must submit the implementation plan for efficiency credits to the Administrator for review and approval no later than 180 days before the date on which the facility intends to demonstrate compliance using the efficiency credit approach.

(e) The emissions rate as calculated using Equation 20 of this section from each existing boiler participating in the efficiency credit option must be in compliance with the limits in Table 2 to this subpart at all times the affected unit is operating, following the compliance date specified in §63.7495.

(f) You must use Equation 20 of this section to demonstrate initial compliance by demonstrating that the emissions from the affected boiler participating in the efficiency credit compliance approach do not exceed the emission limits in Table 2 to this subpart.

$$E_{adj} = E_m \times (1 - ECredits) \quad (\text{Eq. 20})$$

[View or download PDF](#)

Where:

E_{adj} = Emission level adjusted by applying the efficiency credits earned, lb per million Btu steam output (or lb per MWh) for the affected boiler.

E_m = Emissions measured during the performance test, lb per million Btu steam output (or lb per MWh) for the affected boiler.

ECredits = Efficiency credits from Equation 19 for the affected boiler.

(g) As part of each compliance report submitted as required under §63.7550, you must include documentation that the energy conservation measures implemented continue to generate the credit for use in demonstrating compliance with the emission limits.

[76 FR 15664, Mar. 21, 2011, as amended at 78 FR 7178, Jan. 31, 2013]

 [Back to Top](#)

CONTINUOUS COMPLIANCE REQUIREMENTS

§63.7535 Is there a minimum amount of monitoring data I must obtain?

(a) You must monitor and collect data according to this section and the site-specific monitoring plan required by §63.7505(d).

(b) You must operate the monitoring system and collect data at all required intervals at all times that each boiler or process heater is operating and compliance is required, except for periods of monitoring system malfunctions or out of control periods (see §63.8(c)(7) of this part), and required monitoring system quality assurance or control activities, including, as applicable, calibration checks, required zero and span adjustments, and scheduled CMS maintenance as defined in your site-specific monitoring plan. A monitoring system malfunction is any sudden, infrequent, not reasonably preventable failure of the monitoring system to provide valid data. Monitoring system failures that are caused in part by poor maintenance or careless operation are not malfunctions. You are required to complete monitoring system repairs in response to monitoring system malfunctions or out-of-control periods and to return the monitoring system to operation as expeditiously as practicable.

(c) You may not use data recorded during monitoring system malfunctions or out-of-control periods, repairs associated with monitoring system malfunctions or out-of-control periods, or required monitoring system quality assurance or control activities in data averages and calculations used to report emissions or operating levels. You must record and make available upon request results of CMS performance audits and dates and duration of periods when the CMS is out of control to completion of the corrective actions necessary to return the CMS to operation consistent with your site-specific monitoring plan. You must use all the data collected during all other periods in assessing compliance and the operation of the control device and associated control system.

(d) Except for periods of monitoring system malfunctions, repairs associated with monitoring system malfunctions, and required monitoring system quality assurance or quality control activities (including, as applicable, system accuracy audits, calibration checks, and required zero and span adjustments), failure to collect required data is a deviation of the monitoring requirements. In calculating monitoring results, do not use any data collected during periods when the monitoring system is out of control as specified in your site-specific monitoring plan, while conducting repairs associated with periods when the monitoring system is out of control, or while conducting required monitoring system quality assurance or quality control activities. You must calculate monitoring results using all other monitoring data collected while the process is operating. You must report all periods when the monitoring system is out of control in your annual report.

[76 FR 15664, Mar. 21, 2011, as amended at 78 FR 7179, Jan. 31, 2013]

§63.7540 How do I demonstrate continuous compliance with the emission limitations, fuel specifications and work practice standards?

(a) You must demonstrate continuous compliance with each emission limit in Tables 1 and 2 or 11 through 13 to this subpart, the work practice standards in Table 3 to this subpart, and the operating limits in Table 4 to this subpart that applies to you according to the methods specified in Table 8 to this subpart and paragraphs (a)(1) through (19) of this section.

(1) Following the date on which the initial compliance demonstration is completed or is required to be completed under §§63.7 and 63.7510, whichever date comes first, operation above the established maximum or below the established minimum operating limits shall constitute a deviation of established operating limits listed in Table 4 of this subpart except during performance tests conducted to determine compliance with the emission limits or to establish new operating limits. Operating limits must be confirmed or reestablished during performance tests.

(2) As specified in §63.7550(c), you must keep records of the type and amount of all fuels burned in each boiler or process heater during the reporting period to demonstrate that all fuel types and mixtures of fuels burned would result in either of the following:

(i) Lower emissions of HCl, mercury, and TSM than the applicable emission limit for each pollutant, if you demonstrate compliance through fuel analysis.

(ii) Lower fuel input of chlorine, mercury, and TSM than the maximum values calculated during the last performance test, if you demonstrate compliance through performance testing.

(3) If you demonstrate compliance with an applicable HCl emission limit through fuel analysis for a solid or liquid fuel and you plan to burn a new type of solid or liquid fuel, you must recalculate the HCl emission rate using Equation 12 of §63.7530 according to paragraphs (a)(3)(i) through (iii) of this section. You are not required to conduct fuel analyses for the fuels described in §63.7510(a)(2)(i) through (iii). You may exclude the fuels described in §63.7510(a)(2)(i) through (iii) when recalculating the HCl emission rate.

(i) You must determine the chlorine concentration for any new fuel type in units of pounds per million Btu, based on supplier data or your own fuel analysis, according to the provisions in your site-specific fuel analysis plan developed according to §63.7521(b).

(ii) You must determine the new mixture of fuels that will have the highest content of chlorine.

(iii) Recalculate the HCl emission rate from your boiler or process heater under these new conditions using Equation 12 of §63.7530. The recalculated HCl emission rate must be less than the applicable emission limit.

(4) If you demonstrate compliance with an applicable HCl emission limit through performance testing and you plan to burn a new type of fuel or a new mixture of fuels, you must recalculate the maximum chlorine input using Equation 7 of §63.7530. If the results of recalculating the maximum chlorine input using Equation 7 of §63.7530 are greater than the maximum chlorine input level established during the previous performance test, then you must conduct a new performance test within 60 days of burning the new fuel type or fuel mixture according to the procedures in §63.7520 to demonstrate that the HCl emissions do not exceed the emission limit. You must also establish new operating limits based on this performance test according to the procedures in §63.7530(b). In recalculating the maximum chlorine input and establishing the new operating limits, you are not required to conduct fuel analyses for and include the fuels described in §63.7510(a)(2)(i) through (iii).

(5) If you demonstrate compliance with an applicable mercury emission limit through fuel analysis, and you plan to burn a new type of fuel, you must recalculate the mercury emission rate using Equation 13 of §63.7530 according to the procedures specified in paragraphs (a)(5)(i) through (iii) of this section. You are not required to conduct fuel analyses for the fuels described in §63.7510(a)(2)(i) through (iii). You may exclude the fuels described in §63.7510(a)(2)(i) through (iii) when recalculating the mercury emission rate.

(i) You must determine the mercury concentration for any new fuel type in units of pounds per million Btu, based on supplier data or your own fuel analysis, according to the provisions in your site-specific fuel analysis plan developed according to §63.7521(b).

(ii) You must determine the new mixture of fuels that will have the highest content of mercury.

(iii) Recalculate the mercury emission rate from your boiler or process heater under these new conditions using Equation 13 of §63.7530. The recalculated mercury emission rate must be less than the applicable emission limit.

(6) If you demonstrate compliance with an applicable mercury emission limit through performance testing, and you plan to burn a new type of fuel or a new mixture of fuels, you must recalculate the maximum mercury input using Equation 8 of §63.7530. If the results of recalculating the maximum mercury input using Equation 8 of §63.7530 are higher than the maximum mercury input level established during the previous performance test, then you must conduct a new performance test within 60 days of burning the new fuel type or fuel mixture according to the procedures in §63.7520 to demonstrate that the mercury emissions do not exceed the emission limit. You must also establish new operating limits based on this performance test according to the procedures in §63.7530(b). You are not required to conduct fuel analyses for the fuels described in §63.7510(a)(2)(i) through (iii). You may exclude the fuels described in §63.7510(a)(2)(i) through (iii) when recalculating the mercury emission rate.

(7) If your unit is controlled with a fabric filter, and you demonstrate continuous compliance using a bag leak detection system, you must initiate corrective action within 1 hour of a bag leak detection system alert and complete corrective actions as soon as practical, and operate and maintain the fabric filter system such that the periods which would cause an alert are no more than 5 percent of the operating time during a 6-month period. You must also keep records of the date, time, and duration of each alert, the time corrective action was initiated and completed, and a brief description of the cause of the alert and the corrective action taken. You must also record the percent of the operating time during each 6-month period that the conditions exist for an alert. In calculating this operating time percentage, if inspection of the fabric filter demonstrates that no corrective action is required, no alert time is counted. If corrective action is required, each alert shall be counted as a minimum of 1 hour. If you take longer than 1 hour to initiate corrective action, the alert time shall be counted as the actual amount of time taken to initiate corrective action.

(8) To demonstrate compliance with the applicable alternative CO CEMS emission limit listed in Tables 1, 2, or 11 through 13 to this subpart, you must meet the requirements in paragraphs (a)(8)(i) through (iv) of this section.

(i) Continuously monitor CO according to §§63.7525(a) and 63.7535.

(ii) Maintain a CO emission level below or at your applicable alternative CO CEMS-based standard in Tables 1 or 2 or 11 through 13 to this subpart at all times the affected unit is operating.

(iii) Keep records of CO levels according to §63.7555(b).

(iv) You must record and make available upon request results of CO CEMS performance audits, dates and duration of periods when the CO CEMS is out of control to completion of the corrective actions necessary to return the CO CEMS to operation consistent with your site-specific monitoring plan.

(9) The owner or operator of a boiler or process heater using a PM CPMS or a PM CEMS to meet requirements of this subpart shall install, certify, operate, and maintain the PM CPMS or PM CEMS in accordance with your site-specific monitoring plan as required in §63.7505(d).

(10) If your boiler or process heater has a heat input capacity of 10 million Btu per hour or greater, you must conduct an annual tune-up of the boiler or process heater to demonstrate continuous compliance as specified in paragraphs (a)(10)(i) through (vi) of this section. This frequency does not apply to limited-use boilers and process heaters, as defined in §63.7575, or units with continuous oxygen trim systems that maintain an optimum air to fuel ratio.

(i) As applicable, inspect the burner, and clean or replace any components of the burner as necessary (you may delay the burner inspection until the next scheduled unit shutdown). Units that produce electricity for sale may delay the burner inspection until the first outage, not to exceed 36 months from the previous inspection. At units where entry into a piece of process equipment or into a storage vessel is required to complete the tune-up inspections, inspections are required only during planned entries into the storage vessel or process equipment;

(ii) Inspect the flame pattern, as applicable, and adjust the burner as necessary to optimize the flame pattern. The adjustment should be consistent with the manufacturer's specifications, if available;

(iii) Inspect the system controlling the air-to-fuel ratio, as applicable, and ensure that it is correctly calibrated and functioning properly (you may delay the inspection until the next scheduled unit shutdown). Units that produce electricity for sale may delay the inspection until the first outage, not to exceed 36 months from the previous inspection;

(iv) Optimize total emissions of CO. This optimization should be consistent with the manufacturer's specifications, if available, and with any NO_x requirement to which the unit is subject;

(v) Measure the concentrations in the effluent stream of CO in parts per million, by volume, and oxygen in volume percent, before and after the adjustments are made (measurements may be either on a dry or wet basis, as long as it is the same basis before and after the adjustments are made). Measurements may be taken using a portable CO analyzer; and

(vi) Maintain on-site and submit, if requested by the Administrator, an annual report containing the information in paragraphs (a)(10)(vi)(A) through (C) of this section,

(A) The concentrations of CO in the effluent stream in parts per million by volume, and oxygen in volume percent, measured at high fire or typical operating load, before and after the tune-up of the boiler or process heater;

(B) A description of any corrective actions taken as a part of the tune-up; and

(C) The type and amount of fuel used over the 12 months prior to the tune-up, but only if the unit was physically and legally capable of using more than one type of fuel during that period. Units sharing a fuel meter may estimate the fuel used by each unit.

(11) If your boiler or process heater has a heat input capacity of less than 10 million Btu per hour (except as specified in paragraph (a)(12) of this section), you must conduct a biennial tune-up of the boiler or process heater as specified in paragraphs (a)(10)(i) through (vi) of this section to demonstrate continuous compliance.

(12) If your boiler or process heater has a continuous oxygen trim system that maintains an optimum air to fuel ratio, or a heat input capacity of less than or equal to 5 million Btu per hour and the unit is in the units designed to burn gas 1; units designed to burn gas 2 (other); or units designed to burn light liquid subcategories, or meets the definition of limited-use boiler or process heater in §63.7575, you must conduct a tune-up of the boiler or process heater every 5 years as specified in paragraphs (a)(10)(i) through (vi) of this section to demonstrate continuous compliance. You may delay the burner inspection specified in paragraph (a)(10)(i) of this section until the next scheduled or unscheduled unit shutdown, but you must inspect each burner at least once every 72 months.

(13) If the unit is not operating on the required date for a tune-up, the tune-up must be conducted within 30 calendar days of startup.

(14) If you are using a CEMS measuring mercury emissions to meet requirements of this subpart you must install, certify, operate, and maintain the mercury CEMS as specified in paragraphs (a)(14)(i) and (ii) of this section.

(i) Operate the mercury CEMS in accordance with performance specification 12A of 40 CFR part 60, appendix B or operate a sorbent trap based integrated monitor in accordance with performance specification 12B of 40 CFR part 60, appendix B. The duration of the performance test must be the maximum of 30 unit operating days or 720 hours. For each day in which the unit operates, you must obtain hourly mercury concentration data, and stack gas volumetric flow rate data.

(ii) If you are using a mercury CEMS, you must install, operate, calibrate, and maintain an instrument for continuously measuring and recording the mercury mass emissions rate to the atmosphere according to the requirements of performance specifications 6 and 12A of 40 CFR part 60, appendix B, and quality assurance procedure 6 of 40 CFR part 60, appendix F.

(15) If you are using a CEMS to measure HCl emissions to meet requirements of this subpart, you must install, certify, operate, and maintain the HCl CEMS as specified in paragraphs (a)(15)(i) and (ii) of this section. This option for an affected unit takes effect on the date a final performance specification for an HCl CEMS is published in the FEDERAL REGISTER or the date of approval of a site-specific monitoring plan.

(i) Operate the continuous emissions monitoring system in accordance with the applicable performance specification in 40 CFR part 60, appendix B. The duration of the performance test must be the maximum of 30 unit operating days or 720 hours. For each day in which the unit operates, you must obtain hourly HCl concentration data, and stack gas volumetric flow rate data.

(ii) If you are using a HCl CEMS, you must install, operate, calibrate, and maintain an instrument for continuously measuring and recording the HCl mass emissions rate to the atmosphere according to the requirements of the applicable performance specification of 40 CFR part 60, appendix B, and the quality assurance procedures of 40 CFR part 60, appendix F.

(16) If you demonstrate compliance with an applicable TSM emission limit through performance testing, and you plan to burn a new type of fuel or a new mixture of fuels, you must recalculate the maximum TSM input using Equation 9 of §63.7530. If the results of recalculating the maximum TSM input using Equation 9 of §63.7530 are higher than the maximum total selected input level established during the previous performance test, then you must conduct a new performance test within 60 days of burning the new fuel type or fuel mixture according to the procedures in §63.7520 to demonstrate that the TSM emissions do not exceed the emission limit. You must also establish new operating limits based on this performance test according to the procedures in §63.7530(b). You are not required to conduct fuel analyses for the fuels described in §63.7510(a)(2)(i) through (iii). You may exclude the fuels described in §63.7510(a)(2)(i) through (iii) when recalculating the TSM emission rate.

(17) If you demonstrate compliance with an applicable TSM emission limit through fuel analysis for solid or liquid fuels, and you plan to burn a new type of fuel, you must recalculate the TSM emission rate using Equation 14 of §63.7530 according to the procedures specified in paragraphs (a)(5)(i) through (iii) of this section. You are not required to conduct fuel analyses for the fuels described in §63.7510(a)(2)(i) through (iii). You may exclude the fuels described in §63.7510(a)(2)(i) through (iii) when recalculating the TSM emission rate.

(i) You must determine the TSM concentration for any new fuel type in units of pounds per million Btu, based on supplier data or your own fuel analysis, according to the provisions in your site-specific fuel analysis plan developed according to §63.7521(b).

(ii) You must determine the new mixture of fuels that will have the highest content of TSM.

(iii) Recalculate the TSM emission rate from your boiler or process heater under these new conditions using Equation 14 of §63.7530. The recalculated TSM emission rate must be less than the applicable emission limit.

(18) If you demonstrate continuous PM emissions compliance with a PM CPMS you will use a PM CPMS to establish a site-specific operating limit corresponding to the results of the performance test demonstrating compliance with the PM limit. You will conduct your performance test using the test method criteria in Table 5 of this subpart. You will use the PM CPMS to demonstrate continuous compliance with this operating limit. You must repeat the performance test annually and reassess and adjust the site-specific operating limit in accordance with the results of the performance test.

(i) To determine continuous compliance, you must record the PM CPMS output data for all periods when the process is operating and the PM CPMS is not out-of-control. You must demonstrate continuous compliance by using all quality-assured hourly average data collected by the PM CPMS for all operating hours to calculate the arithmetic average operating parameter in units of the operating limit (milliamps) on a 30-day rolling average basis, updated at the end of each new boiler or process heater operating hour.

(ii) For any deviation of the 30-day rolling PM CPMS average value from the established operating parameter limit, you must:

(A) Within 48 hours of the deviation, visually inspect the air pollution control device (APCD);

(B) If inspection of the APCD identifies the cause of the deviation, take corrective action as soon as possible and return the PM CPMS measurement to within the established value; and

(C) Within 30 days of the deviation or at the time of the annual compliance test, whichever comes first, conduct a PM emissions compliance test to determine compliance with the PM emissions limit and to verify or re-establish the CPMS operating limit. You are not required to conduct additional testing for any deviations that occur between the time of the original deviation and the PM emissions compliance test required under this paragraph.

(iii) PM CPMS deviations from the operating limit leading to more than four required performance tests in a 12-month operating period constitute a separate violation of this subpart.

(19) If you choose to comply with the PM filterable emissions limit by using PM CEMS you must install, certify, operate, and maintain a PM CEMS and record the output of the PM CEMS as specified in paragraphs (a)(19)(i) through (vii) of this section. The compliance limit will be expressed as a 30-day rolling average of the numerical emissions limit value applicable for your unit in Tables 1 or 2 or 11 through 13 of this subpart.

(i) Install and certify your PM CEMS according to the procedures and requirements in Performance Specification 11—Specifications and Test Procedures for Particulate Matter Continuous Emission Monitoring Systems at Stationary Sources in Appendix B to part 60 of this chapter, using test criteria outlined in Table V of this rule. The reportable measurement output from the PM CEMS must be expressed in units of the applicable emissions limit (e.g., lb/MMBtu, lb/MWh).

(ii) Operate and maintain your PM CEMS according to the procedures and requirements in Procedure 2—Quality Assurance Requirements for Particulate Matter Continuous Emission Monitoring Systems at Stationary Sources in Appendix F to part 60 of this chapter.

(A) You must conduct the relative response audit (RRA) for your PM CEMS at least once annually.

(B) You must conduct the relative correlation audit (RCA) for your PM CEMS at least once every 3 years.

(iii) Collect PM CEMS hourly average output data for all boiler operating hours except as indicated in paragraph (i) of this section.

(iv) Calculate the arithmetic 30-day rolling average of all of the hourly average PM CEMS output data collected during all nonexempt boiler or process heater operating hours.

(v) You must collect data using the PM CEMS at all times the unit is operating and at the intervals specified this paragraph (a), except for periods of monitoring system malfunctions, repairs associated with monitoring system malfunctions, and required monitoring system quality assurance or quality control activities.

(vi) You must use all the data collected during all boiler or process heater operating hours in assessing the compliance with your operating limit except:

(A) Any data collected during monitoring system malfunctions, repairs associated with monitoring system malfunctions, or required monitoring system quality assurance or control activities conducted during monitoring system malfunctions in calculations and report any such periods in your annual deviation report;

(B) Any data collected during periods when the monitoring system is out of control as specified in your site-specific monitoring plan, repairs associated with periods when the monitoring system is out of control, or required monitoring system quality assurance or control activities conducted during out of control periods in calculations used to report emissions or operating levels and report any such periods in your annual deviation report;

(C) Any data recorded during periods of startup or shutdown.

(vii) You must record and make available upon request results of PM CEMS system performance audits, dates and duration of periods when the PM CEMS is out of control to completion of the corrective actions necessary to return the PM CEMS to operation consistent with your site-specific monitoring plan.

(b) You must report each instance in which you did not meet each emission limit and operating limit in Tables 1 through 4 or 11 through 13 to this subpart that apply to you. These instances are deviations from the emission limits or operating limits, respectively, in this subpart. These deviations must be reported according to the requirements in §63.7550.

(c) If you elected to demonstrate that the unit meets the specification for mercury for the unit designed to burn gas 1 subcategory, you must follow the sampling frequency specified in paragraphs (c)(1) through (4) of this section and conduct this sampling according to the procedures in §63.7521(f) through (i).

(1) If the initial mercury constituents in the gaseous fuels are measured to be equal to or less than half of the mercury specification as defined in §63.7575, you do not need to conduct further sampling.

(2) If the initial mercury constituents are greater than half but equal to or less than 75 percent of the mercury specification as defined in §63.7575, you will conduct semi-annual sampling. If 6 consecutive semi-annual fuel analyses demonstrate 50 percent or less of the mercury specification, you do not need to conduct further sampling. If any semi-annual sample exceeds 75 percent of the mercury specification, you must return to monthly sampling for that fuel, until 12 months of fuel analyses again are less than 75 percent of the compliance level.

(3) If the initial mercury constituents are greater than 75 percent of the mercury specification as defined in §63.7575, you will conduct monthly sampling. If 12 consecutive monthly fuel analyses demonstrate 75 percent or less of the mercury specification, you may decrease the fuel analysis frequency to semi-annual for that fuel.

(4) If the initial sample exceeds the mercury specification as defined in §63.7575, each affected boiler or process heater combusting this fuel is not part of the unit designed to burn gas 1 subcategory and must be in compliance with the emission and operating limits for the appropriate subcategory. You may elect to conduct additional monthly sampling while complying with these emissions and operating limits to demonstrate that the fuel qualifies as another gas 1 fuel. If 12 consecutive monthly fuel analyses samples are at or below the mercury specification as defined in §63.7575, each affected boiler or process heater combusting the fuel can elect to switch back into the unit designed to burn gas 1 subcategory until the mercury specification is exceeded.

(d) For startup and shutdown, you must meet the work practice standards according to item 5 of Table 3 of this subpart.

[78 FR 7179, Jan. 31, 2013]

§63.7541 How do I demonstrate continuous compliance under the emissions averaging provision?

(a) Following the compliance date, the owner or operator must demonstrate compliance with this subpart on a continuous basis by meeting the requirements of paragraphs (a)(1) through (5) of this section.

(1) For each calendar month, demonstrate compliance with the average weighted emissions limit for the existing units participating in the emissions averaging option as determined in §63.7522(f) and (g).

(2) You must maintain the applicable opacity limit according to paragraphs (a)(2)(i) and (ii) of this section.

(i) For each existing unit participating in the emissions averaging option that is equipped with a dry control system and not vented to a common stack, maintain opacity at or below the applicable limit.

(ii) For each group of units participating in the emissions averaging option where each unit in the group is equipped with a dry control system and vented to a common stack that does not receive emissions from non-affected units, maintain opacity at or below the applicable limit at the common stack.

(3) For each existing unit participating in the emissions averaging option that is equipped with a wet scrubber, maintain the 30-day rolling average parameter values at or above the operating limits established during the most recent performance test.

(4) For each existing unit participating in the emissions averaging option that has an approved alternative operating parameter, maintain the 30-day rolling average parameter values consistent with the approved monitoring plan.

(5) For each existing unit participating in the emissions averaging option venting to a common stack configuration containing affected units from other subcategories, maintain the appropriate operating limit for each unit as specified in Table 4 to this subpart that applies.

(b) Any instance where the owner or operator fails to comply with the continuous monitoring requirements in paragraphs (a)(1) through (5) of this section is a deviation.

[↑ Back to Top](#)

NOTIFICATION, REPORTS, AND RECORDS

§63.7545 What notifications must I submit and when?

(a) You must submit to the Administrator all of the notifications in §§63.7(b) and (c), 63.8(e), (f)(4) and (6), and 63.9(b) through (h) that apply to you by the dates specified.

(b) As specified in §63.9(b)(2), if you startup your affected source before January 31, 2013, you must submit an Initial Notification not later than 120 days after January 31, 2013.

(c) As specified in §63.9(b)(4) and (5), if you startup your new or reconstructed affected source on or after January 31, 2013, you must submit an Initial Notification not later than 15 days after the actual date of startup of the affected source.

(d) If you are required to conduct a performance test you must submit a Notification of Intent to conduct a performance test at least 60 days before the performance test is scheduled to begin.

(e) If you are required to conduct an initial compliance demonstration as specified in §63.7530, you must submit a Notification of Compliance Status according to §63.9(h)(2)(ii). For the initial compliance demonstration for each boiler or process heater, you must submit the Notification of Compliance Status, including all performance test results and fuel analyses, before the close of business on the 60th day following the completion of all performance test and/or other initial compliance demonstrations for all boiler or process heaters at the facility according to §63.10(d)(2). The Notification of Compliance Status report must contain all the information specified in paragraphs (e)(1) through (8), as applicable. If you are not required to conduct an initial compliance demonstration as specified in §63.7530(a), the Notification of Compliance Status must only contain the information specified in paragraphs (e)(1) and (8).

(1) A description of the affected unit(s) including identification of which subcategories the unit is in, the design heat input capacity of the unit, a description of the add-on controls used on the unit to comply with this subpart, description of the fuel(s) burned, including whether the fuel(s) were a secondary material determined by you or the EPA through a petition process to be a non-waste under §241.3 of this chapter, whether the fuel(s) were a secondary material processed from discarded non-hazardous secondary materials within the meaning of §241.3 of this chapter, and justification for the selection of fuel(s) burned during the compliance demonstration.

(2) Summary of the results of all performance tests and fuel analyses, and calculations conducted to demonstrate initial compliance including all established operating limits, and including:

(i) Identification of whether you are complying with the PM emission limit or the alternative TSM emission limit.

(ii) Identification of whether you are complying with the output-based emission limits or the heat input-based (i.e., lb/MMBtu or ppm) emission limits,

(3) A summary of the maximum CO emission levels recorded during the performance test to show that you have met any applicable emission standard in Tables 1, 2, or 11 through 13 to this subpart, if you are not using a CO CEMS to demonstrate compliance.

(4) Identification of whether you plan to demonstrate compliance with each applicable emission limit through performance testing, a CEMS, or fuel analysis.

(5) Identification of whether you plan to demonstrate compliance by emissions averaging and identification of whether you plan to demonstrate compliance by using efficiency credits through energy conservation:

(i) If you plan to demonstrate compliance by emission averaging, report the emission level that was being achieved or the control technology employed on January 31, 2013.

(ii) [Reserved]

(6) A signed certification that you have met all applicable emission limits and work practice standards.

(7) If you had a deviation from any emission limit, work practice standard, or operating limit, you must also submit a description of the deviation, the duration of the deviation, and the corrective action taken in the Notification of Compliance Status report.

(8) In addition to the information required in §63.9(h)(2), your notification of compliance status must include the following certification(s) of compliance, as applicable, and signed by a responsible official:

(i) "This facility complies with the required initial tune-up according to the procedures in §63.7540(a)(10)(i) through (vi)."

(ii) "This facility has had an energy assessment performed according to §63.7530(e)."

(iii) Except for units that burn only natural gas, refinery gas, or other gas 1 fuel, or units that qualify for a statutory exemption as provided in section 129(g)(1) of the Clean Air Act, include the following: "No secondary materials that are solid waste were combusted in any affected unit."

(f) If you operate a unit designed to burn natural gas, refinery gas, or other gas 1 fuels that is subject to this subpart, and you intend to use a fuel other than natural gas, refinery gas, gaseous fuel subject to another subpart of this part, part 60, 61, or 65, or other gas 1 fuel to fire the affected unit during a period of natural gas curtailment or supply interruption, as defined in §63.7575, you must submit a notification of alternative fuel use within 48 hours of the declaration of each period of natural gas curtailment or supply interruption, as defined in §63.7575. The notification must include the information specified in paragraphs (f)(1) through (5) of this section.

(1) Company name and address.

(2) Identification of the affected unit.

(3) Reason you are unable to use natural gas or equivalent fuel, including the date when the natural gas curtailment was declared or the natural gas supply interruption began.

(4) Type of alternative fuel that you intend to use.

(5) Dates when the alternative fuel use is expected to begin and end.

(g) If you intend to commence or recommence combustion of solid waste, you must provide 30 days prior notice of the date upon which you will commence or recommence combustion of solid waste. The notification must identify:

(1) The name of the owner or operator of the affected source, as defined in §63.7490, the location of the source, the boiler(s) or process heater(s) that will commence burning solid waste, and the date of the notice.

(2) The currently applicable subcategories under this subpart.

(3) The date on which you became subject to the currently applicable emission limits.

(4) The date upon which you will commence combusting solid waste.

(h) If you have switched fuels or made a physical change to the boiler and the fuel switch or physical change resulted in the applicability of a different subcategory, you must provide notice of the date upon which you switched fuels or made the physical change within 30 days of the switch/change. The notification must identify:

(1) The name of the owner or operator of the affected source, as defined in §63.7490, the location of the source, the boiler(s) and process heater(s) that have switched fuels, were physically changed, and the date of the notice.

(2) The currently applicable subcategory under this subpart.

(3) The date upon which the fuel switch or physical change occurred.

[76 FR 15664, Mar. 21, 2011, as amended at 78 FR 7183, Jan. 31, 2013]

§63.7550 What reports must I submit and when?

(a) You must submit each report in Table 9 to this subpart that applies to you.

(b) Unless the EPA Administrator has approved a different schedule for submission of reports under §63.10(a), you must submit each report, according to paragraph (h) of this section, by the date in Table 9 to this subpart and according to the requirements in paragraphs (b)(1) through (4) of this section. For units that are subject only to a requirement to conduct an annual, biennial, or 5-year tune-up according to §63.7540(a)(10), (11), or (12), respectively, and not subject to emission limits or operating limits, you may submit only an annual, biennial, or 5-year compliance report, as applicable, as specified in paragraphs (b)(1) through (4) of this section, instead of a semi-annual compliance report.

(1) The first compliance report must cover the period beginning on the compliance date that is specified for each boiler or process heater in §63.7495 and ending on July 31 or January 31, whichever date is the first date that occurs at least 180 days (or 1, 2, or 5 years, as applicable, if submitting an annual, biennial, or 5-year compliance report) after the compliance date that is specified for your source in §63.7495.

(2) The first compliance report must be postmarked or submitted no later than July 31 or January 31, whichever date is the first date following the end of the first calendar half after the compliance date that is specified for each boiler or process heater in §63.7495. The first annual, biennial, or 5-year compliance report must be postmarked or submitted no later than January 31.

(3) Each subsequent compliance report must cover the semiannual reporting period from January 1 through June 30 or the semiannual reporting period from July 1 through December 31. Annual, biennial, and 5-year compliance reports must cover the applicable 1-, 2-, or 5-year periods from January 1 to December 31.

(4) Each subsequent compliance report must be postmarked or submitted no later than July 31 or January 31, whichever date is the first date following the end of the semiannual reporting period. Annual, biennial, and 5-year compliance reports must be postmarked or submitted no later than January 31.

(c) A compliance report must contain the following information depending on how the facility chooses to comply with the limits set in this rule.

(1) If the facility is subject to a tune up they must submit a compliance report with the information in paragraphs (c)(5)(i) through (iv) and (xiv) of this section.

(2) If a facility is complying with the fuel analysis they must submit a compliance report with the information in paragraphs (c)(5)(i) through (iv), (vi), (x), (xi), (xiii), (xv) and paragraph (d) of this section.

(3) If a facility is complying with the applicable emissions limit with performance testing they must submit a compliance report with the information in (c)(5)(i) through (iv), (vi), (vii), (ix), (xi), (xiii), (xv) and paragraph (d) of this section.

(4) If a facility is complying with an emissions limit using a CMS the compliance report must contain the information required in paragraphs (c)(5)(i) through (vi), (xi), (xiii), (xv) through (xvii), and paragraph (e) of this section.

(5)(i) Company and Facility name and address.

(ii) Process unit information, emissions limitations, and operating parameter limitations.

(iii) Date of report and beginning and ending dates of the reporting period.

(iv) The total operating time during the reporting period.

(v) If you use a CMS, including CEMS, COMS, or CPMS, you must include the monitoring equipment manufacturer(s) and model numbers and the date of the last CMS certification or audit.

(vi) The total fuel use by each individual boiler or process heater subject to an emission limit within the reporting period, including, but not limited to, a description of the fuel, whether the fuel has received a non-waste determination by the EPA or your basis for concluding that the fuel is not a waste, and the total fuel usage amount with units of measure.

(vii) If you are conducting performance tests once every 3 years consistent with §63.7515(b) or (c), the date of the last 2 performance tests and a statement as to whether there have been any operational changes since the last performance test that could increase emissions.

(viii) A statement indicating that you burned no new types of fuel in an individual boiler or process heater subject to an emission limit. Or, if you did burn a new type of fuel and are subject to a HCl emission limit, you must submit the calculation of chlorine input, using Equation 7 of §63.7530, that demonstrates that your source is still within its maximum chlorine input level established during the previous performance testing (for sources that demonstrate compliance through performance testing) or you must submit the calculation of HCl emission rate using Equation 12 of §63.7530 that demonstrates that your source is still meeting the emission limit for HCl emissions (for boilers or process heaters that

demonstrate compliance through fuel analysis). If you burned a new type of fuel and are subject to a mercury emission limit, you must submit the calculation of mercury input, using Equation 8 of §63.7530, that demonstrates that your source is still within its maximum mercury input level established during the previous performance testing (for sources that demonstrate compliance through performance testing), or you must submit the calculation of mercury emission rate using Equation 13 of §63.7530 that demonstrates that your source is still meeting the emission limit for mercury emissions (for boilers or process heaters that demonstrate compliance through fuel analysis). If you burned a new type of fuel and are subject to a TSM emission limit, you must submit the calculation of TSM input, using Equation 9 of §63.7530, that demonstrates that your source is still within its maximum TSM input level established during the previous performance testing (for sources that demonstrate compliance through performance testing), or you must submit the calculation of TSM emission rate, using Equation 14 of §63.7530, that demonstrates that your source is still meeting the emission limit for TSM emissions (for boilers or process heaters that demonstrate compliance through fuel analysis).

(ix) If you wish to burn a new type of fuel in an individual boiler or process heater subject to an emission limit and you cannot demonstrate compliance with the maximum chlorine input operating limit using Equation 7 of §63.7530 or the maximum mercury input operating limit using Equation 8 of §63.7530, or the maximum TSM input operating limit using Equation 9 of §63.7530 you must include in the compliance report a statement indicating the intent to conduct a new performance test within 60 days of starting to burn the new fuel.

(x) A summary of any monthly fuel analyses conducted to demonstrate compliance according to §§63.7521 and 63.7530 for individual boilers or process heaters subject to emission limits, and any fuel specification analyses conducted according to §§63.7521(f) and 63.7530(g).

(xi) If there are no deviations from any emission limits or operating limits in this subpart that apply to you, a statement that there were no deviations from the emission limits or operating limits during the reporting period.

(xii) If there were no deviations from the monitoring requirements including no periods during which the CMSs, including CEMS, COMS, and CPMS, were out of control as specified in §63.8(c)(7), a statement that there were no deviations and no periods during which the CMS were out of control during the reporting period.

(xiii) If a malfunction occurred during the reporting period, the report must include the number, duration, and a brief description for each type of malfunction which occurred during the reporting period and which caused or may have caused any applicable emission limitation to be exceeded. The report must also include a description of actions taken by you during a malfunction of a boiler, process heater, or associated air pollution control device or CMS to minimize emissions in accordance with §63.7500(a)(3), including actions taken to correct the malfunction.

(xiv) Include the date of the most recent tune-up for each unit subject to only the requirement to conduct an annual, biennial, or 5-year tune-up according to §63.7540(a)(10), (11), or (12) respectively. Include the date of the most recent burner inspection if it was not done annually, biennially, or on a 5-year period and was delayed until the next scheduled or unscheduled unit shutdown.

(xv) If you plan to demonstrate compliance by emission averaging, certify the emission level achieved or the control technology employed is no less stringent than the level or control technology contained in the notification of compliance status in §63.7545(e)(5)(i).

(xvi) For each reporting period, the compliance reports must include all of the calculated 30 day rolling average values based on the daily CEMS (CO and mercury) and CPMS (PM CPMS output, scrubber pH, scrubber liquid flow rate, scrubber pressure drop) data.

(xvii) Statement by a responsible official with that official's name, title, and signature, certifying the truth, accuracy, and completeness of the content of the report.

(d) For each deviation from an emission limit or operating limit in this subpart that occurs at an individual boiler or process heater where you are not using a CMS to comply with that emission limit or operating limit, the compliance report must additionally contain the information required in paragraphs (d)(1) through (3) of this section.

(1) A description of the deviation and which emission limit or operating limit from which you deviated.

(2) Information on the number, duration, and cause of deviations (including unknown cause), as applicable, and the corrective action taken.

(3) If the deviation occurred during an annual performance test, provide the date the annual performance test was completed.

(e) For each deviation from an emission limit, operating limit, and monitoring requirement in this subpart occurring at an individual boiler or process heater where you are using a CMS to comply with that emission limit or operating limit, the compliance report must additionally contain the information required in paragraphs (e)(1) through (9) of this section. This includes any deviations from your site-specific monitoring plan as required in §63.7505(d).

(1) The date and time that each deviation started and stopped and description of the nature of the deviation (i.e., what you deviated from).

(2) The date and time that each CMS was inoperative, except for zero (low-level) and high-level checks.

(3) The date, time, and duration that each CMS was out of control, including the information in §63.8(c)(8).

(4) The date and time that each deviation started and stopped.

(5) A summary of the total duration of the deviation during the reporting period and the total duration as a percent of the total source operating time during that reporting period.

(6) A characterization of the total duration of the deviations during the reporting period into those that are due to control equipment problems, process problems, other known causes, and other unknown causes.

(7) A summary of the total duration of CMS's downtime during the reporting period and the total duration of CMS downtime as a percent of the total source operating time during that reporting period.

(8) A brief description of the source for which there was a deviation.

(9) A description of any changes in CMSs, processes, or controls since the last reporting period for the source for which there was a deviation.

(f)-(g) [Reserved]

(h) You must submit the reports according to the procedures specified in paragraphs (h)(1) through (3) of this section.

(1) Within 60 days after the date of completing each performance test (defined in §63.2) as required by this subpart you must submit the results of the performance tests, including any associated fuel analyses, required by this subpart and the compliance reports required in §63.7550(b) to the EPA's WebFIRE database by using the Compliance and Emissions Data Reporting Interface (CEDRI) that is accessed through the EPA's Central Data Exchange (CDX) (www.epa.gov/cdx). Performance test data must be submitted in the file format generated through use of the EPA's Electronic Reporting Tool (ERT) (see <http://www.epa.gov/ttn/chief/ert/index.html>). Only data collected using test methods on the ERT Web site are subject to this requirement for submitting reports electronically to WebFIRE. Owners or operators who claim that some of the information being submitted for performance tests is confidential business information (CBI) must submit a complete ERT file including information claimed to be CBI on a compact disk or other commonly used electronic storage media (including, but not limited to, flash drives) to the EPA. The electronic media must be clearly marked as CBI and mailed to U.S. EPA/OAPQS/CORE CBI Office, Attention: WebFIRE Administrator, MD C404-02, 4930 Old Page Rd., Durham, NC 27703. The same ERT file with the CBI omitted must be submitted to the EPA via CDX as described earlier in this paragraph. At the discretion of the Administrator, you must also submit these reports, including the confidential business information, to the Administrator in the format specified by the Administrator. For any performance test conducted using test methods that are not listed on the ERT Web site, the owner or operator shall submit the results of the performance test in paper submissions to the Administrator.

(2) Within 60 days after the date of completing each CEMS performance evaluation test (defined in §63.2) you must submit the relative accuracy test audit (RATA) data to the EPA's Central Data Exchange by using CEDRI as mentioned in paragraph (h)(1) of this section. Only RATA pollutants that can be documented with the ERT (as listed on the ERT Web site) are subject to this requirement. For any performance evaluations with no corresponding RATA pollutants listed on the ERT Web site, the owner or operator shall submit the results of the performance evaluation in paper submissions to the Administrator.

(3) You must submit all reports required by Table 9 of this subpart electronically using CEDRI that is accessed through the EPA's Central Data Exchange (CDX) (www.epa.gov/cdx). However, if the reporting form specific to this subpart is not available in CEDRI at the time that the report is due the report you must submit the report to the Administrator at the appropriate address listed in §63.13. At the discretion of the Administrator, you must also submit these reports, to the Administrator in the format specified by the Administrator.

[78 FR 7183, Jan. 31, 2013]

§63.7555 What records must I keep?

(a) You must keep records according to paragraphs (a)(1) and (2) of this section.

(1) A copy of each notification and report that you submitted to comply with this subpart, including all documentation supporting any Initial Notification or Notification of Compliance Status or semiannual compliance report that you submitted, according to the requirements in §63.10(b)(2)(xiv).

(2) Records of performance tests, fuel analyses, or other compliance demonstrations and performance evaluations as required in §63.10(b)(2)(viii).

(b) For each CEMS, COMS, and continuous monitoring system you must keep records according to paragraphs (b)(1) through (5) of this section.

(1) Records described in §63.10(b)(2)(vii) through (xi).

(2) Monitoring data for continuous opacity monitoring system during a performance evaluation as required in §63.6(h)(7)(i) and (ii).

(3) Previous (*i.e.*, superseded) versions of the performance evaluation plan as required in §63.8(d)(3).

(4) Request for alternatives to relative accuracy test for CEMS as required in §63.8(f)(6)(i).

(5) Records of the date and time that each deviation started and stopped.

(c) You must keep the records required in Table 8 to this subpart including records of all monitoring data and calculated averages for applicable operating limits, such as opacity, pressure drop, pH, and operating load, to show continuous compliance with each emission limit and operating limit that applies to you.

(d) For each boiler or process heater subject to an emission limit in Tables 1, 2, or 11 through 13 to this subpart, you must also keep the applicable records in paragraphs (d)(1) through (11) of this section.

(1) You must keep records of monthly fuel use by each boiler or process heater, including the type(s) of fuel and amount(s) used.

(2) If you combust non-hazardous secondary materials that have been determined not to be solid waste pursuant to §241.3(b)(1) and (2) of this chapter, you must keep a record that documents how the secondary material meets each of the legitimacy criteria under §241.3(d)(1) of this chapter. If you combust a fuel that has been processed from a discarded non-hazardous secondary material pursuant to §241.3(b)(4) of this chapter, you must keep records as to how the operations that produced the fuel satisfy the definition of processing in §241.2 of this chapter. If the fuel received a non-waste determination pursuant to the petition process submitted under §241.3(c) of this chapter, you must keep a record that documents how the fuel satisfies the requirements of the petition process. For operating units that combust non-hazardous secondary materials as fuel per §241.4 of this chapter, you must keep records documenting that the material is listed as a non-waste under §241.4(a) of this chapter. Units exempt from the incinerator standards under section 129(g)(1) of the Clean Air Act because they are qualifying facilities burning a homogeneous waste stream do not need to maintain the records described in this paragraph (d)(2).

(3) For units in the limited use subcategory, you must keep a copy of the federally enforceable permit that limits the annual capacity factor to less than or equal to 10 percent and fuel use records for the days the boiler or process heater was operating.

(4) A copy of all calculations and supporting documentation of maximum chlorine fuel input, using Equation 7 of §63.7530, that were done to demonstrate continuous compliance with the HCl emission limit, for sources that demonstrate compliance through performance testing. For sources that demonstrate compliance through fuel analysis, a copy of all calculations and supporting documentation of HCl emission rates, using Equation 12 of §63.7530, that were done to demonstrate compliance with the HCl emission limit. Supporting documentation should include results of any fuel analyses and basis for the estimates of maximum chlorine fuel input or HCl emission rates. You can use the results from one fuel analysis for multiple boilers and process heaters provided they are all burning the same fuel type. However, you must calculate chlorine fuel input, or HCl emission rate, for each boiler and process heater.

(5) A copy of all calculations and supporting documentation of maximum mercury fuel input, using Equation 8 of §63.7530, that were done to demonstrate continuous compliance with the mercury emission limit for sources that demonstrate compliance through performance testing. For sources that demonstrate compliance through fuel analysis, a copy of all calculations and supporting documentation of mercury emission rates, using Equation 13 of §63.7530, that were done to demonstrate compliance with the

mercury emission limit. Supporting documentation should include results of any fuel analyses and basis for the estimates of maximum mercury fuel input or mercury emission rates. You can use the results from one fuel analysis for multiple boilers and process heaters provided they are all burning the same fuel type. However, you must calculate mercury fuel input, or mercury emission rates, for each boiler and process heater.

(6) If, consistent with §63.7515(b), you choose to stack test less frequently than annually, you must keep a record that documents that your emissions in the previous stack test(s) were less than 75 percent of the applicable emission limit (or, in specific instances noted in Tables 1 and 2 or 11 through 13 to this subpart, less than the applicable emission limit), and document that there was no change in source operations including fuel composition and operation of air pollution control equipment that would cause emissions of the relevant pollutant to increase within the past year.

(7) Records of the occurrence and duration of each malfunction of the boiler or process heater, or of the associated air pollution control and monitoring equipment.

(8) Records of actions taken during periods of malfunction to minimize emissions in accordance with the general duty to minimize emissions in §63.7500(a)(3), including corrective actions to restore the malfunctioning boiler or process heater, air pollution control, or monitoring equipment to its normal or usual manner of operation.

(9) A copy of all calculations and supporting documentation of maximum TSM fuel input, using Equation 9 of §63.7530, that were done to demonstrate continuous compliance with the TSM emission limit for sources that demonstrate compliance through performance testing. For sources that demonstrate compliance through fuel analysis, a copy of all calculations and supporting documentation of TSM emission rates, using Equation 14 of §63.7530, that were done to demonstrate compliance with the TSM emission limit. Supporting documentation should include results of any fuel analyses and basis for the estimates of maximum TSM fuel input or TSM emission rates. You can use the results from one fuel analysis for multiple boilers and process heaters provided they are all burning the same fuel type. However, you must calculate TSM fuel input, or TSM emission rates, for each boiler and process heater.

(10) You must maintain records of the calendar date, time, occurrence and duration of each startup and shutdown.

(11) You must maintain records of the type(s) and amount(s) of fuels used during each startup and shutdown.

(e) If you elect to average emissions consistent with §63.7522, you must additionally keep a copy of the emission averaging implementation plan required in §63.7522(g), all calculations required under §63.7522, including monthly records of heat input or steam generation, as applicable, and monitoring records consistent with §63.7541.

(f) If you elect to use efficiency credits from energy conservation measures to demonstrate compliance according to §63.7533, you must keep a copy of the Implementation Plan required in §63.7533(d) and copies of all data and calculations used to establish credits according to §63.7533(b), (c), and (f).

(g) If you elected to demonstrate that the unit meets the specification for mercury for the unit designed to burn gas 1 subcategory, you must maintain monthly records (or at the frequency required by §63.7540(c)) of the calculations and results of the fuel specification for mercury in Table 6.

(h) If you operate a unit in the unit designed to burn gas 1 subcategory that is subject to this subpart, and you use an alternative fuel other than natural gas, refinery gas, gaseous fuel subject to another subpart under this part, other gas 1 fuel, or gaseous fuel subject to another subpart of this part or part 60,

61, or 65, you must keep records of the total hours per calendar year that alternative fuel is burned and the total hours per calendar year that the unit operated during periods of gas curtailment or gas supply emergencies.

(i) You must maintain records of the calendar date, time, occurrence and duration of each startup and shutdown.

(j) You must maintain records of the type(s) and amount(s) of fuels used during each startup and shutdown.

[76 FR 15664, Mar. 21, 2011, as amended at 78 FR 7185, Jan. 31, 2013]

§63.7560 In what form and how long must I keep my records?

(a) Your records must be in a form suitable and readily available for expeditious review, according to §63.10(b)(1).

(b) As specified in §63.10(b)(1), you must keep each record for 5 years following the date of each occurrence, measurement, maintenance, corrective action, report, or record.

(c) You must keep each record on site, or they must be accessible from on site (for example, through a computer network), for at least 2 years after the date of each occurrence, measurement, maintenance, corrective action, report, or record, according to §63.10(b)(1). You can keep the records off site for the remaining 3 years.

OTHER REQUIREMENTS AND INFORMATION

§63.7565 What parts of the General Provisions apply to me?

Table 10 to this subpart shows which parts of the General Provisions in §§63.1 through 63.15 apply to you.

§63.7570 Who implements and enforces this subpart?

(a) This subpart can be implemented and enforced by the EPA, or an Administrator such as your state, local, or tribal agency. If the EPA Administrator has delegated authority to your state, local, or tribal agency, then that agency (as well as the EPA) has the authority to implement and enforce this subpart. You should contact your EPA Regional Office to find out if this subpart is delegated to your state, local, or tribal agency.

(b) In delegating implementation and enforcement authority of this subpart to a state, local, or tribal agency under 40 CFR part 63, subpart E, the authorities listed in paragraphs (b)(1) through (5) of this section are retained by the EPA Administrator and are not transferred to the state, local, or tribal agency, however, the EPA retains oversight of this subpart and can take enforcement actions, as appropriate.

(1) Approval of alternatives to the non-opacity emission limits and work practice standards in §63.7500(a) and (b) under §63.6(g).

(2) Approval of alternative opacity emission limits in §63.7500(a) under §63.6(h)(9).

(3) Approval of major change to test methods in Table 5 to this subpart under §63.7(e)(2)(ii) and (f) and as defined in §63.90, and alternative analytical methods requested under §63.7521(b)(2).

(4) Approval of major change to monitoring under §63.8(f) and as defined in §63.90, and approval of alternative operating parameters under §63.7500(a)(2) and §63.7522(g)(2).

(5) Approval of major change to recordkeeping and reporting under §63.10(e) and as defined in §63.90.

[76 FR 15664, Mar. 21, 2011 as amended at 78 FR 7186, Jan. 31, 2013]

§63.7575 What definitions apply to this subpart?

Terms used in this subpart are defined in the Clean Air Act, in §63.2 (the General Provisions), and in this section as follows:

10-day rolling average means the arithmetic mean of the previous 240 hours of valid operating data. Valid data excludes hours during startup and shutdown, data collected during periods when the monitoring system is out of control as specified in your site-specific monitoring plan, while conducting repairs associated with periods when the monitoring system is out of control, or while conducting required monitoring system quality assurance or quality control activities, and periods when this unit is not operating. The 240 hours should be consecutive, but not necessarily continuous if operations were intermittent.

30-day rolling average means the arithmetic mean of the previous 720 hours of valid operating data. Valid data excludes hours during startup and shutdown, data collected during periods when the monitoring system is out of control as specified in your site-specific monitoring plan, while conducting repairs associated with periods when the monitoring system is out of control, or while conducting required monitoring system quality assurance or quality control activities, and periods when this unit is not operating. The 720 hours should be consecutive, but not necessarily continuous if operations were intermittent.

Affirmative defense means, in the context of an enforcement proceeding, a response or defense put forward by a defendant, regarding which the defendant has the burden of proof, and the merits of which are independently and objectively evaluated in a judicial or administrative proceeding.

Annual capacity factor means the ratio between the actual heat input to a boiler or process heater from the fuels burned during a calendar year and the potential heat input to the boiler or process heater had it been operated for 8,760 hours during a year at the maximum steady state design heat input capacity.

Annual heat input means the heat input for the 12 months preceding the compliance demonstration.

Average annual heat input rate means total heat input divided by the hours of operation for the 12 months preceding the compliance demonstration.

Bag leak detection system means a group of instruments that are capable of monitoring particulate matter loadings in the exhaust of a fabric filter (*i.e.*, baghouse) in order to detect bag failures. A bag leak detection system includes, but is not limited to, an instrument that operates on electrodynamic, triboelectric, light scattering, light transmittance, or other principle to monitor relative particulate matter loadings.

Benchmark means the fuel heat input for a boiler or process heater for the one-year period before the date that an energy demand reduction occurs, unless it can be demonstrated that a different time period is more representative of historical operations.

Biodiesel means a mono-alkyl ester derived from biomass and conforming to ASTM D6751-11b, Standard Specification for Biodiesel Fuel Blend Stock (B100) for Middle Distillate Fuels (incorporated by reference, see §63.14).

Biomass or bio-based solid fuel means any biomass-based solid fuel that is not a solid waste. This includes, but is not limited to, wood residue; wood products (e.g., trees, tree stumps, tree limbs, bark, lumber, sawdust, sander dust, chips, scraps, slabs, millings, and shavings); animal manure, including litter and other bedding materials; vegetative agricultural and silvicultural materials, such as logging residues (slash), nut and grain hulls and chaff (e.g., almond, walnut, peanut, rice, and wheat), bagasse, orchard prunings, corn stalks, coffee bean hulls and grounds. This definition of biomass is not intended to suggest that these materials are or are not solid waste.

Blast furnace gas fuel-fired boiler or process heater means an industrial/commercial/institutional boiler or process heater that receives 90 percent or more of its total annual gas volume from blast furnace gas.

Boiler means an enclosed device using controlled flame combustion and having the primary purpose of recovering thermal energy in the form of steam or hot water. Controlled flame combustion refers to a steady-state, or near steady-state, process wherein fuel and/or oxidizer feed rates are controlled. A device combusting solid waste, as defined in §241.3 of this chapter, is not a boiler unless the device is exempt from the definition of a solid waste incineration unit as provided in section 129(g)(1) of the Clean Air Act. Waste heat boilers are excluded from this definition.

Boiler system means the boiler and associated components, such as, the feed water system, the combustion air system, the fuel system (including burners), blowdown system, combustion control systems, steam systems, and condensate return systems.

Calendar year means the period between January 1 and December 31, inclusive, for a given year.

Coal means all solid fuels classifiable as anthracite, bituminous, sub-bituminous, or lignite by ASTM D388 (incorporated by reference, see §63.14), coal refuse, and petroleum coke. For the purposes of this subpart, this definition of "coal" includes synthetic fuels derived from coal, including but not limited to, solvent-refined coal, coal-oil mixtures, and coal-water mixtures. Coal derived gases are excluded from this definition.

Coal refuse means any by-product of coal mining or coal cleaning operations with an ash content greater than 50 percent (by weight) and a heating value less than 13,900 kilojoules per kilogram (6,000 Btu per pound) on a dry basis.

Commercial/institutional boiler means a boiler used in commercial establishments or institutional establishments such as medical centers, nursing homes, research centers, institutions of higher education, elementary and secondary schools, libraries, religious establishments, governmental buildings, hotels, restaurants, and laundries to provide electricity, steam, and/or hot water.

Common stack means the exhaust of emissions from two or more affected units through a single flue. Affected units with a common stack may each have separate air pollution control systems located before the common stack, or may have a single air pollution control system located after the exhausts come together in a single flue.

Cost-effective energy conservation measure means a measure that is implemented to improve the energy efficiency of the boiler or facility that has a payback (return of investment) period of 2 years or less.

Daily block average means the arithmetic mean of all valid emission concentrations or parameter levels recorded when a unit is operating measured over the 24-hour period from 12 a.m. (midnight) to 12 a.m. (midnight), except for periods of startup and shutdown or downtime.

Deviation. (1) *Deviation* means any instance in which an affected source subject to this subpart, or an owner or operator of such a source:

(i) Fails to meet any applicable requirement or obligation established by this subpart including, but not limited to, any emission limit, operating limit, or work practice standard; or

(ii) Fails to meet any term or condition that is adopted to implement an applicable requirement in this subpart and that is included in the operating permit for any affected source required to obtain such a permit.

(2) A deviation is not always a violation.

Dioxins/furans means tetra- through octa-chlorinated dibenzo-p-dioxins and dibenzofurans.

Distillate oil means fuel oils that contain 0.05 weight percent nitrogen or less and comply with the specifications for fuel oil numbers 1 and 2, as defined by the American Society of Testing and Materials in ASTM D396 (incorporated by reference, see §63.14) or diesel fuel oil numbers 1 and 2, as defined by the American Society for Testing and Materials in ASTM D975 (incorporated by reference, see §63.14), kerosene, and biodiesel as defined by the American Society of Testing and Materials in ASTM D6751-11b (incorporated by reference, see §60.14).

Dry scrubber means an add-on air pollution control system that injects dry alkaline sorbent (dry injection) or sprays an alkaline sorbent (spray dryer) to react with and neutralize acid gas in the exhaust stream forming a dry powder material. Sorbent injection systems used as control devices in fluidized bed boilers and process heaters are included in this definition. A dry scrubber is a dry control system.

Dutch oven means a unit having a refractory-walled cell connected to a conventional boiler setting. Fuel materials are introduced through an opening in the roof of the dutch oven and burn in a pile on its floor. Fluidized bed boilers are not part of the dutch oven design category.

Efficiency credit means emission reductions above those required by this subpart. Efficiency credits generated may be used to comply with the emissions limits. Credits may come from pollution prevention projects that result in reduced fuel use by affected units. Boilers that are shut down cannot be used to generate credits unless the facility provides documentation linking the permanent shutdown to implementation of the energy conservation measures identified in the energy assessment.

Electric utility steam generating unit (EGU) means a fossil fuel-fired combustion unit of more than 25 megawatts electric (MWe) that serves a generator that produces electricity for sale. A fossil fuel-fired unit that cogenerates steam and electricity and supplies more than one-third of its potential electric output capacity and more than 25 MWe output to any utility power distribution system for sale is considered an electric utility steam generating unit. To be "capable of combusting" fossil fuels, an EGU would need to have these fuels allowed in their operating permits and have the appropriate fuel handling facilities on-site or otherwise available (e.g., coal handling equipment, including coal storage area, belts and conveyers, pulverizers, etc.; oil storage facilities). In addition, fossil fuel-fired EGU means any EGU that fired fossil fuel for more than 10.0 percent of the average annual heat input in any 3 consecutive calendar years or for more than 15.0 percent of the annual heat input during any one calendar year after April 16, 2012.

Electrostatic precipitator (ESP) means an add-on air pollution control device used to capture particulate matter by charging the particles using an electrostatic field, collecting the particles using a

grounded collecting surface, and transporting the particles into a hopper. An electrostatic precipitator is usually a dry control system.

Energy assessment means the following for the emission units covered by this subpart:

(1) The energy assessment for facilities with affected boilers and process heaters with a combined heat input capacity of less than 0.3 trillion Btu (TBtu) per year will be 8 on-site technical labor hours in length maximum, but may be longer at the discretion of the owner or operator of the affected source. The boiler system(s) and any on-site energy use system(s) accounting for at least 50 percent of the affected boiler(s) energy (e.g., steam, hot water, process heat, or electricity) production, as applicable, will be evaluated to identify energy savings opportunities, within the limit of performing an 8-hour on-site energy assessment.

(2) The energy assessment for facilities with affected boilers and process heaters with a combined heat input capacity of 0.3 to 1.0 TBtu/year will be 24 on-site technical labor hours in length maximum, but may be longer at the discretion of the owner or operator of the affected source. The boiler system(s) and any on-site energy use system(s) accounting for at least 33 percent of the energy (e.g., steam, hot water, process heat, or electricity) production, as applicable, will be evaluated to identify energy savings opportunities, within the limit of performing a 24-hour on-site energy assessment.

(3) The energy assessment for facilities with affected boilers and process heaters with a combined heat input capacity greater than 1.0 TBtu/year will be up to 24 on-site technical labor hours in length for the first TBtu/yr plus 8 on-site technical labor hours for every additional 1.0 TBtu/yr not to exceed 160 on-site technical hours, but may be longer at the discretion of the owner or operator of the affected source. The boiler system(s), process heater(s), and any on-site energy use system(s) accounting for at least 20 percent of the energy (e.g., steam, process heat, hot water, or electricity) production, as applicable, will be evaluated to identify energy savings opportunities.

(4) The on-site energy use systems serving as the basis for the percent of affected boiler(s) and process heater(s) energy production in paragraphs (1), (2), and (3) of this definition may be segmented by production area or energy use area as most logical and applicable to the specific facility being assessed (e.g., product X manufacturing area; product Y drying area; Building Z).

Energy management practices means the set of practices and procedures designed to manage energy use that are demonstrated by the facility's energy policies, a facility energy manager and other staffing responsibilities, energy performance measurement and tracking methods, an energy saving goal, action plans, operating procedures, internal reporting requirements, and periodic review intervals used at the facility.

Energy management program means a program that includes a set of practices and procedures designed to manage energy use that are demonstrated by the facility's energy policies, a facility energy manager and other staffing responsibilities, energy performance measurement and tracking methods, an energy saving goal, action plans, operating procedures, internal reporting requirements, and periodic review intervals used at the facility. Facilities may establish their program through energy management systems compatible with ISO 50001.

Energy use system includes the following systems located on-site that use energy (steam, hot water, or electricity) provided by the affected boiler or process heater: process heating; compressed air systems; machine drive (motors, pumps, fans); process cooling; facility heating, ventilation, and air-conditioning systems; hot water systems; building envelop; and lighting; or other systems that use steam, hot water, process heat, or electricity provided by the affected boiler or process heater. Energy use systems are only those systems using energy clearly produced by affected boilers and process heaters.

Equivalent means the following only as this term is used in Table 6 to this subpart:

(1) An equivalent sample collection procedure means a published voluntary consensus standard or practice (VCS) or EPA method that includes collection of a minimum of three composite fuel samples, with each composite consisting of a minimum of three increments collected at approximately equal intervals over the test period.

(2) An equivalent sample compositing procedure means a published VCS or EPA method to systematically mix and obtain a representative subsample (part) of the composite sample.

(3) An equivalent sample preparation procedure means a published VCS or EPA method that: Clearly states that the standard, practice or method is appropriate for the pollutant and the fuel matrix; or is cited as an appropriate sample preparation standard, practice or method for the pollutant in the chosen VCS or EPA determinative or analytical method.

(4) An equivalent procedure for determining heat content means a published VCS or EPA method to obtain gross calorific (or higher heating) value.

(5) An equivalent procedure for determining fuel moisture content means a published VCS or EPA method to obtain moisture content. If the sample analysis plan calls for determining metals (especially the mercury, selenium, or arsenic) using an aliquot of the dried sample, then the drying temperature must be modified to prevent vaporizing these metals. On the other hand, if metals analysis is done on an "as received" basis, a separate aliquot can be dried to determine moisture content and the metals concentration mathematically adjusted to a dry basis.

(6) An equivalent pollutant (mercury, HCl) determinative or analytical procedure means a published VCS or EPA method that clearly states that the standard, practice, or method is appropriate for the pollutant and the fuel matrix and has a published detection limit equal or lower than the methods listed in Table 6 to this subpart for the same purpose.

Fabric filter means an add-on air pollution control device used to capture particulate matter by filtering gas streams through filter media, also known as a baghouse. A fabric filter is a dry control system.

Federally enforceable means all limitations and conditions that are enforceable by the EPA Administrator, including, but not limited to, the requirements of 40 CFR parts 60, 61, 63, and 65, requirements within any applicable state implementation plan, and any permit requirements established under 40 CFR 52.21 or under 40 CFR 51.18 and 40 CFR 51.24.

Fluidized bed boiler means a boiler utilizing a fluidized bed combustion process that is not a pulverized coal boiler.

Fluidized bed boiler with an integrated fluidized bed heat exchanger means a boiler utilizing a fluidized bed combustion where the entire tube surface area is located outside of the furnace section at the exit of the cyclone section and exposed to the flue gas stream for conductive heat transfer. This design applies only to boilers in the unit designed to burn coal/solid fossil fuel subcategory that fire coal refuse.

Fluidized bed combustion means a process where a fuel is burned in a bed of granulated particles, which are maintained in a mobile suspension by the forward flow of air and combustion products.

Fuel cell means a boiler type in which the fuel is dropped onto suspended fixed grates and is fired in a pile. The refractory-lined fuel cell uses combustion air preheating and positioning of secondary and tertiary air injection ports to improve boiler efficiency. Fluidized bed, dutch oven, pile burner, hybrid suspension grate, and suspension burners are not part of the fuel cell subcategory.

Fuel type means each category of fuels that share a common name or classification. Examples include, but are not limited to, bituminous coal, sub-bituminous coal, lignite, anthracite, biomass, distillate oil, residual oil. Individual fuel types received from different suppliers are not considered new fuel types.

Gaseous fuel includes, but is not limited to, natural gas, process gas, landfill gas, coal derived gas, refinery gas, and biogas. Blast furnace gas and process gases that are regulated under another subpart of this part, or part 60, part 61, or part 65 of this chapter, are exempted from this definition.

Heat input means heat derived from combustion of fuel in a boiler or process heater and does not include the heat input from preheated combustion air, recirculated flue gases, returned condensate, or exhaust gases from other sources such as gas turbines, internal combustion engines, kilns, etc.

Heavy liquid includes residual oil and any other liquid fuel not classified as a light liquid.

Hourly average means the arithmetic average of at least four CMS data values representing the four 15-minute periods in an hour, or at least two 15-minute data values during an hour when CMS calibration, quality assurance, or maintenance activities are being performed.

Hot water heater means a closed vessel with a capacity of no more than 120 U.S. gallons in which water is heated by combustion of gaseous, liquid, or biomass/bio-based solid fuel and is withdrawn for use external to the vessel. Hot water boilers (i.e., not generating steam) combusting gaseous, liquid, or biomass fuel with a heat input capacity of less than 1.6 million Btu per hour are included in this definition. The 120 U.S. gallon capacity threshold to be considered a hot water heater is independent of the 1.6 MMBtu/hr heat input capacity threshold for hot water boilers. Hot water heater also means a tankless unit that provides on demand hot water.

Hybrid suspension grate boiler means a boiler designed with air distributors to spread the fuel material over the entire width and depth of the boiler combustion zone. The biomass fuel combusted in these units exceeds a moisture content of 40 percent on an as-fired annual heat input basis. The drying and much of the combustion of the fuel takes place in suspension, and the combustion is completed on the grate or floor of the boiler. Fluidized bed, dutch oven, and pile burner designs are not part of the hybrid suspension grate boiler design category.

Industrial boiler means a boiler used in manufacturing, processing, mining, and refining or any other industry to provide steam, hot water, and/or electricity.

Light liquid includes distillate oil, biodiesel, or vegetable oil.

Limited-use boiler or process heater means any boiler or process heater that burns any amount of solid, liquid, or gaseous fuels and has a federally enforceable average annual capacity factor of no more than 10 percent.

Liquid fuel includes, but is not limited to, light liquid, heavy liquid, any form of liquid fuel derived from petroleum, used oil, liquid biofuels, biodiesel, vegetable oil, and comparable fuels as defined under 40 CFR 261.38.

Load fraction means the actual heat input of a boiler or process heater divided by heat input during the performance test that established the minimum sorbent injection rate or minimum activated carbon injection rate, expressed as a fraction (e.g., for 50 percent load the load fraction is 0.5).

Major source for oil and natural gas production facilities, as used in this subpart, shall have the same meaning as in §63.2, except that:

(1) Emissions from any oil or gas exploration or production well (with its associated equipment, as defined in this section), and emissions from any pipeline compressor station or pump station shall not be aggregated with emissions from other similar units to determine whether such emission points or stations are major sources, even when emission points are in a contiguous area or under common control;

(2) Emissions from processes, operations, or equipment that are not part of the same facility, as defined in this section, shall not be aggregated; and

(3) For facilities that are production field facilities, only HAP emissions from glycol dehydration units and storage vessels with the potential for flash emissions shall be aggregated for a major source determination. For facilities that are not production field facilities, HAP emissions from all HAP emission units shall be aggregated for a major source determination.

Metal process furnaces are a subcategory of process heaters, as defined in this subpart, which include natural gas-fired annealing furnaces, preheat furnaces, reheat furnaces, aging furnaces, heat treat furnaces, and homogenizing furnaces.

Million Btu (MMBtu) means one million British thermal units.

Minimum activated carbon injection rate means load fraction multiplied by the lowest hourly average activated carbon injection rate measured according to Table 7 to this subpart during the most recent performance test demonstrating compliance with the applicable emission limit.

Minimum oxygen level means the lowest hourly average oxygen level measured according to Table 7 to this subpart during the most recent performance test demonstrating compliance with the applicable emission limit.

Minimum pressure drop means the lowest hourly average pressure drop measured according to Table 7 to this subpart during the most recent performance test demonstrating compliance with the applicable emission limit.

Minimum scrubber effluent pH means the lowest hourly average sorbent liquid pH measured at the inlet to the wet scrubber according to Table 7 to this subpart during the most recent performance test demonstrating compliance with the applicable hydrogen chloride emission limit.

Minimum scrubber liquid flow rate means the lowest hourly average liquid flow rate (e.g., to the PM scrubber or to the acid gas scrubber) measured according to Table 7 to this subpart during the most recent performance stack test demonstrating compliance with the applicable emission limit.

Minimum scrubber pressure drop means the lowest hourly average scrubber pressure drop measured according to Table 7 to this subpart during the most recent performance test demonstrating compliance with the applicable emission limit.

Minimum sorbent injection rate means:

(1) The load fraction multiplied by the lowest hourly average sorbent injection rate for each sorbent measured according to Table 7 to this subpart during the most recent performance test demonstrating compliance with the applicable emission limits; or

(2) For fluidized bed combustion, the lowest average ratio of sorbent to sulfur measured during the most recent performance test.

Minimum total secondary electric power means the lowest hourly average total secondary electric power determined from the values of secondary voltage and secondary current to the electrostatic precipitator measured according to Table 7 to this subpart during the most recent performance test demonstrating compliance with the applicable emission limits.

Natural gas means:

- (1) A naturally occurring mixture of hydrocarbon and nonhydrocarbon gases found in geologic formations beneath the earth's surface, of which the principal constituent is methane; or
- (2) Liquefied petroleum gas, as defined in ASTM D1835 (incorporated by reference, see §63.14); or
- (3) A mixture of hydrocarbons that maintains a gaseous state at ISO conditions. Additionally, natural gas must either be composed of at least 70 percent methane by volume or have a gross calorific value between 35 and 41 megajoules (MJ) per dry standard cubic meter (950 and 1,100 Btu per dry standard cubic foot); or
- (4) Propane or propane derived synthetic natural gas. Propane means a colorless gas derived from petroleum and natural gas, with the molecular structure C_3H_8 .

Opacity means the degree to which emissions reduce the transmission of light and obscure the view of an object in the background.

Operating day means a 24-hour period between 12 midnight and the following midnight during which any fuel is combusted at any time in the boiler or process heater unit. It is not necessary for fuel to be combusted for the entire 24-hour period.

Other combustor means a unit designed to burn solid fuel that is not classified as a dutch oven, fluidized bed, fuel cell, hybrid suspension grate boiler, pulverized coal boiler, stoker, sloped grate, or suspension boiler as defined in this subpart.

Other gas 1 fuel means a gaseous fuel that is not natural gas or refinery gas and does not exceed a maximum concentration of 40 micrograms/cubic meters of mercury.

Oxygen analyzer system means all equipment required to determine the oxygen content of a gas stream and used to monitor oxygen in the boiler or process heater flue gas, boiler or process heater, firebox, or other appropriate location. This definition includes oxygen trim systems. The source owner or operator must install, calibrate, maintain, and operate the oxygen analyzer system in accordance with the manufacturer's recommendations.

Oxygen trim system means a system of monitors that is used to maintain excess air at the desired level in a combustion device. A typical system consists of a flue gas oxygen and/or CO monitor that automatically provides a feedback signal to the combustion air controller.

Particulate matter (PM) means any finely divided solid or liquid material, other than uncombined water, as measured by the test methods specified under this subpart, or an approved alternative method.

Period of gas curtailment or supply interruption means a period of time during which the supply of gaseous fuel to an affected boiler or process heater is restricted or halted for reasons beyond the control of the facility. The act of entering into a contractual agreement with a supplier of natural gas established for curtailment purposes does not constitute a reason that is under the control of a facility for the purposes of this definition. An increase in the cost or unit price of natural gas due to normal market fluctuations not during periods of supplier delivery restriction does not constitute a period of natural gas

curtailment or supply interruption. On-site gaseous fuel system emergencies or equipment failures qualify as periods of supply interruption when the emergency or failure is beyond the control of the facility.

Pile burner means a boiler design incorporating a design where the anticipated biomass fuel has a high relative moisture content. Grates serve to support the fuel, and underfire air flowing up through the grates provides oxygen for combustion, cools the grates, promotes turbulence in the fuel bed, and fires the fuel. The most common form of pile burning is the dutch oven.

Process heater means an enclosed device using controlled flame, and the unit's primary purpose is to transfer heat indirectly to a process material (liquid, gas, or solid) or to a heat transfer material (e.g., glycol or a mixture of glycol and water) for use in a process unit, instead of generating steam. Process heaters are devices in which the combustion gases do not come into direct contact with process materials. A device combusting solid waste, as defined in §241.3 of this chapter, is not a process heater unless the device is exempt from the definition of a solid waste incineration unit as provided in section 129(g)(1) of the Clean Air Act. Process heaters do not include units used for comfort heat or space heat, food preparation for on-site consumption, or autoclaves. Waste heat process heaters are excluded from this definition.

Pulverized coal boiler means a boiler in which pulverized coal or other solid fossil fuel is introduced into an air stream that carries the coal to the combustion chamber of the boiler where it is fired in suspension.

Qualified energy assessor means:

(1) Someone who has demonstrated capabilities to evaluate energy savings opportunities for steam generation and major energy using systems, including, but not limited to:

- (i) Boiler combustion management.
- (ii) Boiler thermal energy recovery, including
 - (A) Conventional feed water economizer,
 - (B) Conventional combustion air preheater, and
 - (C) Condensing economizer.
- (iii) Boiler blowdown thermal energy recovery.
- (iv) Primary energy resource selection, including
 - (A) Fuel (primary energy source) switching, and
 - (B) Applied steam energy versus direct-fired energy versus electricity.
- (v) Insulation issues.
- (vi) Steam trap and steam leak management.
- (vi) Condensate recovery.
- (viii) Steam end-use management.

(2) Capabilities and knowledge includes, but is not limited to:

(i) Background, experience, and recognized abilities to perform the assessment activities, data analysis, and report preparation.

(ii) Familiarity with operating and maintenance practices for steam or process heating systems.

(iii) Additional potential steam system improvement opportunities including improving steam turbine operations and reducing steam demand.

(iv) Additional process heating system opportunities including effective utilization of waste heat and use of proper process heating methods.

(v) Boiler-steam turbine cogeneration systems.

(vi) Industry specific steam end-use systems.

Refinery gas means any gas that is generated at a petroleum refinery and is combusted. Refinery gas includes natural gas when the natural gas is combined and combusted in any proportion with a gas generated at a refinery. Refinery gas includes gases generated from other facilities when that gas is combined and combusted in any proportion with gas generated at a refinery.

Regulated gas stream means an offgas stream that is routed to a boiler or process heater for the purpose of achieving compliance with a standard under another subpart of this part or part 60, part 61, or part 65 of this chapter.

Residential boiler means a boiler used to provide heat and/or hot water and/or as part of a residential combined heat and power system. This definition includes boilers located at an institutional facility (e.g., university campus, military base, church grounds) or commercial/industrial facility (e.g., farm) used primarily to provide heat and/or hot water for:

(1) A dwelling containing four or fewer families; or

(2) A single unit residence dwelling that has since been converted or subdivided into condominiums or apartments.

Residual oil means crude oil, fuel oil that does not comply with the specifications under the definition of distillate oil, and all fuel oil numbers 4, 5, and 6, as defined by the American Society of Testing and Materials in ASTM D396-10 (incorporated by reference, see §63.14(b)).

Responsible official means responsible official as defined in §70.2.

Secondary material means the material as defined in §241.2 of this chapter.

Shutdown means the cessation of operation of a boiler or process heater for any purpose. Shutdown begins either when none of the steam from the boiler is supplied for heating and/or producing electricity, or for any other purpose, or at the point of no fuel being fired in the boiler or process heater, whichever is earlier. Shutdown ends when there is no steam and no heat being supplied and no fuel being fired in the boiler or process heater.

Sloped grate means a unit where the solid fuel is fed to the top of the grate from where it slides downwards; while sliding the fuel first dries and then ignites and burns. The ash is deposited at the

bottom of the grate. Fluidized bed, dutch oven, pile burner, hybrid suspension grate, suspension burners, and fuel cells are not considered to be a sloped grate design.

Solid fossil fuel includes, but is not limited to, coal, coke, petroleum coke, and tire derived fuel.

Solid fuel means any solid fossil fuel or biomass or bio-based solid fuel.

Startup means either the first-ever firing of fuel in a boiler or process heater for the purpose of supplying steam or heat for heating and/or producing electricity, or for any other purpose, or the firing of fuel in a boiler after a shutdown event for any purpose. Startup ends when any of the steam or heat from the boiler or process heater is supplied for heating, and/or producing electricity, or for any other purpose.

Steam output means:

(1) For a boiler that produces steam for process or heating only (no power generation), the energy content in terms of MMBtu of the boiler steam output,

(2) For a boiler that cogenerates process steam and electricity (also known as combined heat and power), the total energy output, which is the sum of the energy content of the steam exiting the turbine and sent to process in MMBtu and the energy of the electricity generated converted to MMBtu at a rate of 10,000 Btu per kilowatt-hour generated (10 MMBtu per megawatt-hour), and

(3) For a boiler that generates only electricity, the alternate output-based emission limits would be calculated using Equations 21 through 25 of this section, as appropriate:

(i) For emission limits for boilers in the unit designed to burn solid fuel subcategory use Equation 21 of this section:

$$EL_{OBE} = EL_T \times 12.7 \text{ MMBtu/Mwh} \quad (\text{Eq. 21})$$

[View or download PDF](#)

Where:

EL_{OBE} = Emission limit in units of pounds per megawatt-hour.

EL_T = Appropriate emission limit from Table 1 or 2 of this subpart in units of pounds per million Btu heat input.

(ii) For PM and CO emission limits for boilers in one of the subcategories of units designed to burn coal use Equation 22 of this section:

$$EL_{OBE} = EL_T \times 12.2 \text{ MMBtu/Mwh} \quad (\text{Eq. 22})$$

[View or download PDF](#)

Where:

EL_{OBE} = Emission limit in units of pounds per megawatt-hour.

EL_T = Appropriate emission limit from Table 1 or 2 of this subpart in units of pounds per million Btu heat input.

(iii) For PM and CO emission limits for boilers in one of the subcategories of units designed to burn biomass use Equation 23 of this section:

$$EL_{OBE} = EL_T \times 13.9 \text{ MMBtu/Mwh} \quad (\text{Eq. 23})$$

[View or download PDF](#)

Where:

EL_{OBE} = Emission limit in units of pounds per megawatt-hour.

EL_T = Appropriate emission limit from Table 1 or 2 of this subpart in units of pounds per million Btu heat input.

(iv) For emission limits for boilers in one of the subcategories of units designed to burn liquid fuels use Equation 24 of this section:

$$EL_{OBE} = EL_T \times 13.8 \text{ MMBtu/Mwh} \quad (\text{Eq. 24})$$

[View or download PDF](#)

Where:

EL_{OBE} = Emission limit in units of pounds per megawatt-hour.

EL_T = Appropriate emission limit from Table 1 or 2 of this subpart in units of pounds per million Btu heat input.

(v) For emission limits for boilers in the unit designed to burn gas 2 (other) subcategory, use Equation 25 of this section:

$$EL_{OBE} = EL_T \times 10.4 \text{ MMBtu/Mwh} \quad (\text{Eq. 25})$$

[View or download PDF](#)

Where:

EL_{OBE} = Emission limit in units of pounds per megawatt-hour.

EL_T = Appropriate emission limit from Table 1 or 2 of this subpart in units of pounds per million Btu heat input.

Stoker means a unit consisting of a mechanically operated fuel feeding mechanism, a stationary or moving grate to support the burning of fuel and admit under-grate air to the fuel, an overfire air system to complete combustion, and an ash discharge system. This definition of stoker includes air swept stokers. There are two general types of stokers: Underfeed and overfeed. Overfeed stokers include mass feed and spreader stokers. Fluidized bed, dutch oven, pile burner, hybrid suspension grate, suspension burners, and fuel cells are not considered to be a stoker design.

Stoker/sloped grate/other unit designed to burn kiln dried biomass means the unit is in the units designed to burn biomass/bio-based solid subcategory that is either a stoker, sloped grate, or other combustor design and is not in the stoker/sloped grate/other units designed to burn wet biomass subcategory.

Stoker/sloped grate/other unit designed to burn wet biomass means the unit is in the units designed to burn biomass/bio-based solid subcategory that is either a stoker, sloped grate, or other combustor design and any of the biomass/bio-based solid fuel combusted in the unit exceeds 20 percent moisture on an annual heat input basis.

Suspension burner means a unit designed to fire dry biomass/biobased solid particles in suspension that are conveyed in an airstream to the furnace like pulverized coal. The combustion of the fuel material is completed on a grate or floor below. The biomass/biobased fuel combusted in the unit shall not exceed 20 percent moisture on an annual heat input basis. Fluidized bed, dutch oven, pile burner, and hybrid suspension grate units are not part of the suspension burner subcategory.

Temporary boiler means any gaseous or liquid fuel boiler that is designed to, and is capable of, being carried or moved from one location to another by means of, for example, wheels, skids, carrying handles, dollies, trailers, or platforms. A boiler is not a temporary boiler if any one of the following conditions exists:

(1) The equipment is attached to a foundation.

(2) The boiler or a replacement remains at a location within the facility and performs the same or similar function for more than 12 consecutive months, unless the regulatory agency approves an extension. An extension may be granted by the regulating agency upon petition by the owner or operator of a unit specifying the basis for such a request. Any temporary boiler that replaces a temporary boiler at a location and performs the same or similar function will be included in calculating the consecutive time period.

(3) The equipment is located at a seasonal facility and operates during the full annual operating period of the seasonal facility, remains at the facility for at least 2 years, and operates at that facility for at least 3 months each year.

(4) The equipment is moved from one location to another within the facility but continues to perform the same or similar function and serve the same electricity, steam, and/or hot water system in an attempt to circumvent the residence time requirements of this definition.

Total selected metals (TSM) means the sum of the following metallic hazardous air pollutants: arsenic, beryllium, cadmium, chromium, lead, manganese, nickel and selenium.

Traditional fuel means the fuel as defined in §241.2 of this chapter.

Tune-up means adjustments made to a boiler or process heater in accordance with the procedures outlined in §63.7540(a)(10).

Ultra low sulfur liquid fuel means a distillate oil that has less than or equal to 15 ppm sulfur.

Unit designed to burn biomass/bio-based solid subcategory includes any boiler or process heater that burns at least 10 percent biomass or bio-based solids on an annual heat input basis in combination with solid fossil fuels, liquid fuels, or gaseous fuels.

Unit designed to burn coal/solid fossil fuel subcategory includes any boiler or process heater that burns any coal or other solid fossil fuel alone or at least 10 percent coal or other solid fossil fuel on an annual heat input basis in combination with liquid fuels, gaseous fuels, or less than 10 percent biomass and bio-based solids on an annual heat input basis.

Unit designed to burn gas 1 subcategory includes any boiler or process heater that burns only natural gas, refinery gas, and/or other gas 1 fuels. Gaseous fuel boilers and process heaters that burn liquid fuel for periodic testing of liquid fuel, maintenance, or operator training, not to exceed a combined total of 48 hours during any calendar year, are included in this definition. Gaseous fuel boilers and process heaters that burn liquid fuel during periods of gas curtailment or gas supply interruptions of any duration are also included in this definition.

Unit designed to burn gas 2 (other) subcategory includes any boiler or process heater that is not in the unit designed to burn gas 1 subcategory and burns any gaseous fuels either alone or in combination with less than 10 percent coal/solid fossil fuel, and less than 10 percent biomass/bio-based solid fuel on an annual heat input basis, and no liquid fuels. Gaseous fuel boilers and process heaters that are not in the unit designed to burn gas 1 subcategory and that burn liquid fuel for periodic testing of liquid fuel, maintenance, or operator training, not to exceed a combined total of 48 hours during any calendar year, are included in this definition. Gaseous fuel boilers and process heaters that are not in the unit designed to burn gas 1 subcategory and that burn liquid fuel during periods of gas curtailment or gas supply interruption of any duration are also included in this definition.

Unit designed to burn heavy liquid subcategory means a unit in the unit designed to burn liquid subcategory where at least 10 percent of the heat input from liquid fuels on an annual heat input basis comes from heavy liquids.

Unit designed to burn light liquid subcategory means a unit in the unit designed to burn liquid subcategory that is not part of the unit designed to burn heavy liquid subcategory.

Unit designed to burn liquid subcategory includes any boiler or process heater that burns any liquid fuel, but less than 10 percent coal/solid fossil fuel and less than 10 percent biomass/bio-based solid fuel on an annual heat input basis, either alone or in combination with gaseous fuels. Units in the unit design to burn gas 1 or unit designed to burn gas 2 (other) subcategories that burn liquid fuel for periodic testing of liquid fuel, maintenance, or operator training, not to exceed a combined total of 48 hours during any calendar year are not included in this definition. Units in the unit design to burn gas 1 or unit designed to burn gas 2 (other) subcategories during periods of gas curtailment or gas supply interruption of any duration are also not included in this definition.

Unit designed to burn liquid fuel that is a non-continental unit means an industrial, commercial, or institutional boiler or process heater meeting the definition of the unit designed to burn liquid subcategory located in the State of Hawaii, the Virgin Islands, Guam, American Samoa, the Commonwealth of Puerto Rico, or the Northern Mariana Islands.

Unit designed to burn solid fuel subcategory means any boiler or process heater that burns only solid fuels or at least 10 percent solid fuel on an annual heat input basis in combination with liquid fuels or gaseous fuels.

Vegetable oil means oils extracted from vegetation.

Voluntary Consensus Standards or VCS mean technical standards (e.g., materials specifications, test methods, sampling procedures, business practices) developed or adopted by one or more voluntary consensus bodies. EPA/Office of Air Quality Planning and Standards, by precedent, has only used VCS that are written in English. Examples of VCS bodies are: American Society of Testing and Materials (ASTM 100 Barr Harbor Drive, P.O. Box CB700, West Conshohocken, Pennsylvania 19428-B2959, (800) 262-1373, <http://www.astm.org>), American Society of Mechanical Engineers (ASME ASME, Three Park Avenue, New York, NY 10016-5990, (800) 843-2763, <http://www.asme.org>), International Standards Organization (ISO 1, ch. de la Voie-Creuse, Case postale 56, CH-1211 Geneva 20, Switzerland, +41 22 749 01 11, <http://www.iso.org/iso/home.htm>), Standards Australia (AS Level 10, The Exchange Centre, 20 Bridge Street, Sydney, GPO Box 476, Sydney NSW 2001, + 61 2 9237 6171 <http://www.stadards.org.au>), British Standards Institution (BSI, 389 Chiswick High Road, London, W4 4AL, United Kingdom, +44 (0)20 8996 9001, <http://www.bsigroup.com>), Canadian Standards Association (CSA 5060 Spectrum Way, Suite 100, Mississauga, Ontario L4W 5N6, Canada, 800-463-6727, <http://www.csa.ca>), European Committee for Standardization (CEN CENELEC Management Centre Avenue Marnix 17 B-1000 Brussels, Belgium +32 2 550 08 11, <http://www.cen.eu/cen>), and German Engineering Standards (VDI VDI Guidelines Department, P.O. Box 10 11 39 40002, Duesseldorf, Germany, +49 211 6214-230, <http://www.vdi.eu>). The types of standards that are not considered VCS are

standards developed by: The United States, e.g., California (CARB) and Texas (TCEQ); industry groups, such as American Petroleum Institute (API), Gas Processors Association (GPA), and Gas Research Institute (GRI); and other branches of the U.S. government, e.g., Department of Defense (DOD) and Department of Transportation (DOT). This does not preclude EPA from using standards developed by groups that are not VCS bodies within their rule. When this occurs, EPA has done searches and reviews for VCS equivalent to these non-EPA methods.

Waste heat boiler means a device that recovers normally unused energy (i.e., hot exhaust gas) and converts it to usable heat. Waste heat boilers are also referred to as heat recovery steam generators. Waste heat boilers are heat exchangers generating steam from incoming hot exhaust gas from an industrial (e.g., thermal oxidizer, kiln, furnace) or power (e.g., combustion turbine, engine) equipment. Duct burners are sometimes used to increase the temperature of the incoming hot exhaust gas.

Waste heat process heater means an enclosed device that recovers normally unused energy (i.e., hot exhaust gas) and converts it to usable heat. Waste heat process heaters are also referred to as recuperative process heaters. This definition includes both fired and unfired waste heat process heaters.

Wet scrubber means any add-on air pollution control device that mixes an aqueous stream or slurry with the exhaust gases from a boiler or process heater to control emissions of particulate matter or to absorb and neutralize acid gases, such as hydrogen chloride. A wet scrubber creates an aqueous stream or slurry as a byproduct of the emissions control process.

Work practice standard means any design, equipment, work practice, or operational standard, or combination thereof, that is promulgated pursuant to section 112(h) of the Clean Air Act.

[78 FR 15664, Mar. 21, 2011, as amended at 78 FR 7163, Jan. 31, 2013]

Table 1 to Subpart DDDDD of Part 63—Emission Limits for New or Reconstructed Boilers and Process Heaters

As stated in §63.7500, you must comply with the following applicable emission limits:

[Units with heat input capacity of 10 million Btu per hour or greater]

If your boiler or process heater is in this subcategory . . .	For the following pollutants . . .	The emissions must not exceed the following emission limits, except during startup and shutdown . . .	Or the emissions must not exceed the following alternative output-based limits, except during startup and shutdown . . .	Using this specified sampling volume or test run duration . . .
1. Units in all subcategories designed to burn solid fuel.	a. HCl	2.2E-02 lb per MMBtu of heat input	2.5E-02 lb per MMBtu of steam output or 0.28 lb per MWh	For M26A, collect a minimum of 1 dscm per run; for M26 collect a minimum of 120 liters per run.

	b. Mercury	8.0E-07 ^a lb per MMBtu of heat input	8.7E-07 ^a lb per MMBtu of steam output or 1.1E-05 ^a lb per MWh	For M29, collect a minimum of 4 dscm per run; for M30A or M30B, collect a minimum sample as specified in the method; for ASTM D6784 ^b collect a minimum of 4 dscm.
2. Units designed to burn coal/solid fossil fuel	a. Filterable PM (or TSM)	1.1E-03 lb per MMBtu of heat input; or (2.3E-05 lb per MMBtu of heat input)	1.1E-03 lb per MMBtu of steam output or 1.4E-02 lb per MWh; or (2.7E-05 lb per MMBtu of steam output or 2.9E-04 lb per MWh)	Collect a minimum of 3 dscm per run.
3. Pulverized coal boilers designed to burn coal/solid fossil fuel	a. Carbon monoxide (CO) (or CEMS)	130 ppm by volume on a dry basis corrected to 3 percent oxygen, 3-run average; or (320 ppm by volume on a dry basis corrected to 3 percent oxygen, 30-day rolling average)	0.11 lb per MMBtu of steam output or 1.4 lb per MWh; 3-run average	1 hr minimum sampling time.
4. Stokers designed to burn coal/solid fossil fuel	a. CO (or CEMS)	130 ppm by volume on a dry basis corrected to 3 percent oxygen, 3-run average; or (340 ppm by volume on a dry basis corrected to 3 percent oxygen, 30-day rolling average)	0.12 lb per MMBtu of steam output or 1.4 lb per MWh; 3-run average	1 hr minimum sampling time.
5. Fluidized bed units designed to burn coal/solid fossil fuel	a. CO (or CEMS)	130 ppm by volume on a dry basis corrected to 3 percent oxygen, 3-run average; or (230 ppm by volume on a dry basis corrected	0.11 lb per MMBtu of steam output or 1.4 lb per MWh; 3-run average	1 hr minimum sampling time.

		to 3 percent oxygen, 30-day rolling average)		
6. Fluidized bed units with an integrated heat exchanger designed to burn coal/solid fossil fuel	a. CO (or CEMS)	140 ppm by volume on a dry basis corrected to 3 percent oxygen, 3-run average; or (150 ppm by volume on a dry basis corrected to 3 percent oxygen, 30-day rolling average)	1.2E-01 lb per MMBtu of steam output or 1.5 lb per MWh; 3-run average	1 hr minimum sampling time.
7. Stokers/sloped grate/others designed to burn wet biomass fuel	a. CO (or CEMS)	620 ppm by volume on a dry basis corrected to 3 percent oxygen, 3-run average; or (390 ppm by volume on a dry basis corrected to 3 percent oxygen, 30-day rolling average)	5.8E-01 lb per MMBtu of steam output or 6.8 lb per MWh; 3-run average	1 hr minimum sampling time.
	b. Filterable PM (or TSM)	3.0E-02 lb per MMBtu of heat input; or (2.6E-05 lb per MMBtu of heat input)	3.5E-02 lb per MMBtu of steam output or 4.2E-01 lb per MWh; or (2.7E-05 lb per MMBtu of steam output or 3.7E-04 lb per MWh)	Collect a minimum of 2 dscm per run.
8. Stokers/sloped grate/others designed to burn kiln-dried biomass fuel	a. CO	460 ppm by volume on a dry basis corrected to 3 percent oxygen	4.2E-01 lb per MMBtu of steam output or 5.1 lb per MWh	1 hr minimum sampling time.
	b. Filterable PM (or TSM)	3.0E-02 lb per MMBtu of heat input; or (4.0E-03 lb per MMBtu of heat input)	3.5E-02 lb per MMBtu of steam output or 4.2E-01 lb per MWh; or (4.2E-03 lb per MMBtu of steam output or 5.6E-02	Collect a minimum of 2 dscm per run.

			lb per MWh)	
9. Fluidized bed units designed to burn biomass/bio-based solids	a. CO (or CEMS)	230 ppm by volume on a dry basis corrected to 3 percent oxygen, 3-run average; or (310 ppm by volume on a dry basis corrected to 3 percent oxygen, 30-day rolling average)	2.2E-01 lb per MMBtu of steam output or 2.6 lb per MWh; 3-run average	1 hr minimum sampling time.
	b. Filterable PM (or TSM)	9.8E-03 lb per MMBtu of heat input; or (8.3E-05 ^a lb per MMBtu of heat input)	1.2E-02 lb per MMBtu of steam output or 0.14 lb per MWh; or (1.1E-04 ^a lb per MMBtu of steam output or 1.2E-03 ^a lb per MWh)	Collect a minimum of 3 dscm per run.
10. Suspension burners designed to burn biomass/bio-based solids	a. CO (or CEMS)	2,400 ppm by volume on a dry basis corrected to 3 percent oxygen, 3-run average; or (2,000 ppm by volume on a dry basis corrected to 3 percent oxygen, 10-day rolling average)	1.9 lb per MMBtu of steam output or 27 lb per MWh; 3-run average	1 hr minimum sampling time.
	b. Filterable PM (or TSM)	3.0E-02 lb per MMBtu of heat input; or (6.5E-03 lb per MMBtu of heat input)	3.1E-02 lb per MMBtu of steam output or 4.2E-01 lb per MWh; or (6.6E-03 lb per MMBtu of steam output or 9.1E-02 lb per MWh)	Collect a minimum of 2 dscm per run.
11. Dutch Ovens/Pile burners designed to burn biomass/bio-based solids	a. CO (or CEMS)	330 ppm by volume on a dry basis corrected to 3 percent oxygen, 3-run average; or (520 ppm by volume on a	3.5E-01 lb per MMBtu of steam output or 3.6 lb per MWh; 3-run average	1 hr minimum sampling time.

		dry basis corrected to 3 percent oxygen, 10-day rolling average)		
	b. Filterable PM (or TSM)	3.2E-03 lb per MMBtu of heat input; or (3.9E-05 lb per MMBtu of heat input)	4.3E-03 lb per MMBtu of steam output or 4.5E-02 lb per MWh; or (5.2E-05 lb per MMBtu of steam output or 5.5E-04 lb per MWh)	Collect a minimum of 3 dscm per run.
12. Fuel cell units designed to burn biomass/bio-based solids	a. CO	910 ppm by volume on a dry basis corrected to 3 percent oxygen	1.1 lb per MMBtu of steam output or 1.0E+01 lb per MWh	1 hr minimum sampling time.
	b. Filterable PM (or TSM)	2.0E-02 lb per MMBtu of heat input; or (2.9E-05 ^a lb per MMBtu of heat input)	3.0E-02 lb per MMBtu of steam output or 2.8E-01 lb per MWh; or (5.1E-05 lb per MMBtu of steam output or 4.1E-04 lb per MWh)	Collect a minimum of 2 dscm per run.
13. Hybrid suspension grate boiler designed to burn biomass/bio-based solids	a. CO (or CEMS)	1,100 ppm by volume on a dry basis corrected to 3 percent oxygen, 3-run average; or (900 ppm by volume on a dry basis corrected to 3 percent oxygen, 30-day rolling average)	1.4 lb per MMBtu of steam output or 12 lb per MWh; 3-run average	1 hr minimum sampling time.
	b. Filterable PM (or TSM)	2.6E-02 lb per MMBtu of heat input; or (4.4E-04 lb per MMBtu of heat input)	3.3E-02 lb per MMBtu of steam output or 3.7E-01 lb per MWh; or (5.5E-04 lb per MMBtu of steam output or 6.2E-03 lb per MWh)	Collect a minimum of 3 dscm per run.
14. Units designed	a. HCl	4.4E-04 lb per	4.8E-04 lb per	For M26A: Collect a

to burn liquid fuel		MMBtu of heat input	MMBtu of steam output or 6.1E-03 lb per MWh	minimum of 2 dscm per run; for M26, collect a minimum of 240 liters per run.
	b. Mercury	4.8E-07 ^a lb per MMBtu of heat input	5.3E-07 ^a lb per MMBtu of steam output or 6.7E-06 ^a lb per MWh	For M29, collect a minimum of 4 dscm per run; for M30A or M30B, collect a minimum sample as specified in the method; for ASTM D6784 ^b collect a minimum of 4 dscm.
15. Units designed to burn heavy liquid fuel	a. CO	130 ppm by volume on a dry basis corrected to 3 percent oxygen, 3-run average	0.13 lb per MMBtu of steam output or 1.4 lb per MWh; 3-run average	1 hr minimum sampling time.
	b. Filterable PM (or TSM)	1.3E-02 lb per MMBtu of heat input; or (7.5E-05 lb per MMBtu of heat input)	1.5E-02 lb per MMBtu of steam output or 1.8E-01 lb per MWh; or (8.2E-05 lb per MMBtu of steam output or 1.1E-03 lb per MWh)	Collect a minimum of 3 dscm per run.
16. Units designed to burn light liquid fuel	a. CO	130 ppm by volume on a dry basis corrected to 3 percent oxygen	0.13 lb per MMBtu of steam output or 1.4 lb per MWh	1 hr minimum sampling time.
	b. Filterable PM (or TSM)	1.1E-03 ^a lb per MMBtu of heat input; or (2.9E-05 lb per MMBtu of heat input)	1.2E-03 ^a lb per MMBtu of steam output or 1.6E-02 ^a lb per MWh; or (3.2E-05 lb per MMBtu of steam output or 4.0E-04 lb per MWh)	Collect a minimum of 3 dscm per run.
17. Units designed to burn liquid fuel that are non-continental units	a. CO	130 ppm by volume on a dry basis corrected to 3 percent oxygen, 3-run average based	0.13 lb per MMBtu of steam output or 1.4 lb per MWh; 3-run average	1 hr minimum sampling time.

		on stack test		
	b. Filterable PM (or TSM)	2.3E-02 lb per MMBtu of heat input; or (8.6E-04 lb per MMBtu of heat input)	2.5E-02 lb per MMBtu of steam output or 3.2E-01 lb per MWh; or (9.4E-04 lb per MMBtu of steam output or 1.2E-02 lb per MWh)	Collect a minimum of 4 dscm per run.
18. Units designed to burn gas 2 (other) gases	a. CO	130 ppm by volume on a dry basis corrected to 3 percent oxygen	0.16 lb per MMBtu of steam output or 1.0 lb per MWh	1 hr minimum sampling time.
	b. HCl	1.7E-03 lb per MMBtu of heat input	2.9E-03 lb per MMBtu of steam output or 1.8E-02 lb per MWh	For M26A, Collect a minimum of 2 dscm per run; for M26, collect a minimum of 240 liters per run.
	c. Mercury	7.9E-06 lb per MMBtu of heat input	1.4E-05 lb per MMBtu of steam output or 8.3E-05 lb per MWh	For M29, collect a minimum of 3 dscm per run; for M30A or M30B, collect a minimum sample as specified in the method; for ASTM D6784 ^b collect a minimum of 3 dscm.
	d. Filterable PM (or TSM)	6.7E-03 lb per MMBtu of heat input; or (2.1E-04 lb per MMBtu of heat input)	1.2E-02 lb per MMBtu of steam output or 7.0E-02 lb per MWh; or (3.5E-04 lb per MMBtu of steam output or 2.2E-03 lb per MWh)	Collect a minimum of 3 dscm per run.

^aIf you are conducting stack tests to demonstrate compliance and your performance tests for this pollutant for at least 2 consecutive years show that your emissions are at or below this limit, you can skip testing according to §63.7515 if all of the other provisions of §63.7515 are met. For all other pollutants that do not contain a footnote “a”, your performance tests for this pollutant for at least 2 consecutive years must show that your emissions are at or below 75 percent of this limit in order to qualify for skip testing.

^bIncorporated by reference, see §63.14.

°If your affected source is a new or reconstructed affected source that commenced construction or reconstruction after June 4, 2010, and before January 31, 2013, you may comply with the emission limits in Tables 11, 12 or 13 to this subpart until January 31, 2016. On and after January 31, 2016, you must comply with the emission limits in Table 1 to this subpart.

[78 FR 7193, Jan. 31, 2013]

Table 2 to Subpart DDDDD of Part 63—Emission Limits for Existing Boilers and Process Heaters

As stated in §63.7500, you must comply with the following applicable emission limits:

[Units with heat input capacity of 10 million Btu per hour or greater]

If your boiler or process heater is in this subcategory . . .	For the following pollutants . . .	The emissions must not exceed the following emission limits, except during startup and shutdown . . .	The emissions must not exceed the following alternative output-based limits, except during startup and shutdown . . .	Using this specified sampling volume or test run duration . . .
1. Units in all subcategories designed to burn solid fuel	a. HCl	2.2E-02 lb per MMBtu of heat input	2.5E-02 lb per MMBtu of steam output or 0.27 lb per MWh	For M26A, Collect a minimum of 1 dscm per run; for M26, collect a minimum of 120 liters per run.
	b. Mercury	5.7E-06 lb per MMBtu of heat input	6.4E-06 lb per MMBtu of steam output or 7.3E-05 lb per MWh	For M29, collect a minimum of 3 dscm per run; for M30A or M30B, collect a minimum sample as specified in the method; for ASTM D6784 ^b collect a minimum of 3 dscm.
2. Units design to burn coal/solid fossil fuel	a. Filterable PM (or TSM)	4.0E-02 lb per MMBtu of heat input; or (5.3E-05 lb per MMBtu of heat input)	4.2E-02 lb per MMBtu of steam output or 4.9E-01 lb per MWh; or (5.6E-05 lb per MMBtu of steam output or 6.5E-04 lb per MWh)	Collect a minimum of 2 dscm per run.
3. Pulverized coal	a. CO (or	130 ppm by volume	0.11 lb per	1 hr minimum sampling

boilers designed to burn coal/solid fossil fuel	CEMS)	on a dry basis corrected to 3 percent oxygen, 3-run average; or (320 ppm by volume on a dry basis corrected to 3 percent oxygen, 30-day rolling average)	MMBtu of steam output or 1.4 lb per MWh; 3-run average	time.
4. Stokers designed to burn coal/solid fossil fuel	a. CO (or CEMS)	160 ppm by volume on a dry basis corrected to 3 percent oxygen, 3-run average; or (340 ppm by volume on a dry basis corrected to 3 percent oxygen, 30-day rolling average)	0.14 lb per MMBtu of steam output or 1.7 lb per MWh; 3-run average	1 hr minimum sampling time.
5. Fluidized bed units designed to burn coal/solid fossil fuel	a. CO (or CEMS)	130 ppm by volume on a dry basis corrected to 3 percent oxygen, 3-run average; or (230 ppm by volume on a dry basis corrected to 3 percent oxygen, 30-day rolling average)	0.12 lb per MMBtu of steam output or 1.4 lb per MWh; 3-run average	1 hr minimum sampling time.
6. Fluidized bed units with an integrated heat exchanger designed to burn coal/solid fossil fuel	a. CO (or CEMS)	140 ppm by volume on a dry basis corrected to 3 percent oxygen, 3-run average; or (150 ppm by volume on a dry basis corrected to 3 percent oxygen, 30-day rolling average)	1.3E-01 lb per MMBtu of steam output or 1.5 lb per MWh; 3-run average	1 hr minimum sampling time.
7. Stokers/sloped grate/others designed to burn wet biomass fuel	a. CO (or CEMS)	1,500 ppm by volume on a dry basis corrected to 3 percent oxygen, 3-run average; or (720	1.4 lb per MMBtu of steam output or 17 lb per MWh; 3-run average	1 hr minimum sampling time.

		ppm by volume on a dry basis corrected to 3 percent oxygen, 30-day rolling average)		
	b. Filterable PM (or TSM)	3.7E-02 lb per MMBtu of heat input; or (2.4E-04 lb per MMBtu of heat input)	4.3E-02 lb per MMBtu of steam output or 5.2E-01 lb per MWh; or (2.8E-04 lb per MMBtu of steam output or 3.4E-04 lb per MWh)	Collect a minimum of 2 dscm per run.
8. Stokers/sloped grate/others designed to burn kiln-dried biomass fuel	a. CO	460 ppm by volume on a dry basis corrected to 3 percent oxygen	4.2E-01 lb per MMBtu of steam output or 5.1 lb per MWh	1 hr minimum sampling time.
	b. Filterable PM (or TSM)	3.2E-01 lb per MMBtu of heat input; or (4.0E-03 lb per MMBtu of heat input)	3.7E-01 lb per MMBtu of steam output or 4.5 lb per MWh; or (4.6E-03 lb per MMBtu of steam output or 5.6E-02 lb per MWh)	Collect a minimum of 1 dscm per run.
9. Fluidized bed units designed to burn biomass/bio-based solid	a. CO (or CEMS)	470 ppm by volume on a dry basis corrected to 3 percent oxygen, 3-run average; or (310 ppm by volume on a dry basis corrected to 3 percent oxygen, 30-day rolling average)	4.6E-01 lb per MMBtu of steam output or 5.2 lb per MWh; 3-run average	1 hr minimum sampling time.
	b. Filterable PM (or TSM)	1.1E-01 lb per MMBtu of heat input; or (1.2E-03 lb per MMBtu of heat input)	1.4E-01 lb per MMBtu of steam output or 1.6 lb per MWh; or (1.5E-03 lb per MMBtu of steam output or 1.7E-02 lb per	Collect a minimum of 1 dscm per run.

			MWh)	
10. Suspension burners designed to burn biomass/bio-based solid	a. CO (or CEMS)	2,400 ppm by volume on a dry basis corrected to 3 percent oxygen, 3-run average; or (2,000 ppm by volume on a dry basis corrected to 3 percent oxygen, 10-day rolling average)	1.9 lb per MMBtu of steam output or 27 lb per MWh; 3-run average	1 hr minimum sampling time.
	b. Filterable PM (or TSM)	5.1E-02 lb per MMBtu of heat input; or (6.5E-03 lb per MMBtu of heat input)	5.2E-02 lb per MMBtu of steam output or 7.1E-01 lb per MWh; or (6.6E-03 lb per MMBtu of steam output or 9.1E-02 lb per MWh)	Collect a minimum of 2 dscm per run.
11. Dutch Ovens/Pile burners designed to burn biomass/bio-based solid	a. CO (or CEMS)	770 ppm by volume on a dry basis corrected to 3 percent oxygen, 3-run average; or (520 ppm by volume on a dry basis corrected to 3 percent oxygen, 10-day rolling average)	8.4E-01 lb per MMBtu of steam output or 8.4 lb per MWh; 3-run average	1 hr minimum sampling time.
	b. Filterable PM (or TSM)	2.8E-01 lb per MMBtu of heat input; or (2.0E-03 lb per MMBtu of heat input)	3.9E-01 lb per MMBtu of steam output or 3.9 lb per MWh; or (2.8E-03 lb per MMBtu of steam output or 2.8E-02 lb per MWh)	Collect a minimum of 1 dscm per run.
12. Fuel cell units designed to burn biomass/bio-based solid	a. CO	1,100 ppm by volume on a dry basis corrected to 3 percent oxygen	2.4 lb per MMBtu of steam output or 12 lb per MWh	1 hr minimum sampling time.
	b. Filterable	2.0E-02 lb per MMBtu of heat	5.5E-02 lb per MMBtu of steam	Collect a minimum of 2 dscm per run.

	PM (or TSM)	input; or (5.8E-03 lb per MMBtu of heat input)	output or 2.8E-01 lb per MWh; or (1.6E-02 lb per MMBtu of steam output or 8.1E-02 lb per MWh)	
13. Hybrid suspension grate units designed to burn biomass/bio-based solid	a. CO (or CEMS)	2,800 ppm by volume on a dry basis corrected to 3 percent oxygen, 3-run average; or (900 ppm by volume on a dry basis corrected to 3 percent oxygen, 30-day rolling average)	2.8 lb per MMBtu of steam output or 31 lb per MWh; 3-run average	1 hr minimum sampling time.
	b. Filterable PM (or TSM)	4.4E-01 lb per MMBtu of heat input; or (4.5E-04 lb per MMBtu of heat input)	5.5E-01 lb per MMBtu of steam output or 6.2 lb per MWh; or (5.7E-04 lb per MMBtu of steam output or 6.3E-03 lb per MWh)	Collect a minimum of 1 dscm per run.
14. Units designed to burn liquid fuel	a. HCl	1.1E-03 lb per MMBtu of heat input	1.4E-03 lb per MMBtu of steam output or 1.6E-02 lb per MWh	For M26A, collect a minimum of 2 dscm per run; for M26, collect a minimum of 240 liters per run.
	b. Mercury	2.0E-06 lb per MMBtu of heat input	2.5E-06 lb per MMBtu of steam output or 2.8E-05 lb per MWh	For M29, collect a minimum of 3 dscm per run; for M30A or M30B collect a minimum sample as specified in the method, for ASTM D6784 ^b collect a minimum of 2 dscm.
15. Units designed to burn heavy liquid fuel	a. CO	130 ppm by volume on a dry basis corrected to 3 percent oxygen, 3-run average	0.13 lb per MMBtu of steam output or 1.4 lb per MWh; 3-run average	1 hr minimum sampling time.
	b.	6.2E-02 lb per	7.5E-02 lb per	Collect a minimum of 1

	Filterable PM (or TSM)	MMBtu of heat input; or (2.0E-04 lb per MMBtu of heat input)	MMBtu of steam output or 8.6E-01 lb per MWh; or (2.5E-04 lb per MMBtu of steam output or 2.8E-03 lb per MWh)	dscm per run.
16. Units designed to burn light liquid fuel	a. CO	130 ppm by volume on a dry basis corrected to 3 percent oxygen	0.13 lb per MMBtu of steam output or 1.4 lb per MWh	1 hr minimum sampling time.
	b. Filterable PM (or TSM)	7.9E-03 lb per MMBtu of heat input; or (6.2E-05 lb per MMBtu of heat input)	9.6E-03 lb per MMBtu of steam output or 1.1E-01 lb per MWh; or (7.5E-05 lb per MMBtu of steam output or 8.6E-04 lb per MWh)	Collect a minimum of 3 dscm per run.
17. Units designed to burn liquid fuel that are non-continental units	a. CO	130 ppm by volume on a dry basis corrected to 3 percent oxygen, 3-run average based on stack test	0.13 lb per MMBtu of steam output or 1.4 lb per MWh; 3-run average	1 hr minimum sampling time.
	b. Filterable PM (or TSM)	2.7E-01 lb per MMBtu of heat input; or (8.6E-04 lb per MMBtu of heat input)	3.3E-01 lb per MMBtu of steam output or 3.8 lb per MWh; or (1.1E-03 lb per MMBtu of steam output or 1.2E-02 lb per MWh)	Collect a minimum of 2 dscm per run.
18. Units designed to burn gas 2 (other) gases	a. CO	130 ppm by volume on a dry basis corrected to 3 percent oxygen	0.16 lb per MMBtu of steam output or 1.0 lb per MWh	1 hr minimum sampling time.
	b. HCl	1.7E-03 lb per MMBtu of heat input	2.9E-03 lb per MMBtu of steam output or 1.8E-02 lb per MWh	For M26A, collect a minimum of 2 dscm per run; for M26, collect a minimum of 240 liters per run.

	c. Mercury	7.9E-06 lb per MMBtu of heat input	1.4E-05 lb per MMBtu of steam output or 8.3E-05 lb per MWh	For M29, collect a minimum of 3 dscm per run; for M30A or M30B, collect a minimum sample as specified in the method; for ASTM D6784 ^b collect a minimum of 2 dscm.
	d. Filterable PM (or TSM)	6.7E-03 lb per MMBtu of heat input or (2.1E-04 lb per MMBtu of heat input)	1.2E-02 lb per MMBtu of steam output or 7.0E-02 lb per MWh; or (3.5E-04 lb per MMBtu of steam output or 2.2E-03 lb per MWh)	Collect a minimum of 3 dscm per run.

^aIf you are conducting stack tests to demonstrate compliance and your performance tests for this pollutant for at least 2 consecutive years show that your emissions are at or below this limit, you can skip testing according to §63.7515 if all of the other provisions of §63.7515 are met. For all other pollutants that do not contain a footnote a, your performance tests for this pollutant for at least 2 consecutive years must show that your emissions are at or below 75 percent of this limit in order to qualify for skip testing.

^bIncorporated by reference, see §63.14.

[78 FR 7195, Jan. 31, 2013]

Table 3 to Subpart DDDDD of Part 63—Work Practice Standards

As stated in §63.7500, you must comply with the following applicable work practice standards:

If your unit is . . .	You must meet the following . . .
1. A new or existing boiler or process heater with a continuous oxygen trim system that maintains an optimum air to fuel ratio, or a heat input capacity of less than or equal to 5 million Btu per hour in any of the following subcategories: unit designed to burn gas 1; unit designed to burn gas 2 (other); or unit designed to burn light liquid, or a limited use boiler or process heater	Conduct a tune-up of the boiler or process heater every 5 years as specified in §63.7540.
2. A new or existing boiler or process heater without a continuous oxygen trim system and with heat input capacity of less than 10 million	Conduct a tune-up of the boiler or process heater biennially as specified in §63.7540.

<p>Btu per hour in the unit designed to burn heavy liquid or unit designed to burn solid fuel subcategories; or a new or existing boiler or process heater with heat input capacity of less than 10 million Btu per hour, but greater than 5 million Btu per hour, in any of the following subcategories: unit designed to burn gas 1; unit designed to burn gas 2 (other); or unit designed to burn light liquid</p>	
<p>3. A new or existing boiler or process heater without a continuous oxygen trim system and with heat input capacity of 10 million Btu per hour or greater</p>	<p>Conduct a tune-up of the boiler or process heater annually as specified in §63.7540. Units in either the Gas 1 or Metal Process Furnace subcategories will conduct this tune-up as a work practice for all regulated emissions under this subpart. Units in all other subcategories will conduct this tune-up as a work practice for dioxins/furans.</p>
<p>4. An existing boiler or process heater located at a major source facility, not including limited use units</p>	<p>Must have a one-time energy assessment performed by a qualified energy assessor. An energy assessment completed on or after January 1, 2008, that meets or is amended to meet the energy assessment requirements in this table, satisfies the energy assessment requirement. A facility that operates under an energy management program compatible with ISO 50001 that includes the affected units also satisfies the energy assessment requirement. The energy assessment must include the following with extent of the evaluation for items a. to e. appropriate for the on-site technical hours listed in §63.7575:</p>
	<p>a. A visual inspection of the boiler or process heater system.</p>
	<p>b. An evaluation of operating characteristics of the boiler or process heater systems, specifications of energy using systems, operating and maintenance procedures, and unusual operating constraints.</p>
	<p>c. An inventory of major energy use systems consuming energy from affected boilers and process heaters and which are under the control of the boiler/process heater owner/operator.</p>
	<p>d. A review of available architectural and engineering plans, facility operation and</p>

	<p>maintenance procedures and logs, and fuel usage.</p>
	<p>e. A review of the facility's energy management practices and provide recommendations for improvements consistent with the definition of energy management practices, if identified.</p>
	<p>f. A list of cost-effective energy conservation measures that are within the facility's control.</p>
	<p>g. A list of the energy savings potential of the energy conservation measures identified.</p>
	<p>h. A comprehensive report detailing the ways to improve efficiency, the cost of specific improvements, benefits, and the time frame for recouping those investments.</p>
<p>5. An existing or new boiler or process heater subject to emission limits in Table 1 or 2 or 11 through 13 to this subpart during startup</p>	<p>You must operate all CMS during startup. For startup of a boiler or process heater, you must use one or a combination of the following clean fuels: natural gas, synthetic natural gas, propane, distillate oil, syngas, ultra-low sulfur diesel, fuel oil-soaked rags, kerosene, hydrogen, paper, cardboard, refinery gas, and liquefied petroleum gas.</p>
	<p>If you start firing coal/solid fossil fuel, biomass/bio-based solids, heavy liquid fuel, or gas 2 (other) gases, you must vent emissions to the main stack(s) and engage all of the applicable control devices except limestone injection in fluidized bed combustion (FBC) boilers, dry scrubber, fabric filter, selective non-catalytic reduction (SNCR), and selective catalytic reduction (SCR). You must start your limestone injection in FBC boilers, dry scrubber, fabric filter, SNCR, and SCR systems as expeditiously as possible. Startup ends when steam or heat is supplied for any purpose.</p>
	<p>You must comply with all applicable emission limits at all times except for startup or shutdown periods conforming with this work practice. You must collect monitoring data during periods of startup, as specified in §63.7535(b). You must keep records during periods of startup. You must provide reports concerning activities and periods of startup, as specified in §63.7555.</p>

6. An existing or new boiler or process heater subject to emission limits in Tables 1 or 2 or 11 through 13 to this subpart during shutdown	You must operate all CMS during shutdown. While firing coal/solid fossil fuel, biomass/bio-based solids, heavy liquid fuel, or gas 2 (other) gases during shutdown, you must vent emissions to the main stack(s) and operate all applicable control devices, except limestone injection in FBC boilers, dry scrubber, fabric filter, SNCR, and SCR.
	You must comply with all applicable emissions limits at all times except for startup or shutdown periods conforming with this work practice. You must collect monitoring data during periods of shutdown, as specified in §63.7535(b). You must keep records during periods of shutdown. You must provide reports concerning activities and periods of shutdown, as specified in §63.7555.

[78 FR 7198, Jan. 31, 2013]

Table 4 to Subpart DDDDD of Part 63—Operating Limits for Boilers and Process Heaters

As stated in §63.7500, you must comply with the applicable operating limits:

When complying with a Table 1, 2, 11, 12, or 13 numerical emission limit using . . .	You must meet these operating limits . . .
1. Wet PM scrubber control on a boiler not using a PM CPMS	Maintain the 30-day rolling average pressure drop and the 30-day rolling average liquid flow rate at or above the lowest one-hour average pressure drop and the lowest one-hour average liquid flow rate, respectively, measured during the most recent performance test demonstrating compliance with the PM emission limitation according to §63.7530(b) and Table 7 to this subpart.
2. Wet acid gas (HCl) scrubber control on a boiler not using a HCl CEMS	Maintain the 30-day rolling average effluent pH at or above the lowest one-hour average pH and the 30-day rolling average liquid flow rate at or above the lowest one-hour average liquid flow rate measured during the most recent performance test demonstrating compliance with the HCl emission limitation according to §63.7530(b) and Table 7 to this subpart.
3. Fabric filter control on units not using a PM CPMS	a. Maintain opacity to less than or equal to 10 percent opacity (daily block average); or
	b. Install and operate a bag leak detection system according to

	§63.7525 and operate the fabric filter such that the bag leak detection system alert is not activated more than 5 percent of the operating time during each 6-month period.
4. Electrostatic precipitator control on units not using a PM CPMS	a. This option is for boilers and process heaters that operate dry control systems (i.e., an ESP without a wet scrubber). Existing and new boilers and process heaters must maintain opacity to less than or equal to 10 percent opacity (daily block average); or
	b. This option is only for boilers and process heaters not subject to PM CPMS or continuous compliance with an opacity limit (i.e., COMS). Maintain the 30-day rolling average total secondary electric power input of the electrostatic precipitator at or above the operating limits established during the performance test according to §63.7530(b) and Table 7 to this subpart.
5. Dry scrubber or carbon injection control on a boiler not using a mercury CEMS	Maintain the minimum sorbent or carbon injection rate as defined in §63.7575 of this subpart.
6. Any other add-on air pollution control type on units not using a PM CPMS	This option is for boilers and process heaters that operate dry control systems. Existing and new boilers and process heaters must maintain opacity to less than or equal to 10 percent opacity (daily block average).
7. Fuel analysis	Maintain the fuel type or fuel mixture such that the applicable emission rates calculated according to §63.7530(c)(1), (2) and/or (3) is less than the applicable emission limits.
8. Performance testing	For boilers and process heaters that demonstrate compliance with a performance test, maintain the operating load of each unit such that it does not exceed 110 percent of the highest hourly average operating load recorded during the most recent performance test.
9. Oxygen analyzer system	For boilers and process heaters subject to a CO emission limit that demonstrate compliance with an O ₂ analyzer system as specified in §63.7525(a), maintain the 30-day rolling average oxygen content at or above the lowest hourly average oxygen concentration measured during the most recent CO performance test, as specified in Table 8. This requirement does not apply to units that install an oxygen trim system since these units will set the trim system to the level specified in §63.7525(a).
10. SO ₂ CEMS	For boilers or process heaters subject to an HCl emission limit that demonstrate compliance with an SO ₂ CEMS, maintain the 30-day rolling average SO ₂ emission rate at or below the highest hourly average SO ₂ concentration measured during the most recent HCl performance test, as specified in Table 8.

Table 5 to Subpart DDDDD of Part 63—Performance Testing Requirements

As stated in §63.7520, you must comply with the following requirements for performance testing for existing, new or reconstructed affected sources:

To conduct a performance test for the following pollutant...	You must...	Using...
1. Filterable PM	a. Select sampling ports location and the number of traverse points	Method 1 at 40 CFR part 60, appendix A-1 of this chapter.
	b. Determine velocity and volumetric flow-rate of the stack gas	Method 2, 2F, or 2G at 40 CFR part 60, appendix A-1 or A-2 to part 60 of this chapter.
	c. Determine oxygen or carbon dioxide concentration of the stack gas	Method 3A or 3B at 40 CFR part 60, appendix A-2 to part 60 of this chapter, or ANSI/ASME PTC 19.10-1981. ^a
	d. Measure the moisture content of the stack gas	Method 4 at 40 CFR part 60, appendix A-3 of this chapter.
	e. Measure the PM emission concentration	Method 5 or 17 (positive pressure fabric filters must use Method 5D) at 40 CFR part 60, appendix A-3 or A-6 of this chapter.
	f. Convert emissions concentration to lb per MMBtu emission rates	Method 19 F-factor methodology at 40 CFR part 60, appendix A-7 of this chapter.
2. TSM	a. Select sampling ports location and the number of traverse points	Method 1 at 40 CFR part 60, appendix A-1 of this chapter.
	b. Determine velocity and volumetric flow-rate of the stack gas	Method 2, 2F, or 2G at 40 CFR part 60, appendix A-1 or A-2 of this chapter.
	c. Determine oxygen or carbon dioxide concentration of the stack gas	Method 3A or 3B at 40 CFR part 60, appendix A-1 of this chapter, or ANSI/ASME PTC 19.10-1981. ^a
	d. Measure the moisture content of the stack gas	Method 4 at 40 CFR part 60, appendix A-3 of this chapter.

	e. Measure the TSM emission concentration	Method 29 at 40 CFR part 60, appendix A-8 of this chapter
	f. Convert emissions concentration to lb per MMBtu emission rates	Method 19 F-factor methodology at 40 CFR part 60, appendix A-7 of this chapter.
3. Hydrogen chloride	a. Select sampling ports location and the number of traverse points	Method 1 at 40 CFR part 60, appendix A-1 of this chapter.
	b. Determine velocity and volumetric flow-rate of the stack gas	Method 2, 2F, or 2G at 40 CFR part 60, appendix A-2 of this chapter.
	c. Determine oxygen or carbon dioxide concentration of the stack gas	Method 3A or 3B at 40 CFR part 60, appendix A-2 of this chapter, or ANSI/ASME PTC 19.10-1981. ^a
	d. Measure the moisture content of the stack gas	Method 4 at 40 CFR part 60, appendix A-3 of this chapter.
	e. Measure the hydrogen chloride emission concentration	Method 26 or 26A (M26 or M26A) at 40 CFR part 60, appendix A-8 of this chapter.
	f. Convert emissions concentration to lb per MMBtu emission rates	Method 19 F-factor methodology at 40 CFR part 60, appendix A-7 of this chapter.
4. Mercury	a. Select sampling ports location and the number of traverse points	Method 1 at 40 CFR part 60, appendix A-1 of this chapter.
	b. Determine velocity and volumetric flow-rate of the stack gas	Method 2, 2F, or 2G at 40 CFR part 60, appendix A-1 or A-2 of this chapter.
	c. Determine oxygen or carbon dioxide concentration of the stack gas	Method 3A or 3B at 40 CFR part 60, appendix A-1 of this chapter, or ANSI/ASME PTC 19.10-1981. ^a
	d. Measure the moisture content of the stack gas	Method 4 at 40 CFR part 60, appendix A-3 of this chapter.
	e. Measure the mercury emission concentration	Method 29, 30A, or 30B (M29, M30A, or M30B) at 40 CFR part 60, appendix A-8 of this chapter or Method 101A at 40 CFR part 61, appendix B of this chapter, or ASTM Method

		D6784. ^a
	f. Convert emissions concentration to lb per MMBtu emission rates	Method 19 F-factor methodology at 40 CFR part 60, appendix A-7 of this chapter.
5. CO	a. Select the sampling ports location and the number of traverse points	Method 1 at 40 CFR part 60, appendix A-1 of this chapter.
	b. Determine oxygen concentration of the stack gas	Method 3A or 3B at 40 CFR part 60, appendix A-3 of this chapter, or ASTM D6522-00 (Reapproved 2005), or ANSI/ASME PTC 19.10-1981. ^a
	c. Measure the moisture content of the stack gas	Method 4 at 40 CFR part 60, appendix A-3 of this chapter.
	d. Measure the CO emission concentration	Method 10 at 40 CFR part 60, appendix A-4 of this chapter. Use a measurement span value of 2 times the concentration of the applicable emission limit.

[76 FR 15664, Mar. 21, 2011, as amended at 78 FR 7200, Jan. 31, 2013]

Table 6 to Subpart DDDDD of Part 63—Fuel Analysis Requirements

As stated in §63.7521, you must comply with the following requirements for fuel analysis testing for existing, new or reconstructed affected sources. However, equivalent methods (as defined in §63.7575) may be used in lieu of the prescribed methods at the discretion of the source owner or operator:

To conduct a fuel analysis for the following pollutant . . .	You must . . .	Using . . .
1. Mercury	a. Collect fuel samples	Procedure in §63.7521(c) or ASTM D5192 ^a , or ASTM D7430 ^a , or ASTM D6883 ^a , or ASTM D2234/D2234M ^a (for coal) or EPA 1631 or EPA 1631E or ASTM D6323 ^a (for solid), or EPA 821-R-01-013 (for liquid or solid), or ASTM D4177 ^a (for liquid), or ASTM D4057 ^a (for liquid), or equivalent.
	b. Composite fuel samples	Procedure in §63.7521(d) or equivalent.
	c. Prepare composited fuel samples	EPA SW-846-3050B ^a (for solid samples), EPA SW-846-3020A ^a (for liquid samples), ASTM D2013/D2013M ^a (for coal), ASTM D5198 ^a (for

		biomass), or EPA 3050 ^a (for solid fuel), or EPA 821-R-01-013 ^a (for liquid or solid), or equivalent.
	d. Determine heat content of the fuel type	ASTM D5865 ^a (for coal) or ASTM E711 ^a (for biomass), or ASTM D5864 ^a for liquids and other solids, or ASTM D240 ^a or equivalent.
	e. Determine moisture content of the fuel type	ASTM D3173 ^a , ASTM E871 ^a , or ASTM D5864 ^a , or ASTM D240, or ASTM D95 ^a (for liquid fuels), or ASTM D4006 ^a (for liquid fuels), or ASTM D4177 ^a (for liquid fuels) or ASTM D4057 ^a (for liquid fuels), or equivalent.
	f. Measure mercury concentration in fuel sample	ASTM D6722 ^a (for coal), EPA SW-846-7471B ^a (for solid samples), or EPA SW-846-7470A ^a (for liquid samples), or equivalent.
	g. Convert concentration into units of pounds of mercury per MMBtu of heat content	Equation 8 in §63.7530.
	h. Calculate the mercury emission rate from the boiler or process heater in units of pounds per million Btu	Equations 10 and 12 in §63.7530.
2. HCl	a. Collect fuel samples	Procedure in §63.7521(c) or ASTM D5192 ^a , or ASTM D7430 ^a , or ASTM D6883 ^a , or ASTM D2234/D2234M ^a (for coal) or ASTM D6323 ^a (for coal or biomass), ASTM D4177 ^a (for liquid fuels) or ASTM D4057 ^a (for liquid fuels), or equivalent.
	b. Composite fuel samples	Procedure in §63.7521(d) or equivalent.
	c. Prepare composited fuel samples	EPA SW-846-3050B ^a (for solid samples), EPA SW-846-3020A ^a (for liquid samples), ASTM D2013/D2013M ^a (for coal), or ASTM D5198 ^a (for biomass), or EPA 3050 ^a or equivalent.
	d. Determine heat content of the fuel type	ASTM D5865 ^a (for coal) or ASTM E711 ^a (for biomass), ASTM D5864, ASTM D240 ^a or equivalent.
	e. Determine moisture content of the fuel type	ASTM D3173 ^a or ASTM E871 ^a , or D5864 ^a , or ASTM D240 ^a , or ASTM D95 ^a (for liquid fuels), or ASTM D4006 ^a (for liquid fuels), or ASTM D4177 ^a (for liquid fuels) or ASTM D4057 ^a (for liquid fuels) or equivalent.

	f. Measure chlorine concentration in fuel sample	EPA SW-846-9250 ^a , ASTM D6721 ^a , ASTM D4208 ^a (for coal), or EPA SW-846-5050 ^a or ASTM E776 ^a (for solid fuel), or EPA SW-846-9056 ^a or SW-846-9076 ^a (for solids or liquids) or equivalent.
	g. Convert concentrations into units of pounds of HCl per MMBtu of heat content	Equation 7 in §63.7530.
	h. Calculate the HCl emission rate from the boiler or process heater in units of pounds per million Btu	Equations 10 and 11 in §63.7530.
3. Mercury Fuel Specification for other gas 1 fuels	a. Measure mercury concentration in the fuel sample and convert to units of micrograms per cubic meter	Method 30B (M30B) at 40 CFR part 60, appendix A-8 of this chapter or ASTM D5954 ^a , ASTM D6350 ^a , ISO 6978-1:2003(E) ^a , or ISO 6978-2:2003(E) ^a , or EPA-1631 ^a or equivalent.
	b. Measure mercury concentration in the exhaust gas when firing only the other gas 1 fuel is fired in the boiler or process heater	Method 29, 30A, or 30B (M29, M30A, or M30B) at 40 CFR part 60, appendix A-8 of this chapter or Method 101A or Method 102 at 40 CFR part 61, appendix B of this chapter, or ASTM Method D6784 ^a or equivalent.
4. TSM for solid fuels	a. Collect fuel samples	Procedure in §63.7521(c) or ASTM D5192 ^a , or ASTM D7430 ^a , or ASTM D6883 ^a , or ASTM D2234/D2234M ^a (for coal) or ASTM D6323 ^a (for coal or biomass), or ASTM D4177 ^a , (for liquid fuels) or ASTM D4057 ^a (for liquid fuels), or equivalent.
	b. Composite fuel samples	Procedure in §63.7521(d) or equivalent.
	c. Prepare composited fuel samples	EPA SW-846-3050B ^a (for solid samples), EPA SW-846-3020A ^a (for liquid samples), ASTM D2013/D2013M ^a (for coal), ASTM D5198 ^a or TAPPI T266 ^a (for biomass), or EPA 3050 ^a or equivalent.
	d. Determine heat content of the fuel type	ASTM D5865 ^a (for coal) or ASTM E711 ^a (for biomass), or ASTM D5864 ^a for liquids and other solids, or ASTM D240 ^a or equivalent.
	e. Determine moisture content of the fuel type	ASTM D3173 ^a or ASTM E871 ^a , or D5864, or ASTM D240 ^a , or ASTM D95 ^a (for liquid fuels), or

		ASTM D4006 ^a (for liquid fuels), or ASTM D4177 ^a (for liquid fuels) or ASTM D4057 ^a (for liquid fuels), or equivalent.
	f. Measure TSM concentration in fuel sample	ASTM D3683 ^a , or ASTM D4606 ^a , or ASTM D6357 ^a or EPA 200.8 ^a or EPA SW-846-6020 ^a , or EPA SW-846-6020A ^a , or EPA SW-846-6010C ^a , EPA 7060 ^a or EPA 7060A ^a (for arsenic only), or EPA SW-846-7740 ^a (for selenium only).
	g. Convert concentrations into units of pounds of TSM per MMBtu of heat content	Equation 9 in §63.7530.
	h. Calculate the TSM emission rate from the boiler or process heater in units of pounds per million Btu	Equations 10 and 13 in §63.7530.

^aIncorporated by reference, see §63.14.

[78 FR 7201, Jan. 31, 2013]

Table 7 to Subpart DDDDD of Part 63—Establishing Operating Limits

As stated in §63.7520, you must comply with the following requirements for establishing operating limits:

If you have an applicable emission limit for . . .	And your operating limits are based on . . .	You must . . .	Using . . .	According to the following requirements
1. PM, TSM, or mercury	a. Wet scrubber operating parameters	i. Establish a site-specific minimum scrubber pressure drop and minimum flow rate operating limit according to §63.7530(b)	(1) Data from the scrubber pressure drop and liquid flow rate monitors and the PM or mercury performance test	(a) You must collect scrubber pressure drop and liquid flow rate data every 15 minutes during the entire period of the performance tests.
				(b) Determine the lowest hourly average scrubber pressure drop and liquid

				flow rate by computing the hourly averages using all of the 15-minute readings taken during each performance test.
	b. Electrostatic precipitator operating parameters (option only for units that operate wet scrubbers)	i. Establish a site-specific minimum total secondary electric power input according to §63.7530(b)	(1) Data from the voltage and secondary amperage monitors during the PM or mercury performance test	(a) You must collect secondary voltage and secondary amperage for each ESP cell and calculate total secondary electric power input data every 15 minutes during the entire period of the performance tests.
				(b) Determine the average total secondary electric power input by computing the hourly averages using all of the 15-minute readings taken during each performance test.
2. HCl	a. Wet scrubber operating parameters	i. Establish site-specific minimum pressure drop, effluent pH, and flow rate operating limits according to §63.7530(b)	(1) Data from the pressure drop, pH, and liquid flow-rate monitors and the HCl performance test	(a) You must collect pH and liquid flow-rate data every 15 minutes during the entire period of the performance tests.
				(b) Determine the hourly average pH and liquid flow rate by computing the hourly averages using all of the 15-minute readings taken during each performance test.
	b. Dry scrubber operating parameters	i. Establish a site-specific minimum sorbent injection rate operating limit according to §63.7530(b). If	(1) Data from the sorbent injection rate monitors and HCl or mercury performance	(a) You must collect sorbent injection rate data every 15 minutes during the entire period of the performance tests.

		different acid gas sorbents are used during the HCl performance test, the average value for each sorbent becomes the site-specific operating limit for that sorbent	test	
				(b) Determine the hourly average sorbent injection rate by computing the hourly averages using all of the 15-minute readings taken during each performance test.
				(c) Determine the lowest hourly average of the three test run averages established during the performance test as your operating limit. When your unit operates at lower loads, multiply your sorbent injection rate by the load fraction (e.g., for 50 percent load, multiply the injection rate operating limit by 0.5) to determine the required injection rate.
	c. Alternative Maximum SO ₂ emission rate	i. Establish a site-specific maximum SO ₂ emission rate operating limit according to §63.7530(b)	(1) Data from SO ₂ CEMS and the HCl performance test	(a) You must collect the SO ₂ emissions data according to §63.7525(m) during the most recent HCl performance tests.
				(b) The maximum SO ₂ emission rate is equal to the lowest hourly average SO ₂ emission rate measured during the most recent HCl performance tests.

3. Mercury	a. Activated carbon injection	i. Establish a site-specific minimum activated carbon injection rate operating limit according to §63.7530(b)	(1) Data from the activated carbon rate monitors and mercury performance test	(a) You must collect activated carbon injection rate data every 15 minutes during the entire period of the performance tests.
				(b) Determine the hourly average activated carbon injection rate by computing the hourly averages using all of the 15-minute readings taken during each performance test.
				(c) Determine the lowest hourly average established during the performance test as your operating limit. When your unit operates at lower loads, multiply your activated carbon injection rate by the load fraction (e.g., actual heat input divided by heat input during performance test, for 50 percent load, multiply the injection rate operating limit by 0.5) to determine the required injection rate.
4. Carbon monoxide	a. Oxygen	i. Establish a unit-specific limit for minimum oxygen level according to §63.7520	(1) Data from the oxygen analyzer system specified in §63.7525(a)	(a) You must collect oxygen data every 15 minutes during the entire period of the performance tests.
				(b) Determine the hourly average oxygen concentration by computing the hourly averages using all of the 15-minute readings taken during each performance

				test.
				(c) Determine the lowest hourly average established during the performance test as your minimum operating limit.
5. Any pollutant for which compliance is demonstrated by a performance test	a. Boiler or process heater operating load	i. Establish a unit specific limit for maximum operating load according to §63.7520(c)	(1) Data from the operating load monitors or from steam generation monitors	(a) You must collect operating load or steam generation data every 15 minutes during the entire period of the performance test.
				(b) Determine the average operating load by computing the hourly averages using all of the 15-minute readings taken during each performance test.
				(c) Determine the average of the three test run averages during the performance test, and multiply this by 1.1 (110 percent) as your operating limit.

[76 FR 15664, Mar. 21, 2011, as amended at 78 FR 7203, Jan. 31, 2013]

Table 8 to Subpart DDDDD of Part 63—Demonstrating Continuous Compliance

As stated in §63.7540, you must show continuous compliance with the emission limitations for each boiler or process heater according to the following:

If you must meet the following operating limits or work practice standards ...	You must demonstrate continuous compliance by . . .
1. Opacity	a. Collecting the opacity monitoring system data according to §63.7525(c) and §63.7535; and
	b. Reducing the opacity monitoring data to 6-minute averages; and

	c. Maintaining opacity to less than or equal to 10 percent (daily block average).
2. PM CPMS	a. Collecting the PM CPMS output data according to §63.7525;
	b. Reducing the data to 30-day rolling averages; and
	c. Maintaining the 30-day rolling average PM CPMS output data to less than the operating limit established during the performance test according to §63.7530(b)(4).
3. Fabric Filter Bag Leak Detection Operation	Installing and operating a bag leak detection system according to §63.7525 and operating the fabric filter such that the requirements in §63.7540(a)(9) are met.
4. Wet Scrubber Pressure Drop and Liquid Flow-rate	a. Collecting the pressure drop and liquid flow rate monitoring system data according to §§63.7525 and 63.7535; and
	b. Reducing the data to 30-day rolling averages; and
	c. Maintaining the 30-day rolling average pressure drop and liquid flow-rate at or above the operating limits established during the performance test according to §63.7530(b).
5. Wet Scrubber pH	a. Collecting the pH monitoring system data according to §§63.7525 and 63.7535; and
	b. Reducing the data to 30-day rolling averages; and
	c. Maintaining the 30-day rolling average pH at or above the operating limit established during the performance test according to §63.7530(b).
6. Dry Scrubber Sorbent or Carbon Injection Rate	a. Collecting the sorbent or carbon injection rate monitoring system data for the dry scrubber according to §§63.7525 and 63.7535; and
	b. Reducing the data to 30-day rolling averages; and
	c. Maintaining the 30-day rolling average sorbent or carbon injection rate at or above the minimum sorbent or carbon injection rate as defined in §63.7575.
7. Electrostatic Precipitator Total Secondary Electric Power Input	a. Collecting the total secondary electric power input monitoring system data for the electrostatic precipitator according to §§63.7525 and 63.7535; and
	b. Reducing the data to 30-day rolling averages; and
	c. Maintaining the 30-day rolling average total secondary electric power input at or above the operating limits established during the performance test according to §63.7530(b).
8. Emission limits using fuel analysis	a. Conduct monthly fuel analysis for HCl or mercury or TSM according to Table 6 to this subpart; and

	b. Reduce the data to 12-month rolling averages; and
	c. Maintain the 12-month rolling average at or below the applicable emission limit for HCl or mercury or TSM in Tables 1 and 2 or 11 through 13 to this subpart.
9. Oxygen content	a. Continuously monitor the oxygen content using an oxygen analyzer system according to §63.7525(a). This requirement does not apply to units that install an oxygen trim system since these units will set the trim system to the level specified in §63.7525(a)(2).
	b. Reducing the data to 30-day rolling averages; and
	c. Maintain the 30-day rolling average oxygen content at or above the lowest hourly average oxygen level measured during the most recent CO performance test.
10. Boiler or process heater operating load	a. Collecting operating load data or steam generation data every 15 minutes.
	b. Maintaining the operating load such that it does not exceed 110 percent of the highest hourly average operating load recorded during the most recent performance test according to §63.7520(c).
11. SO ₂ emissions using SO ₂ CEMS	a. Collecting the SO ₂ CEMS output data according to §63.7525;
	b. Reducing the data to 30-day rolling averages; and
	c. Maintaining the 30-day rolling average SO ₂ CEMS emission rate to a level at or below the minimum hourly SO ₂ rate measured during the most recent HCl performance test according to §63.7530.

[78 FR 7204, Jan. 31, 2013]

Table 9 to Subpart DDDDD of Part 63—Reporting Requirements

As stated in §63.7550, you must comply with the following requirements for reports:

You must submit a(n)	The report must contain . . .	You must submit the report . . .
1. Compliance report	a. Information required in §63.7550(c)(1) through (5); and	Semiannually, annually, biennially, or every 5 years according to the requirements in §63.7550(b).
	b. If there are no deviations from any emission limitation	

	(emission limit and operating limit) that applies to you and there are no deviations from the requirements for work practice standards in Table 3 to this subpart that apply to you, a statement that there were no deviations from the emission limitations and work practice standards during the reporting period. If there were no periods during which the CMSs, including continuous emissions monitoring system, continuous opacity monitoring system, and operating parameter monitoring systems, were out-of-control as specified in §63.8(c)(7), a statement that there were no periods during which the CMSs were out-of-control during the reporting period; and	
	c. If you have a deviation from any emission limitation (emission limit and operating limit) where you are not using a CMS to comply with that emission limit or operating limit, or a deviation from a work practice standard during the reporting period, the report must contain the information in §63.7550(d); and	
	d. If there were periods during which the CMSs, including continuous emissions monitoring system, continuous opacity monitoring system, and operating parameter monitoring systems, were out-of-control as specified in §63.8(c)(7), or otherwise not operating, the report must contain the information in §63.7550(e)	

[76 FR 15664, Mar. 21, 2011, as amended at 78 FR 7205, Jan. 31, 2013]

Table 10 to Subpart DDDDD of Part 63—Applicability of General Provisions to Subpart DDDDD

As stated in §63.7565, you must comply with the applicable General Provisions according to the following:

Citation	Subject	Applies to subpart DDDDD
§63.1	Applicability	Yes.
§63.2	Definitions	Yes. Additional terms defined in §63.7575
§63.3	Units and Abbreviations	Yes.
§63.4	Prohibited Activities and Circumvention	Yes.
§63.5	Preconstruction Review and Notification Requirements	Yes.

§63.6(a), (b)(1)-(b)(5), (b)(7), (c)	Compliance with Standards and Maintenance Requirements	Yes.
§63.6(e)(1)(i)	General duty to minimize emissions.	No. See §63.7500(a)(3) for the general duty requirement.
§63.6(e)(1)(ii)	Requirement to correct malfunctions as soon as practicable.	No.
§63.6(e)(3)	Startup, shutdown, and malfunction plan requirements.	No.
§63.6(f)(1)	Startup, shutdown, and malfunction exemptions for compliance with non-opacity emission standards.	No.
§63.6(f)(2) and (3)	Compliance with non-opacity emission standards.	Yes.
§63.6(g)	Use of alternative standards	Yes.
§63.6(h)(1)	Startup, shutdown, and malfunction exemptions to opacity standards.	No. See §63.7500(a).
§63.6(h)(2) to (h)(9)	Determining compliance with opacity emission standards	Yes.
§63.6(i)	Extension of compliance	Yes. Note: Facilities may also request extensions of compliance for the installation of combined heat and power, waste heat recovery, or gas pipeline or fuel feeding infrastructure as a means of complying with this subpart.
§63.6(j)	Presidential exemption.	Yes.
§63.7(a), (b), (c), and (d)	Performance Testing Requirements	Yes.
§63.7(e)(1)	Conditions for	No. Subpart DDDDD specifies

	conducting performance tests	conditions for conducting performance tests at §63.7520(a) to (c).
§63.7(e)(2)-(e)(9), (f), (g), and (h)	Performance Testing Requirements	Yes.
§63.8(a) and (b)	Applicability and Conduct of Monitoring	Yes.
§63.8(c)(1)	Operation and maintenance of CMS	Yes.
§63.8(c)(1)(i)	General duty to minimize emissions and CMS operation	No. See §63.7500(a)(3).
§63.8(c)(1)(ii)	Operation and maintenance of CMS	Yes.
§63.8(c)(1)(iii)	Startup, shutdown, and malfunction plans for CMS	No.
§63.8(c)(2) to (c)(9)	Operation and maintenance of CMS	Yes.
§63.8(d)(1) and (2)	Monitoring Requirements, Quality Control Program	Yes.
§63.8(d)(3)	Written procedures for CMS	Yes, except for the last sentence, which refers to a startup, shutdown, and malfunction plan. Startup, shutdown, and malfunction plans are not required.
§63.8(e)	Performance evaluation of a CMS	Yes.
§63.8(f)	Use of an alternative monitoring method.	Yes.
§63.8(g)	Reduction of monitoring data	Yes.
§63.9	Notification Requirements	Yes.
§63.10(a), (b)(1)	Recordkeeping and Reporting Requirements	Yes.
§63.10(b)(2)(i)	Recordkeeping of	Yes.

	occurrence and duration of startups or shutdowns	
§63.10(b)(2)(ii)	Recordkeeping of malfunctions	No. See §63.7555(d)(7) for recordkeeping of occurrence and duration and §63.7555(d)(8) for actions taken during malfunctions.
§63.10(b)(2)(iii)	Maintenance records	Yes.
§63.10(b)(2)(iv) and (v)	Actions taken to minimize emissions during startup, shutdown, or malfunction	No.
§63.10(b)(2)(vi)	Recordkeeping for CMS malfunctions	Yes.
§63.10(b)(2)(vii) to (xiv)	Other CMS requirements	Yes.
§63.10(b)(3)	Recordkeeping requirements for applicability determinations	No.
§63.10(c)(1) to (9)	Recordkeeping for sources with CMS	Yes.
§63.10(c)(10) and (11)	Recording nature and cause of malfunctions, and corrective actions	No. See §63.7555(d)(7) for recordkeeping of occurrence and duration and §63.7555(d)(8) for actions taken during malfunctions.
§63.10(c)(12) and (13)	Recordkeeping for sources with CMS	Yes.
§63.10(c)(15)	Use of startup, shutdown, and malfunction plan	No.
§63.10(d)(1) and (2)	General reporting requirements	Yes.
§63.10(d)(3)	Reporting opacity or visible emission observation results	No.
§63.10(d)(4)	Progress reports under an extension of compliance	Yes.

§63.10(d)(5)	Startup, shutdown, and malfunction reports	No. See §63.7550(c)(11) for malfunction reporting requirements.
§63.10(e)	Additional reporting requirements for sources with CMS	Yes.
§63.10(f)	Waiver of recordkeeping or reporting requirements	Yes.
§63.11	Control Device Requirements	No.
§63.12	State Authority and Delegation	Yes.
§63.13-63.16	Addresses, Incorporation by Reference, Availability of Information, Performance Track Provisions	Yes.
§63.1(a)(5),(a)(7)-(a)(9), (b)(2), (c)(3)-(4), (d), 63.6(b)(6), (c)(3), (c)(4), (d), (e)(2), (e)(3)(ii), (h)(3), (h)(5)(iv), 63.8(a)(3), 63.9(b)(3), (h)(4), 63.10(c)(2)-(4), (c)(9).	Reserved	No.

[76 FR 15664, Mar. 21, 2011, as amended at 78 FR 7205, Jan. 31, 2013]

Table 11 to Subpart DDDDD of Part 63—Toxic Equivalency Factors for Dioxins/Furans

Dioxin/furan congener	Toxic equivalency factor
2,3,7,8-tetrachlorinated dibenzo-p-dioxin	1
1,2,3,7,8-pentachlorinated dibenzo-p-dioxin	1
1,2,3,4,7,8-hexachlorinated dibenzo-p-dioxin	0.1
1,2,3,7,8,9-hexachlorinated dibenzo-p-dioxin	0.1
1,2,3,6,7,8-hexachlorinated dibenzo-p-dioxin	0.1
1,2,3,4,6,7,8-heptachlorinated dibenzo-p-dioxin	0.01
octachlorinated dibenzo-p-dioxin	0.0003
2,3,7,8-tetrachlorinated dibenzofuran	0.1

2,3,4,7,8-pentachlorinated dibenzofuran	0.3
1,2,3,7,8-pentachlorinated dibenzofuran	0.03
1,2,3,4,7,8-hexachlorinated dibenzofuran	0.1
1,2,3,6,7,8-hexachlorinated dibenzofuran	0.1
1,2,3,7,8,9-hexachlorinated dibenzofuran	0.1
2,3,4,6,7,8-hexachlorinated dibenzofuran	0.1
1,2,3,4,6,7,8-heptachlorinated dibenzofuran	0.01
1,2,3,4,7,8,9-heptachlorinated dibenzofuran	0.01
octachlorinated dibenzofuran	0.0003

[76 FR 15664, Mar. 21, 2011]

EDITORIAL NOTE: At 78 FR 7206, Jan. 31, 2013, Table 11 was added, effective Apr. 1, 2013. However Table 11 could not be added as a Table 11 is already in existence.

Table 12 to Subpart DDDDD of Part 63—Alternative Emission Limits for New or Reconstructed Boilers and Process Heaters That Commenced Construction or Reconstruction After June 4, 2010, and Before May 20, 2011

If your boiler or process heater is in this subcategory	For the following pollutants	The emissions must not exceed the following emission limits, except during periods of startup and shutdown	Using this specified sampling volume or test run duration
1. Units in all subcategories designed to burn solid fuel	a. Mercury	3.5E-06 lb per MMBtu of heat input	For M29, collect a minimum of 2 dscm per run; for M30A or M30B, collect a minimum sample as specified in the method; for ASTM D6784 ^a collect a minimum of 2 dscm.
2. Units in all subcategories designed to burn solid fuel that combust at least 10 percent biomass/bio-based solids on an annual heat input basis and less than 10 percent coal/solid fossil fuels on an annual heat input basis	a. Particulate Matter	0.008 lb per MMBtu of heat input (30-day rolling average for units 250 MMBtu/hr or greater, 3-run average for units less than 250 MMBtu/hr)	Collect a minimum of 1 dscm per run.

	b. Hydrogen Chloride	0.004 lb per MMBtu of heat input	For M26A, collect a minimum of 1 dscm per run; for M26, collect a minimum of 60 liters per run.
3. Units in all subcategories designed to burn solid fuel that combust at least 10 percent coal/solid fossil fuels on an annual heat input basis and less than 10 percent biomass/bio-based solids on an annual heat input basis	a. Particulate Matter	0.0011 lb per MMBtu of heat input (30-day rolling average for units 250 MMBtu/hr or greater, 3-run average for units less than 250 MMBtu/hr)	Collect a minimum of 3 dscm per run.
	b. Hydrogen Chloride	0.0022 lb per MMBtu of heat input	For M26A, collect a minimum of 1 dscm per run; for M26, collect a minimum of 60 liters per run.
4. Units designed to burn pulverized coal/solid fossil fuel	a. CO	90 ppm by volume on a dry basis corrected to 3 percent oxygen	1 hr minimum sampling time.
	b. Dioxins/Furans	0.003 ng/dscm (TEQ) corrected to 7 percent oxygen	Collect a minimum of 4 dscm per run.
5. Stokers designed to burn coal/solid fossil fuel	a. CO	7 ppm by volume on a dry basis corrected to 3 percent oxygen	1 hr minimum sampling time.
	b. Dioxins/Furans	0.003 ng/dscm (TEQ) corrected to 7 percent oxygen	Collect a minimum of 4 dscm per run.
6. Fluidized bed units designed to burn coal/solid fossil fuel	a. CO	30 ppm by volume on a dry basis corrected to 3 percent oxygen	1 hr minimum sampling time.
	b. Dioxins/Furans	0.002 ng/dscm (TEQ) corrected to 7 percent oxygen	Collect a minimum of 4 dscm per run.
7. Stokers designed to burn biomass/bio-based solids	a. CO	560 ppm by volume on a dry basis corrected to 3 percent	1 hr minimum sampling time.

		oxygen	
	b. Dioxins/Furans	0.005 ng/dscm (TEQ) corrected to 7 percent oxygen	Collect a minimum of 4 dscm per run.
8. Fluidized bed units designed to burn biomass/bio-based solids	a. CO	260 ppm by volume on a dry basis corrected to 3 percent oxygen	1 hr minimum sampling time.
	b. Dioxins/Furans	0.02 ng/dscm (TEQ) corrected to 7 percent oxygen	Collect a minimum of 4 dscm per run.
9. Suspension burners/Dutch Ovens designed to burn biomass/bio-based solids	a. CO	1,010 ppm by volume on a dry basis corrected to 3 percent oxygen	1 hr minimum sampling time.
	b. Dioxins/Furans	0.2 ng/dscm (TEQ) corrected to 7 percent oxygen	Collect a minimum of 4 dscm per run.
10. Fuel cells designed to burn biomass/bio-based solids	a. CO	470 ppm by volume on a dry basis corrected to 3 percent oxygen	1 hr minimum sampling time.
	b. Dioxins/Furans	0.003 ng/dscm (TEQ) corrected to 7 percent oxygen	Collect a minimum of 4 dscm per run.
11. Hybrid suspension/grate units designed to burn biomass/bio-based solids	a. CO	1,500 ppm by volume on a dry basis corrected to 3 percent oxygen	1 hr minimum sampling time.
	b. Dioxins/Furans	0.2 ng/dscm (TEQ) corrected to 7 percent oxygen	Collect a minimum of 4 dscm per run.
12. Units designed to burn liquid fuel	a. Particulate Matter	0.002 lb per MMBtu of heat input (30-day rolling average for units 250 MMBtu/hr or greater, 3-run average for units less than 250 MMBtu/hr)	Collect a minimum of 2 dscm per run.
	b. Hydrogen	0.0032 lb per	For M26A, collect a

	Chloride	MMBtu of heat input	minimum of 1 dscm per run; for M26, collect a minimum of 60 liters per run.
	c. Mercury	3.0E-07 lb per MMBtu of heat input	For M29, collect a minimum of 2 dscm per run; for M30A or M30B, collect a minimum sample as specified in the method; for ASTM D6784 ^a collect a minimum of 2 dscm.
	d. CO	3 ppm by volume on a dry basis corrected to 3 percent oxygen	1 hr minimum sampling time.
	e. Dioxins/Furans	0.002 ng/dscm (TEQ) corrected to 7 percent oxygen	Collect a minimum of 4 dscm per run.
13. Units designed to burn liquid fuel located in non-continental States and territories	a. Particulate Matter	0.002 lb per MMBtu of heat input (30-day rolling average for units 250 MMBtu/hr or greater, 3-run average for units less than 250 MMBtu/hr)	Collect a minimum of 2 dscm per run.
	b. Hydrogen Chloride	0.0032 lb per MMBtu of heat input	For M26A, collect a minimum of 1 dscm per run; for M26, collect a minimum of 60 liters per run.
	c. Mercury	7.8E-07 lb per MMBtu of heat input	For M29, collect a minimum of 1 dscm per run; for M30A or M30B, collect a minimum sample as specified in the method; for ASTM D6784 ^a collect a minimum of 2 dscm.
	d. CO	51 ppm by volume on a dry basis corrected to 3 percent oxygen	1 hr minimum sampling time.

	e. Dioxins/Furans	0.002 ng/dscm (TEQ) corrected to 7 percent oxygen	Collect a minimum of 4 dscm per run.
14. Units designed to burn gas 2 (other) gases	a. Particulate Matter	0.0067 lb per MMBtu of heat input (30-day rolling average for units 250 MMBtu/hr or greater, 3-run average for units less than 250 MMBtu/hr)	Collect a minimum of 1 dscm per run.
	b. Hydrogen Chloride	0.0017 lb per MMBtu of heat input	For M26A, collect a minimum of 1 dscm per run; for M26, collect a minimum of 60 liters per run.
	c. Mercury	7.9E-06 lb per MMBtu of heat input	For M29, collect a minimum of 1 dscm per run; for M30A or M30B, collect a minimum sample as specified in the method; for ASTM D6784 ^a collect a minimum of 2 dscm.
	d. CO	3 ppm by volume on a dry basis corrected to 3 percent oxygen	1 hr minimum sampling time.
	e. Dioxins/Furans	0.08 ng/dscm (TEQ) corrected to 7 percent oxygen	Collect a minimum of 4 dscm per run.

^aIncorporated by reference, see §63.14.

[76 FR 15664, Mar. 21, 2011]

EDITORIAL NOTE: At 78 FR 7208, Jan. 31, 2013, Table 12 was added, effective Apr. 1, 2013. However, Table 12 could not be added as a Table 12 is already in existence.

Table 13 to Subpart DDDDD of Part 63—Alternative Emission Limits for New or Reconstructed Boilers and Process Heaters That Commenced Construction or Reconstruction After December 23, 2011, and Before January 31, 2013

If your boiler or process heater is in this subcategory . . .	For the following pollutants	The emissions must not exceed the following emission limits, except	Using this specified sampling volume or test run duration . . .
----------------------------------------------------------------------	-------------------------------------	----------------------------------------------------------------------------	------------------------------------------------------------------------

	. . .	during periods of startup and shutdown . . .	
1. Units in all subcategories designed to burn solid fuel	a. HCl	0.022 lb per MMBtu of heat input	For M26A, collect a minimum of 1 dscm per run; for M26 collect a minimum of 120 liters per run.
	b. Mercury	8.6E-07 ^a lb per MMBtu of heat input	For M29, collect a minimum of 4 dscm per run; for M30A or M30B, collect a minimum sample as specified in the method; for ASTM D6784 ^b collect a minimum of 4 dscm.
2. Pulverized coal boilers designed to burn coal/solid fossil fuel	a. Carbon monoxide (CO) (or CEMS)	130 ppm by volume on a dry basis corrected to 3 percent oxygen, 3-run average; or (320 ppm by volume on a dry basis corrected to 3 percent oxygen, 30-day rolling average)	1 hr minimum sampling time.
	b. Filterable PM (or TSM)	1.1E-03 lb per MMBtu of heat input; or (2.8E-05 lb per MMBtu of heat input)	Collect a minimum of 3 dscm per run.
3. Stokers designed to burn coal/solid fossil fuel	a. CO (or CEMS)	130 ppm by volume on a dry basis corrected to 3 percent oxygen, 3-run average; or (340 ppm by volume on a dry basis corrected to 3 percent oxygen, 10-day rolling average)	1 hr minimum sampling time.
	b. Filterable PM (or TSM)	2.8E-02 lb per MMBtu of heat input; or (2.3E-05 lb per MMBtu of heat input)	Collect a minimum of 2 dscm per run.
4. Fluidized bed units designed to burn coal/solid fossil fuel	a. CO (or CEMS)	130 ppm by volume on a dry basis corrected to 3 percent oxygen, 3-run average; or (230 ppm by volume on a dry basis corrected to 3 percent oxygen, 30-day rolling average)	1 hr minimum sampling time.
	b. Filterable PM (or TSM)	1.1E-03 lb per MMBtu of heat input; or (2.3E-05 lb per MMBtu of heat input)	Collect a minimum of 3 dscm per run.

	TSM)	per MMBtu of heat input)	
5. Fluidized bed units with an integrated heat exchanger designed to burn coal/solid fossil fuel	a. CO (or CEMS)	140 ppm by volume on a dry basis corrected to 3 percent oxygen, 3-run average; or (150 ppm by volume on a dry basis corrected to 3 percent oxygen, 30-day rolling average)	1 hr minimum sampling time.
	b. Filterable PM (or TSM)	1.1E-03 lb per MMBtu of heat input; or (2.3E-05 lb per MMBtu of heat input)	Collect a minimum of 3 dscm per run.
6. Stokers/sloped grate/others designed to burn wet biomass fuel	a. CO (or CEMS)	620 ppm by volume on a dry basis corrected to 3 percent oxygen, 3-run average; or (410 ppm by volume on a dry basis corrected to 3 percent oxygen, 10-day rolling average)	1 hr minimum sampling time.
	b. Filterable PM (or TSM)	3.0E-02 lb per MMBtu of heat input; or (2.6E-05 lb per MMBtu of heat input)	Collect a minimum of 2 dscm per run.
7. Stokers/sloped grate/others designed to burn kiln-dried biomass fuel	a. CO	460 ppm by volume on a dry basis corrected to 3 percent oxygen	1 hr minimum sampling time.
	b. Filterable PM (or TSM)	3.2E-01 lb per MMBtu of heat input; or (4.0E-03 lb per MMBtu of heat input)	Collect a minimum of 2 dscm per run.
8. Fluidized bed units designed to burn biomass/bio-based solids	a. CO (or CEMS)	230 ppm by volume on a dry basis corrected to 3 percent oxygen, 3-run average; or (310 ppm by volume on a dry basis corrected to 3 percent oxygen, 30-day rolling average)	1 hr minimum sampling time.
	b. Filterable PM (or TSM)	9.8E-03 lb per MMBtu of heat input; or (8.3E-05 ^a lb per MMBtu of heat input)	Collect a minimum of 3 dscm per run.
9. Suspension burners designed to burn biomass/bio-based	a. CO (or CEMS)	2,400 ppm by volume on a dry basis corrected to 3 percent oxygen, 3-run	1 hr minimum sampling time.

solids		average; or (2,000 ppm by volume on a dry basis corrected to 3 percent oxygen, 10-day rolling average)	
	b. Filterable PM (or TSM)	5.1E-02 lb per MMBtu of heat input; or (6.5E-03 lb per MMBtu of heat input)	Collect a minimum of 2 dscm per run.
10. Dutch Ovens/Pile burners designed to burn biomass/bio-based solids	a. CO (or CEMS)	810 ppm by volume on a dry basis corrected to 3 percent oxygen, 3-run average; or (520 ppm by volume on a dry basis corrected to 3 percent oxygen, 10-day rolling average)	1 hr minimum sampling time.
	b. Filterable PM (or TSM)	3.6E-02 lb per MMBtu of heat input; or (3.9E-05 lb per MMBtu of heat input)	Collect a minimum of 2 dscm per run.
11. Fuel cell units designed to burn biomass/bio-based solids	a. CO	910 ppm by volume on a dry basis corrected to 3 percent oxygen	1 hr minimum sampling time.
	b. Filterable PM (or TSM)	2.0E-02 lb per MMBtu of heat input; or (2.9E-05 lb per MMBtu of heat input)	Collect a minimum of 2 dscm per run.
12. Hybrid suspension grate boiler designed to burn biomass/bio-based solids	a. CO (or CEMS)	1,500 ppm by volume on a dry basis corrected to 3 percent oxygen, 3-run average; or (900 ppm by volume on a dry basis corrected to 3 percent oxygen, 30-day rolling average)	1 hr minimum sampling time.
	b. Filterable PM (or TSM)	2.6E-02 lb per MMBtu of heat input; or (4.4E-04 lb per MMBtu of heat input)	Collect a minimum of 3 dscm per run.
13. Units designed to burn liquid fuel	a. HCl	1.2E-03 lb per MMBtu of heat input	For M26A: Collect a minimum of 2 dscm per run; for M26, collect a minimum of 240 liters per run.
	b. Mercury	4.9E-07 ^a lb per MMBtu of	For M29, collect a minimum

		heat input	of 4 dscm per run; for M30A or M30B, collect a minimum sample as specified in the method; for ASTM D6784 ^b collect a minimum of 4 dscm.
14. Units designed to burn heavy liquid fuel	a. CO (or CEMS)	130 ppm by volume on a dry basis corrected to 3 percent oxygen, 3-run average; or (18 ppm by volume on a dry basis corrected to 3 percent oxygen, 10-day rolling average)	1 hr minimum sampling time.
	b. Filterable PM (or TSM)	1.3E-03 lb per MMBtu of heat input; or (7.5E-05 lb per MMBtu of heat input)	Collect a minimum of 3 dscm per run.
15. Units designed to burn light liquid fuel	a. CO (or CEMS)	130 ^a ppm by volume on a dry basis corrected to 3 percent oxygen; or (60 ppm by volume on a dry basis corrected to 3 percent oxygen, 1-day block average).	1 hr minimum sampling time.
	b. Filterable PM (or TSM)	1.1E-03 ^a lb per MMBtu of heat input; or (2.9E-05 lb per MMBtu of heat input)	Collect a minimum of 3 dscm per run.
16. Units designed to burn liquid fuel that are non-continental units	a. CO	130 ppm by volume on a dry basis corrected to 3 percent oxygen, 3-run average based on stack test; or (91 ppm by volume on a dry basis corrected to 3 percent oxygen, 3-hour rolling average)	1 hr minimum sampling time.
	b. Filterable PM (or TSM)	2.3E-02 lb per MMBtu of heat input; or (8.6E-04 lb per MMBtu of heat input)	Collect a minimum of 2 dscm per run.
17. Units designed to burn gas 2 (other) gases	a. CO	130 ppm by volume on a dry basis corrected to 3 percent oxygen	1 hr minimum sampling time.
	b. HCl	1.7E-03 lb per MMBtu of heat input	For M26A, Collect a minimum of 2 dscm per run; for M26,

			collect a minimum of 240 liters per run.
	c. Mercury	7.9E-06 lb per MMBtu of heat input	For M29, collect a minimum of 3 dscm per run; for M30A or M30B, collect a minimum sample as specified in the method; for ASTM D6784 ^b collect a minimum of 3 dscm.
	d. Filterable PM (or TSM)	6.7E-03 lb per MMBtu of heat input; or (2.1E-04 lb per MMBtu of heat input)	Collect a minimum of 3 dscm per run.

^aIf you are conducting stack tests to demonstrate compliance and your performance tests for this pollutant for at least 2 consecutive years show that your emissions are at or below this limit and you are not required to conduct testing for CEMS or CPMS monitor certification, you can skip testing according to §63.7515 if all of the other provision of §63.7515 are met. For all other pollutants that do not contain a footnote “a”, your performance tests for this pollutant for at least 2 consecutive years must show that your emissions are at or below 75 percent of this limit in order to qualify for skip testing.

^bIncorporated by reference, see §63.14.

[78 FR 7210, Jan. 31, 2013]

Appendix Q

Subpart JJJJ—Standards of Performance for Stationary Spark Ignition Internal Combustion Engines

Source: [73 FR 3591](#), Jan. 18, 2008, unless otherwise noted.

What This Subpart Covers

§ 60.4230 Am I subject to this subpart?

(a) The provisions of this subpart are applicable to manufacturers, owners, and operators of stationary spark ignition (SI) internal combustion engines (ICE) as specified in [paragraphs \(a\)\(1\)](#) through [\(6\)](#) of this section. For the purposes of this subpart, the date that construction commences is the date the engine is ordered by the owner or operator.

(1) Manufacturers of stationary SI ICE with a maximum engine power less than or equal to 19 kilowatt (KW) (25 horsepower (HP)) that are manufactured on or after July 1, 2008.

(2) Manufacturers of stationary SI ICE with a maximum engine power greater than 19 KW (25 HP) that are gasoline fueled or that are rich burn engines fueled by liquefied petroleum gas (LPG), where the date of manufacture is:

(i) On or after July 1, 2008; or

(ii) On or after January 1, 2009, for emergency engines.

(3) Manufacturers of stationary SI ICE with a maximum engine power greater than 19 KW (25 HP) that are not gasoline fueled and are not rich burn engines fueled by LPG, where the manufacturer participates in the voluntary manufacturer certification program described in this subpart and where the date of manufacture is:

(i) On or after July 1, 2007, for engines with a maximum engine power greater than or equal to 500 HP (except lean burn engines with a maximum engine power greater than or equal to 500 HP and less than 1,350 HP);

(ii) On or after January 1, 2008, for lean burn engines with a maximum engine power greater than or equal to 500 HP and less than 1,350 HP;

(iii) On or after July 1, 2008, for engines with a maximum engine power less than 500 HP;
or

(iv) On or after January 1, 2009, for emergency engines.

(4) Owners and operators of stationary SI ICE that commence construction after June 12, 2006, where the stationary SI ICE are manufactured:

(i) On or after July 1, 2007, for engines with a maximum engine power greater than or equal to 500 HP (except lean burn engines with a maximum engine power greater than or equal to 500 HP and less than 1,350 HP);

(ii) on or after January 1, 2008, for lean burn engines with a maximum engine power greater than or equal to 500 HP and less than 1,350 HP;

(iii) on or after July 1, 2008, for engines with a maximum engine power less than 500 HP;
or

(iv) on or after January 1, 2009, for emergency engines with a maximum engine power greater than 19 KW (25 HP).

(5) Owners and operators of stationary SI ICE that are modified or reconstructed after June 12, 2006, and any person that modifies or reconstructs any stationary SI ICE after June 12, 2006.

(6) The provisions of [§ 60.4236 of this subpart](#) are applicable to all owners and operators of stationary SI ICE that commence construction after June 12, 2006.

(b) The provisions of this subpart are not applicable to stationary SI ICE being tested at an engine test cell/stand.

(c) If you are an owner or operator of an area source subject to this subpart, you are exempt from the obligation to obtain a permit under [40 CFR part 70](#) or [40 CFR part 71](#), provided you are not required to obtain a permit under [40 CFR 70.3\(a\)](#) or [40 CFR 71.3\(a\)](#) for a reason other than your status as an area source under this subpart. Notwithstanding the previous sentence, you must continue to comply with the provisions of this subpart as applicable.

(d) For the purposes of this subpart, stationary SI ICE using alcohol-based fuels are considered gasoline engines.

(e) Stationary SI ICE may be eligible for exemption from the requirements of this subpart as described in [40 CFR part 1068, subpart C](#) (or the exemptions described in [40 CFR parts 1048](#) and [1054](#), for engines that would need to be certified to standards in those parts), except that owners and operators, as well as manufacturers, may be eligible to request an exemption for national security.

(f) Owners and operators of facilities with internal combustion engines that are acting as temporary replacement units and that are located at a stationary source for less than 1 year and that have been properly certified as meeting the standards that would be applicable to such engine under the appropriate nonroad engine provisions, are not required to meet any other provisions under this subpart with regard to such engines.

[[73 FR 3591](#), Jan. 18, 2008, as amended at [76 FR 37972](#), June 28, 2011; [86 FR 34360](#), June 29, 2021]

Emission Standards for Manufacturers

§ 60.4231 What emission standards must I meet if I am a manufacturer of stationary SI internal combustion engines or equipment containing such engines?

(a) Stationary SI internal combustion engine manufacturers must certify their stationary SI ICE with a maximum engine power less than or equal to 19 KW (25 HP) manufactured on or after July 1, 2008 to the certification emission standards and other requirements for new nonroad SI engines in [40 CFR part 1054](#), as follows:

If engine displacement is . . .	and manufacturing dates are . . .	the engine must meet the following non-handheld emission standards identified in 40 CFR part 1054 and related requirements:
(1) Below 225 cc	July 1, 2008 to December 31, 2011	Phase 2.
(2) Below 225 cc	January 1, 2012 or later	Phase 3.
(3) At or above 225 cc	July 1, 2008 to December 31, 2010	Phase 2.
(4) At or above 225 cc	January 1, 2011 or later	Phase 3.

(b) Stationary SI internal combustion engine manufacturers must certify their stationary SI ICE with a maximum engine power greater than 19 KW (25 HP) (except emergency stationary ICE with a maximum engine power greater than 25 HP and less than 130 HP) that use gasoline and that are manufactured on or after the applicable date in [§ 60.4230\(a\)\(2\)](#), or manufactured on or after the applicable date in [§ 60.4230\(a\)\(4\)](#) for emergency stationary ICE with a maximum engine power greater than or equal to 130 HP, to the certification emission standards and other requirements for new nonroad SI engines in [40 CFR part 1048](#). Stationary SI internal combustion engine manufacturers must certify their emergency stationary SI ICE with a maximum engine power greater than 25 HP and less than 130 HP that use gasoline and that are manufactured on or after the applicable date in [§ 60.4230\(a\)\(4\)](#) to the Phase 1 emission standards in [40 CFR part 1054, appendix I](#), applicable to class II engines, and other requirements for new nonroad SI engines in [40 CFR part 1054](#). Stationary SI internal combustion engine manufacturers may certify their stationary SI ICE with a maximum engine power less than or equal to 30 KW (40 HP) with a total displacement less than or equal to 1,000 cubic centimeters (cc) that use gasoline to the certification emission standards and other requirements as appropriate for new nonroad SI engines in [40 CFR part 1054](#).

(c) Stationary SI internal combustion engine manufacturers must certify their stationary SI ICE with a maximum engine power greater than 19 KW (25 HP) (except emergency stationary ICE with a maximum engine power greater than 25 HP and less than 130 HP) that are rich burn engines that use LPG and that are manufactured on or after the applicable date in [§](#)

[60.4230\(a\)\(2\)](#), or manufactured on or after the applicable date in [§ 60.4230\(a\)\(4\)](#) for emergency stationary ICE with a maximum engine power greater than or equal to 130 HP, to the certification emission standards and other requirements for new nonroad SI engines in [40 CFR part 1048](#). Stationary SI internal combustion engine manufacturers must certify their emergency stationary SI ICE greater than 25 HP and less than 130 HP that are rich burn engines that use LPG and that are manufactured on or after the applicable date in [§ 60.4230\(a\)\(4\)](#) to the Phase 1 emission standards in [40 CFR part 1054, appendix I](#), applicable to class II engines, and other requirements for new nonroad SI engines in [40 CFR part 1054](#). Stationary SI internal combustion engine manufacturers may certify their stationary SI ICE with a maximum engine power less than or equal to 30 KW (40 HP) with a total displacement less than or equal to 1,000 cc that are rich burn engines that use LPG to the certification emission standards and other requirements as appropriate for new nonroad SI engines in [40 CFR part 1054](#).

(d) Stationary SI internal combustion engine manufacturers who choose to certify their stationary SI ICE with a maximum engine power greater than 19 KW (25 HP) and less than 75 KW (100 HP) (except gasoline and rich burn engines that use LPG and emergency stationary ICE with a maximum engine power greater than 25 HP and less than 130 HP) under the voluntary manufacturer certification program described in this subpart must certify those engines to the certification emission standards for new nonroad SI engines in [40 CFR part 1048](#). Stationary SI internal combustion engine manufacturers who choose to certify their emergency stationary SI ICE greater than 25 HP and less than 130 HP (except gasoline and rich burn engines that use LPG), must certify those engines to the Phase 1 emission standards in [40 CFR part 1054, appendix I](#), applicable to class II engines, for new nonroad SI engines in [40 CFR part 1054](#). Stationary SI internal combustion engine manufacturers may certify their stationary SI ICE with a maximum engine power less than or equal to 30 KW (40 HP) with a total displacement less than or equal to 1,000 cc (except gasoline and rich burn engines that use LPG) to the certification emission standards and other requirements as appropriate for new nonroad SI engines in [40 CFR part 1054](#). For stationary SI ICE with a maximum engine power greater than 19 KW (25 HP) and less than 75 KW (100 HP) (except gasoline and rich burn engines that use LPG and emergency stationary ICE with a maximum engine power greater than 25 HP and less than 130 HP) manufactured prior to January 1, 2011, manufacturers may choose to certify these engines to the standards in Table 1 to this subpart applicable to engines with a maximum engine power greater than or equal to 100 HP and less than 500 HP.

(e) Stationary SI internal combustion engine manufacturers who choose to certify their stationary SI ICE with a maximum engine power greater than or equal to 75 KW (100 HP) (except gasoline and rich burn engines that use LPG) under the voluntary manufacturer certification program described in this subpart must certify those engines to the emission standards in Table 1 to this subpart. Stationary SI internal combustion engine manufacturers may certify their stationary SI ICE with a maximum engine power greater than or equal to 75 KW (100 HP) that are lean burn engines that use LPG to the certification emission standards for new nonroad SI engines in [40 CFR part 1048](#). For stationary SI ICE with a maximum engine power greater than or equal to 100 HP (75 KW) and less than 500 HP (373 KW) manufactured prior to January 1, 2011, and for stationary SI ICE with a maximum engine power greater than or equal to 500 HP (373 KW) manufactured prior to July 1, 2010,

manufacturers may choose to certify these engines to the certification emission standards for new nonroad SI engines in [40 CFR part 1048](#) applicable to engines that are not severe duty engines.

(f) Manufacturers of equipment containing stationary SI internal combustion engines meeting the provisions of [40 CFR part 1054](#) must meet the provisions of [40 CFR part 1060](#), to the extent they apply to equipment manufacturers.

(g) Notwithstanding the requirements in [paragraphs \(a\)](#) through [\(c\)](#) of this section, stationary SI internal combustion engine manufacturers are not required to certify reconstructed engines; however manufacturers may elect to do so. The reconstructed engine must be certified to the emission standards specified in [paragraphs \(a\)](#) through [\(e\)](#) of this section that are applicable to the model year, maximum engine power and displacement of the reconstructed stationary SI ICE.

[[73 FR 3591](#), Jan. 18, 2008, as amended at [73 FR 59175](#), Oct. 8, 2008; [76 FR 37973](#), June 28, 2011; [78 FR 6697](#), Jan. 30, 2013; [86 FR 34360](#), June 29, 2021]

[§ 60.4232 How long must my engines meet the emission standards if I am a manufacturer of stationary SI internal combustion engines?](#)

Engines manufactured by stationary SI internal combustion engine manufacturers must meet the emission standards as required in [§ 60.4231](#) during the certified emissions life of the engines.

[Emission Standards for Owners and Operators](#)

[§ 60.4233 What emission standards must I meet if I am an owner or operator of a stationary SI internal combustion engine?](#)

(a) Owners and operators of stationary SI ICE with a maximum engine power less than or equal to 19 KW (25 HP) manufactured on or after July 1, 2008, must comply with the emission standards in [§ 60.4231\(a\)](#) for their stationary SI ICE.

(b) Owners and operators of stationary SI ICE with a maximum engine power greater than 19 KW (25 HP) manufactured on or after the applicable date in [§ 60.4230\(a\)\(4\)](#) that use gasoline must comply with the emission standards in [§ 60.4231\(b\)](#) for their stationary SI ICE.

(c) Owners and operators of stationary SI ICE with a maximum engine power greater than 19 KW (25 HP) manufactured on or after the applicable date in [§ 60.4230\(a\)\(4\)](#) that are rich burn engines that use LPG must comply with the emission standards in [§ 60.4231\(c\)](#) for their stationary SI ICE.

(d) Owners and operators of stationary SI ICE with a maximum engine power greater than 19 KW (25 HP) and less than 75 KW (100 HP) (except gasoline and rich burn engines that use LPG) must comply with the emission standards for field testing in [40 CFR 1048.101\(c\)](#) for their non-emergency stationary SI ICE and with the emission standards in Table 1 to this subpart for their emergency stationary SI ICE. Owners and operators of stationary SI ICE with a maximum engine power greater than 19 KW (25 HP) and less than 75 KW (100 HP) manufactured prior to January 1, 2011, that were certified to the standards in Table 1 to this subpart applicable to engines with a maximum engine power greater than or equal to 100 HP and less than 500 HP, may optionally choose to meet those standards.

(e) Owners and operators of stationary SI ICE with a maximum engine power greater than or equal to 75 KW (100 HP) (except gasoline and rich burn engines that use LPG) must comply with the emission standards in Table 1 to this subpart for their stationary SI ICE. For owners and operators of stationary SI ICE with a maximum engine power greater than or equal to 100 HP (except gasoline and rich burn engines that use LPG) manufactured prior to January 1, 2011 that were certified to the certification emission standards in [40 CFR part 1048](#) applicable to engines that are not severe duty engines, if such stationary SI ICE was certified to a carbon monoxide (CO) standard above the standard in Table 1 to this subpart, then the owners and operators may meet the CO certification (not field testing) standard for which the engine was certified.

(f) Owners and operators of any modified or reconstructed stationary SI ICE subject to this subpart must meet the requirements as specified in [paragraphs \(f\)\(1\)](#) through [\(5\)](#) of this section.

(1) Owners and operators of stationary SI ICE with a maximum engine power less than or equal to 19 KW (25 HP), that are modified or reconstructed after June 12, 2006, must comply with emission standards in [§ 60.4231\(a\)](#) for their stationary SI ICE. Engines with a date of manufacture prior to July 1, 2008 must comply with the emission standards specified in [§ 60.4231\(a\)](#) applicable to engines manufactured on July 1, 2008.

(2) Owners and operators of stationary SI ICE with a maximum engine power greater than 19 KW (25 HP) that are gasoline engines and are modified or reconstructed after June 12, 2006, must comply with the emission standards in [§ 60.4231\(b\)](#) for their stationary SI ICE. Engines with a date of manufacture prior to July 1, 2008 (or January 1, 2009 for emergency engines) must comply with the emission standards specified in [§ 60.4231\(b\)](#) applicable to engines manufactured on July 1, 2008 (or January 1, 2009 for emergency engines).

(3) Owners and operators of stationary SI ICE with a maximum engine power greater than 19 KW (25 HP) that are rich burn engines that use LPG, that are modified or reconstructed after June 12, 2006, must comply with the same emission standards as those specified in [§ 60.4231\(c\)](#). Engines with a date of manufacture prior to July 1, 2008 (or January 1, 2009 for emergency engines) must comply with the emission standards specified in [§ 60.4231\(c\)](#) applicable to engines manufactured on July 1, 2008 (or January 1, 2009 for emergency engines).

(4) Owners and operators of stationary SI natural gas and lean burn LPG engines with a maximum engine power greater than 19 KW (25 HP), that are modified or reconstructed after June 12, 2006, must comply with the same emission standards as those specified in [paragraph \(d\)](#) or [\(e\)](#) of this section, except that such owners and operators of non-emergency engines and emergency engines greater than or equal to 130 HP must meet a nitrogen oxides (NO_x) emission standard of 3.0 grams per HP-hour (g/HP-hr), a CO emission standard of 4.0 g/HP-hr (5.0 g/HP-hr for non-emergency engines less than 100 HP), and a volatile organic compounds (VOC) emission standard of 1.0 g/HP-hr, or a NO_x emission standard of 250 ppmvd at 15 percent oxygen (O₂), a CO emission standard 540 ppmvd at 15 percent O₂ (675 ppmvd at 15 percent O₂ for non-emergency engines less than 100 HP), and a VOC emission standard of 86 ppmvd at 15 percent O₂, where the date of manufacture of the engine is:

(i) Prior to July 1, 2007, for non-emergency engines with a maximum engine power greater than or equal to 500 HP (except lean burn natural gas engines and LPG engines with a maximum engine power greater than or equal to 500 HP and less than 1,350 HP);

(ii) Prior to July 1, 2008, for non-emergency engines with a maximum engine power less than 500 HP;

(iii) Prior to January 1, 2009, for emergency engines;

(iv) Prior to January 1, 2008, for non-emergency lean burn natural gas engines and LPG engines with a maximum engine power greater than or equal to 500 HP and less than 1,350 HP.

(5) Owners and operators of stationary SI landfill/digester gas ICE engines with a maximum engine power greater than 19 KW (25 HP), that are modified or reconstructed after June 12, 2006, must comply with the same emission standards as those specified in [paragraph \(e\)](#) of this section for stationary landfill/digester gas engines. Engines with maximum engine power less than 500 HP and a date of manufacture prior to July 1, 2008 must comply with the emission standards specified in [paragraph \(e\)](#) of this section for stationary landfill/digester gas ICE with a maximum engine power less than 500 HP manufactured on July 1, 2008. Engines with a maximum engine power greater than or equal to 500 HP (except lean burn engines greater than or equal to 500 HP and less than 1,350 HP) and a date of manufacture prior to July 1, 2007 must comply with the emission standards specified in [paragraph \(e\)](#) of this section for stationary landfill/digester gas ICE with a maximum engine power greater than or equal to 500 HP (except lean burn engines greater than or equal to 500 HP and less than 1,350 HP) manufactured on July 1, 2007. Lean burn engines greater than or equal to 500 HP and less than 1,350 HP with a date of manufacture prior to January 1, 2008 must comply with the emission standards specified in [paragraph \(e\)](#) of this section for stationary landfill/digester gas ICE that are lean burn engines greater than or equal to 500 HP and less than 1,350 HP and manufactured on January 1, 2008.

(g) Owners and operators of stationary SI wellhead gas ICE engines may petition the Administrator for approval on a case-by-case basis to meet emission standards no less stringent than the emission standards that apply to stationary emergency SI engines greater than 25 HP

and less than 130 HP due to the presence of high sulfur levels in the fuel, as specified in Table 1 to this subpart. The request must, at a minimum, demonstrate that the fuel has high sulfur levels that prevent the use of aftertreatment controls and also that the owner has reasonably made all attempts possible to obtain an engine that will meet the standards without the use of aftertreatment controls. The petition must request the most stringent standards reasonably applicable to the engine using the fuel.

(h) Owners and operators of stationary SI ICE that are required to meet standards that reference [40 CFR 1048.101](#) must, if testing their engines in use, meet the standards in that section applicable to field testing, except as indicated in [paragraph \(e\)](#) of this section.

[[73 FR 3591](#), Jan. 18, 2008, as amended at [76 FR 37973](#), June 28, 2011]

§ 60.4234 How long must I meet the emission standards if I am an owner or operator of a stationary SI internal combustion engine?

Owners and operators of stationary SI ICE must operate and maintain stationary SI ICE that achieve the emission standards as required in [§ 60.4233](#) over the entire life of the engine.

Other Requirements for Owners and Operators

§ 60.4235 What fuel requirements must I meet if I am an owner or operator of a stationary SI gasoline fired internal combustion engine subject to this subpart?

Owners and operators of stationary SI ICE subject to this subpart that use gasoline must use gasoline that meets the per gallon sulfur limit in [40 CFR 1090.205](#).

[[73 FR 3591](#), Jan. 18, 2008, as amended at [85 FR 78463](#), Dec. 4, 2020]

§ 60.4236 What is the deadline for importing or installing stationary SI ICE produced in previous model years?

(a) After July 1, 2010, owners and operators may not install stationary SI ICE with a maximum engine power of less than 500 HP that do not meet the applicable requirements in [§ 60.4233](#).

(b) After July 1, 2009, owners and operators may not install stationary SI ICE with a maximum engine power of greater than or equal to 500 HP that do not meet the applicable requirements in [§ 60.4233](#), except that lean burn engines with a maximum engine power greater than or equal to 500 HP and less than 1,350 HP that do not meet the applicable requirements in [§ 60.4233](#) may not be installed after January 1, 2010.

(c) For emergency stationary SI ICE with a maximum engine power of greater than 19 KW (25 HP), owners and operators may not install engines that do not meet the applicable requirements in [§ 60.4233](#) after January 1, 2011.

(d) In addition to the requirements specified in [§§ 60.4231](#) and [60.4233](#), it is prohibited to import stationary SI ICE less than or equal to 19 KW (25 HP), stationary rich burn LPG SI ICE, and stationary gasoline SI ICE that do not meet the applicable requirements specified in [paragraphs \(a\), \(b\), and \(c\)](#) of this section, after the date specified in [paragraph \(a\), \(b\), and \(c\)](#) of this section.

(e) The requirements of this section do not apply to owners and operators of stationary SI ICE that have been modified or reconstructed, and they do not apply to engines that were removed from one existing location and reinstalled at a new location.

§ 60.4237 What are the monitoring requirements if I am an owner or operator of an emergency stationary SI internal combustion engine?

(a) Starting on July 1, 2010, if the emergency stationary SI internal combustion engine that is greater than or equal to 500 HP that was built on or after July 1, 2010, does not meet the standards applicable to non-emergency engines, the owner or operator must install a non-resettable hour meter.

(b) Starting on January 1, 2011, if the emergency stationary SI internal combustion engine that is greater than or equal to 130 HP and less than 500 HP that was built on or after January 1, 2011, does not meet the standards applicable to non-emergency engines, the owner or operator must install a non-resettable hour meter.

(c) If you are an owner or operator of an emergency stationary SI internal combustion engine that is less than 130 HP, was built on or after July 1, 2008, and does not meet the standards applicable to non-emergency engines, you must install a non-resettable hour meter upon startup of your emergency engine.

Compliance Requirements for Manufacturers

§ 60.4238 What are my compliance requirements if I am a manufacturer of stationary SI internal combustion engines ≤19 KW (25 HP) or a manufacturer of equipment containing such engines?

Stationary SI internal combustion engine manufacturers who are subject to the emission standards specified in [§ 60.4231\(a\)](#) must certify their stationary SI ICE using the certification and testing procedures required in [40 CFR part 1054, subparts C and F](#). Manufacturers of

equipment containing stationary SI internal combustion engines meeting the provisions of [40 CFR part 1054](#) must meet the provisions of [40 CFR part 1060, subpart C](#), to the extent they apply to equipment manufacturers.

[[86 FR 34361](#), June 29, 2021]

§ 60.4239 What are my compliance requirements if I am a manufacturer of stationary SI internal combustion engines >19 KW (25 HP) that use gasoline or a manufacturer of equipment containing such engines?

Stationary SI internal combustion engine manufacturers who are subject to the emission standards specified in [§ 60.4231\(b\)](#) must certify their stationary SI ICE using the certification procedures required in [40 CFR part 1048, subpart C](#), and **must** test their engines as specified in that part. Stationary SI internal combustion engine manufacturers who certify their stationary SI ICE with a maximum engine power less than or equal to 30 KW (40 HP) with a total displacement less than or equal to 1,000 cc to the certification emission standards and other requirements for new nonroad SI engines in [40 CFR part 1054](#), and manufacturers of stationary SI emergency engines that are greater than 25 HP and less than 130 HP who meet the Phase 1 emission standards in [40 CFR part 1054, appendix I](#), applicable to class II engines, must certify their stationary SI ICE using the certification and testing procedures required in [40 CFR part 1054, subparts C and F](#). Manufacturers of equipment containing stationary SI internal combustion engines meeting the provisions of [40 CFR part 1054](#) must meet the provisions of [40 CFR part 1060, subpart C](#), to the extent they apply to equipment manufacturers.

[[86 FR 34361](#), June 29, 2021]

§ 60.4240 What are my compliance requirements if I am a manufacturer of stationary SI internal combustion engines >19 KW (25 HP) that are rich burn engines that use LPG or a manufacturer of equipment containing such engines?

Stationary SI internal combustion engine manufacturers who are subject to the emission standards specified in [§ 60.4231\(c\)](#) must certify their stationary SI ICE using the certification procedures required in [40 CFR part 1048, subpart C](#), and **must** test their engines as specified in that part. Stationary SI internal combustion engine manufacturers who certify their stationary SI ICE with a maximum engine power less than or equal to 30 KW (40 HP) with a total displacement less than or equal to 1,000 cc to the certification emission standards and other requirements for new nonroad SI engines in [40 CFR part 1054](#), and manufacturers of stationary SI emergency engines that are greater than 25 HP and less than 130 HP who meet the Phase 1 emission standards in [40 CFR part 1054, appendix I](#), applicable to class II engines, must certify their stationary SI ICE using the certification and testing procedures required in [40 CFR part](#)

[1054, subparts C and F](#). Manufacturers of equipment containing stationary SI internal combustion engines meeting the provisions of [40 CFR part 1054](#) must meet the provisions of [40 CFR part 1060, subpart C](#), to the extent they apply to equipment manufacturers.

[[86 FR 34361](#), June 29, 2021]

§ 60.4241 What are my compliance requirements if I am a manufacturer of stationary SI internal combustion engines participating in the voluntary certification program or a manufacturer of equipment containing such engines?

(a) Manufacturers of stationary SI internal combustion engines with a maximum engine power greater than 19 KW (25 HP) that do not use gasoline and are not rich burn engines that use LPG can choose to certify their engines to the emission standards in [§ 60.4231\(d\)](#) or [\(e\)](#), as applicable, under the voluntary certification program described in this subpart. Manufacturers who certify their engines under the voluntary certification program must meet the requirements as specified in [paragraphs \(b\) through \(g\)](#) of this section. In addition, manufacturers of stationary SI internal combustion engines who choose to certify their engines under the voluntary certification program, must also meet the requirements as specified in [§ 60.4247](#). Manufacturers of stationary SI internal combustion engines who choose not to certify their engines under this section must notify the ultimate purchaser that testing requirements apply as described in [§ 60.4243\(b\)\(2\)](#); manufacturers must keep a copy of this notification for five years after shipping each engine and make those documents available to EPA upon request.

(b) Manufacturers of engines other than those certified to standards in [40 CFR part 1054](#) must certify their stationary SI ICE using the certification procedures required in [40 CFR part 1048, subpart C](#), and **must** follow the same test procedures that apply to Large SI nonroad engines under [40 CFR part 1048](#), but must use the D-1 cycle of International Organization for Standardization 8178-4: 1996(E) (incorporated by reference, see [§ 60.17](#)) or the test cycle requirements specified in Table 3 to [40 CFR 1048.505](#), except that Table 3 of [40 CFR 1048.505](#) applies to high load engines only. Manufacturers of any size may certify their stationary emergency engines at or above 130 hp using assigned deterioration factors established by EPA, consistent with [40 CFR 1048.240](#). Stationary SI internal combustion engine manufacturers who certify their stationary SI ICE with a maximum engine power less than or equal to 30 KW (40 HP) with a total displacement less than or equal to 1,000 cc to the certification emission standards and other requirements for new nonroad SI engines in [40 CFR part 1054](#), and manufacturers of emergency engines that are greater than 25 HP and less than 130 HP who meet the Phase 1 standards in [40 CFR part 1054, appendix I](#), applicable to class II engines, must certify their stationary SI ICE using the certification and testing procedures required in [40 CFR part 1054, subparts C and F](#). Manufacturers of equipment containing stationary SI internal combustion engines meeting the provisions of [40 CFR part 1054](#) must meet the provisions of [40 CFR part 1060, subpart C](#), to the extent they apply to equipment manufacturers.

(c) Certification of stationary SI ICE to the emission standards specified in [§ 60.4231\(d\)](#) or [\(e\)](#), as applicable, is voluntary, but manufacturers who decide to certify are subject to all of the requirements indicated in this subpart with regard to the engines included in their certification. Manufacturers must clearly label their stationary SI engines as certified or non-certified engines.

(d) Manufacturers of natural gas fired stationary SI ICE who conduct voluntary certification of stationary SI ICE to the emission standards specified in [§ 60.4231\(d\)](#) or [\(e\)](#), as applicable, must certify their engines for operation using fuel that meets the definition of pipeline-quality natural gas. The fuel used for certifying stationary SI natural gas engines must meet the definition of pipeline-quality natural gas as described in [§ 60.4248](#). In addition, the manufacturer must provide information to the owner and operator of the certified stationary SI engine including the specifications of the pipeline-quality natural gas to which the engine is certified and what adjustments the owner or operator must make to the engine when installed in the field to ensure compliance with the emission standards.

(e) Manufacturers of stationary SI ICE that are lean burn engines fueled by LPG who conduct voluntary certification of stationary SI ICE to the emission standards specified in [§ 60.4231\(d\)](#) or [\(e\)](#), as applicable, must certify their engines for operation using fuel that meets the specifications in [40 CFR 1065.720](#).

(f) Manufacturers may certify their engines for operation using gaseous fuels in addition to pipeline-quality natural gas; however, the manufacturer must specify the properties of that fuel and provide testing information showing that the engine will meet the emission standards specified in [§ 60.4231\(d\)](#) or [\(e\)](#), as applicable, when operating on that fuel. The manufacturer must also provide instructions for configuring the stationary engine to meet the emission standards on fuels that do not meet the pipeline-quality natural gas definition. The manufacturer must also provide information to the owner and operator of the certified stationary SI engine regarding the configuration that is most conducive to reduced emissions where the engine will be operated on gaseous fuels with different quality than the fuel that it was certified to.

(g) A stationary SI engine manufacturer may certify an engine family solely to the standards applicable to landfill/digester gas engines as specified in [§ 60.4231\(d\)](#) or [\(e\)](#), as applicable, but must certify their engines for operation using landfill/digester gas and must add a permanent label stating that the engine is for use only in landfill/digester gas applications. The label must be added according to the labeling requirements specified in [40 CFR 1048.135\(b\)](#).

(h) For purposes of this subpart, when calculating emissions of volatile organic compounds, emissions of formaldehyde should not be included.

(i) For engines being certified to the voluntary certification standards in Table 1 of this subpart, the VOC measurement shall be made by following the procedures in [40 CFR part 1065, subpart C](#), to determine the total NMHC emissions. As an alternative, manufacturers may measure ethane, as well as methane, for excluding such levels from the total VOC measurement.

[[73 FR 3591](#), Jan. 18, 2008, as amended at [73 FR 59176](#), Oct. 8, 2008; [76 FR 37974](#), June 28, 2011; [86 FR 34361](#), June 29, 2021]

§ 60.4242 What other requirements must I meet if I am a manufacturer of stationary SI internal combustion engines or equipment containing stationary SI internal combustion engines or a manufacturer of equipment containing such engines?

(a) Stationary SI internal combustion engine manufacturers must meet the provisions of [40 CFR parts 1048, 1054, and 1068](#), as applicable, except that engines certified pursuant to the voluntary certification procedures in [§ 60.4241](#) are subject only to the provisions indicated in [§ 60.4247](#) and are permitted to provide instructions to owners and operators allowing for deviations from certified configurations, if such deviations are consistent with the provisions of [§ 60.4241\(c\)](#) through [\(f\)](#). Manufacturers of equipment containing stationary SI internal combustion engines meeting the provisions of [40 CFR part 1054](#) must meet the provisions of [40 CFR part 1060](#), as applicable. Labels on engines certified to [40 CFR part 1048](#) must refer to stationary engines, rather than or in addition to nonroad engines, as appropriate.

(b) An engine manufacturer certifying an engine family or families to standards under this subpart that are identical to standards identified in [40 CFR part 1048](#) or [1054](#) for that model year may certify any such family that contains both nonroad and stationary engines as a single engine family and/or may include any such family containing stationary engines in the averaging, banking and trading provisions applicable for such engines under those parts. This [paragraph \(b\)](#) also applies to equipment or component manufacturers certifying to standards under [40 CFR part 1060](#).

(c) Manufacturers of engine families certified to [40 CFR part 1048](#) may meet the labeling requirements referred to in [paragraph \(a\)](#) of this section for stationary SI ICE by either adding a separate label containing the information required in [paragraph \(a\)](#) of this section or by adding the words “and stationary” after the word “nonroad” to the label.

(d) For all engines manufactured on or after January 1, 2011, and for all engines with a maximum engine power greater than 25 HP and less than 130 HP manufactured on or after July 1, 2008, a stationary SI engine manufacturer that certifies an engine family solely to the standards applicable to emergency engines must add a permanent label stating that the engines in that family are for emergency use only. The label must be added according to the labeling requirements specified in [40 CFR 1048.135\(b\)](#).

(e) All stationary SI engines subject to mandatory certification that do not meet the requirements of this subpart must be labeled and exported according to [40 CFR 1068.230](#). Manufacturers of stationary engines with a maximum engine power greater than 25 HP that are not certified to standards and other requirements under [40 CFR part 1048](#) are subject to the labeling provisions of [40 CFR 1048.20](#) pertaining to excluded stationary engines.

(f) For manufacturers of gaseous-fueled stationary engines required to meet the warranty provisions in [40 CFR 1054.120](#), we may establish an hour-based warranty period equal to at least the certified emissions life of the engines (in engine operating hours) if we determine that these engines are likely to operate for a number of hours greater than the applicable useful life within 24 months. We will not approve an alternate warranty under this [paragraph \(f\)](#) for nonroad engines. An alternate warranty period approved under this [paragraph \(f\)](#) will be the specified number of engine operating hours or two years, whichever comes first. The engine manufacturer shall request this alternate warranty period in its application for certification or in an earlier submission. We may approve an alternate warranty period for an engine family subject to the following conditions:

- (1) The engines must be equipped with non-resettable hour meters.
- (2) The engines must be designed to operate for a number of hours substantially greater than the applicable certified emissions life.
- (3) The emission-related warranty for the engines may not be shorter than any published warranty offered by the manufacturer without charge for the engines. Similarly, the emission-related warranty for any component shall not be shorter than any published warranty offered by the manufacturer without charge for that component.

[[86 FR 34362](#), June 29, 2021]

Compliance Requirements for Owners and Operators

§ 60.4243 What are my compliance requirements if I am an owner or operator of a stationary SI internal combustion engine?

(a) If you are an owner or operator of a stationary SI internal combustion engine that is manufactured after July 1, 2008, and must comply with the emission standards specified in [§ 60.4233\(a\)](#) through [\(c\)](#), you must comply by purchasing an engine certified to the emission standards in [§ 60.4231\(a\)](#) through [\(c\)](#), as applicable, for the same engine class and maximum engine power. In addition, you must meet one of the requirements specified in [\(a\)\(1\)](#) and [\(2\)](#) of this section.

(1) If you operate and maintain the certified stationary SI internal combustion engine and control device according to the manufacturer's emission-related written instructions, you must keep records of conducted maintenance to demonstrate compliance, but no performance testing is required if you are an owner or operator. You must also meet the requirements as specified in [40 CFR part 1068, subparts A through D](#), as they apply to you. If you adjust engine settings according to and consistent with the manufacturer's instructions, your stationary SI internal combustion engine will not be considered out of compliance.

(2) If you do not operate and maintain the certified stationary SI internal combustion engine and control device according to the manufacturer's emission-related written instructions, your engine will be considered a non-certified engine, and you must demonstrate compliance according to (a)(2)(i) through (iii) of this section, as appropriate.

(i) If you are an owner or operator of a stationary SI internal combustion engine less than 100 HP, you must keep a maintenance plan and records of conducted maintenance to demonstrate compliance and must, to the extent practicable, maintain and operate the engine in a manner consistent with good air pollution control practice for minimizing emissions, but no performance testing is required if you are an owner or operator.

(ii) If you are an owner or operator of a stationary SI internal combustion engine greater than or equal to 100 HP and less than or equal to 500 HP, you must keep a maintenance plan and records of conducted maintenance and must, to the extent practicable, maintain and operate the engine in a manner consistent with good air pollution control practice for minimizing emissions. In addition, you must conduct an initial performance test within 1 year of engine startup to demonstrate compliance.

(iii) If you are an owner or operator of a stationary SI internal combustion engine greater than 500 HP, you must keep a maintenance plan and records of conducted maintenance and must, to the extent practicable, maintain and operate the engine in a manner consistent with good air pollution control practice for minimizing emissions. In addition, you must conduct an initial performance test within 1 year of engine startup and conduct subsequent performance testing every 8,760 hours or 3 years, whichever comes first, thereafter to demonstrate compliance.

(b) If you are an owner or operator of a stationary SI internal combustion engine and must comply with the emission standards specified in [§ 60.4233\(d\)](#) or [\(e\)](#), you must demonstrate compliance according to one of the methods specified in [paragraphs \(b\)\(1\)](#) and [\(2\)](#) of this section.

(1) Purchasing an engine certified according to procedures specified in this subpart, for the same model year and demonstrating compliance according to one of the methods specified in [paragraph \(a\)](#) of this section.

(2) Purchasing a non-certified engine and demonstrating compliance with the emission standards specified in [§ 60.4233\(d\)](#) or [\(e\)](#) and according to the requirements specified in [§ 60.4244](#), as applicable, and according to [paragraphs \(b\)\(2\)\(i\)](#) and [\(ii\)](#) of this section.

(i) If you are an owner or operator of a stationary SI internal combustion engine greater than 25 HP and less than or equal to 500 HP, you must keep a maintenance plan and records of conducted maintenance and must, to the extent practicable, maintain and operate the engine in a manner consistent with good air pollution control practice for minimizing emissions. In addition, you must conduct an initial performance test to demonstrate compliance.

(ii) If you are an owner or operator of a stationary SI internal combustion engine greater than 500 HP, you must keep a maintenance plan and records of conducted maintenance and must, to the extent practicable, maintain and operate the engine in a manner consistent with good air pollution control practice for minimizing emissions. In addition, you must conduct an initial performance test and conduct subsequent performance testing every 8,760 hours or 3 years, whichever comes first, thereafter to demonstrate compliance.

(c) If you are an owner or operator of a stationary SI internal combustion engine that must comply with the emission standards specified in [§ 60.4233\(f\)](#), you must demonstrate compliance according to [paragraph \(b\)\(2\)\(i\)](#) or [\(ii\)](#) of this section, except that if you comply according to [paragraph \(b\)\(2\)\(i\)](#) of this section, you demonstrate that your non-certified engine complies with the emission standards specified in [§ 60.4233\(f\)](#).

(d) If you own or operate an emergency stationary ICE, you must operate the emergency stationary ICE according to the requirements in [paragraphs \(d\)\(1\)](#) through [\(3\)](#) of this section. In order for the engine to be considered an emergency stationary ICE under this subpart, any operation other than emergency operation, maintenance and testing, and operation in non-emergency situations for 50 hours per year, as described in [paragraphs \(d\)\(1\)](#) through [\(3\)](#), is prohibited. If you do not operate the engine according to the requirements in [paragraphs \(d\)\(1\)](#) through [\(3\)](#), the engine will not be considered an emergency engine under this subpart and must meet all requirements for non-emergency engines.

(1) There is no time limit on the use of emergency stationary ICE in emergency situations.

(2) You may operate your emergency stationary ICE for the purpose specified in [paragraph \(d\)\(2\)\(i\)](#) of this section for a maximum of 100 hours per calendar year. Any operation for non-emergency situations as allowed by [paragraph \(d\)\(3\)](#) of this section counts as part of the 100 hours per calendar year allowed by this [paragraph \(d\)\(2\)](#).

(i) Emergency stationary ICE may be operated for maintenance checks and readiness testing, provided that the tests are recommended by federal, state or local government, the manufacturer, the vendor, the regional transmission organization or equivalent balancing authority and transmission operator, or the insurance company associated with the engine. The owner or operator may petition the Administrator for approval of additional hours to be used for maintenance checks and readiness testing, but a petition is not required if the owner or operator maintains records indicating that federal, state, or local standards require maintenance and testing of emergency ICE beyond 100 hours per calendar year.

(ii)-(iii) [Reserved]

(3) Emergency stationary ICE may be operated for up to 50 hours per calendar year in non-emergency situations. The 50 hours of operation in non-emergency situations are counted as part of the 100 hours per calendar year for maintenance and testing provided in [paragraph \(d\)\(2\)](#) of this section. Except as provided in [paragraph \(d\)\(3\)\(i\)](#) of this section, the 50 hours per year for non-emergency situations cannot be used for peak shaving or non-emergency

demand response, or to generate income for a facility to an electric grid or otherwise supply power as part of a financial arrangement with another entity.

(i) The 50 hours per year for non-emergency situations can be used to supply power as part of a financial arrangement with another entity if all of the following conditions are met:

(A) The engine is dispatched by the local balancing authority or local transmission and distribution system operator;

(B) The dispatch is intended to mitigate local transmission and/or distribution limitations so as to avert potential voltage collapse or line overloads that could lead to the interruption of power supply in a local area or region.

(C) The dispatch follows reliability, emergency operation or similar protocols that follow specific NERC, regional, state, public utility commission or local standards or guidelines.

(D) The power is provided only to the facility itself or to support the local transmission and distribution system.

(E) The owner or operator identifies and records the entity that dispatches the engine and the specific NERC, regional, state, public utility commission or local standards or guidelines that are being followed for dispatching the engine. The local balancing authority or local transmission and distribution system operator may keep these records on behalf of the engine owner or operator.

(ii) [Reserved]

(e) Owners and operators of stationary SI natural gas fired engines may operate their engines using propane for a maximum of 100 hours per year as an alternative fuel solely during emergency operations, but must keep records of such use. If propane is used for more than 100 hours per year in an engine that is not certified to the emission standards when using propane, the owners and operators are required to conduct a performance test to demonstrate compliance with the emission standards of [§ 60.4233](#).

(f) If you are an owner or operator of a stationary SI internal combustion engine that is less than or equal to 500 HP and you purchase a non-certified engine or you do not operate and maintain your certified stationary SI internal combustion engine and control device according to the manufacturer's written emission-related instructions, you are required to perform initial performance testing as indicated in this section, but you are not required to conduct subsequent performance testing unless the stationary engine undergoes rebuild, major repair or maintenance. Engine rebuilding means to overhaul an engine or to otherwise perform extensive service on the engine (or on a portion of the engine or engine system). For the purpose of this [paragraph \(f\)](#), perform extensive service means to disassemble the engine (or portion of the engine or engine system), inspect and/or replace many of the parts, and reassemble the engine (or portion of the engine or engine system) in such a manner that significantly increases the service life of the resultant engine.

(g) It is expected that air-to-fuel ratio controllers will be used with the operation of three-way catalysts/non-selective catalytic reduction. The AFR controller must be maintained and operated appropriately in order to ensure proper operation of the engine and control device to minimize emissions at all times.

(h) If you are an owner/operator of an stationary SI internal combustion engine with maximum engine power greater than or equal to 500 HP that is manufactured after July 1, 2007 and before July 1, 2008, and must comply with the emission standards specified in sections 60.4233(b) or (c), you must comply by one of the methods specified in [paragraphs \(h\)\(1\)](#) through [\(h\)\(4\)](#) of this section.

(1) Purchasing an engine certified according to [40 CFR part 1048](#). The engine must be installed and configured according to the manufacturer's specifications.

(2) Keeping records of performance test results for each pollutant for a test conducted on a similar engine. The test must have been conducted using the same methods specified in this subpart and these methods must have been followed correctly.

(3) Keeping records of engine manufacturer data indicating compliance with the standards.

(4) Keeping records of control device vendor data indicating compliance with the standards.

(i) If you are an owner or operator of a modified or reconstructed stationary SI internal combustion engine and must comply with the emission standards specified in [§ 60.4233\(f\)](#), you must demonstrate compliance according to one of the methods specified in [paragraphs \(i\)\(1\)](#) or [\(2\)](#) of this section.

(1) Purchasing, or otherwise owning or operating, an engine certified to the emission standards in [§ 60.4233\(f\)](#), as applicable.

(2) Conducting a performance test to demonstrate initial compliance with the emission standards according to the requirements specified in [§ 60.4244](#). The test must be conducted within 60 days after the engine commences operation after the modification or reconstruction.

[[73 FR 3591](#), Jan. 18, 2008, as amended at [76 FR 37974](#), June 28, 2011; [78 FR 6697](#), Jan. 30, 2013; [86 FR 34362](#), June 29, 2021; [87 FR 48606](#), Aug. 10, 2022]

Testing Requirements for Owners and Operators

§ 60.4244 What test methods and other procedures must I use if I am an owner or operator of a stationary SI internal combustion engine?

Owners and operators of stationary SI ICE who conduct performance tests must follow the procedures in [paragraphs \(a\) through \(f\)](#) of this section.

(a) Each performance test must be conducted within 10 percent of 100 percent peak (or the highest achievable) load and according to the requirements in [§ 60.8](#) and under the specific conditions that are specified by Table 2 to this subpart.

(b) You may not conduct performance tests during periods of startup, shutdown, or malfunction, as specified in [§ 60.8\(c\)](#). If your stationary SI internal combustion engine is non-operational, you do not need to startup the engine solely to conduct a performance test; however, you must conduct the performance test immediately upon startup of the engine.

(c) You must conduct three separate test runs for each performance test required in this section, as specified in [§ 60.8\(f\)](#). Each test run must be conducted within 10 percent of 100 percent peak (or the highest achievable) load and last at least 1 hour.

(d) To determine compliance with the NO_x mass per unit output emission limitation, convert the concentration of NO_x in the engine exhaust using Equation 1 of this section:

$$ER = \frac{C_d \times 1.912 \times 10^{-1} \times Q \times T}{HP-hr} \quad (\text{Eq. 1})$$

Where:

ER = Emission rate of NO_x in g/HP-hr.

C_d = Measured NO_x concentration in parts per million by volume (ppmv).

1.912 × 10⁻³ = Conversion constant for ppm NO_x to grams per standard cubic meter at 20 degrees Celsius.

Q = Stack gas volumetric flow rate, in standard cubic meter per hour, dry basis.

T = Time of test run, in hours.

HP-hr = Brake work of the engine, horsepower-hour (HP-hr).

(e) To determine compliance with the CO mass per unit output emission limitation, convert the concentration of CO in the engine exhaust using Equation 2 of this section:

$$ER = \frac{C_d \times 1.164 \times 10^{-1} \times Q \times T}{HP-hr} \quad (\text{Eq. 2})$$

Where:

ER = Emission rate of CO in g/HP-hr.

C_d = Measured CO concentration in ppmv.

1.164×10^{-3} = Conversion constant for ppm CO to grams per standard cubic meter at 20 degrees Celsius.

Q = Stack gas volumetric flow rate, in standard cubic meters per hour, dry basis.

T = Time of test run, in hours.

HP-hr = Brake work of the engine, in HP-hr.

(f) For purposes of this subpart, when calculating emissions of VOC, emissions of formaldehyde should not be included. To determine compliance with the VOC mass per unit output emission limitation, convert the concentration of VOC in the engine exhaust using Equation 3 of this section:

$$ER = \frac{C_d \times 1.833 \times 10^{-1} \times Q \times T}{HP-hr} \quad (\text{Eq. 3})$$

Where:

ER = Emission rate of VOC in g/HP-hr.

C_d = VOC concentration measured as propane in ppmv.

1.833×10^{-3} = Conversion constant for ppm VOC measured as propane, to grams per standard cubic meter at 20 degrees Celsius.

Q = Stack gas volumetric flow rate, in standard cubic meters per hour, dry basis.

T = Time of test run, in hours.

HP-hr = Brake work of the engine, in HP-hr.

(g) If the owner/operator chooses to measure VOC emissions using either Method 18 of [40 CFR part 60, appendix A](#), or Method 320 of [40 CFR part 63, appendix A](#), then it has the option of correcting the measured VOC emissions to account for the potential differences in measured values between these methods and Method 25A. The results from Method 18 and Method 320 can be corrected for response factor differences using Equations 4 and 5 of this section. The corrected VOC concentration can then be placed on a propane basis using Equation 6 of this section.

$$RF_i = \frac{C_{Mi}}{C_{Ai}} \quad (\text{Eq. 4})$$

Where:

RF_i = Response factor of compound i when measured with EPA Method 25A.

C_{Mi} = Measured concentration of compound i in ppmv as carbon.

C_{Ai} = True concentration of compound i in ppmv as carbon.

$$C_{\text{meas}} = RF_i \times C_{\text{corr}} \quad (\text{Eq. 5})$$

Where:

C_{corr} = Concentration of compound i corrected to the value that would have been measured by EPA Method 25A, ppmv as carbon.

C_{meas} = Concentration of compound i measured by EPA Method 320, ppmv as carbon.

$$C_{\text{peq}} = 0.6098 \times C_{\text{corr}} \quad (\text{Eq. 6})$$

Where:

C_{peq} = Concentration of compound i in mg of propane equivalent per DSCM.

Notification, Reports, and Records for Owners and Operators

§ 60.4245 What are my notification, reporting, and recordkeeping requirements if I am an owner or operator of a stationary SI internal combustion engine?

Owners or operators of stationary SI ICE must meet the following notification, reporting and recordkeeping requirements.

(a) Owners and operators of all stationary SI ICE must keep records of the information in [paragraphs \(a\)\(1\)](#) through [\(4\)](#) of this section.

(1) All notifications submitted to comply with this subpart and all documentation supporting any notification.

(2) Maintenance conducted on the engine.

(3) If the stationary SI internal combustion engine is a certified engine, documentation from the manufacturer that the engine is certified to meet the emission standards and information as required in [40 CFR parts 1048, 1054, and 1060](#), as applicable.

(4) If the stationary SI internal combustion engine is not a certified engine or is a certified engine operating in a non-certified manner and subject to [§ 60.4243\(a\)\(2\)](#), documentation that the engine meets the emission standards.

(b) For all stationary SI emergency ICE greater than or equal to 500 HP manufactured on or after July 1, 2010, that do not meet the standards applicable to non-emergency engines, the owner or operator of must keep records of the hours of operation of the engine that is recorded through the non-resettable hour meter. For all stationary SI emergency ICE greater than or equal to 130 HP and less than 500 HP manufactured on or after July 1, 2011 that do not meet the standards applicable to non-emergency engines, the owner or operator of must keep records of the hours of operation of the engine that is recorded through the non-resettable hour meter. For all stationary SI emergency ICE greater than 25 HP and less than 130 HP manufactured on or after July 1, 2008, that do not meet the standards applicable to non-emergency engines, the owner or operator of must keep records of the hours of operation of the engine that is recorded through the non-resettable hour meter. The owner or operator must document how many hours are spent for emergency operation, including what classified the operation as emergency and how many hours are spent for non-emergency operation.

(c) Owners and operators of stationary SI ICE greater than or equal to 500 HP that have not been certified by an engine manufacturer to meet the emission standards in [§ 60.4231](#) must submit an initial notification as required in [§ 60.7\(a\)\(1\)](#). The notification must include the information in [paragraphs \(c\)\(1\) through \(5\)](#) of this section.

(1) Name and address of the owner or operator;

(2) The address of the affected source;

(3) Engine information including make, model, engine family, serial number, model year, maximum engine power, and engine displacement;

(4) Emission control equipment; and

(5) Fuel used.

(d) Owners and operators of stationary SI ICE that are subject to performance testing must submit a copy of each performance test as conducted in [§ 60.4244](#) within 60 days after the test has been completed. Performance test reports using EPA Method 18, EPA Method 320, or ASTM D6348–03 (incorporated by reference—see [40 CFR 60.17](#)) to measure VOC require reporting of all QA/QC data. For Method 18, report results from sections 8.4 and 11.1.1.4; for

Method 320, report results from sections 8.6.2, 9.0, and 13.0; and for ASTM D6348–03 report results of all QA/QC procedures in Annexes 1–7.

(e) If you own or operate an emergency stationary SI ICE with a maximum engine power more than 100 HP that operates for the purpose specified in [§ 60.4243\(d\)\(3\)\(i\)](#), you must submit an annual report according to the requirements in [paragraphs \(e\)\(1\)](#) through [\(3\)](#) of this section.

(1) The report must contain the following information:

(i) Company name and address where the engine is located.

(ii) Date of the report and beginning and ending dates of the reporting period.

(iii) Engine site rating and model year.

(iv) Latitude and longitude of the engine in decimal degrees reported to the fifth decimal place.

(v)-(vi) [Reserved]

(vii) Hours spent for operation for the purposes specified in [§ 60.4243\(d\)\(3\)\(i\)](#), including the date, start time, and end time for engine operation for the purposes specified in [§ 60.4243\(d\)\(3\)\(i\)](#). The report must also identify the entity that dispatched the engine and the situation that necessitated the dispatch of the engine.

(2) The first annual report must cover the calendar year 2015 and must be submitted no later than March 31, 2016. Subsequent annual reports for each calendar year must be submitted no later than March 31 of the following calendar year.

(3) The annual report must be submitted electronically using the subpart specific reporting form in the Compliance and Emissions Data Reporting Interface (CEDRI) that is accessed through EPA's Central Data Exchange (CDX) (www.epa.gov/cdx). However, if the reporting form specific to this subpart is not available in CEDRI at the time that the report is due, the written report must be submitted to the Administrator at the appropriate address listed in [§ 60.4](#).

[[73 FR 3591](#), Jan. 18, 2008, as amended at [73 FR 59177](#), Oct. 8, 2008; [78 FR 6697](#), Jan. 30, 2013; [81 FR 59809](#), Aug. 30, 2016; [86 FR 34362](#), June 29, 2021; [87 FR 48606](#), Aug. 10, 2022]

General Provisions

§ 60.4246 What General Provisions and confidential information provisions apply to me?

(a) Table 3 to this subpart shows which parts of the General Provisions in [§§ 60.1](#) through [60.19](#) apply to you.

(b) The provisions of [40 CFR 1068.10](#) and [1068.11](#) apply for engine manufacturers. For others, the general confidential business information (CBI) provisions apply as described in [40 CFR part 2](#).

[[88 FR 4471](#), Jan. 24, 2023]

Mobile Source Provisions

§ 60.4247 What parts of the mobile source provisions apply to me if I am a manufacturer of stationary SI internal combustion engines or a manufacturer of equipment containing such engines?

(a) Manufacturers certifying to emission standards in [40 CFR part 1054](#) must meet the provisions of [40 CFR part 1054](#). Note that [40 CFR part 1054, appendix I](#), describes various provisions that do not apply for engines meeting Phase 1 standards in [40 CFR part 1054](#). Manufacturers of equipment containing stationary SI internal combustion engines meeting the provisions of [40 CFR part 1054](#) must meet the provisions of [40 CFR part 1060](#) to the extent they apply to equipment manufacturers.

(b) Manufacturers required to certify to emission standards in [40 CFR part 1048](#) must meet the provisions of [40 CFR part 1048](#). Manufacturers certifying to emission standards in [40 CFR part 1048](#) pursuant to the voluntary certification program must meet the requirements in Table 4 to this subpart as well as the standards in [40 CFR 1048.101](#).

(c) For manufacturers of stationary SI internal combustion engines participating in the voluntary certification program and certifying engines to Table 1 to this subpart, Table 4 to this subpart shows which parts of the mobile source provisions in [40 CFR parts 1048, 1065, and 1068](#) apply to you. Compliance with the deterioration factor provisions under [40 CFR 1048.205\(n\)](#) and [1048.240](#) will be required for engines built new on and after January 1, 2010. Prior to January 1, 2010, manufacturers of stationary internal combustion engines participating in the voluntary certification program have the option to develop their own deterioration factors based on an engineering analysis.

[[73 FR 3591](#), Jan. 18, 2008, as amended at [73 FR 59177](#), Oct. 8, 2008; [86 FR 34362](#), June 29, 2021]

Definitions

§ 60.4248 What definitions apply to this subpart?

As used in this subpart, all terms not defined herein shall have the meaning given them in the CAA and in [subpart A of this part](#).

Certified emissions life means the period during which the engine is designed to properly function in terms of reliability and fuel consumption, without being remanufactured, specified as a number of hours of operation or calendar years, whichever comes first. The values for certified emissions life for stationary SI ICE with a maximum engine power less than or equal to 19 KW (25 HP) are given in [40 CFR 1054.107](#) and [1060.101](#), as appropriate. The values for certified emissions life for stationary SI ICE with a maximum engine power greater than 19 KW (25 HP) certified to [40 CFR part 1048](#) are given in [40 CFR 1048.101\(g\)](#). The certified emissions life for stationary SI ICE with a maximum engine power greater than 75 KW (100 HP) certified under the voluntary manufacturer certification program of this subpart is 5,000 hours or 7 years, whichever comes first. You may request in your application for certification that we approve a shorter certified emissions life for an engine family. We may approve a shorter certified emissions life, in hours of engine operation but not in years, if we determine that these engines will rarely operate longer than the shorter certified emissions life. If engines identical to those in the engine family have already been produced and are in use, your demonstration must include documentation from such in-use engines. In other cases, your demonstration must include an engineering analysis of information equivalent to such in-use data, such as data from research engines or similar engine models that are already in production. Your demonstration must also include any overhaul interval that you recommend, any mechanical warranty that you offer for the engine or its components, and any relevant customer design specifications. Your demonstration may include any other relevant information. The certified emissions life value may not be shorter than any of the following:

- (1) 1,000 hours of operation.
- (2) Your recommended overhaul interval.
- (3) Your mechanical warranty for the engine.

Certified stationary internal combustion engine means an engine that belongs to an engine family that has a certificate of conformity that complies with the emission standards and requirements in this part, or of [40 CFR part 1048](#) or [1054](#), as appropriate.

Combustion turbine means all equipment, including but not limited to the turbine, the fuel, air, lubrication and exhaust gas systems, control systems (except emissions control equipment), and any ancillary components and sub-components comprising any simple cycle combustion turbine, any regenerative/recuperative cycle combustion turbine, the combustion turbine portion of any cogeneration cycle combustion system, or the combustion turbine portion of any combined cycle steam/electric generating system.

Compression ignition means relating to a type of stationary internal combustion engine that is not a spark ignition engine.

Date of manufacture means one of the following things:

(1) For freshly manufactured engines and modified engines, date of manufacture means the date the engine is originally produced.

(2) For reconstructed engines, date of manufacture means the date the engine was originally produced, except as specified in paragraph (3) of this definition.

(3) Reconstructed engines are assigned a new date of manufacture if the fixed capital cost of the new and refurbished components exceeds 75 percent of the fixed capital cost of a comparable entirely new facility. An engine that is produced from a previously used engine block does not retain the date of manufacture of the engine in which the engine block was previously used if the engine is produced using all new components except for the engine block. In these cases, the date of manufacture is the date of reconstruction or the date the new engine is produced.

Diesel fuel means any liquid obtained from the distillation of petroleum with a boiling point of approximately 150 to 360 degrees Celsius. One commonly used form is number 2 distillate oil.

Digester gas means any gaseous by-product of wastewater treatment typically formed through the anaerobic decomposition of organic waste materials and composed principally of methane and carbon dioxide (CO₂).

Emergency stationary internal combustion engine means any stationary reciprocating internal combustion engine that meets all of the criteria in paragraphs (1) through (3) of this definition. All emergency stationary ICE must comply with the requirements specified in [§ 60.4243\(d\)](#) in order to be considered emergency stationary ICE. If the engine does not comply with the requirements specified in [§ 60.4243\(d\)](#), then it is not considered to be an emergency stationary ICE under this subpart.

(1) The stationary ICE is operated to provide electrical power or mechanical work during an emergency situation. Examples include stationary ICE used to produce power for critical networks or equipment (including power supplied to portions of a facility) when electric power from the local utility (or the normal power source, if the facility runs on its own power production) is interrupted, or stationary ICE used to pump water in the case of fire or flood, etc.

(2) The stationary ICE is operated under limited circumstances for situations not included in paragraph (1) of this definition, as specified in [§ 60.4243\(d\)](#).

(3) The stationary ICE operates as part of a financial arrangement with another entity in situations not included in paragraph (1) of this definition only as allowed in [§ 60.4243\(d\)\(3\)\(i\)](#).

Engine manufacturer means the manufacturer of the engine. See the definition of “manufacturer” in this section.

Four-stroke engine means any type of engine which completes the power cycle in two crankshaft revolutions, with intake and compression strokes in the first revolution and power and exhaust strokes in the second revolution.

Freshly manufactured engine means an engine that has not been placed into service. An engine becomes freshly manufactured when it is originally produced.

Gasoline means any fuel sold in any State for use in motor vehicles and motor vehicle engines, or nonroad or stationary engines, and commonly or commercially known or sold as gasoline.

Installed means the engine is placed and secured at the location where it is intended to be operated.

Landfill gas means a gaseous by-product of the land application of municipal refuse typically formed through the anaerobic decomposition of waste materials and composed principally of methane and CO₂.

Lean burn engine means any two-stroke or four-stroke spark ignited engine that does not meet the definition of a rich burn engine.

Liquefied petroleum gas means any liquefied hydrocarbon gas obtained as a by-product in petroleum refining or natural gas production.

Manufacturer has the meaning given in section 216(1) of the Clean Air Act. In general, this term includes any person who manufactures a stationary engine for sale in the United States or otherwise introduces a new stationary engine into commerce in the United States. This includes importers who import stationary engines for resale.

Maximum engine power means maximum engine power as defined in [40 CFR 1048.801](#).

Model year means the calendar year in which an engine is manufactured (see “date of manufacture”), except as follows:

(1) Model year means the annual new model production period of the engine manufacturer in which an engine is manufactured (see “date of manufacture”), if the annual new model production period is different than the calendar year and includes January 1 of the calendar year for which the model year is named. It may not begin before January 2 of the previous calendar year and it must end by December 31 of the named calendar year.

(2) For an engine that is converted to a stationary engine after being placed into service as a nonroad or other non-stationary engine, model year means the calendar year or new model production period in which the engine was manufactured (see “date of manufacture”).

Natural gas means a naturally occurring mixture of hydrocarbon and non-hydrocarbon gases found in geologic formations beneath the Earth's surface, of which the principal constituent is methane. Natural gas may be field or pipeline quality.

Other internal combustion engine means any internal combustion engine, except combustion turbines, which is not a reciprocating internal combustion engine or rotary internal combustion engine.

Pipeline-quality natural gas means a naturally occurring fluid mixture of hydrocarbons (e.g., methane, ethane, or propane) produced in geological formations beneath the Earth's surface that maintains a gaseous state at standard atmospheric temperature and pressure under ordinary conditions, and which is provided by a supplier through a pipeline. Pipeline-quality natural gas must either be composed of at least 70 percent methane by volume or have a gross calorific value between 950 and 1,100 British thermal units per standard cubic foot.

Rich burn engine means any four-stroke spark ignited engine where the manufacturer's recommended operating air/fuel ratio divided by the stoichiometric air/fuel ratio at full load conditions is less than or equal to 1.1. Engines originally manufactured as rich burn engines, but modified prior to June 12, 2006, with passive emission control technology for NO_x (such as pre-combustion chambers) will be considered lean burn engines. Also, existing engines where there are no manufacturer's recommendations regarding air/fuel ratio will be considered a rich burn engine if the excess oxygen content of the exhaust at full load conditions is less than or equal to 2 percent.

Rotary internal combustion engine means any internal combustion engine which uses rotary motion to convert heat energy into mechanical work.

Spark ignition means relating to either: a gasoline-fueled engine; or any other type of engine with a spark plug (or other sparking device) and with operating characteristics significantly similar to the theoretical Otto combustion cycle. Spark ignition engines usually use a throttle to regulate intake air flow to control power during normal operation. Dual-fuel engines in which a liquid fuel (typically diesel fuel) is used for compression ignition and gaseous fuel (typically natural gas) is used as the primary fuel at an annual average ratio of less than 2 parts diesel fuel to 100 parts total fuel on an energy equivalent basis are spark ignition engines.

Stationary internal combustion engine means any internal combustion engine, except combustion turbines, that converts heat energy into mechanical work and is not mobile. Stationary ICE differ from mobile ICE in that a stationary internal combustion engine is not a nonroad engine as defined at [40 CFR 1068.30](#) (excluding paragraph (2)(ii) of that definition), and is not used to propel a motor vehicle, aircraft, or a vehicle used solely for competition. Stationary ICE include reciprocating ICE, rotary ICE, and other ICE, except combustion turbines.

Stationary internal combustion engine test cell/stand means an engine test cell/stand, as defined in [40 CFR part 63, subpart PPPPP](#), that tests stationary ICE.

Stoichiometric means the theoretical air-to-fuel ratio required for complete combustion.

Subpart means [40 CFR part 60, subpart JJJJ](#).

Two-stroke engine means a type of engine which completes the power cycle in single crankshaft revolution by combining the intake and compression operations into one stroke and the power and exhaust operations into a second stroke. This system requires auxiliary scavenging and inherently runs lean of stoichiometric.

Volatile organic compounds means volatile organic compounds as defined in [40 CFR 51.100\(s\)](#).

Voluntary certification program means an optional engine certification program that manufacturers of stationary SI internal combustion engines with a maximum engine power greater than 19 KW (25 HP) that do not use gasoline and are not rich burn engines that use LPG can choose to participate in to certify their engines to the emission standards in [§ 60.4231\(d\)](#) or [\(e\)](#), as applicable.

[[73 FR 3591](#), Jan. 18, 2008, as amended at [73 FR 59177](#), Oct. 8, 2008; [76 FR 37974](#), June 28, 2011; [78 FR 6698](#), Jan. 30, 2013; [86 FR 34363](#), June 29, 2021; [87 FR 48606](#), Aug. 10, 2022]

Table 1 to Subpart JJJJ of Part 60—NO_x, CO, and VOC Emission Standards for Stationary Non-Emergency SI Engines ≥100 HP (Except Gasoline and Rich Burn LPG), Stationary SI Landfill/Digester Gas Engines, and Stationary Emergency Engines >25 HP

Engine type and fuel	Maximum engine power	Manufacture date	Emission standards ^a					
			g/HP-hr			ppmvd at 15% O ₂		
			NO _x	CO	VOC ^d	NO _x	CO	VOC ^d
Non-Emergency SI Natural Gas ^b and Non-Emergency SI Lean Burn LPG ^b	100≤HP<500	7/1/2008	2.0	4.0	1.0	160	540	86
		1/1/2011	1.0	2.0	0.7	82	270	60
Non-Emergency SI Lean Burn Natural Gas and LPG	500≤HP<1,350	1/1/2008	2.0	4.0	1.0	160	540	86
		7/1/2010	1.0	2.0	0.7	82	270	60
Non-Emergency SI Natural Gas and Non-Emergency SI Lean Burn LPG (except lean burn 500≤HP<1,350)	HP≥500	7/1/2007	2.0	4.0	1.0	160	540	86
		7/1/2010	1.0	2.0	0.7	82	270	60
Landfill/Digester Gas (except lean burn 500≤HP<1,350)	HP<500	7/1/2008	3.0	5.0	1.0	220	610	80

Engine type and fuel	Maximum engine power	Manufacture date	Emission standards ^a					
			g/HP-hr			ppmvd at 15% O ₂		
			NO _x	CO	VOC ^d	NO _x	CO	VOC ^d
	HP≥500	1/1/2011	2.0	5.0	1.0	150	610	80
		7/1/2007	3.0	5.0	1.0	220	610	80
		7/1/2010	2.0	5.0	1.0	150	610	80
Landfill/Digester Gas Lean Burn	500≤HP<1,350	1/1/2008	3.0	5.0	1.0	220	610	80
		7/1/2010	2.0	5.0	1.0	150	610	80
Emergency	25<HP<130	1/1/2009	^c 10	387	N/A	N/A	N/A	N/A
	HP≥130		2.0	4.0	1.0	160	540	86

^a Owners and operators of stationary non-certified SI engines may choose to comply with the emission standards in units of either g/HP-hr or ppmvd at 15 percent O₂.

^b Owners and operators of new or reconstructed non-emergency lean burn SI stationary engines with a site rating of greater than or equal to 250 brake HP located at a major source that are meeting the requirements of [40 CFR part 63, subpart ZZZZ](#), Table 2a do not have to comply with the CO emission standards of Table 1 of this subpart.

^c The emission standards applicable to emergency engines between 25 HP and 130 HP are in terms of NO_x + HC.

^d For purposes of this subpart, when calculating emissions of volatile organic compounds, emissions of formaldehyde should not be included.

[[76 FR 37975](#), June 28, 2011]

Table 2 to Subpart JJJJ of Part 60—Requirements for Performance Tests

As stated in [§ 60.4244](#), you must comply with the following requirements for performance tests within 10 percent of 100 percent peak (or the highest achievable) load].

For each	Complying with the requirement to	You must	Using	According to the following requirements
1. Stationary SI internal combustion engine	a. Limit the concentration of NO _x in the stationary SI	i. Select the sampling port location and the number/location of	(1) Method 1 or 1A of 40 CFR part 60, appendix A-1 , if	(a) Alternatively, for NO _x , O ₂ , and moisture measurement, ducts

For each	Complying with the requirement to	You must	Using	According to the following requirements
demonstrating compliance according to § 60.4244	internal combustion engine exhaust	traverse points at the exhaust of the stationary internal combustion engine;	measuring flow rate	<p>≤6 inches in diameter may be sampled at a single point located at the duct centroid and ducts >6 and ≤12 inches in diameter may be sampled at 3 traverse points located at 16.7, 50.0, and 83.3% of the measurement line ('3-point long line'). If the duct is >12 inches in diameter and the sampling port location meets the two and half-diameter criterion of Section 11.1.1 of Method 1 of 40 CFR part 60, Appendix A, the duct may be sampled at '3-point long line'; otherwise, conduct the stratification testing and select sampling points according to Section 8.1.2 of Method 7E of 40 CFR part 60, Appendix A.</p>
		<p>ii. Determine the O₂ concentration of the stationary internal combustion engine exhaust at the sampling port location;</p>	<p>(2) Method 3, 3A, or 3B^b of 40 CFR part 60, appendix A-2 or ASTM Method D6522-00 (Reapproved 2005)^{a d}</p>	<p>(b) Measurements to determine O₂ concentration must be made at the same time as the measurements for NO_x concentration.</p>
		<p>iii. If necessary, determine the exhaust flowrate of the stationary</p>	<p>(3) Method 2 or 2C of 40 CFR part 60, appendix A-1 or Method 19 of 40</p>	<p>(c) Measurements to determine the exhaust flowrate must be made (1) at the same</p>

For each	Complying with the requirement to	You must	Using	According to the following requirements
		internal combustion engine exhaust;	CFR part 60, appendix A-7	time as the measurement for NO _x concentration or, alternatively (2) according to the option in Section 11.1.2 of Method 1A of 40 CFR part 60, Appendix A-1 , if applicable.
		iv. If necessary, measure moisture content of the stationary internal combustion engine exhaust at the sampling port location; and	(4) Method 4 of 40 CFR part 60, appendix A-3 , Method 320 of 40 CFR part 63, appendix A , ^e or ASTM Method D6348-03 ^{d e}	(d) Measurements to determine moisture must be made at the same time as the measurement for NO _x concentration.
		v. Measure NO _x at the exhaust of the stationary internal combustion engine; if using a control device, the sampling site must be located at the outlet of the control device	(5) Method 7E of 40 CFR part 60, appendix A-4 , ASTM Method D6522-00 (Reapproved 2005), ^{a d} Method 320 of 40 CFR part 63, appendix A , ^e or ASTM Method D6348-03 ^{d e}	(e) Results of this test consist of the average of the three 1-hour or longer runs.
	b. Limit the concentration of CO in the stationary SI internal combustion engine exhaust	i. Select the sampling port location and the number/location of traverse points at the exhaust of the stationary internal combustion engine;	(1) Method 1 or 1A of 40 CFR part 60, appendix A-1 , if measuring flow rate	(a) Alternatively, for CO, O ₂ , and moisture measurement, ducts ≤6 inches in diameter may be sampled at a single point located at the duct centroid and ducts >6 and ≤12 inches in diameter may be sampled at 3 traverse points located at 16.7, 50.0,

For each	Complying with the requirement to	You must	Using	According to the following requirements
----------	-----------------------------------	----------	-------	-----------------------------------------

and 83.3% of the measurement line ('3-point long line'). If the duct is >12 inches in diameter *and* the sampling port location meets the two and half-diameter criterion of [Section 11.1.1](#) of Method 1 of [40 CFR part 60, Appendix A](#), the duct may be sampled at '3-point long line'; otherwise, conduct the stratification testing and select sampling points according to [Section 8.1.2](#) of Method 7E of [40 CFR part 60, Appendix A](#).

ii. Determine the O₂ concentration of the stationary internal combustion engine exhaust at the sampling port location;

(2) Method 3, 3A, or 3B^b of [40 CFR part 60, appendix A-2](#) or ASTM Method D6522-00 (Reapproved 2005)^{a d}

(b) Measurements to determine O₂ concentration must be made at the same time as the measurements for CO concentration.

iii. If necessary, determine the exhaust flowrate of the stationary internal combustion engine exhaust;

(3) Method 2 or 2C of [40 CFR 60, appendix A-1](#) or Method 19 of [40 CFR part 60, appendix A-7](#)

(c) Measurements to determine the exhaust flowrate must be made (1) at the same time as the measurement for CO concentration or, alternatively (2) according to the option in [Section 11.1.2](#) of Method 1A of [40 CFR part 60,](#)

For each	Complying with the requirement to	You must	Using	According to the following requirements
		<p>iv. If necessary, measure moisture content of the stationary internal combustion engine exhaust at the sampling port location; and</p> <p>v. Measure CO at the exhaust of the stationary internal combustion engine; if using a control device, the sampling site must be located at the outlet of the control device</p>	<p>(4) Method 4 of 40 CFR part 60, appendix A-3, Method 320 of 40 CFR part 63, appendix A,^c or ASTM Method D6348-03^{d e}</p> <p>(5) Method 10 of 40 CFR part 60, appendix A4, ASTM Method D6522-00 (Reapproved 2005),^{a d e} Method 320 of 40 CFR part 63, appendix A,^c or ASTM Method D6348-03^{d e}</p>	<p>Appendix A-1, if applicable.</p> <p>(d) Measurements to determine moisture must be made at the same time as the measurement for CO concentration.</p> <p>(e) Results of this test consist of the average of the three 1-hour or longer runs.</p> <p>(a) Alternatively, for VOC, O₂, and moisture measurement, ducts ≤6 inches in diameter may be sampled at a single point located at the duct centroid and ducts >6 and ≤12 inches in diameter may be sampled at 3 traverse points located at 16.7, 50.0, and 83.3% of the measurement line ('3-point long line'). If the duct is >12 inches in diameter and the sampling port location meets the</p>
	c. Limit the concentration of VOC in the stationary SI internal combustion engine exhaust	i. Select the sampling port location and the number/location of traverse points at the exhaust of the stationary internal combustion engine;	(1) Method 1 or 1A of 40 CFR part 60, appendix A-1 , if measuring flow rate	

For each	Complying with the requirement to	You must	Using	According to the following requirements
				<p>two and half-diameter criterion of Section 11.1.1 of Method 1 of 40 CFR part 60, Appendix A, the duct may be sampled at '3-point long line'; otherwise, conduct the stratification testing and select sampling points according to Section 8.1.2 of Method 7E of 40 CFR part 60, Appendix A.</p>
	<p>ii. Determine the O₂ concentration of the stationary internal combustion engine exhaust at the sampling port location;</p>	<p>(2) Method 3, 3A, or 3B^b of 40 CFR part 60, appendix A-2 or ASTM Method D6522-00 (Reapproved 2005)^{a d}</p>		<p>(b) Measurements to determine O₂ concentration must be made at the same time as the measurements for VOC concentration.</p>
	<p>iii. If necessary, determine the exhaust flowrate of the stationary internal combustion engine exhaust;</p>	<p>(3) Method 2 or 2C of 40 CFR 60, appendix A-1 or Method 19 of 40 CFR part 60, appendix A-7</p>		<p>(c) Measurements to determine the exhaust flowrate must be made (1) at the same time as the measurement for VOC concentration or, alternatively (2) according to the option in Section 11.1.2 of Method 1A of 40 CFR part 60, Appendix A-1, if applicable.</p>
	<p>iv. If necessary, measure moisture content of the stationary internal combustion engine</p>	<p>(4) Method 4 of 40 CFR part 60, appendix A-3, Method 320 of 40 CFR part 63,</p>		<p>(d) Measurements to determine moisture must be made at the same time as the</p>

For each	Complying with the requirement to	You must	Using	According to the following requirements
		exhaust at the sampling port location; and v. Measure VOC at the exhaust of the stationary internal combustion engine; if using a control device, the sampling site must be located at the outlet of the control device	appendix A , ^e or ASTM Method D6348–03 ^{d e} (5) Methods 25A and 18 of 40 CFR part 60 , appendices A–6 and A–7, Method 25A with the use of a hydrocarbon cutter as described in 40 CFR 1065.265 , Method 18 of 40 CFR part 60, appendix A–6 , ^{c e} Method 320 of 40 CFR part 63, appendix A , ^c or ASTM Method D6348–03 ^{d e}	measurement for VOC concentration. (e) Results of this test consist of the average of the three 1-hour or longer runs.

^a Also, you may petition the Administrator for approval to use alternative methods for portable analyzer.

^b You may use ASME PTC 19.10–1981, Flue and Exhaust Gas Analyses, for measuring the O₂ content of the exhaust gas as an alternative to EPA Method 3B. AMSE PTC 19.10–1981 incorporated by reference, see [40 CFR 60.17](#)

^c You may use EPA Method 18 of [40 CFR part 60, appendix A–6](#), provided that you conduct an adequate pre-survey test prior to the emissions test, such as the one described in OTM 11 on EPA's website (<http://www.epa.gov/ttn/emc/prelim/otm11.pdf>).

^d Incorporated by reference; see [40 CFR 60.17](#).

^e You must meet the requirements in [§ 60.4245\(d\)](#).

[[85 FR 63408](#), Oct. 7, 2020]

Table 3 to Subpart JJJJ of Part 60—Applicability of General Provisions to Subpart JJJJ

[As stated in [§ 60.4246](#), you must comply with the following applicable General Provisions]

General provisions citation	Subject of citation	Applies to subpart	Explanation
§ 60.1	General applicability of the General Provisions	Yes	
§ 60.2	Definitions	Yes	Additional terms defined in § 60.4248 .
§ 60.3	Units and abbreviations	Yes	
§ 60.4	Address	Yes	
§ 60.5	Determination of construction or modification	Yes	
§ 60.6	Review of plans	Yes	
§ 60.7	Notification and Recordkeeping	Yes	Except that § 60.7 only applies as specified in § 60.4245 .
§ 60.8	Performance tests	Yes	Except that § 60.8 only applies to owners and operators who are subject to performance testing in subpart JJJJ.
§ 60.9	Availability of information	Yes	
§ 60.10	State Authority	Yes	
§ 60.11	Compliance with standards and maintenance requirements	Yes	Requirements are specified in subpart JJJJ.
§ 60.12	Circumvention	Yes	
§ 60.13	Monitoring requirements	No	
§ 60.14	Modification	Yes	
§ 60.15	Reconstruction	Yes	
§ 60.16	Priority list	Yes	
§ 60.17	Incorporations by reference	Yes	
§ 60.18	General control device requirements	No	
§ 60.19	General notification and reporting requirements	Yes	

Table 4 to Subpart JJJJ of Part 60—Applicability of Mobile Source Provisions for Manufacturers Participating in the

Voluntary Certification Program and Certifying Stationary SI ICE to Emission Standards in Table 1 of Subpart JJJJ

[As stated in [§ 60.4247](#), you must comply with the following applicable mobile source provisions if you are a manufacturer participating in the voluntary certification program and certifying stationary SI ICE to emission standards in Table 1 of subpart JJJJ]

Mobile source provisions citation	Subject of citation	Applies to subpart	Explanation
1048 subpart A	Overview and Applicability	Yes	
1048 subpart B	Emission Standards and Related Requirements	Yes	Except for the specific sections below.
1048.101	Exhaust Emission Standards	No	
1048.105	Evaporative Emission Standards	No	
1048.110	Diagnosing Malfunctions	No	
1048.140	Certifying Blue Sky Series Engines	No	
1048.145	Interim Provisions	No	
1048 subpart C	Certifying Engine Families	Yes	Except for the specific sections below.
1048.205(b)	AECD reporting	Yes	
1048.205(c)	OBD Requirements	No	
1048.205(n)	Deterioration Factors	Yes	Except as indicated in 60.4247(c).
1048.205(p)(1)	Deterioration Factor Discussion	Yes	
1048.205(p)(2)	Liquid Fuels as they require	No	
1048.240(b)(c)(d)	Deterioration Factors	Yes	
1048 subpart D	Testing Production-Line Engines	Yes	
1048 subpart E	Testing In-Use Engines	No	
1048 subpart F	Test Procedures	Yes	
1065.5(a)(4)	Raw sampling (refers reader back to the specific emissions regulation for guidance)	Yes	
1048 subpart G	Compliance Provisions	Yes	
1048 subpart H	Reserved		
1048 subpart I	Definitions and Other Reference Information	Yes	
1048 appendix I and II	Yes		

Mobile source provisions citation	Subject of citation	Applies to subpart	Explanation
1065 (all subparts)	Engine Testing Procedures	Yes	Except for the specific section below.
1065.715	Test Fuel Specifications for Natural Gas	No	
1068 (all subparts)	General Compliance Provisions for Nonroad Programs	Yes	Except for the specific sections below.
1068.245	Hardship Provisions for Unusual Circumstances	No	
1068.250	Hardship Provisions for Small-Volume Manufacturers	No	
1068.255	Hardship Provisions for Equipment Manufacturers and Secondary Engine Manufacturers	No	