

# ADEQ

ARKANSAS  
Department of Environmental Quality

OCT - 6 2016

Bryan Grunsky, Complex Manager  
Georgia-Pacific Chemicals LLC  
P.O. Box 520  
Crossett, AR 71635

Dear Mr. Grunsky:

The enclosed Permit No. 1177-AOP-R15 is your authority to construct, operate, and maintain the equipment and/or control apparatus as set forth in your application initially received on 9/6/2016.

After considering the facts and requirements of A.C.A. §8-4-101 et seq. as referenced by §8-4-304, and implementing regulations, I have determined that Permit No. 1177-AOP-R15 for the construction and operation of equipment at Georgia-Pacific Chemicals LLC shall be issued and effective on the date specified in the permit, unless a Commission review has been properly requested under Arkansas Department of Pollution Control & Ecology Commission's Administrative Procedures, Regulation 8, within thirty (30) days after service of this decision.

The applicant or permittee and any other person submitting public comments on the record may request an adjudicatory hearing and Commission review of the final permitting decisions as provided under Chapter Six of Regulation No. 8, Administrative Procedures, Arkansas Pollution Control and Ecology Commission. Such a request shall be in the form and manner required by Regulation 8.603, including filing a written Request for Hearing with the APC&E Commission Secretary at 101 E. Capitol Ave., Suite 205, Little Rock, Arkansas 72201. If you have any questions about filing the request, please call the Commission at 501-682-7890.

Sincerely,



Stuart Spencer  
Associate Director, Office of Air Quality

Enclosure: Final Permit

# ADEQ OPERATING AIR PERMIT

Pursuant to the Regulations of the Arkansas Operating Air Permit Program, Regulation 26:

Permit No. : 1177-AOP-R15

IS ISSUED TO:

Georgia-Pacific Chemicals LLC  
124 Paper Mill Road  
Crossett, AR 71635  
Ashley County  
AFIN: 02-00028

THIS PERMIT AUTHORIZES THE ABOVE REFERENCED PERMITTEE TO INSTALL, OPERATE, AND MAINTAIN THE EQUIPMENT AND EMISSION UNITS DESCRIBED IN THE PERMIT APPLICATION AND ON THE FOLLOWING PAGES. THIS PERMIT IS VALID BETWEEN:

March 14, 2016 AND March 13, 2021

THE PERMITTEE IS SUBJECT TO ALL LIMITS AND CONDITIONS CONTAINED HEREIN.

Signed:



\_\_\_\_\_  
Stuart Spencer  
Associate Director, Office of Air Quality

**OCT - 6 2016**

\_\_\_\_\_  
Date

Table of Contents

|   |    |
|---|----|
| <b>SECTION I: FACILITY INFORMATION</b> .....  | 6  |
| <b>SECTION II: INTRODUCTION</b> .....   | 7  |
| <b>Summary of Permit Activity</b> .....   | 7  |
| <b>Process Description</b> .....  | 7  |
| <b>Regulations</b> .....  | 8  |
| <b>Emission Summary</b> .....   | 9  |
| <b>SECTION III: PERMIT HISTORY</b> .....  | 19 |
| <b>SECTION IV: SPECIFIC CONDITIONS</b> .....  | 30 |
| <b>Facility-wide Sources</b> .....  | 30 |
| SN-05 Complex Boiler .....  | 30 |
| SN-11 RCI UFC/Formaldehyde Manufacturing Process Regenerative Thermal Oxidizer .....  | 34 |
| SN-129 Thermal Oxidizer .....   | 40 |
| SN-139 Tail Oil Products Loading Stations .....   | 44 |
| SN-136 Crude Tall Oil, Deaerator, and Novacote Resins Loading Stations .....  | 45 |
| SN-138 Resin Loading Stations .....   | 46 |
| SN-140 Emergency Generator Diesel Fired (GEN-2) .....   | 47 |
| SN-145 Haul Roads .....   | 49 |
| SN-146 Equipment Leaks (Fugitive) .....   | 50 |
| <b>Liquid Resins Manufacturing Sources</b> .....  | 51 |
| SN-13 Resi-Mix Silo Process Feed System Baghouse .....  | 51 |
| SN-18 Resi-Mix Silo Process Feed System baghouse .....  | 53 |
| SN-61 Cresylic Acid/Sec-Butylphenol Storage Tank .....  | 55 |
| SN-62 Phenol Storage Tank .....   | 56 |
| SN-63 and SN-65 Pre-polymer Storage Tanks .....   | 57 |
| SN-17 and SN-64 Novacote and DETA Storage Tanks .....   | 58 |
| SN-21, SN-22, SN-23, SN-30, SN-31, SN- 66, SN- 67, SN- 68, SN- 69, SN- 71, SN-73, SN-74, SN-77, SN-78, SN-79, SN-80, SN-81, SN-90, SN-91, SN-97, SN-98, SN-99, SN-100, and SN-102 ..... | 59 |
| SN-21, SN-22, SN-23, SN-30, SN-31, SN- 66, SN- 67, SN- 68, SN- 69, SN- 71, SN-73, SN-74, SN-77, SN-78, SN-79, SN-80, SN-81, SN-90, SN-91, SN-97, SN-98, SN-99, SN-100, and SN-102 ..... | 59 |
| N-21, SN-22, SN-23, SN-30, SN-31, SN- 66, SN- 67, SN- 68, SN- 69, SN- 71, SN-73, SN-74, SN-77, SN-78, SN-79, SN-80, SN-81, SN-90, SN-91, SN-97, SN-98, SN-99, SN-100, and SN-102 .....  | 60 |
| SN-95 Resin Plant Back-up Weigh tank .....  | 61 |
| SN-103 Novacote Resin Storage Tank .....  | 62 |
| SN-125 Formic Acid Storage Tank .....   | 63 |
| SN-132 and SN-133 Wet Strength Resin Loading Racks .....  | 64 |
| SN-135 Aqua Ammonia Storage Tank .....  | 65 |
| SN-142 Liquid Resin Manufacturing Cooling Tower .....   | 66 |
| <b>Spray Dry Resin Manufacturing sources</b> .....  | 68 |
| SN-03 Spray Dry Resin Process and Process Heater .....  | 68 |
| SN-104 and SN-105 Base Liquid Resin Storage Tanks .....   | 71 |

|   |     |
|---|-----|
| SN-148 Non-Bulk Packaging System with Dust Collector .....  | 72  |
| <b>Formaldehyde Production Plant Sources</b> .....  | 74  |
| SN-10 ICI Formaldehyde Process Oxidizer .....   | 74  |
| SN-143 Formaldehyde Production Cooling Tower .....  | 76  |
| <b>Tall Oil Fractionation Plant Sources</b> .....   | 78  |
| SN-01 Hot Oil Heater for TOFRAC Plant.....  | 78  |
| SN-14, SN-15, SN-16, SN-20, SN-24, SN-32, SN-33, SN-34, SN-35, SN-36, SN-37, SN-40,<br>SN-42, SN-43, SN-44, SN-45, SN-46, SN-47, SN-48, SN-49, SN-50, SN-51, SN-53, SN-54,<br>SN-55, SN-56, SN-57, SN-58, SN-107, SN-108, SN-109, SN-110, SN-111, SN-113, and SN-<br>119..... | 80  |
| <b>Rosin Size Plant Sources</b> .....   | 82  |
| SN-26, SN-41, SN-52, SN-118, SN-120, SN-121, SN-122, SN-123, and SN-126.....  | 82  |
| SN-147 Molten Maleic Anhydride Tank and Scrubber .....  | 84  |
| <b>Derivatives Plant Sources</b> .....  | 85  |
| SN-06 Derivatives Plant Solids Addition Baghouse .....  | 85  |
| SN-07 Derivatives Plant Hot Oil Heater.....   | 87  |
| SN-09 Derivatives Plant-Flaker Bagging Station .....  | 89  |
| SN-144 Derivatives Plant Cooling Tower .....  | 91  |
| SN-134 Wastewater Collection & Transfer System .....  | 93  |
| <b>SECTION V: COMPLIANCE PLAN AND SCHEDULE</b> .....  | 95  |
| <b>SECTION VI: PLANTWIDE CONDITIONS</b> .....   | 96  |
| Title VI Provisions .....   | 97  |
| Permit Shield.....  | 98  |
| <b>SECTION VII: INSIGNIFICANT ACTIVITIES</b> .....  | 104 |
| <b>SECTION VIII: GENERAL PROVISIONS</b> .....   | 106 |
| <b>APPENDIX A</b> - 40 C.F.R. Part 60, Subpart Dc   |     |
| <b>APPENDIX B</b> - 40 C.F.R. Part 60, Subpart Kb   |     |
| <b>APPENDIX C</b> - 40 C.F.R. Part 63, Subpart F  |     |
| <b>APPENDIX D</b> - 40 C.F.R. Part 63, Subpart G  |     |
| <b>APPENDIX E</b> - 40 C.F.R. Part 63, Subpart H  |     |
| <b>APPENDIX F</b> - 40 C.F.R. Part 63, Subpart W  |     |
| <b>APPENDIX G</b> - 40 C.F.R. Part 63, Subpart SS   |     |
| <b>APPENDIX H</b> - 40 C.F.R. Part 63, Subpart UU   |     |
| <b>APPENDIX I</b> - 40 C.F.R. Part 63, Subpart WW   |     |
| <b>APPENDIX J</b> - 40 C.F.R. Part 63, Subpart OOO  |     |
| <b>APPENDIX K</b> - 40 C.F.R. Part 63, Subpart FFFF   |     |
| <b>APPENDIX L</b> - 40 C.F.R. Part 61, Subpart FF   |     |
| <b>APPENDIX M</b> - 40 C.F.R. Part 63, Subpart ZZZZ   |     |

List of Acronyms and Abbreviations

|                  |  |
|------------------|--|
| Ark. Code Ann.   | Arkansas Code Annotated                                  |
| AFIN             | ADEQ Facility Identification Number                      |
| C.F.R.           | Code of Federal Regulations                              |
| CO               | Carbon Monoxide  |
| CTO              | Crude Tall Oil   |
| DETA             | Dithethylenetriaamine                                    |
| Dispro           | Disproportionated  |
| EPA              | Environmental Protection Agency                          |
| ESD              | Emulsifier – Spray Dried                                 |
| HAP              | Hazardous Air Pollutant                                  |
| HCHO             | Formaldehyde   |
| HON              | Hazardous Organic NESHAP                                 |
| ICI              | Imperial Chemical Industries                             |
| KOH              | Potassium Hydroxide                                      |
| lb/hr            | Pound Per Hour   |
| MACT             | Maximum Achievable Control Technology                    |
| MON              | Miscellaneous Organic NESHAP                             |
| MVAC             | Motor Vehicle Air Conditioner                            |
| NaOH             | Sodium Hydroxide   |
| NESHAP           | National Emission Standards for Hazardous Air Pollutants |
| No.              | Number   |
| NO <sub>x</sub>  | Nitrogen Oxide   |
| PF               | Phenol-Formadehyde                                       |
| PM               | Particulate Matter                                       |
| PM <sub>10</sub> | Particulate Matter Smaller Than Ten Microns              |
| POM              | Polycyclic Organic Matter                                |
| RCI              | Reichhold Chemical Industries                            |
| SNAP             | Significant New Alternatives Program (SNAP)              |
| SO <sub>2</sub>  | Sulfur Dioxide   |

Georgia-Pacific Chemicals LLC

Permit #: 1177-AOP-R15

AFIN: 02-00028

SSM Startup, Shutdown, and Malfunction Plan

TOC Total Organic Carbon

TOFRAC Tall Oil Fractionation

Tpy Tons Per Year

UF Urea-Formaldehyde

UFC Urea-Formaldehyde Concentrate

UTM Universal Transverse Mercator

VOC Volatile Organic Compound

WSR Wet Strength Resin

Georgia-Pacific Chemicals LLC  
Permit #: 1177-AOP-R15  
AFIN: 02-00028

**SECTION I: FACILITY INFORMATION**

PERMITTEE: Georgia-Pacific Chemicals LLC

AFIN: 02-00028

PERMIT NUMBER: 1177-AOP-R15

FACILITY ADDRESS: 124 Paper Mill Road  
Crossett, AR 71635

MAILING ADDRESS: P.O. Box 520  
Crossett, AR 71635

COUNTY: Ashley County

CONTACT NAME: Bryan Grunsky

CONTACT POSITION: Complex Manager

TELEPHONE NUMBER: (870) 567-7208

REVIEWING ENGINEER: Franck Houenou

UTM North South (Y): Zone 15: 3667113.99 m

UTM East West (X): Zone 15: 596457.63 m

## **SECTION II: INTRODUCTION**

### **Summary of Permit Activity**

Georgia Pacific Chemicals LLC, formerly Georgia-Pacific Resins, Inc., located at 124 Paper Mill Road, Crossett, Arkansas 71635. The facility has submitted an application for administrative amendment to re-install the previously removed sodium hydroxide storage tank M-5. This tank will replace the sodium hydroxide storage tank M-4 that has been removed. The sodium hydroxide storage tank M-5 is added to the permit as an insignificant activity. Also, the facility has requested to remove the word "storage" from the emission summary table group heading, to change the description of SN-121, SN-52, and of the sources in the table shown under Specific Condition #125. There is no change with the total permitted emissions rates.

### **Process Description**

The manufacturing complex of GP Chemicals consists of four distinct operating plants which are listed below. Two of the plants are made-up of several individual operations.

1. Tall Oil Manufacturing Plant
  - a. Crude Tall Oil Fractionation (TOFRAC) Plant
  - b. Rosin Size Plant
  - c. Rosin Derivatives and Pastillation Plant
2. Liquid Resin Manufacturing Plant
  - a. PF Resin Manufacturing
  - b. UF Resin Manufacturing
  - c. Wet Strength Resin Manufacturing
  - d. Novacote Resin Manufacturing
  - e. Resi-Mix Resin Manufacturing
3. Spray Dry Resin Manufacturing
4. Formaldehyde and Urea Formaldehyde Concentrate (UFC) Manufacturing Plant



### Regulations

The following table contains the regulations applicable to this permit.

| Regulations   |
|---|
| Arkansas Air Pollution Control Code, Regulation 18, effective March 14, 2016  |
| Regulations of the Arkansas Plan of Implementation for Air Pollution Control, Regulation 19, effective March 14, 2016   |
| Regulations of the Arkansas Operating Air Permit Program, Regulation 26, effective March 14, 2016   |
| 40 C.F.R. Part 52, Subpart E - Approval and Promulgation of Implementation Plans - Arkansas   |
| 40 C.F.R. Part 60, Subpart Dc – <i>Standards of Performance for Small Industrial-Commercial-Institutional Steam Generating Units</i>  |
| 40 C.F.R. Part 60, Subpart Kb – <i>Standards of Performance for Volatile Organic Liquid Storage Vessels</i>   |
| 40 C.F.R. Part 63, Subpart F – <i>National Emission Standards for Organic Hazardous Air Pollutants From the Synthetic Organic Chemical Manufacturing Industry</i>   |
| 40 C.F.R. Part 63, Subpart G – <i>National Emission Standards for Organic Hazardous Air Pollutants From the Synthetic Organic Chemical Manufacturing Industry for Process Vents, Storage Vessels, Transfer Operations, and Wastewater</i> |
| 40 C.F.R. Part 63, Subpart H – <i>National Emission Standards for Organic Hazardous Air Pollutants for Equipment Leaks</i>  |
| 40 C.F.R. Part 63, Subpart W – <i>National Emission Standards for Hazardous Air Pollutants for Epoxy Resins Production and Non - Nylon Polyamides Production,</i>   |
| 40 C.F.R. Part 63, Subpart SS – <i>National Emission Standard for Closed Vent Systems, Control Devices, Recovery Devices and Routing to a Fuel Gas System or a Process</i>  |
| 40 C.F.R. Part 63, Subpart UU – <i>National Emission Standards for Equipment Leaks - Control Level 2 Standards</i>  |
| 40 C.F.R. Part 63, Subpart WW – <i>National Emission Standards for Storage Vessels (Tanks)- Control Level 2</i>   |
| 40 C.F.R. Part 63, Subpart OOO – <i>National Emission Standards for Hazardous Air Pollutants for Amino/Phenolic Resins Production</i>   |
| 40 C.F.R. Part 63, Subpart FFFF – <i>National Emission Standards for Hazardous Air Pollutants for Miscellaneous Organic NESHAPS (MON)</i>   |
| 40 C.F.R. Part 61, Subpart FF – <i>National Emission Standards for Benzene Waste Operations</i>   |
| 40 C.F.R. Part 63, Subpart ZZZZ – <i>National Emission Standards for Hazardous Air Pollutants for Stationary Reciprocating Internal Combustion Engines (RICE)</i>   |

### Emission Summary

The following table is a summary of emissions from the facility. This table, in itself, is not an enforceable condition of the permit.

| EMISSION SUMMARY          |           |             |                   |                       |         |
|---------------------------|-----------|-------------|-------------------|-----------------------|---------|
| Source Number             | Equip ID. | Description | Pollutant         | Emission Rates        |         |
|                           |           |             |                   | lb/hr                 | tpy     |
| Total Allowable Emissions |           |             | PM                | 104.2                 | 249.0   |
|                           |           |             | PM <sub>10</sub>  | 103.8                 | 248.7   |
|                           |           |             | PM <sub>2.5</sub> | See Note <sup>1</sup> |         |
|                           |           |             | SO <sub>2</sub>   | 24.4                  | 99.5    |
|                           |           |             | VOC               | 173.8                 | 219.5   |
|                           |           |             | CO                | 28.1                  | 102.2   |
|                           |           |             | NO <sub>x</sub>   | 45.5                  | 112.8   |
| HAPs                      |           |             | Acetaldehyde      | 2.70                  | 11.55   |
|                           |           |             | Acrolein          | 0.02                  | 0.03    |
|                           |           |             | Chlorine          | 0.31                  | 1.30    |
|                           |           |             | Chloroform        | 0.18                  | 0.76    |
|                           |           |             | Ethylene Glycol   | 1.10                  | 4.60    |
|                           |           |             | Epichlorohydrin*  | 0.14                  | 0.27    |
|                           |           |             | Formaldehyde*     | 3.63                  | 13.60   |
|                           |           |             | Hexane            | 0.38                  | 1.62    |
|                           |           |             | Hydrogen Chloride | 2.23                  | 4.47    |
|                           |           |             | Maleic Anhydride* | 0.16                  | 0.46    |
|                           |           |             | Methanol*         | 30.81                 | 108.00  |
|                           |           |             | O-Cresol*         | 0.21                  | 0.05    |
|                           |           |             | Phenol*           | 5.934                 | 11.1302 |
|                           |           |             | Lead Compounds    | 0.10                  | 0.40    |
|                           |           |             | Cadmium           | 0.07                  | 0.07    |
|                           |           |             | POM (Total)       | 0.08                  | 0.08    |
|                           |           |             | Total Other HAPs  | 0.09                  | 0.18    |

| EMISSION SUMMARY              |           |  |                      |                |       |
|-------------------------------|-----------|--|----------------------|----------------|-------|
| Source Number                 | Equip ID. | Description  | Pollutant            | Emission Rates |       |
|                               |           |  |                      | lb/hr          | tpy   |
| Air Contaminants <sup>2</sup> |           |  | Total Iodine         | 4.20           | 3.80  |
|                               |           |  | Formic Acid          | 8.60           | 0.20  |
|                               |           |  | Ammonia              | 22.78          | 15.83 |
|                               |           |  | Dimethyl Ether (DME) | 0.56           | 2.45  |
| SN-01                         | HOH-1     | Hot Oil Heater for TOFRAC Plant (43.6 MMBTU/hr)            | PM                   | 0.4            | 1.5   |
|                               |           |  | PM <sub>10</sub>     | 0.4            | 1.5   |
|                               |           |  | SO <sub>2</sub>      | 0.1            | 0.2   |
|                               |           |  | VOC                  | 0.3            | 1.1   |
|                               |           |  | CO                   | 3.7            | 16.1  |
|                               |           |  | NO <sub>x</sub>      | 4.4            | 19.1  |
|                               |           |  | Cadmium              | 0.01           | 0.01  |
|                               |           |  | Formaldehyde         | 0.01           | 0.02  |
|                               |           |  | Hexane               | 0.08           | 0.35  |
|                               |           | POM (Total)  | 0.01                 | 0.01           |       |
| SN-03                         | BH-4      | Spray Dry Resin Process and Process Heater (15.4 MMBTU/hr) | PM                   | 11.7           | 46.3  |
|                               |           |  | PM <sub>10</sub>     | 11.7           | 46.3  |
|                               |           |  | SO <sub>2</sub>      | 0.1            | 0.1   |
|                               |           |  | VOC                  | 34.0           | 148.9 |
|                               |           |  | CO                   | 1.3            | 5.7   |
|                               |           |  | NO <sub>x</sub>      | 1.6            | 6.8   |
|                               |           |  | Ammonia              | 2.65           | 11.62 |
|                               |           |  | Acetaldehyde         | 2.20           | 9.50  |
|                               |           |  | Formaldehyde         | 2.20           | 9.62  |
|                               |           |  | Hexane               | 0.02           | 0.08  |
|                               |           |  | Methanol             | 21.80          | 95.38 |
|                               |           |  | Phenol               | 2.30           | 10.10 |
|                               |           |  | POM (Total)          | 0.01           | 0.01  |
|                               |           |  | Cadmium              | 0.01           | 0.01  |
| Dimethyl Ether                | 0.56      | 2.45   |                      |                |       |

| EMISSION SUMMARY |           |   |                               |                |       |
|------------------|-----------|---|-------------------------------|----------------|-------|
| Source Number    | Equip ID. | Description                                       | Pollutant                     | Emission Rates |       |
|                  |           |   |                               | lb/hr          | tpy   |
| SN-05            | B-1       | Complex Boiler/MON Control System (94.1 MMBTU/hr) | PM                            | 35.0           | 180.6 |
|                  |           |   | Sootblowing limit             | 85.0           |       |
|                  |           |   | PM <sub>10</sub>              | 35.0           | 180.6 |
|                  |           |   | Sootblowing limit             | 85.0           |       |
|                  |           |   | Lead Compounds                | 0.10           | 0.40  |
|                  |           |   | SO <sub>2</sub>               | 21.1           | 92.3  |
|                  |           |   | VOC                           | 4.6            | 20.1  |
|                  |           |   | CO                            | 8.0            | 34.7  |
|                  |           |   | NO <sub>x</sub>               | 13.3           | 58.0  |
|                  |           |   | Lead                          | 0.10           | 0.40  |
|                  |           |   | Total Iodine***               | 4.20**         | 3.80  |
|                  |           |   | Acetaldehyde                  | 0.02           | 0.07  |
|                  |           |   | Acrolein                      | 0.01           | 0.02  |
|                  |           |   | Formaldehyde                  | 0.04           | 0.15  |
|                  |           |   | Hexane                        | 0.22           | 0.96  |
|                  |           |   | Methanol                      | 0.03           | 0.12  |
| Phenol           | 0.05      | 0.22  |                               |                |       |
| POM (Total)      | 0.01      | 0.01  |                               |                |       |
| Cadmium          | 0.01      | 0.01  |                               |                |       |
| SN-06            | BH-5      | Derivatives Plant Solids Addition Baghouse        | PM                            | 0.5            | 1.8   |
|                  |           |   | PM <sub>10</sub>              | 0.5            | 1.8   |
|                  |           |   | VOC                           | 0.1            | 0.1   |
|                  |           |   | Formaldehyde Maleic Anhydride | 0.1            | 0.1   |
|                  |           |   |                               | 0.1            | 0.2   |
| SN-07            | HOH-2     | Derivatives Plant Hot Oil Heater (5.2 MMBTU/hr)   | PM                            | 0.1            | 0.2   |
|                  |           |   | PM <sub>10</sub>              | 0.1            | 0.2   |
|                  |           |   | SO <sub>2</sub>               | 0.1            | 0.1   |
|                  |           |   | VOC                           | 0.1            | 0.2   |
|                  |           |   | CO                            | 0.5            | 2.0   |
|                  |           |   | NO <sub>x</sub>               | 0.6            | 2.3   |
|                  |           |   | Formaldehyde                  | 0.01           | 0.01  |
|                  |           |   | Hexane                        | 0.01           | 0.05  |
|                  |           |   | POM (Total)                   | 0.01           | 0.01  |
|                  |           |   | Cadmium                       | 0.01           | 0.01  |
| SN-09            | BH-6      | Derivatives Plant Flaker Bagging Station          | PM                            | 0.8            | 3.2   |
|                  |           |   | PM <sub>10</sub>              | 0.8            | 3.2   |

| EMISSION SUMMARY |           |   |                   |                |      |
|------------------|-----------|---|-------------------|----------------|------|
| Source Number    | Equip ID. | Description   | Pollutant         | Emission Rates |      |
|                  |           |   |                   | lb/hr          | tpy  |
| SN-10            | OX-1      | ICI Formaldehyde Process Oxidizer (2.0 MMBTU/hr) with Waste Heat Recovery System        | PM                | 0.1            | 0.1  |
|                  |           |   | PM <sub>10</sub>  | 0.1            | 0.1  |
|                  |           |   | SO <sub>2</sub>   | 0.1            | 0.1  |
|                  |           |   | VOC               | 1.7            | 7.7  |
|                  |           |   | CO                | 0.2            | 0.9  |
|                  |           |   | NO <sub>x</sub>   | 0.2            | 0.9  |
|                  |           |   | Acetaldehyde      | 0.26           | 1.15 |
|                  |           |   | Formaldehyde      | 0.40           | 1.80 |
|                  |           |   | Hexane            | 0.01           | 0.02 |
|                  |           |   | Methanol          | 1.30           | 5.90 |
|                  |           |   | POM (Total)       | 0.01           | 0.01 |
| Cadmium          | 0.01      | 0.01  |                   |                |      |
| SN-11            | OX-2      | RCI UFC/Formaldehyde Manufacturing Process Regenerative Thermal Oxidizer (3.3 MMBTU/hr) | PM                | 0.1            | 0.2  |
|                  |           |   | PM <sub>10</sub>  | 0.1            | 0.2  |
|                  |           |   | SO <sub>2</sub>   | 0.1            | 0.1  |
|                  |           |   | VOC               | 2.4            | 8.1  |
|                  |           |   | CO                | 6.5            | 26.8 |
|                  |           |   | NO <sub>x</sub>   | 0.4            | 1.5  |
|                  |           |   | Acetaldehyde      | 0.03           | 0.11 |
|                  |           |   | Epichlorohydrin   | 0.10           | 0.10 |
|                  |           |   | Formaldehyde      | 0.20           | 0.50 |
|                  |           |   | Hexane            | 0.01           | 0.03 |
|                  |           |   | Hydrogen Chloride | 2.23           | 4.47 |
|                  |           |   | Methanol          | 0.90           | 2.20 |
|                  |           |   | Phenol            | 0.02           | 0.06 |
| POM (Total)      | 0.01      | 0.01  |                   |                |      |
| Cadmium          | 0.01      | 0.01  |                   |                |      |
| SN-13            | BH-2      | Resi-Mix Process Feed System Baghouse   | PM                | 0.1            | 0.4  |
|                  |           |   | PM <sub>10</sub>  | 0.1            | 0.4  |
| SN-17            | NC-1      | Novacote Storage Tank<br>32,130 gal   | Ammonia           | 0.3            | 0.3  |
| SN-18            | BH-3      | Resi-Mix Resin Process Mix Tank<br>5,288 gal  | PM                | 0.1            | 0.3  |
|                  |           |   | PM <sub>10</sub>  | 0.1            | 0.3  |
|                  |           |   | VOC               | 0.1            | 0.1  |
|                  |           |   | Formaldehyde      | 0.01           | 0.01 |
|                  |           |   | Methanol          | 0.01           | 0.01 |
|                  |           |   | Phenol            | 0.01           | 0.01 |

| EMISSION SUMMARY |           |   |                                 |                     |                     |
|------------------|-----------|---|---------------------------------|---------------------|---------------------|
| Source Number    | Equip ID. | Description   | Pollutant                       | Emission Rates      |                     |
|                  |           |   |                                 | lb/hr               | tpy                 |
| SN-61            | P-7       | Cresylic Acid/Secondary Butylphenols Storage Tank<br>20,304 gal         | VOC<br>O-Cresol<br>Phenol       | 0.4<br>0.20<br>0.30 | 0.1<br>0.01<br>0.01 |
| SN-62            | M-8       | Phenol Storage Tank<br>133,501 gal                                      | VOC<br>Phenol                   | 3.2<br>3.12         | 0.5<br>0.45         |
| SN-63            | P-8       | Pre-Polymer Storage Tank<br>25,366 gal                                  | VOC                             | 0.1                 | 0.4                 |
| SN-64            | M-15      | DETA Storage Tank<br>8,455 gal  | VOC                             | 0.2                 | 0.1                 |
| SN-65            | P-12      | Pre-Polymer Storage Tank<br>37,053 gal                                  | VOC                             | 0.1                 | 0.4                 |
| SN-92            | U-11      | UF Resin Storage Tank<br>25,366 gal                                     | Source has not been constructed |                     |                     |
| SN-93            | U-12      | UF Resin Storage Tank<br>25,366 gal                                     | Source has not been constructed |                     |                     |
| SN-94            | U-13      | UF Resin Storage Tank<br>25,366 gal                                     | Source has not been constructed |                     |                     |
| SN-95            | W-3       | DETA, Phenol, UFC, HCHO, and Pre-Polymer Process Weigh Tank - 9,710 gal | VOC<br>Total Other HAPs         | 0.1<br>0.09         | 0.2<br>0.18         |
| SN-103           | NC-2      | Novacote Resin Storage Tank<br>32,130 gal                               | Ammonia                         | 0.3                 | 0.3                 |
| SN-104           | SD-1      | Liquid Base Resin Storage Tank -<br>24,537 gal                          | VOC<br>Formaldehyde<br>Methanol | 0.1<br>0.01<br>0.02 | 0.1<br>0.01<br>0.06 |
| SN-105           | SD-2      | Liquid Base Resin Storage Tank -<br>24,537 gal                          | VOC<br>Formaldehyde<br>Methanol | 0.1<br>0.01<br>0.01 | 0.1<br>0.01<br>0.06 |

| EMISSION SUMMARY |           |   |                         |                |        |
|------------------|-----------|---|-------------------------|----------------|--------|
| Source Number    | Equip ID. | Description                               | Pollutant               | Emission Rates |        |
|                  |           |   |                         | lb/hr          | tpy    |
| SN-125           | Formic    | Formic Acid Storage Tank<br>10,000 gal    | Formic Acid             | 8.60           | 0.20   |
| SN-129           | OX-3      | Thermal Oxidizer<br>(2.5 MMBtu/hr)        | PM                      | 1.1            | 4.6    |
|                  |           |   | PM <sub>10</sub>        | 1.1            | 4.6    |
|                  |           |   | SO <sub>2</sub>         | 1.2            | 5.4    |
|                  |           |   | VOC                     | 0.5            | 2.2    |
|                  |           |   | CO                      | 2.8            | 12.2   |
|                  |           |   | NO <sub>x</sub>         | 1.6            | 6.7    |
|                  |           |   | Total Iodine***         | 4.20**         | 3.80   |
|                  |           |   | Acetaldehyde            | 0.01           | 0.01   |
|                  |           |   | Acrolein                | 0.01           | 0.01   |
|                  |           |   | Formaldehyde            | 0.02           | 0.06   |
|                  |           |   | Hexane                  | 0.03           | 0.13   |
|                  |           |   | Methanol                | 0.01           | 0.02   |
|                  |           |   | Phenol                  | 0.02           | 0.06   |
|                  |           |   | POM (Total)             | 0.01           | 0.01   |
| Cadmium          | 0.01      | 0.01                                      |                         |                |        |
| SN-132           | WSLOAD1   | Wet Strength Resin Loading Rack           | VOC                     | 0.1            | 0.3    |
| SN-133           | WSLOAD2   | Wet Strength Resin Loading Rack           | VOC                     | 0.1            | 0.3    |
| SN-134           | --        | Wastewater Collection & Transfer System   | VOC                     | 6.6            | 4.1    |
|                  |           |   | Ammonia                 | 0.03           | 0.11   |
|                  |           |   | Acetaldehyde            | 0.17           | 0.70   |
|                  |           |   | Formaldehyde            | 0.41           | 0.57   |
|                  |           |   | Methanol                | 5.88           | 1.59   |
|                  |           |   | Phenol                  | 0.004          | 0.0002 |
| SN-135           | M-14      | Aqua Ammonia Storage Tank                 | Ammonia                 | 19.1           | 1.9    |
| SN-136           | --        | Crude Tall Oil, Novacote Loading Stations | VOC                     | 0.1            | 0.2    |
|                  |           |   | Ammonia                 | 0.4            | 1.6    |
| SN-137           | --        | Formaldehyde/UFC Loading Stations         | Source has been removed |                |        |
| SN-138           | --        | Resin Loading Stations                    | VOC                     | 0.4            | 1.2    |
|                  |           |   | Formaldehyde            | 0.02           | 0.05   |
|                  |           |   | Methanol                | 0.17           | 0.60   |
|                  |           |   | Phenol                  | 0.02           | 0.06   |

| EMISSION SUMMARY |           |  |                  |                |      |
|------------------|-----------|--|------------------|----------------|------|
| Source Number    | Equip ID. | Description                              | Pollutant        | Emission Rates |      |
|                  |           |  |                  | lb/hr          | tpy  |
| SN-139           | --        | Tall Oil Products Loading Stations       | VOC              | 15.0           | 2.8  |
| SN-140           | GEN-2     | Emergency Generator Diesel Fired         | PM               | 1.7            | 1.3  |
|                  |           |  | PM <sub>10</sub> | 1.7            | 1.3  |
|                  |           |  | SO <sub>2</sub>  | 1.6            | 1.2  |
|                  |           |  | VOC              | 2.0            | 1.5  |
|                  |           |  | CO               | 5.1            | 3.8  |
|                  |           |  | NO <sub>x</sub>  | 23.4           | 17.5 |
|                  |           |  | Acetaldehyde     | 0.01           | 0.01 |
|                  |           |  | Formaldehyde     | 0.01           | 0.01 |
|                  |           |  | POM (Total)      | 0.01           | 0.01 |
| SN-142           | --        | Liquid Resin Manufacturing Cooling Tower | PM               | 0.8            | 3.4  |
|                  |           |  | PM <sub>10</sub> | 0.8            | 3.4  |
|                  |           |  | VOC              | 0.1            | 0.4  |
|                  |           |  | Chlorine         | 0.16           | 0.68 |
|                  |           |  | Chloroform       | 0.08           | 0.34 |
| SN-143           | --        | Formaldehyde Production Cooling Tower    | PM               | 0.4            | 1.5  |
|                  |           |  | PM <sub>10</sub> | 0.4            | 1.5  |
|                  |           |  | VOC              | 0.1            | 0.2  |
|                  |           |  | Chlorine         | 0.07           | 0.29 |
|                  |           |  | Chloroform       | 0.04           | 0.15 |
| SN-144           | --        | Derivatives Plant Cooling Tower          | PM               | 0.6            | 2.7  |
|                  |           |  | PM <sub>10</sub> | 0.6            | 2.7  |
|                  |           |  | VOC              | 0.1            | 0.3  |
|                  |           |  | Chlorine         | 0.08           | 0.33 |
|                  |           |  | Chloroform       | 0.06           | 0.27 |
| SN-145           | --        | Haul Roads                               | PM               | 0.5            | 0.4  |
|                  |           |  | PM <sub>10</sub> | 0.1            | 0.1  |
| SN-146           | --        | Equipment Leaks Fugitive Emissions       | VOC              | 1.7            | 7.5  |
|                  |           |  | Epichlorohydrin  | 0.04           | 0.17 |
|                  |           |  | Cresol-O         | 0.01           | 0.04 |
|                  |           |  | Formaldehyde     | 0.15           | 0.66 |
|                  |           |  | Methanol         | 0.43           | 1.90 |
|                  |           |  | Phenol           | 0.03           | 0.12 |
|                  |           |  | Ethylene Glycol  | 1.10           | 4.60 |
| SN-147           | --        | Molten Maleic Anhydride Storage Tank     | VOC              | 0.1            | 0.3  |
|                  |           |  | Maleic Anhydride | 0.06           | 0.26 |
| SN-148           | --        | Non-Bulk Packaging System                | PM               | 0.2            | 0.5  |
|                  |           |  | PM <sub>10</sub> | 0.2            | 0.5  |



| EMISSION SUMMARY                          |           |   |           |                |     |
|---|-----------|---|-----------|----------------|-----|
| Source Number                             | Equip ID. | Description   | Pollutant | Emission Rates |     |
|   |           |   |           | lb/hr          | tpy |
| <b>Tall Oil Fractionation Plant Tanks</b> |           |   |           |                |     |
| SN-14                                     | T-43      | Tall Oil Fatty Acid Storage Tank, 260,000 gal       | VOC       | 67.8           | 8.7 |
| SN-15                                     | T-44      | Tall Oil Fatty Acid Storage Tank 80,737 gal         |           |                |     |
| SN-16                                     | T-41      | Tall Oil Fatty Acid Storage Tank, 835,176 gal       |           |                |     |
| SN-20                                     | T-42      | Crude talk Oil Storage Tank, 835,176 gal            |           |                |     |
| SN-24                                     | T-21      | Tall Oil Rosin Storage Tank 25,366 gal              |           |                |     |
| SN-32                                     | T-47      | Pitch Storage Tank, 75,159 gal                      |           |                |     |
| SN-33                                     | T-20      | Heads Storage Tank, 25,366 gal                      |           |                |     |
| SN-34                                     | T-31      | Heads Storage Tank, 25,366 gal                      |           |                |     |
| SN-35                                     | T-49      | Tall Oil Rosin Storage Tank, 146,795 gal            |           |                |     |
| SN-36                                     | T-26      | 502 Bottoms Storage Tank, 27,057 gal                |           |                |     |
| SN-37                                     | T-50      | Rosin Drumming Tank and Drumming Station, 5,707 gal |           |                |     |
| SN-40                                     | T-40      | Crude Tall Oil Storage Tank 835,000 gal             |           |                |     |
| SN-42                                     | T-6       | Distilled Tall Oil Storage Tank 30,439 gal          |           |                |     |
| SN-43                                     | T-24      | Pitch Storage Tank 30,439 gal                       |           |                |     |
| SN-44                                     | T-36      | Pitch Storage Tank 18,602 gal                       |           |                |     |
| SN-45                                     | T-19      | Heads Storage Tank, 25,366 gal                      |           |                |     |
| SN-46                                     | T-22      | Tall Oil Fatty Acid Storage Tank 25,366 gal         |           |                |     |
| SN-47                                     | T-29      | Heads Storage Tank, 25,366 gal                      |           |                |     |
| SN-48                                     | T-17      | Tall Oil Fatty Acid Storage Tank 25,366 gal         |           |                |     |
| SN-49                                     | T-18      | Tall Oil Fatty Acid Storage Tank 25,366 gal         |           |                |     |
| SN-50                                     | T-25      | 502 Bottoms Storage Tank 25,366 gal                 |           |                |     |
| SN-51                                     | T-23      | Distilled Tall Oil, 25,366 gal                      |           |                |     |
| SN-53                                     | T-8       | Tall Oil Rosin Storage Tank, 25,366 gal             |           |                |     |
| SN-54                                     | T-9       | Tall Oil Rosin Storage Tank, 29,934 gal             |           |                |     |
| SN-55                                     | T-10      | Tall Oil Rosin Storage Tank, 25,366 gal             |           |                |     |
| SN-56                                     | T-12      | Tall Oil Rosin Storage Tank, 25,366 gal             |           |                |     |
| SN-57                                     | T-48      | Tall Oil Fatty Acid Storage Tank 48,102 gal         |           |                |     |
| SN-58                                     | T-46      | Tall Oil Fatty Acid Storage Tank 146,795 gal        |           |                |     |
| SN-107                                    | T-27      | Tall Oil Blend Tank, 30,439 gal                     |           |                |     |
| SN-108                                    | T-28      | Tall Oil Blend Tank, 30,439 gal                     |           |                |     |
| SN-109                                    | T-30      | Tall Oil Blend Tank, 30,439 gal                     |           |                |     |
| SN-110                                    | T-32      | Tall Oil Blend Tank, 16,611 gal                     |           |                |     |
| SN-111                                    | T-56      | Wet Tall Oil Storage Tank, 27,500 gal               |           |                |     |
| SN-113                                    | T-57      | Wet Tall Oil Storage Tank, 36,100 gal               |           |                |     |
| SN-119                                    | T-59      | Crude Tall Oil Storage Tank, 32,130 gal             |           |                |     |

| EMISSION SUMMARY                  |           |   |   |                             |                             |
|-----------------------------------|-----------|---|---|-----------------------------|-----------------------------|
| Source Number                     | Equip ID. | Description                                   | Pollutant                                 | Emission Rates              |                             |
|                                   |           |   |   | lb/hr                       | tpy                         |
| <b>Liquid Resin Storage Tanks</b> |           |   |   |                             |                             |
| SN-21                             | WS-4      | Wet Strength Resin Storage Tank<br>30,932 gal | VOC<br>Formaldehyde<br>Methanol<br>Phenol | 0.5<br>0.03<br>0.25<br>0.06 | 0.3<br>0.02<br>0.16<br>0.04 |
| SN-22                             | WS-5      | Wet Strength Resin Storage Tank<br>30,932 gal |   |                             |                             |
| SN-23                             | DS-1      | Wet Strength Resin Storage Tank<br>30,932 gal |   |                             |                             |
| SN-30                             | P-11      | PF Resin Storage Tank<br>21,138 gal           |   |                             |                             |
| SN-31                             | RM-7      | Resi-Mix Resin Storage Tank 31,285 gal        |   |                             |                             |
| SN-66                             | P-1       | PF Resin Storage Tank 14,680 gal              |   |                             |                             |
| SN-67                             | P-2       | PF Resin Storage Tank 17,650 gal              |   |                             |                             |
| SN-68                             | P-3       | PF Resin Storage Tank 14,680 gal              |   |                             |                             |
| SN-69                             | P-5       | PF Resin Storage Tank 14,680 gal              |   |                             |                             |
| SN-71                             | P-6       | PF Resin Storage Tank 14,680 gal              |   |                             |                             |
| SN-73                             | P-9       | PF Resin Storage Tank 21,138 gal              |   |                             |                             |
| SN-74                             | P-10      | PF Resin Storage Tank 21,138 gal              |   |                             |                             |
| SN-77                             | RM-2      | Resi-Mix Resin Storage Tank 31,285 gal        |   |                             |                             |
| SN-78                             | RM-3      | Resi-Mix Resin Storage Tank 31,285 gal        |   |                             |                             |
| SN-79                             | RM-4      | Resi-Mix Resin Storage Tank 31,285 gal        |   |                             |                             |
| SN-80                             | RM-5      | Resi-Mix Resin Storage Tank 31,285 gal        |   |                             |                             |
| SN-81                             | RM-6      | Resi-Mix Resin Storage Tank 31,285 gal        |   |                             |                             |
| SN-90                             | U-9       | UF Resin Storage Tank 25,366 gal              |   |                             |                             |
| SN-91                             | U-10      | UF Resin Storage Tank 25,366 gal              |   |                             |                             |
| SN-97                             | WS-1      | Wet Strength Resin Storage Tank<br>30,000 gal |   |                             |                             |
| SN-98                             | WS-2      | Wet Strength Resin Storage Tank<br>30,000 gal |   |                             |                             |
| SN-99                             | WS-3      | Wet Strength Resin Storage Tank<br>30,000 gal |   |                             |                             |
| SN-100                            | WS-6      | Wet Strength Resin Storage Tank<br>30,932 gal |   |                             |                             |
| SN-102                            | WS-7      | Wet Strength Resin Storage Tank<br>30,932 gal |   |                             |                             |

Georgia-Pacific Chemicals LLC  
 Permit #: 1177-AOP-R15  
 AFIN: 02-00028

| EMISSION SUMMARY              |           |   |           |                |     |
|-------------------------------|-----------|---|-----------|----------------|-----|
| Source Number                 | Equip ID. | Description                                   | Pollutant | Emission Rates |     |
|                               |           |   |           | lb/hr          | tpy |
| <b>Rosin Size Plant Tanks</b> |           |   |           |                |     |
| SN-26                         | T-62      | Deaerator Material Storage Tank<br>32,130 gal | VOC       | 31.0           | 1.0 |
| SN-41                         | T-5       | Dispro Rosin Storage Tank<br>30,439 gal       |           |                |     |
| SN-52                         | T-7       | Rosin Size Plant Process Tank, 25,366 gal     |           |                |     |
| SN-118                        | T-61      | Deaerator Material Storage Tank 32,130 gal    |           |                |     |
| SN-120                        | T-11      | Rosin Size Plant Storage Tank, 25,383 gal     |           |                |     |
| SN-121                        | T-13      | Rosin Size Plant Process Tank, 25,383 gal     |           |                |     |
| SN-122                        | T-14      | Rosin Size Plant Storage Tank, 25,383 gal     |           |                |     |
| SN-123                        | T-51      | Hot Melt Holding Tank, 21,500 gal             |           |                |     |
| SN-126                        | T-75      | Hot Melt Holding Tank, 21,500 gal             |           |                |     |

<sup>1</sup>PM<sub>2.5</sub> limits are source specific, if required. Not all sources have PM<sub>2.5</sub> limits.

<sup>2</sup>Air Contaminants such as ammonia, acetone, and certain halogenated solvents are not VOCs or HAPs.

\* Included in VOC total

\*\* Batch Average Value (for both SN-05 and SN-129)

\*\*\* Although the Iodine emissions are permitted for up to 3.80 tpy for both SN-05 & SN-129 (both sources are permitted for continuous use), the total facility limit is 3.80 tpy because only one source can be operated at a time.

### SECTION III: PERMIT HISTORY

Georgia-Pacific LLC owns and operates several different types of industrial plants in Crossett, Arkansas. The construction of the Chemical Manufacturing Complex was begun in 1969 and has been expanded in several stages since that time. The facility was known as the Chemical Division of the Georgia-Pacific Corporation, Inc. until 1992 when the name was changed to Georgia-Pacific Resins, Inc. and changed to Georgia-Pacific Chemical LLC. December 31, 2006.

The facility's first air permit (**574-A**) was issued October 1979 for the construction of a Tall Oil Plant and the emission of small amounts of particulates, NO<sub>x</sub>, and hydrocarbons, as well as 57 pounds per hour of SO<sub>2</sub>.

**Air Permit 574-AR-1** was issued July 22, 1983, to cover the construction of a Spray-Dry Resin Plant. The increased emissions associated with this project were particulate matter, SO<sub>2</sub>, VOCs, phenol, and formaldehyde. This permit addressed the reasons the modification was not subject to PSD review.

**Air Permit 574-AR-2** was issued August 28, 1987, to cover the boiler upgrade at the Resin Manufacturing Plant. A 17 MM BTU/hr boiler was replaced by a 94.1 MM Btu/hr boiler. The smaller boiler was put on stand-by status, to be used when the new boiler was shut down for maintenance. The smaller boiler (SN-04) was removed from service August 22, 1995. The larger boiler is now known as the Complex Boiler (SN-05). This permit addressed the reasons the modification was not subject to PSD review.

**Air Permit 1059-A** was issued July 5, 1990, to cover the expansion of operations at the Resin Manufacturing Plant. A new process receives rosin acid from the Tall Oil Plant and esterifies it with glycerol or pentaerythritol to form rosin esters. The summary stated that this permit is only for this modification and will be superseded and voided when the next consolidated permit is issued.

**Air Permit 1177-A** was issued September 11, 1991, to install two incinerators to control VOC emissions from the RCI Plant, the ICI Plant, and the Resin Plant. The control equipment associated with the RCI Plant and the ICI Plant was regulated under New Source Performance Standards (NSPS) CFR 40 Part 60, Subpart VV - *Standards of Performance for Equipment of VOC in the Synthetic Chemicals Manufacturing Industry*. This air permit voided permits 574-AR-2 and 1059-A.

**Air Permit 1177-AR-1** was issued March 19, 1992, to allow the installation of three additional storage tanks and the modification of one existing storage tank previously used to store methanol. Two tanks were designated as tall oil fatty acid tanks, one for crude tall oil, and one as a surface size tank. All the tanks were regulated by New Source Performance Standards (NSPS) CFR 40 Part 60, Subpart Kb - *Standards of Performance for Volatile Organic Liquid Storage Vessels* specifically, 40 CFR 60.116b(a) and 40 CFR 60.116b(b).

Georgia-Pacific Chemicals LLC  
Permit #: 1177-AOP-R15  
AFIN: 02-00028

**Air Permit 1177-AR-2** was issued September 28, 1992, to allow the installation of six additional storage tanks and two baghouses. The tanks were installed in the Tall Oil Plant and the Resin Plant (SN-20 through SN-25). The baghouses were installed on the Resi-Mix Reactor (SN-18) and the Novacote Hopper (SN-19). These tanks were also subject to New Source Performance Standards (NSPS) CFR 40 Part 60, Subpart Kb - *Standards of Performance for Volatile Organic Liquid Storage Vessels*. This permit also noted the name change from Georgia-Pacific Corporation, Inc., Chemical Division to Georgia-Pacific Resins, Inc.

**Air Permit 1177-AR-3** was issued September 10, 1993, to allow for the installation of four new tanks; a dispersed size storage tank (SN-26), two dispersed size release tanks (SN-27 and SN-28), and a rosin size disperser vessel (SN-29). Only the storage tank was subject to NSPS Subpart Kb.

**Air Permit 1177-AR-4** was issued January 3, 1994, to allow the replacement of a catalytic incinerator with a thermal incinerator (SN-11). The permit also said that the facility was subject to New Source Performance Standards (NSPS) CFR 40 Part 60, Subpart VV - *Standards of Performance for Equipment Leaks of VOC in the Synthetic Organic Chemicals Manufacturing Industry*.

**Air Permit 1177-AR-5** was issued April 12, 1996, with 29 new source numbers (SN-30 through SN-58). The permit modification was issued to cover the installation of a new VOC control system which includes a caustic scrubber, followed by a chilled water condenser, and finally the existing complex boiler (SN-05). This system serves the Tall Oil Fractionation Plant, the Rosin Size Plant, and the Rosin Derivatives Plant. The Tall Oil Fractionation Plant increased production capacity from 73,000 tons to 140,000 tons of crude tall oil per year, installed five new product storage tanks, a rosin drumming tank, a rosin drumming station, and replaced the Dow-Therm heater. The Rosin Size Plant replaced the condenser with a VOC control system. The Rosin Derivatives Plant replaced the two stage condenser with a new VOC control system. The Crude Tall Oil Plant replaced the wet scrubber with a high-efficiency packed column scrubber. The permit stated that the facility was subject to NESHAP 40 CFR Part 63, Subpart G and Subpart H. The permit also stated that the facility was not subject to NSPS 40 CFR 60, Subpart VV or Subpart RRR due to the fact that the formaldehyde plants have not been modified since they were originally constructed.

**Air Permit 1177-AOP-R0** was issued August 13, 2001, and it is the initial Title V permit for the facility. This permit incorporated the following changes to the facility:

1. The Complex Boiler SN-05 is allowed to burn the Resin Kettle Overheads (RKO) in addition to its other fuels. Georgia-Pacific Resins requested a modification to produce a rosin product which could cause iodine to be emitted from the Complex Boiler, SN-05. A three-stage alkaline scrubber was installed to remove the iodine from the vent gas stream prior to being sent to the complex boiler for destruction;

2. Another change allowed the production of a pastille rosin which would cause maleic anhydride to be emitted from SN-09, the Derivatives Plant Flaker Bagging Station. Two storage tanks SN-41 and SN-42 were added to store Dispro rosin and distilled tall oil respectively. These tanks used the source numbers for two tanks which were removed. A 13,000 gallon Novacote Size Storage Tank, SN-124; and a 10,000 Formic Acid Storage Tank, SN-125 were also added. The modification which included the Formic Acid Storage Tank also included a 10,000 gal sulfuric acid storage tank which is added to the insignificant activities list. An 80 MMBTU/hr Package Boiler, SN-130, was also added in a modification. These changes were all processed as modifications to the facility's previous SIP permit and were all incorporated into this Title V permit; and
3. These changes included the addition of a sixth batch liquid resin manufacturing kettle (K-7) to be controlled by SN-11, the RCI oxidizer, the addition of six Urea-Formaldehyde Resin product storage tanks SN-85, 88, 91, 92, 93, and 94, and the addition of two wet strength resin storage tanks, SN-101 and 102. Other changes from Georgia Pacific's previous permit include adding a pre-polymer storage tank (M-17) and increasing the production of liquid resin to 337 MM pounds per year and increasing the Derivatives Plant production to 7.5 MM pounds per year. There are also 55 sources which were previously considered insignificant which were added to this permit.

**Air Permit 1177-AOP-R1** was issued on February 21, 2003. The facility requested to increase the hourly VOC emission rate to 3.0 lb/hr batch average and reduce the hours of operation to 4,400 hr/year for the CTO cooker (SN-12). The facility did not increase the annual VOC emissions at SN-12. GPRI also requested to construct an 835,000 gallon tank (SN-40) to store crude tall oil (CTO). The emissions from SN-40 were 0.1 lb/hr and 0.4 tpy of VOC. The semiannual reporting requirements were removed from Specific Conditions 5, 36, and 105.

**Air Permit 1177-AOP-R2** was issued on September 12, 2003. GPRI submitted applications requesting the following:

1. Included the production of Phenolic Rosin Resin (PRR);
2. To allow a change in service for the storage tank SN-17 and weight tank W-3 (SN-95); and
3. Allow GPRI to use Method 320 in lieu of Method 18; and
4. Install a new loading rack (SN-133), a new 30,000 gal urea solution storage tank, two new 30,000 gal wet strength resin (WSR) tanks (SN-101 and SN-102), and a 7,343 gal wet strength resin and urea dilute tank.

The change resulted in an increase of VOC by 1.2 tpy and HAPs by 0.044 tpy.

**Air Permit 1177-AOP-R3** was issued on December 5, 2003, to allow products from the CTO to be produced in shorter batch times. As a result of shorter batch times, the hourly VOC limit for the CTO Acidulation Scrubber (SN-12) was increased to 5.0 lb/hr. The hours of operation for SN-12 were reduced to 2,640 hours/yr in order to maintain the current annual limit of 6.6 tpy. GPRI also requested to add a 20,000 Phenol Distillate Storage Tank (PD-1). PD-1 is considered an insignificant activity since VOC emissions from PD-1 are less than 2.81 lb/yr.

**Air Permit 1177-AOP-R4** was issued on June 21, 2004, to allow SCRUB-2B to operate with additional modes of operation for processing gas fed to the VOC control system. The initial purpose of SCRUB-2B was to condense steam and remove iodides generated during Lytor production. It now also reduces the concentration of formaldehyde, from DUF 70 production. SCRUB-2B was modified such that only stage 1 operates during the production of DUF 70. However, during Lytor operation or operation resulting in a halogenated waste gas, SCRUB-2B will continue to operate all three stages in accordance with Specific Condition #6. The water from SCRUB-2B will be sent to an oil/water separator and the facility's waste water collection area (SN-134). GPRI also changed service for an existing 15,000 gallon tank, SN-70, to be used to store Nonylphenol.

**Air Permit 1177-AOP-R5** was issued on October 27, 2004, to allow an increase in production of a resin, LYTOR® 105K to 100 batches per year. The gas from the production of LYTOR® 105K is sent to the Complex Boiler (SN-05) to be combusted. GPRI also requested the hourly permitted iodine limit for SN-05 to be a batch average and to include Total Iodine compounds. As a result of the increased production of the resin, total iodine emissions from SN-05 increased by 0.47 lb/hr (batch average) and 2.0 tpy.

**Air Permit 1177-AOP-R6** was issued on May 5, 2005, to allow a change in service for two storage tanks (SN-17 and SN-60). DETA resin was stored in SN-17 was replaced by another resin, Novacote. The two resins, on a VOC emission rate basis, are equivalent. Cresylic Acid stored in SN-60 was replaced by Secondary Butylphenols. The two organic compounds, on a VOC as well as HAP emission rate basis, are equivalent. VOC emissions from each tank are 0.1 lb/hr and 0.4 tpy. GPRI also requested to re-melt and fuel blend old rosin material from a current stockpile and sample rosin generated on a daily basis. The fuel blend is combusted in the Complex Boiler (SN-05). Combustion of the fuel blend is considered to be an insignificant activity. Lastly, the requirement that a six hour period must elapse between start up of LYTOR® 105K batches was removed because batch times are at least 12 hours and there is only one reaction vessel used for production of the resin. As a result of the requested change permitted Phenol emissions increased by 0.10 lb/hr and 0.40 tpy.

**Air Permit 1177-AOP-R7** was issued on April 3, 2006 to increase annual production of LYTOR® 105K (SN-05 & SN-129) from 100 batches per year to 150 batches per year as referenced in Plantwide Condition #13. With this increase in production of LYTOR® 105K, batch average emissions did not change, however the Iodine annual emissions increased by 1.25 tons/year

**Air Permit 1177-AOP-R8** was issued February 5, 2008. This modification was submitted to renew the facility existing permit. Subsequently, additional applications were submitted requesting the following modifications to the existing permit:

- The addition of a stand-by railcar containing approximately 180,000 lbs of diethylenetriamine (DETA) to the insignificant activity list.
- The temporary storage of Phenol in Storage Tank M-5 (SN-60) and Storage Tank M-6 (Insignificant Activity).
- The temporary storage of Cresylic Acid / Secondary Butylphenol in Storage Tank SN-61.
- The temporary removal from service of the Phenol Storage Tank (SN-62) for repairs. However, the tank remained in the permit as a permitted source.

Georgia-Pacific Chemicals LLC  
Permit #: 1177-AOP-R15  
AFIN: 02-00028

- The addition of a new emulsifier soap formulation on the facility's spray dry system (SN-03).
- The installation of a new Hot Melt Holding Tank (SN-126).
- The removal of the Package Boiler (SN-130).
- The removal of storage tank T-34 (SN-106).
- The addition of A-13 Insignificant Activities to TOFRAC plant: new column (DT-1); XTOL Light Distilled Heads Storage Tank T-73 and Test Tank T-74. These two tanks replaced SN-106.
- The facility name changed from Georgia-Pacific Resins, Inc. to Georgia Pacific Chemicals LLC, effective December 31, 2006.
- The addition of 40 CFR 61, Subpart FF (the BENWASTE rule) as an applicable regulation. The only requirement for the facility is to submit an initial report quantifying the TAB amount and must recalculate TAB only if it changes its process in a way that could cause the TAB amount to exceed 1 Mg/year. The initial report was due in April 1993, however after reviewing internal files, the facility did not find a copy of any report submitted to the Department in 1993. A report was submitted in November 2006 to update the Department's files.

Other changes in permitted emissions were due to updated AP-42 factors. The existing SO<sub>2</sub> permitted emission rates for SN-05 were incorrectly calculated in the original Title V application. Therefore SN-05 emission rates were changed to the correct emission rates. There were no physical changes and/or change in operation associated with the permitted emission changes at SN-05. With the changes identified above permitted PM/PM<sub>10</sub>, VOC, CO, NO<sub>x</sub>, Maleic Anhydride, and Phenol decreased by 61.3 tons/year (tpy), 4.3 tpy, 25.7 tpy, 31.6 tpy, 2.1 tpy, and 2.6 tpy, respectively. Permitted SO<sub>2</sub>, Total Iodine, Formaldehyde, Methanol, Arsenic Compounds, Lead Compounds, Cadmium, Manganese Chromium, and Ammonia increased by 45.9 tpy, 01.25 tpy, 0.70 tpy, 10.6 tpy, 0.40 tpy, 0.40 tpy, 0.40 tpy, 1.05 tpy, 0.40 tpy, and 2.00 tpy, respectively.

**Air Permit # 1177-AOP-R9** was issued on February 10, 2009. The modification included the following changes:

- The replacement of the Tall Oil Fatty Storage Tank (SN-14) with a larger vessel.
- The replacement of Hot Melt Holding Tank (SN-123) with a larger vessel.
- A footnote addition to the emission rate table for SN-14, SN-15, SN-46, SN-48, SN-49, SN-57, and SN-58 to clarify that the VOC hourly emission rate (0.1 lb/hr) represented the average hourly emission and 0.14 lb/hr represented the short term hourly maximum emission limit. However, the facility accepted a VOC emission limit for each source of 0.2 lb/hr to ensure compliance can be maintained at all times.
- The addition of a new group of spray dried resins which contain ammonia at the spray dry process (SN-03).
- The reclassification of Aqua Ammonia Tank (SN-135) as a permitted source rather than an insignificant activity.
- Administrative amendments to the facility's insignificant activity list. The update was necessary to reflect several tanks that were taken out of service and activities that no longer occur. In addition, some of the group classifications were corrected.



Georgia-Pacific Chemicals LLC  
Permit #: 1177-AOP-R15  
AFIN: 02-00028

- The revision of the language in Specific Condition #62 of Air Permit #1175-AOP-R8 to reflect calculation methodology that was consistent with the permit application and AP-42 Chapter 7.1.

With these modifications permitted Ammonia emissions increased by 14.04 tpy.

**Air Permit # 1177-AOP-R10** was issued on April 9, 2010. The modification included the following changes:

On May 12, 2008, the Department received an application for a modification that requested the following changes:

- Incorporated the provisions of 40 CFR 63, Subpart FFFF, *National Emission Standards for Hazardous Air Pollutants for Miscellaneous Organic Chemical Manufacturing (MON)*.
- The reclassification of the Crude Tall Oil, Novacote, Formaldehyde/Urea Formaldehyde Concentrate (UFC), Resin and Tall Oil Products Loading Stations (SN-136, SN-137, SN-138, and SN-139) from insignificant activities to permitted sources.
  - Incorporated minor permit revisions and typographical errors.

On August 18, 2008, the facility submitted an application for an administrative amendment to the facility's insignificant activity list. The update was necessary to include two Urea Formaldehyde Resins Storage Tanks (SN-86 and SN-87).

On October 15, 2008, the Department received an application for an administrative amendment to correct the description for the storage tank identified as RM-1 (SN-76) to reflect current usage for dilute caustic storage in accordance with Group A-4.

On November 13, 2008, the Department received an application for a minor modification application requesting the following modifications:

- The installation of an overhead condenser and vacuum pump system to the facility's rosin size cooker/reactor (C-1).
- The increase of the production limit for rosin derivatives by 20,000,000 pounds/year while reducing the rosin size production rate by 20,000,000 pounds/year.

On December 15, 2008, the Department received an application for a minor modification application requesting to add three urea formaldehyde Resin storage tanks (SN-85, SN-88 and SN-89) and a back-up emergency generator (SN-140).

On June 9, 2009, the Department received an application for an administrative amendment to the insignificant activity list. The revision was necessary to allow for the addition of a portable diesel fired air compressor.

On June 26, 2009, the Department received an application for an administrative amendment to the facility's insignificant activity list. The modification was necessary to allow two 7,200 gallon epichlorohydrin tank truck trailers to remain onsite. Also, the facility submitted a minor modification application requesting the following modification:

Georgia-Pacific Chemicals LLC  
 Permit #: 1177-AOP-R15  
 AFIN: 02-00028

- Removal of Reactors R-1 and R-2 (SN-29), Casein Mix Tanks; CT-61 and CT-62 (Insignificant Activities).
- Discontinued the use of Release Tanks RT-2 (SN-28) and RT-3 (SN-116), Storage Tanks T-60 (SN-117) and T-63 (SN-25) and the Brine Storage Tank T-86 (Insignificant Activity).
- Reclassified tanks T-61 (SN-118) and T-62 (SN-26) as deaerator product storage.
- Reclassified tank T-59 (SN-119) as storage for Crude Tall Oil (CTO).

With these modifications permitted VOC emissions decreased by 1.1 tons per year (tpy). Permitted PM/PM<sub>10</sub>, SO<sub>2</sub>, CO, & NO<sub>x</sub> emissions increased by 1.3 tpy, 1.2 tpy, 3.8 tpy, and 17.6 tpy, respectively. Methanol and formaldehyde permitted emission increased by 0.4 tpy each, and ammonia emissions increased by 1.6 tpy.

**Air Permit # 1177-AOP-R11** was issued on May 27, 2011. This modification was to revise the emission limitations associated with managing wastewater generated at this facility and the Spray Dryer Process (SN-03). This modification did not involve the addition of any new equipment or physical changes to the wastewater collection and transfer system or the Spray Dryer Process.

Based on sampling data and updated emission calculations, GP believed that the emission limits associated with the entire waste water collection and transfer system were insufficient (#1177-AOP-R10). Using updated analytical information, and an established EPA method for estimating fugitive emission from liquid-pool evaporation, GP updated the emission estimates for the facility's wastewater collection and transfer system (SN-134).

The facility completed voluntary engineering tests to compare Method 320 (FTIR) and Method 25A(FID), the current compliance test methodology, on the Spray Dry Baghouse (SN-03). Based on the comparative study, the facility proposed to use the FTIR to establish a new emission limit for the spray dryer. The modified permitted emission limit for SN-03 increased based on tests using Method 320.

This modification also incorporated a change to Resin Plant Back-up Weigh Tank, SN-95, allowing throughput of non-HAP/VOC materials while also allowing finished products to be staged or temporarily stored.

Total facility permitted emissions changed as follows:

| <b>Pollutant</b> | <b>tpy</b> |
|------------------|------------|
| VOC              | +92.6      |
| Formaldehyde     | +6.05      |
| Methanol         | +73.80     |
| Ammonia          | +0.50      |
| Acetaldehyde     | +10.25     |
| Benzene          | +0.10      |
| Dimethyl Ether   | +2.45      |
| Toluene          | +0.20      |

Georgia-Pacific Chemicals LLC  
Permit #: 1177-AOP-R15  
AFIN: 02-00028

**Air Permit # 1177-AOP-R12** was issued on July 15, 2011. This modification was to add a one thousand gallon ethylene glycol tank to the A-13 insignificant activities list. Permitted emission limits remained unchanged.

**Air Permit # 1177-AOP-R13** was issued on March 14, 2016.

October 2011 a minor modification was submitted to replace the existing RCI UFC/Formaldehyde Manufacturing Process Regenerative Thermal Oxidizer (SN-11) with a new regenerative thermal oxidizer (RTO). This modification will not result in an increase in emission because the new RTO will have a lower heat input burner and a higher percent volatile organic compound control efficiency than the existing RTO.

November 11, 2011 a minor modification was submitted to temporarily install a natural gas/fuel oil fired 80 MMBtu Package Boiler (SN-141) to provide back-up steam until the facility is tied in to the Paper Mill for the extra steam supply. The fuel oil capabilities of the boiler will not be connected; therefore only natural gas will be permitted to be burned. During the comment period of this permit the facility informed the Department that the Package Boiler (SN-141) has been removed from the facility.

December 19, 2011 a modification was submitted to add (hazardous Air Pollutants) HAPs to various sources that were determined not to be de minimis and to correct permitted emissions rates based on more recent test data and/or more accurate calculation methodology, where necessary. VOC permitted emission rates are also being updated for certain sources, as applicable based on the HAP related revisions.

August 6, 2012 a renewal application was submitted to renew the facility's existing permit. No physical modifications were proposed in this renewal application; however, GP proposed to make several modifications to the permit as described below. Emission rates have been re-evaluated to reflect updated emission factors, additional stack test data, and more accurate calculation methodologies, as applicable.

The following is a summary of the requested changes with this renewal application.

1. Remove the following sources that are no longer in service:
  - a. Crude Tall Oil Acidulation Plant Scrubber (SN-12)
  - b. Phenol Storage Tank (SN-60)
  - c. Three UF Resin Storage Tanks (SN-85, SN-88, and SN-89)
  - d. Wet Strength Resin Storage Tank (SN-101)
2. Rename source SN-137 from "Formaldehyde/UFC Loading Station" to "UFC Railcar Loading Station".
3. Incorporate previously requested modifications from Minor Modification Applications submitted October 17, 2011 and November 11, 2011 and a Major Modification Application submitted December 16, 2011.
4. Include the following sources that were not previously evaluated and included in the Title V permit:
  - a. Haul Roads (SN-145)
  - b. Fugitive Equipment Leaks (SN-146)
  - c. Liquid Resin Manufacturing Cooling Tower (SN-142)
  - d. Formaldehyde Production Cooling Tower (SN-143)

- e. Derivative Plant Cooling Tower (SN-144)
5. Removed Specific Condition 6b which specifies limits when the plant is producing any formaldehyde containing rosin. GP Crossett no longer produces formaldehyde containing rosin
  6. Add additional start-up, shutdown, and malfunction (SSM) wording to Specific Condition Nos. 14, 27, 39, 53, and 112.
  7. Bubble emission limits for the Liquid Resin Storage Tanks (i.e., SN-21, SN-22, SN-23, SN-30, SN-31, SN-66, SN-67, SN-68, SN-69, SN-71, SN-73, SN-74, SN-77, SN-78, SN-79, SN-80, SN-81, SN-90, SN-91, SN-97, SN-98, SN-99, SN-100, and SN-102).
  8. Bubble the emission limits for the Tall Oil Fractionation Plant Storage Tanks (i.e., SN-14, SN-15, SN-16, SN-20, SN-24, SN-32, SN-33, SN-34, SN-35, SN-36, SN-37, SN-40, SN-42, SN-43, SN-44, SN-45, SN-46, SN-47, SN-48, SN-49, SN-50, SN-51, SN-52, and SN-53, SN-54, SN-55, SN-56, SN-57, SN-58, SN-107, SN-108, SN-109, SN-110, SN-111, SN-113, and SN-119).
  9. Bubble the emission limits for the Rosin Size Plant storage tanks (SN-26, SN-41, SN-118, SN-120, SN-121, SN-122, SN-123, SN-126).
  10. Hazardous air pollutants were evaluated pursuant to the ADEQ's permittee guidance (dated July 2012) and emissions limits were proposed for all sources as appropriate.
  11. Add GHG emission limits for sources SN-01, SN-03, SN-05, SN-07, SN-10, SN-11, SN-129, SN-140 and SN-141.

October 17, 2013 a minor modification was submitted to group certain resin tanks used in the Liquid Resin Manufacturing Plant and bubble the emission limits to allow the plant flexibility.

August 8, 2014 a minor modification application was submitted to

- Group all tanks used in the Tall Oil Fractionation Plant Tanks and replace the Tall Oil Rosin Storage Tank, Tank 7 (SN-52) with Tank 63 (formerly permitted as Neutral Rosin Adduct Storage Tank, SN-25) which will be modified to the same height and capacity of Tank 7. Tank 63 will be part of the Rosin Size Plant Sources. The facility requests to designate the modified Tank 63 as SN-52.
- Group all tanks used in the Rosin Size Plant to allow the plant more flexibility to store a variety of products. Revise the process description for Tank 11 (SN-120), Tank 13 (SN-121), and Tank 14 (SN-122). The facility no longer store Novaflo<sup>®</sup> 50 in Tanks 11 and 13 and 70% DUF in Tank 14. This modification will allow the facility to store an amidoamine intermediate in Tank 11 (SN-120), XTOL<sup>®</sup> 692 from the C-1 Cooker in Tank 14 (SN-122). Tank 13 (SN-121) will be used as a blending tank to blend XTOL<sup>®</sup> 692 and amidoamine to make an emulsifier, GP<sup>®</sup> 768G42.
- Install a new 12,500 gal storage tank that will store molten maleic anhydride (MMA). This is a Group 2 tank under the MON Rule, because the vapor pressure is less than 1.0 psi, GP Chemicals will voluntarily control working losses from the tank when it is being filled using a small packaged wet scrubber (SN-147).
- Include MMA fugitive emissions into the fugitive emission limit in SN-146

Georgia-Pacific Chemicals LLC  
Permit #: 1177-AOP-R15  
AFIN: 02-00028

September 22, 2014 the facility submitted an addendum to the Title V Renewal application to correct the heat input for the spray dryer burner (SN-03) and revised the associated emission limits. The burner was originally permitted in 1983 at 10.0 MMBtu/hr but it is actually 15.4 MMBtu/hr. The original burner has not been modified, reconstructed, or replaced. GP has data from previous compliance and engineering tests while the spray dryer process unit was operating at or above 90% production capacity showing that emissions from the spray dryer were below permitted levels even with the larger burner. The facility also submitted revised calculations for the fugitive emissions from plant wide LDAR equipment within the affected sources regulated by HON, West Strength MACT, Resin MACT and MON LDAR programs identified as SN-146.

January 23, 2015 the facility submitted a minor modification to install a non-bulk packaging system (SN-148) that bags the finished product from the spray dry unit. The system will be equipped with a new dust collector to minimize particulate emissions.

During the comment period of the draft permit, several comments were received from the public in regards to HAPs emitted from the facility. On November 13, 2015, GP Chemicals conducted an air quality analysis, based on a request from ADEQ, to determine if emissions of formaldehyde would potentially exceed the presumptively acceptable impact level (PAIL). Per ADEQ guidance, this is accomplished by conducting an air dispersion modeling analysis. Other HAPs emitted from the facility were screened by ADEQ and it was determined no further action is required at this time.

Several sources modeled for formaldehyde differ from the current permitted emission rates and the most recent Title V submittals. Thus, On January 29, 2016 the facility submitted a request to modify emissions. In order to decrease emissions from the facility, GP Chemicals proposed to install enforceable emission controls on the Urea Formaldehyde Concentrate (UFC) railcar loading station (SN-137). The existing control device to be used will be SN-11, RCI UFC/Formaldehyde Manufacturing Process Oxidizer. In addition, GP Chemicals proposed to lower emission limits for the spray dryer (SN-03), liquid resin manufacturing tank source group, wastewater treatment (SN-134), and equipment leaks (SN-146).

The emission reduction for the railcar loading station will be achieved by controlling emissions with the RCI control device, SN-11. Emissions for the spray dryer (SN-03) were calculated based on the most recent stack data of 2.2 lb/hr formaldehyde. Equipment Leaks (SN-146) were not listed as a source in the previous air permit (#1177-AOP-R12), but emission estimates for this application are being updated. Emission changes for the wastewater treatment (SN-134) are based on a change in methodology due to removal of the wastewater pond.

In addition to revising the formaldehyde emission limits GP Chemicals is also updating the estimates for other HAP emissions from the railcar unloading, liquid resin tanks, wastewater treatment, and equipment leak sources as these calculations were updates as part of the formaldehyde refinements.

Georgia-Pacific Chemicals LLC

Permit #: 1177-AOP-R15

AFIN: 02-00028

Total permitted emissions will increase by 13.8 tons/year (tpy) PM<sub>10</sub>, 14.1 tpy PM, and 36.5 tpy CO. Total permitted emissions will decrease by 9.5 tpy SO<sub>2</sub>, 5.8 tpy NO<sub>x</sub>, 43.9 tpy VOC, 44.1798 tpy total HAPs and 7.30 tpy of Air Contaminants (Ammonia, Hydrogen Sulfide, Sulfuric Acid, Formic Acid, and TRS).

**Air Permit # 1177-AOP-R14** was issued on July 8, 2016. The facility submitted an application for administrative amendment to remove SN-137(Formaldehyde/UFC Loading Stations) from the operating permit. Total permitted emissions will decrease by 0.2 tpy VOC.

**SECTION IV: SPECIFIC CONDITIONS**

**Facility-wide Sources**  
 SN-05 Complex Boiler

Source Description

The Complex Boiler (B-1), permitted to burn natural gas only, produces utility steam for the facility and serves as a Miscellaneous Organic National Emission Standard for Hazardous Air Pollutants (MON) control device which controls HAP and VOC emissions from the Rosin Size and Derivative kettles as well as TOFRAC. The Complex Boiler is also the primary control device for the three sources above under the MON (40 CFR 63, Subpart FFFF).

When there is a “combined emission stream,” MON requires that the stream must comply based on the hierarchy listed in 63.2450(c)(2). As such, the stream must comply with the Group 1 Batch Process Vent requirements in Table 3 of Subpart FFFF -- which requires 98% DRE collectedly on all Batch Process Vents or 20 ppm @ 3% O<sub>2</sub> on the outlet of the control device.

Georgia Pacific Chemicals LLC manufactures a rosin, LYTOR® 105K, which uses an iodide catalyst in the rosin cooker (C-1). During certain phases of the rosin cook, iodine could escape from the cooker in the form of elemental iodine and light organic iodine containing compounds. A three-stage alkaline scrubber (SCRUB-2B) was installed in January 2001 to scrub iodine from the vent gas stream prior to being sent to the Complex Boiler for destruction.

Specific Conditions

1. The permittee shall not exceed the emission rates set forth in the following table. The permittee shall demonstrate compliance with this condition by complying with Specific Condition #5, #6, and #9 [Reg.19.501 *et seq.* and 40 C.F.R. § 52 Subpart E]

| SN | Description  | Pollutant                 | lb/hr | tpy   |
|----|--|---------------------------|-------|-------|
| 05 | Complex Boiler/ MON Control System (94.1 MMBTU/hr) | PM <sub>10</sub> (normal) | 35.0  | 180.6 |
|    |  | (Sootblowing)             | 85.0  |       |
|    |  | SO <sub>2</sub>           | 21.1  | 92.3  |
|    |  | VOC                       | 4.6   | 20.1  |
|    |  | CO                        | 8.0   | 34.7  |
|    |  | NO <sub>x</sub>           | 13.3  | 58.0  |

2. The permittee shall not exceed the emission rates set forth in the following table. The permittee shall demonstrate compliance with this condition by with Specific Condition #5, #6, and #9. [Reg.18.801 and Ark. Code Ann. § 8-4-203 as referenced by Ark. Code Ann. §§ 8-4-304 and 8-4-311]

| SN | Description  | Pollutant                 | lb/hr          | tpy    |
|----|--|---------------------------|----------------|--------|
| 05 | Complex Boiler/ MON Control System (94.1 MMBTU/hr) | PM (normal) (Sootblowing) | 35.00<br>85.00 | 180.60 |
|    |  | Total Iodine              | 4.20*          | 3.80   |
|    |  | Lead Compounds            | 0.10           | 0.40   |
|    |  | Acetaldehyde              | 0.02           | 0.07   |
|    |  | Acrolein                  | 0.01           | 0.02   |
|    |  | Formaldehyde              | 0.04           | 0.15   |
|    |  | Hexane                    | 0.22           | 0.96   |
|    |  | Methanol                  | 0.03           | 0.12   |
|    |  | Phenol                    | 0.05           | 0.22   |
|    |  | POM (Total)               | 0.01           | 0.01   |
|    |  | Cadmium                   | 0.01           | 0.01   |

\*Batch Average

3. Visible emissions may not exceed the limits specified in the following table of this permit as measured by EPA Reference Method 9. Compliance with this limit shall be demonstrated by Specific Condition #4

| SN | Limit | Regulatory Citation                         |
|----|-------|---|
| 05 | 20%   | Reg.19.503 and 40 C.F.R. Part 52, Subpart E |

4. Weekly observations of the opacity from SN-05 shall be conducted by a person trained but not necessarily certified in EPA Reference Method 9/a certified EPA Reference Method 9 reader. If visible emissions in excess of the permitted levels are detected, the permittee shall immediately take action to identify the cause of the visible emissions in excess of the permit limit, implement corrective action, and document that visible emissions did not appear to be in excess of the permitted opacity following the corrective action/perform an EPA Reference Method 9 test to verify emissions are not in excess of the permitted level. The permittee shall maintain records which contain the following items in order to demonstrate compliance with this specific condition. These records shall be updated weekly, kept on site, and made available to Department personnel upon request.
- The date and time of the observation.
  - If visible emissions which appeared to be above the permitted limit were detected.



- c. If visible emissions which appeared to be above the permitted limit were detected, the cause of the exceedance of the opacity limit, the corrective action taken, and if the visible emissions appeared to be below the permitted limit after the corrective action was taken.
- d. The name of the person conducting the opacity observations.

[Reg.18.1004 and Ark. Code Ann. § 8-4-203 as referenced by Ark. Code Ann. §§ 8-4-304 and 8-4-311]

- 5. During production of LYTOR® 105K or while gas which contains halogens is fed to the VOC control system, the permittee shall maintain a scrubbing liquid with a pH of at least 9.0 and a minimum flow rate 10 gallons per minute in the third stage of SCRUB-2B. The permittee shall maintain records of the scrubbing liquid flow rate and pH prior to each batch of LYTOR® 105K. These records shall be kept on site and made available to Department personnel upon request. [Reg.18.1004 and Ark. Code Ann. § 8-4-203 as referenced by Ark. Code Ann. §§ 8-4-304 and 8-4-311]
- 6. The permittee shall test the Complex Boiler, SN-05, during normal operating conditions for emissions of PM, CO, NO<sub>x</sub>, SO<sub>2</sub>, and VOC to test compliance with the limits set forth in the table in Specific Conditions #1 and #2 above. These tests shall be conducted using an EPA approved test method for each pollutant tested. The compliance testing conducted on November 17, 2011 satisfies the requirement of this permit condition. [Reg.19.503 and 40 C.F.R. Part 52, Subpart E]
- 7. The Thermal Oxidizer, SN-129, or the Complex Boiler, SN-05, shall be operated at all times that the Tall Oil Fractionation Plant, the Rosin Size Plant, or the Rosin Derivatives Plant is in production. [Reg.19.705, Ark. Code Ann. § 8-4-203 as referenced by Ark. Code Ann. §§ 8-4-304 and 8-4-311, and 40 C.F.R. §70.6]
- 8. The permittee shall comply with one (1) of the following emission limitations for the Rosin Size Cooker and TOFRAC Hot Wells #1 and #2 except during periods of start-up, shut-down, and malfunctions.
  - a. Reduce emissions of total organic HAP, measured as TOC (as carbon), by 98%;  
or
  - b. Limit emissions of organic HAP, measured as TOC (as carbon), to 20 ppmvd.

Compliance with condition will be demonstrated by Specific Condition #12. [Reg.19.703, 40 C.F.R. §63.2460(a)]

- 9. Whenever the TOFRAC Plant, the Rosin Size Plant (C-1), or the Rosin Derivatives Plant (R-1) is in production, the permittee shall maintain a “daily average” firebox temperature in the Complex Boiler at or above established operating range submitted in the most recent MON Notification of Compliance Status (NCS) Report. Based on the latest NCS submittal, the Complex Boiler must operate with a firebox temperature at or above 1,150°F on a “daily average” basis. Compliance with this condition will be demonstrated by Specific Condition #10 and #11. [Reg.19.304, 40 C.F.R. 63 Subpart FFFF, and 40 C.F.R. Part 63 Subpart SS]

10. The permittee shall install, calibrate, maintain, and operate according to manufacturer's specifications a temperature monitoring device equipped with a continuous recorder. The temperature monitoring device shall be installed in the firebox of the boiler.  
[Reg.19.304, 40 C.F.R. 63 Subpart FFFF, and 40 C.F.R. Part 63 Subpart SS]
11. The permittee shall maintain continuous records of the temperature in the Complex Boiler Firebox as monitored by the temperature monitoring device. The permittee shall also maintain daily averages of the firebox temperature. These records shall be kept onsite, updated daily, and made available to Department personnel upon request.  
[Reg.19.304, 40 C.F.R. 63 Subpart FFFF, and 40 C.F.R. Part 63 Subpart SS]
12. The permittee shall conduct an initial TOC compliance test to establish compliance with either the 98% destruction efficiency requirement or the 20 ppmvd outlet limitation for the Complex Boiler. This test shall be conducted under hypothetical worst case conditions based on the capture and control system limitations. The permittee shall submit a Notification of Performance Test at least 60 calendar days prior to the initial or any subsequent performance test and the results of the initial performance test shall be submitted with the Notification of Compliance Status no later than October 7, 2008. The facility submitted the Initial Notification of Compliance Status (NCS) on October 7, 2008. As shown in the NCS dated October 16, 2009, the most recent MON compliance test was conducted on August 18, 2009 on the Complex Boiler (SN-05), which established a new MON compliance temperature of 1,150°F or greater.[Reg.19.304, 40 C.F.R. 63 Subpart FFFF, and 40 C.F.R. Part 63 Subpart SS]
13. The permittee shall submit periodic reports no later than March 30<sup>th</sup> and September 30<sup>th</sup> of each year covering the six month period ending thirty days prior to each due date as approved by EPA on August 14, 2012. The permittee shall report start-up, shutdown, and malfunction (SSM) events handled consistent with the SSM Plan on the Semi-Annual Compliance Report. SSM Events that are not handled consistent with the SSM Plan shall be reported in accordance with General Provision #8(a). [Reg.19.304, 40 C.F.R. 63 Subpart FFFF]
14. The permittee shall develop, implement and maintain a startup-shutdown, and malfunction plan by May 10, 2008. [Reg.19.304, 40 C.F.R. 63 Subpart FFFF]
15. The permittee shall submit a Notification of Compliance Status as outlined in §63.2550 (d) by October 7, 2008. The facility submitted the Notification of Compliance Status on October 7, 2008. [Reg.19.304, 40 C.F.R. 63 Subpart FFFF]
16. The permittee shall submit other reports as required by §63.2520 including Notification of process change in accordance with 40 CFR 63.2520(e)(10). [Reg.19.304, 40 C.F.R. 63 Subpart FFFF]
17. The permittee shall maintain records as required by §63.2525. [Reg.19.304, 40 C.F.R. 63 Subpart FFFF]

SN-11 RCI UFC/Formaldehyde Manufacturing Process Regenerative Thermal Oxidizer

Source Description

The RCI Formaldehyde Manufacturing Process Regenerative Thermal Oxidizer (SN-11) controls emissions from equipment which are regulated under several NESHAP standards, which are summarized as follows:

NESHAP Subpart G (HON): Group 1 Methanol Tank (M-2) with 95% destruction efficiency requirement, Group 2 Vapor Recovery Tank, Group 2 Formaldehyde Storage Tanks (F1-5), and Group 2 Formaldehyde/UFC Load Rack.

NESHAP Subpart OOO (Resin MACT): RCI UFC/Formaldehyde Process (Absorber), Group 2 UFC Storage Tanks (C1-6), Amino Phenolic Resin Reactors (K1-3) with 83% destruction efficiency requirement and the Group 2 UFC Load Rack (which is only regulated under HON because it also loads formaldehyde). The RCI UFC/Formaldehyde Process (Absorber) is an existing continuous process vent subject to Subpart OOO with no current applicable control requirements.

When either the Resin MACT RCI UFC/Formaldehyde Manufacturing Process or Resin MACT Reactors (K1, K2 or K3) is in operation, the RCI Regenerative Thermal Oxidizer (RTO) controls emissions from all of the equipment referenced above at 910°C which meets the 95% destruction efficiency requirement for the Group 1 Methanol Tank. If both Resin MACT processes are shut down (RCI Plant and Resin Reactors (K1-3)), the Group 1 Methanol Tank is interlocked such that methanol cannot be pumped to the tank, thus eliminating working losses. If the RTO is shut down due to a NESHAP covered process being shut down, breathing losses from the five formaldehyde tanks are routed through the RTO stack.

NESHAP Subpart W (Wet Strength MACT) is applicable to the Reactors K-4 and K-7. Emissions from K-4 and K-7 are also controlled by the RCI RTO.

There is also a Novacote/Urea Solution Reactor (K-5) that is controlled by the RCI RTO, but the reactor is not subject to HON, Resin MACT, or Wet Strength MACT based on the current production associated with this unit.

Specific Conditions

18. The permittee shall not exceed the emission rates set forth in the following table. The permittee shall demonstrate compliance with this condition by complying with Specific Condition #25 and Plant Wide Condition #13 . [Reg.19.501 *et seq.* and 40 C.F.R. § 52 Subpart E]

| SN | Description                                      | Pollutant        | lb/hr | tpy |
|----|--|------------------|-------|-----|
| 11 | RCI<br>UFC/Formaldehyde<br>Manufacturing Process | PM <sub>10</sub> | 0.1   | 0.2 |
|    |  | SO <sub>2</sub>  | 0.1   | 0.1 |

| SN | Description                                  | Pollutant       | lb/hr | tpy  |
|----|--|-----------------|-------|------|
|    | Regenerative Thermal Oxidizer (3.3 MMBTU/hr) | VOC             | 2.4   | 8.1  |
|    |  | CO              | 6.5   | 26.8 |
|    |  | NO <sub>x</sub> | 0.4   | 1.5  |

19. The permittee shall not exceed the emission rates set forth in the following table. The permittee shall demonstrate compliance with this condition by through compliance with Specific Condition #25 and Plant Wide Condition #13. [Reg.18.801 and Ark. Code Ann. § 8-4-203 as referenced by Ark. Code Ann. §§ 8-4-304 and 8-4-311]

| SN | Description  | Pollutant         | lb/hr | tpy  |
|----|--|-------------------|-------|------|
| 11 | RCI<br>UFC/Formaldehyde<br>Manufacturing Process<br>Regenerative Thermal<br>Oxidizer (3.3<br>MMBTU/hr) | PM                | 0.1   | 0.2  |
|    |  | Acetaldehyde      | 0.03  | 0.11 |
|    |  | Epichlorohydrin   | 0.10  | 0.10 |
|    |  | Formaldehyde      | 0.20  | 0.50 |
|    |  | Hexane            | 0.01  | 0.03 |
|    |  | Hydrogen Chloride | 2.23  | 4.47 |
|    |  | Methanol          | 0.90  | 2.20 |
|    |  | Phenol            | 0.02  | 0.06 |
|    |  | POM (Total)       | 0.01  | 0.01 |
|    |  | Cadmium           | 0.01  | 0.01 |

20. Visible emissions may not exceed the limits specified in the following table of this permit as measured by EPA Reference Method 9. Compliance with this limit shall be demonstrated by natural gas combustion.

| SN | Limit | Regulatory Citation  |
|----|-------|--|
| 11 | 5%    | Reg.18.501 and Ark. Code Ann. § 8-4-203 as referenced by Ark. Code Ann. §§ 8-4-304 and 8-4-311 |

21. The permittee shall reduce inlet emissions of total organic HAP by 95 percent from RCI UFC/Formaldehyde Manufacturing Process Oxidizer Regenerative Thermal (OX-2) or

- greater except during periods of planned routine maintenance and during a Startup, Shutdown or Malfunction. All such events shall be reported in accordance with Specific Condition #26. Compliance with this condition will be demonstrated by Specific Condition #25. [Reg.19.304 and 40 C.F.R. Part 63, Subpart G, §63.119(e)1-5]
22. The permittee shall reduce inlet emissions of total organic HAP by 83 percent or greater from kettles K-1 through K-3. Compliance with this condition will be demonstrated by Specific Conditions #25 and #29. [Reg.19.304 and 40 C.F.R. Part 63, Subpart OOO, §63.1406(a)(2)ii]
  23. Periods of planned routine maintenance for the RCI UFC/Formaldehyde Manufacturing Process Regenerative Thermal Oxidizer, OX-2, SN-11, shall not exceed 240 hours per year. Compliance with this condition will be shown by Specific Condition #24. [Reg.19.304 and 40 C.F.R. Part 63, Subpart G, §63.119(e)3]
  24. The permittee shall maintain a record of all planned routine maintenance for the RCI UFC/Formaldehyde Manufacturing Process Regenerative Thermal Oxidizer, OX-2, SN-11. [Reg.19.705 and 40 C.F.R. Part 52, Subpart E]
  25. The permittee shall maintain a minimum oxidizer temperature of 910EC (or subsequent established minimum temperature in the most recent NCS update) in the RCI Formaldehyde Manufacturing Process Regenerative Thermal Oxidizer combustion chamber, OX-2, SN-11 whenever the RCI formaldehyde plant is in operation, the methanol tank is in service, or the kettles K-1 through K-7 are producing amino-phenolic resins. As allowed in 40 CFR §63.152(f)(5-7), and 40 CFR §63.1416(c)(2-4), periods of non-operation, SSM events<sup>1</sup> and monitoring system breakdowns, repairs, calibrations and zero (low level) and high-level adjustments do not count toward the calculation of the “daily average value”. Compliance with this condition will be demonstrated by Specific Conditions #27 and #28. [Reg.19.304, 40 C.F.R. Part 63, Subpart G, §60.120(d)5, and 40 C.F.R. Part 63, Subpart OOO]
  26. The permittee shall report all upset conditions, including planned routine maintenance and SSM as referenced in Specific Condition #21. Any exceedance shall be deemed in violation and be subject to enforcement actions unless the permittee demonstrate that the excess emissions resulted from:
    - a. Equipment malfunction or upset and are not the result of negligence or improper maintenance; or
    - b. Physical constraints on the ability of a source to comply with the emission standard, limitation or rate during startup or shutdown;

---

<sup>1</sup> Due to recent changes to the Resin MACT (see 79 Fed. Reg. 60898 (Oct. 8, 2014)), the duration of SSM events are no longer excluded from monitoring data utilized to determine compliance with Resin MACT requirements. 40 CFR § 63.1416(4). The duration of SSM events will, however, continue to be excluded from monitoring data utilized to determine compliance with HON requirements.

The permittee shall report such occurrence or upset or breakdown of equipment, with the exception of SSM events where the actions taken in response are consistent with the procedures specified in the SSM Plan required by Specific Condition #34, to the Department by the end of the next business day after the discovery of the occurrence and submit to the Department a full report of occurrence in accordance with Regulation No. 19 §19.601(c). SSM events where the actions taken in response are consistent with the procedures specified in the SSM Plan shall be reported with the semi-annual SSM reports required by Specific Condition #38. [Reg.19.601 and 40 C.F.R. Part 52, Subpart E]

27. The permittee shall install, calibrate, maintain, and operate according to manufacturer's specifications a temperature monitoring device equipped with a continuous recorder. The temperature monitoring device shall be installed in the combustion chamber of the regenerative thermal oxidizer or in the ductwork immediately downstream of the firebox in a position before any substantial heat exchange occurs. [Reg.19.304, 40 C.F.R. Part 63, Subpart G, and 40 C.F.R. Part 63, Subpart OOO]
28. The permittee shall maintain continuous records of the temperature in the combustion chamber as monitored by the temperature monitoring device. The permittee shall also maintain daily averages of the combustion chamber or position immediately downstream of the combustion chamber. [Reg.19.304, 40 C.F.R. Part 63, Subpart G, and 40 C.F.R. Part 63, Subpart OOO]
29. The permittee shall conduct an initial compliance test of the HAP destruction efficiency of the RCI Formaldehyde Manufacturing Process Regenerative Thermal Oxidizer, SN-11. This test was conducted in accordance with the provisions of §63.1413 and §63.997. This test was initially conducted on December 18, 2001. An additional performance test to establish a new temperature operating range of the RTO was conducted on May 16-17, 2012. [Reg.19.304 and 40 C.F.R. Part 63, Subpart G]
30. The permittee shall conduct annual inspections of the RCI Formaldehyde Manufacturing Process Oxidizer, SN-11 and all its associated equipment subject to 40 CFR Part 63, Subpart G. These annual inspections shall be conducted according to §63.148(b)(1)(ii). [Reg.19.304 and 40 C.F.R. Part 63, Subpart G]
31. The permittee shall submit Periodic Reports no later than March 30<sup>th</sup> and September 30<sup>th</sup> of each year covering the six month period ending thirty days prior to each due date as approved by EPA on August 14, 2012. [Reg.19.304 and 40 C.F.R. Part 63, Subpart G]
32. The permittee shall record, update annually, and maintain the following information: an analysis of the design and actual throughput of the transfer rack, an analysis documenting the weight-percent organic HAPs in the liquid loaded, and an analysis documenting the annual rack weighted average HAP partial pressure of the transfer rack. These records shall be kept on site and made available to Department personnel upon request. [Reg.19.304 and 40 C.F.R. Part 63, Subpart G, §63.130(f)]

33. The permittee shall install, maintain, and operate a flow indicator on the bypass line which diverts emissions required to be controlled by this subpart to identify any period when the emissions are not routed to OX-2. [Reg.19.304 40 C.F.R. Part 63, Subpart OOO, §63.1415(d)(1).]
34. The permittee shall develop, implement and maintain a startup, shutdown, and malfunction plan. [Reg.19.304 and 40 C.F.R. Part 63, Subpart A 63.6(e)(3) and 40 C.F.R. Part 63, Subpart G, §63.119]
35. The permittee shall comply with the equipment leak provisions of 40 CFR Part 63, Subpart UU. The provisions of Subpart UU include: [Reg.19.304 and 40 C.F.R. Part 63, Subpart OOO, §63.1410]
  - a. Identifying all equipment subject to Subpart UU - §63.1022
  - b. Conducting monitoring for leaks - §63.1022
  - c. Maintain records for equipment subject to Subpart UU - §63.1038
  - d. Reporting is required in the Periodic Reports of Subpart OOO in Specific Condition #37.
36. The permittee shall submit a Notification of Compliance Status as outlined in §63.1417(e) within 150 days after the January 20, 2003 compliance date. The facility submitted the Notification of Compliance Status on June 17, 2003. The facility conducted subsequent performance testing on May 16-17, 2012 and submitted an amendment to the Notification of Compliance Status on July 16, 2012. [Reg.19.304 and 40 C.F.R. Part 63, Subpart OOO, §63.1417(e)]
37. The permittee shall submit periodic reports no later than March 30th and September 30th of each year covering the six month period ending thirty days prior to each due date as approved by EPA on August 14, 2012. [Regulation No. 19 §19.304 and 40 CFR Part 63, Subpart OOO]
38. The permittee shall submit start-up, shutdown, and malfunction (SSM) reports as outlined in §63.152(d)(1) and reports of malfunctions as outlined in §63.1417(g) on the same schedule as the Periodic Reports in Specific Condition #37. The reports shall include events handled consistent with the SSM Plan. SSM events that are not handled consistent with the SSM plan shall be reported in accordance with General Provision #8a. [Reg.19.304, 40 C.F.R. Part 63, Subpart OOO, §63.1417(g) and 40 C.F.R. Part 63, Subpart G, §63.152(d)(1)]
39. The permittee shall submit other reports as required by §63.1417(h). These reports shall include: [Reg.19.304 and 40 C.F.R. Part 63, Subpart OOO, §63.1417(h)]
  - a. Notification of storage vessel inspection as specified in 40 C.F.R. Part 63, Subpart WW. - §63.1417(h)(1)

Georgia-Pacific Chemicals LLC

Permit #: 1177-AOP-R15

AFIN: 02-00028

- b. Site Specific Test Plan. This report shall be submitted no later than 90 days prior to the planned date for a performance test and shall contain the information required in §63.1417(h)(2).
- c. Notification of Planned Performance Tests. This notification shall be at least 30 days prior to the date the performance test is scheduled. - §63.1417(h)(3).
- d. Notification of change in primary product. - §63.1417(h)(4)
- e. Notification of added emission points. - §63.1417(h)(5)
- f. Redesignation of control device. - §63.1417(h)(6)
- g. Notification of process change. - §63.1417(h)(7)



SN-129 Thermal Oxidizer

Source Description

The thermal oxidizer is a direct flame thermal oxidizer. Although the device is intended as a backup for the Complex Boiler (SN-05) it is permitted for continuous use. The Thermal Oxidizer is the back-up control device for the MON (40 CFR 63, Subpart FFFF) sources that are normally controlled by the Complex Boiler. The thermal oxidizer uses natural gas as an auxiliary fuel.

Specific Conditions

40. The permittee shall not exceed the emission rates set forth in the following table. The permittee shall demonstrate compliance with this condition by compliance with Specific Conditions #42 and #46. [Reg.19.501 *et seq.* and 40 C.F.R. § 52 Subpart E]

| SN  | Description                        | Pollutant        | lb/hr | tpy  |
|-----|------------------------------------|------------------|-------|------|
| 129 | Thermal Oxidizer<br>(2.5 MMBtu/hr) | PM <sub>10</sub> | 1.1   | 4.6  |
|     |                                    | SO <sub>2</sub>  | 1.2   | 5.4  |
|     |                                    | VOC              | 0.5   | 2.2  |
|     |                                    | CO               | 2.8   | 12.2 |
|     |                                    | NO <sub>x</sub>  | 1.6   | 6.7  |

41. The permittee shall not exceed the emission rates set forth in the following table. The permittee shall demonstrate compliance with this condition by compliance with Specific Conditions #42 and #46. [Reg.18.801 and Ark. Code Ann. § 8-4-203 as referenced by Ark. Code Ann. §§ 8-4-304 and 8-4-311]

| SN  | Description      | Pollutant    | lb/hr | tpy  |
|-----|------------------|--------------|-------|------|
| 129 | Thermal Oxidizer | PM           | 1.1   | 4.6  |
|     |                  | Total Iodine | 4.20* | 3.80 |
|     |                  | Acetaldehyde | 0.01  | 0.01 |
|     |                  | Acrolein     | 0.01  | 0.01 |
|     |                  | Formaldehyde | 0.02  | 0.06 |
|     |                  | Hexane       | 0.03  | 0.13 |
|     |                  | Methanol     | 0.01  | 0.02 |

| SN | Description | Pollutant  | lb/hr | tpy  |
|----|-------------|------------|-------|------|
|    |             | Phenol     | 0.02  | 0.06 |
|    |             | POM(Total) | 0.01  | 0.01 |
|    |             | Cadmium    | 0.01  | 0.01 |

\* Batch Average

42. Visible emissions may not exceed the limits specified in the following table of this permit as measured by EPA Reference Method 9. Compliance with this limit shall be demonstrated by Specific Condition #43.

| SN  | Limit | Regulatory Citation                         |
|-----|-------|---|
| 129 | 20%   | Reg.19.503 and 40 C.F.R. Part 52, Subpart E |

43. Weekly observations of the opacity from SN-129 shall be conducted by a person trained but not necessarily certified in EPA Reference Method 9/a certified EPA Reference Method 9 reader. If visible emissions in excess of the permitted levels are detected, the permittee shall immediately take action to identify the cause of the visible emissions in excess of the permit limit, implement corrective action, and document that visible emissions did not appear to be in excess of the permitted opacity following the corrective action/perform an EPA Reference Method 9 test to verify emissions are not in excess of the permitted level. The permittee shall maintain records which contain the following items in order to demonstrate compliance with this specific condition. These records shall be updated weekly, kept on site, and made available to Department personnel upon request.

- a. The date and time of the observation.
- b. If visible emissions which appeared to be above the permitted limit were detected.
- c. If visible emissions which appeared to be above the permitted limit were detected, the cause of the exceedance of the opacity limit, the corrective action taken, and if the visible emissions appeared to be below the permitted limit after the corrective action was taken.
- d. The name of the person conducting the opacity observations

[Reg.18.1004 and Ark. Code Ann. § 8-4-203 as referenced by Ark. Code Ann. §§ 8-4-304 and 8-4-311]

44. When Thermal Oxidizer (SN-129) is in service, the permittee shall maintain a “daily average” thermal oxidizer firebox temperature at or above established operating range submitted in the most recent MON Notification of Compliance Status (NCS) Report.

Based on the latest NCS submitted in October 2009, the Thermal Oxidizer must operate with a firebox temperature at or above 1,410°F on a “daily average” basis. Compliance with this condition will be demonstrated by Specific Condition #45. [Reg.19.705, Ark. Code Ann. § 8-4-203 as referenced by Ark. Code Ann. §§ 8-4-304 and 8-4-311, and 40 C.F.R. §70.6]

45. The permittee shall maintain daily records of the temperature in the Thermal Oxidizer, SN-129, for each day the unit is in use. These records shall be kept on site and made available to Department personnel upon request. [Reg.19.705 and 40 C.F.R. Part 52, Subpart E]
46. The permittee shall test the Thermal Oxidizer, SN-129, for emissions of SO<sub>2</sub> and VOC to test compliance with the limits set forth in the table in Specific Condition #40 above. These tests shall be conducted using an EPA approved test method for each pollutant tested and while operating as a control device for the facility. The compliance testing conducted December 19, 2001 satisfies the requirements of this permit condition. [Reg.19.702 and 40 C.F.R. Part 52, Subpart E]
47. The Thermal Oxidizer, SN-129, or the Complex Boiler, SN-05, shall be operated at all times that the Tall Oil Fractionation Plant, the Rosin Size Plant, or the Rosin Derivatives Plant is in production. [Reg.19.705, Ark. Code Ann. § 8-4-203 as referenced by Ark. Code Ann. §§ 8-4-304 and 8-4-311, and 40 C.F.R. §70.6]
48. The permittee shall comply with one of the following emission limitations for the Rosin Size Cooker and TOFRAC Hot Wells #1 and #2 except during periods of start-up, shutdown, and malfunction. [Reg.19.703, 40 C.F.R. §63.2460(a)]
  - a. Reduce emissions of total organic HAP, measured as TOC (as carbon), by 98%; or
  - b. Limit emissions of organic HAP, measured as TOC (as carbon), to 20 ppmvd.

Compliance with this condition shall be demonstrated by compliance with Specific Condition #51. [Reg.19.703, 40 C.F.R. §63.2460(a)]

49. The permittee shall install, calibrate, maintain, and operate according to manufacturer’s specifications a temperature monitoring device equipped with a continuous recorder. The temperature monitoring device shall be installed in the firebox of the oxidizer or in the ductwork immediately downstream of the firebox in a position before any substantial heat exchange occurs. [Reg.19.304, 40 C.F.R. Part 63 Subpart FFFF, and 40 C.F.R. Part 63 Subpart SS]
50. The permittee shall maintain continuous records of the temperature in the firebox as monitored by the temperature monitoring device. The permittee shall also maintain daily averages of the firebox temperature or position immediately downstream of the firebox. These records shall be kept onsite, updated daily, and made available to Department personnel upon request. [Reg.19.304, 40 C.F.R. 63 Subpart FFFF, and 40 C.F.R. Part 63 Subpart SS]

51. The permittee shall conduct an initial TOC compliance test to establish compliance with either the 98% destruction efficiency requirement or the 20 ppmvd outlet limitation for the Thermal Oxidizer. This test shall be conducted under hypothetical worst case conditions based on the capture and control system limitations. The performance test shall establish the operating range as required by Subpart FFFF and Subpart SS. The permittee shall submit a Notification of Performance Test at least 60 calendar days prior to the initial or any subsequent performance test and the results of the initial performance test shall be submitted with the Notification of Compliance Status no later than October 5, 2008. MON test was last conducted on August 19, 2009. [Reg.19.304, 40 C.F.R. 63 Subpart FFFF, and 40 C.F.R. Part 63 Subpart SS]
52. The permittee shall submit Periodic Reports no later than March 30<sup>th</sup> and September 30<sup>th</sup> of each year covering the six month period ending thirty days prior to each due date as approved by EPA on August 14, 2012. The permittee shall report start-up, shutdown, and malfunction (SSM) events handled consistent with the SSM Plan on the Semi-Annual Compliance Report. SSM events that are not handled consistent with the SSM Plan shall be reported in accordance with General Provision #8a. [Reg.19.304, 40 C.F.R. 63 Subpart FFFF]
53. The permittee shall develop, implement and maintain a startup-shutdown, and malfunction plan by May 10, 2008. [Reg.19.304, 40 C.F.R. 63 Subpart FFFF]
54. The permittee shall submit a Notification of Compliance Status as outlined in §63.2550 (d) by October 5, 2008. [Reg.19.304, 40 C.F.R. 63 Subpart FFFF]
55. The permittee shall submit other reports as required by §63.2520 including Notification of process change in accordance with 40 CFR §63.2520(e)(10). [Reg.19.304, 40 C.F.R. 63 Subpart FFFF]
56. The permittee shall maintain records as required by §63.2525. [Reg.19.304, 40 C.F.R. 63 Subpart FFFF]

SN-139 Tail Oil Products Loading Stations

Source Description

The Tail Oil Products Loading Stations are used to load or offload a variety of tail oil byproducts and formulated products between storage tanks, trucks and railcars. Some of the products loaded at these transfer racks may contain organic HAP impurities or residuals which necessitate that these loading stations be regulated as Group 2, transfer racks with no control requirements under the Miscellaneous Organic NESHAP, 40 CFR 63, Subpart FFFF.

Specific Conditions

57. The permittee shall not exceed the emission rates set forth in the following table. The permittee shall demonstrate compliance with this condition by complying with Plant Wide Condition #13. [Reg.19.501 *et seq.* and 40 C.F.R. § 52 Subpart E]

| SN  | Description                        | Pollutant | lb/hr | tpy  |
|-----|------------------------------------|-----------|-------|------|
| 139 | Tail Oil Products Loading Stations | VOC       | 15.0  | 2.87 |

SN-136 Crude Tall Oil, Deaerator, and Novacote Resins Loading Stations

Source Description

The Crude Tall Oil (CTO), Deaerator, and Novacote Resins Loading Stations are used to load and offload crude tall oil, deaerator products, and Novacote resin products between storage tanks, trucks and railcars. Some of the products loaded at these transfer racks may contain OHAP impurities which necessitate that these loading stations be regulated as Group 2 transfer racks with no control requirements under the Miscellaneous Organic NESHAP, 40 CFR 63, Subpart FFFF.

Specific Conditions

58. The permittee shall not exceed the emission rates set forth in the following table. The permittee shall demonstrate compliance with this condition by complying with Plant Wide Condition #13. [Reg.19.501 *et seq.* and 40 C.F.R. § 52 Subpart E]

| SN  | Description   | Pollutant | lb/hr | tpy |
|-----|---|-----------|-------|-----|
| 136 | Crude Tall Oil, Deaerator, and Novacote Resins Loading Stations | VOC       | 0.1   | 0.2 |

59. The permittee shall not exceed the emission rates set forth in the following table. The permittee shall demonstrate compliance with this condition by complying with Plant Wide Condition #13. [Reg.18.801 and Ark. Code Ann. § 8-4-203 as referenced by Ark. Code Ann. §§ 8-4-304 and 8-4-311]

| SN  | Description   | Pollutant | lb/hr | tpy |
|-----|---|-----------|-------|-----|
| 136 | Crude Tall Oil, Deaerator, and Novacote Resins Loading Stations | Ammonia   | 0.4   | 1.6 |

SN-138 Resin Loading Stations

Source Description

The resin loading stations are used to offload a variety phenol formaldehyde resin products to trucks and railcars. The UFC loading stations are part of the amino phenolic production unit, but are not regulated.

Specific Conditions

60. The permittee shall not exceed the emission rates set forth in the following table. The permittee shall demonstrate compliance with this condition by complying with Plant Wide Condition #13. [Reg.19.501 *et seq.* and 40 C.F.R. § 52 Subpart E]

| SN  | Description            | Pollutant | lb/hr | tpy |
|-----|------------------------|-----------|-------|-----|
| 138 | Resin Loading Stations | VOC       | 0.4   | 1.2 |

61. The permittee shall not exceed the emission rates set forth in the following table. The permittee shall demonstrate compliance with this condition by complying with Plant Wide Condition #13. [Reg.18.801 and Ark. Code Ann. § 8-4-203 as referenced by Ark. Code Ann. §§ 8-4-304 and 8-4-311]

| SN  | Description            | Pollutant    | lb/hr | tpy  |
|-----|------------------------|--------------|-------|------|
| 138 | Resin Loading Stations | Formaldehyde | 0.02  | 0.05 |
|     |                        | Methanol     | 0.17  | 0.60 |
|     |                        | Phenol       | 0.02  | 0.06 |

SN-140 Emergency Generator Diesel Fired (GEN-2)

Source Description

The diesel fired generator is used as a back-up for failures of the electricity from the local utility. To help ensure the equipment is reliable during emergency situations, the generator is test run each week. Typically, the unit will be operated for very short durations not to exceed 1,500 hours/year. The generator includes an emergency stationary Reciprocating Internal Combustion Engine (RICE) with a brake horsepower of 755 HP.

Specific Conditions

62. The permittee shall not exceed the emission rates set forth in the following table. The permittee shall demonstrate compliance with this condition by complying with Specific Condition #64. [Reg.19.501 *et seq.* and 40 C.F.R. § 52 Subpart E]

| SN  | Description                              | Pollutant        | lb/hr | tpy  |
|-----|--|------------------|-------|------|
| 140 | Emergency Generator Diesel Fired (GEN-2) | PM <sub>10</sub> | 1.7   | 1.3  |
|     |  | SO <sub>2</sub>  | 1.6   | 1.2  |
|     |  | VOC              | 2.0   | 1.5  |
|     |  | CO               | 5.1   | 3.8  |
|     |  | NO <sub>x</sub>  | 23.4  | 17.5 |

63. The permittee shall not exceed the emission rates set forth in the following table. The permittee shall demonstrate compliance with this condition by complying with Specific Condition #64. [Reg.18.801 and Ark. Code Ann. § 8-4-203 as referenced by Ark. Code Ann. §§ 8-4-304 and 8-4-311]

| SN  | Description                              | Pollutant    | lb/hr | tpy  |
|-----|--|--------------|-------|------|
| 140 | Emergency Generator Diesel Fired (GEN-2) | PM           | 1.7   | 1.3  |
|     |  | Acetaldehyde | 0.01  | 0.01 |
|     |  | Formaldehyde | 0.01  | 0.01 |
|     |  | POM(Total)   | 0.01  | 0.01 |

64. The permittee shall not operate the emergency generator SN-140 in excess of 1,500 total hours (emergency and non-emergency) per calendar year in order to demonstrate compliance with the annual emission rate limits. Emergency operation in excess of these hours may be allowable but shall be reported and will be evaluated in accordance with



Georgia-Pacific Chemicals LLC  
Permit #: 1177-AOP-R15  
AFIN: 02-00028

Reg.19.602 and other applicable regulations. [Reg.19.705, Ark. Code Ann. § 8-4-203 as referenced by Ark. Code Ann. §§ 8-4-304 and 8-4-311, and 40 C.F.R. §70.6]

65. The permittee shall maintain monthly records to demonstrate compliance with Specific Condition #64. The permittee shall update these records by the fifteenth day of the month following the month to which the records pertain. The calendar year totals and each individual month's data shall be maintained on-site, made available to Department personnel upon request, and submitted in accordance with General Provision #7. [Reg.19.705 and 40 C.F.R. Part 52, Subpart E]
  
66. The Emergency Generator (SN-140) is subject to the standards 40 CFR, Part 63 Subpart ZZZZ (*NESHAP for Stationary Reciprocating Internal Combustion Engines (RICE)*). The permittee shall demonstrate compliance through initial notification requirement as specified in §63.6645(f). [Reg.19.304 and 40 C.F.R. Part 63, Subpart ZZZZ]

SN-145 Haul Roads

Source Description

Vehicle traffic on the paved roads throughout the manufacturing complex creates fugitive dust emissions.

Specific Conditions

67. The permittee shall not exceed the emission rates set forth in the following table. The permittee shall demonstrate compliance with this condition by complying with Specific Condition #69. [Reg.19.501 *et seq.* and 40 C.F.R. § 52 Subpart E]

| SN  | Description | Pollutant        | lb/hr | tpy |
|-----|-------------|------------------|-------|-----|
| 145 | Haul Roads  | PM <sub>10</sub> | 0.1   | 0.1 |

68. The permittee shall not exceed the emission rates set forth in the following table. The permittee shall demonstrate compliance with this condition by complying with Specific Condition #69. [Reg.18.801 and Ark. Code Ann. § 8-4-203 as referenced by Ark. Code Ann. §§ 8-4-304 and 8-4-311]

| SN  | Description | Pollutant | lb/hr | tpy |
|-----|-------------|-----------|-------|-----|
| 145 | Haul Roads  | PM        | 0.5   | 0.4 |

69. The permittee shall not operate in a manner such that fugitive emissions from the haul roads would cause a nuisance off-site or allow visible emissions from extending beyond the property boundary. Off-site opacity less than or equal to 5% shall not be considered a nuisance. The permittee shall use water sprays or other techniques as necessary to control fugitive emissions that migrate off-site. [Reg.18.501, and Ark. Code Ann. § 8-4-203 as referenced by Ark. Code Ann. §§ 8-4-304 and 8-4-311]

SN-146 Equipment Leaks (Fugitive)

Source Description

Fugitive VOC/HAP emissions result from equipment component leaks such as valves, connectors, pumps, and agitators.

Specific Conditions

70. The permittee shall not exceed the emission rates set forth in the following table. The permittee shall demonstrate compliance with this condition by complying with Specific Condition #35 for Resin MACT, Plantwide Conditions #17 and 18 for HON, Plantwide Condition #20, #21, #23, and #24 for WSR MACT and Plantwide Condition #30 for MON. [Reg.19.501 *et seq.* and 40 C.F.R. § 52 Subpart E]

| SN  | Description                | Pollutant | lb/hr | tpy |
|-----|----------------------------|-----------|-------|-----|
| 146 | Equipment leaks (Fugitive) | VOC       | 1.7   | 7.5 |

71. The permittee shall not exceed the emission rates set forth in the following table. The permittee shall demonstrate compliance with this condition by compliance with Specific Condition #35 for Resin MACT, Plantwide Conditions #17 and 18 for HON, Plantwide Condition #20, #21, #23, and #24 for WSR MACT and Plantwide Condition #30 for MON. [Reg.18.801 and Ark. Code Ann. § 8-4-203 as referenced by Ark. Code Ann. §§ 8-4-304 and 8-4-311]

| SN  | Description                | Pollutant       | lb/hr | tpy  |
|-----|----------------------------|-----------------|-------|------|
| 146 | Equipment leaks (Fugitive) | Epichlorohydrin | 0.04  | 0.17 |
|     |                            | O-Cresol        | 0.01  | 0.04 |
|     |                            | Formaldehyde    | 0.15  | 0.66 |
|     |                            | Methanol        | 0.43  | 1.90 |
|     |                            | Phenol          | 0.03  | 0.12 |
|     |                            | Ethylene Glycol | 1.10  | 4.60 |

**Liquid Resins Manufacturing Sources**  
 SN-13 Resi-Mix Silo Process Feed System Baghouse

Source Description

The Resi-Mix Silo Process Feed System Baghouse, BH-2, controls dust emissions from extenders and fillers, as well as the raw material conveying equipment. The dust collected in the baghouse is recycled and used as raw material in the Resi-Mix Process.

Specific Conditions

72. The permittee shall not exceed the emission rates set forth in the following table. The permittee shall demonstrate compliance with this condition by complying with Plant Wide Condition #13. [Reg.19.501 *et seq.* and 40 C.F.R. § 52 Subpart E]

| SN | Description                                | Pollutant        | lb/hr | tpy |
|----|--|------------------|-------|-----|
| 13 | Resi-Mix Silo Process Feed System Baghouse | PM <sub>10</sub> | 0.1   | 0.4 |

73. The permittee shall not exceed the emission rates set forth in the following table. The permittee shall demonstrate compliance with this condition by complying with Plant Wide Condition #13. [Reg.18.801 and Ark. Code Ann. § 8-4-203 as referenced by Ark. Code Ann. §§ 8-4-304 and 8-4-311]

| SN | Description                                | Pollutant | lb/hr | tpy |
|----|--|-----------|-------|-----|
| 13 | Resi-Mix Silo Process Feed System Baghouse | PM        | 0.1   | 0.4 |

74. Visible emissions may not exceed the limits specified in the following table of this permit as measured by EPA Reference Method 9. Compliance with this limit shall be demonstrated through compliance with Plant Wide Condition #15.

| SN | Limit | Regulatory Citation  |
|----|-------|--|
| 13 | 5%    | Reg.18.501 and Ark. Code Ann. § 8-4-203 as referenced by Ark. Code Ann. §§ 8-4-304 and 8-4-311 |

75. The Resi-Mix Silo Process Feed System Baghouse (SN-13) is subject to Compliance Assurance Monitoring (CAM) and shall comply with all applicable CAM provisions, including: [Reg.19.703, 40 C.F.R. Part 52 Subpart E, and Part §64.6]

Georgia-Pacific Chemicals LLC

Permit #: 1177-AOP-R15

AFIN: 02-00028

- a. The permittee shall perform a visible inspection of the baghouse exhaust once a week to check that the baghouse is operating in good working order. The permittee shall maintain records which document the baghouse inspection date and results. The records shall be updated on a weekly basis. These records shall be kept on site, provided to Department personnel upon request and may be used by the Department for enforcement purposes.
- b. The presence of any visible emissions from the operating baghouse shall be considered an indicator that a bag rupture or leak is occurring and that corrective action is necessary.
- c. Upon observing visible emissions, an operator will check the pressure drop, pulsing system, and baghouse structure as appropriate. If these checks do not allow the operator to correct the visible emissions, the maintenance department will be notified immediately. A complete maintenance inspection will be initiated within 12 hours of the observation and any necessary repairs will be completed within 12 hours or the source shall be taken out of service until the maintenance inspection and any necessary repairs can be made. Records of corrective action shall be kept onsite, updated daily, and made available to Department personnel upon request.

SN-18 Resi-Mix Silo Process Feed System baghouse

Source Description

The Resi-Mix Silo Process Feed System Baghouse, BH-2, controls dust emissions from extenders and fillers, as well as the raw material conveying equipment. The dust collected in the baghouse is recycled and used as raw material in the Resi-Mix Process.

Specific Conditions

76. The permittee shall not exceed the emission rates set forth in the following table. The permittee shall demonstrate compliance with this condition by complying with Plant Wide Condition #13. [Reg.19.501 *et seq.* and 40 C.F.R. § 52 Subpart E]

| SN | Description                                | Pollutant        | lb/hr | tpy |
|----|--|------------------|-------|-----|
| 18 | Resi-Mix Silo Process Feed System baghouse | PM <sub>10</sub> | 0.1   | 0.3 |
|    |  | VOC              | 0.1   | 0.1 |

77. The permittee shall not exceed the emission rates set forth in the following table. The permittee shall demonstrate compliance with this condition by complying with Plant Wide Condition #13. [Reg.18.801 and Ark. Code Ann. § 8-4-203 as referenced by Ark. Code Ann. §§ 8-4-304 and 8-4-311]

| SN | Description                                | Pollutant    | lb/hr | tpy  |
|----|--|--------------|-------|------|
| 18 | Resi-Mix Silo Process Feed System baghouse | PM           | 0.1   | 0.3  |
|    |  | Formaldehyde | 0.01  | 0.01 |
|    |  | Methanol     | 0.01  | 0.01 |
|    |  | Phenol       | 0.01  | 0.01 |

78. Visible emissions may not exceed the limits specified in the following table of this permit as measured by EPA Reference Method 9. Compliance with this limit shall be demonstrated through compliance with Plant Wide Condition #15.

| SN | Limit | Regulatory Citation  |
|----|-------|--|
| 13 | 5%    | Reg.18.501 and Ark. Code Ann. § 8-4-203 as referenced by Ark. Code Ann. §§ 8-4-304 and 8-4-311 |

79. The Resi-Mix Resin Process Mix Tank (SN-18) is subject to Compliance Assurance Monitoring (CAM) and shall comply with all applicable CAM provisions, including: [Reg.19.703, 40 C.F.R. Part 52 Subpart E, and Part §64.6]

- a. The permittee shall perform a visible inspection of the baghouse exhaust once a week to check that the baghouse is operating in good working order. The permittee shall maintain records which document the baghouse inspection date and results. The records shall be updated on a weekly basis. These records shall be kept on site, provided to Department personnel upon request and may be used by the Department for enforcement purposes.
- b. The presence of any visible emissions from the operating baghouse shall be considered an indicator that a bag rupture or leak is occurring and that corrective action is necessary.
- c. Upon observing visible emissions, an operator will check the pressure drop, pulsing system, and baghouse structure as appropriate. If these checks do not allow the operator to correct the visible emissions, the maintenance department will be notified immediately. A complete maintenance inspection will be initiated within 12 hours of the observation and any necessary repairs any necessary repairs will be completed within 12 hours or the or the source shall be taken out of service until the maintenance inspection and any necessary repairs can be made. Records of corrective action shall be kept onsite, updated daily, and made available to Department personnel upon request.

SN-61 Cresylic Acid/Sec-Butylphenol Storage Tank

Source Description

The Cresylic Acid Storage Tank, P-7, provides cresylic acid as a raw material to the liquid resin kettles. This tank may also be used to store secondary butylphenols which are on VOC basis equivalent to Cresylic Acid.

Specific Conditions

80. The permittee shall not exceed the emission rates set forth in the following table. Emission limits are based on EPA Tanks emission estimates and are assumed to be worst case. [Reg.19.501 *et seq.* and 40 C.F.R. § 52 Subpart E]

| SN | Description                                | Pollutant | lb/hr | tpy |
|----|--|-----------|-------|-----|
| 61 | Cresylic Acid/Sec-Butylphenol Storage Tank | VOC       | 0.4   | 0.1 |

81. The permittee shall not exceed the emission rates set forth in the following table. Emission limits are based on EPA Tanks emission estimates and are assumed to be worst case. [Reg.18.801 and Ark. Code Ann. § 8-4-203 as referenced by Ark. Code Ann. §§ 8-4-304 and 8-4-311]

| SN | Description                                | Pollutant | lb/hr | tpy  |
|----|--|-----------|-------|------|
| 61 | Cresylic Acid/Sec-Butylphenol Storage Tank | O-Cresol  | 0.20  | 0.01 |
|    |  | Phenol    | 0.30  | 0.01 |



SN-62 Phenol Storage Tank

Source Description

The Phenol Storage Tank, M-8, provides phenol to the kettles at the liquid resin manufacturing plant.

Specific Conditions

82. The permittee shall not exceed the emission rates set forth in the following table. The permittee shall demonstrate compliance with this condition by compliance with Plant Wide Condition #13. [Reg.19.501 *et seq.* and 40 C.F.R. § 52 Subpart E]

| SN | Description         | Pollutant | lb/hr | tpy |
|----|---------------------|-----------|-------|-----|
| 62 | Phenol Storage Tank | VOC       | 3.2   | 0.5 |

83. The permittee shall not exceed the emission rates set forth in the following table. The permittee shall demonstrate compliance with this condition by compliance with Plant Wide Condition #13. [Reg.18.801 and Ark. Code Ann. § 8-4-203 as referenced by Ark. Code Ann. §§ 8-4-304 and 8-4-311]

| SN | Description         | Pollutant | lb/hr | tpy  |
|----|---------------------|-----------|-------|------|
| 62 | Phenol Storage Tank | Phenol    | 3.12  | 0.45 |

SN-63 and SN-65 Pre-polymer Storage Tanks

Source Description

The Pre-Polymer Storage Tanks, P-8 and P-12, provide raw materials to the kettles. Pre-polymer is transported to K-2 through meters. The material is transported to a weigh tank (W-3) which sends the proper amount of pre-polymer to K-1 and K-4. Pre-polymer is an intermediate product which is manufactured in the kettles for later use in manufacturing the final resin product.

Specific Conditions

84. The permittee shall not exceed the emission rates set forth in the following table. The permittee shall demonstrate compliance with this condition by complying with Plant Wide Condition #13. [Reg.19.501 *et seq.* and 40 C.F.R. § 52 Subpart E]

| SN | Description               | Pollutant | lb/hr | tpy |
|----|---------------------------|-----------|-------|-----|
| 63 | Pre-polymer Storage Tanks | VOC       | 0.1   | 0.4 |
| 65 |                           | VOC       | 0.1   | 0.4 |

Georgia-Pacific Chemicals LLC  
Permit #: 1177-AOP-R15  
AFIN: 02-00028

SN-17 and SN-64 Novacote and DETA Storage Tanks

Source Description

The Novacote (SN-17) and DETA (SN-64) Storage Tanks provide raw material for kettles and/or storage tank additions. The resin can be processed through either a mass flow meter or a process weigh tank (W-3) which send the proper amount of resin to the kettles and/or storage tanks.

Specific Conditions

85. The permittee shall not exceed the emission rates set forth in the following table. The permittee shall demonstrate compliance with this condition by complying with Plant Wide Condition #13. [Reg.19.501 *et seq.* and 40 C.F.R. § 52 Subpart E]

| SN | Description           | Pollutant | lb/hr | tpy |
|----|-----------------------|-----------|-------|-----|
| 17 | Novacote Storage Tank | Ammonia   | 0.3   | 0.3 |
| 64 | DETA Storage Tank     | VOC       | 0.2   | 0.1 |

Georgia-Pacific Chemicals LLC  
 Permit #: 1177-AOP-R15  
 AFIN: 02-00028

SN-21, SN-22, SN-23, SN-30, SN-31, SN- 66, SN- 67, SN- 68, SN- 69, SN- 71, SN-73, SN-74,  
 SN-77, SN-78, SN-79, SN-80, SN-81, SN-90, SN-91, SN-97, SN-98, SN-99, SN-100, and SN-  
 102

Liquid Resin storage Tanks

Source Description

The Wet Strength Resin Storage Tanks (SN-21, SN-22, SN-23, SN-97, SN-98, SN-99, SN-100, and SN-102), WS-1 through WS-7 and DS-1, provide product storage for wet strength resin produced in the liquid resin manufacturing reactors until the wet strength resin can be loaded onto trucks for off-site shipment.

The PF Resin Storage tanks (SN-30, SN-66, SN-67, SN-68, SN-69, SN-71, SN-73, and SN-74) are product storage tanks which hold phenol formaldehyde resins produced in the reactors until they are shipped off site by trucks. The PF Resin Storage Tanks have equipment ID numbers P-1, P-2, P-3, P-5, P-6, P-9, P-10, and P-11. These tanks are authorized to store either PF-Resin or UF-Resin.

The Resi Mix Storage Tanks (SN-31, SN-77, SN-78, SN-79, SN-80, SN-81) are product storage tanks for Resi-mix resins produced in the resi-mix tank (K-6) of the resi-mix liquid resin manufacturing plant. The tanks hold the resi-mix resin product until it is loaded onto trucks for off-site shipment.

The UF Resin Storage Tanks (SN-90 and SN-91), U-9 and U-10, store the urea formaldehyde resin products that may be produced by reactors K-1 through K-3 of the liquid resin manufacturing plant. The tanks hold the UF Resin product until it is loaded onto trucks for off-site shipment.

Specific Conditions

86. The permittee shall not exceed the emission rates set forth in the following table. The permittee shall demonstrate compliance with this condition by complying with Plant Wide Condition #13. [Reg.19.501 *et seq.* and 40 C.F.R. § 52 Subpart E]

| SN  | Description                | Pollutant | lb/hr | tpy |
|---|----------------------------|-----------|-------|-----|
| SN-21, SN-22, SN-23, SN-30, SN-31, SN- 66, SN- 67, SN- 68, SN- 69, SN- 71, SN-73, SN-74, SN-77, SN-78, SN-79, SN-80, SN-81, SN-90, SN-91, SN-97, SN-98, SN-99, SN-100, and SN-102 | Liquid Resin storage Tanks | VOC       | 0.5   | 0.3 |

87. The permittee shall not exceed the emission rates set forth in the following table. The permittee shall demonstrate compliance with this condition by complying with Plant

Georgia-Pacific Chemicals LLC

Permit #: 1177-AOP-R15

AFIN: 02-00028

Wide Condition #13. [Reg.18.801 and Ark. Code Ann. § 8-4-203 as referenced by Ark. Code Ann. §§ 8-4-304 and 8-4-311]

| SN  | Description                | Pollutant    | lb/hr | tpy  |
|---|----------------------------|--------------|-------|------|
| N-21, SN-22, SN-23, SN-30, SN-31, SN- 66, SN- 67, SN- 68, SN-69, SN- 71, SN-73, SN-74, SN-77, SN-78, SN-79, SN-80, SN-81, SN-90, SN-91, SN-97, SN-98, SN-99, SN-100, and SN-102 | Liquid Resin storage Tanks | Methanol     | 0.25  | 0.16 |
|   |                            | Formaldehyde | 0.03  | 0.02 |
|   |                            | Phenol       | 0.06  | 0.04 |

SN-95 Resin Plant Back-up Weigh tank

Source Description

The Resin Plant Back-up Weigh Tank, W-3, meters the amount of DETA, phenol, formaldehyde, urea-formaldehyde concentrate, pre-polymer, and other non-HAP/non-VOC additives from various tanks to reactors.

W-3 was replaced by flow meters in a modification to permit 1177-AOP-R1. W-3 will be used as a back-up weigh tank and to stage or temporarily store finished products.

Specific Conditions

88. The permittee shall not exceed the emission rates set forth in the following table. The permittee shall demonstrate compliance with this condition by complying with Plant Wide Condition #13. [Reg.19.501 *et seq.* and 40 C.F.R. § 52 Subpart E]

| SN | Description                    | Pollutant | lb/hr | tpy |
|----|--------------------------------|-----------|-------|-----|
| 95 | Resin Plant Back-up Weigh tank | VOC       | 0.1   | 0.2 |

89. The permittee shall not exceed the emission rates set forth in the following table. The permittee shall demonstrate compliance with this condition by complying with Plant Wide Condition #25. [Reg.18.801 and Ark. Code Ann. § 8-4-203 as referenced by Ark. Code Ann. §§ 8-4-304 and 8-4-311]

| SN | Description                    | Pollutant        | lb/hr | tpy  |
|----|--------------------------------|------------------|-------|------|
| 95 | Resin Plant Back-up Weigh tank | Total Other HAPs | 0.09  | 0.18 |

Georgia-Pacific Chemicals LLC  
Permit #: 1177-AOP-R15  
AFIN: 02-00028

SN-103 Novacote Resin Storage Tank

Source Description

The Novacote Resin Storage Tank, NC-2, provides product storage for Novacote resin produced in the liquid resin manufacturing kettles until the Novacote resin can be loaded onto trucks or railcars for off-site shipment.

Specific Conditions

90. The permittee shall not exceed the emission rates set forth in the following table. The permittee shall demonstrate compliance with this condition by complying with Plant Wide Condition #13. [Reg.19.501 *et seq.* and 40 C.F.R. § 52 Subpart E]

| SN  | Description                 | Pollutant | lb/hr | tpy |
|-----|-----------------------------|-----------|-------|-----|
| 103 | Novacote Resin Storage Tank | Ammonia   | 0.3   | 0.3 |

Georgia-Pacific Chemicals LLC  
Permit #: 1177-AOP-R15  
AFIN: 02-00028

SN-125 Formic Acid Storage Tank

Source Description

Specific Conditions

91. The permittee shall not exceed the emission rates set forth in the following table. The permittee shall demonstrate compliance with this condition by complying with Plant Wide Condition #13. [Reg.19.501 *et seq.* and 40 C.F.R. § 52 Subpart E]

| SN  | Description              | Pollutant   | lb/hr | tpy  |
|-----|--------------------------|-------------|-------|------|
| 125 | Formic Acid Storage Tank | Formic Acid | 8.60  | 0.20 |



Georgia-Pacific Chemicals LLC  
Permit #: 1177-AOP-R15  
AFIN: 02-00028

SN-132 and SN-133 Wet Strength Resin Loading Racks

Source Description

WSLOAD1(SN-132) and WSLOAD2(SN-133) are loading racks exclusively used to load wet strength resins.

Specific Conditions

92. The permittee shall not exceed the emission rates set forth in the following table. The permittee shall demonstrate compliance with this condition by complying with Plant Wide Condition #13. [Reg.19.501 *et seq.* and 40 C.F.R. § 52 Subpart E]

| SN  | Description                     | Pollutant | lb/hr | tpy |
|-----|---------------------------------|-----------|-------|-----|
| 132 | Wet Strength Resin Loading Rack | VOC       | 0.1   | 0.3 |
| 133 |                                 | VOC       | 0.1   | 0.3 |

SN-135 Aqua Ammonia Storage Tank

Source Description

The aqua ammonia storage tank provides ammonia to the kettles at the liquid resin manufacturing plant.

Specific Conditions

93. The permittee shall not exceed the emission rates set forth in the following table. The permittee shall demonstrate compliance with this condition by compliance with Specific Condition #94. [Reg.19.501 *et seq.* and 40 C.F.R. § 52 Subpart E]

| SN  | Description               | Pollutant | lb/hr | tpy |
|-----|---------------------------|-----------|-------|-----|
| 135 | Aqua Ammonia Storage Tank | Ammonia   | 19.1  | 1.9 |

94. The permittee shall not have a throughput in excess of 1,300,000 gallons of aqueous ammonia at SN-135 during any consecutive twelve month period. [Regulation No. 18 §18.1004 and A.C.A. §8-4-203 as referenced by §8-4-304 and §8-4-311]
95. The permittee shall maintain records which demonstrate compliance with the emission limit set in Specific Condition #94. These records may be used by the Department for enforcement purposes. Records shall be updated on a monthly basis, shall be kept on site, and shall be provided to Department personnel in accordance with General Provision #7. [Regulation No. 18 §18.1004 and A.C.A. §8-4-203 as referenced by §8-4-304 and §8-4-311]

SN-142 Liquid Resin Manufacturing Cooling Tower

Source Description

The facility operates a cooling tower as part of the liquid resin manufacturing operations. The make-up water for the cooling tower will come from the Sparta aquifer from a well onsite. The maximum specific conductance of water sampled from the monitoring well near Huttig, AR (approximately 15 miles from the facility) was 1,170  $\mu\text{S}/\text{cm}$  during testing from 2006 to 2010, which correlates to a TDS value of approximately of 872.5 ppm. To be conservative, a maximum TDS value of 1,047 ppm (872.5 plus a 20% safety factor) was used to estimate maximum particulate matter emissions from the tower. The cooling water is treated with chlorine. The chlorine reacts with organics in the water to form chloroform.

Specific Conditions

96. The permittee shall not exceed the emission rates set forth in the following table. Compliance with this condition is demonstrated by the equipment maximum flowrate and maximum TDS value for the Crossett area from USGS. [Reg.19.501 *et seq.* and 40 C.F.R. § 52 Subpart E]

| SN  | Description                              | Pollutant        | lb/hr | tpy |
|-----|--|------------------|-------|-----|
| 142 | Liquid Resin Manufacturing Cooling Tower | PM <sub>10</sub> | 0.8   | 3.4 |
|     |  | VOC              | 0.1   | 0.4 |

97. The permittee shall not exceed the emission rates set forth in the following table. Compliance with this condition is demonstrated by the equipment maximum flowrate and maximum TDS value for the Crossett area from USGS. [Reg.18.801 and Ark. Code Ann. § 8-4-203 as referenced by Ark. Code Ann. §§ 8-4-304 and 8-4-311]

| SN  | Description                              | Pollutant  | lb/hr | tpy  |
|-----|--|------------|-------|------|
| 142 | Liquid Resin Manufacturing Cooling Tower | PM         | 0.8   | 3.4  |
|     |  | Chloroform | 0.08  | 0.34 |
|     |  | Chlorine   | 0.16  | 0.68 |

Georgia-Pacific Chemicals LLC

Permit #: 1177-AOP-R15

AFIN: 02-00028

98. Visible emissions may not exceed the limits specified in the following table of this permit as measured by EPA Reference Method 9. Compliance with the opacity limit for this cooling tower is demonstrated by the equipment maximum flowrate and maximum TDS value for the Crossett area from USGS.

| SN  | Limit | Regulatory Citation                            |
|-----|-------|--|
| 142 | 20%   | Reg.19.503 and 40 C.F.R.<br>Part 52, Subpart E |

**Spray Dry Resin Manufacturing sources**  
 SN-03 Spray Dry Resin Process and Process Heater  
 Source Description

Liquid PF liquid resins manufactured in the batch process reactors are used to manufacture spray-dried resins. PF resin is pumped into two base resin storage tanks (S-1, S-2) and diluted to reduce the solids content. These liquid resins are pumped through a heat exchanger and then injected into the 15.4 MM Btu/hr natural gas fired spray dryer chamber. The atomizing air used in the spray dryer is heated by a natural gas-fired burner. Combustion gases generated by the burner are exhausted through the final spray dryer stack. A drying agent contained in Tank S-3 is also injected into the spray dryer. After exiting the spray drying chamber, the dried resin is cooled before it enters a series of eight (six primary, two secondary) high efficiency cyclones. After the resin is separated from the gas stream, it enters a swirl trap which entrains the particles in a refrigerated air stream. Heavier particles fall through the swirl trap and discharge through a venturi valve where they also encounter the refrigerated air stream. The two air streams are combined and conveyed to the cooling conveyor cyclone collectors (two units). The finished product is then discharged through the packaging system. Emulsifier soap solution is produced in the same manner. Particulate-laden exhaust gases from the six primary cyclone collectors and the cooling conveyor cyclone (secondary) collectors are discharged through a baghouse (BH-4).

Specific Conditions

99. The permittee shall not exceed the emission rates set forth in the following table. The permittee shall demonstrate compliance with this condition by complying with Specific Condition #102 and Plant Wide Condition #13. [Reg.19.501 *et seq.* and 40 C.F.R. § 52 Subpart E]

| SN | Description                                      | Pollutant        | lb/hr | tpy   |
|----|--|------------------|-------|-------|
| 03 | Spray Dry Resin<br>Process and Process<br>Heater | PM <sub>10</sub> | 11.7  | 46.3  |
|    |  | SO <sub>2</sub>  | 0.1   | 0.1   |
|    |  | VOC              | 34.0  | 148.9 |
|    |  | CO               | 1.3   | 5.7   |
|    |  | NO <sub>x</sub>  | 1.6   | 6.8   |

100. The permittee shall not exceed the emission rates set forth in the following table. The permittee shall demonstrate compliance with this condition by compliance with Plant Wide Condition #13. [Reg.18.801 and Ark. Code Ann. § 8-4-203 as referenced by Ark. Code Ann. §§ 8-4-304 and 8-4-311]

| SN | Description                                | Pollutant      | lb/hr | tpy   |
|----|--|----------------|-------|-------|
| 03 | Spray Dry Resin Process and Process Heater | PM             | 11.7  | 46.3  |
|    |  | Acetaldehyde   | 2.20  | 9.50  |
|    |  | Ammonia        | 2.65  | 11.62 |
|    |  | Formaldehyde   | 2.20  | 9.62  |
|    |  | Hexane         | 0.02  | 0.08  |
|    |  | Methanol       | 21.80 | 95.38 |
|    |  | Phenol         | 2.30  | 10.10 |
|    |  | POM (Total)    | 0.01  | 0.01  |
|    |  | Cadmium        | 0.01  | 0.01  |
|    |  | Dimethyl Ether | 0.56  | 2.45  |

101. Visible emissions may not exceed the limits specified in the following table of this permit as measured by EPA Reference Method 9. Compliance with this limit shall be demonstrated by Plant Wide Condition #15.

| SN | Limit | Regulatory Citation  |
|----|-------|--|
| 03 | 5%    | Reg.18.501 and Ark. Code Ann. § 8-4-203 as referenced by Ark. Code Ann. §§ 8-4-304 and 8-4-311 |

102. The permittee shall test the Spray Dry Resin Process and Process Heater, SN-03, for emissions of PM<sub>10</sub> and VOC to demonstrate compliance with the limits set forth in the table in Specific Condition #102 above. These tests shall be conducted using an EPA approved test method for each pollutant tested. The compliance testing conducted on June 2-3, 2008 satisfies the requirements of this permit condition. [Reg.19.702 and 40 C.F.R. Part 52, Subpart E]

Georgia-Pacific Chemicals LLC

Permit #: 1177-AOP-R15

AFIN: 02-00028

103. The Spray Dry Resin Process and Process Heater (SN-03) is subject to Compliance Assurance Monitoring (CAM) and shall comply with all applicable CAM provisions, including: [Reg.19.703, 40 C.F.R. Part 52 Subpart E, and Part §64.6]
- a. The permittee shall perform a visible inspection of the baghouse exhaust once a week to check that the baghouse is operating in good working order. The permittee shall maintain records which document the baghouse inspection date and results. The records shall be updated on a weekly basis. These records shall be kept on site, provided to Department personnel upon request and may be used by the Department for enforcement purposes.
  - b. The presence of any visible emissions from the operating baghouse shall be considered an indicator that a bag rupture or leak is occurring and that corrective action is necessary.
  - c. Upon observing visible emissions, an operator will check the pressure drop, pulsing system, and baghouse structure. If these checks do not allow the operator to correct the visible emissions, the maintenance department will be notified immediately. A complete maintenance inspection will be initiated within 12 hours of the observation and any necessary repairs completed within 12 hours or the source shall be taken out of service until the maintenance inspection and any necessary repairs can be made. Records of corrective action shall be kept onsite, updated daily, and made available to Department personnel upon request.

SN-104 and SN-105 Base Liquid Resin Storage Tanks

Source Description

The Base Liquid Resin Storage Tanks, SD-1 and SD-2, store the PF resins produced at the liquid resin manufacturing plant which will be used in the production of spray dry resins.

Specific Conditions

104. The permittee shall not exceed the emission rates set forth in the following table. The permittee shall demonstrate compliance with this condition by complying with Plant Wide Condition #13. [Reg.19.501 *et seq.* and 40 C.F.R. § 52 Subpart E]

| SN  | Description                     | Pollutant | lb/hr | tpy |
|-----|---------------------------------|-----------|-------|-----|
| 104 | Base Liquid Resin Storage Tanks | VOC       | 0.1   | 0.1 |
| 105 |                                 |           | 0.1   | 0.1 |

105. The permittee shall not exceed the emission rates set forth in the following table. The permittee shall demonstrate compliance with this condition by complying with Plant Wide Condition #13. [Reg.18.801 and Ark. Code Ann. § 8-4-203 as referenced by Ark. Code Ann. §§ 8-4-304 and 8-4-311]

| SN  | Description                     | Pollutant    | lb/hr | tpy  |
|-----|---------------------------------|--------------|-------|------|
| 104 | Base Liquid Resin Storage Tanks | Formaldehyde | 0.01  | 0.01 |
|     |                                 | Methanol     | 0.02  | 0.06 |
| 105 |                                 | Formaldehyde | 0.01  | 0.01 |
|     |                                 | Methanol     | 0.01  | 0.06 |



SN-148 Non-Bulk Packaging System with Dust Collector

Source Description

The non-bulk packaging system (SN-148) bags the finished product from the spray dry unit. The system is equipped with a dust collector to minimize particulate emissions.

Specific Conditions

106. The permittee shall not exceed the emission rates set forth in the following table. Compliance with this condition is based on the maximum capacity of the equipment for hourly rate and the maximum hours of operation for the annual rate. [Reg.19.501 *et seq.* and 40 C.F.R. § 52 Subpart E]

| SN  | Description                                   | Pollutant        | lb/hr | tpy |
|-----|---|------------------|-------|-----|
| 148 | Non-Bulk Packaging System with Dust Collector | PM <sub>10</sub> | 0.2   | 0.5 |

107. The permittee shall not exceed the emission rates set forth in the following table. The permittee shall demonstrate compliance with this condition by Compliance with this condition is based on the maximum capacity of the equipment for hourly rate and the maximum hours of operation for the annual rate. [Reg.18.801 and Ark. Code Ann. § 8-4-203 as referenced by Ark. Code Ann. §§ 8-4-304 and 8-4-311]

| SN  | Description                                   | Pollutant | lb/hr | tpy |
|-----|---|-----------|-------|-----|
| 148 | Non-Bulk Packaging System with Dust Collector | PM        | 0.2   | 0.5 |

108. Visible emissions may not exceed the limits specified in the following table of this permit as measured by EPA Reference Method 9.

| SN  | Limit | Regulatory Citation  |
|-----|-------|--|
| 148 | 5%    | Reg.18.501 and Ark. Code Ann. § 8-4-203 as referenced by Ark. Code Ann. §§ 8-4-304 and 8-4-311 |

109. Monthly observations of the opacity from SN-05 shall be conducted by a person trained but not necessarily certified in EPA Reference Method 9/a certified EPA Reference Method 9 reader. If visible emissions in excess of the permitted levels are detected, the permittee shall immediately take action to identify the cause of the visible emissions in

Georgia-Pacific Chemicals LLC

Permit #: 1177-AOP-R15

AFIN: 02-00028

excess of the permit limit, implement corrective action, and document that visible emissions did not appear to be in excess of the permitted opacity following the corrective action/perform an EPA Reference Method 9 test to verify emissions are not in excess of the permitted level. The permittee shall maintain records which contain the following items in order to demonstrate compliance with this specific condition. These records shall be updated monthly, kept on site, and made available to Department personnel upon request.

- a. The date and time of the observation.
- b. If visible emissions which appeared to be above the permitted limit were detected.
- c. If visible emissions which appeared to be above the permitted limit were detected, the cause of the exceedance of the opacity limit, the corrective action taken, and if the visible emissions appeared to be below the permitted limit after the corrective action was taken.
- d. The name of the person conducting the opacity observations.

[Reg.18.1004 and Ark. Code Ann. § 8-4-203 as referenced by Ark. Code Ann. §§ 8-4-304 and 8-4-311]

**Formaldehyde Production Plant Sources**  
 SN-10 ICI Formaldehyde Process Oxidizer

Source Description

The ICI Formaldehyde Process Oxidizer (OX-1) controls VOC emissions from the ICI formaldehyde process. The Oxidizer uses natural gas as an auxiliary fuel.

Specific Conditions

110. The permittee shall not exceed the emission rates set forth in the following table. The permittee shall demonstrate compliance with this condition by complying with Plant Wide Condition #13. [Reg.19.501 *et seq.* and 40 C.F.R. § 52 Subpart E]

| SN | Description                       | Pollutant        | lb/hr | tpy |
|----|-----------------------------------|------------------|-------|-----|
| 10 | ICI Formaldehyde Process Oxidizer | PM <sub>10</sub> | 0.1   | 0.1 |
|    |                                   | SO <sub>2</sub>  | 0.1   | 0.1 |
|    |                                   | VOC              | 1.7   | 7.7 |
|    |                                   | CO               | 0.2   | 0.9 |
|    |                                   | NO <sub>x</sub>  | 0.2   | 0.9 |

111. The permittee shall not exceed the emission rates set forth in the following table. The permittee shall demonstrate compliance with this condition by complying with Plant Wide Condition #13. [Reg.18.801 and Ark. Code Ann. § 8-4-203 as referenced by Ark. Code Ann. §§ 8-4-304 and 8-4-311]

| SN | Description                       | Pollutant    | lb/hr | tpy  |
|----|-----------------------------------|--------------|-------|------|
| 10 | ICI Formaldehyde Process Oxidizer | PM           | 0.1   | 0.1  |
|    |                                   | Acetaldehyde | 0.26  | 1.15 |
|    |                                   | Formaldehyde | 0.40  | 1.80 |
|    |                                   | Hexane       | 0.01  | 0.02 |
|    |                                   | Methanol     | 1.30  | 5.90 |
|    |                                   | POM(Total)   | 0.01  | 0.01 |
|    |                                   | Cadmium      | 0.01  | 0.01 |

112. Visible emissions may not exceed the limits specified in the following table of this permit as measured by EPA Reference Method 9. Compliance with this limit shall be demonstrated by combusting natural gas.

| SN | Limit | Regulatory Citation  |
|----|-------|--|
| 10 | 5%    | Reg.18.501 and Ark. Code Ann. § 8-4-203 as referenced by Ark. Code Ann. §§ 8-4-304 and 8-4-311 |

113. The permittee shall reduce inlet emissions of total organic HAP by 98 percent or greater except during periods of planned routine maintenance and Startups, Shutdowns and Malfunctions. Compliance with this condition will be demonstrated by Specific Conditions #114. [Reg.19.304 and 40 C.F.R. Part 63, Subpart G, §63.113(a)2]
114. The permittee shall maintain a daily average oxidizer temperature of 1600EF or higher in the ICI Formaldehyde Manufacturing Process Oxidizer, OX-1, SN-10 whenever the ICI formaldehyde plant is in operation. As allowed in 40 CFR §63.152(f)(5-7), periods of non-operation, SSM events and monitoring system breakdowns, repairs, calibrations, and zero (low level) and high-level adjustments do not count toward the calculation of the “daily average value”. Compliance with this condition will be demonstrated by Specific Conditions #115 and #116. [Reg.19.304 and 40 C.F.R. Part 63, Subpart G, §63.114(e)]
115. The permittee shall install, calibrate, maintain, and operate according to manufacturer’s specifications a temperature monitoring device equipped with a continuous recorder. The temperature monitoring device shall be installed in the firebox of the incinerator or in the ductwork immediately downstream of the firebox in a position before any substantial heat exchange occurs. Compliance with this condition will be demonstrated by Specific Condition #116. [Reg.19.304 and 40 C.F.R. Part 63, Subpart G, §63.118(a)1]
116. The permittee shall maintain continuous records of the temperature in the firebox as monitored by the temperature monitoring device. The permittee shall also maintain daily averages of the firebox temperature. [Reg.19.304 and 40 C.F.R. Part 63, Subpart G, §63.152(a)]
117. The permittee shall submit Periodic Reports no later than March 30<sup>th</sup> and September 30<sup>th</sup> of each year covering the six month period ending thirty days prior to each due date as approved by EPA on August 14, 2012. The periodic SSM report shall include events handled consistent with the SSM Plan. SSM events that are not handled consistent with the SSM Plan shall be reported in accordance with General Provision #8(a). [Reg.19.304 and 40 C.F.R. Part 63, Subpart G]

SN-143 Formaldehyde Production Cooling Tower

Source Description

The facility operates a cooling tower as part of the formaldehyde production operations. The make-up water for the cooling tower will come from the Sparta aquifer from a well onsite. The maximum specific conductance of water sampled from the monitoring well near Huttig, AR (approximately 15 miles from the facility) was 1,170  $\mu\text{S}/\text{cm}$  during testing from 2006 to 2010, which correlates to a TDS value of approximately of 872.5 ppm. To be conservative, a maximum TDS value of 1,047 ppm (872.5 plus a 20% safety factor) was used to estimate maximum particulate matter emissions from the tower. The cooling water is treated with chlorine. The chlorine reacts with organics in the water to form chloroform.

Specific Conditions

118. The permittee shall not exceed the emission rates set forth in the following table. Compliance with this condition is demonstrated by equipment maximum flowrate and maximum TDS value for the Crossett area from USGS. [Reg.19.501 *et seq.* and 40 C.F.R. § 52 Subpart E]

| SN  | Description                           | Pollutant        | lb/hr | tpy |
|-----|---------------------------------------|------------------|-------|-----|
| 143 | Formaldehyde Production Cooling Tower | PM <sub>10</sub> | 0.4   | 1.5 |
|     |                                       | VOC              | 0.1   | 0.2 |

119. The permittee shall not exceed the emission rates set forth in the following table. Compliance with this condition is demonstrated by equipment maximum flowrate and maximum TDS value for the Crossett area from USGS. [Reg.18.801 and Ark. Code Ann. § 8-4-203 as referenced by Ark. Code Ann. §§ 8-4-304 and 8-4-311]

| SN  | Description                           | Pollutant  | lb/hr | tpy  |
|-----|---------------------------------------|------------|-------|------|
| 143 | Formaldehyde Production Cooling Tower | PM         | 0.4   | 1.5  |
|     |                                       | Chloroform | 0.04  | 0.15 |
|     |                                       | Chlorine   | 0.07  | 0.29 |

Georgia-Pacific Chemicals LLC

Permit #: 1177-AOP-R15

AFIN: 02-00028

120. Visible emissions may not exceed the limits specified in the following table of this permit as measured by EPA Reference Method 9. Compliance with the opacity limit for this cooling tower is demonstrated by the equipment maximum flowrate and maximum TDS value for the Crossett area from USGS.

| SN  | Limit | Regulatory Citation                            |
|-----|-------|--|
| 143 | 20%   | Reg.19.503 and 40 C.F.R.<br>Part 52, Subpart E |

**Tall Oil Fractionation Plant Sources**  
 SN-01 Hot Oil Heater for TOFRAC Plant

Source Description

The Hot Oil Heater for the TOFRAC Plant, HOH-1 provides utility heat in the reboilers of the Tall Oil Fractionation Plant. The hot oil heater is fueled by natural gas and has a heat input capacity of 43.6 MM Btu/hr.

Specific Conditions

121. The permittee shall not exceed the emission rates set forth in the following table. The permittee shall demonstrate compliance with this condition by complying with Plant Wide Condition #13. [Reg.19.501 *et seq.* and 40 C.F.R. § 52 Subpart E]

| SN | Description                     | Pollutant        | lb/hr | tpy  |
|----|---------------------------------|------------------|-------|------|
| 01 | Hot Oil Heater for TOFRAC Plant | PM <sub>10</sub> | 0.4   | 1.5  |
|    |                                 | SO <sub>2</sub>  | 0.1   | 0.2  |
|    |                                 | VOC              | 0.3   | 1.1  |
|    |                                 | CO               | 3.7   | 16.1 |
|    |                                 | NO <sub>x</sub>  | 4.4   | 19.1 |

122. The permittee shall not exceed the emission rates set forth in the following table. The permittee shall demonstrate compliance with this condition by complying with Plant Wide Condition #13. [Reg.18.801 and Ark. Code Ann. § 8-4-203 as referenced by Ark. Code Ann. §§ 8-4-304 and 8-4-311]

| SN | Description                     | Pollutant    | lb/hr | tpy  |
|----|---------------------------------|--------------|-------|------|
| 01 | Hot Oil Heater for TOFRAC Plant | PM           | 0.4   | 1.5  |
|    |                                 | Formaldehyde | 0.01  | 0.02 |
|    |                                 | Hexane       | 0.08  | 0.35 |
|    |                                 | POM(Total)   | 0.01  | 0.01 |
|    |                                 | Cadmium      | 0.01  | 0.01 |

Georgia-Pacific Chemicals LLC

Permit #: 1177-AOP-R15

AFIN: 02-00028

123. Visible emissions may not exceed the limits specified in the following table of this permit as measured by EPA Reference Method 9. Compliance with this limit shall be demonstrated by combusting natural gas.

| SN | Limit | Regulatory Citation  |
|----|-------|--|
| 01 | 5%    | Reg.18.501 and Ark. Code Ann. § 8-4-203 as referenced by Ark. Code Ann. §§ 8-4-304 and 8-4-311 |



SN-14, SN-15, SN-16, SN-20, SN-24, SN-32, SN-33, SN-34, SN-35, SN-36, SN-37, SN-40, SN-42, SN-43, SN-44, SN-45, SN-46, SN-47, SN-48, SN-49, SN-50, SN-51, SN-53, SN-54, SN-55, SN-56, SN-57, SN-58, SN-107, SN-108, SN-109, SN-110, SN-111, SN-113, and SN-119  
Tall Oil Fractionation Plant Storage Tanks

Source Description

The Crude Tall Oil Storage Tanks, (SN-16, SN-20, and SN-40) tank numbers T-40, T-41, and T-42, store crude tall oil for use as a raw material for the tall oil fractionation plant. Each tank has a storage capacity of 835,000 gallons. Crude tall oil is received at the facility from railcars and tank trucks and is unloaded into Debrine Storage Tanks. The Debrine Storage Tanks separate the brine layer from the crude tall oil. The debrined tall oil is then sent from the Debrine Storage Tanks to the Crude Tall Oil Storage Tanks.

Pitch Storage Tanks, (SN-32, SN-43, and SN-44) tank numbers T-47, T-24, and T-36, store the pitch product of the depitching unit of the tall oil fractionation plant. The pitch from the tanks is sent off-site by rail car and tank truck and may also be used as a fuel for the Complex Boiler, SN-05.

The Heads Storage Tanks, (SN-33, SN-34, SN-45, and SN-47) tanks numbers T-20, T-31, T-19, and T-29, store the overhead product of the primary rosin column. This product is shipped off-site by tank truck and rail car or is sent on for further processing in the Tall Oil Fractionation Plant.

The Tall Oil Fatty Acid Storage Tanks (SN-14, SN-15, SN-46, SN-47, SN-48, SN-49, SN-57, and SN-58) tank numbers T-17, 18, 22, 43, 44, 46, and 48 store products from the fatty acid distillation column. The tall oil fatty acid is shipped off-site by rail car and truck.

The Tall Oil Rosin Storage Tanks, (SN-24, SN-35, SN-53, SN-54, SN-55, and SN-56) tank numbers T-21, T-49, T-8, T-9, T-10, and T-12, store the rosin product from the primary and secondary rosin columns. The rosin storage tanks store the rosin until it can be shipped off-site by tank truck and rail car or sent to the rosin drumming tank, tall oil blend tanks, size cooler, or derivatives reactor.

The 502 Bottoms Storage Tanks, (SN-36 and SN-50) tank number T-26 and T-25, store the bottoms product from the fatty acid distillation column of the Tall Oil Fractionation Plant. The 502 bottoms product is shipped off-site by rail car or tank truck, and is used in formulated products.

The Distilled Tall Oil Storage Tank, (SN-51) T-23 stores the distilled tall oil product from the fatty acid distillation column. The distilled tall oil is shipped off-site by rail car or tank truck and is used in formulated products.

The Modified Tall Oil Storage Tank, (SN-42) T-6 stores modified tall oil product produced by the rosin size process. The modified tall oil is shipped off-site by rail car or tank truck. Although the material stored in the Modified Tall Oil Rosin Storage Tank is not believed to contain any HAP containing materials, the potential exists for trace residual quantities of maleic anhydride to be present in the finished product. Due to the potential for the HAP being present, the Modified Tall Oil Rosin Storage Tank is regulated as a Group 2 Storage Tank, with no applicable control requirements under the Miscellaneous Organic NESHAP, 40 CFR 63, Subpart FFFF.

The Tall Oil Blend Tanks (SN-107, SN-108, SN-109, and SN-110) are tank numbers T-27, T-28, T-30, and T-32.

The Rosin Drumming Storage Tank (SN-37) T-50 stores rosin product from the tall oil rosin storage tanks, which is being sent to rosin drumming for packaging.

The Wet Tall Oil Storage Tanks, (SN-111 and SN-113) tank numbers T-56 and 57, store the product from the CTO cooker until the product can be sold or pumped to storage.

The Crude Tall Oil Storage Tank (SN-119) T-59 store Crude Tall Oil (CTO) for usage at the TOFRAC plant.

#### Specific Conditions

124. The permittee shall not exceed the emission rates set forth in the following table. The permittee shall demonstrate compliance with this condition by complying with Plant Wide Condition #13. [Reg.19.501 *et seq.* and 40 C.F.R. § 52 Subpart E]

| SN   | Description                                | Pollutant | lb/hr | tpy |
|--|--|-----------|-------|-----|
| SN-14, SN-15, SN-16, SN-20, SN-24, SN-32, SN-33, SN-34, SN-35, SN-36, SN-37, SN-40, SN-42, SN-43, SN-44, SN-45, SN-46, SN-47, SN-48, SN-49, SN-50, SN-51, SN-53, SN-54, SN-55, SN-56, SN-57, SN-58, SN-107, SN-108, SN-109, SN-110, SN-111, SN-113, and SN-119 | Tall Oil Fractionation Plant Storage Tanks | VOC       | 67.8  | 8.7 |

### **Rosin Size Plant Sources**

SN-26, SN-41, SN-52, SN-118, SN-120, SN-121, SN-122, SN-123, and SN-126  
Rosin Size Plant Storage Tanks

#### Source Description

The Deaerator Material Storage Tanks, (SN-26 and SN-118) T-61 and T-62 store deaerator material currently until shipped off site.

ESD Storage Tanks (SN-120, SN-121, SN-122, and SN-52): Molten maleic anhydride (MMA) from Tank 76 (SN-147) is used in the production of a modified tall oil in the C-1 Cooker. From the C-1 Cooker, modified tall oil (XTOL<sup>®</sup> 6920) is pumped to Tank T-14 (SN-122) for storage. Modified tall oil from tank 14 and amidoamine, received from offsite and stored in Tank T-11 (SN-120), are blended in tank 13 (SN-121) to make an emulsifier. This emulsifier is pumped from Tank T-13 (SN-121) to Tank 7 (SN-52) and neutralized to an emulsifier soap solution. From Tank T-7, the emulsifier soap solution is transferred to one of two storage tanks, (SD-1 or SD-2) at the spray dry facility.

The storage tank requirements specified under 40 CFR Part 63.2470 do not apply to T-22, T-13, T-14, and T-7 because the tanks only contain OHAPS as “impurities” and do not meet the definition of regulated storage tanks in 40 CFR 63.2550.

The Dispro Rosin Storage Tank, (SN-41) T-5, stores the Dispro Rosin product from the rosin size plant reactor until it can be shipped off-site by railcar or truck. Although the material stored in the Dispro Rosin Storage Tank is not believed to contain any HAP containing materials, the potential exists for trace residual quantities of maleic anhydride to be present in the finished product. Due to the potential presence of the HAP, the Dispro Rosin Storage tank is regulated as a Group 2 Storage Tank, with no applicable control requirement under the Miscellaneous Organic NESHAP, 40 CFR 63, Subpart FFFF.

Hot Melt Holding Tanks, (SN-123 and SN-126) T-51 and T-75, hold the derivatives plant product until it is sent to the product bagging system or shipped off-site. The Hot Melt Holding Tank uses steam to keep the product at the desired temperature. Although the material stored in the hot melt tanks is not believed to contain any HAP containing material, the potential exists for trace residual quantities of maleic anhydride to be present in the finished product. Due to the potential presence of the HAP, the Hot Melt Holding Tanks are regulated as Group 2 Storage Tanks, with no applicable control requirements under the Miscellaneous Organic NESHAP, 40 CFR 63, Subpart FFFF.

Georgia-Pacific Chemicals LLC  
Permit #: 1177-AOP-R15  
AFIN: 02-00028

Specific Conditions

125. The permittee shall not exceed the emission rates set forth in the following table. The permittee shall demonstrate compliance with this condition by complying with Plant Wide Condition #13. [Reg.19.501 *et seq.* and 40 C.F.R. § 52 Subpart E]

| SN  | Description                                | Pollutant | lb/hr | tpy |
|---|--|-----------|-------|-----|
| SN-26, SN-41, SN-52, SN-118, SN-120, SN-121, SN-122, SN-123, and SN-126 | Rosin Size Plant Storage and Process Tanks | VOC       | 31.0  | 1.0 |

SN-147 Molten Maleic Anhydride Tank and Scrubber

Source Description

Molten Maleic Anhydride (MMA) is an additive used in the production of a modified tall oil product. The 12,500 gallon tank is controlled by a venture scrubber. Although controls are not required, GP Chemicals has elected to add a scrubber to control working losses. The scrubber operates when unloading MMA and whenever the tank pressure is 4 psig or higher. Because the Miscellaneous Chemical Manufacturing Processing Unit (MCPU) is an existing source, the threshold vapor pressure for a MON Group 1 tank is 1.0 psi. The vapor pressure of MMA at storage temperature is <1.0 psi. Therefore, this tank is a Group 2 tank. The potential uncontrolled VOC emissions from this source are less than 100 tons per year. Therefore, the Compliance Assurance Monitoring (CAM) requirements do not apply.

Specific Conditions

126. The permittee shall not exceed the emission rates set forth in the following table. Compliance with this condition is based on the maximum capacity of the equipment for hourly rate and the maximum hours of operation (8,760 hr/yr) for the annual rate. [Reg.19.501 *et seq.* and 40 C.F.R. § 52 Subpart E]

| SN  | Description                               | Pollutant | lb/hr | tpy |
|-----|---|-----------|-------|-----|
| 147 | Molten Maleic Anhydride Tank and Scrubber | VOC       | 0.1   | 0.3 |

127. The permittee shall not exceed the emission rates set forth in the following table. Compliance with this condition is based on the maximum capacity of the equipment for hourly rate and the maximum hours of operation (8,760 hr/yr) for the annual rate. [Reg.18.801 and Ark. Code Ann. § 8-4-203 as referenced by Ark. Code Ann. §§ 8-4-304 and 8-4-311]

| SN  | Description                               | Pollutant        | lb/hr | tpy  |
|-----|---|------------------|-------|------|
| 147 | Molten Maleic Anhydride Tank and Scrubber | Maleic Anhydride | 0.06  | 0.26 |

**Derivatives Plant Sources**  
 SN-06 Derivatives Plant Solids Addition Baghouse

Source Description

The Derivatives Plant Solids Addition Baghouse, BH-5, is used to control dust emissions from the low and high volume storage tanks, T-19 and T-80, which are used as raw materials in the rosin derivatives plant. The collected dust is sent offsite for disposal.

Specific Conditions

128. The permittee shall not exceed the emission rates set forth in the following table. The permittee shall demonstrate compliance with this condition by complying with Plant Wide Condition #13. [Reg.19.501 *et seq.* and 40 C.F.R. § 52 Subpart E]

| SN | Description                                | Pollutant        | lb/hr | tpy |
|----|--|------------------|-------|-----|
| 06 | Derivatives Plant Solids Addition Baghouse | PM <sub>10</sub> | 0.5   | 1.8 |
|    |  | VOC              | 0.1   | 0.1 |

129. The permittee shall not exceed the emission rates set forth in the following table. The permittee shall demonstrate compliance with this condition by complying with Plant Wide Condition #13. [Reg.18.801 and Ark. Code Ann. § 8-4-203 as referenced by Ark. Code Ann. §§ 8-4-304 and 8-4-311]

| SN | Description                                | Pollutant        | lb/hr | tpy |
|----|--|------------------|-------|-----|
| 06 | Derivatives Plant Solids Addition Baghouse | PM               | 0.5   | 1.8 |
|    |  | Formaldehyde     | 0.1   | 0.1 |
|    |  | Maleic Anhydride | 0.1   | 0.2 |

130. Visible emissions may not exceed the limits specified in the following table of this permit as measured by EPA Reference Method 9. Compliance with this limit shall be demonstrated by Plant Wide Condition #15.

| SN | Limit | Regulatory Citation  |
|----|-------|--|
| 06 | 5%    | Reg.18.501 and Ark. Code Ann. § 8-4-203 as referenced by Ark. Code Ann. §§ 8-4-304 and 8-4-311 |

Georgia-Pacific Chemicals LLC

Permit #: 1177-AOP-R15

AFIN: 02-00028

131. The Derivatives Plant Solids Addition Baghouse (SN-06) is subject to Compliance Assurance Monitoring (CAM) and shall comply with all applicable CAM provisions including: [Reg.19.703, 40 C.F.R. Part 52 Subpart E, and Part §64.6]
- a. The permittee shall perform a visible inspection of the baghouse exhaust once a week to check that the baghouse is in good working order. The permittee shall maintain records which document the baghouse inspection date and results. The records shall be updated on a weekly basis. These records shall be kept on site and provided to Department personnel upon request and may be used by the Department for enforcement purposes.
  - b. The presence of any visible emissions from the operating baghouse shall be considered an indicator that a bag rupture or leak is occurring and that corrective action is necessary.
  - c. Upon observing visible emissions, an operator will check the pressure drop, pulsing system, and baghouse structure as appropriate. If these checks do not allow the operator to correct the visible emissions, the maintenance department will be notified immediately. A complete maintenance inspection will be initiated within 12 hours of the observation and any necessary repairs completed within 12 hours or the source shall be taken out of service until the maintenance inspection and any necessary repairs can be made. Records of corrective action shall be kept onsite, updated daily, and made available to Department personnel upon request.

SN-07 Derivatives Plant Hot Oil Heater

Source Description

The Derivatives Plant Hot Oil Heater, HOH-2, is a 5.2 MMBtu/hr natural gas fired heater which provides hot oil for the rosin derivatives plant.

Specific Conditions

132. The permittee shall not exceed the emission rates set forth in the following table. The permittee shall demonstrate compliance with this condition by complying with Plant Wide Condition #13. [Reg.19.501 *et seq.* and 40 C.F.R. § 52 Subpart E]

| SN | Description                      | Pollutant        | lb/hr | tpy |
|----|----------------------------------|------------------|-------|-----|
| 07 | Derivatives Plant Hot Oil Heater | PM <sub>10</sub> | 0.1   | 0.2 |
|    |                                  | SO <sub>2</sub>  | 0.1   | 0.1 |
|    |                                  | VOC              | 0.1   | 0.2 |
|    |                                  | CO               | 0.5   | 2.0 |
|    |                                  | NO <sub>x</sub>  | 0.6   | 2.3 |

133. The permittee shall not exceed the emission rates set forth in the following table. The permittee shall demonstrate compliance with this condition by complying with Plant Wide Condition #13. [Reg.18.801 and Ark. Code Ann. § 8-4-203 as referenced by Ark. Code Ann. §§ 8-4-304 and 8-4-311]

| SN | Description                      | Pollutant    | lb/hr | tpy  |
|----|----------------------------------|--------------|-------|------|
| 07 | Derivatives Plant Hot Oil Heater | PM           | 0.1   | 0.2  |
|    |                                  | Formaldehyde | 0.01  | 0.01 |
|    |                                  | Hexane       | 0.01  | 0.05 |
|    |                                  | POM (Total)  | 0.01  | 0.01 |
|    |                                  | Cadmium      | 0.01  | 0.01 |



Georgia-Pacific Chemicals LLC

Permit #: 1177-AOP-R15

AFIN: 02-00028

134. Visible emissions may not exceed the limits specified in the following table of this permit as measured by EPA Reference Method 9. Compliance with this limit shall be demonstrated by combusting natural gas.

| SN | Limit | Regulatory Citation  |
|----|-------|--|
| 06 | 5%    | Reg.18.501 and Ark. Code Ann. § 8-4-203 as referenced by Ark. Code Ann. §§ 8-4-304 and 8-4-311 |

SN-09 Derivatives Plant-Flaker Bagging Station

Source Description

The dust emissions from the Derivatives Plant-Flaker Bagging Station are controlled by the baghouse BH-6, SN-09. The captured dust is recycled, sent as a product off-site, or sent to a landfill for disposal.

Specific Conditions

135. The permittee shall not exceed the emission rates set forth in the following table. The permittee shall demonstrate compliance with this condition by complying with Plant Wide Condition #13. [Reg.19.501 *et seq.* and 40 C.F.R. § 52 Subpart E]

| SN | Description                              | Pollutant        | lb/hr | tpy |
|----|--|------------------|-------|-----|
| 09 | Derivatives Plant-Flaker Bagging Station | PM <sub>10</sub> | 0.8   | 3.2 |

136. The permittee shall not exceed the emission rates set forth in the following table. The permittee shall demonstrate compliance with this condition by complying with Plant Wide Condition #13. [Reg.18.801 and Ark. Code Ann. § 8-4-203 as referenced by Ark. Code Ann. §§ 8-4-304 and 8-4-311]

| SN | Description                              | Pollutant | lb/hr | tpy |
|----|--|-----------|-------|-----|
| 09 | Derivatives Plant-Flaker Bagging Station | PM        | 0.8   | 3.2 |

137. Visible emissions may not exceed the limits specified in the following table of this permit as measured by EPA Reference Method 9. Compliance with this limit shall be demonstrated by Plant Wide Condition #15.

| SN | Limit | Regulatory Citation  |
|----|-------|--|
| 09 | 5%    | Reg.18.501 and Ark. Code Ann. § 8-4-203 as referenced by Ark. Code Ann. §§ 8-4-304 and 8-4-311 |

Georgia-Pacific Chemicals LLC

Permit #: 1177-AOP-R15

AFIN: 02-00028

138. The Derivatives Plant-Flaker Bagging Station (SN-09) is subject to Compliance Assurance Monitoring (CAM) and shall comply with all applicable CAM provisions including: [Reg.19.703, 40 C.F.R. Part 52 Subpart E, and Part §64.6]
- a. The permittee shall perform a visible inspection of the baghouse exhaust once a week to check that the baghouse is operating in good working order. The permittee shall maintain records which document the baghouse inspection date and results. The records shall be updated on a weekly basis. These records shall be kept on site and provided to Department personnel upon request and may be used by the Department for enforcement purposes.
  - b. The presence of any visible emissions from the operating baghouse shall be considered an indicator that a bag rupture or leak is occurring and that corrective action is necessary.
  - c. Upon observing visible emissions, an operator will check the pressure drop, pulsing system, and baghouse structure as appropriate. If these checks do not allow the operator to correct the visible emissions, the maintenance department will be notified immediately. A complete maintenance inspection will be initiated within 12 hours of the observation and any necessary repairs completed within 12 hours or the source shall be taken out of service until the maintenance inspection and any necessary repairs can be made. Records of corrective action shall be kept onsite, updated daily, and made available to Department personnel upon request.

SN-144 Derivatives Plant Cooling Tower

Source Description

The facility operates a cooling tower as part of the derivatives plant operations. The make-up water for the cooling tower will come from the Sparta aquifer from a well onsite. The maximum specific conductance of water sampled from the monitoring well near Huttig, AR (approximately 15 miles from the facility) was 1,170  $\mu\text{S}/\text{cm}$  during testing from 2006 to 2010, which correlates to a TDS value of approximately of 872.5 ppm. To be conservative, a maximum TDS value of 1,047 ppm (872.5 plus a 20% safety factor) was used to estimate maximum particulate matter emissions from the tower. The cooling water is treated with chlorine. The chlorine reacts with organics in the water to form chloroform.

Specific Conditions

139. The permittee shall not exceed the emission rates set forth in the following table. Compliance with this condition is demonstrated by the equipment maximum flowrate and maximum TDS value for the Crossett area from USGS. [Reg.19.501 *et seq.* and 40 C.F.R. § 52 Subpart E]

| SN  | Description                     | Pollutant        | lb/hr | tpy |
|-----|---------------------------------|------------------|-------|-----|
| 144 | Derivatives Plant Cooling Tower | PM <sub>10</sub> | 0.6   | 2.7 |
|     |                                 | VOC              | 0.1   | 0.3 |

140. The permittee shall not exceed the emission rates set forth in the following table. The permittee shall demonstrate compliance with this condition by . [Reg.18.801 and Ark. Code Ann. § 8-4-203 as referenced by Ark. Code Ann. §§ 8-4-304 and 8-4-311]

| SN  | Description                     | Pollutant  | lb/hr | tpy  |
|-----|---------------------------------|------------|-------|------|
| 144 | Derivatives Plant Cooling Tower | PM         | 0.6   | 2.7  |
|     |                                 | Chloroform | 0.06  | 0.27 |
|     |                                 | Chlorine   | 0.08  | 0.33 |

Georgia-Pacific Chemicals LLC

Permit #: 1177-AOP-R15

AFIN: 02-00028

141. Visible emissions may not exceed the limits specified in the following table of this permit as measured by EPA Reference Method 9. Compliance with the opacity limit for this cooling tower is demonstrated by the equipment maximum flowrate and maximum TDS value for the Crossett area from USGS.

| SN  | Limit | Regulatory Citation                            |
|-----|-------|--|
| 144 | 20%   | Reg.19.503 and 40 C.F.R.<br>Part 52, Subpart E |

SN-134 Wastewater Collection & Transfer System

Source Description

The chemical facility has an extensive system of pipes, impoundments, trenches, sumps, and containment structures used to convey and manage wastewater produced by various processes and storm water that falls in process areas. These streams flow from the point of generation through a variety of intermediate structures to the chemical plant's wastewater collection pond. The water is then pumped from the collection pond to the adjacent papermill wastewater treatment system for treatment and discharge. The chemical plant's combined wastewater stream includes maintenance wastewater from the HON process and a variety of process and maintenance wastewater from the Resin MACT and MON regulated process units including but not limited to: Reactors, condensate, filter cleanings, scrubber discharges, blow downs, distillates, wash waters, and other miscellaneous wastewater streams. Because most of these streams contain low concentrations of organic materials and ammonia, a small percentage is emitted to atmosphere as fugitive emissions. The predominant source of the wastewater HAP loading and wastewater fugitive come from the Resin MACT "affected sources". As such, this wastewater collection and transfer system meets the Resin MACT definition of a Waste Management Unit (WMU) and is therefore regulated as part of the Resin MACT APPU.

Specific Conditions

142. The permittee shall not exceed the emission rates set forth in the following table. The permittee shall demonstrate compliance with this condition by complying with Specific Condition #144. [Reg.19.501 *et seq.* and 40 C.F.R. § 52 Subpart E]

| SN  | Description                             | Pollutant | lb/hr | tpy |
|-----|---|-----------|-------|-----|
| 134 | Wastewater Collection & Transfer System | VOC       | 6.6   | 4.1 |

143. The permittee shall not exceed the emission rates set forth in the following table. The permittee shall demonstrate compliance with this condition by complying with Specific Condition #144. [Reg.18.801 and Ark. Code Ann. § 8-4-203 as referenced by Ark. Code Ann. §§ 8-4-304 and 8-4-311]

| SN  | Description                             | Pollutant    | lb/hr | tpy    |
|-----|---|--------------|-------|--------|
| 134 | Wastewater Collection & Transfer System | Acetaldehyde | 0.17  | 0.70   |
|     |   | Ammonia      | 0.03  | 0.11   |
|     |   | Formaldehyde | 0.41  | 0.57   |
|     |   | Methanol     | 5.88  | 1.59   |
|     |   | Phenol       | 0.004 | 0.0002 |

Georgia-Pacific Chemicals LLC

Permit #: 1177-AOP-R15

AFIN: 02-00028

144. The permittee shall maintain the following information on each Group 2 process wastewater stream subject to the requirements of 40 C.F.R. 63, Subpart FFFF and Subpart G in a readily accessible location:
- a. Process unit identification and description of the process unit;
  - b. Stream identification code;
  - c. Concentrations in parts per million, by weight of any applicable Table 8 and Table 9 compounds in the stream;
  - d. Documentation of the methodology used to determine the concentrations; and,
  - e. Flow rate in liters per minute.

These required elements are listed in the MON Notification of Compliance Status on file with the ADEQ. [40 C.F.R §63.147(b)(8)]

Georgia-Pacific Chemicals LLC  
Permit #: 1177-AOP-R15  
AFIN: 02-00028

## **SECTION V: COMPLIANCE PLAN AND SCHEDULE**

Georgia-Pacific Chemicals LLC will continue to operate in compliance with those identified regulatory provisions. The facility will examine and analyze future regulations that may apply and determine their applicability with any necessary action taken on a timely basis.



## SECTION VI: PLANTWIDE CONDITIONS

1. The permittee shall notify the Director in writing within thirty (30) days after commencing construction, completing construction, first placing the equipment and/or facility in operation, and reaching the equipment and/or facility target production rate. [Reg.19.704, 40 C.F.R. § 52 Subpart E, and Ark. Code Ann. § 8-4-203 as referenced by Ark. Code Ann. §§ 8-4-304 and 8-4-311]
2. If the permittee fails to start construction within eighteen months or suspends construction for eighteen months or more, the Director may cancel all or part of this permit. [Reg.19.410(B) and 40 C.F.R. § 52 Subpart E]
3. The permittee must test any equipment scheduled for testing, unless otherwise stated in the Specific Conditions of this permit or by any federally regulated requirements, within the following time frames: (1) new equipment or newly modified equipment within sixty (60) days of achieving the maximum production rate, but no later than 180 days after initial start up of the permitted source or (2) operating equipment according to the time frames set forth by the Department or within 180 days of permit issuance if no date is specified. The permittee must notify the Department of the scheduled date of compliance testing at least fifteen (15) business days in advance of such test. The permittee shall submit the compliance test results to the Department within thirty (30) calendar days after completing the testing. [Reg.19.702 and/or Reg.18.1002 and Ark. Code Ann. § 8-4-203 as referenced by Ark. Code Ann. §§ 8-4-304 and 8-4-311]
4. The permittee must provide:
  - a. Sampling ports adequate for applicable test methods;
  - b. Safe sampling platforms;
  - c. Safe access to sampling platforms; and
  - d. Utilities for sampling and testing equipment.

[Reg.19.702 and/or Reg.18.1002 and Ark. Code Ann. § 8-4-203 as referenced by Ark. Code Ann. §§ 8-4-304 and 8-4-311]

5. The permittee must operate the equipment, control apparatus and emission monitoring equipment within the design limitations. The permittee shall maintain the equipment in good condition at all times. [Reg.19.303 and Ark. Code Ann. § 8-4-203 as referenced by Ark. Code Ann. §§ 8-4-304 and 8-4-311]
6. This permit subsumes and incorporates all previously issued air permits for this facility. [Reg. 26 and Ark. Code Ann. § 8-4-203 as referenced by Ark. Code Ann. §§ 8-4-304 and 8-4-311]

Title VI Provisions

7. The permittee must comply with the standards for labeling of products using ozone-depleting substances. [40 C.F.R. § 82 Subpart E]
  - a. All containers containing a class I or class II substance stored or transported, all products containing a class I substance, and all products directly manufactured with a class I substance must bear the required warning statement if it is being introduced to interstate commerce pursuant to § 82.106.
  - b. The placement of the required warning statement must comply with the requirements pursuant to § 82.108.
  - c. The form of the label bearing the required warning must comply with the requirements pursuant to § 82.110.
  - d. No person may modify, remove, or interfere with the required warning statement except as described in § 82.112.
8. The permittee must comply with the standards for recycling and emissions reduction, except as provided for MVACs in Subpart B. [40 C.F.R. § 82 Subpart F]
  - a. Persons opening appliances for maintenance, service, repair, or disposal must comply with the required practices pursuant to § 82.156.
  - b. Equipment used during the maintenance, service, repair, or disposal of appliances must comply with the standards for recycling and recovery equipment pursuant to § 82.158.
  - c. Persons performing maintenance, service repair, or disposal of appliances must be certified by an approved technician certification program pursuant to § 82.161.
  - d. Persons disposing of small appliances, MVACs, and MVAC like appliances must comply with record keeping requirements pursuant to § 82.166. (“MVAC like appliance” as defined at § 82.152)
  - e. Persons owning commercial or industrial process refrigeration equipment must comply with leak repair requirements pursuant to § 82.156.
  - f. Owners/operators of appliances normally containing 50 or more pounds of refrigerant must keep records of refrigerant purchased and added to such appliances pursuant to § 82.166.
9. If the permittee manufactures, transforms, destroys, imports, or exports a class I or class II substance, the permittee is subject to all requirements as specified in 40 C.F.R. § 82 Subpart A, Production and Consumption Controls.
10. If the permittee performs a service on motor (fleet) vehicles when this service involves ozone depleting substance refrigerant (or regulated substitute substance) in the motor vehicle air conditioner (MVAC), the permittee is subject to all the applicable requirements as specified in 40 C.F.R. § 82 Subpart B, Servicing of Motor Vehicle Air Conditioners.

The term “motor vehicle” as used in Subpart B does not include a vehicle in which final assembly of the vehicle has not been completed. The term “MVAC” as used in Subpart B does not include the air tight sealed refrigeration system used as refrigerated cargo, or the system used on passenger buses using HCFC 22 refrigerant.

11. The permittee can switch from any ozone depleting substance to any alternative listed in the Significant New Alternatives Program (SNAP) promulgated pursuant to 40 C.F.R. § 82 Subpart G.

Permit Shield

12. Compliance with the conditions of this permit shall be deemed compliance with all applicable requirements, as of the date of permit issuance, included in and specifically identified in the following table of this condition. The permit specifically identifies the following as applicable requirements based upon the information submitted by the permittee in the Title V application dated August 6, 2012 and minor sources applications dated October 17, 2011, November 11, 2011, December 16, 2011, October 16, 2013, August 8, 2014, September 24, 2014, and January 23, 2015.

Applicable Regulations

| Source No.                                     | Regulation  | Description  |
|--|---|--|
| ICI Formaldehyde Process Line                  | 40 C.F.R. Part 63, Subpart F<br>40 C.F.R. Part 63, Subpart G<br>40 C.F.R. Part 63, Subpart H                                      | National Emission Standards for Organic Hazardous Air Pollutants From the Synthetic Organic Chemical Manufacturing Industry. (HON Rule)  |
| Wet Strength Resin Process Line                | 40 C.F.R. Part 63, Subpart W<br>40 C.F.R. Part 63, Subpart H  | National Emission Standards for Hazardous Air Pollutants for the Epoxy Resins Production and Non-Nylon Polyamides Production   |
| Amino/Phenolic Resin Process Lines             | 40 C.F.R. Part 63, Subpart OOO<br>40 C.F.R. Part 63, Subpart SS<br>40 C.F.R. Part 63, Subpart UU<br>40 C.F.R. Part 63, Subpart WW | National Emission Standards for Hazardous Air Pollutants for Amino/Phenolic Resins Production.<br>Subpart SS, UU, and WW are standards incorporated by reference from OOO. These subparts are standards for control devices, leak detection, and storage tanks |
| SN-130   | 40 C.F.R. Part 60, Subpart Dc   | Standards of Performance for Small Industrial-Commercial-Institutional Steam Generating Units  |
| Tanks listed in Plantwide Conditions 16 and 17 | 40 C.F.R. Part 60, Subpart Kb   | Standards of Performance for Volatile Organic Liquid Storage Vessels   |

| Source No. | Regulation                      | Description   |
|------------|---------------------------------|---|
| Facility   | Arkansas Regulation 19          | Compilation of Regulations of the Arkansas State Implementation Plan for Air Pollution Control                    |
| Facility   | Arkansas Regulation 26          | Regulations of the Arkansas Operating Air Permit Program  |
| Facility   | Ark. Code Ann. §8-3-103         | Hydrogen Sulfide Emissions  |
| Facility   | 40 C.F.R. Part 61, Subpart FFFF | National Emission Standards for Hazardous Air Pollutants for Miscellaneous Organic NESHAPS (MON)                  |
| Facility   | 40 C.F.R. Part 61, Subpart FF   | National Emission Standards for Benzene Waste Operations  |
| Facility   | 40 C.F.R. 63, SUBPART ZZZZ      | National Emission Standards for Hazardous Air Pollutants for Stationary Reciprocating Internal Combustion Engines |

The permit specifically identifies the following as inapplicable based upon information submitted by the permittee in an application dated August 6, 2012 and minor sources applications dated October 17, 2011, November 11, 2011, December 16, 2011, October 16, 2013, August 8, 2014, September 24, 2014, and January 23, 2015.

Inapplicable Regulations

| Source No.                       | Regulation                    | Description  |
|----------------------------------|-------------------------------|--|
| SN-05 Complex Boiler             | 40 C.F.R. Part 60 Subpart Db  | Standards of Performance for Industrial-Commercial-Institutional Steam Generating Units  |
| Formaldehyde production facility | 40 C.F.R. Part 60 Subpart VV  | Standards of Performance for Equipment Leaks in the Synthetic Organic Chemical Manufacturing Industry  |
| Facility                         | 40 C.F.R. Part 60 Subpart DDD | Standards of Performance for Volatile Organic Compound Emissions from the Polymer Manufacturing Industry   |
| Formaldehyde production facility | 40 C.F.R. Part 60 Subpart III | Standards of Performance for Volatile Organic Compound Emissions from the Synthetic Organic Chemical Manufacturing Industry Air Oxidation Process Unit Processes |
| Formaldehyde production facility | 40 C.F.R. Part 60 Subpart NNN | Standards of Performance for Volatile Organic Compound Emissions from the Synthetic Organic Chemical Manufacturing Industry Distillation Operations              |

| Source No.                       | Regulation                    | Description   |
|----------------------------------|-------------------------------|---|
| Formaldehyde production facility | 40 C.F.R. Part 60 Subpart RRR | Standards of Performance for Volatile Organic Compound Emissions from the Synthetic Organic Chemical Manufacturing Industry Reactor Processes |

13. The permittee shall not exceed production or process limits specified in the following table for each of the facility's production plants in any consecutive 12 month period. Compliance with this condition will be demonstrated by Plantwide Conditions #14 and #28. [Reg.19.705, Ark. Code Ann. § 8-4-203 as referenced by Ark. Code Ann. §§ 8-4-304 and 8-4-311, and 40 C.F.R. § 70.6]

| Plant                                   | Consecutive 12 Month Limit  |
|---|---|
| Rosin Size Plant and Deaerator Material | 70,000,000 pounds (7,954,545 gallons) of Rosin Size Material and Deaerator produced   |
| Rosin Derivatives Plant                 | 50,000,000 pounds of Rosin Derivatives produced   |
| Spray Dry Resin                         | 25,000,000 pounds of Spray Dry Powdered Resin produced  |
| Formaldehyde Production Plant           | 212,000,000 pounds of Formaldehyde Produced (50% basis) of which 65,600,000 pounds can be Urea-Formaldehyde Concentrate (50% basis) |
| Tall Oil Fractionation Plant            | 280,000,000 pounds (35,000,000 gallons) of Crude Tall Oil processed   |
|   | 150 Batches of LYTOR® 105K  |
| Liquid Resin Plant                      | 845,000,000 pounds of liquid resin produced   |

14. The permittee shall maintain monthly records of the amounts of product produced or the amount of materials processed as per the limits established in Plantwide Condition #13 at each production plant at the facility. These records shall be updated by the 10<sup>th</sup> day of the month following the month to which the records pertain. These records shall be kept on sight and made available to Department personnel upon request. An annual total and each individual month's data shall be submitted to the Department in accordance with General Provision #7. [Reg.19.705 and 40 C.F.R. Part 52 Subpart E]

15. The permittee shall conduct weekly observations of the opacity from the sources in the following table and keep a record of these observations. [Reg.19.702 and 40 C.F.R. 52, Subpart E]

| Source Number | Equipment ID Number |
|---------------|---------------------|
| 03            | BH-4                |
| 06            | BH-5                |

| Source Number | Equipment ID Number |
|---------------|---------------------|
| 09            | BH-6                |
| 13            | BH-2                |
| 18            | BH-3                |

Weekly observations may be performed by plant personnel that are not certified opacity readers. If any visible emissions are detected, the permittee shall immediately take action to identify the cause of the visible emissions, implement corrective action, and document that visible emissions did not appear to be in excess of the permitted opacity following the corrective action. The permittee shall maintain records which contain the following items in order to demonstrate compliance with this plantwide condition.

- a. The date and time of the observation and the source observed.
- b. If visible emissions were detected.
- c. If visible emissions were detected, the cause of the emissions in excess of the opacity limit, the corrective action taken, and if the visible emissions appeared to be below the permitted limit after the corrective action was taken.
- d. The name of the person conducting the opacity observation.

These records shall be kept on site and made available to Department personnel upon request.

16. The facility shall maintain readily accessible records showing the dimension of the storage vessels listed in the table below and an analysis of the storage capacity of those vessels. [Reg.19.304 and 40 C.F.R. Part 60 Subpart Kb]

| Source Number | Equipment ID |
|---------------|--------------|
| 11            | M-2          |

17. The permittee shall maintain readily accessible records showing the dimension of the storage vessels listed in the table below and an analysis of the storage capacity of those vessels. All the listed storage vessels are controlled by SN-11, the Regenerative Thermal Oxidizer (RTO). [Reg.19.304 and 40 C.F.R. Part 63, Subpart G]

| Tank ID Number | Description               |
|----------------|---------------------------|
| M-2            | Methanol Storage Tank     |
| F-1            | Formaldehyde Storage Tank |
| F-2            | Formaldehyde Storage Tank |
| F-3            | Formaldehyde Storage Tank |
| F-4            | Formaldehyde Storage Tank |
| F-5            | Formaldehyde Storage Tank |

18. The permittee shall, for all equipment at the ICI formaldehyde plant in organic HAP service, comply with the general standards as outlined in §63.162 of 40 C.F.R. Part 63, Subpart H and the equipment specific standards outlined in §63.163 to §63.176 of 40 C.F.R. Part 63, Subpart H. [Reg.19.304 and 40 C.F.R. Part 63, Subpart H]
19. The permittee shall, for all equipment at the ICI formaldehyde plant in organic HAP service, comply with the testing and procedure requirements as outlined in §63.180 of 40 C.F.R. Part 63, Subpart H. [Reg.19.304 and 40 C.F.R. Part 63, Subpart H]
20. Compliance with the reporting requirements for the leak detection and repair requirements of 40 C.F.R. Part 63, Subpart H shall be demonstrated through compliance with Specific Condition #31. [Reg.19.304 and 40 C.F.R. Part 63, Subpart H]
21. The permittee shall comply with the requirements of 40 C.F.R. Part 63, Subpart H to control emissions from equipment leaks from equipment used in the production of wet strength resins. [Reg.19.304 and 40 C.F.R. Part 63, Subpart W]
22. The permittee shall, for all equipment at the Liquid Resin Manufacturing plant used to manufacture wet strength resins and which are in organic HAP service, comply with the general standards as outlined in §63.162 of 40 C.F.R. Part 63, Subpart H and the equipment specific standards outlined in §63.163 to §63.176 of Subpart H. [Reg.19.304 and 40 C.F.R. Part 63, Subpart W]
23. The permittee shall, for all equipment at the Liquid Resin Manufacturing plant used to manufacture wet strength resins and which are in organic HAP service, comply with the testing and procedure requirements as outlined in §63.180 of 40 C.F.R. Part 63, Subpart H. [Reg.19.304 and 40 C.F.R. Part 63, Subpart W]
24. The permittee shall, for all equipment at the Liquid Resin Manufacturing plant used to manufacture wet strength resins and which are in organic HAP service, comply with the record keeping and reporting requirements outlined in §63.181 and of 40 CFR Part 63, Subpart H. [Reg.19.304 and 40 C.F.R. Part 63, Subpart W]
25. The permittee shall emit less than 0.25 tons of any single HAP or any combination of HAPs from SN-95 in any consecutive twelve month period. The purpose of this condition is to avoid the provisions of 40 C.F.R. Part 63, §63.1407. [Reg.18.801, and Ark. Code Ann. § 8-4-203 as referenced by Ark. Code Ann. §§ 8-4-304 and 8-4-311]

26. The facility shall maintain monthly records of the 12 month rolling total which demonstrate compliance with the limits set in Plant Wide Condition #25 and may be used by the Department for enforcement purposes. These records shall be updated by the fifteenth day of the month following the month to which the records pertain. These records shall be kept on site, and shall be made available to Department personnel upon request. An annual total and each individual month's data shall be submitted to the Department in accordance with General Provision #7. [Reg.18.1004 and Ark. Code Ann. § 8-4-203 as referenced by Ark. Code Ann. §§ 8-4-304 and 8-4-311]
27. The permittee is subject to and shall comply with the requirements of 40 C.F.R. Part 68 including the submittal of the Risk Management Plan if permittee's facility is required pursuant to Section 112(r). [Ark. Code Ann. § 8-4-203 as referenced by Ark. Code Ann. §§ 8-4-304 and 8-4-311]
28. The permittee shall not produce more than two batches of LYTOR® 105K in any consecutive 24 hour period. Furthermore, the permittee shall not begin the startup of any batch unless either SN-05 or SN-129 is operating. [Reg.18.1004 and Ark. Code Ann. § 8-4-203 as referenced by Ark. Code Ann. §§ 8-4-304 and 8-4-311]
29. The permittee shall maintain records of each batch of LYTOR® 105K produced. These records shall include date, time of batch startup, time of previous batch startup, size of batch, and the number of batches produced in the previous eleven months. These records shall be updated on a per batch basis, kept on site, be made available to Department personnel upon request, and shall be submitted to the Air Division in accordance with General Provision #7. [Reg.18.1004 and Ark. Code Ann. § 8-4-203 as referenced by Ark. Code Ann. §§ 8-4-304 and 8-4-311]
30. To comply with the MON Subpart FFFF Leak Detection and Repair Requirements (LDAR) detailed in 40 CFR 63.2480 and in Table 6 of the subpart, the permittee shall implement and maintain an LDAR program for the MON affected source meeting the requirements in 40 C.F.R. Part 63, Subpart H. Records of the equipment counts of regulated valves, pump seals, compressor seals, pressure relief valves, connectors, open-ended lines, and sampling connections within the Subpart FFFF MON affected source shall be maintained onsite and reported semi-annually in the MON Semi-annual Report as required by Subpart FFFF and Subpart H. [Reg.19.501 et seq. and 40 C.F.R. Part 52, Subpart E]



**SECTION VII: INSIGNIFICANT ACTIVITIES**

The following sources are insignificant activities. Any activity that has a state or federal applicable requirement shall be considered a significant activity even if this activity meets the criteria of Reg.26.304 or listed in the table below. Insignificant activity determinations rely upon the information submitted by the permittee in an application dated September 02, 2016.

| Description  | Equipment ID   | Operation                  | Category |
|--|----------------|----------------------------|----------|
| 325hp Hydroblaster   |                |                            | A-1      |
| 1,000 gal Dowtherm Storage Tank                            | M-18           | UFC Manufacturing          | A-3      |
| 4,000 gal Therminol Charging Tank                          | V-701          | TOFRAC Plant               | A-3      |
| Sodium Hydroxide Storage Tank                              | M-5            | Liquid Resin Manufacturing | A-4      |
| Sodium Hydroxide Storage Tank                              | M-19           | Liquid Resin Manufacturing | A-4      |
| Sodium Hydroxide Process Weigh Tank                        | W-1            | Liquid Resin Manufacturing | A-4      |
| Sodium Hydroxide Process Weigh Tank                        | W-2            | Liquid Resin Manufacturing | A-4      |
| Dilute Caustic Storage                                     | RM-1           | Liquid Resin Manufacturing | A-4      |
| Sodium Hydroxide Storage Tank                              | T-53           | Facility Wide              | A-4      |
| Sodium Hydroxide Storage Tank                              | T-15           | Rosin Size Plant           | A-4      |
| Potassium Hydroxide Storage Tank                           | T-16           | Rosin Size Plant           | A-4      |
| NaOH/KOH and Water Dilution Tank                           | T-84           | Rosin Size Plant           | A-4      |
| Urea Storage Silo  | D-3            | Liquid Resin Manufacturing | A-13     |
| Kettle Urea Feed Hoppers                                   | UH-1           | Liquid Resin Manufacturing | A-13     |
| Epichlorohydrin Storage Tank                               | M-7            | Liquid Resin Manufacturing | A-13     |
| DETA Railcar Storage and Transfer to Trucks                | DETA Truck     | Liquid Resin Manufacturing | A-13     |
| Phenol Storage Tank  | M-6            | Liquid Resin Manufacturing | A-13     |
| Urea Solution Storage Tank                                 | US-1           | Liquid Resin Manufacturing | A-13     |
| Wet Strength Resin and Urea Solution Dilute Tank           | WSR Dilute     | Liquid Resin Manufacturing | A-13     |
| Novacote and Glassmat Resin Blend Storage Tanks            | U-5<br>U-6     | Liquid Resin Manufacturing | A-13     |
| Onsite Storage of Epichlorohydrin: 2-7,200 gallon trailers | EPI-1<br>EPI-2 | Liquid Resin Manufacturing | A-13     |
| RCI Distillate Tank  | M-10           | UFC Manufacturing          | A-13     |
| Hexamine Storage Tank                                      | S-3            | Spray Dry Manufacturing    | A-13     |
| Column   | DT-1           | TOFRAC Plant               | A-13     |
| XTOL Light Distilled Head Storage tank                     | T-73           | TOFREAC Plant              | A-13     |
| Test Tank  | T-74           | TOFRAC Plant               | A-13     |
| XTOL Railcar Loading                                       | N/A            | TOFRAC Plant               | A-13     |
| Therminol Surge Tank                                       | V-702          | TOFRAC Plant               | A-13     |
| Crude Tall Oil Storage Tank                                | T-1            | Tofrac Plant               | A-13     |
| Methanol Railcar Maintenance                               | N/A            | Facility-Wide              | A-13     |

Georgia-Pacific Chemicals LLC

Permit #: 1177-AOP-R15

AFIN: 02-00028

| <b>Description</b>   | <b>Equipment ID</b> | <b>Operation</b> | <b>Category</b> |
|--|---------------------|------------------|-----------------|
| Portable Pump with Diesel Engine                               | PP-1                | Facility Wide    | A-13            |
| 10 hp Self-Priming Water Pump                                  | Pump-1              | Facility Wide    | A-13            |
| 208 hp Non-Road, Non-Stationary<br>Emergency Generator         | N/A                 | Facility Wide    | A-13            |
| 111 hp Non-Road, Non-Stationary Diesel<br>Fired Air Compressor | N/A                 | Facility Wide    | A-13            |
| Ethylene Glycol Tank   | N/A                 | Facility Wide    | A-13            |

### SECTION VIII: GENERAL PROVISIONS

1. Any terms or conditions included in this permit which specify and reference Arkansas Pollution Control & Ecology Commission Regulation 18 or the Arkansas Water and Air Pollution Control Act (Ark. Code Ann. § 8-4-101 *et seq.*) as the sole origin of and authority for the terms or conditions are not required under the Clean Air Act or any of its applicable requirements, and are not federally enforceable under the Clean Air Act. Arkansas Pollution Control & Ecology Commission Regulation 18 was adopted pursuant to the Arkansas Water and Air Pollution Control Act (Ark. Code Ann. § 8-4-101 *et seq.*). Any terms or conditions included in this permit which specify and reference Arkansas Pollution Control & Ecology Commission Regulation 18 or the Arkansas Water and Air Pollution Control Act (Ark. Code Ann. § 8-4-101 *et seq.*) as the origin of and authority for the terms or conditions are enforceable under this Arkansas statute. [40 C.F.R. § 70.6(b)(2)]
2. This permit shall be valid for a period of five (5) years beginning on the date this permit becomes effective and ending five (5) years later. [40 C.F.R. § 70.6(a)(2) and Reg.26.701(B)]
3. The permittee must submit a complete application for permit renewal at least six (6) months before permit expiration. Permit expiration terminates the permittee's right to operate unless the permittee submitted a complete renewal application at least six (6) months before permit expiration. If the permittee submits a complete application, the existing permit will remain in effect until the Department takes final action on the renewal application. The Department will not necessarily notify the permittee when the permit renewal application is due. [Reg.26.406]
4. Where an applicable requirement of the Clean Air Act, as amended, 42 U.S.C. 7401, *et seq.* (Act) is more stringent than an applicable requirement of regulations promulgated under Title IV of the Act, the permit incorporates both provisions into the permit, and the Director or the Administrator can enforce both provisions. [40 C.F.R. § 70.6(a)(1)(ii) and Reg.26.701(A)(2)]
5. The permittee must maintain the following records of monitoring information as required by this permit.
  - a. The date, place as defined in this permit, and time of sampling or measurements;
  - b. The date(s) analyses performed;
  - c. The company or entity performing the analyses;
  - d. The analytical techniques or methods used;
  - e. The results of such analyses; and
  - f. The operating conditions existing at the time of sampling or measurement.

[40 C.F.R. § 70.6(a)(3)(ii)(A) and Reg.26.701(C)(2)]

6. The permittee must retain the records of all required monitoring data and support information for at least five (5) years from the date of the monitoring sample, measurement, report, or application. Support information includes all calibration and maintenance records and all original strip chart recordings for continuous monitoring instrumentation, and copies of all reports required by this permit. [40 C.F.R. § 70.6(a)(3)(ii)(B) and Reg.26.701(C)(2)(b)]
7. The permittee must submit reports of all required monitoring every six (6) months. If the permit establishes no other reporting period, the reporting period shall end on the last day of the month six months after the issuance of the initial Title V permit and every six months thereafter. The report is due on the first day of the second month after the end of the reporting period. The first report due after issuance of the initial Title V permit shall contain six months of data and each report thereafter shall contain 12 months of data. The report shall contain data for all monitoring requirements in effect during the reporting period. If a monitoring requirement is not in effect for the entire reporting period, only those months of data in which the monitoring requirement was in effect are required to be reported. The report must clearly identify all instances of deviations from permit requirements. A responsible official as defined in Reg.26.2 must certify all required reports. The permittee will send the reports to the address below:

Arkansas Department of Environmental Quality  
Air Division  
ATTN: Compliance Inspector Supervisor  
5301 Northshore Drive  
North Little Rock, AR 72118-5317

[40 C.F.R. § 70.6(a)(3)(iii)(A) and Reg.26.701(C)(3)(a)]

8. The permittee shall report to the Department all deviations from permit requirements, including those attributable to upset conditions as defined in the permit.
  - a. For all upset conditions (as defined in Reg.19.601), the permittee will make an initial report to the Department by the next business day after the discovery of the occurrence. The initial report may be made by telephone and shall include:
    - i. The facility name and location;
    - ii. The process unit or emission source deviating from the permit limit;
    - iii. The permit limit, including the identification of pollutants, from which deviation occurs;
    - iv. The date and time the deviation started;
    - v. The duration of the deviation;
    - vi. The emissions during the deviation;
    - vii. The probable cause of such deviations;
    - viii. Any corrective actions or preventive measures taken or being taken to prevent such deviations in the future; and

ix. The name of the person submitting the report.

The permittee shall make a full report in writing to the Department within five (5) business days of discovery of the occurrence. The report must include, in addition to the information required by the initial report, a schedule of actions taken or planned to eliminate future occurrences and/or to minimize the amount the permit's limits were exceeded and to reduce the length of time the limits were exceeded. The permittee may submit a full report in writing (by facsimile, overnight courier, or other means) by the next business day after discovery of the occurrence, and the report will serve as both the initial report and full report.

b. For all deviations, the permittee shall report such events in semi-annual reporting and annual certifications required in this permit. This includes all upset conditions reported in 8a above. The semi-annual report must include all the information as required by the initial and full reports required in 8a.

[Reg.19.601, Reg.19.602, Reg.26.701(C)(3)(b), and 40 C.F.R. § 70.6(a)(3)(iii)(B)]

9. If any provision of the permit or the application thereof to any person or circumstance is held invalid, such invalidity will not affect other provisions or applications hereof which can be given effect without the invalid provision or application, and to this end, provisions of this Regulation are declared to be separable and severable. [40 C.F.R. § 70.6(a)(5), Reg.26.701(E), and Ark. Code Ann. § 8-4-203 as referenced by Ark. Code Ann. §§ 8-4-304 and 8-4-311]
10. The permittee must comply with all conditions of this Part 70 permit. Any permit noncompliance with applicable requirements as defined in Regulation 26 constitutes a violation of the Clean Air Act, as amended, 42 U.S.C. § 7401, *et seq.* and is grounds for enforcement action; for permit termination, revocation and reissuance, for permit modification; or for denial of a permit renewal application. [40 C.F.R. § 70.6(a)(6)(i) and Reg.26.701(F)(1)]
11. It shall not be a defense for a permittee in an enforcement action that it would have been necessary to halt or reduce the permitted activity to maintain compliance with the conditions of this permit. [40 C.F.R. § 70.6(a)(6)(ii) and Reg.26.701(F)(2)]
12. The Department may modify, revoke, reopen and reissue the permit or terminate the permit for cause. The filing of a request by the permittee for a permit modification, revocation and reissuance, termination, or of a notification of planned changes or anticipated noncompliance does not stay any permit condition. [40 C.F.R. § 70.6(a)(6)(iii) and Reg.26.701(F)(3)]
13. This permit does not convey any property rights of any sort, or any exclusive privilege. [40 C.F.R. § 70.6(a)(6)(iv) and Reg.26.701(F)(4)]

14. The permittee must furnish to the Director, within the time specified by the Director, any information that the Director may request in writing to determine whether cause exists for modifying, revoking and reissuing, or terminating the permit or to determine compliance with the permit. Upon request, the permittee must also furnish to the Director copies of records required by the permit. For information the permittee claims confidentiality, the Department may require the permittee to furnish such records directly to the Director along with a claim of confidentiality. [40 C.F.R. § 70.6(a)(6)(v) and Reg.26.701(F)(5)]
15. The permittee must pay all permit fees in accordance with the procedures established in Regulation 9. [40 C.F.R. § 70.6(a)(7) and Reg.26.701(G)]
16. No permit revision shall be required, under any approved economic incentives, marketable permits, emissions trading and other similar programs or processes for changes provided for elsewhere in this permit. [40 C.F.R. § 70.6(a)(8) and Reg.26.701(H)]
17. If the permit allows different operating scenarios, the permittee shall, contemporaneously with making a change from one operating scenario to another, record in a log at the permitted facility a record of the operational scenario. [40 C.F.R. § 70.6(a)(9)(i) and Reg.26.701(I)(1)]
18. The Administrator and citizens may enforce under the Act all terms and conditions in this permit, including any provisions designed to limit a source's potential to emit, unless the Department specifically designates terms and conditions of the permit as being federally unenforceable under the Act or under any of its applicable requirements. [40 C.F.R. § 70.6(b) and Reg.26.702(A) and (B)]
19. Any document (including reports) required by this permit pursuant to 40 C.F.R. § 70 must contain a certification by a responsible official as defined in Reg.26.2. [40 C.F.R. § 70.6(c)(1) and Reg.26.703(A)]
20. The permittee must allow an authorized representative of the Department, upon presentation of credentials, to perform the following: [40 C.F.R. § 70.6(c)(2) and Reg.26.703(B)]
  - a. Enter upon the permittee's premises where the permitted source is located or emissions related activity is conducted, or where records must be kept under the conditions of this permit;
  - b. Have access to and copy, at reasonable times, any records required under the conditions of this permit;
  - c. Inspect at reasonable times any facilities, equipment (including monitoring and air pollution control equipment), practices, or operations regulated or required under this permit; and
  - d. As authorized by the Act, sample or monitor at reasonable times substances or parameters for assuring compliance with this permit or applicable requirements.

21. The permittee shall submit a compliance certification with the terms and conditions contained in the permit, including emission limitations, standards, or work practices. The permittee must submit the compliance certification annually. If the permit establishes no other reporting period, the reporting period shall end on the last day of the anniversary month of the initial Title V permit. The report is due on the first day of the second month after the end of the reporting period. The permittee must also submit the compliance certification to the Administrator as well as to the Department. All compliance certifications required by this permit must include the following: [40 C.F.R. § 70.6(c)(5) and Reg.26.703(E)(3)]
  - a. The identification of each term or condition of the permit that is the basis of the certification;
  - b. The compliance status;
  - c. Whether compliance was continuous or intermittent;
  - d. The method(s) used for determining the compliance status of the source, currently and over the reporting period established by the monitoring requirements of this permit; and
  - e. Such other facts as the Department may require elsewhere in this permit or by § 114(a)(3) and § 504(b) of the Act.
22. Nothing in this permit will alter or affect the following: [Reg.26.704(C)]
  - a. The provisions of Section 303 of the Act (emergency orders), including the authority of the Administrator under that section;
  - b. The liability of the permittee for any violation of applicable requirements prior to or at the time of permit issuance;
  - c. The applicable requirements of the acid rain program, consistent with § 408(a) of the Act; or
  - d. The ability of EPA to obtain information from a source pursuant to § 114 of the Act.
23. This permit authorizes only those pollutant emitting activities addressed in this permit. [Ark. Code Ann. § 8-4-203 as referenced by Ark. Code Ann. §§ 8-4-304 and 8-4-311]
24. The permittee may request in writing and at least 15 days in advance of the deadline, an extension to any testing, compliance or other dates in this permit. No such extensions are authorized until the permittee receives written Department approval. The Department may grant such a request, at its discretion in the following circumstances:
  - a. Such an extension does not violate a federal requirement;
  - b. The permittee demonstrates the need for the extension; and
  - c. The permittee documents that all reasonable measures have been taken to meet the current deadline and documents reasons it cannot be met.

[Reg.18.314(A), Reg.19.416(A), Reg.26.1013(A), Ark. Code Ann. § 8-4-203 as referenced by Ark. Code Ann. §§ 8-4-304 and 8-4-311, and 40 C.F.R. § 52 Subpart E]

25. The permittee may request in writing and at least 30 days in advance, temporary emissions and/or testing that would otherwise exceed an emission rate, throughput requirement, or other limit in this permit. No such activities are authorized until the permittee receives written Department approval. Any such emissions shall be included in the facility's total emissions and reported as such. The Department may grant such a request, at its discretion under the following conditions:
- a. Such a request does not violate a federal requirement;
  - b. Such a request is temporary in nature;
  - c. Such a request will not result in a condition of air pollution;
  - d. The request contains such information necessary for the Department to evaluate the request, including but not limited to, quantification of such emissions and the date/time such emission will occur;
  - e. Such a request will result in increased emissions less than five tons of any individual criteria pollutant, one ton of any single HAP and 2.5 tons of total HAPs; and
  - f. The permittee maintains records of the dates and results of such temporary emissions/testing.

[Reg.18.314(B), Reg.19.416(B), Reg.26.1013(B), Ark. Code Ann. § 8-4-203 as referenced by Ark. Code Ann. §§ 8-4-304 and 8-4-311, and 40 C.F.R. § 52 Subpart E]

26. The permittee may request in writing and at least 30 days in advance, an alternative to the specified monitoring in this permit. No such alternatives are authorized until the permittee receives written Department approval. The Department may grant such a request, at its discretion under the following conditions:
- a. The request does not violate a federal requirement;
  - b. The request provides an equivalent or greater degree of actual monitoring to the current requirements; and
  - c. Any such request, if approved, is incorporated in the next permit modification application by the permittee.

[Reg.18.314(C), Reg.19.416(C), Reg.26.1013(C), Ark. Code Ann. § 8-4-203 as referenced by Ark. Code Ann. §§ 8-4-304 and 8-4-311, and 40 C.F.R. § 52 Subpart E]



**Appendix A**  
40 C.F.R. Part 60, Subpart Dc – *Standards of Performance for Small Industrial-Commercial-  
Institutional Steam Generating Units*

SOURCE: 72 FR 32759, June 13, 2007, unless otherwise noted.

**§60.40c Applicability and delegation of authority.**

(a) Except as provided in paragraphs (d), (e), (f), and (g) of this section, the affected facility to which this subpart applies is each steam generating unit for which construction, modification, or reconstruction is commenced after June 9, 1989 and that has a maximum design heat input capacity of 29 megawatts (MW) (100 million British thermal units per hour (MMBtu/h)) or less, but greater than or equal to 2.9 MW (10 MMBtu/h).

(b) In delegating implementation and enforcement authority to a State under section 111(c) of the Clean Air Act, §60.48c(a)(4) shall be retained by the Administrator and not transferred to a State.

(c) Steam generating units that meet the applicability requirements in paragraph (a) of this section are not subject to the sulfur dioxide (SO<sub>2</sub>) or particulate matter (PM) emission limits, performance testing requirements, or monitoring requirements under this subpart (§§60.42c, 60.43c, 60.44c, 60.45c, 60.46c, or 60.47c) during periods of combustion research, as defined in §60.41c.

(d) Any temporary change to an existing steam generating unit for the purpose of conducting combustion research is not considered a modification under §60.14.

(e) Affected facilities (*i.e.* heat recovery steam generators and fuel heaters) that are associated with stationary combustion turbines and meet the applicability requirements of subpart KKKK of this part are not subject to this subpart. This subpart will continue to apply to all other heat recovery steam generators, fuel heaters, and other affected facilities that are capable of combusting more than or equal to 2.9 MW (10 MMBtu/h) heat input of fossil fuel but less than or equal to 29 MW (100 MMBtu/h) heat input of fossil fuel. If the heat recovery steam generator, fuel heater, or other affected facility is subject to this subpart, only emissions resulting from combustion of fuels in the steam generating unit are subject to this subpart. (The stationary combustion turbine emissions are subject to subpart GG or KKKK, as applicable, of this part.)

(f) Any affected facility that meets the applicability requirements of and is subject to subpart AAAA or subpart CCCC of this part is not subject to this subpart.

(g) Any facility that meets the applicability requirements and is subject to an EPA approved State or Federal section 111(d)/129 plan implementing subpart BBBB of this part is not subject to this subpart.

(h) Affected facilities that also meet the applicability requirements under subpart J or subpart Ja of this part are subject to the PM and NO<sub>x</sub> standards under this subpart and the SO<sub>2</sub> standards under subpart J or subpart Ja of this part, as applicable.

(i) Temporary boilers are not subject to this subpart.

[72 FR 32759, June 13, 2007, as amended at 74 FR 5090, Jan. 28, 2009; 77 FR 9461, Feb. 16, 2012]

**§60.41c Definitions.**

As used in this subpart, all terms not defined herein shall have the meaning given them in the Clean Air Act and in subpart A of this part.

*Annual capacity factor* means the ratio between the actual heat input to a steam generating unit from an individual fuel or combination of fuels during a period of 12 consecutive calendar months and the potential heat input to the steam generating unit from all fuels had the steam generating unit been operated for 8,760 hours during that 12-month period at the maximum design heat input capacity. In the case of steam generating units that are rented or leased, the actual heat input shall be determined based on the combined heat input from all operations of the affected facility during a period of 12 consecutive calendar months.

*Coal* means all solid fuels classified as anthracite, bituminous, subbituminous, or lignite by the American Society of Testing and Materials in ASTM D388 (incorporated by reference, see §60.17), coal refuse, and petroleum coke. Coal-derived synthetic fuels derived from coal for the purposes of creating useful heat, including but not limited to solvent refined coal, gasified coal not meeting the definition of natural gas, coal-oil mixtures, and coal-water mixtures, are also included in this definition for the purposes of this subpart.

*Coal refuse* means any by-product of coal mining or coal cleaning operations with an ash content greater than 50 percent (by weight) and a heating value less than 13,900 kilojoules per kilogram (kJ/kg) (6,000 Btu per pound (Btu/lb) on a dry basis).

*Combined cycle system* means a system in which a separate source (such as a stationary gas turbine, internal combustion engine, or kiln) provides exhaust gas to a steam generating unit.

*Combustion research* means the experimental firing of any fuel or combination of fuels in a steam generating unit for the purpose of conducting research and development of more efficient combustion or more effective prevention or control of air pollutant emissions from combustion, provided that, during these periods of research and development, the heat generated is not used for any purpose other than preheating combustion air for use by that steam generating unit (*i.e.*, the heat generated is released to the atmosphere without being used for space heating, process heating, driving pumps, preheating combustion air for other units, generating electricity, or any other purpose).

*Conventional technology* means wet flue gas desulfurization technology, dry flue gas desulfurization technology, atmospheric fluidized bed combustion technology, and oil hydrodesulfurization technology.

*Distillate oil* means fuel oil that complies with the specifications for fuel oil numbers 1 or 2, as defined by the American Society for Testing and Materials in ASTM D396 (incorporated by reference, see §60.17), diesel fuel oil numbers 1 or 2, as defined by the American Society for Testing and Materials in ASTM D975 (incorporated by reference, see §60.17), kerosine, as defined by the American Society of Testing and Materials in ASTM D3699 (incorporated by reference, see §60.17), biodiesel as defined by the American Society of Testing and Materials in ASTM D6751 (incorporated by reference, see §60.17), or biodiesel blends as defined by the American Society of Testing and Materials in ASTM D7467 (incorporated by reference, see §60.17).

*Dry flue gas desulfurization technology* means a SO<sub>2</sub> control system that is located between the steam generating unit and the exhaust vent or stack, and that removes sulfur oxides from the combustion gases of the steam generating unit by contacting the combustion gases with an alkaline reagent and water, whether introduced separately or as a premixed slurry or solution and forming a dry powder material. This definition includes devices where the dry powder material is subsequently converted to another form. Alkaline reagents used in dry flue gas desulfurization systems include, but are not limited to, lime and sodium compounds.

*Duct burner* means a device that combusts fuel and that is placed in the exhaust duct from another source (such as a stationary gas turbine, internal combustion engine, kiln, etc.) to allow the firing of additional fuel to heat the exhaust gases before the exhaust gases enter a steam generating unit.

*Emerging technology* means any SO<sub>2</sub> control system that is not defined as a conventional technology under this section, and for which the owner or operator of the affected facility has received approval from the Administrator to operate as an emerging technology under §60.48c(a)(4).

*Federally enforceable* means all limitations and conditions that are enforceable by the Administrator, including the requirements of 40 CFR parts 60 and 61, requirements within any applicable State implementation plan, and any permit requirements established under 40 CFR 52.21 or under 40 CFR 51.18 and 51.24.

*Fluidized bed combustion technology* means a device wherein fuel is distributed onto a bed (or series of beds) of limestone aggregate (or other sorbent materials) for combustion; and these materials are forced upward in the device by the flow of combustion air and the gaseous products of combustion. Fluidized bed combustion technology includes, but is not limited to, bubbling bed units and circulating bed units.

*Fuel pretreatment* means a process that removes a portion of the sulfur in a fuel before combustion of the fuel in a steam generating unit.

*Heat input* means heat derived from combustion of fuel in a steam generating unit and does not include the heat derived from preheated combustion air, recirculated flue gases, or exhaust gases from other sources (such as stationary gas turbines, internal combustion engines, and kilns).

*Heat transfer medium* means any material that is used to transfer heat from one point to another point.

*Maximum design heat input capacity* means the ability of a steam generating unit to combust a stated maximum amount of fuel (or combination of fuels) on a steady state basis as determined by the physical design and characteristics of the steam generating unit.

*Natural gas* means:

(1) A naturally occurring mixture of hydrocarbon and nonhydrocarbon gases found in geologic formations beneath the earth's surface, of which the principal constituent is methane; or

(2) Liquefied petroleum (LP) gas, as defined by the American Society for Testing and Materials in ASTM D1835 (incorporated by reference, see §60.17); or

(3) A mixture of hydrocarbons that maintains a gaseous state at ISO conditions. Additionally, natural gas must either be composed of at least 70 percent methane by volume or have a gross calorific value between 34 and 43 megajoules (MJ) per dry standard cubic meter (910 and 1,150 Btu per dry standard cubic foot).

*Noncontinental area* means the State of Hawaii, the Virgin Islands, Guam, American Samoa, the Commonwealth of Puerto Rico, or the Northern Mariana Islands.

*Oil* means crude oil or petroleum, or a liquid fuel derived from crude oil or petroleum, including distillate oil and residual oil.

*Potential sulfur dioxide emission rate* means the theoretical SO<sub>2</sub> emissions (nanograms per joule (ng/J) or lb/MMBtu heat input) that would result from combusting fuel in an uncleaned state and without using emission control systems.

*Process heater* means a device that is primarily used to heat a material to initiate or promote a chemical reaction in which the material participates as a reactant or catalyst.

*Residual oil* means crude oil, fuel oil that does not comply with the specifications under the definition of distillate oil, and all fuel oil numbers 4, 5, and 6, as defined by the American Society for Testing and Materials in ASTM D396 (incorporated by reference, see §60.17).

*Steam generating unit* means a device that combusts any fuel and produces steam or heats water or heats any heat transfer medium. This term includes any duct burner that combusts fuel and is part of a combined cycle system. This term does not include process heaters as defined in this subpart.

*Steam generating unit operating day* means a 24-hour period between 12:00 midnight and the following midnight during which any fuel is combusted at any time in the steam generating unit. It is not necessary for fuel to be combusted continuously for the entire 24-hour period.

*Temporary boiler* means a steam generating unit that combusts natural gas or distillate oil with a potential SO<sub>2</sub> emissions rate no greater than 26 ng/J (0.060 lb/MMBtu), and the unit is designed to, and is capable of, being carried or moved from one location to another by means of, for example, wheels, skids, carrying handles, dollies, trailers, or platforms. A steam generating unit is not a temporary boiler if any one of the following conditions exists:

- (1) The equipment is attached to a foundation.
- (2) The steam generating unit or a replacement remains at a location for more than 180 consecutive days. Any temporary boiler that replaces a temporary boiler at a location and performs the same or similar function will be included in calculating the consecutive time period.
- (3) The equipment is located at a seasonal facility and operates during the full annual operating period of the seasonal facility, remains at the facility for at least 2 years, and operates at that facility for at least 3 months each year.
- (4) The equipment is moved from one location to another in an attempt to circumvent the residence time requirements of this definition.

*Wet flue gas desulfurization technology* means an SO<sub>2</sub> control system that is located between the steam generating unit and the exhaust vent or stack, and that removes sulfur oxides from the combustion gases of the steam generating unit by contacting the combustion gases with an alkaline slurry or solution and forming a liquid material. This definition includes devices where the liquid material is subsequently converted to another form. Alkaline reagents used in wet flue gas desulfurization systems include, but are not limited to, lime, limestone, and sodium compounds.

*Wet scrubber system* means any emission control device that mixes an aqueous stream or slurry with the exhaust gases from a steam generating unit to control emissions of PM or SO<sub>2</sub>.

*Wood* means wood, wood residue, bark, or any derivative fuel or residue thereof, in any form, including but not limited to sawdust, sanderdust, wood chips, scraps, slabs, millings, shavings, and processed pellets made from wood or other forest residues.

[72 FR 32759, June 13, 2007, as amended at 74 FR 5090, Jan. 28, 2009; 77 FR 9461, Feb. 16, 2012]

#### **§60.42c Standard for sulfur dioxide (SO<sub>2</sub>).**

(a) Except as provided in paragraphs (b), (c), and (e) of this section, on and after the date on which the performance test is completed or required to be completed under §60.8, whichever date comes first, the owner or operator of an affected facility that combusts only coal shall neither: cause to be discharged into the atmosphere from the affected facility any gases that contain SO<sub>2</sub> in excess of 87 ng/J (0.20 lb/MMBtu) heat input or 10 percent (0.10) of the potential SO<sub>2</sub> emission rate (90 percent reduction), nor cause to be discharged into the atmosphere from the affected facility any gases that contain SO<sub>2</sub> in excess of 520 ng/J (1.2 lb/MMBtu) heat input. If coal is combusted with other fuels, the affected facility shall neither: cause to be discharged into the atmosphere from the affected facility any gases that contain SO<sub>2</sub> in excess of 87 ng/J (0.20 lb/MMBtu) heat input or 10 percent (0.10) of the potential SO<sub>2</sub> emission rate (90 percent reduction), nor cause to be discharged into the atmosphere from the affected facility any gases that contain SO<sub>2</sub> in excess of the emission limit is determined pursuant to paragraph (e)(2) of this section.

(b) Except as provided in paragraphs (c) and (e) of this section, on and after the date on which the performance test is completed or required to be completed under §60.8, whichever date comes first, the owner or operator of an affected facility that:

(1) Combusts only coal refuse alone in a fluidized bed combustion steam generating unit shall neither:

(i) Cause to be discharged into the atmosphere from that affected facility any gases that contain SO<sub>2</sub> in excess of 87 ng/J (0.20 lb/MMBtu) heat input or 20 percent (0.20) of the potential SO<sub>2</sub> emission rate (80 percent reduction); nor

(ii) Cause to be discharged into the atmosphere from that affected facility any gases that contain SO<sub>2</sub> in excess of 520 ng/J (1.2 lb/MMBtu) heat input. If coal is fired with coal refuse, the affected facility subject to paragraph (a) of this section. If oil or any other fuel (except coal) is fired with coal refuse, the affected facility is subject to the 87 ng/J (0.20 lb/MMBtu) heat input SO<sub>2</sub> emissions limit or the 90 percent SO<sub>2</sub> reduction requirement specified in paragraph (a) of this section and the emission limit is determined pursuant to paragraph (e)(2) of this section.

(2) Combusts only coal and that uses an emerging technology for the control of SO<sub>2</sub> emissions shall neither:

(i) Cause to be discharged into the atmosphere from that affected facility any gases that contain SO<sub>2</sub> in excess of 50 percent (0.50) of the potential SO<sub>2</sub> emission rate (50 percent reduction); nor

(ii) Cause to be discharged into the atmosphere from that affected facility any gases that contain SO<sub>2</sub> in excess of 260 ng/J (0.60 lb/MMBtu) heat input. If coal is combusted with other fuels, the affected facility is subject to the 50 percent SO<sub>2</sub> reduction requirement specified in this paragraph and the emission limit determined pursuant to paragraph (e)(2) of this section.

(c) On and after the date on which the initial performance test is completed or required to be completed under §60.8, whichever date comes first, no owner or operator of an affected facility that combusts coal, alone or in combination with any other fuel, and is listed in paragraphs (c)(1), (2), (3), or (4) of this section shall cause to be discharged into the atmosphere from that affected facility any gases that contain SO<sub>2</sub> in excess of the emission limit determined pursuant to paragraph (e)(2) of this section. Percent reduction requirements are not applicable to affected facilities under paragraphs (c)(1), (2), (3), or (4).

(1) Affected facilities that have a heat input capacity of 22 MW (75 MMBtu/h) or less;

(2) Affected facilities that have an annual capacity for coal of 55 percent (0.55) or less and are subject to a federally enforceable requirement limiting operation of the affected facility to an annual capacity factor for coal of 55 percent (0.55) or less.

(3) Affected facilities located in a noncontinental area; or

(4) Affected facilities that combust coal in a duct burner as part of a combined cycle system where 30 percent (0.30) or less of the heat entering the steam generating unit is from combustion of coal in the duct burner and 70 percent (0.70) or more of the heat entering the steam generating unit is from exhaust gases entering the duct burner.

(d) On and after the date on which the initial performance test is completed or required to be completed under §60.8, whichever date comes first, no owner or operator of an affected facility that combusts oil shall cause to be discharged into the atmosphere from that affected facility any gases that contain SO<sub>2</sub> in excess of 215 ng/J (0.50 lb/MMBtu) heat input from oil; or, as an alternative, no owner or operator of an affected facility that combusts oil shall combust oil in the affected facility that contains greater than 0.5 weight percent sulfur. The percent reduction requirements are not applicable to affected facilities under this paragraph.

(e) On and after the date on which the initial performance test is completed or required to be completed under §60.8, whichever date comes first, no owner or operator of an affected facility that combusts coal, oil, or coal and oil with any other fuel shall cause to be discharged into the atmosphere from that affected facility any gases that contain SO<sub>2</sub> in excess of the following:

(1) The percent of potential SO<sub>2</sub> emission rate or numerical SO<sub>2</sub> emission rate required under paragraph (a) or (b)(2) of this section, as applicable, for any affected facility that

(i) Combusts coal in combination with any other fuel;

(ii) Has a heat input capacity greater than 22 MW (75 MMBtu/h); and

(iii) Has an annual capacity factor for coal greater than 55 percent (0.55); and

(2) The emission limit determined according to the following formula for any affected facility that combusts coal, oil, or coal and oil with any other fuel:

$$E_s = \frac{(K_a H_a + K_b H_b + K_c H_c)}{(H_a + H_b + H_c)}$$

Where:

E<sub>s</sub> = SO<sub>2</sub> emission limit, expressed in ng/J or lb/MMBtu heat input;

K<sub>a</sub> = 520 ng/J (1.2 lb/MMBtu);

K<sub>b</sub> = 260 ng/J (0.60 lb/MMBtu);

K<sub>c</sub> = 215 ng/J (0.50 lb/MMBtu);

H<sub>a</sub> = Heat input from the combustion of coal, except coal combusted in an affected facility subject to paragraph (b)(2) of this section, in Joules (J) [MMBtu];

H<sub>b</sub> = Heat input from the combustion of coal in an affected facility subject to paragraph (b)(2) of this section, in J (MMBtu); and

$H_c$  = Heat input from the combustion of oil, in J (MMBtu).

(f) Reduction in the potential SO<sub>2</sub> emission rate through fuel pretreatment is not credited toward the percent reduction requirement under paragraph (b)(2) of this section unless:

(1) Fuel pretreatment results in a 50 percent (0.50) or greater reduction in the potential SO<sub>2</sub> emission rate; and

(2) Emissions from the pretreated fuel (without either combustion or post-combustion SO<sub>2</sub> control) are equal to or less than the emission limits specified under paragraph (b)(2) of this section.

(g) Except as provided in paragraph (h) of this section, compliance with the percent reduction requirements, fuel oil sulfur limits, and emission limits of this section shall be determined on a 30-day rolling average basis.

(h) For affected facilities listed under paragraphs (h)(1), (2), (3), or (4) of this section, compliance with the emission limits or fuel oil sulfur limits under this section may be determined based on a certification from the fuel supplier, as described under §60.48c(f), as applicable.

(1) Distillate oil-fired affected facilities with heat input capacities between 2.9 and 29 MW (10 and 100 MMBtu/hr).

(2) Residual oil-fired affected facilities with heat input capacities between 2.9 and 8.7 MW (10 and 30 MMBtu/hr).

(3) Coal-fired affected facilities with heat input capacities between 2.9 and 8.7 MW (10 and 30 MMBtu/h).

(4) Other fuels-fired affected facilities with heat input capacities between 2.9 and 8.7 MW (10 and 30 MMBtu/h).

(i) The SO<sub>2</sub> emission limits, fuel oil sulfur limits, and percent reduction requirements under this section apply at all times, including periods of startup, shutdown, and malfunction.

(j) For affected facilities located in noncontinental areas and affected facilities complying with the percent reduction standard, only the heat input supplied to the affected facility from the combustion of coal and oil is counted under this section. No credit is provided for the heat input to the affected facility from wood or other fuels or for heat derived from exhaust gases from other sources, such as stationary gas turbines, internal combustion engines, and kilns.

[72 FR 32759, June 13, 2007, as amended at 74 FR 5090, Jan. 28, 2009; 77 FR 9462, Feb. 16, 2012]

#### **§60.43c Standard for particulate matter (PM).**

(a) On and after the date on which the initial performance test is completed or required to be completed under §60.8, whichever date comes first, no owner or operator of an affected facility that commenced construction, reconstruction, or modification on or before February 28, 2005, that combusts coal or combusts mixtures of coal with other fuels and has a heat input capacity of 8.7 MW (30 MMBtu/h) or greater, shall cause to be discharged into the atmosphere from that affected facility any gases that contain PM in excess of the following emission limits:

(1) 22 ng/J (0.051 lb/MMBtu) heat input if the affected facility combusts only coal, or combusts coal with other fuels and has an annual capacity factor for the other fuels of 10 percent (0.10) or less.



(2) 43 ng/J (0.10 lb/MMBtu) heat input if the affected facility combusts coal with other fuels, has an annual capacity factor for the other fuels greater than 10 percent (0.10), and is subject to a federally enforceable requirement limiting operation of the affected facility to an annual capacity factor greater than 10 percent (0.10) for fuels other than coal.

(b) On and after the date on which the initial performance test is completed or required to be completed under §60.8, whichever date comes first, no owner or operator of an affected facility that commenced construction, reconstruction, or modification on or before February 28, 2005, that combusts wood or combusts mixtures of wood with other fuels (except coal) and has a heat input capacity of 8.7 MW (30 MMBtu/h) or greater, shall cause to be discharged into the atmosphere from that affected facility any gases that contain PM in excess of the following emissions limits:

(1) 43 ng/J (0.10 lb/MMBtu) heat input if the affected facility has an annual capacity factor for wood greater than 30 percent (0.30); or

(2) 130 ng/J (0.30 lb/MMBtu) heat input if the affected facility has an annual capacity factor for wood of 30 percent (0.30) or less and is subject to a federally enforceable requirement limiting operation of the affected facility to an annual capacity factor for wood of 30 percent (0.30) or less.

(c) On and after the date on which the initial performance test is completed or required to be completed under §60.8, whichever date comes first, no owner or operator of an affected facility that combusts coal, wood, or oil and has a heat input capacity of 8.7 MW (30 MMBtu/h) or greater shall cause to be discharged into the atmosphere from that affected facility any gases that exhibit greater than 20 percent opacity (6-minute average), except for one 6-minute period per hour of not more than 27 percent opacity. Owners and operators of an affected facility that elect to install, calibrate, maintain, and operate a continuous emissions monitoring system (CEMS) for measuring PM emissions according to the requirements of this subpart and are subject to a federally enforceable PM limit of 0.030 lb/MMBtu or less are exempt from the opacity standard specified in this paragraph (c).

(d) The PM and opacity standards under this section apply at all times, except during periods of startup, shutdown, or malfunction.

(e)(1) On and after the date on which the initial performance test is completed or is required to be completed under §60.8, whichever date comes first, no owner or operator of an affected facility that commences construction, reconstruction, or modification after February 28, 2005, and that combusts coal, oil, wood, a mixture of these fuels, or a mixture of these fuels with any other fuels and has a heat input capacity of 8.7 MW (30 MMBtu/h) or greater shall cause to be discharged into the atmosphere from that affected facility any gases that contain PM in excess of 13 ng/J (0.030 lb/MMBtu) heat input, except as provided in paragraphs (e)(2), (e)(3), and (e)(4) of this section.

(2) As an alternative to meeting the requirements of paragraph (e)(1) of this section, the owner or operator of an affected facility for which modification commenced after February 28, 2005, may elect to meet the requirements of this paragraph. On and after the date on which the initial performance test is completed or required to be completed under §60.8, whichever date comes first, no owner or operator of an affected facility that commences modification after February 28, 2005 shall cause to be discharged into the atmosphere from that affected facility any gases that contain PM in excess of both:

(i) 22 ng/J (0.051 lb/MMBtu) heat input derived from the combustion of coal, oil, wood, a mixture of these fuels, or a mixture of these fuels with any other fuels; and

(ii) 0.2 percent of the combustion concentration (99.8 percent reduction) when combusting coal, oil, wood, a mixture of these fuels, or a mixture of these fuels with any other fuels.

(3) On and after the date on which the initial performance test is completed or is required to be completed under §60.8, whichever date comes first, no owner or operator of an affected facility that commences modification after February 28, 2005, and that combusts over 30 percent wood (by heat input) on an annual basis and has a heat input capacity of 8.7 MW (30 MMBtu/h) or greater shall cause to be discharged into the atmosphere from that affected facility any gases that contain PM in excess of 43 ng/J (0.10 lb/MMBtu) heat input.

(4) An owner or operator of an affected facility that commences construction, reconstruction, or modification after February 28, 2005, and that combusts only oil that contains no more than 0.50 weight percent sulfur or a mixture of 0.50 weight percent sulfur oil with other fuels not subject to a PM standard under §60.43c and not using a post-combustion technology (except a wet scrubber) to reduce PM or SO<sub>2</sub> emissions is not subject to the PM limit in this section.

[72 FR 32759, June 13, 2007, as amended at 74 FR 5091, Jan. 28, 2009; 77 FR 9462, Feb. 16, 2012]

#### **§60.44c Compliance and performance test methods and procedures for sulfur dioxide.**

(a) Except as provided in paragraphs (g) and (h) of this section and §60.8(b), performance tests required under §60.8 shall be conducted following the procedures specified in paragraphs (b), (c), (d), (e), and (f) of this section, as applicable. Section 60.8(f) does not apply to this section. The 30-day notice required in §60.8(d) applies only to the initial performance test unless otherwise specified by the Administrator.

(b) The initial performance test required under §60.8 shall be conducted over 30 consecutive operating days of the steam generating unit. Compliance with the percent reduction requirements and SO<sub>2</sub> emission limits under §60.42c shall be determined using a 30-day average. The first operating day included in the initial performance test shall be scheduled within 30 days after achieving the maximum production rate at which the affect facility will be operated, but not later than 180 days after the initial startup of the facility. The steam generating unit load during the 30-day period does not have to be the maximum design heat input capacity, but must be representative of future operating conditions.

(c) After the initial performance test required under paragraph (b) of this section and §60.8, compliance with the percent reduction requirements and SO<sub>2</sub> emission limits under §60.42c is based on the average percent reduction and the average SO<sub>2</sub> emission rates for 30 consecutive steam generating unit operating days. A separate performance test is completed at the end of each steam generating unit operating day, and a new 30-day average percent reduction and SO<sub>2</sub>emission rate are calculated to show compliance with the standard.

(d) If only coal, only oil, or a mixture of coal and oil is combusted in an affected facility, the procedures in Method 19 of appendix A of this part are used to determine the hourly SO<sub>2</sub> emission rate (E<sub>ho</sub>) and the 30-day average SO<sub>2</sub> emission rate (E<sub>ao</sub>). The hourly averages used to compute the 30-day averages are obtained from the CEMS. Method 19 of appendix A of this part shall be used to calculate E<sub>ao</sub> when using daily fuel sampling or Method 6B of appendix A of this part.

(e) If coal, oil, or coal and oil are combusted with other fuels:

(1) An adjusted E<sub>ho</sub> (E<sub>ho,o</sub>) is used in Equation 19-19 of Method 19 of appendix A of this part to compute the adjusted E<sub>ao</sub> (E<sub>ao,o</sub>). The E<sub>ho,o</sub> is computed using the following formula:

$$E_{ho,o} = \frac{E_{ho} - E_w(1 - X_1)}{X_1}$$

Where:

$E_{ho}$  = Adjusted  $E_{no}$ , ng/J (lb/MMBtu);

$E_{ho}$  = Hourly  $SO_2$  emission rate, ng/J (lb/MMBtu);

$E_w$  =  $SO_2$  concentration in fuels other than coal and oil combusted in the affected facility, as determined by fuel sampling and analysis procedures in Method 9 of appendix A of this part, ng/J (lb/MMBtu). The value  $E_w$  for each fuel lot is used for each hourly average during the time that the lot is being combusted. The owner or operator does not have to measure  $E_w$  if the owner or operator elects to assume  $E_w = 0$ .

$X_k$  = Fraction of the total heat input from fuel combustion derived from coal and oil, as determined by applicable procedures in Method 19 of appendix A of this part.

(2) The owner or operator of an affected facility that qualifies under the provisions of §60.42c(c) or (d) (where percent reduction is not required) does not have to measure the parameters  $E_w$  or  $X_k$  if the owner or operator of the affected facility elects to measure emission rates of the coal or oil using the fuel sampling and analysis procedures under Method 19 of appendix A of this part.

(f) Affected facilities subject to the percent reduction requirements under §60.42c(a) or (b) shall determine compliance with the  $SO_2$  emission limits under §60.42c pursuant to paragraphs (d) or (e) of this section, and shall determine compliance with the percent reduction requirements using the following procedures:

(1) If only coal is combusted, the percent of potential  $SO_2$  emission rate is computed using the following formula:

$$\%P_s = 100 \left( 1 - \frac{\%R_g}{100} \right) \left( 1 - \frac{\%R_f}{100} \right)$$

Where:

$\%P_s$  = Potential  $SO_2$  emission rate, in percent;

$\%R_g$  =  $SO_2$  removal efficiency of the control device as determined by Method 19 of appendix A of this part, in percent; and

$\%R_f$  =  $SO_2$  removal efficiency of fuel pretreatment as determined by Method 19 of appendix A of this part, in percent.

(2) If coal, oil, or coal and oil are combusted with other fuels, the same procedures required in paragraph (f)(1) of this section are used, except as provided for in the following:

(i) To compute the  $\%P_s$ , an adjusted  $\%R_g$  ( $\%R_{g,o}$ ) is computed from  $E_{ao}$  from paragraph (e)(1) of this section and an adjusted average  $SO_2$  inlet rate ( $E_{ai,o}$ ) using the following formula:

$$\%R_{g,o} = 100 \left( 1 - \frac{E_{ao}}{E_{ai,o}} \right)$$

Where:

$\%R_{g,o}$  = Adjusted  $\%R_g$ , in percent;

$E_{ao}$  = Adjusted  $E_{ao}$ , ng/J (lb/MMBtu); and

$E_{ai,o}$  = Adjusted average  $SO_2$  inlet rate, ng/J (lb/MMBtu).

(ii) To compute  $E_{aiO}$ , an adjusted hourly  $SO_2$  inlet rate ( $E_{hiO}$ ) is used. The  $E_{hiO}$  is computed using the following formula:

$$E_{hiO} = \frac{E_{hi} - E_w(1 - X_k)}{X_k}$$

Where:

$E_{hiO}$  = Adjusted  $E_{hi}$ , ng/J (lb/MMBtu);

$E_{hi}$  = Hourly  $SO_2$  inlet rate, ng/J (lb/MMBtu);

$E_w$  =  $SO_2$  concentration in fuels other than coal and oil combusted in the affected facility, as determined by fuel sampling and analysis procedures in Method 19 of appendix A of this part, ng/J (lb/MMBtu). The value  $E_w$  for each fuel lot is used for each hourly average during the time that the lot is being combusted. The owner or operator does not have to measure  $E_w$  if the owner or operator elects to assume  $E_w = 0$ ; and

$X_k$  = Fraction of the total heat input from fuel combustion derived from coal and oil, as determined by applicable procedures in Method 19 of appendix A of this part.

(g) For oil-fired affected facilities where the owner or operator seeks to demonstrate compliance with the fuel oil sulfur limits under §60.42c based on shipment fuel sampling, the initial performance test shall consist of sampling and analyzing the oil in the initial tank of oil to be fired in the steam generating unit to demonstrate that the oil contains 0.5 weight percent sulfur or less. Thereafter, the owner or operator of the affected facility shall sample the oil in the fuel tank after each new shipment of oil is received, as described under §60.46c(d)(2).

(h) For affected facilities subject to §60.42c(h)(1), (2), or (3) where the owner or operator seeks to demonstrate compliance with the  $SO_2$  standards based on fuel supplier certification, the performance test shall consist of the certification from the fuel supplier, as described in §60.48c(f), as applicable.

(i) The owner or operator of an affected facility seeking to demonstrate compliance with the  $SO_2$  standards under §60.42c(c)(2) shall demonstrate the maximum design heat input capacity of the steam generating unit by operating the steam generating unit at this capacity for 24 hours. This demonstration shall be made during the initial performance test, and a subsequent demonstration may be requested at any other time. If the demonstrated 24-hour average firing rate for the affected facility is less than the maximum design heat input capacity stated by the manufacturer of the affected facility, the demonstrated 24-hour average firing rate shall be used to determine the annual capacity factor for the affected facility; otherwise, the maximum design heat input capacity provided by the manufacturer shall be used.

(j) The owner or operator of an affected facility shall use all valid  $SO_2$  emissions data in calculating  $\%P_s$  and  $E_{ho}$  under paragraphs (d), (e), or (f) of this section, as applicable, whether or not the minimum emissions data requirements under §60.46c(f) are achieved. All valid emissions data, including valid data collected during periods of startup, shutdown, and malfunction, shall be used in calculating  $\%P_s$  or  $E_{ho}$  pursuant to paragraphs (d), (e), or (f) of this section, as applicable.

[72 FR 32759, June 13, 2007, as amended at 74 FR 5091, Jan. 28, 2009]

#### **§60.45c Compliance and performance test methods and procedures for particulate matter.**

(a) The owner or operator of an affected facility subject to the PM and/or opacity standards under §60.43c shall conduct an initial performance test as required under §60.8, and shall conduct subsequent performance tests as requested by the Administrator, to determine compliance with the standards using the following procedures and reference methods, except as specified in paragraph (c) of this section.

(1) Method 1 of appendix A of this part shall be used to select the sampling site and the number of traverse sampling points.

(2) Method 3A or 3B of appendix A-2 of this part shall be used for gas analysis when applying Method 5 or 5B of appendix A-3 of this part or 17 of appendix A-6 of this part.

(3) Method 5, 5B, or 17 of appendix A of this part shall be used to measure the concentration of PM as follows:

(i) Method 5 of appendix A of this part may be used only at affected facilities without wet scrubber systems.

(ii) Method 17 of appendix A of this part may be used at affected facilities with or without wet scrubber systems provided the stack gas temperature does not exceed a temperature of 160 °C (320 °F). The procedures of Sections 8.1 and 11.1 of Method 5B of appendix A of this part may be used in Method 17 of appendix A of this part only if Method 17 of appendix A of this part is used in conjunction with a wet scrubber system. Method 17 of appendix A of this part shall not be used in conjunction with a wet scrubber system if the effluent is saturated or laden with water droplets.

(iii) Method 5B of appendix A of this part may be used in conjunction with a wet scrubber system.

(4) The sampling time for each run shall be at least 120 minutes and the minimum sampling volume shall be 1.7 dry standard cubic meters (dscm) [60 dry standard cubic feet (dscf)] except that smaller sampling times or volumes may be approved by the Administrator when necessitated by process variables or other factors.

(5) For Method 5 or 5B of appendix A of this part, the temperature of the sample gas in the probe and filter holder shall be monitored and maintained at 160 ±14 °C (320±25 °F).

(6) For determination of PM emissions, an oxygen (O<sub>2</sub>) or carbon dioxide (CO<sub>2</sub>) measurement shall be obtained simultaneously with each run of Method 5, 5B, or 17 of appendix A of this part by traversing the duct at the same sampling location.

(7) For each run using Method 5, 5B, or 17 of appendix A of this part, the emission rates expressed in ng/J (lb/MMBtu) heat input shall be determined using:

(i) The O<sub>2</sub> or CO<sub>2</sub> measurements and PM measurements obtained under this section, (ii) The dry basis F factor, and

(iii) The dry basis emission rate calculation procedure contained in Method 19 of appendix A of this part.

(8) Method 9 of appendix A-4 of this part shall be used for determining the opacity of stack emissions.

(b) The owner or operator of an affected facility seeking to demonstrate compliance with the PM standards under §60.43c(b)(2) shall demonstrate the maximum design heat input capacity of the steam generating unit by operating the steam generating unit at this capacity for 24 hours. This demonstration shall be made during the initial performance test, and a subsequent demonstration may be requested at any other time. If the demonstrated 24-hour average firing rate for the affected facility is less than the maximum design heat input capacity stated by the manufacturer of the affected facility, the demonstrated 24-hour average firing rate shall be used to determine the annual capacity factor for the affected facility; otherwise, the maximum design heat input capacity provided by the manufacturer shall be used.

(c) In place of PM testing with Method 5 or 5B of appendix A-3 of this part or Method 17 of appendix A-6 of this part, an owner or operator may elect to install, calibrate, maintain, and operate a CEMS for monitoring PM emissions discharged to the atmosphere and record the output of the system. The owner or operator of an affected facility who elects to continuously monitor PM emissions instead of conducting performance testing using Method 5 or 5B of appendix A-3 of this part or Method 17 of appendix A-6 of this part shall install, calibrate, maintain, and operate a CEMS and shall comply with the requirements specified in paragraphs (c)(1) through (c)(14) of this section.

(1) Notify the Administrator 1 month before starting use of the system.

(2) Notify the Administrator 1 month before stopping use of the system.

(3) The monitor shall be installed, evaluated, and operated in accordance with §60.13 of subpart A of this part.

(4) The initial performance evaluation shall be completed no later than 180 days after the date of initial startup of the affected facility, as specified under §60.8 of subpart A of this part or within 180 days of notification to the Administrator of use of CEMS if the owner or operator was previously determining compliance by Method 5, 5B, or 17 of appendix A of this part performance tests, whichever is later.

(5) The owner or operator of an affected facility shall conduct an initial performance test for PM emissions as required under §60.8 of subpart A of this part. Compliance with the PM emission limit shall be determined by using the CEMS specified in paragraph (d) of this section to measure PM and calculating a 24-hour block arithmetic average emission concentration using EPA Reference Method 19 of appendix A of this part, section 4.1.

(6) Compliance with the PM emission limit shall be determined based on the 24-hour daily (block) average of the hourly arithmetic average emission concentrations using CEMS outlet data.

(7) At a minimum, valid CEMS hourly averages shall be obtained as specified in paragraph (c)(7)(i) of this section for 75 percent of the total operating hours per 30-day rolling average.

(i) At least two data points per hour shall be used to calculate each 1-hour arithmetic average.

(ii) [Reserved]

(8) The 1-hour arithmetic averages required under paragraph (c)(7) of this section shall be expressed in ng/J or lb/MMBtu heat input and shall be used to calculate the boiler operating day daily arithmetic average emission concentrations. The 1-hour arithmetic averages shall be calculated using the data points required under §60.13(e)(2) of subpart A of this part.

(9) All valid CEMS data shall be used in calculating average emission concentrations even if the minimum CEMS data requirements of paragraph (c)(7) of this section are not met.

(10) The CEMS shall be operated according to Performance Specification 11 in appendix B of this part.

(11) During the correlation testing runs of the CEMS required by Performance Specification 11 in appendix B of this part, PM and O<sub>2</sub> (or CO<sub>2</sub>) data shall be collected concurrently (or within a 30- to 60-minute period) by both the continuous emission monitors and performance tests conducted using the following test methods.

(i) For PM, Method 5 or 5B of appendix A-3 of this part or Method 17 of appendix A-6 of this part shall be used; and

(ii) For O<sub>2</sub> (or CO<sub>2</sub>), Method 3A or 3B of appendix A-2 of this part, as applicable shall be used.

(12) Quarterly accuracy determinations and daily calibration drift tests shall be performed in accordance with procedure 2 in appendix F of this part. Relative Response Audit's must be performed annually and Response Correlation Audits must be performed every 3 years.

(13) When PM emissions data are not obtained because of CEMS breakdowns, repairs, calibration checks, and zero and span adjustments, emissions data shall be obtained by using other monitoring systems as approved by the Administrator or EPA Reference Method 19 of appendix A of this part to provide, as necessary, valid emissions data for a minimum of 75 percent of total operating hours on a 30-day rolling average.

(14) As of January 1, 2012, and within 90 days after the date of completing each performance test, as defined in §60.8, conducted to demonstrate compliance with this subpart, you must submit relative accuracy test audit (*i.e.*, reference method) data and performance test (*i.e.*, compliance test) data, except opacity data, electronically to EPA's Central Data Exchange (CDX) by using the Electronic Reporting Tool (ERT) (see [http://www.epa.gov/ttn/chief/ert/ert\\_tool.html/](http://www.epa.gov/ttn/chief/ert/ert_tool.html/)) or other compatible electronic spreadsheet. Only data collected using test methods compatible with ERT are subject to this requirement to be submitted electronically into EPA's WebFIRE database.

(d) The owner or operator of an affected facility seeking to demonstrate compliance under §60.43c(e)(4) shall follow the applicable procedures under §60.48c(f). For residual oil-fired affected facilities, fuel supplier certifications are only allowed for facilities with heat input capacities between 2.9 and 8.7 MW (10 to 30 MMBtu/h).

[72 FR 32759, June 13, 2007, as amended at 74 FR 5091, Jan. 28, 2009; 76 FR 3523, Jan. 20, 2011; 77 FR 9463, Feb. 16, 2012]

#### **§60.46c Emission monitoring for sulfur dioxide.**

(a) Except as provided in paragraphs (d) and (e) of this section, the owner or operator of an affected facility subject to the SO<sub>2</sub> emission limits under §60.42c shall install, calibrate, maintain, and operate a CEMS for measuring SO<sub>2</sub> concentrations and either O<sub>2</sub> or CO<sub>2</sub> concentrations at the outlet of the SO<sub>2</sub> control device (or the outlet of the steam generating unit if no SO<sub>2</sub> control device is used), and shall record the output of the system. The owner or operator of an affected facility subject to the percent reduction requirements under §60.42c shall measure SO<sub>2</sub> concentrations and either O<sub>2</sub> or CO<sub>2</sub> concentrations at both the inlet and outlet of the SO<sub>2</sub> control device.

(b) The 1-hour average SO<sub>2</sub> emission rates measured by a CEMS shall be expressed in ng/J or lb/MMBtu heat input and shall be used to calculate the average emission rates under §60.42c. Each 1-hour average SO<sub>2</sub> emission rate must be based on at least 30 minutes of operation, and shall be calculated using the data points required under §60.13(h)(2). Hourly SO<sub>2</sub> emission rates are not calculated if the affected facility is operated less than 30 minutes in a 1-hour period and are not counted toward determination of a steam generating unit operating day.

(c) The procedures under §60.13 shall be followed for installation, evaluation, and operation of the CEMS.

(1) All CEMS shall be operated in accordance with the applicable procedures under Performance Specifications 1, 2, and 3 of appendix B of this part.

(2) Quarterly accuracy determinations and daily calibration drift tests shall be performed in accordance with Procedure 1 of appendix F of this part.

(3) For affected facilities subject to the percent reduction requirements under §60.42c, the span value of the SO<sub>2</sub> CEMS at the inlet to the SO<sub>2</sub> control device shall be 125 percent of the maximum estimated hourly potential SO<sub>2</sub> emission rate of the fuel combusted, and the span value of the SO<sub>2</sub> CEMS at the outlet from the SO<sub>2</sub> control device shall be 50 percent of the maximum estimated hourly potential SO<sub>2</sub> emission rate of the fuel combusted.

(4) For affected facilities that are not subject to the percent reduction requirements of §60.42c, the span value of the SO<sub>2</sub> CEMS at the outlet from the SO<sub>2</sub> control device (or outlet of the steam generating unit if no SO<sub>2</sub> control device is used) shall be 125 percent of the maximum estimated hourly potential SO<sub>2</sub> emission rate of the fuel combusted.

(d) As an alternative to operating a CEMS at the inlet to the SO<sub>2</sub> control device (or outlet of the steam generating unit if no SO<sub>2</sub> control device is used) as required under paragraph (a) of this section, an owner or operator may elect to determine the average SO<sub>2</sub> emission rate by sampling the fuel prior to combustion. As an alternative to operating a CEMS at the outlet from the SO<sub>2</sub> control device (or outlet of the steam generating unit if no SO<sub>2</sub> control device is used) as required under paragraph (a) of this section, an owner or operator may elect to determine the average SO<sub>2</sub> emission rate by using Method 6B of appendix A of this part. Fuel sampling shall be conducted pursuant to either paragraph (d)(1) or (d)(2) of this section. Method 6B of appendix A of this part shall be conducted pursuant to paragraph (d)(3) of this section.

(1) For affected facilities combusting coal or oil, coal or oil samples shall be collected daily in an as-fired condition at the inlet to the steam generating unit and analyzed for sulfur content and heat content according to the Method 19 of appendix A of this part. Method 19 of appendix A of this part provides procedures for converting these measurements into the format to be used in calculating the average SO<sub>2</sub> input rate.

(2) As an alternative fuel sampling procedure for affected facilities combusting oil, oil samples may be collected from the fuel tank for each steam generating unit immediately after the fuel tank is filled and before any oil is combusted. The owner or operator of the affected facility shall analyze the oil sample to determine the sulfur content of the oil. If a partially empty fuel tank is refilled, a new sample and analysis of the fuel in the tank would be required upon filling. Results of the fuel analysis taken after each new shipment of oil is received shall be used as the daily value when calculating the 30-day rolling average until the next shipment is received. If the fuel analysis shows that the sulfur content in the fuel tank is greater than 0.5 weight percent sulfur, the owner or operator shall ensure that the sulfur content of subsequent oil shipments is low enough to cause the 30-day rolling average sulfur content to be 0.5 weight percent sulfur or less.

(3) Method 6B of appendix A of this part may be used in lieu of CEMS to measure SO<sub>2</sub> at the inlet or outlet of the SO<sub>2</sub> control system. An initial stratification test is required to verify the adequacy of the Method 6B of appendix A of this part sampling location. The stratification test shall consist of three paired runs of a suitable SO<sub>2</sub> and CO<sub>2</sub> measurement train operated at the candidate location and a second similar train operated according to the procedures in §3.2 and the applicable procedures in section 7 of Performance Specification 2 of appendix B of this part. Method 6B of appendix A of this part, Method 6A of appendix A of this part, or a combination of Methods 6 and 3 of appendix A of this part or Methods 6C and 3A of appendix A of this part are suitable measurement techniques. If Method 6B of appendix A of this part is used for the second train, sampling time and timer operation may be adjusted for the stratification test as long as an adequate sample volume is collected; however, both sampling trains are to be operated similarly. For the location to be adequate for Method 6B of appendix A of this part 24-hour tests, the mean of the absolute difference between the three paired runs must be less than 10 percent (0.10).



(e) The monitoring requirements of paragraphs (a) and (d) of this section shall not apply to affected facilities subject to §60.42c(h) (1), (2), or (3) where the owner or operator of the affected facility seeks to demonstrate compliance with the SO<sub>2</sub> standards based on fuel supplier certification, as described under §60.48c(f), as applicable.

(f) The owner or operator of an affected facility operating a CEMS pursuant to paragraph (a) of this section, or conducting as-fired fuel sampling pursuant to paragraph (d)(1) of this section, shall obtain emission data for at least 75 percent of the operating hours in at least 22 out of 30 successive steam generating unit operating days. If this minimum data requirement is not met with a single monitoring system, the owner or operator of the affected facility shall supplement the emission data with data collected with other monitoring systems as approved by the Administrator.

#### **§60.47c Emission monitoring for particulate matter.**

(a) Except as provided in paragraphs (c), (d), (e), and (f) of this section, the owner or operator of an affected facility combusting coal, oil, or wood that is subject to the opacity standards under §60.43c shall install, calibrate, maintain, and operate a continuous opacity monitoring system (COMS) for measuring the opacity of the emissions discharged to the atmosphere and record the output of the system. The owner or operator of an affected facility subject to an opacity standard in §60.43c(c) that is not required to use a COMS due to paragraphs (c), (d), (e), or (f) of this section that elects not to use a COMS shall conduct a performance test using Method 9 of appendix A-4 of this part and the procedures in §60.11 to demonstrate compliance with the applicable limit in §60.43c by April 29, 2011, within 45 days of stopping use of an existing COMS, or within 180 days after initial startup of the facility, whichever is later, and shall comply with either paragraphs (a)(1), (a)(2), or (a)(3) of this section. The observation period for Method 9 of appendix A-4 of this part performance tests may be reduced from 3 hours to 60 minutes if all 6-minute averages are less than 10 percent and all individual 15-second observations are less than or equal to 20 percent during the initial 60 minutes of observation.

(1) Except as provided in paragraph (a)(2) and (a)(3) of this section, the owner or operator shall conduct subsequent Method 9 of appendix A-4 of this part performance tests using the procedures in paragraph (a) of this section according to the applicable schedule in paragraphs (a)(1)(i) through (a)(1)(iv) of this section, as determined by the most recent Method 9 of appendix A-4 of this part performance test results.

(i) If no visible emissions are observed, a subsequent Method 9 of appendix A-4 of this part performance test must be completed within 12 calendar months from the date that the most recent performance test was conducted or within 45 days of the next day that fuel with an opacity standard is combusted, whichever is later;

(ii) If visible emissions are observed but the maximum 6-minute average opacity is less than or equal to 5 percent, a subsequent Method 9 of appendix A-4 of this part performance test must be completed within 6 calendar months from the date that the most recent performance test was conducted or within 45 days of the next day that fuel with an opacity standard is combusted, whichever is later;

(iii) If the maximum 6-minute average opacity is greater than 5 percent but less than or equal to 10 percent, a subsequent Method 9 of appendix A-4 of this part performance test must be completed within 3 calendar months from the date that the most recent performance test was conducted or within 45 days of the next day that fuel with an opacity standard is combusted, whichever is later; or

(iv) If the maximum 6-minute average opacity is greater than 10 percent, a subsequent Method 9 of appendix A-4 of this part performance test must be completed within 45 calendar days from the date that the most recent performance test was conducted.

(2) If the maximum 6-minute opacity is less than 10 percent during the most recent Method 9 of appendix A-4 of this part performance test, the owner or operator may, as an alternative to performing subsequent Method 9 of appendix A-4 of this part performance tests, elect to perform subsequent monitoring using Method 22 of appendix A-7 of this part according to the procedures specified in paragraphs (a)(2)(i) and (ii) of this section.

(i) The owner or operator shall conduct 10 minute observations (during normal operation) each operating day the affected facility fires fuel for which an opacity standard is applicable using Method 22 of appendix A-7 of this part and demonstrate that the sum of the occurrences of any visible emissions is not in excess of 5 percent of the observation period (*i.e.*, 30 seconds per 10 minute period). If the sum of the occurrence of any visible emissions is greater than 30 seconds during the initial 10 minute observation, immediately conduct a 30 minute observation. If the sum of the occurrence of visible emissions is greater than 5 percent of the observation period (*i.e.*, 90 seconds per 30 minute period), the owner or operator shall either document and adjust the operation of the facility and demonstrate within 24 hours that the sum of the occurrence of visible emissions is equal to or less than 5 percent during a 30 minute observation (*i.e.*, 90 seconds) or conduct a new Method 9 of appendix A-4 of this part performance test using the procedures in paragraph (a) of this section within 45 calendar days according to the requirements in §60.45c(a)(8).

(ii) If no visible emissions are observed for 10 operating days during which an opacity standard is applicable, observations can be reduced to once every 7 operating days during which an opacity standard is applicable. If any visible emissions are observed, daily observations shall be resumed.

(3) If the maximum 6-minute opacity is less than 10 percent during the most recent Method 9 of appendix A-4 of this part performance test, the owner or operator may, as an alternative to performing subsequent Method 9 of appendix A-4 performance tests, elect to perform subsequent monitoring using a digital opacity compliance system according to a site-specific monitoring plan approved by the Administrator. The observations shall be similar, but not necessarily identical, to the requirements in paragraph (a)(2) of this section. For reference purposes in preparing the monitoring plan, see OAQPS "Determination of Visible Emission Opacity from Stationary Sources Using Computer-Based Photographic Analysis Systems." This document is available from the U.S. Environmental Protection Agency (U.S. EPA); Office of Air Quality and Planning Standards; Sector Policies and Programs Division; Measurement Policy Group (D243-02), Research Triangle Park, NC 27711. This document is also available on the Technology Transfer Network (TTN) under Emission Measurement Center Preliminary Methods.

(b) All COMS shall be operated in accordance with the applicable procedures under Performance Specification 1 of appendix B of this part. The span value of the opacity COMS shall be between 60 and 80 percent.

(c) Owners and operators of an affected facilities that burn only distillate oil that contains no more than 0.5 weight percent sulfur and/or liquid or gaseous fuels with potential sulfur dioxide emission rates of 26 ng/J (0.060 lb/MMBtu) heat input or less and that do not use a post-combustion technology to reduce SO<sub>2</sub> or PM emissions and that are subject to an opacity standard in §60.43c(c) are not required to operate a COMS if they follow the applicable procedures in §60.48c(f).

(d) Owners or operators complying with the PM emission limit by using a PM CEMS must calibrate, maintain, operate, and record the output of the system for PM emissions discharged to the atmosphere as specified in §60.45c(c). The CEMS specified in paragraph §60.45c(c) shall be operated and data recorded during all periods of operation of the affected facility except for CEMS breakdowns and repairs. Data is recorded during calibration checks, and zero and span adjustments.

(e) Owners and operators of an affected facility that is subject to an opacity standard in §60.43c(c) and that does not use post-combustion technology (except a wet scrubber) for reducing PM, SO<sub>2</sub>, or carbon monoxide (CO) emissions, burns only gaseous fuels or fuel oils that contain less than or equal to

0.5 weight percent sulfur, and is operated such that emissions of CO discharged to the atmosphere from the affected facility are maintained at levels less than or equal to 0.15 lb/MMBtu on a boiler operating day average basis is not required to operate a COMS. Owners and operators of affected facilities electing to comply with this paragraph must demonstrate compliance according to the procedures specified in paragraphs (e)(1) through (4) of this section; or

(1) You must monitor CO emissions using a CEMS according to the procedures specified in paragraphs (e)(1)(i) through (iv) of this section.

(i) The CO CEMS must be installed, certified, maintained, and operated according to the provisions in §60.58b(i)(3) of subpart Eb of this part.

(ii) Each 1-hour CO emissions average is calculated using the data points generated by the CO CEMS expressed in parts per million by volume corrected to 3 percent oxygen (dry basis).

(iii) At a minimum, valid 1-hour CO emissions averages must be obtained for at least 90 percent of the operating hours on a 30-day rolling average basis. The 1-hour averages are calculated using the data points required in §60.13(h)(2).

(iv) Quarterly accuracy determinations and daily calibration drift tests for the CO CEMS must be performed in accordance with procedure 1 in appendix F of this part.

(2) You must calculate the 1-hour average CO emissions levels for each steam generating unit operating day by multiplying the average hourly CO output concentration measured by the CO CEMS times the corresponding average hourly flue gas flow rate and divided by the corresponding average hourly heat input to the affected source. The 24-hour average CO emission level is determined by calculating the arithmetic average of the hourly CO emission levels computed for each steam generating unit operating day.

(3) You must evaluate the preceding 24-hour average CO emission level each steam generating unit operating day excluding periods of affected source startup, shutdown, or malfunction. If the 24-hour average CO emission level is greater than 0.15 lb/MMBtu, you must initiate investigation of the relevant equipment and control systems within 24 hours of the first discovery of the high emission incident and, take the appropriate corrective action as soon as practicable to adjust control settings or repair equipment to reduce the 24-hour average CO emission level to 0.15 lb/MMBtu or less.

(4) You must record the CO measurements and calculations performed according to paragraph (e) of this section and any corrective actions taken. The record of corrective action taken must include the date and time during which the 24-hour average CO emission level was greater than 0.15 lb/MMBtu, and the date, time, and description of the corrective action.

(f) An owner or operator of an affected facility that is subject to an opacity standard in §60.43c(c) is not required to operate a COMS provided that the affected facility meets the conditions in either paragraphs (f)(1), (2), or (3) of this section.

(1) The affected facility uses a fabric filter (baghouse) as the primary PM control device and, the owner or operator operates a bag leak detection system to monitor the performance of the fabric filter according to the requirements in section §60.48Da of this part.

(2) The affected facility uses an ESP as the primary PM control device, and the owner or operator uses an ESP predictive model to monitor the performance of the ESP developed in accordance and operated according to the requirements in section §60.48Da of this part.

(3) The affected facility burns only gaseous fuels and/or fuel oils that contain no greater than 0.5 weight percent sulfur, and the owner or operator operates the unit according to a written site-specific monitoring plan approved by the permitting authority. This monitoring plan must include procedures and criteria for establishing and monitoring specific parameters for the affected facility indicative of compliance with the opacity standard. For testing performed as part of this site-specific monitoring plan, the permitting authority may require as an alternative to the notification and reporting requirements specified in §§60.8 and 60.11 that the owner or operator submit any deviations with the excess emissions report required under §60.48c(c).

[72 FR 32759, June 13, 2007, as amended at 74 FR 5091, Jan. 28, 2009; 76 FR 3523, Jan. 20, 2011; 77 FR 9463, Feb. 16, 2012]

#### **§60.48c Reporting and recordkeeping requirements.**

(a) The owner or operator of each affected facility shall submit notification of the date of construction or reconstruction and actual startup, as provided by §60.7 of this part. This notification shall include:

(1) The design heat input capacity of the affected facility and identification of fuels to be combusted in the affected facility.

(2) If applicable, a copy of any federally enforceable requirement that limits the annual capacity factor for any fuel or mixture of fuels under §60.42c, or §60.43c.

(3) The annual capacity factor at which the owner or operator anticipates operating the affected facility based on all fuels fired and based on each individual fuel fired.

(4) Notification if an emerging technology will be used for controlling SO<sub>2</sub> emissions. The Administrator will examine the description of the control device and will determine whether the technology qualifies as an emerging technology. In making this determination, the Administrator may require the owner or operator of the affected facility to submit additional information concerning the control device. The affected facility is subject to the provisions of §60.42c(a) or (b)(1), unless and until this determination is made by the Administrator.

(b) The owner or operator of each affected facility subject to the SO<sub>2</sub> emission limits of §60.42c, or the PM or opacity limits of §60.43c, shall submit to the Administrator the performance test data from the initial and any subsequent performance tests and, if applicable, the performance evaluation of the CEMS and/or COMS using the applicable performance specifications in appendix B of this part.

(c) In addition to the applicable requirements in §60.7, the owner or operator of an affected facility subject to the opacity limits in §60.43c(c) shall submit excess emission reports for any excess emissions from the affected facility that occur during the reporting period and maintain records according to the requirements specified in paragraphs (c)(1) through (3) of this section, as applicable to the visible emissions monitoring method used.

(1) For each performance test conducted using Method 9 of appendix A-4 of this part, the owner or operator shall keep the records including the information specified in paragraphs (c)(1)(i) through (iii) of this section.

(i) Dates and time intervals of all opacity observation periods;

(ii) Name, affiliation, and copy of current visible emission reading certification for each visible emission observer participating in the performance test; and

(iii) Copies of all visible emission observer opacity field data sheets;

(2) For each performance test conducted using Method 22 of appendix A-4 of this part, the owner or operator shall keep the records including the information specified in paragraphs (c)(2)(i) through (iv) of this section.

(i) Dates and time intervals of all visible emissions observation periods;

(ii) Name and affiliation for each visible emission observer participating in the performance test;

(iii) Copies of all visible emission observer opacity field data sheets; and

(iv) Documentation of any adjustments made and the time the adjustments were completed to the affected facility operation by the owner or operator to demonstrate compliance with the applicable monitoring requirements.

(3) For each digital opacity compliance system, the owner or operator shall maintain records and submit reports according to the requirements specified in the site-specific monitoring plan approved by the Administrator

(d) The owner or operator of each affected facility subject to the SO<sub>2</sub> emission limits, fuel oil sulfur limits, or percent reduction requirements under §60.42c shall submit reports to the Administrator.

(e) The owner or operator of each affected facility subject to the SO<sub>2</sub> emission limits, fuel oil sulfur limits, or percent reduction requirements under §60.42c shall keep records and submit reports as required under paragraph (d) of this section, including the following information, as applicable.

(1) Calendar dates covered in the reporting period.

(2) Each 30-day average SO<sub>2</sub> emission rate (ng/J or lb/MMBtu), or 30-day average sulfur content (weight percent), calculated during the reporting period, ending with the last 30-day period; reasons for any noncompliance with the emission standards; and a description of corrective actions taken.

(3) Each 30-day average percent of potential SO<sub>2</sub> emission rate calculated during the reporting period, ending with the last 30-day period; reasons for any noncompliance with the emission standards; and a description of the corrective actions taken.

(4) Identification of any steam generating unit operating days for which SO<sub>2</sub> or diluent (O<sub>2</sub> or CO<sub>2</sub>) data have not been obtained by an approved method for at least 75 percent of the operating hours; justification for not obtaining sufficient data; and a description of corrective actions taken.

(5) Identification of any times when emissions data have been excluded from the calculation of average emission rates; justification for excluding data; and a description of corrective actions taken if data have been excluded for periods other than those during which coal or oil were not combusted in the steam generating unit.

(6) Identification of the F factor used in calculations, method of determination, and type of fuel combusted.

(7) Identification of whether averages have been obtained based on CEMS rather than manual sampling methods.

(8) If a CEMS is used, identification of any times when the pollutant concentration exceeded the full span of the CEMS.

(9) If a CEMS is used, description of any modifications to the CEMS that could affect the ability of the CEMS to comply with Performance Specifications 2 or 3 of appendix B of this part.

(10) If a CEMS is used, results of daily CEMS drift tests and quarterly accuracy assessments as required under appendix F, Procedure 1 of this part.

(11) If fuel supplier certification is used to demonstrate compliance, records of fuel supplier certification as described under paragraph (f)(1), (2), (3), or (4) of this section, as applicable. In addition to records of fuel supplier certifications, the report shall include a certified statement signed by the owner or operator of the affected facility that the records of fuel supplier certifications submitted represent all of the fuel combusted during the reporting period.

(f) Fuel supplier certification shall include the following information:

(1) For distillate oil:

(i) The name of the oil supplier;

(ii) A statement from the oil supplier that the oil complies with the specifications under the definition of distillate oil in §60.41c; and

(iii) The sulfur content or maximum sulfur content of the oil.

(2) For residual oil:

(i) The name of the oil supplier;

(ii) The location of the oil when the sample was drawn for analysis to determine the sulfur content of the oil, specifically including whether the oil was sampled as delivered to the affected facility, or whether the sample was drawn from oil in storage at the oil supplier's or oil refiner's facility, or other location;

(iii) The sulfur content of the oil from which the shipment came (or of the shipment itself); and

(iv) The method used to determine the sulfur content of the oil.

(3) For coal:

(i) The name of the coal supplier;

(ii) The location of the coal when the sample was collected for analysis to determine the properties of the coal, specifically including whether the coal was sampled as delivered to the affected facility or whether the sample was collected from coal in storage at the mine, at a coal preparation plant, at a coal supplier's facility, or at another location. The certification shall include the name of the coal mine (and coal seam), coal storage facility, or coal preparation plant (where the sample was collected);

(iii) The results of the analysis of the coal from which the shipment came (or of the shipment itself) including the sulfur content, moisture content, ash content, and heat content; and

(iv) The methods used to determine the properties of the coal.

(4) For other fuels:

(i) The name of the supplier of the fuel;

(ii) The potential sulfur emissions rate or maximum potential sulfur emissions rate of the fuel in ng/J heat input; and

(iii) The method used to determine the potential sulfur emissions rate of the fuel.

(g)(1) Except as provided under paragraphs (g)(2) and (g)(3) of this section, the owner or operator of each affected facility shall record and maintain records of the amount of each fuel combusted during each operating day.

(2) As an alternative to meeting the requirements of paragraph (g)(1) of this section, the owner or operator of an affected facility that combusts only natural gas, wood, fuels using fuel certification in §60.48c(f) to demonstrate compliance with the SO<sub>2</sub> standard, fuels not subject to an emissions standard (excluding opacity), or a mixture of these fuels may elect to record and maintain records of the amount of each fuel combusted during each calendar month.

(3) As an alternative to meeting the requirements of paragraph (g)(1) of this section, the owner or operator of an affected facility or multiple affected facilities located on a contiguous property unit where the only fuels combusted in any steam generating unit (including steam generating units not subject to this subpart) at that property are natural gas, wood, distillate oil meeting the most current requirements in §60.42C to use fuel certification to demonstrate compliance with the SO<sub>2</sub> standard, and/or fuels, excluding coal and residual oil, not subject to an emissions standard (excluding opacity) may elect to record and maintain records of the total amount of each steam generating unit fuel delivered to that property during each calendar month.

(h) The owner or operator of each affected facility subject to a federally enforceable requirement limiting the annual capacity factor for any fuel or mixture of fuels under §60.42c or §60.43c shall calculate the annual capacity factor individually for each fuel combusted. The annual capacity factor is determined on a 12-month rolling average basis with a new annual capacity factor calculated at the end of the calendar month.

(i) All records required under this section shall be maintained by the owner or operator of the affected facility for a period of two years following the date of such record.

(j) The reporting period for the reports required under this subpart is each six-month period. All reports shall be submitted to the Administrator and shall be postmarked by the 30th day following the end of the reporting period.

[72 FR 32759, June 13, 2007, as amended at 74 FR 5091, Jan. 28, 2009]

**Appendix B**

40 C.F.R. Part 60, Subpart Kb – *Standards of Performance for Volatile Organic Liquid Storage Vessels*



SOURCE: 52 FR 11429, Apr. 8, 1987, unless otherwise noted.

**§60.110b Applicability and designation of affected facility.**

(a) Except as provided in paragraph (b) of this section, the affected facility to which this subpart applies is each storage vessel with a capacity greater than or equal to 75 cubic meters (m<sup>3</sup>) that is used to store volatile organic liquids (VOL) for which construction, reconstruction, or modification is commenced after July 23, 1984.

(b) This subpart does not apply to storage vessels with a capacity greater than or equal to 151 m<sup>3</sup> storing a liquid with a maximum true vapor pressure less than 3.5 kilopascals (kPa) or with a capacity greater than or equal to 75 m<sup>3</sup> but less than 151 m<sup>3</sup> storing a liquid with a maximum true vapor pressure less than 15.0 kPa.

(c) [Reserved]

(d) This subpart does not apply to the following:

(1) Vessels at coke oven by-product plants.

(2) Pressure vessels designed to operate in excess of 204.9 kPa and without emissions to the atmosphere.

(3) Vessels permanently attached to mobile vehicles such as trucks, railcars, barges, or ships.

(4) Vessels with a design capacity less than or equal to 1,589.874 m<sup>3</sup> used for petroleum or condensate stored, processed, or treated prior to custody transfer.

(5) Vessels located at bulk gasoline plants.

(6) Storage vessels located at gasoline service stations.

(7) Vessels used to store beverage alcohol.

(8) Vessels subject to subpart GGGG of 40 CFR part 63.

(e) *Alternative means of compliance—(1) Option to comply with part 65.* Owners or operators may choose to comply with 40 CFR part 65, subpart C, to satisfy the requirements of §§60.112b through 60.117b for storage vessels that are subject to this subpart that meet the specifications in paragraphs (e)(1)(i) and (ii) of this section. When choosing to comply with 40 CFR part 65, subpart C, the monitoring requirements of §60.116b(c), (e), (f)(1), and (g) still apply. Other provisions applying to owners or operators who choose to comply with 40 CFR part 65 are provided in 40 CFR 65.1.

(i) A storage vessel with a design capacity greater than or equal to 151 m<sup>3</sup> containing a VOL that, as stored, has a maximum true vapor pressure equal to or greater than 5.2 kPa; or

(ii) A storage vessel with a design capacity greater than 75 m<sup>3</sup> but less than 151 m<sup>3</sup> containing a VOL that, as stored, has a maximum true vapor pressure equal to or greater than 27.6 kPa.

(2) *Part 60, subpart A.* Owners or operators who choose to comply with 40 CFR part 65, subpart C, must also comply with §§60.1, 60.2, 60.5, 60.6, 60.7(a)(1) and (4), 60.14, 60.15, and 60.16 for those storage vessels. All sections and paragraphs of subpart A of this part that are not mentioned in this paragraph (e)(2) do not apply to owners or operators of storage vessels complying with 40 CFR part 65, subpart C, except that provisions required to be met prior to implementing 40 CFR part 65 still apply. Owners and operators who choose to comply with 40 CFR part 65, subpart C, must comply with 40 CFR part 65, subpart A.

(3) *Internal floating roof report.* If an owner or operator installs an internal floating roof and, at initial startup, chooses to comply with 40 CFR part 65, subpart C, a report shall be furnished to the Administrator stating that the control equipment meets the specifications of 40 CFR 65.43. This report shall be an attachment to the notification required by 40 CFR 65.5(b).

(4) *External floating roof report.* If an owner or operator installs an external floating roof and, at initial startup, chooses to comply with 40 CFR part 65, subpart C, a report shall be furnished to the Administrator stating that the control equipment meets the specifications of 40 CFR 65.44. This report shall be an attachment to the notification required by 40 CFR 65.5(b).

[52 FR 11429, Apr. 8, 1987, as amended at 54 FR 32973, Aug. 11, 1989; 65 FR 78275, Dec. 14, 2000; 68 FR 59332, Oct. 15, 2003]

#### **§60.111b Definitions.**

Terms used in this subpart are defined in the Act, in subpart A of this part, or in this subpart as follows:

*Bulk gasoline plant* means any gasoline distribution facility that has a gasoline throughput less than or equal to 75,700 liters per day. Gasoline throughput shall be the maximum calculated design throughput as may be limited by compliance with an enforceable condition under Federal requirement or Federal, State or local law, and discoverable by the Administrator and any other person.

*Condensate* means hydrocarbon liquid separated from natural gas that condenses due to changes in the temperature or pressure, or both, and remains liquid at standard conditions.

*Custody transfer* means the transfer of produced petroleum and/or condensate, after processing and/or treatment in the producing operations, from storage vessels or automatic transfer facilities to pipelines or any other forms of transportation.

*Fill* means the introduction of VOL into a storage vessel but not necessarily to complete capacity.

*Gasoline service station* means any site where gasoline is dispensed to motor vehicle fuel tanks from stationary storage tanks.

*Maximum true vapor pressure* means the equilibrium partial pressure exerted by the volatile organic compounds (as defined in 40 CFR 51.100) in the stored VOL at the temperature equal to the highest calendar-month average of the VOL storage temperature for VOL's stored above or below the ambient temperature or at the local maximum monthly average temperature as reported by the National Weather Service for VOL's stored at the ambient temperature, as determined:

(1) In accordance with methods described in American Petroleum Institute Bulletin 2517, Evaporation Loss From External Floating Roof Tanks, (incorporated by reference—see §60.17); or

(2) As obtained from standard reference texts; or

(3) As determined by ASTM D2879-83, 96, or 97 (incorporated by reference—see §60.17);

(4) Any other method approved by the Administrator.

*Petroleum* means the crude oil removed from the earth and the oils derived from tar sands, shale, and coal.

*Petroleum liquids* means petroleum, condensate, and any finished or intermediate products manufactured in a petroleum refinery.

*Process tank* means a tank that is used within a process (including a solvent or raw material recovery process) to collect material discharged from a feedstock storage vessel or equipment within the process before the material is transferred to other equipment within the process, to a product or by-product storage vessel, or to a vessel used to store recovered solvent or raw material. In many process tanks, unit operations such as reactions and blending are conducted. Other process tanks, such as surge control vessels and bottoms receivers, however, may not involve unit operations.

*Reid vapor pressure* means the absolute vapor pressure of volatile crude oil and volatile nonviscous petroleum liquids except liquified petroleum gases, as determined by ASTM D323-82 or 94 (incorporated by reference—see §60.17).

*Storage vessel* means each tank, reservoir, or container used for the storage of volatile organic liquids but does not include:

(1) Frames, housing, auxiliary supports, or other components that are not directly involved in the containment of liquids or vapors;

(2) Subsurface caverns or porous rock reservoirs; or

(3) Process tanks.

*Volatile organic liquid (VOL)* means any organic liquid which can emit volatile organic compounds (as defined in 40 CFR 51.100) into the atmosphere.

*Waste* means any liquid resulting from industrial, commercial, mining or agricultural operations, or from community activities that is discarded or is being accumulated, stored, or physically, chemically, or biologically treated prior to being discarded or recycled.

[52 FR 11429, Apr. 8, 1987, as amended at 54 FR 32973, Aug. 11, 1989; 65 FR 61756, Oct. 17, 2000; 68 FR 59333, Oct. 15, 2003]

#### **§60.112b Standard for volatile organic compounds (VOC).**

(a) The owner or operator of each storage vessel either with a design capacity greater than or equal to 151 m<sup>3</sup> containing a VOL that, as stored, has a maximum true vapor pressure equal to or greater than 5.2 kPa but less than 76.6 kPa or with a design capacity greater than or equal to 75 m<sup>3</sup> but less than 151 m<sup>3</sup> containing a VOL that, as stored, has a maximum true vapor pressure equal to or greater than 27.6 kPa but less than 76.6 kPa, shall equip each storage vessel with one of the following:

(1) A fixed roof in combination with an internal floating roof meeting the following specifications:

(i) The internal floating roof shall rest or float on the liquid surface (but not necessarily in complete contact with it) inside a storage vessel that has a fixed roof. The internal floating roof shall be floating on

the liquid surface at all times, except during initial fill and during those intervals when the storage vessel is completely emptied or subsequently emptied and refilled. When the roof is resting on the leg supports, the process of filling, emptying, or refilling shall be continuous and shall be accomplished as rapidly as possible.

(ii) Each internal floating roof shall be equipped with one of the following closure devices between the wall of the storage vessel and the edge of the internal floating roof:

(A) A foam- or liquid-filled seal mounted in contact with the liquid (liquid-mounted seal). A liquid-mounted seal means a foam- or liquid-filled seal mounted in contact with the liquid between the wall of the storage vessel and the floating roof continuously around the circumference of the tank.

(B) Two seals mounted one above the other so that each forms a continuous closure that completely covers the space between the wall of the storage vessel and the edge of the internal floating roof. The lower seal may be vapor-mounted, but both must be continuous.

(C) A mechanical shoe seal. A mechanical shoe seal is a metal sheet held vertically against the wall of the storage vessel by springs or weighted levers and is connected by braces to the floating roof. A flexible coated fabric (envelope) spans the annular space between the metal sheet and the floating roof.

(iii) Each opening in a noncontact internal floating roof except for automatic bleeder vents (vacuum breaker vents) and the rim space vents is to provide a projection below the liquid surface.

(iv) Each opening in the internal floating roof except for leg sleeves, automatic bleeder vents, rim space vents, column wells, ladder wells, sample wells, and stub drains is to be equipped with a cover or lid which is to be maintained in a closed position at all times (i.e., no visible gap) except when the device is in actual use. The cover or lid shall be equipped with a gasket. Covers on each access hatch and automatic gauge float well shall be bolted except when they are in use.

(v) Automatic bleeder vents shall be equipped with a gasket and are to be closed at all times when the roof is floating except when the roof is being floated off or is being landed on the roof leg supports.

(vi) Rim space vents shall be equipped with a gasket and are to be set to open only when the internal floating roof is not floating or at the manufacturer's recommended setting.

(vii) Each penetration of the internal floating roof for the purpose of sampling shall be a sample well. The sample well shall have a slit fabric cover that covers at least 90 percent of the opening.

(viii) Each penetration of the internal floating roof that allows for passage of a column supporting the fixed roof shall have a flexible fabric sleeve seal or a gasketed sliding cover.

(ix) Each penetration of the internal floating roof that allows for passage of a ladder shall have a gasketed sliding cover.

(2) An external floating roof. An external floating roof means a pontoon-type or double-deck type cover that rests on the liquid surface in a vessel with no fixed roof. Each external floating roof must meet the following specifications:

(i) Each external floating roof shall be equipped with a closure device between the wall of the storage vessel and the roof edge. The closure device is to consist of two seals, one above the other. The lower seal is referred to as the primary seal, and the upper seal is referred to as the secondary seal.

(A) The primary seal shall be either a mechanical shoe seal or a liquid-mounted seal. Except as provided in §60.113b(b)(4), the seal shall completely cover the annular space between the edge of the floating roof and tank wall.

(B) The secondary seal shall completely cover the annular space between the external floating roof and the wall of the storage vessel in a continuous fashion except as allowed in §60.113b(b)(4).

(ii) Except for automatic bleeder vents and rim space vents, each opening in a noncontact external floating roof shall provide a projection below the liquid surface. Except for automatic bleeder vents, rim space vents, roof drains, and leg sleeves, each opening in the roof is to be equipped with a gasketed cover, seal, or lid that is to be maintained in a closed position at all times (i.e., no visible gap) except when the device is in actual use. Automatic bleeder vents are to be closed at all times when the roof is floating except when the roof is being floated off or is being landed on the roof leg supports. Rim vents are to be set to open when the roof is being floated off the roof legs supports or at the manufacturer's recommended setting. Automatic bleeder vents and rim space vents are to be gasketed. Each emergency roof drain is to be provided with a slotted membrane fabric cover that covers at least 90 percent of the area of the opening.

(iii) The roof shall be floating on the liquid at all times (i.e., off the roof leg supports) except during initial fill until the roof is lifted off leg supports and when the tank is completely emptied and subsequently refilled. The process of filling, emptying, or refilling when the roof is resting on the leg supports shall be continuous and shall be accomplished as rapidly as possible.

(3) A closed vent system and control device meeting the following specifications:

(i) The closed vent system shall be designed to collect all VOC vapors and gases discharged from the storage vessel and operated with no detectable emissions as indicated by an instrument reading of less than 500 ppm above background and visual inspections, as determined in part 60, subpart VV, §60.485(b).

(ii) The control device shall be designed and operated to reduce inlet VOC emissions by 95 percent or greater. If a flare is used as the control device, it shall meet the specifications described in the general control device requirements (§60.18) of the General Provisions.

(4) A system equivalent to those described in paragraphs (a)(1), (a)(2), or (a)(3) of this section as provided in §60.114b of this subpart.

(b) The owner or operator of each storage vessel with a design capacity greater than or equal to 75 m<sup>3</sup> which contains a VOL that, as stored, has a maximum true vapor pressure greater than or equal to 76.6 kPa shall equip each storage vessel with one of the following:

(1) A closed vent system and control device as specified in §60.112b(a)(3).

(2) A system equivalent to that described in paragraph (b)(1) as provided in §60.114b of this subpart.

(c) *Site-specific standard for Merck & Co., Inc.'s Stonewall Plant in Elkton, Virginia.* This paragraph applies only to the pharmaceutical manufacturing facility, commonly referred to as the Stonewall Plant, located at Route 340 South, in Elkton, Virginia ("site").

(1) For any storage vessel that otherwise would be subject to the control technology requirements of paragraphs (a) or (b) of this section, the site shall have the option of either complying directly with the requirements of this subpart, or reducing the site-wide total criteria pollutant emissions cap (total

emissions cap) in accordance with the procedures set forth in a permit issued pursuant to 40 CFR 52.2454. If the site chooses the option of reducing the total emissions cap in accordance with the procedures set forth in such permit, the requirements of such permit shall apply in lieu of the otherwise applicable requirements of this subpart for such storage vessel.

(2) For any storage vessel at the site not subject to the requirements of 40 CFR 60.112b (a) or (b), the requirements of 40 CFR 60.116b (b) and (c) and the General Provisions (subpart A of this part) shall not apply.

[52 FR 11429, Apr. 8, 1987, as amended at 62 FR 52641, Oct. 8, 1997]

### **§60.113b Testing and procedures.**

The owner or operator of each storage vessel as specified in §60.112b(a) shall meet the requirements of paragraph (a), (b), or (c) of this section. The applicable paragraph for a particular storage vessel depends on the control equipment installed to meet the requirements of §60.112b.

(a) After installing the control equipment required to meet §60.112b(a)(1) (permanently affixed roof and internal floating roof), each owner or operator shall:

(1) Visually inspect the internal floating roof, the primary seal, and the secondary seal (if one is in service), prior to filling the storage vessel with VOL. If there are holes, tears, or other openings in the primary seal, the secondary seal, or the seal fabric or defects in the internal floating roof, or both, the owner or operator shall repair the items before filling the storage vessel.

(2) For Vessels equipped with a liquid-mounted or mechanical shoe primary seal, visually inspect the internal floating roof and the primary seal or the secondary seal (if one is in service) through manholes and roof hatches on the fixed roof at least once every 12 months after initial fill. If the internal floating roof is not resting on the surface of the VOL inside the storage vessel, or there is liquid accumulated on the roof, or the seal is detached, or there are holes or tears in the seal fabric, the owner or operator shall repair the items or empty and remove the storage vessel from service within 45 days. If a failure that is detected during inspections required in this paragraph cannot be repaired within 45 days and if the vessel cannot be emptied within 45 days, a 30-day extension may be requested from the Administrator in the inspection report required in §60.115b(a)(3). Such a request for an extension must document that alternate storage capacity is unavailable and specify a schedule of actions the company will take that will assure that the control equipment will be repaired or the vessel will be emptied as soon as possible.

(3) For vessels equipped with a double-seal system as specified in §60.112b(a)(1)(ii)(B):

(i) Visually inspect the vessel as specified in paragraph (a)(4) of this section at least every 5 years;  
or

(ii) Visually inspect the vessel as specified in paragraph (a)(2) of this section.

(4) Visually inspect the internal floating roof, the primary seal, the secondary seal (if one is in service), gaskets, slotted membranes and sleeve seals (if any) each time the storage vessel is emptied and degassed. If the internal floating roof has defects, the primary seal has holes, tears, or other openings in the seal or the seal fabric, or the secondary seal has holes, tears, or other openings in the seal or the seal fabric, or the gaskets no longer close off the liquid surfaces from the atmosphere, or the slotted membrane has more than 10 percent open area, the owner or operator shall repair the items as necessary so that none of the conditions specified in this paragraph exist before refilling the storage vessel with VOL. In no event shall inspections conducted in accordance with this provision occur at intervals greater than 10 years in the case of vessels conducting the annual visual inspection as specified

in paragraphs (a)(2) and (a)(3)(ii) of this section and at intervals no greater than 5 years in the case of vessels specified in paragraph (a)(3)(i) of this section.

(5) Notify the Administrator in writing at least 30 days prior to the filling or refilling of each storage vessel for which an inspection is required by paragraphs (a)(1) and (a)(4) of this section to afford the Administrator the opportunity to have an observer present. If the inspection required by paragraph (a)(4) of this section is not planned and the owner or operator could not have known about the inspection 30 days in advance or refilling the tank, the owner or operator shall notify the Administrator at least 7 days prior to the refilling of the storage vessel. Notification shall be made by telephone immediately followed by written documentation demonstrating why the inspection was unplanned. Alternatively, this notification including the written documentation may be made in writing and sent by express mail so that it is received by the Administrator at least 7 days prior to the refilling.

(b) After installing the control equipment required to meet §60.112b(a)(2) (external floating roof), the owner or operator shall:

(1) Determine the gap areas and maximum gap widths, between the primary seal and the wall of the storage vessel and between the secondary seal and the wall of the storage vessel according to the following frequency.

(i) Measurements of gaps between the tank wall and the primary seal (seal gaps) shall be performed during the hydrostatic testing of the vessel or within 60 days of the initial fill with VOL and at least once every 5 years thereafter.

(ii) Measurements of gaps between the tank wall and the secondary seal shall be performed within 60 days of the initial fill with VOL and at least once per year thereafter.

(iii) If any source ceases to store VOL for a period of 1 year or more, subsequent introduction of VOL into the vessel shall be considered an initial fill for the purposes of paragraphs (b)(1)(i) and (b)(1)(ii) of this section.

(2) Determine gap widths and areas in the primary and secondary seals individually by the following procedures:

(i) Measure seal gaps, if any, at one or more floating roof levels when the roof is floating off the roof leg supports.

(ii) Measure seal gaps around the entire circumference of the tank in each place where a 0.32-cm diameter uniform probe passes freely (without forcing or binding against seal) between the seal and the wall of the storage vessel and measure the circumferential distance of each such location.

(iii) The total surface area of each gap described in paragraph (b)(2)(ii) of this section shall be determined by using probes of various widths to measure accurately the actual distance from the tank wall to the seal and multiplying each such width by its respective circumferential distance.

(3) Add the gap surface area of each gap location for the primary seal and the secondary seal individually and divide the sum for each seal by the nominal diameter of the tank and compare each ratio to the respective standards in paragraph (b)(4) of this section.

(4) Make necessary repairs or empty the storage vessel within 45 days of identification in any inspection for seals not meeting the requirements listed in (b)(4) (i) and (ii) of this section:

(i) The accumulated area of gaps between the tank wall and the mechanical shoe or liquid-mounted primary seal shall not exceed 212 cm<sup>2</sup> per meter of tank diameter, and the width of any portion of any gap shall not exceed 3.81 cm.

(A) One end of the mechanical shoe is to extend into the stored liquid, and the other end is to extend a minimum vertical distance of 61 cm above the stored liquid surface.

(B) There are to be no holes, tears, or other openings in the shoe, seal fabric, or seal envelope.

(ii) The secondary seal is to meet the following requirements:

(A) The secondary seal is to be installed above the primary seal so that it completely covers the space between the roof edge and the tank wall except as provided in paragraph (b)(2)(iii) of this section.

(B) The accumulated area of gaps between the tank wall and the secondary seal shall not exceed 21.2 cm<sup>2</sup> per meter of tank diameter, and the width of any portion of any gap shall not exceed 1.27 cm.

(C) There are to be no holes, tears, or other openings in the seal or seal fabric.

(iii) If a failure that is detected during inspections required in paragraph (b)(1) of §60.113b(b) cannot be repaired within 45 days and if the vessel cannot be emptied within 45 days, a 30-day extension may be requested from the Administrator in the inspection report required in §60.115b(b)(4). Such extension request must include a demonstration of unavailability of alternate storage capacity and a specification of a schedule that will assure that the control equipment will be repaired or the vessel will be emptied as soon as possible.

(5) Notify the Administrator 30 days in advance of any gap measurements required by paragraph (b)(1) of this section to afford the Administrator the opportunity to have an observer present.

(6) Visually inspect the external floating roof, the primary seal, secondary seal, and fittings each time the vessel is emptied and degassed.

(i) If the external floating roof has defects, the primary seal has holes, tears, or other openings in the seal or the seal fabric, or the secondary seal has holes, tears, or other openings in the seal or the seal fabric, the owner or operator shall repair the items as necessary so that none of the conditions specified in this paragraph exist before filling or refilling the storage vessel with VOL.

(ii) For all the inspections required by paragraph (b)(6) of this section, the owner or operator shall notify the Administrator in writing at least 30 days prior to the filling or refilling of each storage vessel to afford the Administrator the opportunity to inspect the storage vessel prior to refilling. If the inspection required by paragraph (b)(6) of this section is not planned and the owner or operator could not have known about the inspection 30 days in advance of refilling the tank, the owner or operator shall notify the Administrator at least 7 days prior to the refilling of the storage vessel. Notification shall be made by telephone immediately followed by written documentation demonstrating why the inspection was unplanned. Alternatively, this notification including the written documentation may be made in writing and sent by express mail so that it is received by the Administrator at least 7 days prior to the refilling.

(c) The owner or operator of each source that is equipped with a closed vent system and control device as required in §60.112b (a)(3) or (b)(2) (other than a flare) is exempt from §60.8 of the General Provisions and shall meet the following requirements.



(1) Submit for approval by the Administrator as an attachment to the notification required by §60.7(a)(1) or, if the facility is exempt from §60.7(a)(1), as an attachment to the notification required by §60.7(a)(2), an operating plan containing the information listed below.

(i) Documentation demonstrating that the control device will achieve the required control efficiency during maximum loading conditions. This documentation is to include a description of the gas stream which enters the control device, including flow and VOC content under varying liquid level conditions (dynamic and static) and manufacturer's design specifications for the control device. If the control device or the closed vent capture system receives vapors, gases, or liquids other than fuels from sources that are not designated sources under this subpart, the efficiency demonstration is to include consideration of all vapors, gases, and liquids received by the closed vent capture system and control device. If an enclosed combustion device with a minimum residence time of 0.75 seconds and a minimum temperature of 816 °C is used to meet the 95 percent requirement, documentation that those conditions will exist is sufficient to meet the requirements of this paragraph.

(ii) A description of the parameter or parameters to be monitored to ensure that the control device will be operated in conformance with its design and an explanation of the criteria used for selection of that parameter (or parameters).

(2) Operate the closed vent system and control device and monitor the parameters of the closed vent system and control device in accordance with the operating plan submitted to the Administrator in accordance with paragraph (c)(1) of this section, unless the plan was modified by the Administrator during the review process. In this case, the modified plan applies.

(d) The owner or operator of each source that is equipped with a closed vent system and a flare to meet the requirements in §60.112b (a)(3) or (b)(2) shall meet the requirements as specified in the general control device requirements, §60.18 (e) and (f).

[52 FR 11429, Apr. 8, 1987, as amended at 54 FR 32973, Aug. 11, 1989]

**§60.114b Alternative means of emission limitation.**

(a) If, in the Administrator's judgment, an alternative means of emission limitation will achieve a reduction in emissions at least equivalent to the reduction in emissions achieved by any requirement in §60.112b, the Administrator will publish in the FEDERAL REGISTER a notice permitting the use of the alternative means for purposes of compliance with that requirement.

(b) Any notice under paragraph (a) of this section will be published only after notice and an opportunity for a hearing.

(c) Any person seeking permission under this section shall submit to the Administrator a written application including:

(1) An actual emissions test that uses a full-sized or scale-model storage vessel that accurately collects and measures all VOC emissions from a given control device and that accurately simulates wind and accounts for other emission variables such as temperature and barometric pressure.

(2) An engineering evaluation that the Administrator determines is an accurate method of determining equivalence.

(d) The Administrator may condition the permission on requirements that may be necessary to ensure operation and maintenance to achieve the same emissions reduction as specified in §60.112b.

### **§60.115b Reporting and recordkeeping requirements.**

The owner or operator of each storage vessel as specified in §60.112b(a) shall keep records and furnish reports as required by paragraphs (a), (b), or (c) of this section depending upon the control equipment installed to meet the requirements of §60.112b. The owner or operator shall keep copies of all reports and records required by this section, except for the record required by (c)(1), for at least 2 years. The record required by (c)(1) will be kept for the life of the control equipment.

(a) After installing control equipment in accordance with §60.112b(a)(1) (fixed roof and internal floating roof), the owner or operator shall meet the following requirements.

(1) Furnish the Administrator with a report that describes the control equipment and certifies that the control equipment meets the specifications of §60.112b(a)(1) and §60.113b(a)(1). This report shall be an attachment to the notification required by §60.7(a)(3).

(2) Keep a record of each inspection performed as required by §60.113b (a)(1), (a)(2), (a)(3), and (a)(4). Each record shall identify the storage vessel on which the inspection was performed and shall contain the date the vessel was inspected and the observed condition of each component of the control equipment (seals, internal floating roof, and fittings).

(3) If any of the conditions described in §60.113b(a)(2) are detected during the annual visual inspection required by §60.113b(a)(2), a report shall be furnished to the Administrator within 30 days of the inspection. Each report shall identify the storage vessel, the nature of the defects, and the date the storage vessel was emptied or the nature of and date the repair was made.

(4) After each inspection required by §60.113b(a)(3) that finds holes or tears in the seal or seal fabric, or defects in the internal floating roof, or other control equipment defects listed in §60.113b(a)(3)(ii), a report shall be furnished to the Administrator within 30 days of the inspection. The report shall identify the storage vessel and the reason it did not meet the specifications of §61.112b(a)(1) or §60.113b(a)(3) and list each repair made.

(b) After installing control equipment in accordance with §61.112b(a)(2) (external floating roof), the owner or operator shall meet the following requirements.

(1) Furnish the Administrator with a report that describes the control equipment and certifies that the control equipment meets the specifications of §60.112b(a)(2) and §60.113b(b)(2), (b)(3), and (b)(4). This report shall be an attachment to the notification required by §60.7(a)(3).

(2) Within 60 days of performing the seal gap measurements required by §60.113b(b)(1), furnish the Administrator with a report that contains:

- (i) The date of measurement.
- (ii) The raw data obtained in the measurement.
- (iii) The calculations described in §60.113b (b)(2) and (b)(3).

(3) Keep a record of each gap measurement performed as required by §60.113b(b). Each record shall identify the storage vessel in which the measurement was performed and shall contain:

- (i) The date of measurement.
- (ii) The raw data obtained in the measurement.

(iii) The calculations described in §60.113b (b)(2) and (b)(3).

(4) After each seal gap measurement that detects gaps exceeding the limitations specified by §60.113b(b)(4), submit a report to the Administrator within 30 days of the inspection. The report will identify the vessel and contain the information specified in paragraph (b)(2) of this section and the date the vessel was emptied or the repairs made and date of repair.

(c) After installing control equipment in accordance with §60.112b (a)(3) or (b)(1) (closed vent system and control device other than a flare), the owner or operator shall keep the following records.

(1) A copy of the operating plan.

(2) A record of the measured values of the parameters monitored in accordance with §60.113b(c)(2).

(d) After installing a closed vent system and flare to comply with §60.112b, the owner or operator shall meet the following requirements.

(1) A report containing the measurements required by §60.18(f) (1), (2), (3), (4), (5), and (6) shall be furnished to the Administrator as required by §60.8 of the General Provisions. This report shall be submitted within 6 months of the initial start-up date.

(2) Records shall be kept of all periods of operation during which the flare pilot flame is absent.

(3) Semiannual reports of all periods recorded under §60.115b(d)(2) in which the pilot flame was absent shall be furnished to the Administrator.

#### **§60.116b Monitoring of operations.**

(a) The owner or operator shall keep copies of all records required by this section, except for the record required by paragraph (b) of this section, for at least 2 years. The record required by paragraph (b) of this section will be kept for the life of the source.

(b) The owner or operator of each storage vessel as specified in §60.110b(a) shall keep readily accessible records showing the dimension of the storage vessel and an analysis showing the capacity of the storage vessel.

(c) Except as provided in paragraphs (f) and (g) of this section, the owner or operator of each storage vessel either with a design capacity greater than or equal to 151 m<sup>3</sup> storing a liquid with a maximum true vapor pressure greater than or equal to 3.5 kPa or with a design capacity greater than or equal to 75 m<sup>3</sup> but less than 151 m<sup>3</sup> storing a liquid with a maximum true vapor pressure greater than or equal to 15.0 kPa shall maintain a record of the VOL stored, the period of storage, and the maximum true vapor pressure of that VOL during the respective storage period.

(d) Except as provided in paragraph (g) of this section, the owner or operator of each storage vessel either with a design capacity greater than or equal to 151 m<sup>3</sup> storing a liquid with a maximum true vapor pressure that is normally less than 5.2 kPa or with a design capacity greater than or equal to 75 m<sup>3</sup> but less than 151 m<sup>3</sup> storing a liquid with a maximum true vapor pressure that is normally less than 27.6 kPa shall notify the Administrator within 30 days when the maximum true vapor pressure of the liquid exceeds the respective maximum true vapor pressure values for each volume range.

(e) Available data on the storage temperature may be used to determine the maximum true vapor pressure as determined below.

(1) For vessels operated above or below ambient temperatures, the maximum true vapor pressure is calculated based upon the highest expected calendar-month average of the storage temperature. For vessels operated at ambient temperatures, the maximum true vapor pressure is calculated based upon the maximum local monthly average ambient temperature as reported by the National Weather Service.

(2) For crude oil or refined petroleum products the vapor pressure may be obtained by the following:

(i) Available data on the Reid vapor pressure and the maximum expected storage temperature based on the highest expected calendar-month average temperature of the stored product may be used to determine the maximum true vapor pressure from nomographs contained in API Bulletin 2517 (incorporated by reference—see §60.17), unless the Administrator specifically requests that the liquid be sampled, the actual storage temperature determined, and the Reid vapor pressure determined from the sample(s).

(ii) The true vapor pressure of each type of crude oil with a Reid vapor pressure less than 13.8 kPa or with physical properties that preclude determination by the recommended method is to be determined from available data and recorded if the estimated maximum true vapor pressure is greater than 3.5 kPa.

(3) For other liquids, the vapor pressure:

(i) May be obtained from standard reference texts, or

(ii) Determined by ASTM D2879-83, 96, or 97 (incorporated by reference—see §60.17); or

(iii) Measured by an appropriate method approved by the Administrator; or

(iv) Calculated by an appropriate method approved by the Administrator.

(f) The owner or operator of each vessel storing a waste mixture of indeterminate or variable composition shall be subject to the following requirements.

(1) Prior to the initial filling of the vessel, the highest maximum true vapor pressure for the range of anticipated liquid compositions to be stored will be determined using the methods described in paragraph (e) of this section.

(2) For vessels in which the vapor pressure of the anticipated liquid composition is above the cutoff for monitoring but below the cutoff for controls as defined in §60.112b(a), an initial physical test of the vapor pressure is required; and a physical test at least once every 6 months thereafter is required as determined by the following methods:

(i) ASTM D2879-83, 96, or 97 (incorporated by reference—see §60.17); or

(ii) ASTM D323-82 or 94 (incorporated by reference—see §60.17); or

(iii) As measured by an appropriate method as approved by the Administrator.

(g) The owner or operator of each vessel equipped with a closed vent system and control device meeting the specification of §60.112b or with emissions reductions equipment as specified in 40 CFR 65.42(b)(4), (b)(5), (b)(6), or (c) is exempt from the requirements of paragraphs (c) and (d) of this section.

**§60.117b Delegation of authority.**

(a) In delegating implementation and enforcement authority to a State under section 111(c) of the Act, the authorities contained in paragraph (b) of this section shall be retained by the Administrator and not transferred to a State.

(b) Authorities which will not be delegated to States: §§60.111b(f)(4), 60.114b, 60.116b(e)(3)(iii), 60.116b(e)(3)(iv), and 60.116b(f)(2)(iii).

[52 FR 11429, Apr. 8, 1987, as amended at 52 FR 22780, June 16, 1987]

**Appendix C**

40 C.F.R. Part 63, Subpart F – *National Emission Standards for Organic Hazardous Air  
Pollutants From the Synthetic Organic Chemical Manufacturing Industry*

SOURCE: 59 FR 19454, Apr. 22, 1994, unless otherwise noted.

**§63.100 Applicability and designation of source.**

(a) This subpart provides applicability provisions, definitions, and other general provisions that are applicable to subparts G and H of this part.

(b) Except as provided in paragraphs (b)(4) and (c) of this section, the provisions of subparts F, G, and H of this part apply to chemical manufacturing process units that meet all the criteria specified in paragraphs (b)(1), (b)(2), and (b)(3) of this section:

(1) Manufacture as a primary product one or more of the chemicals listed in paragraphs (b)(1)(i) or (b)(1)(ii) of this section.

(i) One or more of the chemicals listed in table 1 of this subpart; or

(ii) One or more of the chemicals listed in paragraphs (b)(1)(ii)(A) or (b)(1)(ii)(B) of this section:

(A) Tetrahydrobenzaldehyde (CAS Number 100-50-5); or

(B) Crotonaldehyde (CAS Number 123-73-9).

(2) Use as a reactant or manufacture as a product, or co-product, one or more of the organic hazardous air pollutants listed in table 2 of this subpart;

(3) Are located at a plant site that is a major source as defined in section 112(a) of the Act.

(4) The owner or operator of a chemical manufacturing processing unit is exempt from all requirements of subparts F, G, and H of this part until not later than April 22, 1997 if the owner or operator certifies, in a notification to the appropriate EPA Regional Office, not later than May 14, 1996, that the plant site at which the chemical manufacturing processing unit is located emits, and will continue to emit, during any 12-month period, less than 10 tons per year of any individual hazardous air pollutants (HAP), and less than 25 tons per year of any combination of HAP.

(i) If such a determination is based on limitations and conditions that are not federally enforceable (as defined in subpart A of this part), the owner or operator shall document the basis for the determination as specified in paragraphs (b)(4)(i)(A) through (b)(4)(i)(C) and comply with the recordkeeping requirement in 63.103(f).

(A) The owner or operator shall identify all HAP emission points at the plant site, including those emission points subject to and emission points not subject to subparts F, G, and H;

(B) The owner or operator shall calculate the amount of annual HAP emissions released from each emission point at the plant site, using acceptable measurement or estimating techniques for maximum expected operating conditions at the plant site. Examples of estimating procedures that are considered acceptable include the calculation procedures in §63.150 of subpart G, the early reduction demonstration procedures specified in §§63.74 (c)(2), (c)(3), (d)(2), (d)(3), and (g), or accepted engineering practices. If the total annual HAP emissions for the plant site are annually reported under Emergency Planning and Community Right-to-Know Act (EPCRA) section 313, then such reported annual emissions may be used to satisfy the requirements of §63.100(b)(4)(i)(B).

(C) The owner or operator shall sum the amount of annual HAP emissions from all emission points on the plant site. If the total emissions of any one HAP are less than 10 tons per year and the total emissions of any combination of HAP are less than 25 tons per year, the plant site qualifies for the exemption described in paragraph (b)(4) of this section, provided that emissions are kept below these thresholds.

(ii) If such a determination is based on limitations and conditions that are federally enforceable (as defined in subpart A of this part), the owner or operator is not subject to the provisions of paragraph (b)(4) of this section.

(c) The owner or operator of a chemical manufacturing process unit that meets the criteria specified in paragraphs (b)(1) and (b)(3) of this section but does not use as a reactant or manufacture as a product or co-product, any organic hazardous air pollutant listed in table 2 of this subpart shall comply only with the requirements of §63.103(e) of this subpart. To comply with this subpart, such chemical manufacturing process units shall not be required to comply with the provisions of subpart A of this part.

(d) The primary product of a chemical manufacturing process unit shall be determined according to the procedures specified in paragraphs (d)(1), (d)(2), (d)(3), and (d)(4) of this section.

(1) If a chemical manufacturing process unit produces more than one intended chemical product, the product with the greatest annual design capacity on a mass basis determines the primary product of the process.

(2) If a chemical manufacturing process unit has two or more products that have the same maximum annual design capacity on a mass basis and if one of those chemicals is listed in table 1 of this subpart, then the listed chemical is considered the primary product and the chemical manufacturing process unit is subject to this subpart. If more than one of the products is listed in table 1 of this subpart, then the owner or operator may designate as the primary product any of the listed chemicals and the chemical manufacturing process unit is subject to this subpart.

(3) For chemical manufacturing process units that are designed and operated as flexible operation units producing one or more chemicals listed in table 1 of this subpart, the primary product shall be determined for existing sources based on the expected utilization for the five years following April 22, 1994 and for new sources based on the expected utilization for the first five years after initial start-up.

(i) If the predominant use of the flexible operation unit, as described in paragraphs (d)(3)(i)(A) and (d)(3)(i)(B) of this section, is to produce one or more chemicals listed in table 1 of this subpart, then the flexible operation unit shall be subject to the provisions of subparts F, G, and H of this part.

(A) If the flexible operation unit produces one product for the greatest annual operating time, then that product shall represent the primary product of the flexible operation unit.

(B) If the flexible operation unit produces multiple chemicals equally based on operating time, then the product with the greatest annual production on a mass basis shall represent the primary product of the flexible operation unit.

(ii) The determination of applicability of this subpart to chemical manufacturing process units that are designed and operated as flexible operation units shall be reported as part of an operating permit application or as otherwise specified by the permitting authority.

(4) Notwithstanding the provisions of paragraph (d)(3) of this section, for chemical manufacturing process units that are designed and operated as flexible operation units producing a chemical listed in paragraph (b)(1)(ii) of this section, the primary product shall be determined for existing sources based on



the expected utilization for the five years following May 12, 1998 and for new sources based on the expected utilization for the first five years after initial start-up.

(i) The predominant use of the flexible operation unit shall be determined according to paragraphs (d)(3)(i)(A) and (d)(3)(i)(B) of this section. If the predominant use is to produce one of the chemicals listed in paragraph (b)(1)(ii) of this section, then the flexible operation unit shall be subject to the provisions of this subpart and subparts G and H of this part.

(ii) The determination of applicability of this subpart to chemical manufacturing process units that are designed and operated as flexible operation units shall be reported as part of an operating permit application or as otherwise specified by the permitting authority.

(e) The source to which this subpart applies is the collection of all chemical manufacturing process units and the associated equipment at a major source that meet the criteria specified in paragraphs (b)(1) through (3) of this section. The source includes the process vents; storage vessels; transfer racks; waste management units; maintenance wastewater; heat exchange systems; equipment identified in §63.149; and pumps, compressors, agitators, pressure relief devices, sampling connection systems, open-ended valves or lines, valves, connectors, instrumentation systems, surge control vessels, and bottoms receivers that are associated with that collection of chemical manufacturing process units. The source also includes equipment required by, or utilized as a method of compliance with, subparts F, G, or H of this part which may include control devices and recovery devices.

(1) This subpart applies to maintenance wastewater and heat exchange systems within a source that is subject to this subpart.

(2) This subpart F and subpart G of this part apply to process vents, storage vessels, transfer racks, equipment identified in §63.149 of subpart G of this part, and wastewater streams and associated treatment residuals within a source that is subject to this subpart.

(3) This subpart F and subpart H of this part apply to pumps, compressors, agitators, pressure relief devices, sampling connection systems, open-ended valves or lines, valves, connectors, instrumentation systems, surge control vessels, and bottoms receivers within a source that is subject to this subpart. If specific items of equipment, comprising part of a chemical manufacturing process unit subject to this subpart, are managed by different administrative organizations (e.g., different companies, affiliates, departments, divisions, etc.), those items of equipment may be aggregated with any chemical manufacturing process unit within the source for all purposes under subpart H of this part, providing there is no delay in the applicable compliance date in §63.100(k).

(f) The source includes the emission points listed in paragraphs (f)(1) through (f)(11) of this section, but those emission points are not subject to the requirements of this subpart F and subparts G and H of this part. This subpart does not require emission points that are listed in paragraphs (f)(1) through (f)(11) of this section to comply with the provisions of subpart A of this part.

(1) Equipment that is located within a chemical manufacturing process unit that is subject to this subpart but the equipment does not contain organic hazardous air pollutants.

(2) Stormwater from segregated sewers;

(3) Water from fire-fighting and deluge systems in segregated sewers;

(4) Spills;

(5) Water from safety showers;

(6) Water from testing of deluge systems;

(7) Water from testing of firefighting systems;

(8) Vessels storing organic liquids that contain organic hazardous air pollutants only as impurities;

(9) Loading racks, loading arms, or loading hoses that only transfer liquids containing organic hazardous air pollutants as impurities;

(10) Loading racks, loading arms, or loading hoses that vapor balance during all loading operations;  
and

(11) Equipment that is intended to operate in organic hazardous air pollutant service, as defined in §63.161 of subpart H of this part, for less than 300 hours during the calendar year.

(g) The owner or operator shall follow the procedures specified in paragraphs (g)(1) through (g)(4) of this section to determine whether a storage vessel is part of the source to which this subpart applies.

(1) Where a storage vessel is dedicated to a chemical manufacturing process unit, the storage vessel shall be considered part of that chemical manufacturing process unit.

(i) If the chemical manufacturing process unit is subject to this subpart according to the criteria specified in paragraph (b) of this section, then the storage vessel is part of the source to which this subpart applies.

(ii) If the chemical manufacturing process unit is not subject to this subpart according to the criteria specified in paragraph (b) of this section, then the storage vessel is not part of the source to which this subpart applies.

(2) If a storage vessel is not dedicated to a single chemical manufacturing process unit, then the applicability of this subpart F and subpart G of this part shall be determined according to the provisions in paragraphs (g)(2)(i) through (g)(2)(iii) of this section.

(i) If a storage vessel is shared among chemical manufacturing process units and one of the process units has the predominant use, as determined by paragraph (g)(2)(i)(A) and (g)(2)(i)(B) of this section, then the storage vessel is part of that chemical manufacturing process unit.

(A) If the greatest input into the storage vessel is from a chemical manufacturing process unit that is located on the same plant site, then that chemical manufacturing process unit has the predominant use.

(B) If the greatest input into the storage vessel is provided from a chemical manufacturing process unit that is not located on the same plant site, then the predominant use is the chemical manufacturing process unit on the same plant site that receives the greatest amount of material from the storage vessel.

(ii) If a storage vessel is shared among chemical manufacturing process units so that there is no single predominant use, and at least one of those chemical manufacturing process units is subject to this subpart, the storage vessel shall be considered to be part of the chemical manufacturing process unit that is subject to this subpart. If more than one chemical manufacturing process unit is subject to this subpart, the owner or operator may assign the storage vessel to any of the chemical manufacturing process units subject to this subpart.

(iii) If the predominant use of a storage vessel varies from year to year, then the applicability of this subpart shall be determined according to the criteria in paragraphs (g)(2)(iii)(A) and (g)(2)(iii)(B) of this

section, as applicable. This determination shall be reported as part of an operating permit application or as otherwise specified by the permitting authority.

(A) For chemical manufacturing process units that produce one or more of the chemicals listed in table 1 of this subpart and meet the criteria in paragraphs (b)(2) and (b)(3) of this section, the applicability shall be based on the utilization that occurred during the 12-month period preceding April 22, 1994.

(B) For chemical manufacturing process units that produce one or more of the chemicals listed in paragraph (b)(1)(ii) of this section and meet the criteria in paragraphs (b)(2) and (b)(3) of this section, the applicability shall be based on the utilization that occurred during the 12-month period preceding May 12, 1998.

(iv) If there is a change in the material stored in the storage vessel, the owner or operator shall reevaluate the applicability of this subpart to the vessel.

(3) Where a storage vessel is located at a major source that includes one or more chemical manufacturing process units which place material into, or receive materials from the storage vessel, but the storage vessel is located in a tank farm (including a marine tank farm), the applicability of this subpart F and subpart G of this part shall be determined according to the provisions in paragraphs (g)(3)(i) through (g)(3)(iv) of this section.

(i) The storage vessel may only be assigned to a chemical manufacturing process unit that utilizes the storage vessel and does not have an intervening storage vessel for that product (or raw material, as appropriate). With respect to any chemical manufacturing process unit, an intervening storage vessel means a storage vessel connected by hard-piping to the chemical manufacturing process unit and to the storage vessel in the tank farm so that product or raw material entering or leaving the chemical manufacturing process unit flows into (or from) the intervening storage vessel and does not flow directly into (or from) the storage vessel in the tank farm.

(ii) If there is no chemical manufacturing process unit at the major source that meets the criteria of paragraph (g)(3)(i) of this section with respect to a storage vessel, this subpart F and subpart G of this part do not apply to the storage vessel.

(iii) If there is only one chemical manufacturing process unit at the major source that meets the criteria of paragraph (g)(3)(i) of this section with respect to a storage vessel, the storage vessel shall be assigned to that chemical manufacturing process unit. Applicability of this subpart F and subpart G to this part to the storage vessel shall then be determined according to the provisions of paragraph (b) of this section.

(iv) If there are two or more chemical manufacturing process units at the major source that meet the criteria of paragraph (g)(3)(i) of this section with respect to a storage vessel, the storage vessel shall be assigned to one of those chemical manufacturing process units according to the provisions of paragraph (g)(2) of this section. The predominant use shall be determined among only those chemical manufacturing process units that meet the criteria of paragraph (g)(3)(i) of this section. Applicability of this subpart F and subpart G of this part to the storage vessel shall then be determined according to the provisions of paragraph (b) of this section.

(4) If the storage vessel begins receiving material from (or sending material to) another chemical manufacturing process unit, or ceases to receive material from (or send material to) a chemical manufacturing process unit, or if the applicability of this subpart F and subpart G of this part to a storage vessel has been determined according to the provisions of paragraphs (g)(2)(i) and (g)(2)(ii) of this section and there is a change so that the predominant use may reasonably have changed, the owner or operator shall reevaluate the applicability of this subpart to the storage vessel.

(h) The owner or operator shall follow the procedures specified in paragraphs (h)(1) and (h)(2) of this section to determine whether the arms and hoses in a loading rack are part of the source to which this subpart applies.

(1) Where a loading rack is dedicated to a chemical manufacturing process unit, the loading rack shall be considered part of that specific chemical manufacturing process unit.

(i) If the chemical manufacturing process unit is subject to this subpart according to the criteria specified in paragraph (b) of this section and the loading rack does not meet the criteria specified in paragraphs (f)(9) and (f)(10) of this section, then the loading rack is considered a transfer rack (as defined in §63.101 of this subpart) and is part of the source to which this subpart applies.

(ii) If the chemical manufacturing process unit is not subject to this subpart according to the criteria specified in paragraph (b) of this section, then the loading rack is not considered a transfer rack (as defined in §63.101 of this subpart) and is not a part of the source to which this subpart applies.

(2) If a loading rack is shared among chemical manufacturing process units, then the applicability of this subpart F and subpart G of this part shall be determined at each loading arm or loading hose according to the provisions in paragraphs (h)(2)(i) through (h)(2)(iv) of this section.

(i) Each loading arm or loading hose that is dedicated to the transfer of liquid organic hazardous air pollutants listed in table 2 of this subpart from a chemical manufacturing process unit to which this subpart applies is part of that chemical manufacturing process unit and is part of the source to which this subpart applies unless the loading arm or loading hose meets the criteria specified in paragraphs (f)(9) or (f)(10) of this section.

(ii) If a loading arm or loading hose is shared among chemical manufacturing process units, and one of the chemical manufacturing process units provides the greatest amount of the material that is loaded by the loading arm or loading hose, then the loading arm or loading hose is part of that chemical manufacturing process unit.

(A) If the chemical manufacturing process unit is subject to this subpart according to the criteria specified in paragraph (b) of this section, then the loading arm or loading hose is part of the source to which this subpart applies unless the loading arm or loading hose meets the criteria specified in paragraphs (f)(9) or (f)(10) of this section.

(B) If the chemical manufacturing process unit is not subject to this subpart according to the criteria specified in paragraph (b) of this section, then the loading arm or loading hose is not part of the source to which this subpart applies.

(iii) If a loading arm or loading hose is shared among chemical manufacturing process units so that there is no single predominant use as described in paragraph (h)(2)(ii) of this section and at least one of those chemical manufacturing process units is subject to this subpart, then the loading arm or hose is part of the chemical manufacturing process unit that is subject to this subpart. If more than one of the chemical manufacturing process units is subject to this subpart, the owner or operator may assign the loading arm or loading hose to any of the chemical manufacturing process units subject to this subpart.

(iv) If the predominant use of a loading arm or loading hose varies from year to year, then the applicability of this subpart shall be determined according to the criteria in paragraphs (h)(2)(iv)(A) and (h)(2)(iv)(B) of this section, as applicable. This determination shall be reported as part of an operating permit application or as otherwise specified by the permitting authority.

(A) For chemical manufacturing process units that produce one or more of the chemicals listed in table 1 of this subpart and meet the criteria in paragraphs (b)(2) and (b)(3) of this section, the applicability shall be based on the utilization that occurred during the 12-month period preceding April 22, 1994.

(B) For chemical manufacturing process units that produce one or more of the chemicals listed in paragraph (b)(1)(ii) of this section and meet the criteria in paragraphs (b)(2) and (b)(3) of this section, the applicability shall be based on the utilization that occurred during the year preceding May 12, 1998.

(3) If a loading rack that was dedicated to a single chemical manufacturing process unit begins to serve another chemical manufacturing process unit, or if applicability was determined under the provisions of paragraphs (h)(2)(i) through (h)(2)(iii) of this section and there is a change so that the predominant use may reasonably have changed, the owner or operator shall reevaluate the applicability of this subpart to the loading rack, loading arm, or loading hose.

(i) Except as provided in paragraph (i)(4) of this section, the owner or operator shall follow the procedures specified in paragraphs (i)(1) through (i)(3) and (i)(5) of this section to determine whether the vent(s) from a distillation unit is part of the source to which this subpart applies.

(1) Where a distillation unit is dedicated to a chemical manufacturing process unit, the distillation column shall be considered part of that chemical manufacturing process unit.

(i) If the chemical manufacturing process unit is subject to this subpart according to the criteria specified in paragraph (b) of this section, then the distillation unit is part of the source to which this subpart applies.

(ii) If the chemical manufacturing process unit is not subject to this subpart according to the criteria specified in paragraph (b) of this section, then the distillation unit is not part of the source to which this subpart applies.

(2) If a distillation unit is not dedicated to a single chemical manufacturing process unit, then the applicability of this subpart and subpart G of this part shall be determined according to the provisions in paragraphs (i)(2)(i) through (i)(2)(iv) of this section.

(i) If the greatest input to the distillation unit is from a chemical manufacturing process unit located on the same plant site, then the distillation unit shall be assigned to that chemical manufacturing process unit.

(ii) If the greatest input to the distillation unit is provided from a chemical manufacturing process unit that is not located on the same plant site, then the distillation unit shall be assigned to the chemical manufacturing process unit located at the same plant site that receives the greatest amount of material from the distillation unit.

(iii) If a distillation unit is shared among chemical manufacturing process units so that there is no single predominant use as described in paragraphs (i)(2)(i) and (i)(2)(ii) of this section, and at least one of those chemical manufacturing process units is subject to this subpart, the distillation unit shall be assigned to the chemical manufacturing process unit that is subject to this subpart. If more than one chemical manufacturing process unit is subject to this subpart, the owner or operator may assign the distillation unit to any of the chemical manufacturing process units subject to this subpart.

(iv) If the predominant use of a distillation unit varies from year to year, then the applicability of this subpart shall be determined according to the criteria in paragraphs (i)(2)(iv)(A) and (i)(2)(iv)(B), as applicable. This determination shall be included as part of an operating permit application or as otherwise specified by the permitting authority.

(A) For chemical manufacturing process units that produce one or more of the chemicals listed in table 1 of this subpart and meet the criteria in paragraphs (b)(2) and (b)(3) of this section, the applicability shall be based on the utilization that occurred during the year preceding April 22, 1994.

(B) For chemical manufacturing process units that produce one or more of the chemicals listed in paragraph (b)(1)(ii) of this section and meet the criteria in paragraphs (b)(2) and (b)(3) of this section, the applicability shall be based on the utilization that occurred during the year preceding May 12, 1998.

(3) If the chemical manufacturing process unit to which the distillation unit is assigned is subject to this subpart, then each vent from the individual distillation unit shall be considered separately to determine whether it is a process vent (as defined in §63.101 of this subpart). Each vent that is a process vent is part of the source to which this subpart applies.

(4) If the distillation unit is part of one of the chemical manufacturing process units listed in paragraphs (i)(4)(i) through (i)(4)(iii) of this section, then each vent from the individual distillation unit shall be considered separately to determine whether it is a process vent (as defined in §63.101 of this subpart). Each vent that is a process vent is part of the source to which this subpart applies:

- (i) The Aromex unit that produces benzene, toluene, and xylene;
- (ii) The unit that produces hexane; or
- (iii) The unit that produces cyclohexane.

(5) If a distillation unit that was dedicated to a single chemical manufacturing process unit, or that was part of a chemical manufacturing unit identified in paragraphs (i)(4)(i) through (i)(4)(iii) of this section, begins to serve another chemical manufacturing process unit, or if applicability was determined under the provisions of paragraphs (i)(2)(i) through (i)(2)(iii) of this section and there is a change so that the predominant use may reasonably have changed, the owner or operator shall reevaluate the applicability of this subpart to the distillation unit.

(j) The provisions of subparts F, G, and H of this part do not apply to the processes specified in paragraphs (j)(1) through (j)(6) of this section. Subparts F, G, and H do not require processes specified in paragraphs (j)(1) through (j)(6) to comply with the provisions of subpart A of this part.

(1) Research and development facilities, regardless of whether the facilities are located at the same plant site as a chemical manufacturing process unit that is subject to the provisions of subparts F, G, or H of this part.

(2) Petroleum refining process units, regardless of whether the units supply feedstocks that include chemicals listed in table 1 of this subpart to chemical manufacturing process units that are subject to the provisions of subparts F, G, or H of this part.

(3) Ethylene process units, regardless of whether the units supply feedstocks that include chemicals listed in table 1 of this subpart to chemical manufacturing process units that are subject to the provisions of subpart F, G, or H of this part.

(4) Batch process vents within a chemical manufacturing process unit.

(5) Chemical manufacturing process units that are located in coke by-product recovery plants.

(6) Solvent reclamation, recovery, or recycling operations at hazardous waste TSDF facilities requiring a permit under 40 CFR part 270 that are separate entities and not part of a SOCOMI chemical manufacturing process unit.

(k) Except as provided in paragraphs (l), (m), and (p) of this section, sources subject to subparts F, G, or H of this part are required to achieve compliance on or before the dates specified in paragraphs (k)(1) through (k)(8) of this section.

(1)(i) New sources that commence construction or reconstruction after December 31, 1992, but before August 27, 1996 shall be in compliance with this subpart F, subparts G and H of this part upon initial start-up or by April 22, 1994, whichever is later, as provided in §63.6(b) of subpart A of this part, and further, where start-up occurs before January 17, 1997 shall also be in compliance with this subpart F and subparts G and H of this part (as amended on January 17, 1997) by January 17, 1997, except that, with respect to all new sources that commenced construction or reconstruction after December 31, 1992, and before August 27, 1996:

(A) Heat exchange systems and maintenance wastewater, that are part of a new source on which construction or reconstruction commenced after December 31, 1992, but before August 27, 1996, shall be in compliance with this subpart F no later than initial start-up or 180 days after January 17, 1997, whichever is later;

(B) Process wastewater streams and equipment subject to §63.149, that are part of a new source on which construction or reconstruction commenced after December 31, 1992, but before August 27, 1996, shall be in compliance with this subpart F and subpart G of this part no later than initial start-up or 180 days after January 17, 1997, whichever is later; and

(ii) New sources that commence construction after August 26, 1996 shall be in compliance with this subpart F, subparts G and H of this part upon initial start-up or by January 17, 1997, whichever is later.

(2) Existing sources shall be in compliance with this subpart F and subpart G of this part no later than the dates specified in paragraphs (k)(2)(i) and (k)(2)(ii) of this section, unless an extension has been granted by the Administrator as provided in §63.151(a)(6) of subpart G of this part or granted by the permitting authority as provided in §63.6(i) of subpart A of this part.

(i) Process vents, storage vessels, and transfer racks at an existing source shall be in compliance with the applicable sections of this subpart and subpart G of this part no later than April 22, 1997.

(ii) Heat exchange systems and maintenance wastewater shall be in compliance with the applicable sections of this subpart, and equipment subject to §63.149 and process wastewater streams shall be in compliance with the applicable sections of this subpart and subpart G of this part no later than April 22, 1999, except as provided in paragraphs (k)(2)(ii)(A) and (k)(2)(ii)(B) of this section.

(A) If a process wastewater stream or equipment subject to §63.149 is subject to the control requirements of subpart G of this part due to the contribution of nitrobenzene to the total annual average concentration (as determined according to the procedures in §63.144(b) of subpart G of this part), the wastewater stream shall be in compliance no later than January 18, 2000.

(B) If a process wastewater stream is used to generate credits in an emissions average in accordance with §63.150 of subpart G of this part, the process wastewater stream shall be in compliance with the applicable sections of subpart G of this part no later than April 22, 1997.

(3) Existing sources shall be in compliance with subpart H of this part no later than the dates specified in paragraphs (k)(3)(i) through (k)(3)(v) of this section, except as provided for in paragraphs

(k)(4) through (k)(8) of this section, unless an extension has been granted by the Administrator as provided in §63.182(a)(6) of this part or granted by the permitting authority as provided in §63.6(i) of subpart A of this part. The group designation for each process unit is indicated in table 1 of this subpart.

(i) Group I: October 24, 1994.

(ii) Group II: January 23, 1995.

(iii) Group III: April 24, 1995.

(iv) Group IV: July 24, 1995.

(v) Group V: October 23, 1995.

(4) Existing chemical manufacturing process units in Groups I and II as identified in table 1 of this subpart shall be in compliance with the requirements of §63.164 of subpart H no later than May 10, 1995, for any compressor meeting one or more of the criteria in paragraphs (k)(4)(i) through (k)(4)(iv) of this section, if the work can be accomplished without a process unit shutdown, as defined in §63.161 in subpart H.

(i) The seal system will be replaced;

(ii) A barrier fluid system will be installed;

(iii) A new barrier fluid will be utilized which requires changes to the existing barrier fluid system; or

(iv) The compressor must be modified to permit connecting the compressor to a closed vent system.

(5) Existing chemical manufacturing process units shall be in compliance with the requirements of §63.164 in subpart H no later than 1 year after the applicable compliance date specified in paragraph (k)(3) of this section, for any compressor meeting the criteria in paragraphs (k)(5)(i) through (k)(5)(iv) of this section.

(i) The compressor meets one or more of the criteria specified in paragraphs (k)(4) (i) through (iv) of this section;

(ii) The work can be accomplished without a process unit shutdown as defined in §63.161 of subpart H;

(iii) The additional time is actually necessary due to the unavailability of parts beyond the control of the owner or operator; and

(iv) The owner or operator submits a request to the appropriate EPA Regional Office at the addresses listed in §63.13 of subpart A of this part no later than 45 days before the applicable compliance date in paragraph (k)(3) of this section, but in no event earlier than May 10, 1995. The request shall include the information specified in paragraphs (k)(5)(iv)(A) through (k)(5)(iv)(E) of this section. Unless the EPA Regional Office objects to the request within 30 days after receipt, the request shall be deemed approved.

(A) The name and address of the owner or operator and the address of the existing source if it differs from the address of the owner or operator;



(B) The name, address, and telephone number of a contact person for further information;

(C) An identification of the chemical manufacturing process unit, and of the specific equipment for which additional compliance time is required;

(D) The reason compliance can not reasonably be achieved by the applicable date specified in paragraphs (k)(3)(i) through (k)(3)(v) of this section; and

(E) The date by which the owner or operator expects to achieve compliance.

(6)(i) If compliance with the compressor provisions of §63.164 of subpart H of this part can not reasonably be achieved without a process unit shutdown, as defined in §63.161 of subpart H, the owner or operator shall achieve compliance no later than April 22, 1996, except as provided for in paragraph (k)(6)(ii) of this section. The owner or operator who elects to use this provision shall comply with the requirements of §63.103(g) of this subpart.

(ii) If compliance with the compressor provisions of §63.164 of subpart H of this part can not be achieved without replacing the compressor or recasting the distance piece, the owner or operator shall achieve compliance no later than April 22, 1997. The owner or operator who elects to use this provision shall also comply with the requirements of §63.103(g) of this subpart.

(7) Existing sources shall be in compliance with the provisions of §63.170 of subpart H no later than April 22, 1997.

(8) If an owner or operator of a chemical manufacturing process unit subject to the provisions of subparts F, G, and H of part 63 plans to implement pollution prevention measures to eliminate the use or production of HAP listed in table 2 of this subpart by October 23, 1995, the provisions of subpart H do not apply regardless of the compliance dates specified in paragraph (k)(3) of this section. The owner or operator who elects to use this provision shall comply with the requirements of §63.103(h) of this subpart.

(9) All terms in this subpart F or subpart G of this part that define a period of time for completion of required tasks (e.g., weekly, monthly, quarterly, annual), unless specified otherwise in the section or subsection that imposes the requirement, refer to the standard calendar periods.

(i) Notwithstanding time periods specified in this subpart F or subpart G of this part for completion of required tasks, such time periods may be changed by mutual agreement between the owner or operator and the Administrator, as specified in subpart A of this part (e.g., a period could begin on the compliance date or another date, rather than on the first day of the standard calendar period). For each time period that is changed by agreement, the revised period shall remain in effect until it is changed. A new request is not necessary for each recurring period.

(ii) Where the period specified for compliance is a standard calendar period, if the initial compliance date occurs after the beginning of the period, compliance shall be required according to the schedule specified in paragraphs (k)(9)(ii)(A) or (k)(9)(ii)(B) of this section, as appropriate.

(A) Compliance shall be required before the end of the standard calendar period within which the compliance deadline occurs, if there remain at least 3 days for tasks that must be performed weekly, at least 2 weeks for tasks that must be performed monthly, at least 1 month for tasks that must be performed each quarter, or at least 3 months for tasks that must be performed annually; or

(B) In all other cases, compliance shall be required before the end of the first full standard calendar period after the period within which the initial compliance deadline occurs.

(iii) In all instances where a provision of this subpart F or subpart G of this part requires completion of a task during each of multiple successive periods, an owner or operator may perform the required task at any time during the specified period, provided the task is conducted at a reasonable interval after completion of the task during the previous period.

(l)(1) If an additional chemical manufacturing process unit meeting the criteria specified in paragraph (b) of this section is added to a plant site that is a major source as defined in section 112(a) of the Act, the addition shall be subject to the requirements for a new source in subparts F, G, and H of this part if:

(i) It is an addition that meets the definition of construction in §63.2 of subpart A of this part;

(ii)(A) Such construction commenced after December 31, 1992 for chemical manufacturing process units that produce as a primary product one or more of the chemicals listed in table 1 of this subpart;

(B) Such construction commenced after August 22, 1997 for chemical manufacturing process units that produce as a primary product one or more of the chemicals listed in paragraph (b)(1)(ii) of this section; and

(iii) The addition has the potential to emit 10 tons per year or more of any HAP or 25 tons per year or more of any combination of HAP's, unless the Administrator establishes a lesser quantity.

(2) If any change is made to a chemical manufacturing process unit subject to this subpart, the change shall be subject to the requirements of a new source in subparts F, G, and H of this part if:

(i) It is a change that meets the definition of reconstruction in §63.2 of subpart A of this part; and

(ii)(A) Such reconstruction commenced after December 31, 1992 for chemical manufacturing process units that produce as a primary product one or more of the chemicals listed in table 1 of this subpart; and

(B) Such construction commenced after August 22, 1997 for chemical manufacturing process units that produce as a primary product one or more of the chemicals listed in paragraph (b)(1)(ii) of this section.

(3) If an additional chemical manufacturing process unit is added to a plant site or a change is made to a chemical manufacturing process unit and the addition or change is determined to be subject to the new source requirements according to paragraph (l)(1) or (l)(2) of this section:

(i) The new or reconstructed source shall be in compliance with the new source requirements of subparts F, G, and H of this part upon initial start-up of the new or reconstructed source or by April 22, 1994, whichever is later; and

(ii) The owner or operator of the new or reconstructed source shall comply with the reporting and recordkeeping requirements in subparts F, G, and H of this part that are applicable to new sources. The applicable reports include, but are not limited to:

(A) The application for approval of construction or reconstruction which shall be submitted by the date specified in §63.151(b)(2)(ii) of subpart G of this part, or an Initial Notification as specified in §63.151(b)(2)(iii) of subpart G of this part;

(B) Changes that meet the criteria in §63.151(j) of subpart G of this part, unless the information has been submitted in an operating permit application or amendment;

(C) The Notification of Compliance Status as required by §63.152(b) of subpart G of this part for the new or reconstructed source;

(D) Periodic Reports and Other Reports as required by §63.152(c) and (d) of subpart G of this part;

(E) Reports required by §63.182 of subpart H of this part; and

(F) Reports and notifications required by sections of subpart A of this part that are applicable to subparts F, G, and H of this part, as identified in table 3 of this subpart.

(4) If an additional chemical manufacturing process unit is added to a plant site, or if an emission point is added to an existing chemical manufacturing process unit, or if another deliberate operational process change creating an additional Group 1 emission point(s) is made to an existing chemical manufacturing process unit, or if a surge control vessel or bottoms receiver becomes subject to §63.170 of subpart H, or if a compressor becomes subject to §63.164 of subpart H, and if the addition or change is not subject to the new source requirements as determined according to paragraph (l)(1) or (l)(2) of this section, the requirements in paragraphs (l)(4)(i) through (l)(4)(iii) of this section shall apply. Examples of process changes include, but are not limited to, changes in production capacity, feedstock type, or catalyst type, or whenever there is replacement, removal, or addition of recovery equipment. For purposes of this paragraph and paragraph (m) of this section, process changes do not include: Process upsets, unintentional temporary process changes, and changes that are within the equipment configuration and operating conditions documented in the Notification of Compliance Status required by §63.152(b) of subpart G of this part.

(i) The added emission point(s) and any emission point(s) within the added or changed chemical manufacturing process unit are subject to the requirements of subparts F, G, and H of this part for an existing source;

(ii) The added emission point(s) and any emission point(s) within the added or changed chemical manufacturing process unit shall be in compliance with subparts F, G, and H of this part by the dates specified in paragraph (l)(4)(ii) (A) or (B) of this section, as applicable.

(A) If a chemical manufacturing process unit is added to a plant site or an emission point(s) is added to an existing chemical manufacturing process unit, the added emission point(s) shall be in compliance upon initial start-up of the added chemical manufacturing process unit or emission point(s) or by 3 years after April 22, 1994, whichever is later.

(B) If a deliberate operational process change to an existing chemical manufacturing process unit causes a Group 2 emission point to become a Group 1 emission point, if a surge control vessel or bottoms receiver becomes subject to §63.170 of subpart H, or if a compressor becomes subject to §63.164 of subpart H, the owner or operator shall be in compliance upon initial start-up or by 3 years after April 22, 1994, whichever is later, unless the owner or operator demonstrates to the Administrator that achieving compliance will take longer than making the change. If this demonstration is made to the Administrator's satisfaction, the owner or operator shall follow the procedures in paragraphs (m)(1) through (m)(3) of this section to establish a compliance date.

(iii) The owner or operator of a chemical manufacturing process unit or emission point that is added to a plant site and is subject to the requirements for existing sources shall comply with the reporting and recordkeeping requirements of subparts F, G, and H of this part that are applicable to existing sources, including, but not limited to, the reports listed in paragraphs (l)(4)(iii) (A) through (E) of this section. A change to an existing chemical manufacturing process unit shall be subject to the reporting requirements for existing sources, including but not limited to, the reports listed in paragraphs (l)(4)(iii)(A) through (E) of this section if the change meets the criteria specified in §63.118(g), (h), (i), or (j) of subpart G of this part

for process vents or the criteria in §63.155(i) or (j) of subpart G of this part. The applicable reports include, but are not limited to:

(A) Reports specified in §63.151(i) and (j) of subpart G of this part, unless the information has been submitted in an operating permit application or amendment;

(B) The Notification of Compliance Status as required by §63.152(b) of subpart G of this part for the emission points that were added or changed;

(C) Periodic Reports and other reports as required by §63.152 (c) and (d) of subpart G of this part;

(D) Reports required by §63.182 of subpart H of this part; and

(E) Reports and notifications required by sections of subpart A of this part that are applicable to subparts F, G, and H of this part, as identified in table 3 of this subpart.

(m) If a change that does not meet the criteria in paragraph (l)(4) of this section is made to a chemical manufacturing process unit subject to subparts F and G of this part, and the change causes a Group 2 emission point to become a Group 1 emission point (as defined in §63.111 of subpart G of this part), then the owner or operator shall comply with the requirements of subpart G of this part for the Group 1 emission point as expeditiously as practicable, but in no event later than 3 years after the emission point becomes Group 1.

(1) The owner or operator shall submit to the Administrator for approval a compliance schedule, along with a justification for the schedule.

(2) The compliance schedule shall be submitted with the report required in §63.151(i)(2) of subpart G of this part for emission points included in an emissions average or §63.151(j)(1) or subpart G of this part for emission points not in an emissions average, unless the compliance schedule has been submitted in an operating permit application or amendment.

(3) The Administrator shall approve the compliance schedule or request changes within 120 calendar days of receipt of the compliance schedule and justification.

(n) *Rules stayed for reconsideration.* Notwithstanding any other provision of this subpart, the effectiveness of subpart F is stayed from October 24, 1994, to April 24, 1995, only as applied to those sources for which the owner or operator makes a representation in writing to the Administrator that the resolution of the area source definition issues could have an effect on the compliance status of the source with respect to subpart F.

(o) *Sections stayed for reconsideration.* Notwithstanding any other provision of this subpart, the effectiveness of §§63.164 and 63.170 of subpart H is stayed from October 28, 1994, to April 24, 1995, only as applied to those sources subject to §63.100(k)(3) (i) and (ii).

(p) *Compliance dates for chemical manufacturing process units that produce crotonaldehyde or tetrahydrobenzaldehyde.* Notwithstanding the provisions of paragraph (k) of this section, chemical manufacturing process units that meet the criteria in paragraphs (b)(1)(ii), (b)(2), and (b)(3) of this section shall be in compliance with this subpart and subparts G and H of this part by the dates specified in paragraphs (p)(1) and (p)(2) of this section, as applicable.

(1) If the source consists only of chemical manufacturing process units that produce as a primary product one or more of the chemicals listed in paragraph (b)(1)(ii) of this section, new sources shall

comply by the date specified in paragraph (p)(1)(i) of this section and existing sources shall comply by the dates specified in paragraphs (p)(1)(ii) and (p)(1)(iii) of this section.

(i) Upon initial start-up or May 12, 1998, whichever is later.

(ii) This subpart and subpart G of this part by May 14, 2001, unless an extension has been granted by the Administrator as provided in §63.151(a)(6) or granted by the permitting authority as provided in §63.6(i) of subpart A of this part. When April 22, 1994 is referred to in this subpart and subpart G of this part, May 12, 1998 shall be used as the applicable date for that provision. When December 31, 1992 is referred to in this subpart and subpart G of this part, August 22, 1997 shall be used as the applicable date for that provision.

(iii) Subpart H of this part by May 12, 1999, unless an extension has been granted by the Administrator as provided in §63.151(a)(6) or granted by the permitting authority as provided in §63.6(i) of subpart A of this part. When April 22, 1994 is referred to in subpart H of this part, May 12, 1998 shall be used as the applicable date for that provision. When December 31, 1992 is referred to in subpart H of this part, August 22, 1997 shall be used as the applicable date for that provision.

(2) If the source consists of a combination of chemical manufacturing process units that produce as a primary product one or more of the chemicals listed in paragraphs (b)(1)(i) and (b)(1)(ii) of this section, new chemical manufacturing process units that meet the criteria in paragraph (b)(1)(ii) of this section shall comply by the date specified in paragraph (p)(1)(i) of this section and existing chemical manufacturing process units producing crotonaldehyde and/or tetrahydrobenzaldehyde shall comply by the dates specified in paragraphs (p)(1)(ii) and (p)(1)(iii) of this section.

(q) If the owner or operator of a process vent, or of a gas stream transferred subject to §63.113(i), is unable to comply with the provisions of §§63.113 through 63.118 by the applicable compliance date specified in paragraph (k),(l), or (m) of this section for the reasons stated in paragraph (q)(1),(3), or (5) of this section, the owner or operator shall comply with the applicable provisions in §§63.113 through 63.118 as expeditiously as practicable, but in no event later than the date approved by the Administrator pursuant to paragraph (q)(2), (4), or (6) of this section, respectively. For requests under paragraph (q)(1) or (3) of this section, the date approved by the Administrator may be earlier than, and shall not be later than, the later of January 22, 2004 or 3 years after the transferee's refusal to accept the stream for disposal. For requests submitted under paragraph (q)(5) of this section, the date approved by the Administrator may be earlier than, and shall not be later than, 3 years after the date of publication of the amendments to this subpart or to subpart G of this part which created the need for an extension of the compliance.

(1) If the owner or operator has been sending a gas stream for disposal as described in §63.113(i) prior to January 22, 2001, and the transferee does not submit a written certification as described in §63.113(i)(2) and ceases to accept the gas stream for disposal, the owner or operator shall comply with paragraph (q)(2) of this section.

(2)(i) An owner or operator directed to comply with paragraph (q)(2) of this section shall submit to the Administrator for approval a compliance schedule, along with a justification for the schedule.

(ii) The compliance schedule and justification shall be submitted no later than 90 days after the transferee ceases to accept the gas stream for disposal.

(iii) The Administrator shall approve the compliance schedule or request changes within 120 days of receipt of the compliance schedule and justification.

(3) If the owner or operator has been sending the gas stream for disposal as described in §63.113(i) to a transferee who had submitted a written certification as described in §63.113(i)(2), and the transferee

revokes its written certification, the owner or operator shall comply with paragraph (q)(4) of this section. During the period between the date when the owner or operator receives notice of revocation of the transferee's written certification and the compliance date established under paragraph (q)(4) of this section, the owner or operator shall implement, to the extent reasonably available, measures to prevent or minimize excess emissions to the extent practical. For purposes of this paragraph (q)(3), the term "excess emissions" means emissions in excess of those that would have occurred if the transferee had continued managing the gas stream in compliance with the requirements in §§63.113 through 63.118. The measures to be taken shall be identified in the applicable startup, shutdown, and malfunction plan. If the measures that can be reasonably taken will change over time, so that a more effective measure which could not reasonably be taken initially would be reasonable at a later date, the Administrator may require the more effective measure by a specified date (in addition to or instead of any other measures taken sooner or later than that date) as a condition of approval of the compliance schedule.

(4)(i) An owner or operator directed to comply with this paragraph (q)(4) shall submit to the Administrator for approval the documents specified in paragraphs (q)(4)(i)(A) through (E) of this section no later than 90 days after the owner or operator receives notice of revocation of the transferee's written certification.

(A) A request for determination of a compliance date.

(B) A justification for the request for determination of a compliance date.

(C) A compliance schedule.

(D) A justification for the compliance schedule.

(E) A description of the measures that will be taken to minimize excess emissions until the new compliance date, and the date when each measure will first be implemented. The owner or operator shall describe how, and to what extent, each measure will minimize excess emissions, and shall justify any period of time when measures are not in place.

(ii) The Administrator shall approve or disapprove the request for determination of a compliance date and the compliance schedule, or request changes, within 120 days after receipt of the documents specified in paragraphs (q)(4)(i)(A) through (E) of this section. Upon approving the request for determination and compliance schedule, the Administrator shall specify a reasonable compliance date consistent with the introductory text in paragraph (q) of this section.

(5) If the owner's or operator's inability to meet otherwise applicable compliance deadlines is due to amendments of this subpart or of subpart G of this part published on or after January 22, 2001 and neither condition specified in paragraph (q)(1) or (3) of this section is applicable, the owner or operator shall comply with paragraph (q)(6) of this section.

(6)(i) An owner or operator directed to comply with this paragraph (6)(i) shall submit to the Administrator for approval, a request for determination of a compliance date, a compliance schedule, a justification for the determination of a compliance date, and a justification for the compliance schedule.

(ii) The documents required to be submitted under paragraph (q)(6)(i) of this section shall be submitted no later than 120 days after publication of the amendments of this subpart or of subpart G of this part which necessitate the request for an extension.

(iii) The Administrator shall approve or disapprove the request for a determination of a compliance date, or request changes, within 120 days after receipt of the request for determination of a compliance date, the compliance schedule, and the two justifications. If the request for determination of a compliance

date is disapproved, the compliance schedule is disapproved and the owner or operator shall comply by the applicable date specified in paragraph (k),(l), or (m) of this section. If the request for the determination of a compliance date is approved, the Administrator shall specify, at the time of approval, a reasonable compliance date consistent with the introductory text in paragraph (q) of this section.

[59 FR 19454, Apr. 22, 1994, as amended at 59 FR 53360, Oct. 24, 1994; 59 FR 54132, Oct. 28, 1994; 60 FR 5321, Jan. 27, 1995; 60 FR 18023, 18028, Apr. 10, 1995; 60 FR 63626, Dec. 12, 1995; 61 FR 7718, Feb. 29, 1996; 61 FR 64574, Dec. 5, 1996; 62 FR 2729, Jan. 17, 1997; 63 FR 26081, May 12, 1998; 64 FR 20191, Apr. 26, 1999; 66 FR 6927, Jan. 22, 2001]

### **§63.101 Definitions.**

(a) The following terms as used in subparts F, G, and H of this part shall have the meaning given them in subpart A of this part: Act, actual emissions, Administrator, affected source, approved permit program, commenced, compliance date, construction, continuous monitoring system, continuous parameter monitoring system, effective date, emission standard, emissions averaging, EPA, equivalent emission limitation, existing source, Federally enforceable, fixed capital cost, hazardous air pollutant, lesser quantity, major source, malfunction, new source, owner or operator, performance evaluation, performance test, permit program, permitting authority, reconstruction, relevant standard, responsible official, run, standard conditions, State, and stationary source.

(b) All other terms used in this subpart and subparts G and H of this part shall have the meaning given them in the Act and in this section. If the same term is defined in subpart A of this part and in this section, it shall have the meaning given in this section for purposes of subparts F, G, and H of this part.

*Air oxidation reactor* means a device or vessel in which air, or a combination of air and oxygen, is used as an oxygen source in combination with one or more organic reactants to produce one or more organic compounds. Air oxidation reactor includes the product separator and any associated vacuum pump or steam jet.

*Batch operation* means a noncontinuous operation in which a discrete quantity or batch of feed is charged into a unit operation within a chemical manufacturing process unit and processed at one time. Batch operation includes noncontinuous operations in which the equipment is fed intermittently or discontinuously. Addition of raw material and withdrawal of product do not occur simultaneously in a batch operation. After each batch operation, the equipment is generally emptied before a fresh batch is started.

*Batch process vent* means gaseous venting to the atmosphere from a batch operation.

*Bottoms receiver* means a tank that collects distillation bottoms before the stream is sent for storage or for further downstream processing.

*By-product* means a chemical that is produced coincidentally during the production of another chemical.

*Chemical manufacturing process unit* means the equipment assembled and connected by pipes or ducts to process raw materials and to manufacture an intended product. A chemical manufacturing process unit consists of more than one unit operation. For the purpose of this subpart, chemical manufacturing process unit includes air oxidation reactors and their associated product separators and recovery devices; reactors and their associated product separators and recovery devices; distillation units and their associated distillate receivers and recovery devices; associated unit operations; associated recovery devices; and any feed, intermediate and product storage vessels, product transfer racks, and connected ducts and piping. A chemical manufacturing process unit includes pumps, compressors, agitators, pressure relief devices, sampling connection systems, open-ended valves or lines, valves,

connectors, instrumentation systems, and control devices or systems. A chemical manufacturing process unit is identified by its primary product.

*Control device* means any combustion device, recovery device, or recapture device. Such equipment includes, but is not limited to, absorbers, carbon adsorbers, condensers, incinerators, flares, boilers, and process heaters. For process vents (as defined in this section), recapture devices are considered control devices but recovery devices are not considered control devices. For a steam stripper, a primary condenser is not considered a control device.

*Co-product* means a chemical that is produced during the production of another chemical.

*Distillate receiver* means overhead receivers, overhead accumulators, reflux drums, and condenser(s) including ejector-condenser(s) associated with a distillation unit.

*Distillation unit* means a device or vessel in which one or more feed streams are separated into two or more exit streams, each exit stream having component concentrations different from those in the feed stream(s). The separation is achieved by the redistribution of the components between the liquid and the vapor phases by vaporization and condensation as they approach equilibrium within the distillation unit. Distillation unit includes the distillate receiver, reboiler, and any associated vacuum pump or steam jet.

*Emission point* means an individual process vent, storage vessel, transfer rack, wastewater stream, or equipment leak.

*Equipment leak* means emissions of organic hazardous air pollutants from a connector, pump, compressor, agitator, pressure relief device, sampling connection system, open-ended valve or line, valve, surge control vessel, bottoms receiver, or instrumentation system in organic hazardous air pollutant service as defined in §63.161.

*Ethylene process or ethylene process unit* means a chemical manufacturing process unit in which ethylene and/or propylene are produced by separation from petroleum refining process streams or by subjecting hydrocarbons to high temperatures in the presence of steam. The ethylene process unit includes the separation of ethylene and/or propylene from associated streams such as a C<sub>4</sub> product, pyrolysis gasoline, and pyrolysis fuel oil. The ethylene process does not include the manufacture of SOCOMI chemicals such as the production of butadiene from the C<sub>4</sub> stream and aromatics from pyrolysis gasoline.

*Flexible operation unit* means a chemical manufacturing process unit that manufactures different chemical products periodically by alternating raw materials or operating conditions. These units are also referred to as campaign plants or blocked operations.

*Fuel gas* means gases that are combusted to derive useful work or heat.

*Fuel gas system* means the offsite and onsite piping and flow and pressure control system that gathers gaseous stream(s) generated by onsite operations, may blend them with other sources of gas, and transports the gaseous stream for use as fuel gas in combustion devices or in in-process combustion equipment such as furnaces and gas turbines either singly or in combination.

*Heat exchange system* means any cooling tower system or once-through cooling water system (e.g., river or pond water). A heat exchange system can include more than one heat exchanger and can include an entire recirculating or once-through cooling system.



*Impurity* means a substance that is produced coincidentally with the primary product, or is present in a raw material. An impurity does not serve a useful purpose in the production or use of the primary product and is not isolated.

*Initial start-up* means the first time a new or reconstructed source begins production, or, for equipment added or changed as described in §63.100 (l) or (m) of this subpart, the first time the equipment is put into operation. Initial start-up does not include operation solely for testing equipment. For purposes of subpart G of this part, initial start-up does not include subsequent start-ups (as defined in this section) of chemical manufacturing process units following malfunctions or shutdowns or following changes in product for flexible operation units or following recharging of equipment in batch operation. For purposes of subpart H of this part, initial start-up does not include subsequent start-ups (as defined in §63.161 of subpart H of this part) of process units (as defined in §63.161 of subpart H of this part) following malfunctions or process unit shutdowns.

*Loading rack* means a single system used to fill tank trucks and railcars at a single geographic site. Loading equipment and operations that are physically separate (i.e., do not share common piping, valves, and other equipment) are considered to be separate loading racks.

*Maintenance wastewater* means wastewater generated by the draining of process fluid from components in the chemical manufacturing process unit into an individual drain system prior to or during maintenance activities. Maintenance wastewater can be generated during planned and unplanned shutdowns and during periods not associated with a shutdown. Examples of activities that can generate maintenance wastewaters include descaling of heat exchanger tubing bundles, cleaning of distillation column traps, draining of low legs and high point bleeds, draining of pumps into an individual drain system, and draining of portions of the chemical manufacturing process unit for repair.

*On-site* or *On site* means, with respect to records required to be maintained by this subpart, that the records are stored at a location within a major source which encompasses the affected source. On-site includes, but is not limited to, storage at the chemical manufacturing process unit to which the records pertain, or storage in central files elsewhere at the major source.

*Operating permit* means a permit required by 40 CFR part 70 or 71.

*Organic hazardous air pollutant* or *organic HAP* means one of the chemicals listed in table 2 of this subpart.

*Petroleum refining process*, also referred to as a *petroleum refining process unit*, means a process that for the purpose of producing transportation fuels (such as gasoline and diesel fuels), heating fuels (such as fuel gas, distillate, and residual fuel oils), or lubricants separates petroleum or separates, cracks, or reforms unfinished derivatives. Examples of such units include, but are not limited to, alkylation units, catalytic hydrotreating, catalytic hydrorefining, catalytic hydrocracking, catalytic reforming, catalytic cracking, crude distillation, and thermal processes.

*Plant site* means all contiguous or adjoining property that is under common control, including properties that are separated only by a road or other public right-of-way. Common control includes properties that are owned, leased, or operated by the same entity, parent entity, subsidiary, or any combination thereof.

*Process vent* means the point of discharge to the atmosphere (or the point of entry into a control device, if any) of a gas stream if the gas stream has the characteristics specified in §63.107(b) through (h), or meets the criteria specified in §63.107(i). For purposes of §§63.113 through 63.118, all references to the characteristics of a process vent (e.g., flow rate, total HAP concentration, or TRE index value) shall mean the characteristics of the gas stream.

*Process wastewater* means wastewater which, during manufacturing or processing, comes into direct contact with or results from the production or use of any raw material, intermediate product, finished product, by-product, or waste product. Examples are product tank drawdown or feed tank drawdown; water formed during a chemical reaction or used as a reactant; water used to wash impurities from organic products or reactants; water used to cool or quench organic vapor streams through direct contact; and condensed steam from jet ejector systems pulling vacuum on vessels containing organics.

*Product* means a compound or chemical which is manufactured as the intended product of the chemical manufacturing process unit. By-products, isolated intermediates, impurities, wastes, and trace contaminants are not considered products.

*Product separator* means phase separators, flash drums, knock-out drums, decanters, degassers, and condenser(s) including ejector-condenser(s) associated with a reactor or an air oxidation reactor.

*Reactor* means a device or vessel in which one or more chemicals or reactants, other than air, are combined or decomposed in such a way that their molecular structures are altered and one or more new organic compounds are formed. Reactor includes the product separator and any associated vacuum pump or steam jet.

*Recapture device* means an individual unit of equipment capable of and used for the purpose of recovering chemicals, but not normally for use, reuse, or sale. For example, a recapture device may recover chemicals primarily for disposal. Recapture devices include, but are not limited to, absorbers, carbon adsorbers, and condensers.

*Recovery device* means an individual unit of equipment capable of and normally used for the purpose of recovering chemicals for fuel value (i.e., net positive heating value), use, reuse or for sale for fuel value, use, or reuse. Examples of equipment that may be recovery devices include absorbers, carbon adsorbers, condensers, oil-water separators or organic-water separators, or organic removal devices such as decanters, strippers, or thin-film evaporation units. For purposes of the monitoring, recordkeeping, and reporting requirements of subpart G of this part, recapture devices are considered recovery devices.

*Research and development facility* means laboratory and pilot plant operations whose primary purpose is to conduct research and development into new processes and products, where the operations are under the close supervision of technically trained personnel, and is not engaged in the manufacture of products for commercial sale, except in a *de minimis* manner.

*Shutdown* means for purposes including, but not limited to, periodic maintenance, replacement of equipment, or repair, the cessation of operation of a chemical manufacturing process unit or a reactor, air oxidation reactor, distillation unit, waste management unit, equipment required or used to comply with this subpart F, subparts G, or H of this part or the emptying and degassing of a storage vessel. Shutdown does not include the routine rinsing or washing of equipment in batch operation between batches.

*Source* means the collection of emission points to which this subpart applies as determined by the criteria in §63.100 of this subpart. For purposes of subparts F, G, and H of this part, the term *affected source* as used in subpart A of this part has the same meaning as the term *source* defined here.

*Start-up* means the setting into operation of a chemical manufacturing process unit or a reactor, air oxidation reactor, distillation unit, waste management unit, or equipment required or used to comply with this subpart F, subpart G, or H of this part or a storage vessel after emptying and degassing. Start-up includes initial start-up, operation solely for testing equipment, the recharging of equipment in batch operation, and transitional conditions due to changes in product for flexible operation units.

*Start-up, shutdown, and malfunction plan* means the plan required under §63.6(e)(3) of subpart A of this part. This plan details the procedures for operation and maintenance of the source during periods of start-up, shutdown, and malfunction.

*Storage vessel* means a tank or other vessel that is used to store organic liquids that contain one or more of the organic HAP's listed in table 2 of this subpart and that has been assigned, according to the procedures in §63.100(g) of this subpart, to a chemical manufacturing process unit that is subject to this subpart. Storage vessel does not include:

- (1) Vessels permanently attached to motor vehicles such as trucks, railcars, barges, or ships;
- (2) Pressure vessels designed to operate in excess of 204.9 kilopascals and without emissions to the atmosphere;
- (3) Vessels with capacities smaller than 38 cubic meters;
- (4) Vessels storing organic liquids that contain organic hazardous air pollutants only as impurities;
- (5) Bottoms receiver tanks;
- (6) Surge control vessels; or
- (7) Wastewater storage tanks. Wastewater storage tanks are covered under the wastewater provisions.

*Surge control vessel* means feed drums, recycle drums, and intermediate vessels. Surge control vessels are used within a chemical manufacturing process unit when in-process storage, mixing, or management of flow rates or volumes is needed to assist in production of a product.

*Transfer operation* means the loading, into a tank truck or railcar, of organic liquids that contain one or more of the organic hazardous air pollutants listed in table 2 of this subpart from a transfer rack (as defined in this section). Transfer operations do not include loading at an operating pressure greater than 204.9 kilopascals.

*Transfer rack* means the collection of loading arms and loading hoses, at a single loading rack, that are assigned to a chemical manufacturing process unit subject to this subpart according to the procedures specified in §63.100(h) of this subpart and are used to fill tank trucks and/or railcars with organic liquids that contain one or more of the organic hazardous air pollutants listed in table 2 of this subpart. Transfer rack includes the associated pumps, meters, shutoff valves, relief valves, and other piping and valves. Transfer rack does not include:

- (1) Racks, arms, or hoses that only transfer liquids containing organic hazardous air pollutants as impurities;
- (2) Racks, arms, or hoses that vapor balance during all loading operations; or
- (3) Racks transferring organic liquids that contain organic hazardous air pollutants only as impurities.

*Unit operation* means one or more pieces of process equipment used to make a single change to the physical or chemical characteristics of one or more process streams. Unit operations include, but are not limited to, reactors, distillation units, extraction columns, absorbers, decanters, dryers, condensers, and filtration equipment.

*Vapor balancing system* means a piping system that is designed to collect organic hazardous air pollutants vapors displaced from tank trucks or railcars during loading; and to route the collected organic hazardous air pollutants vapors to the storage vessel from which the liquid being loaded originated, or to another storage vessel connected by a common header or to compress and route to a process or a fuel gas system the collected organic hazardous air pollutants vapors.

*Waste management unit* means the equipment, structure(s), and/or device(s) used to convey, store, treat, or dispose of wastewater streams or residuals. Examples of waste management units include: Wastewater tanks, surface impoundments, individual drain systems, and biological wastewater treatment units. Examples of equipment that may be waste management units include containers, air flotation units, oil-water separators or organic-water separators, or organic removal devices such as decanters, strippers, or thin-film evaporation units. If such equipment is used for recovery then it is part of a chemical manufacturing process unit and is not a waste management unit.

*Wastewater* means water that:

(1) Contains either:

(i) An annual average concentration of Table 9 compounds (as defined in §63.111 of subpart G of this part) of at least 5 parts per million by weight and has an annual average flow rate of 0.02 liter per minute or greater, or

(ii) An annual average concentration of Table 9 compounds (as defined in §63.111 of subpart G) of at least 10,000 parts per million by weight at any flow rate, and that

(2) Is discarded from a chemical manufacturing process unit that meets all of the criteria specified in §63.100 (b)(1) through (b)(3) of this subpart. Wastewater is process wastewater or maintenance wastewater.

[59 FR 19454, Apr. 22, 1994, as amended at 60 FR 18024, Apr. 10, 1995; 60 FR 63626, Dec. 12, 1995; 62 FR 2731, Jan. 17, 1997; 65 FR 26497, May 8, 2000; 66 FR 6928, Jan. 22, 2001]

### **§63.102 General standards.**

(a) Owners and operators of sources subject to this subpart shall comply with the requirements of subparts G and H of this part.

(1) The provisions set forth in this subpart F and subpart G of this part shall apply at all times except during periods of start-up or shutdown (as defined in §63.101 of this subpart), malfunction, or non-operation of the chemical manufacturing process unit (or specific portion thereof) resulting in cessation of the emissions to which this subpart F and subpart G of this part apply. However, if a start-up, shutdown, malfunction or period of non-operation of one portion of a chemical manufacturing process unit does not affect the ability of a particular emission point to comply with the specific provisions to which it is subject, then that emission point shall still be required to comply with the applicable provisions of this subpart F and subpart G of this part during the start-up, shutdown, malfunction or period of non-operation. For example, if there is an overpressure in the reactor area, a storage vessel in the chemical manufacturing process unit would still be required to be controlled in accordance with §63.119 of subpart G of the part. Similarly, the degassing of a storage vessel would not affect the ability of a process vent to meet the requirements of §63.113 of subpart G of this part.

(2) The provisions set forth in subpart H of this part shall apply at all times except during periods of start-up or shutdown, as defined in §63.101(b) of this subpart, malfunction, process unit shutdown (as defined in §63.161 of subpart H of this part), or non-operation of the chemical manufacturing process unit

(or specific portion thereof) in which the lines are drained and depressurized resulting in cessation of the emissions to which subpart H of this part applies.

(3) The owner or operator shall not shut down items of equipment that are required or utilized for compliance with the provisions of this subpart F, subpart G or H of this part during times when emissions (or, where applicable, wastewater streams or residuals) are being routed to such items of equipment, if the shutdown would contravene requirements of this subpart F, subpart G or H of this part applicable to such items of equipment. This paragraph does not apply if the item of equipment is malfunctioning, or if the owner or operator must shut down the equipment to avoid damage due to a contemporaneous start-up, shutdown, or malfunction of the chemical manufacturing process unit or portion thereof.

(4) During start-ups, shutdowns, and malfunctions when the requirements of this subpart F, subparts G and/or H of this part do not apply pursuant to paragraphs (a)(1) through (a)(3) of this section, the owner or operator shall implement, to the extent reasonably available, measures to prevent or minimize excess emissions to the extent practical. The general duty to minimize emissions during a period of startup, shutdown, or malfunction does not require the owner or operator to achieve emission levels that would be required by the applicable standard at other times if this is not consistent with safety and good air pollution control practices, nor does it require the owner or operator to make any further efforts to reduce emissions if levels required by the applicable standard have been achieved. Determination of whether such operation and maintenance procedures are being used will be based on information available to the Administrator which may include, but is not limited to, monitoring results, review of operation and maintenance procedures (including the startup, shutdown, and malfunction plan required in §63.6(e)(3)), review of operation and maintenance records, and inspection of the source. The measures to be taken may include, but are not limited to, air pollution control technologies, recovery technologies, work practices, pollution prevention, monitoring, and/or changes in the manner of operation of the source. Back-up control devices are not required, but may be used if available.

(b) If, in the judgment of the Administrator, an alternative means of emission limitation will achieve a reduction in organic HAP emissions at least equivalent to the reduction in organic HAP emissions from that source achieved under any design, equipment, work practice, or operational standards in subpart G or H of this part, the Administrator will publish in the FEDERAL REGISTER a notice permitting the use of the alternative means for purposes of compliance with that requirement.

(1) The notice may condition the permission on requirements related to the operation and maintenance of the alternative means.

(2) Any notice under paragraph (b) of this section shall be published only after public notice and an opportunity for a hearing.

(3) Any person seeking permission to use an alternative means of compliance under this section shall collect, verify, and submit to the Administrator information showing that the alternative means achieves equivalent emission reductions.

(c) Each owner or operator of a source subject to this subpart shall obtain a permit under 40 CFR part 70 or part 71 from the appropriate permitting authority by the date determined by 40 CFR part 70 or part 71, as appropriate.

(1) If the EPA has approved a State operating permit program under 40 CFR Part 70, the permit shall be obtained from the State authority. If the State operating permit program has not been approved, the source shall apply to the EPA Regional Office.

(2) [Reserved]

(d) The requirements in subparts F, G, and H of this part are Federally enforceable under section 112 of the Act on and after the dates specified in §63.100(k) of this subpart.

[59 FR 19454, Apr. 22, 1994, as amended at 60 FR 63626, Dec. 12, 1995; 61 FR 64575, Dec. 5, 1996; 62 FR 2732, Jan. 17, 1997; 71 FR 20455, Apr. 20, 2006]

### **§63.103 General compliance, reporting, and recordkeeping provisions.**

(a) Table 3 of this subpart specifies the provisions of subpart A that apply and those that do not apply to owners and operators of sources subject to subparts F, G, and H of this part.

(b) Initial performance tests and initial compliance determinations shall be required only as specified in subparts G and H of this part.

(1) Performance tests and compliance determinations shall be conducted according to the schedule and procedures in §63.7(a) of subpart A of this part and the applicable sections of subparts G and H of this part.

(2) The owner or operator shall notify the Administrator of the intention to conduct a performance test at least 30 calendar days before the performance test is scheduled to allow the Administrator the opportunity to have an observer present during the test.

(3) Performance tests shall be conducted according to the provisions of §63.7(e) of subpart A of this part, except that performance tests shall be conducted at maximum representative operating conditions for the process. During the performance test, an owner or operator may operate the control or recovery device at maximum or minimum representative operating conditions for monitored control or recovery device parameters, whichever results in lower emission reduction.

(4) Data shall be reduced in accordance with the EPA-approved methods specified in the applicable subpart or, if other test methods are used, the data and methods shall be validated according to the protocol in Method 301 of appendix A of this part.

(5) Performance tests may be waived with approval of the Administrator as specified in §63.7(h)(2) of subpart A of this part. Owners or operators of sources subject to subparts F, G, and H of this part who apply for a waiver of a performance test shall submit the application by the dates specified in paragraph (b)(5)(i) of this section rather than the dates specified in §63.7(h)(3) of subpart A of this part.

(i) If a request is made for an extension of compliance under §63.151(a)(6) of subpart G or §63.6(i) of subpart A of this part, the application for a waiver of an initial performance test shall accompany the information required for the request for an extension of compliance. If no extension of compliance is requested, the application for a waiver of an initial performance test shall be submitted no later than 90 calendar days before the Notification of Compliance Status required in §63.152(b) of subpart G of this part is due to be submitted.

(ii) Any application for a waiver of a performance test shall include information justifying the owner or operator's request for a waiver, such as the technical or economic infeasibility, or the impracticality, of the source performing the required test.

(6) The owner or operator of a flexible operation unit shall conduct all required compliance demonstrations during production of the primary product. The owner or operator is not required to conduct compliance demonstrations for operating conditions during production of a product other than the primary product. Except as otherwise provided in this subpart or in subpart G or subpart H of this part, as applicable, the owner or operator shall operate each control device, recovery device, and/or recapture

device that is required or used for compliance, and associated monitoring systems, without regard for whether the product that is being produced is the primary product or a different product. Except as otherwise provided in this subpart, subpart G and/or subpart H of this part, as applicable, operation of a control device, recapture device and/or recovery device required or used for compliance such that the daily average of monitored parameter values is outside the parameter range established pursuant to §63.152(b)(2), or such that the monitoring data show operation inconsistent with the monitoring plan established pursuant to §63.120(d)(2) or §63.181(g)(1)(iv), shall constitute a violation of the required operating conditions.

(c) Each owner or operator of a source subject to subparts F, G, and H of this part shall keep copies of all applicable reports and records required by subparts F, G, and H of this part for at least 5 years; except that, if subparts G or H require records to be maintained for a time period different than 5 years, those records shall be maintained for the time specified in subpart G or H of this part. If an owner or operator submits copies of reports to the applicable EPA Regional Office, the owner or operator is not required to maintain copies of reports. If the EPA Regional Office has waived the requirement of §63.10(a)(4)(ii) for submittal of copies of reports, the owner or operator is not required to maintain copies of reports.

(1) All applicable records shall be maintained in such a manner that they can be readily accessed. The most recent 6 months of records shall be retained on site or shall be accessible from a central location by computer or other means that provides access within 2 hours after a request. The remaining four and one-half years of records may be retained offsite. Records may be maintained in hard copy or computer-readable form including, but not limited to, on paper, microfilm, computer, floppy disk, magnetic tape, or microfiche.

(2) The owner or operator subject to subparts F, G, and H of this part shall keep the records specified in this paragraph, as well as records specified in subparts G and H.

(i) Records of the occurrence and duration of each start-up, shutdown, and malfunction of operation of process equipment or of air pollution control equipment or continuous monitoring systems used to comply with this subpart F, subpart G, or H of this part during which excess emissions (as defined in §63.102(a)(4)) occur.

(ii) For each start-up, shutdown, and malfunction during which excess emissions (as defined in §63.102(a)(4)) occur, records that the procedures specified in the source's start-up, shutdown, and malfunction plan were followed, and documentation of actions taken that are not consistent with the plan. For example, if a start-up, shutdown, and malfunction plan includes procedures for routing a control device to a backup control device (e.g., the incinerator for a halogenated stream could be routed to a flare during periods when the primary control device is out of service), records must be kept of whether the plan was followed. These records may take the form of a "checklist," or other form of recordkeeping that confirms conformance with the start-up, shutdown, and malfunction plan for the event.

(iii) For continuous monitoring systems used to comply with subpart G of this part, records documenting the completion of calibration checks and maintenance of continuous monitoring systems that are specified in the manufacturer's instructions or other written procedures that provide adequate assurance that the equipment would reasonably be expected to monitor accurately.

(3) Records of start-up, shutdown and malfunction and continuous monitoring system calibration and maintenance are not required if they pertain solely to Group 2 emission points, as defined in §63.111 of subpart G of this part, that are not included in an emissions average.

(d) All reports required under subparts F, G, and H of this part shall be sent to the Administrator at the addresses listed in §63.13 of subpart A of this part, except that requests for permission to use an alternative means of compliance as provided for in §63.102(b) of this subpart and application for approval

of a nominal efficiency as provided for in §63.150 (i)(1) through (i)(6) of subpart G of this part shall be submitted to the Director of the EPA Office of Air Quality Planning and Standards rather than to the Administrator or delegated authority.

(1) Wherever subpart A of this part specifies "postmark" dates, submittals may be sent by methods other than the U.S. Mail (e.g., by fax or courier). Submittals shall be sent on or before the specified date.

(2) If acceptable to both the Administrator and the owner or operator of a source, reports may be submitted on electronic media.

(e) The owner or operator of a chemical manufacturing process unit which meets the criteria of §63.100(b)(1) and §63.100(b)(3), but not the criteria of §63.100(b)(2), shall comply with the requirements of either paragraph (e)(1) or (e)(2) of this section.

(1) Retain information, data, and analysis used to determine that the chemical manufacturing process unit does not use as a reactant or manufacture as a product or co-product any organic hazardous air pollutant. Examples of information that could document this include, but are not limited to, records of chemicals purchased for the process, analyses of process stream composition, engineering calculations, or process knowledge.

(2) When requested by the Administrator, demonstrate that the chemical manufacturing process unit does not use as a reactant or manufacture as a product or co-product any organic hazardous air pollutant.

(f) To qualify for the exemption specified in §63.100(b)(4) of this subpart, the owner or operator shall maintain the documentation of the information required pursuant to §63.100(b)(4)(i), and documentation of any update of this information requested by the EPA Regional Office, and shall provide the documentation to the EPA Regional Office upon request. The EPA Regional Office will notify the owner or operator, after reviewing such documentation, if the source does not qualify for the exemption specified in §63.100(b)(4) of this section. In such cases, compliance with subpart H shall be required no later than 90 days after expiration of the applicable compliance date in §63.100(k)(3), but in no event earlier than 90 days after the date of such notification by the EPA Regional Office. Compliance with this subpart F and subpart G of this part shall be no later than April 22, 1997, or as otherwise specified in §63.100(k)(2)(ii) of this subpart, unless an extension has been granted by the EPA Regional Office or permitting authority as provided in §63.6(i) of subpart A of this part.

(g) An owner or operator who elects to use the compliance extension provisions of §63.100(k)(6)(i) or (ii) shall submit a compliance extension request to the appropriate EPA Regional Office no later than 45 days before the applicable compliance date in §63.100(k)(3), but in no event is submittal required earlier than May 10, 1995. The request shall contain the information specified in §63.100(k)(5)(iv) and the reason compliance can not reasonably be achieved without a process unit shutdown, as defined in 40 CFR 63.161 or without replacement of the compressor or recasting of the distance piece.

(h) An owner or operator who elects to use the compliance extension provisions of §63.100(k)(8) shall submit to the appropriate EPA Regional Office a brief description of the process change, identify the HAP eliminated, and the expected date of cessation of use or production of HAP. The description shall be submitted no later than May 10, 1995, or with the Notice of Compliance Status as required in §63.182(c) of subpart H, whichever is later.

[59 FR 19454, Apr. 22, 1994, as amended at 59 FR 48176, Sept. 20, 1994; 60 FR 18024, Apr. 10, 1995; 62 FR 2733, Jan. 17, 1997; 63 FR 26082, May 12, 1998]

#### **§63.104 Heat exchange system requirements.**



(a) Unless one or more of the conditions specified in paragraphs (a)(1) through (a)(6) of this section are met, owners and operators of sources subject to this subpart shall monitor each heat exchange system used to cool process equipment in a chemical manufacturing process unit meeting the conditions of §63.100 (b)(1) through (b)(3) of this subpart, except for chemical manufacturing process units meeting the condition specified in §63.100(c) of this subpart, according to the provisions in either paragraph (b) or (c) of this section. Whenever a leak is detected, the owner or operator shall comply with the requirements in paragraph (d) of this section.

(1) The heat exchange system is operated with the minimum pressure on the cooling water side at least 35 kilopascals greater than the maximum pressure on the process side.

(2) There is an intervening cooling fluid, containing less than 5 percent by weight of total hazardous air pollutants listed in table 4 of this subpart, between the process and the cooling water. This intervening fluid serves to isolate the cooling water from the process fluid and the intervening fluid is not sent through a cooling tower or discharged. For purposes of this section, discharge does not include emptying for maintenance purposes.

(3) The once-through heat exchange system is subject to a National Pollution Discharge Elimination System (NPDES) permit with an allowable discharge limit of 1 part per million or less above influent concentration or 10 percent or less above influent concentration, whichever is greater.

(4) The once-through heat exchange system is subject to an NPDES permit that:

(i) Requires monitoring of a parameter(s) or condition(s) to detect a leak of process fluids into cooling water;

(ii) Specifies or includes the normal range of the parameter or condition;

(iii) Requires monitoring for the parameters selected as leak indicators no less frequently than monthly for the first six months and quarterly thereafter; and

(iv) Requires the owner or operator to report and correct leaks to the cooling water when the parameter or condition exceeds the normal range.

(5) The recirculating heat exchange system is used to cool process fluids that contain less than 5 percent by weight of total hazardous air pollutants listed in table 4 of this subpart.

(6) The once-through heat exchange system is used to cool process fluids that contain less than 5 percent by weight of total hazardous air pollutants listed in table 9 of subpart G of this part.

(b) The owner or operator who elects to comply with the requirements of paragraph (a) of this section by monitoring the cooling water for the presence of one or more organic hazardous air pollutants or other representative substances whose presence in cooling water indicates a leak shall comply with the requirements specified in paragraphs (b)(1) through (b)(6) of this section. The cooling water shall be monitored for total hazardous air pollutants, total volatile organic compounds, total organic carbon, one or more speciated HAP compounds, or other representative substances that would indicate the presence of a leak in the heat exchange system.

(1) The cooling water shall be monitored monthly for the first 6 months and quarterly thereafter to detect leaks.

(2)(i) For recirculating heat exchange systems (cooling tower systems), the monitoring of speciated hazardous air pollutants or total hazardous air pollutants refers to the hazardous air pollutants listed in table 4 of this subpart.

(ii) For once-through heat exchange systems, the monitoring of speciated hazardous air pollutants or total hazardous air pollutants refers to the hazardous air pollutants listed in table 9 of subpart G of this part.

(3) The concentration of the monitored substance(s) in the cooling water shall be determined using any EPA-approved method listed in part 136 of this chapter as long as the method is sensitive to concentrations as low as 10 parts per million and the same method is used for both entrance and exit samples. Alternative methods may be used upon approval by the Administrator.

(4) The samples shall be collected either at the entrance and exit of each heat exchange system or at locations where the cooling water enters and exits each heat exchanger or any combination of heat exchangers.

(i) For samples taken at the entrance and exit of recirculating heat exchange systems, the entrance is the point at which the cooling water leaves the cooling tower prior to being returned to the process equipment and the exit is the point at which the cooling water is introduced to the cooling tower after being used to cool the process fluid.

(ii) For samples taken at the entrance and exit of once-through heat exchange systems, the entrance is the point at which the cooling water enters and the exit is the point at which the cooling water exits the plant site or chemical manufacturing process units.

(iii) For samples taken at the entrance and exit of each heat exchanger or any combination of heat exchangers in chemical manufacturing process units, the entrance is the point at which the cooling water enters the individual heat exchanger or group of heat exchangers and the exit is the point at which the cooling water exits the heat exchanger or group of heat exchangers.

(5) A minimum of three sets of samples shall be taken at each entrance and exit as defined in paragraph (b)(4) of this section. The average entrance and exit concentrations shall then be calculated. The concentration shall be corrected for the addition of any makeup water or for any evaporative losses, as applicable.

(6) A leak is detected if the exit mean concentration is found to be greater than the entrance mean using a one-sided statistical procedure at the 0.05 level of significance and the amount by which it is greater is at least 1 part per million or 10 percent of the entrance mean, whichever is greater.

(c) The owner or operator who elects to comply with the requirement of paragraph (a) of this section by monitoring using a surrogate indicator of heat exchange system leaks shall comply with the requirements specified in paragraphs (c)(1) through (c)(3) of this section. Surrogate indicators that could be used to develop an acceptable monitoring program are ion specific electrode monitoring, pH, conductivity or other representative indicators.

(1) The owner or operator shall prepare and implement a monitoring plan that documents the procedures that will be used to detect leaks of process fluids into cooling water. The plan shall require monitoring of one or more surrogate indicators or monitoring of one or more process parameters or other conditions that indicate a leak. Monitoring that is already being conducted for other purposes may be used to satisfy the requirements of this section. The plan shall include the information specified in paragraphs (c)(1)(i) and (c)(1)(ii) of this section.

(i) A description of the parameter or condition to be monitored and an explanation of how the selected parameter or condition will reliably indicate the presence of a leak.

(ii) The parameter level(s) or conditions(s) that shall constitute a leak. This shall be documented by data or calculations showing that the selected levels or conditions will reliably identify leaks. The monitoring must be sufficiently sensitive to determine the range of parameter levels or conditions when the system is not leaking. When the selected parameter level or condition is outside that range, a leak is indicated.

(iii) The monitoring frequency which shall be no less frequent than monthly for the first 6 months and quarterly thereafter to detect leaks.

(iv) The records that will be maintained to document compliance with the requirements of this section.

(2) If a substantial leak is identified by methods other than those described in the monitoring plan and the method(s) specified in the plan could not detect the leak, the owner or operator shall revise the plan and document the basis for the changes. The owner or operator shall complete the revisions to the plan no later than 180 days after discovery of the leak.

(3) The owner or operator shall maintain, at all times, the monitoring plan that is currently in use. The current plan shall be maintained on-site, or shall be accessible from a central location by computer or other means that provides access within 2 hours after a request. If the monitoring plan is superseded, the owner or operator shall retain the most recent superseded plan at least until 5 years from the date of its creation. The superseded plan shall be retained on-site (or accessible from a central location by computer or other means that provides access within two hours after a request) for at least 6 months after its creation.

(d) If a leak is detected according to the criteria of paragraph (b) or (c) of this section, the owner or operator shall comply with the requirements in paragraphs (d)(1) and (d)(2) of this section, except as provided in paragraph (e) of this section.

(1) The leak shall be repaired as soon as practical but not later than 45 calendar days after the owner or operator receives results of monitoring tests indicating a leak. The leak shall be repaired unless the owner or operator demonstrates that the results are due to a condition other than a leak.

(2) Once the leak has been repaired, the owner or operator shall confirm that the heat exchange system has been repaired within 7 calendar days of the repair or startup, whichever is later.

(e) Delay of repair of heat exchange systems for which leaks have been detected is allowed if the equipment is isolated from the process. Delay of repair is also allowed if repair is technically infeasible without a shutdown and any one of the conditions in paragraph (e)(1) or (e)(2) of this section is met. All time periods in paragraphs (e)(1) and (e)(2) of this section shall be determined from the date when the owner or operator determines that delay of repair is necessary.

(1) If a shutdown is expected within the next 2 months, a special shutdown before that planned shutdown is not required.

(2) If a shutdown is not expected within the next 2 months, the owner or operator may delay repair as provided in paragraph (e)(2)(i) or (e)(2)(ii) of this section. Documentation of a decision to delay repair shall state the reasons repair was delayed and shall specify a schedule for completing the repair as soon as practical.

(i) If a shutdown for repair would cause greater emissions than the potential emissions from delaying repair, the owner or operator may delay repair until the next shutdown of the process equipment associated with the leaking heat exchanger. The owner or operator shall document the basis for the determination that a shutdown for repair would cause greater emissions than the emissions likely to result from delaying repair as specified in paragraphs (e)(2)(i)(A) and (e)(2)(i)(B) of this section.

(A) The owner or operator shall calculate the potential emissions from the leaking heat exchanger by multiplying the concentration of total hazardous air pollutants listed in table 4 of this subpart in the cooling water from the leaking heat exchanger by the flowrate of the cooling water from the leaking heat exchanger by the expected duration of the delay. The owner or operator may calculate potential emissions using total organic carbon concentration instead of total hazardous air pollutants listed in table 4 of this subpart.

(B) The owner or operator shall determine emissions from purging and depressurizing the equipment that will result from the unscheduled shutdown for the repair.

(ii) If repair is delayed for reasons other than those specified in paragraph (e)(2)(i) of this section, the owner or operator may delay repair up to a maximum of 120 calendar days. The owner shall demonstrate that the necessary parts or personnel were not available.

(f)(1) *Required records.* The owner or operator shall retain the records identified in paragraphs (f)(1)(i) through (f)(1)(iv) of this section as specified in §63.103(c)(1).

(i) Monitoring data required by this section indicating a leak and the date when the leak was detected, and if demonstrated not to be a leak, the basis for that determination;

(ii) Records of any leaks detected by procedures subject to paragraph (c)(2) of this section and the date the leak was discovered;

(iii) The dates of efforts to repair leaks; and

(iv) The method or procedure used to confirm repair of a leak and the date repair was confirmed.

(2) *Reports.* If an owner or operator invokes the delay of repair provisions for a heat exchange system, the following information shall be submitted in the next semi-annual periodic report required by §63.152(c) of subpart G of this part. If the leak remains unrepaired, the information shall also be submitted in each subsequent periodic report, until repair of the leak is reported.

(i) The owner or operator shall report the presence of the leak and the date that the leak was detected.

(ii) The owner or operator shall report whether or not the leak has been repaired.

(iii) The owner or operator shall report the reason(s) for delay of repair. If delay of repair is invoked due to the reasons described in paragraph (e)(2) of this section, documentation of emissions estimates must also be submitted.

(iv) If the leak remains unrepaired, the owner or operator shall report the expected date of repair.

(v) If the leak is repaired, the owner or operator shall report the date the leak was successfully repaired.

### **§63.105 Maintenance wastewater requirements.**

(a) Each owner or operator of a source subject to this subpart shall comply with the requirements of paragraphs (b) through (e) of this section for maintenance wastewaters containing those organic HAP's listed in table 9 of subpart G of this part.

(b) The owner or operator shall prepare a description of maintenance procedures for management of wastewaters generated from the emptying and purging of equipment in the process during temporary shutdowns for inspections, maintenance, and repair (i.e., a maintenance-turnaround) and during periods which are not shutdowns (i.e., routine maintenance). The descriptions shall:

(1) Specify the process equipment or maintenance tasks that are anticipated to create wastewater during maintenance activities.

(2) Specify the procedures that will be followed to properly manage the wastewater and control organic HAP emissions to the atmosphere; and

(3) Specify the procedures to be followed when clearing materials from process equipment.

(c) The owner or operator shall modify and update the information required by paragraph (b) of this section as needed following each maintenance procedure based on the actions taken and the wastewaters generated in the preceding maintenance procedure.

(d) The owner or operator shall incorporate the procedures described in paragraphs (b) and (c) of this section as part of the startup, shutdown, and malfunction plan required under §63.6(e)(3).

(e) The owner or operator shall maintain a record of the information required by paragraphs (b) and (c) of this section as part of the start-up, shutdown, and malfunction plan required under §63.6(e)(3) of subpart A of this part.

[59 FR 19454, Apr. 22, 1994, as amended at 60 FR 63626, Dec. 12, 1995; 71 FR 20456, Apr. 20, 2006]

### **§63.106 Implementation and enforcement.**

(a) This subpart can be implemented and enforced by the U.S. EPA, or a delegated authority such as the applicable State, local, or Tribal agency. If the U.S. EPA Administrator has delegated authority to a State, local, or Tribal agency, then that agency, in addition to the U.S. EPA, has the authority to implement and enforce this subpart. Contact the applicable U.S. EPA Regional Office to find out if implementation and enforcement of this subpart is delegated to a State, local, or Tribal agency.

(b) In delegating implementation and enforcement authority of this subpart to a State, local, or Tribal agency under subpart E of this part, the authorities contained in paragraph (c) of this section are retained by the Administrator of U.S. EPA and cannot be transferred to the State, local, or Tribal agency.

(c) The authorities that cannot be delegated to State, local, or Tribal agencies are as specified in paragraphs (c)(1) through (4) of this section.

(1) Approval of alternatives to requirements in §§63.100, 63.102, and 63.104. Where these standards reference another subpart, the cited provisions will be delegated according to the delegation provisions of the referenced subpart.

(2) Approval of major alternatives to test methods under §63.7(e)(2)(ii) and (f), as defined in §63.90, and as required in this subpart.

(3) Approval of major alternatives to monitoring under §63.8(f), as defined in §63.90, and as required in this subpart.

(4) Approval of major alternatives to recordkeeping and reporting under §63.10(f), as defined in §63.90, and as required in this subpart.

[68 FR 37344, June 23, 2003]

**§63.107 Identification of process vents subject to this subpart.**

(a) The owner or operator shall use the criteria specified in this §63.107 to determine whether there are any process vents associated with an air oxidation reactor, distillation unit, or reactor that is in a source subject to this subpart. A process vent is the point of discharge to the atmosphere (or the point of entry into a control device, if any) of a gas stream if the gas stream has the characteristics specified in paragraphs (b) through (h) of this section, or meets the criteria specified in paragraph (i) of this section.

(b) Some, or all, of the gas stream originates as a continuous flow from an air oxidation reactor, distillation unit, or reactor during operation of the chemical manufacturing process unit.

(c) The discharge to the atmosphere (with or without passing through a control device) meets at least one of the conditions specified in paragraphs (c)(1) through (3) of this section.

(1) Is directly from an air oxidation reactor, distillation unit, or reactor; or

(2) Is from an air oxidation reactor, distillation unit, or reactor after passing solely (i.e., without passing through any other unit operation for a process purpose) through one or more recovery devices within the chemical manufacturing process unit; or

(3) Is from a device recovering only mechanical energy from a gas stream that comes either directly from an air oxidation reactor, distillation unit, or reactor, or from an air oxidation reactor, distillation unit, or reactor after passing solely (i.e., without passing through any other unit operation for a process purpose) through one or more recovery devices within the chemical manufacturing process unit.

(d) The gas stream contains greater than 0.005 weight percent total organic HAP at the point of discharge to the atmosphere (or at the point of entry into a control device, if any).

(e) The air oxidation reactor, distillation unit, or reactor is part of a chemical manufacturing process unit that meets the criteria of §63.100(b).

(f) The gas stream is in the gas phase from the point of origin at the air oxidation reactor, distillation unit, or reactor to the point of discharge to the atmosphere (or to the point of entry into a control device, if any).

(g) The gas stream is discharged to the atmosphere either on-site, off-site, or both.

(h) The gas stream is not any of the items identified in paragraphs (h)(1) through (9) of this section.

(1) A relief valve discharge.

(2) A leak from equipment subject to subpart H of this part.

(3) A gas stream going to a fuel gas system as defined in §63.101.

(4) A gas stream exiting a control device used to comply with §63.113.

(5) A gas stream transferred to other processes (on-site or off-site) for reaction or other use in another process (i.e., for chemical value as a product, isolated intermediate, byproduct, or coproduct, or for heat value).

(6) A gas stream transferred for fuel value (i.e., net positive heating value), use, reuse, or for sale for fuel value, use, or reuse.

(7) A storage vessel vent or transfer operation vent subject to §63.119 or §63.126.

(8) A vent from a waste management unit subject to §§63.132 through 63.137.

(9) A gas stream exiting an analyzer.

(i) The gas stream would meet the characteristics specified in paragraphs (b) through (g) of this section, but, for purposes of avoiding applicability, has been deliberately interrupted, temporarily liquefied, routed through any item of equipment for no process purpose, or disposed of in a flare that does not meet the criteria in §63.11(b), or an incinerator that does not reduce emissions of organic HAP by 98 percent or to a concentration of 20 parts per million by volume, whichever is less stringent.

[66 FR 6928, Jan. 22, 2001]

**Table 1 to Subpart F of Part 63—Synthetic Organic Chemical Manufacturing Industry Chemicals**

| <b>Chemical name<sup>a</sup></b> | <b>CAS No.<sup>b</sup></b> | <b>Group</b> |
|----------------------------------|----------------------------|--------------|
| Acenaphthene                     | 83329                      | V            |
| Acetal                           | 105577                     | V            |
| Acetaldehyde                     | 75070                      | II           |
| Acetamide                        | 60355                      | II           |
| Acetanilide                      | 103844                     | II           |
| Acetic acid                      | 64197                      | II           |
| Acetic anhydride                 | 108247                     | II           |
| Acetoacetanilide                 | 102012                     | III          |
| Acetone                          | 67641                      | I            |
| Acetone cyanohydrin              | 75865                      | V            |
| Acetonitrile                     | 75058                      | I            |
| Acetophenone                     | 98862                      | I            |
| Acrolein                         | 107028                     | IV           |
| Acrylamide                       | 79061                      | I            |
| Acrylic acid                     | 79107                      | IV           |

|                           |        |     |
|---------------------------|--------|-----|
| Acrylonitrile             | 107131 | I   |
| Adiponitrile              | 111693 | I   |
| Alizarin                  | 72480  | V   |
| Alkyl anthraquinones      | 008    | V   |
| Allyl alcohol             | 107186 | I   |
| Allyl chloride            | 107051 | IV  |
| Allyl cyanide             | 109751 | IV  |
| Aminophenol sulfonic acid | 0010   | V   |
| Aminophenol (p-)          | 123308 | I   |
| Aniline                   | 62533  | I   |
| Aniline hydrochloride     | 142041 | III |
| Anisidine (o-)            | 90040  | II  |
| Anthracene                | 120127 | V   |
| Anthraquinone             | 84651  | III |
| Azobenzene                | 103333 | I   |
| Benzaldehyde              | 100527 | III |
| Benzene                   | 71432  | I   |
| Benzenedisulfonic acid    | 98486  | I   |
| Benzenesulfonic acid      | 98113  | I   |
| Benzil                    | 134816 | III |
| Benzilic acid             | 76937  | III |
| Benzoic acid              | 65850  | III |
| Benzoin                   | 119539 | III |
| Benzonitrile              | 100470 | III |
| Benzophenone              | 119619 | I   |
| Benzotrichloride          | 98077  | III |
| Benzoyl chloride          | 98884  | III |
| Benzyl acetate            | 140114 | III |
| Benzyl alcohol            | 100516 | III |
| Benzyl benzoate           | 120514 | III |



|                                      |          |     |
|--------------------------------------|----------|-----|
| Benzyl chloride                      | 100447   | III |
| Benzyl dichloride                    | 98873    | III |
| Biphenyl                             | 92524    | I   |
| Bisphenol A                          | 80057    | III |
| Bis(Chloromethyl) Ether              | 54288    | I   |
| Bromobenzene                         | 10886    | I   |
| Bromoform                            | 75252    | V   |
| Bromonaphthalene                     | 27497514 | IV  |
| Butadiene (1,3-)                     | 106990   | II  |
| Butanediol (1,4-)                    | 110634   | I   |
| Butyl acrylate (n-)                  | 141322   | V   |
| Butylene glycol (1,3-)               | 107880   | II  |
| Butyrolactone                        | 96480    | I   |
| Caprolactam                          | 105602   | II  |
| Carbaryl                             | 63252    | V   |
| Carbazole                            | 86748    | V   |
| Carbon disulfide                     | 75150    | IV  |
| Carbon tetrabromide                  | 558134   | II  |
| Carbon tetrachloride                 | 56235    | I   |
| Carbon tetrafluoride                 | 75730    | II  |
| Chloral                              | 75876    | II  |
| Chloroacetic acid                    | 79118    | II  |
| Chloroacetophenone (2-)              | 532274   | I   |
| Chloroaniline (p-)                   | 106478   | II  |
| Chlorobenzene                        | 108907   | I   |
| 2-Chloro-1,3-butadiene (Chloroprene) | 126998   | II  |
| Chlorodifluoroethane                 | 25497294 | V   |
| Chlorodifluoromethane                | 75456    | I   |
| Chloroform                           | 67663    | I   |
| Chloronaphthalene                    | 25586430 | IV  |

|                                    |          |     |
|------------------------------------|----------|-----|
| Chloronitrobenzene                 | 121733   | I   |
| (m-).                              |          |     |
| Chloronitrobenzene                 | 88733    | I   |
| (o-).                              |          |     |
| Chloronitrobenzene                 | 100005   | I   |
| (p-).                              |          |     |
| Chlorophenol (m-)                  | 108430   | II  |
| Chlorophenol (o-)                  | 95578    | II  |
| Chlorophenol (p-)                  | 106489   | II  |
| Chlorotoluene (m-)                 | 108418   | III |
| Chlorotoluene (o-)                 | 95498    | III |
| Chlorotoluene (p-)                 | 106434   | III |
| Chlorotrifluoromethane             | 75729    | II  |
| Chrysene                           | 218019   | V   |
| Cresol and cresylic acid (m-)      | 108394   | III |
| Cresol and cresylic acid (o-)      | 95487    | III |
| Cresol and cresylic acid (p-)      | 106445   | III |
| Cresols and cresylic acids (mixed) | 1319773  | III |
| Cumene                             | 98828    | I   |
| Cumene hydroperoxide               | 80159    | I   |
| Cyanoacetic acid                   | 372098   | II  |
| Cyclohexane                        | 110827   | I   |
| Cyclohexanol                       | 108930   | I   |
| Cyclohexanone                      | 108941   | I   |
| Cyclohexylamine                    | 108918   | III |
| Cyclooctadienes                    | 29965977 | II  |
| Decahydronaphthalene               | 91178    | IV  |
| Diacetoxy-2-Butene (1,4-)          | 0012     | V   |
| Diaminophenol hydrochloride        | 137097   | V   |
| Dibromomethane                     | 74953    | V   |

|  |          |     |
|--|----------|-----|
| Dichloroaniline (mixed isomers)                  | 27134276 | I   |
| Dichlorobenzene (p-)                             | 106467   | I   |
| Dichlorobenzene (m-)                             | 541731   | I   |
| Dichlorobenzene (o-)                             | 95501    | I   |
| Dichlorobenzidine                                | 91941    | I   |
| (3,3'-).   |          |     |
| Dichlorodifluoromethane                          | 75718    | I   |
| Dichloroethane (1,2-) (Ethylenedichloride) (EDC) | 107062   | I   |
| Dichloroethyl ether (bis(2-chloroethyl)ether)    | 111444   | I   |
| Dichloroethylene (1,2-)                          | 540590   | II  |
| Dichlorophenol (2,4-)                            | 120832   | III |
| Dichloropropene (1,3-)                           | 542756   | II  |
| Dichlorotetrafluoro-                             | 1320372  | V   |
| ethane.  |          |     |
| Dichloro-1-butene (3,4-)                         | 760236   | II  |
| Dichloro-2-butene (1,4-)                         | 764410   | V   |
| Diethanolamine (2,2'-Iminodiethanol)             | 111422   | I   |
| Diethyl sulfate                                  | 64675    | II  |
| Diethylamine                                     | 109897   | IV  |
| Diethylaniline (2,6-)                            | 579668   | V   |
| Diethylene glycol                                | 111466   | I   |
| Diethylene glycol dibutyl ether                  | 112732   | I   |
| Diethylene glycol diethyl ether                  | 112367   | I   |
| Diethylene glycol dimethyl ether                 | 111966   | I   |
| Diethylene glycol monobutyl ether acetate        | 124174   | I   |
| Diethylene glycol monobutyl ether                | 112345   | I   |
| Diethylene glycol monoethyl ether acetate        | 112152   | I   |
| Diethylene glycol monoethyl ether                | 111900   | I   |
| Diethylene glycol monohexyl ether                | 112594   | V   |
| Diethylene glycol monomethyl ether acetate       | 629389   | V   |

|   |           |     |
|---|-----------|-----|
| Diethylene glycol monomethyl ether      | 111773    | I   |
| Dihydroxybenzoic acid (Resorcylic acid) | 27138574  | V   |
| Dimethylbenzidine                       | 119937    | II  |
| (3,3'-).                                |           |     |
| Dimethyl ether                          | 115106    | IV  |
| Dimethylformamide (N,N-)                | 68122     | II  |
| Dimethylhydrazine                       | 57147     | II  |
| (1,1-).                                 |           |     |
| Dimethyl sulfate                        | 77781     | I   |
| Dimethyl terephthalate                  | 120616    | II  |
| Dimethylamine                           | 124403    | IV  |
| Dimethylaminoethanol (2-)               | 108010    | I   |
| Dimethylaniline (N,N')                  | 121697    | III |
| Dinitrobenzenes (NOS) <sup>c</sup>      | 25154545  | I   |
| Dinitrophenol (2,4-)                    | 51285     | III |
| Dinitrotoluene (2,4-)                   | 121142    | III |
| Dioxane (1,4-) (1,4-Diethyleneoxide)    | 1239      | 11I |
| Dioxolane (1,3-)                        | 646060    | I   |
| Diphenyl methane                        | 101815    | I   |
| Diphenyl oxide                          | 101848    | I   |
| Diphenyl thiourea                       | 102089    | III |
| Diphenylamine                           | 122394    | III |
| Dipropylene glycol                      | 110985    | I   |
| Di-o-tolyguanidine                      | 97392     | III |
| Dodecanedioic acid                      | 693232    | I   |
| Dodecyl benzene (branched)              | 123013    | V   |
| Dodecyl phenol (branched)               | 121158585 | V   |
| Dodecylaniline                          | 28675174  | V   |
| Dodecylbenzene (n-)                     | 121013    | I   |
| Dodecylphenol                           | 27193868  | III |

|   |         |     |
|---|---------|-----|
| Epichlorohydrin (1-chloro-2,3-epoxypropane) | 106898  | I   |
| Ethanolamine                                | 141435  | I   |
| Ethyl acrylate                              | 140885  | II  |
| Ethylbenzene                                | 100414  | I   |
| Ethyl chloride (Chloroethane)               | 75003   | IV  |
| Ethyl chloroacetate                         | 105395  | II  |
| Ethylamine                                  | 75047   | V   |
| Ethylaniline (N-)                           | 103695  | III |
| Ethylaniline (o-)                           | 578541  | III |
| Ethylcellulose                              | 9004573 | V   |
| Ethylcyanoacetate                           | 105566  | V   |
| Ethylene carbonate                          | 96491   | I   |
| Ethylene dibromide (Dibromoethane)          | 106934  | I   |
| Ethylene glycol                             | 107211  | I   |
| Ethylene glycol diacetate                   | 111557  | I   |
| Ethylene glycol dibutyl ether               | 112481  | V   |
| Ethylene glycol diethyl ether               | 629141  | I   |
| (1,2-diethoxyethane).                       |         |     |
| Ethylene glycol                             | 110714  | I   |
| dimethyl ether                              |         |     |
| Ethylene glycol monoacetate                 | 542596  | V   |
| Ethylene glycol monobutyl ether             | 112072  | I   |
| acetate.                                    |         |     |
| Ethylene glycol monobutyl ether             | 111762  | I   |
| Ethylene glycol monoethyl ether             | 111159  | I   |
| acetate.                                    |         |     |
| Ethylene glycol monoethyl ether             | 110805  | I   |
| Ethylene glycol monohexyl ether             | 112254  | V   |
| Ethylene glycol monomethyl ether acetate    | 110496  | I   |
| Ethylene glycol monomethyl ether            | 109864  | I   |

|                                  |         |    |
|----------------------------------|---------|----|
| Ethylene glycol monoethyl ether  | 002     | V  |
| Ethylene glycol monophenyl ether | 122996  | I  |
| Ethylene glycol monopropyl ether | 2807309 | I  |
| Ethylene oxide                   | 75218   | I  |
| Ethylenediamine                  | 107153  | II |
| Ethylenediamine tetraacetic acid | 60004   | V  |
| Ethylenimine (Aziridine)         | 151564  | II |
| Ethylhexyl acrylate (2-isomer)   | 103117  | II |
| Fluoranthene                     | 206440  | V  |
| Formaldehyde                     | 50000   | I  |
| Formamide                        | 75127   | II |
| Formic acid                      | 64186   | II |
| Fumaric acid                     | 110178  | I  |
| Glutaraldehyde                   | 111308  | IV |
| Glyceraldehyde                   | 367475  | V  |
| Glycerol                         | 56815   | II |
| Glycine                          | 56406   | II |
| Glyoxal                          | 107222  | II |
| Hexachlorobenzene                | 118741  | II |
| Hexachlorobutadiene              | 87683   | II |
| Hexachloroethane                 | 67721   | II |
| Hexadiene (1,4-)                 | 592450  | II |
| Hexamethylene-                   | 100970  | I  |
| tetramine.                       |         |    |
| Hexane                           | 110543  | V  |
| Hexanetriol (1,2,6-)             | 106694  | IV |
| Hydroquinone                     | 123319  | I  |
| Hydroxyadipaldehyde              | 141311  | V  |
| Isobutyl acrylate                | 106638  | V  |
| Isobutylene                      | 115117  | V  |

|                                  |          |     |
|----------------------------------|----------|-----|
| Isophorone                       | 78591    | IV  |
| Isophorone nitrile               | 0017     | V   |
| Isophthalic acid                 | 121915   | III |
| Isopropylphenol                  | 25168063 | III |
| Linear alkylbenzene              | __       | dI  |
| Maleic anhydride                 | 108316   | I   |
| Maleic hydrazide                 | 123331   | I   |
| Malic acid                       | 6915157  | I   |
| Metanilic acid                   | 121471   | I   |
| Methacrylic acid                 | 79414    | V   |
| Methanol                         | 67561    | IV  |
| Methionine                       | 63683    | I   |
| Methyl acetate                   | 79209    | IV  |
| Methyl acrylate                  | 96333    | V   |
| Methyl bromide (Bromomethane)    | 74839    | IV  |
| Methyl chloride (Chloromethane)  | 74873    | IV  |
| Methyl ethyl ketone (2-butanone) | 78933    | V   |
| Methyl formate                   | 107313   | II  |
| Methyl hydrazine                 | 60344    | IV  |
| Methyl isobutyl carbinol         | 108112   | IV  |
| Methyl isobutyl ketone (Hexone)  | 108101   | IV  |
| Methyl isocyanate                | 624839   | IV  |
| Methyl mercaptan                 | 74931    | IV  |
| Methyl methacrylate              | 80626    | IV  |
| Methyl phenyl carbinol           | 98851    | II  |
| Methyl tert-butyl ether          | 1634044  | V   |
| Methylamine                      | 74895    | IV  |
| Methylaniline (N-)               | 100618   | III |
| Methylcyclohexane                | 108872   | III |
| Methylcyclohexanol               | 25639423 | V   |

|   |         |     |
|---|---------|-----|
| Methylcyclohexanone                           | 1331222 | III |
| Methylene chloride (Dichloromethane)          | 75092   | I   |
| Methylene dianiline (4,4'-isomer)             | 101779  | I   |
| Methylene diphenyl diisocyanate (4,4'-) (MDI) | 101688  | III |
| Methylionones (a-)                            | 79696   | V   |
| Methylpentynol                                | 77758   | V   |
| Methylstyrene (a-)                            | 98839   | I   |
| Naphthalene                                   | 91203   | IV  |
| Naphthalene sulfonic acid (a-)                | 85472   | IV  |
| Naphthalene sulfonic acid (b-)                | 120183  | IV  |
| Naphthol (a-)                                 | 90153   | IV  |
| Naphthol (b-)                                 | 135193  | IV  |
| Naphtholsulfonic acid (1-)                    | 567180  | V   |
| Naphthylamine sulfonic acid (1,4-)            | 84866   | V   |
| Naphthylamine sulfonic acid (2,1-)            | 81163   | V   |
| Naphthylamine (1-)                            | 134327  | V   |
| Naphthylamine (2-)                            | 91598   | V   |
| Nitroaniline (m-)                             | 99092   | II  |
| Nitroaniline (o-)                             | 88744   | I   |
| Nitroanisole (o-)                             | 91236   | III |
| Nitroanisole (p-)                             | 100174  | III |
| Nitrobenzene                                  | 98953   | I   |
| Nitronaphthalene (1-)                         | 86577   | IV  |
| Nitrophenol (p-)                              | 100027  | III |
| Nitrophenol (o-)                              | 88755   | III |
| Nitropropane (2-)                             | 79469   | II  |
| Nitrotoluene (all isomers)                    | 1321126 | III |
| Nitrotoluene (o-)                             | 88722   | III |
| Nitrotoluene (m-)                             | 99081   | III |
| Nitrotoluene (p-)                             | 99990   | III |



|                                       |          |     |
|---------------------------------------|----------|-----|
| Nitroxylyene                          | 25168041 | V   |
| Nonylbenzene (branched)               | 1081772  | V   |
| Nonylphenol                           | 25154523 | V   |
| Octene-1                              | 111660   | I   |
| Octylphenol                           | 27193288 | III |
| Paraformaldehyde                      | 30525894 | I   |
| Paraldehyde                           | 123637   | II  |
| Pentachlorophenol                     | 87865    | III |
| Pentaerythritol                       | 115775   | I   |
| Peracetic acid                        | 79210    | II  |
| Perchloromethyl mercaptan             | 594423   | IV  |
| Phenanthrene                          | 85018    | V   |
| Phenetidine (p-)                      | 156434   | III |
| Phenol                                | 108952   | III |
| Phenolphthalein                       | 77098    | III |
| Phenolsulfonic acids (all isomers)    | 1333397  | III |
| Phenyl anthranilic acid (all isomers) | 91407    | III |
| Phenylenediamine (p-)                 | 106503   | I   |
| Phloroglucinol                        | 108736   | III |
| Phosgene                              | 75445    | IV  |
| Phthalic acid                         | 88993    | III |
| Phthalic anhydride                    | 85449    | III |
| Phthalimide                           | 85416    | III |
| Phthalonitrile                        | 91156    | III |
| Picoline (b-)                         | 108996   | II  |
| Piperazine                            | 110850   | I   |
| Propiolactone (beta-)                 | 57578    | I   |
| Propionaldehyde                       | 123386   | IV  |
| Propionic acid                        | 79094    | I   |
| Propylene carbonate                   | 108327   | V   |

|  |        |     |
|--|--------|-----|
| Propylene dichloride (1,2-dichloropropane) | 78875  | IV  |
| Propylene glycol                           | 57556  | I   |
| Propylene glycol monomethyl ether          | 107982 | I   |
| Propylene oxide                            | 75569  | I   |
| Pyrene                                     | 129000 | V   |
| Pyridine                                   | 110861 | II  |
| p-tert-Butyl toluene                       | 98511  | III |
| Quinone                                    | 106514 | III |
| Resorcinol                                 | 108463 | I   |
| Salicylic acid                             | 69727  | III |
| Sodium methoxide                           | 124414 | IV  |
| Sodium phenate                             | 139026 | III |
| Stilbene                                   | 588590 | III |
| Styrene                                    | 100425 | I   |
| Succinic acid                              | 110156 | I   |
| Succinonitrile                             | 110612 | I   |
| Sulfanilic acid                            | 121573 | III |
| Sulfolane                                  | 126330 | II  |
| Tartaric acid                              | 526830 | I   |
| Terephthalic acid                          | 100210 | II  |
| Tetrabromophthalic anhydride               | 632791 | III |
| Tetrachlorobenzene (1,2,4,5-)              | 95943  | I   |
| Tetrachloroethane (1,1,2,2-)               | 79345  | II  |
| Tetrachloroethylene (Perchloroethylene)    | 127184 | I   |
| Tetrachlorophthalic-<br>anhydride.         | 117088 | III |
| Tetraethyl lead                            | 78002  | IV  |
| Tetraethylene glycol                       | 112607 | I   |
| Tetraethylene-<br>pentamine.               | 112572 | V   |

|  |          |     |
|--|----------|-----|
| Tetrahydrofuran                              | 109999   | I   |
| Tetrahydronaphthalene                        | 119642   | IV  |
| Tetrahydrophthalic anhydride                 | 85438    | II  |
| Tetramethylene-                              | 110601   | II  |
| diamine.                                     |          |     |
| Tetramethylethylenediamine                   | 110189   | V   |
| Tetramethyllead                              | 75741    | V   |
| Toluene                                      | 108883   | I   |
| Toluene 2,4 diamine                          | 95807    | II  |
| Toluene 2,4 diisocyanate                     | 584849   | II  |
| Toluene diisocyanates (mixture)              | 26471625 | II  |
| Toluene sulfonic acids                       | 104154   | III |
| Toluenesulfonyl chloride                     | 98599    | III |
| Toluidine (o-)                               | 95534    | II  |
| Trichloroaniline-                            | 634935   | III |
| (2,4,6-).                                    |          |     |
| Trichlorobenzene (1,2,3-)                    | 87616    | V   |
| Trichlorobenzene (1,2,4-)                    | 120821   | I   |
| Trichloroethane                              | 71556    | II  |
| (1,1,1-)                                     |          |     |
| Trichloroethane (1,1,2-) (Vinyl trichloride) | 79005    | II  |
| Trichloroethylene                            | 79016    | I   |
| Trichlorofluoromethane                       | 75694    | I   |
| Trichlorophenol                              | 95954    | I   |
| (2,4,5-).                                    |          |     |
| (1,1,2-) Trichloro                           | 76131    | I   |
| (1,2,2-) trifluoroethane.                    |          |     |
| Triethanolamine                              | 102716   | I   |
| Triethylamine                                | 121448   | IV  |
| Triethylene glycol                           | 112276   | I   |

|                                     |          |     |
|-------------------------------------|----------|-----|
| Triethylene glycol                  | 112492   | I   |
| dimethyl ether.                     |          |     |
| Triethylene glycol monoethyl ether  | 112505   | V   |
| Triethylene glycol monomethyl ether | 112356   | I   |
| Trimethylamine                      | 75503    | IV  |
| Trimethylcyclohexanol               | 933482   | IV  |
| Trimethylcyclo-                     | 2408379  | IV  |
| hexanone.                           |          |     |
| Trimethylcyclo-                     | 34216347 | V   |
| hexylamine.                         |          |     |
| Trimethylolpropane                  | 77996    | I   |
| Trimethylpentane (2,2,4-)           | 540841   | V   |
| Tripropylene glycol                 | 24800440 | V   |
| Vinyl acetate                       | 108054   | II  |
| Vinyl chloride (Chloroethylene)     | 75014    | I   |
| Vinyl toluene                       | 25013154 | III |
| Vinylcyclohexene (4-)               | 100403   | II  |
| Vinylidene chloride                 | 75354    | II  |
| (1,1-dichloroethylene).             |          |     |
| Vinyl(N-)-pyrrolidone(2-)           | 88120    | V   |
| Xanthates                           | 140896   | V   |
| Xylene sulfonic acid                | 25321419 | III |
| Xylenes (NOS) <sup>c</sup>          | 1330207  | I   |
| Xylene (m-)                         | 108383   | I   |
| Xylene (o-)                         | 95476    | I   |
| Xylene (p-)                         | 106423   | I   |
| Xylenols (Mixed)                    | 1300716  | V   |
| Xylidene                            | 1300738  | III |

<sup>a</sup>Isomer means all structural arrangements for the same number of atoms of each element and does not mean salts, esters, or derivatives.

<sup>b</sup>CAS Number = Chemical Abstract Service number.

<sup>c</sup>NOS = not otherwise specified.

<sup>d</sup>No CAS number assigned.

[59 FR 19454, Apr. 22, 1994, as amended at 59 FR 48176, Sept. 20, 1994; 61 FR 31439, June 20, 1996; 63 FR 26082, May 12, 1998]

**Table 2 to Subpart F of Part 63—Organic Hazardous Air Pollutants**

| <b>Chemical name<sup>a b</sup></b> | <b>CAS No.<sup>c</sup></b> |
|------------------------------------|----------------------------|
| Acenaphthene                       | 83329                      |
| Acetaldehyde                       | 75070                      |
| Acetamide                          | 60355                      |
| Acetonitrile                       | 75058                      |
| Acetophenone                       | 98862                      |
| Acrolein                           | 107028                     |
| Acrylamide                         | 79061                      |
| Acrylic acid                       | 79107                      |
| Acrylonitrile                      | 107131                     |
| Alizarin                           | 72480                      |
| Allyl chloride                     | 107051                     |
| Aniline                            | 62533                      |
| Anisidine (o-)                     | 90040                      |
| Anthracene                         | 120127                     |
| Anthraquinone                      | 84651                      |
| Benzene                            | 71432                      |
| Benzotrichloride                   | 98077                      |
| Benzyl chloride                    | 100447                     |
| Biphenyl                           | 92524                      |
| Bis(chloromethyl)ether             | 542881                     |
| Bromoform                          | 75252                      |
| Bromonaphthalene                   | 27497514                   |
| Butadiene (1,3-)                   | 106990                     |

|   |          |
|---|----------|
| Carbon disulfide                                  | 75150    |
| Carbon tetrachloride                              | 56235    |
| Chloroacetic acid                                 | 79118    |
| Chloroacetophenone (2-)                           | 532274   |
| Chlorobenzene                                     | 108907   |
| 2-Chloro-,1,3-butadiene (Chloroprene)             | 126998   |
| Chloroform  | 67663    |
| Chloronaphthalene                                 | 25586430 |
| Chrysene  | 218019   |
| Cresols and cresylic acids (mixed)                | 1319773  |
| Cresol and cresylic acid (o-)                     | 95487    |
| Cresol and cresylic acid (m-)                     | 108394   |
| Cresol and cresylic acid (p-)                     | 106445   |
| Cumene  | 98828    |
| Dichlorobenzene (p-)                              | 106467   |
| Dichlorobenzidine (3,3'-)                         | 91941    |
| Dichloroethane (1,2-) (Ethylene dichloride) (EDC) | 107062   |
| Dichloroethylether (Bis(2-chloroethyl)ether)      | 111444   |
| Dichloropropene (1,3-)                            | 542756   |
| Diethanolamine (2,2'-Iminodiethanol)              | 111422   |
| Dimethylaniline (N,N-)                            | 121697   |
| Diethyl sulfate                                   | 64675    |
| Dimethylbenzidine (3,3'-)                         | 119937   |
| Dimethylformamide (N,N-)                          | 68122    |
| Dimethylhydrazine (1,1-)                          | 58147    |
| Dimethylphthalate                                 | 131113   |
| Dimethylsulfate                                   | 77781    |
| Dinitrophenol (2,4-)                              | 51285    |
| Dinitrotoluene (2,4-)                             | 121142   |
| Dioxane (1,4-) (1,4-Diethyleneoxide)              | 123911   |

|   |         |
|---|---------|
| 1,2-Diphenylhydrazine                         | 122667  |
| Epichlorohydrin (1-Chloro-2,3-epoxypropane)   | 106898  |
| Ethyl acrylate                                | 140885  |
| Ethylbenzene                                  | 100414  |
| Ethyl chloride (Chloroethane)                 | 75003   |
| Ethylene dibromide (Dibromoethane)            | 106934  |
| Ethylene glycol                               | 107211  |
| Ethylene oxide                                | 75218   |
| Ethylidene dichloride (1,1-Dichloroethane)    | 75343   |
| Fluoranthene                                  | 206440  |
| Formaldehyde                                  | 50000   |
| Glycol ethers <sup>d</sup>                    |         |
| Hexachlorobenzene                             | 118741  |
| Hexachlorobutadiene                           | 87683   |
| Hexachloroethane                              | 67721   |
| Hexane  | 110543  |
| Hydroquinone                                  | 123319  |
| Isophorone                                    | 78591   |
| Maleic anhydride                              | 108316  |
| Methanol                                      | 67561   |
| Methylbromide (Bromomethane)                  | 74839   |
| Methylchloride (Chloromethane)                | 74873   |
| Methyl hydrazine                              | 60344   |
| Methyl isobutyl ketone (Hexone)               | 108101  |
| Methyl isocyanate                             | 624839  |
| Methyl methacrylate                           | 80626   |
| Methyl tert-butyl ether                       | 1634044 |
| Methylene chloride (Dichloromethane)          | 75092   |
| Methylene diphenyl diisocyanate (4,4'-) (MDI) | 101688  |
| Methylenedianiline (4,4'-)                    | 101779  |

|  |        |
|--|--------|
| Naphthalene                                | 91203  |
| Naphthalene sulfonic acid ( $\alpha$ )     | 85472  |
| Naphthalene sulfonic acid ( $\beta$ )      | 120183 |
| Naphthol ( $\alpha$ )                      | 90153  |
| Naphthol ( $\beta$ )                       | 135193 |
| Naphtholsulfonic acid (1-)                 | 567180 |
| Naphthylamine sulfonic acid (1,4-)         | 84866  |
| Naphthylamine sulfonic acid (2,1-)         | 81163  |
| Naphthylamine (1-)                         | 134327 |
| Naphthylamine (2-)                         | 91598  |
| Nitronaphthalene (1-)                      | 86577  |
| Nitrobenzene                               | 98953  |
| Nitrophenol (p-)                           | 100027 |
| Nitropropane (2-)                          | 79469  |
| Phenanthrene                               | 85018  |
| Phenol                                     | 108952 |
| Phenylenediamine (p-)                      | 106503 |
| Phosgene                                   | 75445  |
| Phthalic anhydride                         | 85449  |
| Propiolactone (beta-)                      | 57578  |
| Propionaldehyde                            | 123386 |
| Propylene dichloride (1,2-Dichloropropane) | 78875  |
| Propylene oxide                            | 75569  |
| Pyrene                                     | 129000 |
| Quinone                                    | 106514 |
| Styrene                                    | 100425 |
| Tetrachloroethane (1,1,2,2-)               | 79345  |
| Tetrachloroethylene (Perchloroethylene)    | 127184 |
| Tetrahydronaphthalene                      | 119642 |
| Toluene                                    | 108883 |



|  |         |
|--|---------|
| Toluene diamine (2,4-)                       | 95807   |
| Toluene diisocyanate (2,4-)                  | 584849  |
| Toluidine (o-)                               | 95534   |
| Trichlorobenzene (1,2,4-)                    | 120821  |
| Trichloroethane (1,1,1-) (Methyl chloroform) | 71556   |
| Trichloroethane (1,1,2-) (Vinyl trichloride) | 79005   |
| Trichloroethylene                            | 79016   |
| Trichlorophenol (2,4,5-)                     | 95954   |
| Triethylamine                                | 121448  |
| Trimethylpentane (2,2,4-)                    | 540841  |
| Vinyl acetate                                | 108054  |
| Vinyl chloride (Chloroethylene)              | 75014   |
| Vinylidene chloride (1,1-Dichloroethylene)   | 75354   |
| Xylenes (NOS)                                | 1330207 |
| Xylene (m-)                                  | 108383  |
| Xylene (o-)                                  | 95476   |
| Xylene (p-)                                  | 106423  |

<sup>a</sup>For all Listings above containing the word "Compounds," the following applies: Unless otherwise specified, these listings are defined as including any unique chemical substance that contains the named chemical (i.e., antimony, arsenic) as part of that chemical's infrastructure.

<sup>b</sup>Isomer means all structural arrangements for the same number of atoms of each element and does not mean salts, esters, or derivatives.

<sup>c</sup>CAS No. = Chemical Abstract Service number.

<sup>d</sup>Includes mono- and di- ethers of ethylene glycol, diethylene glycol, and triethylene glycol R-(OCH<sub>2</sub> CH<sub>2n</sub>-OR where:

n = 1, 2, or 3;

R = alkyl or aryl groups; and

R" = R, H or groups which, when removed, yield glycol ethers with the structure:

R-(OCH<sub>2</sub> CH<sub>2n</sub>-OH

Polymers are excluded from the glycol category.

**Table 3 to Subpart F of Part 63—General Provisions Applicability to Subparts F, G, and H<sup>a</sup> to Subpart F**

| <b>Reference</b>     | <b>Applies to subparts F, G, and H</b> | <b>Comment</b>   |
|----------------------|--|--|
| 63.1(a)(1)           | Yes                                    | Overlap clarified in §63.101, §63.111, §63.161.  |
| 63.1(a)(2)           | Yes                                    |  |
| 63.1(a)(3)           | Yes                                    | §63.110 and §63.160(b) of subparts G and H identify which standards are overridden.  |
| 63.1(a)(4)           | No                                     | Subpart F specifies applicability of each paragraph in subpart A to subparts F, G, and H.  |
| 63.1 (a)(5)-(a)(9)   | No                                     |  |
| 63.1(a)(10)          | No                                     | Subparts F, G, and H specify calendar or operating day.  |
| 63.1(a)(11)          | No                                     | Subpart F §63.103(d) specifies acceptable methods for submitting reports. <sup>a</sup>   |
| 63.1 (a)(12)-(a)(14) | Yes                                    |  |
| 63.1(b)(1)           | No                                     | Subpart F specifies applicability.   |
| 63.1(b)(2)           | Yes                                    |  |
| 63.1(b)(3)           | No                                     |  |
| 63.1(c)(1)           | No                                     | Subpart F specifies applicability.   |
| 63.1(c)(2)           | No                                     | Area sources are not subject to subparts F, G, and H.  |
| 63.1(c)(3)           | No                                     |  |
| 63.1(c)(4)           | Yes                                    |  |
| 63.1(c)(5)           | No                                     | Subparts G and H specify applicable notification requirements.   |
| 63.1(d)              | No                                     |  |
| 63.1(e)              | No                                     | Subparts F, G, and H established before permit program.  |
| 63.2                 | Yes                                    | Subpart F §63.101(a) specifies those subpart A definitions that apply to the HON. Subpart F definition of “source” is equivalent to subpart A definition of “affected source.” |
| 63.3                 | No                                     | Units of measure are spelled out in subparts F, G, and H.  |
| 63.4 (a)(1)-(a)(3)   | Yes                                    |  |

|                 |                                      |  |
|-----------------|--------------------------------------|--|
| 63.4(a)(4)      | No                                   | This is a reserved paragraph in subpart A of part 63.  |
| 63.4(a)(5)      | Yes                                  |  |
| 63.4(b)         | Yes                                  |  |
| 63.4(c)         | Yes                                  |  |
| 63.5(a)(1)      | Yes                                  | Except the terms “source” and “stationary source” in §63.5(a)(1) should be interpreted as having the same meaning as “affected source.”  |
| 63.5(a)(2)      | Yes                                  |  |
| 63.5(b)(1)      | Yes                                  | Except §63.100(l) defines when construction or reconstruction is subject to standards for new sources.   |
| 63.5(b)(2)      | No                                   | This is a reserved paragraph in subpart A of part 63.  |
| 63.5(b)(3)      | Yes                                  |  |
| 63.5(b)(4)      | Yes                                  | Except the cross reference to §63.9(b) is limited to §63.9(b) (4) and (5). Subpart F overrides §63.9 (b)(1) through (b)(3).  |
| 63.5(b)(5)      | Yes                                  |  |
| 63.5(b)(6)      | Yes                                  | Except §63.100(l) defines when construction or reconstruction is subject to standards for new sources.   |
| 63.5(c)         | No                                   | This is a reserved paragraph in subpart A of part 63.  |
| 63.5(d)(1)(i)   | No                                   | For subpart G, see §63.151(b) (2)(ii) and (2)(iii) for the applicability and timing of this submittal; for subpart H, see §63.182(b) (2)(ii) and (b)(2)(iii) for applicability and timing of this submittal. |
| 63.5(d)(1)(ii)  | Yes                                  | Except §63.5(d)(1)(ii)(H) does not apply.  |
| 63.5(d)(1)(iii) | No                                   | Subpart G requires submittal of the Notification of Compliance Status in §63.152(b); subpart H specifies requirements in §63.182(c).   |
| 63.5(d)(2)      | No                                   |  |
| 63.5(d)(3)      | Yes—<br>subpart G<br>No—subpart<br>H | Except §63.5(d)(3)(ii) does not apply to subpart G.  |
| 63.5(d)(4)      | Yes                                  |  |
| 63.5(e)         | Yes                                  |  |
| 63.5(f)(1)      | Yes                                  |  |

|                  |     |   |
|------------------|-----|---|
| 63.5(f)(2)       | Yes | Except the cross-reference to §63.5(d)(1) is changed to §63.151(b)(2)(ii) of subpart G and to §63.182(b)(2)(ii) of subpart H. The cross-reference to §63.5(b)(2) does not apply.  |
| 63.6(a)          | Yes |   |
| 63.6(b)(1)       | No  | Subparts F and H specify compliance dates for sources subject to subparts F, G, and H.  |
| 63.6(b)(2)       | No  |   |
| 63.6(b)(3)       | Yes |   |
| 63.6(b)(4)       | No  | May apply when standards are proposed under Section 112(f) of the Clean Air Act.  |
| 63.6(b)(5)       | No  | Subparts G and H include notification requirements.   |
| 63.6(b)(6)       | No  |   |
| 63.6(b)(7)       | No  |   |
| 63.6(c)(1)       | No  | Subpart F specifies the compliance dates for subparts G and H.  |
| 63.6(c)(2)       | No  |   |
| 63.6(c)(3)       | No  |   |
| 63.6(c)(4)       | No  |   |
| 63.6(c)(5)       | Yes |   |
| 63.6(d)          | No  |   |
| 63.6(e)          | Yes | Except as otherwise specified for individual paragraphs. Does not apply to Group 2 emission points unless they are included in an emissions average. <sup>b</sup>   |
| 63.6(e)(1)(i)    | No  | This is addressed by §63.102(a)(4) of subpart F.  |
| 63.6(e)(1)(ii)   | Yes |   |
| 63.6(e)(1)(iii)  | Yes |   |
| 63.6(e)(2)       | Yes |   |
| 63.6(e)(3)(i)    | Yes | For subpart H, the startup, shutdown, and malfunction plan requirement of §63.6(e)(3)(i) is limited to control devices subject to the provisions of subpart H and is optional for other equipment subject to subpart H. The startup, shutdown, and malfunction plan may include written procedures that identify conditions that justify a delay of repair. |
| 63.6(e)(3)(i)(A) | No  | This is addressed by §63.102(a)(4).   |
| 63.6(e)(3)(i)(B) | Yes |   |

|                                      |                                      |   |
|--------------------------------------|--------------------------------------|---|
| 63.6(e)(3)(i)(C)                     | Yes                                  |   |
| 63.6(e)(3)(ii)                       | Yes                                  |   |
| 63.6(e)(3)(iii)                      | No                                   | Recordkeeping and reporting are specified in §63.103(c)(2) of subpart F and §63.152(d)(1) of subpart G.   |
| 63.6(e)(3)(iv)                       | No                                   | Recordkeeping and reporting are specified in §63.103(c)(2) of subpart F and §63.152(d)(1) of subpart G.   |
| 63.6(e)(3)(v)                        | No                                   | Records retention requirements are specified in §63.103(c).   |
| 63.6(e)(3)(vi)                       | Yes                                  |   |
| 63.6(e)(3)(vii)                      | Yes                                  |   |
| 63.6(e)(3)(vii)(A)                   | Yes                                  |   |
| 63.6(e)(3)(vii)(B)                   | Yes                                  | Except the plan must provide for operation in compliance with §63.102(a)(4).                              |
| 63.6(e)(3)(vii)(C)                   | Yes                                  |   |
| 63.6(e)(3)(viii)                     | Yes                                  |   |
| 63.6(e)(3)(ix)                       | Yes                                  |   |
| 63.6(f)(1)                           | No                                   | §63.102(a) of subpart F specifies when the standards apply.   |
| 63.6(f)(2)(i)                        | Yes                                  |   |
| 63.6(f)(2)(ii)                       | Yes—<br>subpart G<br>No—subpart<br>H | §63.152(c)(2) of subpart G specifies the use of monitoring data in determining compliance with subpart G. |
| 63.6(f)(2)(iii) (A),<br>(B), and (C) | Yes                                  |   |
| 63.6(f)(2)(iii)(D)                   | No                                   |   |
| 63.6(f)(2)(iv)                       | Yes                                  |   |
| 63.6(f)(2)(v)                        | Yes                                  |   |
| 63.6(f)(3)                           | Yes                                  |   |
| 63.6(g)                              | No                                   | Procedures specified in §63.102(b) of subpart F.  |
| 63.6(h)                              | No                                   |   |
| 63.6(i)(1)                           | Yes                                  |   |
| 63.6(i)(2)                           | Yes                                  |   |
| 63.6(i)(3)                           | No                                   | For subpart G, §63.151(a)(6) specifies procedures; for subpart H, §63.182(a)(6) specifies procedures.     |

|                  |     |   |
|------------------|-----|---|
| 63.6(i)(4)(i)(A) | Yes |   |
| 63.6(i)(4)(i)(B) | No  | Dates are specified in §63.151(a)(6)(i) of subpart G and §63.182(a)(6)(i) of subpart H.   |
| 63.6(i)(4)(ii)   | No  |   |
| 63.6(i) (5)-(14) | Yes |   |
| 63.6(i)(15)      | No  |   |
| 63.6(i)(16)      | Yes |   |
| 63.6(j)          | Yes |   |
| 63.7(a)(1)       | No  | Subparts F, G, and H specify required testing and compliance demonstration procedures.  |
| 63.7(a)(2)       | No  | For subpart G, test results must be submitted in the Notification of Compliance Status due 150 days after compliance date, as specified in §63.152(b); for subpart H, all test results subject to reporting are reported in periodic reports. |
| 63.7(a)(3)       | Yes |   |
| 63.7(b)          | No  |   |
| 63.7(c)          | No  |   |
| 63.7(d)          | Yes |   |
| 63.7(e)(1)       | Yes |   |
| 63.7(e)(2)       | Yes |   |
| 63.7(e)(3)       | No  | Subparts F, G, and H specify test methods and procedures.   |
| 63.7(e)(4)       | Yes |   |
| 63.7(f)          | No  | Subparts F, G, and H specify applicable methods and provide alternatives.   |
| 63.7(g)          | No  | Performance test reporting specified in §63.152(b) of subpart G: Not applicable to subpart H because no performance test required by subpart H.   |
| 63.7(h)(1)       | Yes |   |
| 63.7(h)(2)       | Yes |   |
| 63.7(h)(3)       | No  | §63.103(b)(5) of subpart F specifies provisions for requests to waive performance tests.  |
| 63.7(h)(4)       | No  |   |
| 63.7(h)(5)       | Yes |   |

|                    |     |  |
|--------------------|-----|--|
| 63.8(a)(1)         | Yes |  |
| 63.8(a)(2)         | No  |  |
| 63.8(a)(3)         | No  |  |
| 63.8(a)(4)         | Yes |  |
| 63.8(b)(1)         | Yes |  |
| 63.8(b)(2)         | No  | Subparts G and H specify locations to conduct monitoring.  |
| 63.8(b)(3)         | Yes |  |
| 63.8(c)(1)(i)      | Yes |  |
| 63.8(c)(1)(ii)     | No  | For subpart G, submit as part of periodic report required by §63.152(c); for subpart H, retain as required by §63.181(g)(2)(ii).   |
| 63.8(c)(1)(iii)    | Yes |  |
| 63.8(c)(2)         | Yes |  |
| 63.8(c)(3)         | Yes |  |
| 63.8(c)(4)         | No  | Subpart G specifies monitoring frequency by kind of emission point and control technology used (e.g., §63.111, §63.120(d)(2), §63.143, and §63.152(f)); subpart H does not require use of continuous monitoring systems. |
| 63.8 (c)(5)-(c)(8) | No  |  |
| 63.8(d)            | No  |  |
| 63.8(e)            | No  |  |
| 63.8 (f)(1)-(f)(3) | Yes |  |
| 63.8(f)(4)(i)      | No  | Timeframe for submitting request specified in §63.151(f) or (g) of subpart G; not applicable to subpart H because subpart H specifies acceptable alternative methods.  |
| 63.8(f)(4)(ii)     | Yes |  |
| 63.8(f)(4)(iii)    | No  |  |
| 63.8(f)(5)(i)      | Yes |  |
| 63.8(f)(5)(ii)     | No  |  |
| 63.8(f)(5)(iii)    | Yes |  |
| 63.8(f)(6)         | No  | Subparts G and H do not require continuous emission monitoring.  |
| 63.8(g)            | No  | Data reduction procedures specified in §63.152(f) and (g) of   |

|             |     |   |
|-------------|-----|---|
|             |     | subpart G; not applicable to subpart H.   |
| 63.9(a)     | Yes |   |
| 63.9(b)(1)  | No  | Specified in §63.151(b)(2) of subpart G; specified in §63.182(b) of subpart H.  |
| 63.9(b)(2)  | No  | Initial Notification provisions are specified in §63.151(b) of subpart G; in §63.182(b) of subpart H.   |
| 63.9(b)(3)  | No  |   |
| 63.9(b)(4)  | Yes | Except that the notification in §63.9(b)(4)(i) shall be submitted at the time specified in §63.151(b)(2)(ii) of subpart G; in §63.182(b)(2) of subpart H. |
| 63.9(b)(5)  | Yes | Except that the notification in §63.9(b)(5) shall be submitted at the time specified in §63.151(b)(2)(ii) of subpart G; in §63.182(b)(2) of subpart H.    |
| 63.9(c)     | Yes |   |
| 63.9(d)     | Yes |   |
| 63.9(e)     | No  |   |
| 63.9(f)     | No  |   |
| 63.9(g)     | No  |   |
| 63.9(h)     | No  | §63.152(b) of subpart G and §63.182(c) of subpart H specify Notification of Compliance Status requirements.   |
| 63.9(i)     | Yes |   |
| 63.9(j)     | No  |   |
| 63.10(a)    | Yes |   |
| 63.10(b)(1) | No  | §63.103(c) of subpart F specifies record retention requirements.  |
| 63.10(b)(2) | No  | §63.103(c) of subpart F specifies required records.   |
| 63.10(b)(3) | No  |   |
| 63.10(c)    | No  |   |
| 63.10(d)(1) | No  |   |
| 63.10(d)(2) | No  | §63.152(b) of subpart G specifies performance test reporting; not applicable to subpart H.  |
| 63.10(d)(3) | No  |   |
| 63.10(d)(4) | Yes |   |
| 63.10(d)(5) | Yes | Except that reports required by §63.10(d)(5) shall be submitted   |



|             |     |  |
|-------------|-----|--|
|             |     | at the time specified in §63.152(d) of subpart G and in §63.182(d) of subpart H. |
| 63.10(e)    | No  |  |
| 63.10(f)    | Yes |  |
| 63.11-63.15 | Yes |  |

<sup>a</sup>Wherever subpart A specifies “postmark” dates, submittals may be sent by methods other than the U.S. Mail (e.g., by fax or courier). Submittals shall be sent by the specified dates, but a postmark is not necessarily required.

<sup>b</sup>The plan, and any records or reports of start-up, shutdown, and malfunction do not apply to Group 2 emission points unless they are included in an emissions average.

[62 FR 2737, Jan. 17, 1997, as amended at 71 FR 20456, Apr. 20, 2006]

**Table 4 to Subpart F of Part 63—Organic Hazardous Air Pollutants Subject to Cooling Tower Monitoring Requirements in §63.104**

| Chemical name           | CAS Number <sup>a</sup> |
|-------------------------|-------------------------|
| Acetaldehyde            | 75070                   |
| Acetonitrile            | 75058                   |
| Acetophenone            | 98862                   |
| Acrolein                | 107028                  |
| Acrylonitrile           | 107131                  |
| Allyl chloride          | 107051                  |
| Aniline                 | 62533                   |
| Anisidine (o-)          | 90040                   |
| Benzene                 | 71432                   |
| Benzyl chloride         | 100447                  |
| Biphenyl                | 92524                   |
| Bromoform               | 75252                   |
| Butadiene (1,3-)        | 106990                  |
| Carbon disulfide        | 75150                   |
| Carbon tetrachloride    | 56235                   |
| Chloroacetophenone (2-) | 532274                  |

|   |        |
|---|--------|
| Chlorobenzene                                     | 108907 |
| 2-Chloro-1,3-butadiene (Chloroprene)              | 126998 |
| Chloroform  | 67663  |
| Cresol and cresylic acid (o-)                     | 95487  |
| Cresol and cresylic acid (m-)                     | 108394 |
| Cresol and cresylic acid (p-)                     | 106445 |
| Cumene  | 98828  |
| Dichlorobenzene (p-)                              | 106467 |
| Dichlorobenzidine (3,3''-)                        | 91941  |
| Dichloroethane (1,2-) (Ethylene dichloride) (EDC) | 107062 |
| Dichloroethyl ether (Bis(2-chloroethyl)ether)     | 111444 |
| Dichloropropene (1,3-)                            | 542756 |
| Diethylene glycol diethyl ether                   | 112367 |
| Diethylene glycol dimethyl ether                  | 111966 |
| Diethyl sulfate                                   | 64675  |
| Dimethylaniline (N,N-)                            | 121697 |
| Dimethylhydrazine (1,1-)                          | 57147  |
| Dimethyl phthalate                                | 131113 |
| Dimethyl sulfate                                  | 77781  |
| Dinitrophenol (2,4-)                              | 51285  |
| Dinitrotoluene (2,4-)                             | 121142 |
| Dioxane (1,4-) (1,4-Diethyleneoxide)              | 123911 |
| Epichlorohydrin (1-Chloro-2,3-epoxypropane)       | 106898 |
| Ethyl acrylate                                    | 140885 |
| Ethylbenzene                                      | 100414 |
| Ethyl chloride (Chloroethane)                     | 75003  |
| Ethylene dibromide (Dibromoethane)                | 106934 |
| Ethylene glycol dimethyl ether                    | 110714 |
| Ethylene glycol monobutyl ether                   | 111762 |
| Ethylene glycol monobutyl ether acetate           | 112072 |

|  |         |
|--|---------|
| Ethylene glycol monoethyl ether acetate    | 111159  |
| Ethylene glycol monoethyl ether            | 110805  |
| Ethylene glycol monomethyl ether           | 109864  |
| Ethylene glycol monomethyl ether acetate   | 110496  |
| Ethylene glycol monopropyl ether           | 2807309 |
| Ethylene oxide                             | 75218   |
| Ethylidene dichloride (1,1-Dichloroethane) | 75343   |
| Formaldehyde                               | 50000   |
| Hexachlorobenzene                          | 118741  |
| Hexachlorobutadiene                        | 87683   |
| Hexachloroethane                           | 67721   |
| Hexane                                     | 110543  |
| Isophorone                                 | 78591   |
| Methanol                                   | 67561   |
| Methyl bromide (Bromomethane)              | 74839   |
| Methyl chloride (Chloromethane)            | 74873   |
| Methyl hydrazine                           | 60344   |
| Methyl isobutyl ketone (Hexone)            | 108101  |
| Methyl methacrylate                        | 80626   |
| Methyl tert-butyl ether                    | 1634044 |
| Methylene chloride (Dichloromethane)       | 75092   |
| Methylenedianiline (4,4''-)                | 101779  |
| Naphthalene                                | 91203   |
| Nitrobenzene                               | 98953   |
| Nitropropane (2-)                          | 79469   |
| Phenol                                     | 108952  |
| Phenylenediamine (p-)                      | 106503  |
| Phosgene                                   | 75445   |
| Propionaldehyde                            | 123386  |
| Propylene dichloride (1,2-Dichloropropane) | 78875   |

|  |        |
|--|--------|
| Propylene oxide                              | 75569  |
| Quinone                                      | 106514 |
| Styrene                                      | 100425 |
| Tetrachloroethane (1,1,2,2-)                 | 79345  |
| Tetrachloroethylene (Perchloroethylene)      | 127184 |
| Toluene                                      | 108883 |
| Toluidine (o-)                               | 95534  |
| Trichlorobenzene (1,2,4-)                    | 120821 |
| Trichloroethane (1,1,1-) (Methyl chloroform) | 71556  |
| Trichloroethane (1,1,2-) (Vinyl trichloride) | 79005  |
| Trichloroethylene                            | 79016  |
| Trichlorophenol (2,4,5-)                     | 95954  |
| Triethylamine                                | 121448 |
| Trimethylpentane (2,2,4-)                    | 540841 |
| Vinyl acetate                                | 108054 |
| Vinyl chloride (chloroethylene)              | 75014  |
| Vinylidene chloride (1,1-Dichloroethylene)   | 75354  |
| Xylene (m-)                                  | 108383 |
| Xylene (o-)                                  | 95476  |
| Xylene (p-)                                  | 106423 |

<sup>a</sup>CAS Number = Chemical Abstract Service number.

[62 FR 2740, Jan. 17, 1997, as amended at 71 FR 76614, Dec. 21, 2006]

**Appendix D**

40 C.F.R. Part 63, Subpart G – *National Emission Standards for Organic Hazardous Air Pollutants From the Synthetic Organic Chemical Manufacturing Industry for Process Vents, Storage Vessels, Transfer Operations, and Wastewater*

SOURCE: 59 FR 19468, Apr. 22, 1994, unless otherwise noted.

**§63.110 Applicability.**

(a) This subpart applies to all process vents, storage vessels, transfer racks, wastewater streams, and in-process equipment subject to §63.149 within a source subject to subpart F of this part.

(b) *Overlap with other regulations for storage vessels.* (1) After the compliance dates specified in §63.100 of subpart F of this part, a Group 1 or Group 2 storage vessel that is also subject to the provisions of 40 CFR part 60, subpart Kb is required to comply only with the provisions of this subpart.

(2) After the compliance dates specified in §63.100 of subpart F of this part, a Group 1 storage vessel that is also subject to the provisions of 40 CFR part 61, subpart Y is required to comply only with the provisions of this subpart.

(3) After the compliance dates specified in §63.100 of subpart F of this part, a Group 2 storage vessel that is also subject to the provisions of 40 CFR part 61, subpart Y is required to comply only with the provisions of 40 CFR part 61, subpart Y. The recordkeeping and reporting requirements of 40 CFR part 61, subpart Y will be accepted as compliance with the recordkeeping and reporting requirements of this subpart.

(c) *Overlap with other regulations for transfer racks.* (1) After the compliance dates specified in §63.100 of subpart F of this part, a Group 1 transfer rack that is also subject to the provisions of 40 CFR part 61, subpart BB is required to comply only with the provisions of this subpart.

(2) After the compliance dates specified in §63.100 of subpart F of this part, a Group 2 transfer rack that is also subject to the provisions of 40 CFR part 61, subpart BB is required to comply with the provisions of either paragraph (c)(2)(i) or (c)(2)(ii) of this subpart.

(i) If the transfer rack is subject to the control requirements specified in §61.302 of 40 CFR part 61, subpart BB, then the transfer rack is required to comply with the control requirements of §61.302 of 40 CFR part 61, subpart BB. The owner or operator may elect to comply with either the associated testing, monitoring, reporting, and recordkeeping requirements of 40 CFR part 61, subpart BB or with the testing, monitoring, recordkeeping, and reporting requirements specified in this subpart for Group 1 transfer racks. The owner or operator shall indicate this decision in either the Notification of Compliance Status specified in §63.152(b) of this subpart or in an operating permit application or amendment.

(ii) If the transfer rack is subject only to reporting and recordkeeping requirements under 40 CFR part 61, subpart BB, then the transfer rack is required to comply only with the reporting and recordkeeping requirements specified in this subpart for Group 2 transfer racks and is exempt from the reporting and recordkeeping requirements in 40 CFR part 61, subpart BB.

(d) *Overlap with other regulations for process vents.* (1) After the compliance dates specified in §63.100 of subpart F of this part, a Group 1 process vent that is also subject to the provisions of 40 CFR part 60, subpart III is required to comply only with the provisions of this subpart.

(2) After the compliance dates specified in §63.100 of subpart F of this part, the owner or operator of a Group 2 process vent that is also subject to the provisions of 40 CFR part 60, subpart III shall determine requirements according to paragraphs (d)(2)(i) and (d)(2)(ii) of this section.

(i) If the Group 2 process vent has a TRE value less than 1 as determined by the procedures in 40 CFR part 60, subpart III, the process vent is required to comply with the provisions in paragraphs (d)(2)(i)(A) through (d)(2)(i)(C) of this section.

(A) The provisions in both this subpart and in 40 CFR part 60, subpart III for applicability determination and the associated recordkeeping and reporting;

(B) The provisions in both this subpart and in 40 CFR part 60, subpart III for process changes and recalculation of the TRE index value and the associated recordkeeping and reporting; and

(C) The control requirements in §60.612 of 40 CFR part 60, subpart III. The owner or operator may elect to comply with either the associated testing, monitoring, reporting, and recordkeeping requirements of 40 CFR part 60, subpart III or with the testing, monitoring, reporting, and recordkeeping requirements specified in this subpart for Group 1 process vents. The owner or operator shall indicate this decision in either the Notification of Compliance Status specified in §63.152(b) of this subpart or in an operating permit application or amendment.

(ii) If the Group 2 process vent has a TRE value greater than or equal to 1 as determined by the procedures in 40 CFR part 60, subpart III, the process vent is required to comply only with the provisions specified in paragraphs (d)(2)(ii)(A) through (d)(2)(ii)(D) of this section.

(A) The provisions in both this subpart and in 40 CFR part 60, subpart III for applicability determination and the associated recordkeeping and reporting;

(B) The provisions in both this subpart and in 40 CFR part 60, subpart III for process changes and recalculation of the TRE index value and the associated recordkeeping and reporting;

(C) If the provisions of both this subpart and 40 CFR part 60, subpart III require continuous monitoring of recovery device operating parameters, the process vent is required to comply only with the provisions that are specified in this subpart for continuous monitoring of recovery device operating parameters and the associated testing, reporting, and recordkeeping.

(D) If only the provisions of 40 CFR part 60, subpart III require continuous monitoring of recovery device operating parameters, the process vent is required to comply only with the provisions that are specified in 40 CFR part 60, subpart III for continuous monitoring of recovery device operating parameters and the associated testing, reporting, and recordkeeping.

(3) After the compliance dates specified in 63.100 of subpart F of this part, if an owner or operator of a process vent subject to this subpart that is also subject to the provisions of 40 CFR part 60, subpart III elects to control the process vent to the levels required in §63.113 (a)(1) or (a)(2) of this subpart without calculating the TRE index value for the vent according to the procedures specified in §63.115(d) of this subpart then the owner or operator shall comply with the testing, monitoring, reporting, and recordkeeping provisions of this subpart and shall be exempt from the testing, monitoring, reporting, and recordkeeping provisions of 40 CFR part 60, subpart III.

(4) After the compliance dates specified in §63.100 of subpart F of this part, a Group 1 process vent that is also subject to the provisions of 40 CFR part 60, subpart NNN is required to comply only with the provisions of this subpart.

(5) After the compliance dates specified in §63.100 of subpart F of this part, the owner or operator of a Group 2 process vent that is also subject to the provisions of 40 CFR part 60, subpart NNN shall determine requirements according to paragraphs (d)(5)(i) and (d)(5)(ii) of this section.

(i) If the Group 2 process vent has a TRE value less than 1 as determined by the procedures in 40 CFR part 60, subpart NNN, the process vent is required to comply with the provisions in paragraphs (d)(5)(i)(A) through (d)(5)(i)(C) of this section.

(A) The provisions in both this subpart and in 40 CFR part 60, subpart NNN for applicability determination and the associated recordkeeping and reporting;

(B) The provisions in both this subpart and in 40 CFR part 60, subpart NNN for process changes and recalculation of the TRE index value and the associated recordkeeping and reporting; and

(C) The control requirements in §60.662 of 40 CFR part 60, subpart NNN. The owner or operator may elect to comply with either the associated testing, monitoring, reporting, and recordkeeping requirements of 40 CFR part 60, subpart NNN or with the testing, monitoring, reporting, and recordkeeping requirements specified in this subpart for Group 1 process vents. The owner or operator shall indicate this decision in either the Notification of Compliance Status specified in §63.152(b) of this subpart or in an operating permit application or amendment.

(ii) If the Group 2 process vent has a TRE value greater than or equal to 1 as determined by the procedures in 40 CFR part 60, subpart NNN, the process vent is required to comply only with the provisions specified in paragraphs (d)(5)(ii)(A) through (d)(5)(ii)(D) of this section.

(A) The provisions in both this subpart and in 40 CFR part 60, subpart NNN for applicability determination and the associated recordkeeping and reporting;

(B) The provisions in both this subpart and in 40 CFR part 60, subpart NNN for process changes and recalculation of the TRE index value and the associated recordkeeping and reporting;

(C) If the provisions of both this subpart and 40 CFR part 60, subpart NNN require continuous monitoring of recovery device operating parameters, the process vent is required to comply only with the provisions that are specified in this subpart for continuous monitoring of recovery device operating parameters and the associated testing, reporting, and recordkeeping.

(D) If only the provisions of 40 CFR part 60, subpart NNN require continuous monitoring of recovery device operating parameters, the process vent is required to comply only with the provisions that are specified in 40 CFR part 60, subpart NNN for continuous monitoring of recovery device operating parameters and the associated testing, reporting, and recordkeeping.

(6) After the compliance dates specified in §63.100 of subpart F of this part, if an owner or operator of a process vent subject to this subpart that is also subject to the provisions of 40 CFR part 60, subpart NNN elects to control the process vent to the levels required in §63.113(a)(1) or (a)(2) of this subpart without calculating the TRE index value for the vent according to the procedures specified in §63.115(d) of this subpart then the owner or operator shall comply with the testing, monitoring, reporting, and recordkeeping provisions of this subpart and shall be exempt from the testing, monitoring, reporting, and recordkeeping provisions of 40 CFR part 60, subpart NNN.

(7) After the compliance dates specified in §63.100 of subpart F of this part, a Group 1 process vent that is also subject to the provisions of 40 CFR part 60, subpart RRR is required to comply only with the provisions of this subpart.

(8) After the compliance dates specified in §63.100 of subpart F of this part, the owner or operator of a Group 2 process vent that is also subject to the provisions of 40 CFR part 60, subpart RRR shall determine requirements according to paragraphs (d)(8)(i) and (d)(8)(ii) of this section.



(i) If the Group 2 process vent has a TRE value less than 1 as determined by the procedures in 40 CFR part 60, subpart RRR, the process vent is required to comply with the provisions in paragraphs (d)(8)(i)(A) through (d)(8)(i)(C) of this section.

(A) The provisions in both this subpart and in 40 CFR part 60, subpart RRR for applicability determination and the associated recordkeeping and reporting;

(B) The provisions in both this subpart and in 40 CFR part 60, subpart RRR for process changes and recalculation of the TRE index value and the associated recordkeeping and reporting; and

(C) The control requirements in §60.702 of 40 CFR part 60, subpart RRR. The owner or operator may elect to comply with either the associated testing, monitoring, reporting, and recordkeeping requirements of 40 CFR part 60, subpart RRR or with the testing, monitoring, reporting, and recordkeeping requirements specified in this subpart for Group 1 process vents. The owner or operator shall indicate this decision in either the Notification of Compliance Status specified in §63.152(b) of this subpart or in an operating permit application or amendment.

(ii) If the Group 2 process vent has a TRE value greater than or equal to 1 as determined by the procedures in 40 CFR part 60, subpart RRR, the process vent is required to comply only with the provisions specified in paragraphs (d)(8)(ii)(A) through (d)(8)(ii)(D) of this section.

(A) The provisions in both this subpart and in 40 CFR part 60, subpart RRR for applicability determination and the associated recordkeeping and reporting;

(B) The provisions in both this subpart and in 40 CFR part 60, subpart RRR for process changes and recalculation of the TRE index value and the associated recordkeeping and reporting;

(C) If the provisions of both this subpart and 40 CFR part 60, subpart RRR require continuous monitoring of recovery device operating parameters, the process vent is required to comply only with the provisions that are specified in this subpart for continuous monitoring of recovery device operating parameters and the associated testing, reporting, and recordkeeping.

(D) If only the provisions of 40 CFR part 60, subpart RRR require continuous monitoring of recovery device operating parameters, the process vent is required to comply only with the provisions that are specified in 40 CFR part 60, subpart RRR for continuous monitoring of recovery device operating parameters and the associated testing, reporting, and recordkeeping.

(9) After the compliance dates specified in §63.100 of subpart F of this part, if an owner or operator of a process vent subject to this subpart that is also subject to the provisions of 40 CFR part 60, subpart RRR elects to control the process vent to the levels required in §63.113(a)(1) or (a)(2) of this subpart without calculating the TRE index value for the vent according to the procedures specified in §63.115(d) of this subpart then the owner or operator shall comply with the testing, monitoring, reporting, and recordkeeping provisions of this subpart and shall be exempt from the testing, monitoring, reporting, and recordkeeping provisions of 40 CFR part 60, subpart RRR.

(10) As an alternative to the requirements of paragraphs (d)(2), (d)(3), (d)(5), (d)(6), (d)(8), and/or (d)(9) of this section as applicable, if a chemical manufacturing process unit has equipment subject to the provisions of this subpart and equipment subject to the provisions of 40 CFR part 60, subpart III, NNN, or RRR, the owner or operator may elect to apply this subpart to all such equipment in the chemical manufacturing process unit. If the owner or operator elects this method of compliance, all total organic compounds minus methane and ethane, in such equipment shall be considered for purposes of applicability and compliance with this subpart, as if they were organic hazardous air pollutants. Compliance with the provisions of this subpart, in the manner described in this paragraph, shall be deemed to constitute compliance with 40 CFR part 60, subpart III, NNN, or RRR, as applicable.

(e) *Overlap with other regulations for wastewater.* (1) After the compliance dates specified in §63.100 of subpart F of this part, the owner or operator of a Group 1 or Group 2 wastewater stream that is also subject to the provisions of 40 CFR part 61, subpart FF is required to comply with the provisions of both this subpart and 40 CFR part 61, subpart FF. Alternatively, the owner or operator may elect to comply with the provisions of paragraphs (e)(1)(i) and (e)(1)(ii) of this section, which shall constitute compliance with the provisions of 40 CFR part 61, subpart FF.

(i) Comply with the provisions of this subpart; and

(ii) For any Group 2 wastewater stream or organic stream whose benzene emissions are subject to control through the use of one or more treatment processes or waste management units under the provisions of 40 CFR part 61, subpart FF on or after December 31, 1992, comply with the requirements of this subpart for Group 1 wastewater streams.

(2) After the compliance dates specified in §63.100 of subpart F of this part, the owner or operator of any Group 1 or Group 2 wastewater stream that is also subject to provisions in 40 CFR parts 260 through 272 shall comply with the requirements of either paragraph (e)(2)(i) or (e)(2)(ii) of this section.

(i) For each Group 1 or Group 2 wastewater stream, the owner or operator shall comply with the more stringent control requirements (e.g., waste management units, numerical treatment standards, etc.) and the more stringent testing, monitoring, recordkeeping, and reporting requirements that overlap between the provisions of this subpart and the provisions of 40 CFR parts 260 through 272. The owner or operator shall keep a record of the information used to determine which requirements were the most stringent and shall submit this information if requested by the Administrator; or

(ii) The owner or operator shall submit, no later than four months before the applicable compliance date specified in §63.100 of subpart F of this part, a request for a case-by-case determination of requirements. The request shall include the information specified in paragraphs (e)(2)(ii)(A) and (e)(2)(ii)(B) of this section.

(A) Identification of the wastewater streams that are subject to this subpart and to provisions in 40 CFR parts 260 through 272, determination of the Group 1/Group 2 status of those streams, determination of whether or not those streams are listed or exhibit a characteristic as specified in 40 CFR part 261, and determination of whether the waste management unit is subject to permitting under 40 CFR part 270.

(B) Identification of the specific control requirements (e.g., waste management units, numerical treatment standards, etc.) and testing, monitoring, recordkeeping, and reporting requirements that overlap between the provisions of this subpart and the provisions of 40 CFR parts 260 through 272.

(f) *Overlap with the Vinyl Chloride NESHAP.* (1) After the compliance dates specified in §63.100 of subpart F of this part, the owner or operator of any Group 1 process vent that is also subject to the provisions of 40 CFR part 61, subpart F shall comply only with the provisions of this subpart.

(2) After the compliance dates specified in §63.100 of subpart F of this part, the owner or operator of any Group 2 process vent that is also subject to the provisions of 40 CFR part 61, subpart F shall comply with the provisions specified in either paragraph (f)(2)(i) or (f)(2)(ii) of this subpart.

(i) If the process vent is already controlled by a combustion device meeting the requirements of 40 CFR part 61, subpart F, then the owner or operator shall comply with either the associated testing, monitoring, reporting, and recordkeeping provisions for Group 1 process vents in this subpart or the testing, monitoring, reporting, and recordkeeping provisions of 40 CFR part 61, subpart F. The owner or operator shall indicate this decision in either the Notification of Compliance Status specified in §63.152(b) of this subpart or in an operating permit application or amendment.

(ii) If the process vent is not already controlled by a combustion device, then the owner or operator shall comply with the provisions of both this subpart and 40 CFR part 61, subpart F.

(3) After the compliance dates specified in §63.100 of subpart F of this part, if an owner or operator of a process vent subject to this subpart that is also subject to the provisions of 40 CFR part 61, subpart F elects to control the process vent to the levels required in §63.113(a)(1) or (a)(2) of this subpart without calculating the TRE index value for the vent according to the procedures specified in §63.115(d) of this subpart then the owner or operator shall comply with the testing, monitoring, reporting, and recordkeeping provisions of this subpart and shall be exempt from the testing, monitoring, reporting, and recordkeeping provisions of 40 CFR part 61, subpart F.

(4) After the compliance dates specified in §63.100 of subpart F of this part, the owner or operator of a Group 1 or Group 2 wastewater stream that is also subject to the provisions of 40 CFR part 61, subpart F shall comply with the provisions of either paragraph (f)(4)(i) or (f)(4)(ii) of this section.

(i) The owner or operator shall comply with the provisions of both this subpart and 40 CFR part 61, subpart F or

(ii) The owner or operator may submit, no later than four months before the applicable compliance date specified in §63.100 of subpart F of this part, information demonstrating how compliance with 40 CFR Part 61, subpart F, will also ensure compliance with this subpart. The information shall include a description of the testing, monitoring, reporting, and recordkeeping that will be performed.

(g) *Rules stayed for reconsideration.* Notwithstanding any other provision of this subpart, the effectiveness of subpart G is stayed from October 24, 1994, to April 24, 1995, only as applied to those sources for which the owner or operator makes a representation in writing to the Administrator that the resolution of the area source definition issues could have an effect on the compliance status of the source with respect to subpart G.

(h) *Overlap with other regulations for monitoring, recordkeeping, or reporting with respect to combustion devices, recovery devices, or recapture devices.* After the compliance dates specified in §63.100 of subpart F of this part, if any combustion device, recovery device, or recapture device subject to this subpart is also subject to monitoring, recordkeeping, and reporting requirements in 40 CFR part 264, subpart AA or CC, or is subject to monitoring and recordkeeping requirements in 40 CFR part 265, subpart AA or CC and the owner or operator complies with the periodic reporting requirements under 40 CFR part 264, subpart AA or CC that would apply to the device if the facility had final-permitted status, the owner or operator may elect to comply either with the monitoring, recordkeeping, and reporting requirements of this subpart, or with the monitoring, recordkeeping, and reporting requirements in 40 CFR parts 264 and/or 265, as described in this paragraph, which shall constitute compliance with the monitoring, recordkeeping, and reporting requirements of this subpart. The owner or operator shall identify which option has been selected in the Notification of Compliance Status required by §63.152(b).

(i) *Alternative means of compliance—(1) Option to comply with part 65.* Owners or operators of CMPU that are subject to §63.100 may choose to comply with the provisions of 40 CFR part 65 for all Group 1 and Group 2 process vents, Group 1 storage vessels, Group 1 transfer operations, and equipment that are subject to §63.100, that are part of the CMPU. Other provisions applying to owners or operators who choose to comply with 40 CFR part 65 are provided in 40 CFR 65.1. Group 1 and Group 2 wastewater streams, Group 2 transfer operations, Group 2 storage vessels, and in-process streams are not eligible to comply with 40 CFR part 65 and must continue to comply with the requirements of this subpart and subpart F of this part.

(i) For Group 1 and Group 2 process vents, 40 CFR part 65, subpart D, satisfies the requirements of §§63.102, 63.103, 63.112 through 63.118, 63.148, 63.151, and 63.152.

(ii) For Group 1 storage vessels, 40 CFR part 65, subpart C, satisfies the requirements of §§63.102, 63.103, 63.112, 63.119 through 63.123, 63.148, 63.151, and 63.152.

(iii) For Group 1 transfer racks, 40 CFR part 65, subpart E, satisfies the requirements of §§63.102, 63.103, 63.112, 63.126 through 63.130, 63.148, 63.151, and 63.152.

(iv) For equipment, comply with §65.160(g).

(2) *Part 63, subpart A.* Owners or operators who choose to comply with 40 CFR part 65 must also comply with the applicable general provisions of this part 63 listed in table 1A of this subpart. All sections and paragraphs of subpart A of this part that are not mentioned in table 1A of this subpart do not apply to owners or operators who choose to comply with 40 CFR part 65, except that provisions required to be met prior to implementing 40 CFR part 65 still apply. Owners and operators who choose to comply with a subpart of 40 CFR part 65 must comply with 40 CFR part 65, subpart A.

[59 FR 19468, Apr. 22, 1994, as amended at 59 FR 53360, Oct. 24, 1994; 60 FR 5321, Jan. 27, 1995; 61 FR 64575, Dec. 5, 1996; 62 FR 2742, Jan. 17, 1997; 65 FR 78284, Dec. 14, 2000; 66 FR 6929, Jan. 22, 2001]

### **§63.111 Definitions.**

All terms used in this subpart shall have the meaning given them in the Act, in subpart F of this part, and in this section, as follows.

*Air oxidation reactor* means a device or vessel in which air, or a combination of air and oxygen, is used as an oxygen source in combination with one or more organic reactants to produce one or more organic compounds. Air oxidation reactor includes the product separator and any associated vacuum pump or steam jet.

*Annual average concentration*, as used in the wastewater provisions, means the flow-weighted annual average concentration, as determined according to the procedures specified in §63.144(b) of this subpart.

*Annual average flow rate*, as used in the wastewater provisions, means the annual average flow rate, as determined according to the procedures specified in §63.144(c).

*Automated monitoring and recording system* means any means of measuring values of monitored parameters and creating a hard copy or computer record of the measured values that does not require manual reading of monitoring instruments and manual transcription of data values. Automated monitoring and recording systems include, but are not limited to, computerized systems and strip charts.

*Batch operation* means a noncontinuous operation in which a discrete quantity or batch of feed is charged into a unit operation within a chemical manufacturing process unit and distilled or reacted at one time. Batch operation includes noncontinuous operations in which the equipment is fed intermittently or discontinuously. Addition of raw material and withdrawal of product do not occur simultaneously in a batch operation. After each batch operation, the equipment is generally emptied before a fresh batch is started.

*Boiler* means any enclosed combustion device that extracts useful energy in the form of steam and is not an incinerator. Boiler also means any industrial furnace as defined in 40 CFR 260.10.

*By compound* means by individual stream components, not carbon equivalents.

*Car-seal* means a seal that is placed on a device that is used to change the position of a valve (e.g., from opened to closed) in such a way that the position of the valve cannot be changed without breaking the seal.

*Chemical manufacturing process unit* means the equipment assembled and connected by pipes or ducts to process raw materials and to manufacture an intended product. A chemical manufacturing process unit consists of more than one unit operation. For the purpose of this subpart, chemical manufacturing process unit includes air oxidation reactors and their associated product separators and recovery devices; reactors and their associated product separators and recovery devices; distillation units and their associated distillate receivers and recovery devices; associated unit operations; associated recovery devices; and any feed, intermediate and product storage vessels, product transfer racks, and connected ducts and piping. A chemical manufacturing process unit includes pumps, compressors, agitators, pressure relief devices, sampling connection systems, open-ended valves or lines, valves, connectors, instrumentation systems, and control devices or systems. A chemical manufacturing process unit is identified by its primary product.

*Closed biological treatment process* means a tank or surface impoundment where biological treatment occurs and air emissions from the treatment process are routed to either a control device by means of a closed vent system or to a fuel gas system by means of hard-piping. The tank or surface impoundment has a fixed roof, as defined in §63.111 of this subpart, or a floating flexible membrane cover that meets the requirements specified in §63.134 of this subpart.

*Closed-vent system* means a system that is not open to the atmosphere and is composed of piping, ductwork, connections, and, if necessary, flow inducing devices that transport gas or vapor from an emission point to a control device.

*Combustion device* means an individual unit of equipment, such as a flare, incinerator, process heater, or boiler, used for the combustion of organic hazardous air pollutant emissions.

*Container*, as used in the wastewater provisions, means any portable waste management unit that has a capacity greater than or equal to 0.1 m<sup>3</sup> in which a material is stored, transported, treated, or otherwise handled. Examples of containers are drums, barrels, tank trucks, barges, dumpsters, tank cars, dump trucks, and ships.

*Continuous record* means documentation, either in hard copy or computer readable form, of data values measured at least once every 15 minutes and recorded at the frequency specified in §63.152(f) or §63.152(g) of this subpart.

*Continuous recorder* means a data recording device that either records an instantaneous data value at least once every 15 minutes or records 15-minute or more frequent block average values.

*Continuous seal* means a seal that forms a continuous closure that completely covers the space between the wall of the storage vessel and the edge of the floating roof. A continuous seal may be a vapor-mounted, liquid-mounted, or metallic shoe seal. A continuous seal may be constructed of fastened segments so as to form a continuous seal.

*Continuous vapor processing system* means a vapor processing system that treats total organic compound vapors collected from tank trucks or railcars on a demand basis without intermediate accumulation in a vapor holder.

*Control device* means any combustion device, recovery device, or recapture device. Such equipment includes, but is not limited to, absorbers, carbon adsorbers, condensers, incinerators, flares, boilers, and process heaters. For process vents, recapture devices are considered control devices but

recovery devices are not considered control devices, and for a steam stripper, a primary condenser is not considered a control device.

*Cover*, as used in the wastewater provisions, means a device or system which is placed on or over a waste management unit containing wastewater or residuals so that the entire surface area is enclosed to minimize air emissions. A cover may have openings necessary for operation, inspection, and maintenance of the waste management unit such as access hatches, sampling ports, and gauge wells provided that each opening is closed when not in use. Examples of covers include a fixed roof installed on a wastewater tank, a lid installed on a container, and an air-supported enclosure installed over a waste management unit.

*Distillate receiver* means overhead receivers, overhead accumulators, reflux drums, and condenser(s) including ejector-condenser(s) associated with a distillation unit.

*Distillation unit* means a device or vessel in which one or more feed streams are separated into two or more exit streams, each exit stream having component concentrations different from those in the feed stream(s). The separation is achieved by the redistribution of the components between the liquid and the vapor phases by vaporization and condensation as they approach equilibrium within the distillation unit. Distillation unit includes the distillate receiver, reboiler, and any associated vacuum pump or steam jet.

*Duct work* means a conveyance system such as those commonly used for heating and ventilation systems. It is often made of sheet metal and often has sections connected by screws or crimping. Hard-piping is not ductwork.

*Enhanced biological treatment system or enhanced biological treatment process* means an aerated, thoroughly mixed treatment unit(s) that contains biomass suspended in water followed by a clarifier that removes biomass from the treated water and recycles recovered biomass to the aeration unit. The mixed liquor volatile suspended solids (biomass) is greater than 1 kilogram per cubic meter throughout each aeration unit. The biomass is suspended and aerated in the water of the aeration unit(s) by either submerged air flow or mechanical agitation. A thoroughly mixed treatment unit is a unit that is designed and operated to approach or achieve uniform biomass distribution and organic compound concentration throughout the aeration unit by quickly dispersing the recycled biomass and the wastewater entering the unit.

*External floating roof* means a pontoon-type or double-deck-type cover that rests on the liquid surface in a storage vessel or waste management unit with no fixed roof.

*Fill or filling* means the introduction of organic hazardous air pollutant into a storage vessel or the introduction of a wastewater stream or residual into a waste management unit, but not necessarily to complete capacity.

*First attempt at repair* means to take action for the purpose of stopping or reducing leakage of organic material to the atmosphere.

*Fixed roof* means a cover that is mounted on a waste management unit or storage vessel in a stationary manner and that does not move with fluctuations in liquid level.

*Flame zone* means the portion of the combustion chamber in a boiler or process heater occupied by the flame envelope.

*Floating roof* means a cover consisting of a double deck, pontoon single deck, internal floating cover or covered floating roof, which rests upon and is supported by the liquid being contained, and is equipped

with a closure seal or seals to close the space between the roof edge and waste management unit or storage vessel wall.

*Flow indicator* means a device which indicates whether gas flow is, or whether the valve position would allow gas flow to be, present in a line.

*Fuel gas* means gases that are combusted to derive useful work or heat.

*Fuel gas system* means the offsite and onsite piping and control system that gathers gaseous stream(s) generated by onsite operations, may blend them with other sources of gas, and transports the gaseous stream for use as fuel gas in combustion devices, or in-process combustion equipment such as furnaces and gas turbines, either singly or in combination.

*Group 1 process vent* means a process vent for which the vent stream flow rate is greater than or equal to 0.005 standard cubic meter per minute, the total organic HAP concentration is greater than or equal to 50 parts per million by volume, and the total resource effectiveness index value, calculated according to §63.115, is less than or equal to 1.0.

*Group 2 process vent* means a process vent for which the vent stream flow rate is less than 0.005 standard cubic meter per minute, the total organic HAP concentration is less than 50 parts per million by volume or the total resource effectiveness index value, calculated according to §63.115, is greater than 1.0.

*Group 1 storage vessel* means a storage vessel that meets the criteria for design storage capacity and stored-liquid maximum true vapor pressure specified in table 5 of this subpart for storage vessels at existing sources, and in table 6 of this subpart for storage vessels at new sources.

*Group 2 storage vessel* means a storage vessel that does not meet the definition of a Group 1 storage vessel.

*Group 1 transfer rack* means a transfer rack that annually loads greater than or equal to 0.65 million liter of liquid products that contain organic hazardous air pollutants with a rack weighted average vapor pressure greater than or equal to 10.3 kilopascals.

*Group 2 transfer rack* means a transfer rack that does not meet the definition of Group 1 transfer rack.

*Group 1 wastewater stream* means a wastewater stream consisting of process wastewater as defined in §63.101 of subpart F at an existing or new source that meets the criteria for Group 1 status in §63.132(c) of this subpart for Table 9 compounds and/or a wastewater stream consisting of process wastewater at a new source that meets the criteria for Group 1 status in §63.132(d) of this subpart for Table 8 compounds.

*Group 2 wastewater stream* means any process wastewater stream that does not meet the definition of a Group 1 wastewater stream.

*Halogenated vent stream or halogenated stream* means a vent stream from a process vent or transfer operation determined to have a mass emission rate of halogen atoms contained in organic compounds of 0.45 kilograms per hour or greater determined by the procedures presented in §63.115(d)(2)(v) of this subpart.

*Halogens and hydrogen halides* means hydrogen chloride (HCl), chlorine (Cl<sub>2</sub>), hydrogen bromide (HBr), bromine (Br<sub>2</sub>), and hydrogen fluoride (HF).

*Hard-piping* means pipe or tubing that is manufactured and properly installed using good engineering judgment and standards such as American National Standards Institute (ANSI) B31-3.

*Incinerator* means an enclosed combustion device that is used for destroying organic compounds. Auxiliary fuel may be used to heat waste gas to combustion temperatures. Any energy recovery section present is not physically formed into one manufactured or assembled unit with the combustion section; rather, the energy recovery section is a separate section following the combustion section and the two are joined by ducts or connections carrying flue gas. The above energy recovery section limitation does not apply to an energy recovery section used solely to preheat the incoming vent stream or combustion air.

*Individual drain system* means the stationary system used to convey wastewater streams or residuals to a waste management unit or to discharge or disposal. The term includes hard-piping, all process drains and junction boxes, together with their associated sewer lines and other junction boxes, manholes, sumps, and lift stations, conveying wastewater streams or residuals. A segregated stormwater sewer system, which is a drain and collection system designed and operated for the sole purpose of collecting rainfall runoff at a facility, and which is segregated from all other individual drain systems, is excluded from this definition.

*Intermittent vapor processing system* means a vapor processing system that employs an intermediate vapor holder to accumulate total organic compound vapors collected from tank trucks or railcars, and treats the accumulated vapors only during automatically controlled cycles.

*Internal floating roof* means a cover that rests or floats on the liquid surface (but not necessarily in complete contact with it) inside a storage vessel or waste management unit that has a permanently affixed roof.

*Junction box* means a manhole or access point to a wastewater sewer line or a lift station.

*Liquid-mounted seal* means a foam- or liquid-filled seal mounted in contact with the liquid between the wall of the storage vessel or waste management unit and the floating roof. The seal is mounted continuously around the circumference of the vessel or unit.

*Loading cycle* means the time period from the beginning of filling a tank truck or railcar until flow to the control device ceases, as measured by the flow indicator.

*Loading rack* means a single system used to fill tank trucks and railcars at a single geographic site. Loading equipment and operations that are physically separate (i.e., do not share common piping, valves, and other equipment) are considered to be separate loading racks.

*Maximum true vapor pressure* means the equilibrium partial pressure exerted by the total organic HAP's in the stored or transferred liquid at the temperature equal to the highest calendar-month average of the liquid storage or transfer temperature for liquids stored or transferred above or below the ambient temperature or at the local maximum monthly average temperature as reported by the National Weather Service for liquids stored or transferred at the ambient temperature, as determined:

(1) In accordance with methods described in American Petroleum Institute Publication 2517, Evaporative Loss From External Floating-Roof Tanks (incorporated by reference as specified in §63.14 of subpart A of this part); or

(2) As obtained from standard reference texts; or

(3) As determined by the American Society for Testing and Materials Method D2879-83 or 96 (incorporated by reference as specified in §63.14 of subpart A of this part); or



(4) Any other method approved by the Administrator.

*Metallic shoe seal or mechanical shoe seal* means metal sheets that are held vertically against the wall of the storage vessel by springs, weighted levers, or other mechanisms and connected to the floating roof by braces or other means. A flexible coated fabric (envelope) spans the annular space between the metal sheet and the floating roof.

*Non-automated monitoring and recording system* means manual reading of values measured by monitoring instruments and manual transcription of those values to create a record. Non-automated systems do not include strip charts.

*Oil-water separator or organic-water separator* means a waste management unit, generally a tank used to separate oil or organics from water. An oil-water or organic-water separator consists of not only the separation unit but also the forebay and other separator basins, skimmers, weirs, grit chambers, sludge hoppers, and bar screens that are located directly after the individual drain system and prior to additional treatment units such as an air flotation unit, clarifier, or biological treatment unit. Examples of an oil-water or organic-water separator include, but are not limited to, an American Petroleum Institute separator, parallel-plate interceptor, and corrugated-plate interceptor with the associated ancillary equipment.

*Open biological treatment process* means a biological treatment process that is not a closed biological treatment process as defined in this section.

*Operating permit* means a permit required by 40 CFR part 70 or part 71.

*Organic hazardous air pollutant or organic HAP* means any of the chemicals listed in table 2 of subpart F of this part.

*Organic monitoring device* means a unit of equipment used to indicate the concentration level of organic compounds exiting a recovery device based on a detection principle such as infra-red, photoionization, or thermal conductivity.

*Point of determination* means each point where process wastewater exits the chemical manufacturing process unit.

NOTE TO DEFINITION FOR POINT OF DETERMINATION: The regulation allows determination of the characteristics of a wastewater stream (1) at the point of determination or (2) downstream of the point of determination if corrections are made for changes in flow rate and annual average concentration of Table 8 or Table 9 compounds as determined in §63.144 of this subpart. Such changes include losses by air emissions; reduction of annual average concentration or changes in flow rate by mixing with other water or wastewater streams; and reduction in flow rate or annual average concentration by treating or otherwise handling the wastewater stream to remove or destroy hazardous air pollutants.

*Point of transfer* means:

(1) If the transfer is to an off-site location for control, the point where the conveyance crosses the property line; or

(2) If the transfer is to an on-site location not owned or operated by the owner or operator of the source, the point where the conveyance enters the operation or equipment of the transferee.

*Primary fuel* means the fuel that provides the principal heat input to the device. To be considered primary, the fuel must be able to sustain operation without the addition of other fuels.

*Process heater* means a device that transfers heat liberated by burning fuel directly to process streams or to heat transfer liquids other than water.

*Process unit* has the same meaning as *chemical manufacturing process unit* as defined in this section.

*Process wastewater stream* means a stream that contains process wastewater as defined in §63.101 of subpart F of this part.

*Product separator* means phase separators, flash drums, knock-out drums, decanters, degassers, and condenser(s) including ejector-condenser(s) associated with a reactor or an air oxidation reactor.

*Product tank*, as used in the wastewater provisions, means a stationary unit that is designed to contain an accumulation of materials that are fed to or produced by a process unit, and is constructed primarily of non-earthen materials (e.g., wood, concrete, steel, plastic) which provide structural support. This term has the same meaning as a product storage vessel.

*Product tank drawdown* means any material or mixture of materials discharged from a product tank for the purpose of removing water or other contaminants from the product tank.

*Rack-weighted average partial pressure* means the throughput weighted average of the average maximum true vapor pressure of liquids containing organic HAP transferred at a transfer rack. The rack-weighted average partial pressure shall be calculated using the equation below:

Where:

P = Rack-weighted average partial pressure, kilopascals.

$$P = \frac{\sum P_i G_i}{\sum G_i}$$

$P_i$  = Individual HAP maximum true vapor pressure, kilopascals, =  $X_i \cdot P$ , where  $X_i$  is the mole fraction of compound  $i$  in the liquid.

$G_i$  = Yearly volume of each liquid that contains organic HAP that is transferred at the rack, liters.

$i$  = Each liquid that contains HAP that is transferred at the rack.

*Reactor* means a device or vessel in which one or more chemicals or reactants, other than air, are combined or decomposed in such a way that their molecular structures are altered and one or more new organic compounds are formed. Reactor includes the product separator and any associated vacuum pump or steam jet.

*Recapture device* means an individual unit of equipment capable of and used for the purpose of recovering chemicals, but not normally for use, reuse, or sale. For example, a recapture device may recover chemicals primarily for disposal. Recapture devices include, but are not limited to, absorbers, carbon adsorbers, and condensers.

*Recovery device* means an individual unit of equipment capable of and normally used for the purpose of recovering chemicals for fuel value (i.e., net positive heating value), use, reuse or for sale for fuel value, use, or reuse. Examples of equipment that may be recovery devices include absorbers, carbon adsorbers, condensers, oil-water separators or organic-water separators, or organic removal devices such as decanters, strippers, or thin-film evaporation units. For purposes of the monitoring,

recordkeeping, and reporting requirements of this subpart, recapture devices are considered recovery devices.

*Relief valve* means a valve used only to release an unplanned, nonroutine discharge. A relief valve discharge can result from an operator error, a malfunction such as a power failure or equipment failure, or other unexpected cause that requires immediate venting of gas from process equipment in order to avoid safety hazards or equipment damage.

*Reference control technology for process vents* means a combustion device or recapture device used to reduce organic hazardous air pollutant emissions by 98 percent, or to an outlet concentration of 20 parts per million by volume.

*Reference control technology for storage vessels* means an internal floating roof meeting the specifications of §63.119(b) of this subpart, an external floating roof meeting the specifications of §63.119(c) of this subpart, an external floating roof converted to an internal floating roof meeting the specifications of §63.119(d) of this subpart, or a closed-vent system to a control device achieving 95-percent reduction in organic HAP emissions. For purposes of emissions averaging, these four technologies are considered equivalent.

*Reference control technology for transfer racks* means a combustion device, recapture device, or recovery device used to reduce organic hazardous air pollutants emissions by 98 percent, or to an outlet concentration of 20 parts per million by volume; or a vapor balancing system.

*Reference control technology for wastewater* means the use of:

- (1) Controls specified in §63.133 through §63.137;
- (2) A steam stripper meeting the specifications of §63.138(d) of this subpart or any of the other alternative control measures specified in §63.138(b), (c), (e), (f), (g), or (h) of this subpart; and
- (3) A control device to reduce by 95 percent (or to an outlet concentration of 20 parts per million by volume for combustion devices or for noncombustion devices controlling air emissions from waste management units other than surface impoundments or containers) the organic hazardous air pollutants emissions in the vapor streams vented from wastewater tanks, oil-water separators, containers, surface impoundments, individual drain systems, and treatment processes (including the design steam stripper) managing wastewater.

*Residual* means any liquid or solid material containing Table 9 compounds that is removed from a wastewater stream by a waste management unit or treatment process that does not destroy organics (nondestructive unit). Examples of residuals from nondestructive wastewater management units are: the organic layer and bottom residue removed by a decanter or organic-water separator and the overheads from a steam stripper or air stripper. Examples of materials which are not residuals are: silt; mud; leaves; bottoms from a steam stripper or air stripper; and sludges, ash, or other materials removed from wastewater being treated by destructive devices such as biological treatment units and incinerators.

*Secondary fuel* means a fuel fired through a burner other than the primary fuel burner that provides supplementary heat in addition to the heat provided by the primary fuel.

*Sewer line* means a lateral, trunk line, branch line, or other conduit including, but not limited to, grates, trenches, etc., used to convey wastewater streams or residuals to a downstream waste management unit.

*Simultaneous loading* means, for a shared control device, loading of organic HAP materials from more than one transfer arm at the same time such that the beginning and ending times of loading cycles coincide or overlap and there is no interruption in vapor flow to the shared control device.

*Single-seal system* means a floating roof having one continuous seal that completely covers the space between the wall of the storage vessel and the edge of the floating roof. This seal may be a vapor-mounted, liquid-mounted, or metallic shoe seal.

*Specific gravity monitoring device* means a unit of equipment used to monitor specific gravity and having a minimum accuracy of  $\pm 0.02$  specific gravity units.

*Steam jet ejector* means a steam nozzle which discharges a high-velocity jet across a suction chamber that is connected to the equipment to be evacuated.

*Surface impoundment* means a waste management unit which is a natural topographic depression, manmade excavation, or diked area formed primarily of earthen materials (although it may be lined with manmade materials), which is designed to hold an accumulation of liquid wastes or waste containing free liquids. A surface impoundment is used for the purpose of treating, storing, or disposing of wastewater or residuals, and is not an injection well. Examples of surface impoundments are equalization, settling, and aeration pits, ponds, and lagoons.

*Surge control vessel* means feed drums, recycle drums, and intermediate vessels. Surge control vessels are used within a chemical manufacturing process unit when in-process storage, mixing, or management of flow rates or volumes is needed to assist in production of a product.

*Table 8 compound* means a compound listed in table 8 of this subpart.

*Table 9 compound* means a compound listed in table 9 of this subpart.

*Temperature monitoring device* means a unit of equipment used to monitor temperature and having a minimum accuracy of (a)  $\pm 1$  percent of the temperature being monitored expressed in degrees Celsius ( $^{\circ}\text{C}$ ) or (b)  $\pm 0.5$  degrees ( $^{\circ}\text{C}$ ), whichever is greater.

*The 33/50 program* means a voluntary pollution prevention initiative established and administered by the EPA to encourage emissions reductions of 17 chemicals emitted in large volumes by industrial facilities. The EPA Document Number 741-K-92-001 provides more information about the 33/50 program.

*Total organic compounds* or *TOC*, as used in the process vents provisions, means those compounds measured according to the procedures of Method 18 of 40 CFR part 60, appendix A.

*Total resource effectiveness index value* or *TRE index value* means a measure of the supplemental total resource requirement per unit reduction of organic HAP associated with a process vent stream, based on vent stream flow rate, emission rate of organic HAP, net heating value, and corrosion properties (whether or not the vent stream contains halogenated compounds), as quantified by the equations given under §63.115 of this subpart.

*Treatment process* means a specific technique that removes or destroys the organics in a wastewater or residual stream such as a steam stripping unit, thin-film evaporation unit, waste incinerator, biological treatment unit, or any other process applied to wastewater streams or residuals to comply with §63.138 of this subpart. Most treatment processes are conducted in tanks. Treatment processes are a subset of waste management units.

*Vapor collection system*, as used in the transfer provisions, means the equipment used to collect and transport organic HAP vapors displaced during the loading of tank trucks or railcars. This does not include the vapor collection system that is part of any tank truck or railcar vapor collection manifold system.

*Vapor-mounted seal* means a continuous seal that completely covers the annular space between the wall of the storage vessel or waste management unit and the edge of the floating roof and is mounted such that there is a vapor space between the stored liquid and the bottom of the seal.

*Vent stream*, as used in the process vent provisions, means the gas stream flowing through the process vent.

*Waste management unit* means the equipment, structure(s), and/or device(s) used to convey, store, treat, or dispose of wastewater streams or residuals. Examples of waste management units include: Wastewater tanks, surface impoundments, individual drain systems, and biological wastewater treatment units. Examples of equipment that may be waste management units include containers, air flotation units, oil-water separators or organic-water separators, or organic removal devices such as decanters, strippers, or thin-film evaporation units. If such equipment is used for recovery, then it is part of a chemical manufacturing process unit and is not a waste management unit.

*Wastewater stream* means a stream that contains only wastewater as defined in §63.101 of subpart F of this part.

*Wastewater tank* means a stationary waste management unit that is designed to contain an accumulation of wastewater or residuals and is constructed primarily of non-earthen materials (e.g., wood, concrete, steel, plastic) which provide structural support. Wastewater tanks used for flow equalization are included in this definition.

*Water seal controls* means a seal pot, p-leg trap, or other type of trap filled with water (e.g, flooded sewers that maintain water levels adequate to prevent air flow through the system) that creates a water barrier between the sewer line and the atmosphere. The water level of the seal must be maintained in the vertical leg of a drain in order to be considered a water seal.

[59 FR 19468, Apr. 22, 1994, as amended at 60 FR 18024, 18029, Apr. 10, 1995; 60 FR 63626, Dec. 12, 1995; 62 FR 2742, Jan. 17, 1997; 63 FR 67792, Dec. 9, 1998; 65 FR 62215, Oct. 17, 2000; 66 FR 6929, Jan. 22, 2001]

### **§63.112 Emission standard.**

(a) The owner or operator of an existing source subject to the requirements of this subpart shall control emissions of organic HAP's to the level represented by the following equation:

$$E_A = 0.02\sum EPV_1 + \sum EPV_2 + 0.05\sum ES_1 + \sum ES_2 + 0.02\sum ETR_1 + \sum ETR_2 + \sum EWW_{1C} + \sum EWW_2$$

where:

$E_A$  = Emission rate, megagrams per year, allowed for the source.

$0.02\sum EPV_1$  = Sum of the residual emissions, megagrams per year, from all Group 1 process vents, as defined in §63.111 of this subpart.

$\sum EPV_2$  = Sum of the emissions, megagrams per year, from all Group 2 process vents as defined in §63.111 of this subpart.

$0.05\sum ES_1$  = Sum of the residual emissions, megagrams per year, from all Group 1 storage vessels, as defined in §63.111 of this subpart.

$\Sigma ES_2$  = Sum of the emissions, megagrams per year, from all Group 2 storage vessels, as defined in §63.111 of this subpart.

$0.02\Sigma ETR_1$  = Sum of the residual emissions, megagrams per year, from all Group 1 transfer racks, as defined in §63.111 of this subpart.

$\Sigma ETR_2$  = Sum of the emissions, megagrams per year, from all Group 2 transfer racks, as defined in §63.111 of this subpart.

$\Sigma EWW_{1c}$  = Sum of the residual emissions from all Group 1 wastewater streams, as defined in §63.111 of this subpart. This term is calculated for each Group 1 stream according to the equation for  $EWW_{1c}$  in §63.150(g)(5)(i) of this subpart.

$\Sigma EWW_2$  = Sum of emissions from all Group 2 wastewater streams, as defined in §63.111 of this subpart.

The emissions level represented by this equation is dependent on the collection of emission points in the source. The level is not fixed and can change as the emissions from each emission point change or as the number of emission points in the source changes.

(b) The owner or operator of a new source subject to the requirements of this subpart shall control emissions of organic HAP's to the level represented by the equation in paragraph (a) of this section.

(c) The owner or operator of an existing source shall demonstrate compliance with the emission standard in paragraph (a) of this section by following the procedures specified in paragraph (e) of this section for all emission points, or by following the emissions averaging compliance approach specified in paragraph (f) of this section for some emission points and the procedures specified in paragraph (e) of this section for all other emission points within the source.

(d) The owner or operator of a new source shall demonstrate compliance with the emission standard in paragraph (b) of this section only by following the procedures in paragraph (e) of this section. The owner or operator of a new source may not use the emissions averaging compliance approach.

(e) The owner or operator of an existing or new source may comply with the process vent provisions in §§63.113 through 63.118 of this subpart, the storage vessel provisions in §§63.119 through 63.123 of this subpart, the transfer operation provisions in §§63.126 through 63.130 of this subpart, the wastewater provisions in §§63.131 through 63.147 of this subpart, the leak inspection provisions in §63.148, and the provisions in §63.149 of this subpart.

(1) The owner or operator using this compliance approach shall also comply with the requirements of §63.151 and §63.152 of this subpart, as applicable.

(2) The owner or operator using this compliance approach is not required to calculate the annual emission rate specified in paragraph (a) of this section.

(3) When emissions of different kinds (e.g., emissions from process vents, transfer operations, storage vessels, process wastewater, and/or in-process equipment subject to §63.149 of this subpart) are combined, and at least one of the emission streams would be classified as Group 1 in the absence of combination with other emission streams, the owner or operator shall comply with the requirements of either paragraph (e)(3)(i) or paragraph (e)(3)(ii) of this section.

(i) Comply with the applicable requirements of this subpart for each kind of emissions in the stream (e.g., the requirements in §§63.113 through 63.118 of this subpart G for process vents, and the requirements of §§63.126 through 63.130 for transfer operations); or

(ii) Comply with the first set of requirements identified in paragraphs (e)(3)(ii)(A) through (e)(3)(ii)(E) of this section which applies to any individual emission stream that is included in the combined stream,

where either that emission stream would be classified as Group 1 in the absence of combination with other emission streams, or the owner chooses to consider that emission stream to be Group 1 for purposes of this paragraph. Compliance with the first applicable set of requirements identified in paragraphs (e)(3)(ii)(A) through (e)(3)(ii)(E) of this section constitutes compliance with all other requirements in paragraphs (e)(3)(ii)(A) through (e)(3)(ii)(E) of this section applicable to other types of emissions in the combined stream.

(A) The requirements of this subpart for Group 1 process vents, including applicable monitoring, recordkeeping, and reporting;

(B) The requirements of this subpart for Group 1 transfer racks, including applicable monitoring, recordkeeping, and reporting;

(C) The requirements of §63.119(e) for control of emissions from Group 1 storage vessels, including monitoring, recordkeeping, and reporting;

(D) The requirements of §63.139 for control devices used to control emissions from waste management units, including applicable monitoring, recordkeeping, and reporting; or

(E) The requirements of §63.139 for closed vent systems for control of emissions from in-process equipment subject to §63.149, including applicable monitoring, recordkeeping, and reporting.

(f) The owner or operator of an existing source may elect to control some of the emission points within the source to different levels than specified under §§63.113 through 63.148 of this subpart by using an emissions averaging compliance approach as long as the overall emissions for the source do not exceed the emission level specified in paragraph (a) of this section. The owner or operator using emissions averaging must meet the requirements in paragraphs (f)(1) and (f)(2) of this section.

(1) Calculate emission debits and credits for those emission points involved in the emissions average as specified in §63.150 of this subpart; and

(2) Comply with the requirements of §63.151 and §63.152 of this subpart, as applicable.

(g) A State may restrict the owner or operator of an existing source to using only the procedures in paragraph (e) of this section to comply with the emission standard in paragraph (a) of this section.

(h) Where the provisions of this subpart require a performance test, waiver of that requirement shall be addressed only as provided in §63.103(b)(5) of subpart F of this part.

[59 FR 19468, Apr. 22, 1994, as amended at 62 FR 2744, Jan. 17, 1997]

### **§63.113 Process vent provisions—reference control technology.**

(a) The owner or operator of a Group 1 process vent as defined in this subpart shall comply with the requirements of paragraph (a)(1), (2), or (3) of this section. The owner or operator who transfers a gas stream that has the characteristics specified in §63.107 (b) through (h) or meets the criteria specified in §63.107(i) to an off-site location or an on-site location not owned or operated by the owner or operator of the source for disposal shall comply with the requirements of paragraph (i) of this section.

(1) Reduce emissions of organic HAP using a flare.

(i) The flare shall comply with the requirements of §63.11(b) of subpart A of this part.

(ii) Halogenated vent streams, as defined in §63.111 of this subpart, shall not be vented to a flare.

(2) Reduce emissions of total organic hazardous air pollutants by 98 weight-percent or to a concentration of 20 parts per million by volume, whichever is less stringent. For combustion devices, the emission reduction or concentration shall be calculated on a dry basis, corrected to 3-percent oxygen, and compliance can be determined by measuring either organic hazardous air pollutants or total organic carbon using the procedures in §63.116 of this subpart.

(i) Compliance with paragraph (a)(2) of this section may be achieved by using any combination of combustion, recovery, and/or recapture devices, except that a recovery device may not be used to comply with paragraph (a)(2) of this section by reducing emissions of total organic hazardous air pollutants by 98 weight-percent, except as provided in paragraph (a)(2)(ii) of this section.

(ii) An owner or operator may use a recovery device, alone or in combination with one or more combustion or recapture devices, to reduce emissions of total organic hazardous air pollutants by 98 weight-percent if all the conditions of paragraphs (a)(2)(ii)(A) through (a)(2)(ii)(D) of this section are met.

(A) The recovery device (and any combustion device or recapture device which operates in combination with the recovery device to reduce emissions of total organic hazardous air pollutants by 98 weight-percent) was installed before the date of proposal of the subpart of this part 63 that makes this subpart G applicable to process vents in the chemical manufacturing process unit.

(B) The recovery device that will be used to reduce emissions of total organic hazardous air pollutants by 98 weight-percent is the last recovery device before emission to the atmosphere.

(C) The recovery device, alone or in combination with one or more combustion or recapture devices, is capable of reducing emissions of total organic hazardous air pollutants by 98 weight-percent, but is not capable of reliably reducing emissions of total organic hazardous air pollutants to a concentration of 20 parts per million by volume.

(D) If the owner or operator disposed of the recovered material, the recovery device would comply with the requirements of this subpart for recapture devices.

(3) Achieve and maintain a TRE index value greater than 1.0 at the outlet of the final recovery device, or prior to release of the vent stream to the atmosphere if no recovery device is present. If the TRE index value is greater than 1.0, the process vent shall comply with the provisions for a Group 2 process vent specified in either paragraph (d) or (e) of this section, whichever is applicable.

(b) If a boiler or process heater is used to comply with the percent reduction requirement or concentration limit specified in paragraph (a)(2) of this section, then the vent stream shall be introduced into the flame zone of such a device.

(c) Halogenated vent streams from Group 1 process vents that are combusted shall be controlled according to paragraph (c)(1) or (2) of this section.

(1) If a combustion device is used to comply with paragraph (a)(2) of this section for a halogenated vent stream, then the gas stream exiting the combustion device shall be conveyed to a halogen reduction device, such as a scrubber, before it is discharged to the atmosphere.

(i) Except as provided in paragraph (c)(1)(ii) of this section, the halogen reduction device shall reduce overall emissions of hydrogen halides and halogens, as defined in §63.111 of this subpart, by 99 percent or shall reduce the outlet mass of total hydrogen halides and halogens to less than 0.45 kilogram per hour, whichever is less stringent.



(ii) If a scrubber or other halogen reduction device was installed prior to December 31, 1992, the device shall reduce overall emissions of hydrogen halides and halogens, as defined in §63.111 of this subpart, by 95 percent or shall reduce the outlet mass of total hydrogen halides and halogens to less than 0.45 kilograms per hour, whichever is less stringent.

(2) A halogen reduction device, such as a scrubber or other technique, may be used to reduce the vent stream halogen atom mass emission rate to less than 0.45 kilogram per hour prior to any combustion control device, and thus make the vent stream nonhalogenated; the vent stream must comply with the requirements of paragraph (a)(1) or (a)(2) of this section.

(d) The owner or operator of a Group 2 process vent having a flow rate greater than or equal to 0.005 standard cubic meter per minute, a HAP concentration greater than or equal to 50 parts per million by volume, and a TRE index value greater than 1.0 but less than or equal to 4.0 shall maintain a TRE index value greater than 1.0 and shall comply with the monitoring of recovery device parameters in §63.114(b) or (c) of this subpart, the TRE index calculations of §63.115 of this subpart, and the applicable reporting and recordkeeping provisions of §§63.117 and 63.118 of this subpart. Such owner or operator is not subject to any other provisions of §§63.114 through 63.118 of this subpart.

(e) The owner or operator of a Group 2 process vent with a TRE index value greater than 4.0 shall maintain a TRE index value greater than 4.0, comply with the provisions for calculation of a TRE index value in §63.115 and the reporting and recordkeeping provisions in §§63.117(b) and 63.118(c) and (h), and is not subject to monitoring or any other provisions of §§63.114 through 63.118.

(f) The owner or operator of a Group 2 process vent with a flow rate less than 0.005 standard cubic meter per minute shall maintain a flow rate less than 0.005 standard cubic meter per minute; comply with the Group determination procedures in §63.115 (a), (b), and (e) of this subpart; and the reporting and recordkeeping requirements in §63.117(c) of this subpart, §63.118(d) of this subpart, and §63.118(i) of this subpart; and is not subject to monitoring or any other provisions of §§63.114 through 63.118 of this subpart.

(g) The owner or operator of a Group 2 process vent with a total organic HAP concentration less than 50 parts per million by volume shall maintain a total organic HAP concentration less than 50 parts per million by volume; comply with the Group determination procedures in §63.115(a), (c), and (e); the reporting and recordkeeping requirements in §§63.117(d) and 63.118(e) and (j); and is not subject to monitoring or any other provisions of §§63.114 through 63.118.

(h) The owner or operator of a process vent complying with paragraph (a)(1) or (a)(2) of this section is not required to perform the group determination described in §63.115 of this subpart.

(i) *Off-site control or on-site control not owned or operated by the source.* This paragraph (i) applies to gas streams that have the characteristics specified in §63.107(b) through (h) or meet the criteria specified in §63.107(i); that are transferred for disposal to an on-site control device (or other compliance equipment) not owned or operated by the owner or operator of the source generating the gas stream, or to an off-site control device or other compliance equipment; and that have the characteristics (e.g., flow rate, total organic HAP concentration, or TRE index value) of a Group 1 process vent, determined at the point of transfer.

(1) The owner or operator transferring the gas stream shall:

(i) Comply with the provisions specified in §63.114(d) for each gas stream prior to transfer.

(ii) Notify the transferee that the gas stream contains organic hazardous air pollutants that are to be treated in accordance with the provisions of this subpart. The notice shall be submitted to the transferee initially and whenever there is a change in the required control.

(2) The owner or operator may not transfer the gas stream unless the transferee has submitted to the EPA a written certification that the transferee will manage and treat any gas stream transferred under this paragraph (i) and received from a source subject to the requirements of this subpart in accordance with the requirements of either §§63.113 through 63.118, or §63.102(b), or subpart D of this part if alternative emission limitations have been granted the transferor in accordance with those provisions. The certifying entity may revoke the written certification by sending a written statement to EPA and the owner or operator giving at least 90 days notice that the certifying entity is rescinding acceptance of responsibility for compliance with the regulatory provisions listed in this paragraph (i). Upon expiration of the notice period, the owner or operator may not transfer the gas stream to the transferee. Records retained by the transferee shall be retained in accordance with §63.103(c).

(3) By providing this written certification to EPA, the certifying entity accepts responsibility for compliance with the regulatory provisions listed in paragraph (i)(2) of this section with respect to any transfer covered by the written certification. Failure to abide by any of those provisions with respect to such transfers may result in enforcement action by EPA against the certifying entity in accordance with the enforcement provisions applicable to violations of these provisions by owners or operators of sources.

(4) Written certifications and revocation statements to EPA from the transferees of such gas streams shall be signed by a responsible official of the certifying entity, provide the name and address of the certifying entity, and be sent to the appropriate EPA Regional Office at the addresses listed in §63.13. Such written certifications are not transferable by the transferee.

[59 FR 19468, Apr. 22, 1994, as amended at 62 FR 2745, Jan. 17, 1997; 66 FR 6929, Jan. 22, 2001]

#### **§63.114 Process vent provisions—monitoring requirements.**

(a) Each owner or operator of a process vent that uses a combustion device to comply with the requirements in §63.113 (a)(1) or (a)(2) of this subpart, or that uses a recovery device or recapture device to comply with the requirements in §63.113(a)(2) of this subpart, shall install monitoring equipment specified in paragraph (a)(1), (a)(2), (a)(3), (a)(4), or (a)(5) of this section, depending on the type of device used. All monitoring equipment shall be installed, calibrated, maintained, and operated according to manufacturer's specifications or other written procedures that provide adequate assurance that the equipment would reasonably be expected to monitor accurately.

(1) Where an incinerator is used, a temperature monitoring device equipped with a continuous recorder is required.

(i) Where an incinerator other than a catalytic incinerator is used, a temperature monitoring device shall be installed in the firebox or in the ductwork immediately downstream of the firebox in a position before any substantial heat exchange occurs.

(ii) Where a catalytic incinerator is used, temperature monitoring devices shall be installed in the gas stream immediately before and after the catalyst bed.

(2) Where a flare is used, the following monitoring equipment is required: A device (including but not limited to a thermocouple, ultra-violet beam sensor, or infrared sensor) capable of continuously detecting the presence of a pilot flame.

(3) Where a boiler or process heater of less than 44 megawatts design heat input capacity is used, the following monitoring equipment is required: a temperature monitoring device in the firebox equipped with a continuous recorder. This requirement does not apply to gas streams that are introduced with primary fuel or are used as the primary fuel.

(4) Where a scrubber is used with an incinerator, boiler, or process heater in the case of halogenated vent streams, the following monitoring equipment is required for the scrubber.

(i) A pH monitoring device equipped with a continuous recorder shall be installed to monitor the pH of the scrubber effluent.

(ii) A flow meter equipped with a continuous recorder shall be located at the scrubber influent for liquid flow. Gas flow rate shall be determined using one of the procedures specified in paragraphs (a)(4)(ii)(A) through (C) of this section.

(A) The owner or operator may determine gas flow rate using the design blower capacity, with appropriate adjustments for pressure drop.

(B) If the scrubber is subject to rules in 40 CFR parts 264 through 266 that have required a determination of the liquid to gas (L/G) ratio prior to the applicable compliance date for this subpart specified in §63.100(k), the owner or operator may determine gas flow rate by the method that had been utilized to comply with those rules. A determination that was conducted prior to the compliance date for this subpart may be utilized to comply with this subpart if it is still representative.

(C) The owner or operator may prepare and implement a gas flow rate determination plan that documents an appropriate method which will be used to determine the gas flow rate. The plan shall require determination of gas flow rate by a method which will at least provide a value for either a representative or the highest gas flow rate anticipated in the scrubber during representative operating conditions other than startups, shutdowns, or malfunctions. The plan shall include a description of the methodology to be followed and an explanation of how the selected methodology will reliably determine the gas flow rate, and a description of the records that will be maintained to document the determination of gas flow rate. The owner or operator shall maintain the plan as specified in §63.103(c).

(5) Where a recovery device or recapture device is used to comply with the requirements of §63.113(a)(2) of this subpart, the owner or operator shall utilize the appropriate monitoring device identified in paragraph (b), (b)(1), (b)(2), or (b)(3) of this section.

(b) Each owner or operator of a process vent with a TRE index value greater than 1.0 as specified under §§63.113(a)(3) or 63.113(d) of this subpart that uses one or more recovery devices shall install either an organic monitoring device equipped with a continuous recorder or the monitoring equipment specified in paragraph (b)(1), (b)(2), or (b)(3) of this section, depending on the type of recovery device used. All monitoring equipment shall be installed, calibrated, and maintained according to the manufacturer's specifications or other written procedures that provide adequate assurance that the equipment would reasonably be expected to monitor accurately. Monitoring is not required for process vents with TRE index values greater than 4.0 as specified in §63.113(e) of this subpart.

(1) Where an absorber is the final recovery device in the recovery system, a scrubbing liquid temperature monitoring device and a specific gravity monitoring device, each equipped with a continuous recorder shall be used;

(2) Where a condenser is the final recovery device in the recovery system, a condenser exit (product side) temperature monitoring device equipped with a continuous recorder shall be used;

(3) Where a carbon adsorber is the final recovery device in the recovery system, an integrating regeneration stream flow monitoring device having an accuracy of  $\pm 10$  percent or better, capable of recording the total regeneration stream mass or volumetric flow for each regeneration cycle; and a carbon bed temperature monitoring device, capable of recording the carbon bed temperature after each regeneration and within 15 minutes of completing any cooling cycle shall be used.

(c) An owner or operator of a process vent may request approval to monitor parameters other than those listed in paragraph (a) or (b) of this section. The request shall be submitted according to the procedures specified in §63.151(f) or §63.152(e) of this subpart. Approval shall be requested if the owner or operator:

(1) Uses a combustion device other than an incinerator, boiler, process heater, or flare; or

(2) Maintains a TRE greater than 1.0 but less than or equal to 4.0 without a recovery device or with a recovery device other than the recovery devices listed in paragraphs (a) and (b) of this section; or

(3) Uses one of the combustion or recovery or recapture devices listed in paragraphs (a) and (b) of this section, but seeks to monitor a parameter other than those specified in paragraphs (a) and (b) of this section.

(d) The owner or operator of a process vent shall comply with paragraph (d)(1) or (2) of this section for any bypass line between the origin of the gas stream (i.e., at an air oxidation reactor, distillation unit, or reactor as identified in §63.107(b)) and the point where the gas stream reaches the process vent, as described in §63.107, that could divert the gas stream directly to the atmosphere. Equipment such as low leg drains, high point bleeds, analyzer vents, open-ended valves or lines, and pressure relief valves needed for safety purposes are not subject to this paragraph (d).

(1) Properly install, maintain, and operate a flow indicator that takes a reading at least once every 15 minutes. Records shall be generated as specified in §63.118(a)(3). The flow indicator shall be installed at the entrance to any bypass line that could divert the gas stream to the atmosphere; or

(2) Secure the bypass line valve in the non-diverting position with a car-seal or a lock-and-key type configuration. A visual inspection of the seal or closure mechanism shall be performed at least once every month to ensure that the valve is maintained in the non-diverting position and the gas stream is not diverted through the bypass line.

(e) The owner or operator shall establish a range that indicates proper operation of the control or recovery device for each parameter monitored under paragraphs (a), (b), and (c) of this section. In order to establish the range, the information required in §63.152(b) of this subpart shall be submitted in the Notification of Compliance Status or the operating permit application or amendment. The range may be based upon a prior performance test conducted for determining compliance with a regulation promulgated by the EPA, and the owner or operator is not required to conduct a performance test under §63.116 of this subpart, if the prior performance test was conducted using the same methods specified in §63.116 and either no process changes have been made since the test, or the owner or operator can demonstrate that the results of the performance test, with or without adjustments, reliably demonstrate compliance despite process changes.

[59 FR 19468, Apr. 22, 1994, as amended at 62 FR 2745, Jan. 17, 1997; 66 FR 6930, Jan. 22, 2001]

#### **§63.115 Process vent provisions—methods and procedures for process vent group determination.**

(a) For purposes of determining vent stream flow rate, total organic HAP or total organic carbon concentration or TRE index value, as specified under paragraph (b), (c), or (d) of this section, the sampling site shall be after the last recovery device (if any recovery devices are present) but prior to the inlet of any control device that is present and prior to release to the atmosphere.

(1) Method 1 or 1A of 40 CFR part 60, appendix A, as appropriate, shall be used for selection of the sampling site.

(2) No traverse site selection method is needed for vents smaller than 0.10 meter in diameter.

(b) To demonstrate that a vent stream flow rate is less than 0.005 standard cubic meter per minute in accordance with the Group 2 process vent definition of this subpart, the owner or operator shall measure flow rate by the following procedures:

(1) The sampling site shall be selected as specified in paragraph (a) of this section.

(2) The gas volumetric flow rate shall be determined using Method 2, 2A, 2C, or 2D of 40 CFR part 60, appendix A, as appropriate.

(c) Each owner or operator seeking to demonstrate that a vent stream has an organic HAP concentration below 50 parts per million by volume in accordance with the Group 2 process vent definition of this subpart shall measure either total organic HAP or TOC concentration using the following procedures:

(1) The sampling site shall be selected as specified in paragraph (a) of this section.

(2) Method 18 or Method 25A of 40 CFR part 60, appendix A shall be used to measure concentration; alternatively, any other method or data that has been validated according to the protocol in Method 301 of appendix A of this part may be used.

(3) Where Method 18 of 40 CFR part 60, appendix A is used, the following procedures shall be used to calculate parts per million by volume concentration:

(i) The minimum sampling time for each run shall be 1 hour in which either an integrated sample or four grab samples shall be taken. If grab sampling is used, then the samples shall be taken at approximately equal intervals in time, such as 15 minute intervals during the run.

(ii) The concentration of either TOC (minus methane and ethane) or organic HAP shall be calculated according to paragraph (c)(3)(ii)(A) or (c)(3)(ii)(B) of this section as applicable.

(A) The TOC concentration ( $C_{\text{TOC}}$ ) is the sum of the concentrations of the individual components and shall be computed for each run using the following equation:

$$C_{\text{TOC}} = \frac{\sum_{i=1}^x \left( \sum_{j=1}^n C_{ji} \right)}{X}$$

where:

$C_{\text{TOC}}$  = Concentration of TOC (minus methane and ethane), dry basis, parts per million by volume.

$C_{ji}$  = Concentration of sample component  $j$  of the sample  $i$ , dry basis, parts per million by volume.

$n$  = Number of components in the sample.

$x$  = Number of samples in the sample run.

(B) The total organic HAP concentration ( $C_{\text{HAP}}$ ) shall be computed according to the equation in paragraph (c)(3)(ii)(A) of this section except that only the organic HAP species shall be summed. The list of organic HAP's is provided in table 2 of subpart F of this part.

(4) Where Method 25A of 40 CFR part 60, appendix A is used, the following procedures shall be used to calculate parts per million by volume TOC concentration:

(i) Method 25A of 40 CFR part 60, appendix A, shall be used only if a single organic HAP compound is greater than 50 percent of total organic HAP, by volume, in the vent stream.

(ii) The vent stream composition may be determined by either process knowledge, test data collected using an appropriate EPA method, or a method or data validated according to the protocol in Method 301 of appendix A of this part. Examples of information that could constitute process knowledge include calculations based on material balances, process stoichiometry, or previous test results provided the results are still relevant to the current vent stream conditions.

(iii) The organic HAP used as the calibration gas for Method 25A of 40 CFR part 60, appendix A shall be the single organic HAP compound present at greater than 50 percent of the total organic HAP by volume.

(iv) The span value for Method 25A of 40 CFR part 60, appendix A shall be 50 parts per million by volume.

(v) Use of Method 25A of 40 CFR part 60, appendix A is acceptable if the response from the high-level calibration gas is at least 20 times the standard deviation of the response from the zero calibration gas when the instrument is zeroed on the most sensitive scale.

(vi) The owner or operator shall demonstrate that the concentration of TOC including methane and ethane measured by Method 25A of 40 CFR part 60, appendix A is below 25 parts per million by volume to be considered a Group 2 vent with an organic HAP concentration below 50 parts per million by volume and to qualify for the low concentration exclusion in §63.113(g) of this subpart.

(d) To determine the TRE index value, the owner or operator shall conduct a TRE determination and calculate the TRE index value according to the procedures in paragraph (d)(1) or (d)(2) of this section and the TRE equation in paragraph (d)(3) of this section.

(1) Engineering assessment may be used to determine vent stream flow rate, net heating value, TOC emission rate, and total organic HAP emission rate for the representative operating condition expected to yield the lowest TRE index value.

(i) If the TRE value calculated using such engineering assessment and the TRE equation in paragraph (d)(3) of this section is greater than 4.0, then the owner or operator is not required to perform the measurements specified in paragraph (d)(2) of this section.

(ii) If the TRE value calculated using such engineering assessment and the TRE equation in paragraph (d)(3) of this section is less than or equal to 4.0, then the owner or operator is required to perform the measurements specified in paragraph (d)(2) of this section for group determination or consider the process vent a Group 1 vent and comply with the emission reduction specified in §63.113(a) of this subpart.

(iii) Engineering assessment includes, but is not limited to, the following:

(A) Previous test results provided the tests are representative of current operating practices at the process unit.

(B) Bench-scale or pilot-scale test data representative of the process under representative operating conditions.

(C) Maximum flow rate, TOC emission rate, organic HAP emission rate, or net heating value limit specified or implied within a permit limit applicable to the process vent.

(D) Design analysis based on accepted chemical engineering principles, measurable process parameters, or physical or chemical laws or properties. Examples of analytical methods include, but are not limited to:

(1) Use of material balances based on process stoichiometry to estimate maximum organic HAP concentrations,

(2) Estimation of maximum flow rate based on physical equipment design such as pump or blower capacities,

(3) Estimation of TOC or organic HAP concentrations based on saturation conditions,

(4) Estimation of maximum expected net heating value based on the vent stream concentration of each organic compound or, alternatively, as if all TOC in the vent stream were the compound with the highest heating value.

(E) All data, assumptions, and procedures used in the engineering assessment shall be documented.

(2) Except as provided in paragraph (d)(1) of this section, vent stream flow rate, net heating value, TOC emission rate, and total organic HAP emission rate shall be measured and calculated according to the procedures in paragraphs (d)(2)(i) through (v) of this section and used as input to the TRE index value calculation in paragraph (d)(3) of this section.

(i) The vent stream volumetric flow rate ( $Q_s$ ), in standard cubic meters per minute at 20 degrees Celcius, shall be determined using Method 2, 2A, 2C, or 2D of 40 CFR part 60, appendix A, as appropriate. If the vent stream tested passes through a final steam jet ejector and is not condensed, the vent stream volumetric flow shall be corrected to 2.3 percent moisture.

(ii) The molar composition of the vent stream, which is used to calculate net heating value, shall be determined using the following methods:

(A) Method 18 of 40 CFR part 60, appendix A to measure the concentration of each organic compound.

(B) American Society for Testing and Materials D1946-77 to measure the concentration of carbon monoxide and hydrogen.

(C) Method 4 of 40 CFR part 60, appendix A, to measure the moisture content of the vent stream.

(iii) The net heating value of the vent stream shall be calculated using the following equation:

$$H_T = K_1 \left( \sum_{j=1}^n C_j H_j \right) (1 - B_{ws})$$

where:

$H_T$  = Net heating value of the sample, megaJoule per standard cubic meter, where the net enthalpy per mole of vent stream is based on combustion at 25 °C and 760 millimeters of mercury, but the standard temperature for

determining the volume corresponding to one mole is 20 °C, as in the definition of  $Q_s$  (vent stream flow rate).

$K_1$  = Constant,  $1.740 \times 10^{-7}$  (parts per million)<sup>-1</sup> (gram-mole per standard cubic meter) (megaJoule per kilocalorie), where standard temperature for (gram-mole per standard cubic meter) is 20 °C.

$B_{ws}$  = Water vapor content of the vent stream, proportion by volume; except that if the vent stream passes through a final steam jet and is not condensed, it shall be assumed that  $B_{ws} = 0.023$  in order to correct to 2.3 percent moisture.

$C_j$  = Concentration on a dry basis of compound j in parts per million, as measured for all organic compounds by Method 18 of 40 CFR part 60, appendix A and measured for hydrogen and carbon monoxide by American Society for Testing and Materials D1946-77 as indicated in paragraph (d)(2)(ii) of this section.

$H_j$  = Net heat of combustion of compound j, kilocalorie per gram-mole, based on combustion at 25 °C and 760 millimeters mercury. The heats of combustion of vent stream components shall be determined using American Society for Testing and Materials D2382-76 if published values are not available or cannot be calculated.

(iv) The emission rate of TOC (minus methane and ethane) ( $E_{TOC}$ ) and the emission rate of total organic HAP ( $E_{HAP}$ ) in the vent stream shall both be calculated using the following equation:

$$E = K_2 \left[ \sum_{j=1}^n C_j M_j \right] Q_s$$

where:

$E$  = Emission rate of TOC (minus methane and ethane) or emission rate of total organic HAP in the sample, kilograms per hour.

$K_2$  = Constant,  $2.494 \times 10^{-6}$  (parts per million)<sup>-1</sup> (gram-mole per standard cubic meter) (kilogram/gram) (minutes/hour), where standard temperature for (gram-mole per standard cubic meter) is 20 °C.

$C_j$  = Concentration on a dry basis of organic compound j in parts per million as measured by Method 18 of 40 CFR part 60, appendix A as indicated in paragraph (d)(2)(ii) of this section. If the TOC emission rate is being calculated,  $C_j$  includes all organic compounds measured minus methane and ethane; if the total organic HAP emission rate is being calculated, only organic HAP compounds listed in table 2 in subpart F of this part are included.

$M_j$  = Molecular weight of organic compound j, gram/gram-mole.

$Q_s$  = Vent stream flow rate, dry standard cubic meter per minute, at a temperature of 20 °C.

(v) In order to determine whether a vent stream is halogenated, the mass emission rate of halogen atoms contained in organic compounds shall be calculated.

(A) The vent stream concentration of each organic compound containing halogen atoms (parts per million by volume, by compound) shall be determined based on the following procedures:

(1) Process knowledge that no halogen or hydrogen halides are present in the process, or

(2) Applicable engineering assessment as discussed in paragraph (d)(1)(iii) of this section, or

(3) Concentration of organic compounds containing halogens measured by Method 18 of 40 CFR part 60, appendix A, or



(4) Any other method or data that has been validated according to the applicable procedures in Method 301 of appendix A of this part.

(B) The following equation shall be used to calculate the mass emission rate of halogen atoms:

$$E = K_2 Q \left( \sum_{j=1}^n \sum_{i=1}^m C_j * L_{ji} * M_{ji} \right)$$

where:

E = mass of halogen atoms, dry basis, kilogram per hour.

K<sub>2</sub> = Constant, 2.494 × 10<sup>-6</sup> (parts per million)<sup>-1</sup> (kilogram-mole per standard cubic meter) (minute/hour), where standard temperature is 20 °C.

C<sub>j</sub> = Concentration of halogenated compound j in the gas stream, dry basis, parts per million by volume.

M<sub>ji</sub> = Molecular weight of halogen atom i in compound j of the gas stream, kilogram per kilogram-mole.

L<sub>ji</sub> = Number of atoms of halogen i in compound j of the gas stream.

Q = Flow rate of gas stream, dry standard cubic meters per minute, determined according to paragraph (d)(1) or (d)(2)(i) of this section.

j = Halogenated compound j in the gas stream.

i = Halogen atom i in compound j of the gas stream.

n = Number of halogenated compounds j in the gas stream.

m = Number of different halogens i in each compound j of the gas stream.

(3) The owner or operator shall calculate the TRE index value of the vent stream using the equations and procedures in this paragraph.

(i) The equation for calculating the TRE index for a vent stream controlled by a flare or incinerator is as follows:

$$TRE = \frac{1}{E_{HAP}} [a + b(Q_s) + c(H_T) + d(E_{TOC})]$$

where:

TRE = TRE index value.

E<sub>HAP</sub> = Hourly emission rate of total organic HAP, kilograms per hour, as calculated in paragraph (d)(1) or (d)(2)(iv) of this section.

Q<sub>s</sub> = Vent stream flow rate, standard cubic meters per minute, at a standard temperature of 20 °C, as calculated in paragraph (d)(1) or (d)(2)(i) of this section.

H<sub>T</sub> = Vent stream net heating value, megaJoules per standard cubic meter, as calculated in paragraph (d)(1) or (d)(2)(iii) of this section.

E<sub>TOC</sub> = Emission rate of TOC (minus methane and ethane), kilograms per hour, as calculated in paragraph (d)(1) or (d)(2)(iv) of this section.

a,b,c,d = Coefficients presented in table 1 of this subpart, selected in accordance with paragraphs (d)(3)(ii) and (iii) of this section.

(ii) The owner or operator of a nonhalogenated vent stream shall calculate the TRE index value based on the use of a flare, a thermal incinerator with 0 percent heat recovery, and a thermal incinerator with 70 percent heat recovery and shall select the lowest TRE index value. The owner or operator shall use the applicable coefficients in table 1 of this subpart for nonhalogenated vent streams located within existing sources and the applicable coefficients in table 2 of this subpart for nonhalogenated vent streams located within new sources.

(iii) The owner or operator of a halogenated vent stream shall calculate the TRE index value based on the use of a thermal incinerator with 0 percent heat recovery, and a scrubber. The owner or operator shall use the applicable coefficients in table 1 of this subpart for halogenated vent streams located within existing sources and the applicable coefficients in table 2 of this subpart for halogenated vent streams located within new sources.

(e) The owner or operator of a Group 2 process vent shall recalculate the TRE index value, flow, or organic hazardous air pollutants concentration for each process vent, as necessary to determine whether the vent is Group 1 or Group 2, whenever process changes are made that could reasonably be expected to change the vent to a Group 1 vent. Examples of process changes include, but are not limited to, changes in production capacity, production rate, feedstock type, or catalyst type, or whenever there is replacement, removal, or addition of recovery equipment. For purposes of this paragraph, process changes do not include: Process upsets; unintentional, temporary process changes; and changes that are within the range on which the original TRE calculation was based.

(1) The TRE index value, flow rate, or organic HAP concentration shall be recalculated based on measurements of vent stream flow rate, TOC, and organic HAP concentrations, and heating values as specified in §63.115 (a), (b), (c), and (d) of this subpart, as applicable, or on best engineering assessment of the effects of the change. Engineering assessments shall meet the specifications in paragraph (d)(1) of this section.

(2) Where the recalculated TRE index value is less than or equal to 1.0, or less than or equal to 4.0 but greater than 1.0, the recalculated flow rate is greater than or equal to 0.005 standard cubic meter per minute, or the recalculated concentration is greater than or equal to 50 parts per million by volume, the owner or operator shall submit a report as specified in §63.118 (g), (h), (i), or (j) of this subpart and shall comply with the appropriate provisions in §63.113 of this subpart by the dates specified in §63.100 of subpart F of this part.

(f) Notwithstanding any other provisions of this subpart, in any case where a process vent includes one or more gas streams that are not from a source subject to this subpart (hereafter called "non-HON streams" for purposes of this paragraph), and one or more gas streams that meet the criteria in §63.107(b) through (h) or the criteria in §63.107(i) (hereafter called "HON streams" for purposes of this paragraph), the owner or operator may elect to comply with paragraphs (f)(1) through (3) of this section.

(1) The owner or operator may determine the characteristics (flow rate, total organic HAP concentration, and TRE index value) for each HON stream, or combination of HON streams, at a representative point as near as practical to, but before, the point at which it is combined with one or more non-HON streams.

(2) If one or more of the HON streams, or combinations of HON streams, has the characteristics (determined at the location specified in paragraph (f)(1) of this section) associated with a Group 1 process vent, the combined vent stream is a Group 1 process vent. Except as specified in paragraph (f)(3) of this section, if none of the HON streams, or combinations of HON streams, when determined at the location specified in paragraph (f)(1) of this section, has the characteristics associated with a Group 1 process

vent, the combined vent stream is a Group 2 process vent regardless of the TRE index value determined at the location specified in §63.115(a). If the combined vent stream is a Group 2 process vent as determined by the previous sentence, but one or more of the HON streams, or combinations of HON streams, has a TRE index value greater than 1 but less than or equal to 4, the combined vent stream is a process vent with a TRE index value greater than 1 but less than or equal to 4. In this case, the owner or operator shall monitor the combined vent stream as required by §63.114(b).

(3) Paragraphs (f)(1) and (2) of this section are not intended to apply instead of any other subpart of this part. If another subpart of this part applies to one or more of the non-HON streams contributing to the combined vent stream, that subpart may impose emission control requirements such as, but not limited to, requiring the combined vent stream to be classified and controlled as a Group 1 process vent.

[59 FR 19468, Apr. 22, 1994, as amended at 62 FR 2746, Jan. 17, 1997; 66 FR 6931, Jan. 22, 2001]

**§63.116 Process vent provisions—performance test methods and procedures to determine compliance.**

(a) When a flare is used to comply with §63.113(a)(1), the owner or operator shall comply with paragraphs (a)(1) through (3) of this section. The owner or operator is not required to conduct a performance test to determine percent emission reduction or outlet organic HAP or TOC concentration.

(1) Conduct a visible emission test using the techniques specified in §63.11(b)(4).

(2) Determine the net heating value of the gas being combusted using the techniques specified in §63.11(b)(6).

(3) Determine the exit velocity using the techniques specified in either §63.11(b)(7)(i) (and §63.11(b)(7)(iii), where applicable) or §63.11(b)(8), as appropriate.

(b) An owner or operator is not required to conduct a performance test when any control device specified in paragraphs (b)(1) through (b)(5) of this section is used.

(1) A boiler or process heater with a design heat input capacity of 44 megawatts or greater.

(2) A boiler or process heater into which the gas stream is introduced with the primary fuel or is used as the primary fuel.

(3) A control device for which a performance test was conducted for determining compliance with a regulation promulgated by the EPA and the test was conducted using the same methods specified in this section and either no process changes have been made since the test, or the owner or operator can demonstrate that the results of the performance test, with or without adjustments, reliably demonstrate compliance despite process changes.

(4) A boiler or process heater burning hazardous waste for which the owner or operator:

(i) Has been issued a final permit under 40 CFR part 270 and complies with the requirements of 40 CFR part 266, subpart H, or

(ii) Has certified compliance with the interim status requirements of 40 CFR part 266, subpart H.

(5) A hazardous waste incinerator for which the owner or operator has been issued a final permit under 40 CFR part 270 and complies with the requirements of 40 CFR part 264, subpart O, or has certified compliance with the interim status requirements of 40 CFR part 265, subpart O.

(c) Except as provided in paragraphs (a) and (b) of this section, an owner or operator using a control device to comply with the organic HAP concentration limit or percent reduction efficiency requirements in §63.113(a)(2) of this subpart shall conduct a performance test using the procedures in paragraphs (c)(1) through (c)(4) of this section. The organic HAP concentration and percent reduction may be measured as either total organic HAP or as TOC minus methane and ethane according to the procedures specified.

(1) Method 1 or 1A of 40 CFR part 60, appendix A, as appropriate, shall be used for selection of the sampling sites.

(i) For determination of compliance with the 98 percent reduction of total organic HAP requirement of §63.113(a)(2) of this subpart, sampling sites shall be located at the inlet of the control device as specified in paragraphs (c)(1)(i)(A) and (c)(1)(i)(B) of this section, and at the outlet of the control device.

(A) The control device inlet sampling site shall be located after the final product recovery device.

(B) If a vent stream is introduced with the combustion air or as a secondary fuel into a boiler or process heater with a design capacity less than 44 megawatts, selection of the location of the inlet sampling sites shall ensure the measurement of total organic HAP or TOC (minus methane and ethane) concentrations in all vent streams and primary and secondary fuels introduced into the boiler or process heater.

(ii) For determination of compliance with the 20 parts per million by volume total organic HAP limit in §63.113(a)(2) of this subpart, the sampling site shall be located at the outlet of the control device.

(2) The gas volumetric flow rate shall be determined using Method 2, 2A, 2C, or 2D of 40 CFR part 60, appendix A, as appropriate.

(3) To determine compliance with the 20 parts per million by volume total organic HAP limit in §63.113(a)(2) of this subpart, the owner or operator shall use Method 18 of 40 CFR part 60, appendix A to measure either TOC minus methane and ethane or total organic HAP. Alternatively, any other method or data that has been validated according to the applicable procedures in Method 301 of appendix A of this part, may be used. The following procedures shall be used to calculate parts per million by volume concentration, corrected to 3 percent oxygen:

(i) The minimum sampling time for each run shall be 1 hour in which either an integrated sample or a minimum of four grab samples shall be taken. If grab sampling is used, then the samples shall be taken at approximately equal intervals in time, such as 15 minute intervals during the run.

(ii) The concentration of either TOC (minus methane or ethane) or total organic HAP shall be calculated according to paragraph (c)(3)(ii)(A) or (c)(3)(ii)(B) of this section.

(A) The TOC concentration ( $C_{\text{TOC}}$ ) is the sum of the concentrations of the individual components and shall be computed for each run using the following equation:

$$C_{\text{TOC}} = \sum_{i=1}^x \frac{\left( \sum_{j=1}^n C_{ji} \right)}{x}$$

where:

$C_{\text{TOC}}$  = Concentration of TOC (minus methane and ethane), dry basis, parts per million by volume.

$C_{ji}$  = Concentration of sample components j of sample i, dry basis, parts per million by volume.

n = Number of components in the sample.

x = Number of samples in the sample run.

(B) The total organic HAP concentration ( $C_{HAP}$ ) shall be computed according to the equation in paragraph (c)(3)(ii)(A) of this section except that only the organic HAP species shall be summed. The list of organic HAP's is provided in table 2 of subpart F of this part.

(iii) The concentration of TOC or total organic HAP shall be corrected to 3 percent oxygen if a combustion device is the control device.

(A) The emission rate correction factor or excess air, integrated sampling and analysis procedures of Method 3B of 40 CFR part 60, appendix A shall be used to determine the oxygen concentration ( $\%O_{2d}$ ). The samples shall be taken during the same time that the TOC (minus methane or ethane) or total organic HAP samples are taken.

(B) The concentration corrected to 3 percent oxygen ( $C_c$ ) shall be computed using the following equation:

$$C_c = C_m \left( \frac{17.9}{20.9 - \%O_{2d}} \right)$$

Where:

$C_c$  = Concentration of TOC or organic HAP corrected to 3 percent oxygen, dry basis, parts per million by volume.

$C_m$  = Concentration of TOC (minus methane and ethane) or organic HAP, dry basis, parts per million by volume.

$\%O_{2d}$  = Concentration of oxygen, dry basis, percent by volume.

(4) To determine compliance with the 98 percent reduction requirement of §63.113(a)(2) of this subpart, the owner or operator shall use Method 18 of 40 CFR part 60, appendix A; alternatively, any other method or data that has been validated according to the applicable procedures in Method 301 of appendix A of this part may be used. The following procedures shall be used to calculate percent reduction efficiency:

(i) The minimum sampling time for each run shall be 1 hour in which either an integrated sample or a minimum of four grab samples shall be taken. If grab sampling is used, then the samples shall be taken at approximately equal intervals in time such as 15 minute intervals during the run.

(ii) The mass rate of either TOC (minus methane and ethane) or total organic HAP ( $E_i$ ,  $E_o$ ) shall be computed.

(A) The following equations shall be used:

$$E_i = K_2 \left( \sum_{j=1}^n C_{ij} M_{ij} \right) Q_i$$

$$E_o = K_2 \left( \sum_{j=1}^n C_{oj} M_{oj} \right) Q_o$$

where:

$C_{ij}$ ,  $C_{oj}$  = Concentration of sample component  $j$  of the gas stream at the inlet and outlet of the control device, respectively, dry basis, parts per million by volume.

$E_i$ ,  $E_o$  = Mass rate of TOC (minus methane and ethane) or total organic HAP at the inlet and outlet of the control device, respectively, dry basis, kilogram per hour.

$M_{ij}$ ,  $M_{oj}$  = Molecular weight of sample component  $j$  of the gas stream at the inlet and outlet of the control device, respectively, gram/gram-mole.

$Q_i$ ,  $Q_o$  = Flow rate of gas stream at the inlet and outlet of the control device, respectively, dry standard cubic meter per minute.

$K_2$  = Constant,  $2.494 \times 10^{-6}$  (parts per million)<sup>-1</sup> (gram-mole per standard cubic meter) (kilogram/gram) (minute/hour), where standard temperature (gram-mole per standard cubic meter) is 20 °C.

(B) Where the mass rate of TOC is being calculated, all organic compounds (minus methane and ethane) measured by Method 18 of 40 CFR part 60, appendix A are summed using the equation in paragraph (c)(4)(ii)(A) of this section.

(C) Where the mass rate of total organic HAP is being calculated, only the organic HAP species shall be summed using the equation in paragraph (c)(4)(ii)(A) of this section. The list of organic HAP's is provided in table 2 of subpart F of this part.

(iii) The percent reduction in TOC (minus methane and ethane) or total organic HAP shall be calculated as follows:

$$R = \frac{E_i - E_o}{E_i} (100)$$

where:

$R$  = Control efficiency of control device, percent.

$E_i$  = Mass rate of TOC (minus methane and ethane) or total organic HAP at the inlet to the control device as calculated under paragraph (c)(4)(ii) of this section, kilograms TOC per hour or kilograms organic HAP per hour.

$E_o$  = Mass rate of TOC (minus methane and ethane) or total organic HAP at the outlet of the control device, as calculated under paragraph (c)(4)(ii) of this section, kilograms TOC per hour or kilograms organic HAP per hour.

(iv) If the vent stream entering a boiler or process heater with a design capacity less than 44 megawatts is introduced with the combustion air or as a secondary fuel, the weight-percent reduction of total organic HAP or TOC (minus methane and ethane) across the device shall be determined by comparing the TOC (minus methane and ethane) or total organic HAP in all combusted vent streams and primary and secondary fuels with the TOC (minus methane and ethane) or total organic HAP exiting the combustion device, respectively.

(d) An owner or operator using a combustion device followed by a scrubber or other halogen reduction device to control halogenated vent streams in compliance with §63.113(c)(1) shall conduct a performance test to determine compliance with the control efficiency or emission limits for hydrogen halides and halogens.

(1) For an owner or operator determining compliance with the percent reduction of total hydrogen halides and halogens, sampling sites shall be located at the inlet and outlet of the scrubber or other halogen reduction device used to reduce halogen emissions. For an owner or operator determining compliance with the less than 0.45 kilogram per hour outlet emission limit for total hydrogen halides and halogens, the sampling site shall be located at the outlet of the scrubber or other halogen reduction device and prior to any releases to the atmosphere.

(2) Except as provided in paragraph (d)(5) of this section, Method 26 or Method 26A of 40 CFR part 60, appendix A, shall be used to determine the concentration, in milligrams per dry standard cubic meter, of total hydrogen halides and halogens that may be present in the vent stream. The mass emissions of each hydrogen halide and halogen compound shall be calculated from the measured concentrations and the gas stream flow rate.

(3) To determine compliance with the percent removal efficiency, the mass emissions for any hydrogen halides and halogens present at the inlet of the scrubber or other halogen reduction device shall be summed together. The mass emissions of the compounds present at the outlet of the scrubber or other halogen reduction device shall be summed together. Percent reduction shall be determined by comparison of the summed inlet and outlet measurements.

(4) To demonstrate compliance with the less than 0.45 kilogram per hour outlet emission limit, the test results must show that the mass emission rate of total hydrogen halides and halogens measured at the outlet of the scrubber or other halogen reduction device is below 0.45 kilogram per hour.

(5) The owner or operator may use any other method to demonstrate compliance if the method or data has been validated according to the applicable procedures of Method 301 of appendix A of this part.

(e) An owner or operator using a scrubber or other halogen reduction device to reduce the vent stream halogen atom mass emission rate to less than 0.45 kilogram per hour prior to a combustion control device in compliance with §63.113(c)(2) of this subpart shall determine the halogen atom mass emission rate prior to the combustor according to the procedures in §63.115(d)(2)(v) of this subpart.

[59 FR 19468, Apr. 22, 1994, as amended at 62 FR 2746, Jan. 17, 1997; 64 FR 20191, Apr. 26, 1999; 66 FR 6931, Jan. 22, 2001]

**§63.117 Process vent provisions—reporting and recordkeeping requirements for group and TRE determinations and performance tests.**

(a) Each owner or operator subject to the control provisions for Group 1 process vents in §63.113(a) or the provisions for Group 2 process vents with a TRE index value greater than 1.0 but less than or equal to 4.0 in §63.113(d) shall:

(1) Keep an up-to-date, readily accessible record of the data specified in paragraphs (a)(4) through (a)(8) of this section, as applicable, and

(2) Include the data in paragraphs (a)(4) through (a)(8) of this section in the Notification of Compliance Status report as specified in §63.152(b) of this subpart.

(3) If any subsequent TRE determinations or performance tests are conducted after the Notification of Compliance Status has been submitted, report the data in paragraphs (a)(4) through (a)(8) of this section in the next Periodic Report as specified in §63.152(c) of this subpart.

(4) Record and report the following when using a combustion device to achieve a 98 weight percent reduction in organic HAP or an organic HAP concentration of 20 parts per million by volume, as specified in §63.113(a)(2) of this subpart:

(i) The parameter monitoring results for incinerators, catalytic incinerators, boilers or process heaters specified in table 3 of this subpart, and averaged over the same time period of the performance testing.

(ii) For an incinerator, the percent reduction of organic HAP or TOC achieved by the incinerator determined as specified in §63.116(c) of this subpart, or the concentration of organic HAP or TOC (parts per million by volume, by compound) determined as specified in §63.116(c) of this subpart at the outlet of the incinerator on a dry basis corrected to 3 percent oxygen.

(iii) For a boiler or process heater, a description of the location at which the vent stream is introduced into the boiler or process heater.

(iv) For a boiler or process heater with a design heat input capacity of less than 44 megawatts and where the vent stream is introduced with combustion air or used as a secondary fuel and is not mixed with the primary fuel, the percent reduction of organic HAP or TOC, or the concentration of organic HAP or TOC (parts per million by volume, by compound) determined as specified in §63.116(c) at the outlet of the combustion device on a dry basis corrected to 3 percent oxygen.

(5) Record and report the following when using a flare to comply with §63.113(a)(1) of this subpart:

(i) Flare design (i.e., steam-assisted, air-assisted, or non-assisted);

(ii) All visible emission readings, heat content determinations, flow rate measurements, and exit velocity determinations made during the compliance determination required by §63.116(a) of this subpart; and

(iii) All periods during the compliance determination when the pilot flame is absent.

(6) Record and report the following when using a scrubber following a combustion device to control a halogenated vent stream:

(i) The percent reduction or scrubber outlet mass emission rate of total hydrogen halides and halogens as specified in §63.116(d) of this subpart;

(ii) The pH of the scrubber effluent; and

(iii) The scrubber liquid to gas ratio.

(7) Record and report the following when achieving and maintaining a TRE index value greater than 1.0 but less than 4.0 as specified in §63.113(a)(3) or §63.113(d) of this subpart:

(i) The parameter monitoring results for absorbers, condensers, or carbon adsorbers, as specified in table 4 of this subpart, and averaged over the same time period of the measurements of vent stream flow rate and concentration used in the TRE determination (both measured while the vent stream is normally routed and constituted), and



(ii) The measurements and calculations performed to determine the TRE index value of the vent stream.

(8) Record and report the halogen concentration in the vent stream determined according to the procedures specified in §63.115(d)(2)(v).

(b) The owner or operator of a Group 2 process vent with a TRE index greater than 4.0 as specified in §63.113(e) of this subpart, shall maintain records and submit as part of the Notification of Compliance Status specified in §63.152 of this subpart, measurements, engineering assessments, and calculations performed to determine the TRE index value of the vent stream. Documentation of engineering assessments shall include all data, assumptions, and procedures used for the engineering assessments, as specified in §63.115(d)(1) of this subpart.

(c) Each owner or operator who elects to demonstrate that a process vent is a Group 2 process vent based on a flow rate less than 0.005 standard cubic meter per minute must submit to the Administrator the flow rate measurement using methods and procedures specified in §63.115 (a) and (b) of this subpart with the Notification of Compliance Status specified in §63.152 of this subpart.

(d) Each owner or operator who elects to demonstrate that a process vent is a Group 2 process vent based on organic HAP or TOC concentration less than 50 parts per million by volume must submit to the Administrator an organic HAP or TOC concentration measurement using the methods and procedures specified in §63.115 (a) and (c) of this subpart with the Notification of Compliance Status specified in §63.152 of this subpart.

(e) If an owner or operator uses a control or recovery device other than those listed in tables 3 and 4 of this subpart or requests approval to monitor a parameter other than those specified in tables 3 and 4 of this subpart, the owner or operator shall submit a description of planned reporting and recordkeeping procedures as required under §63.151(f) or §63.152(e) of this subpart. The Administrator will specify appropriate reporting and recordkeeping requirements as part of the review of the permit application or by other appropriate means.

(f) For each parameter monitored according to tables 3 or 4 of this subpart or paragraph (e) of this section, the owner or operator shall establish a range for the parameter that indicates proper operation of the control or recovery device. In order to establish the range, the information required in §63.152(b) of this subpart shall be submitted in the Notification of Compliance Status or the operating permit application or amendment.

[59 FR 19468, Apr. 22, 1994, as amended at 61 FR 64576, Dec. 5, 1996; 66 FR 6932, Jan. 22, 2001]

#### **§63.118 Process vent provisions—periodic reporting and recordkeeping requirements.**

(a) Each owner or operator using a control device to comply with §63.113 (a)(1) or (a)(2) of this subpart shall keep the following records up-to-date and readily accessible:

(1) Continuous records of the equipment operating parameters specified to be monitored under §63.114(a) of this subpart and listed in table 3 of this subpart or specified by the Administrator in accordance with §63.114(c) and §63.117(e) of this subpart. For flares, the hourly records and records of pilot flame outages specified in table 3 of this subpart shall be maintained in place of continuous records.

(2) Records of the daily average value of each continuously monitored parameter for each operating day determined according to the procedures specified in §63.152(f). For flares, records of the times and duration of all periods during which all pilot flames are absent shall be kept rather than daily averages.

(3) Hourly records of whether the flow indicator specified under §63.114(d)(1) was operating and whether a diversion was detected at any time during the hour, as well as records of the times and durations of all periods when the gas stream is diverted to the atmosphere or the monitor is not operating.

(4) Where a seal mechanism is used to comply with §63.114(d)(2) of this subpart, hourly records of flow are not required. In such cases, the owner or operator shall record that the monthly visual inspection of the seals or closure mechanism has been done, and shall record the duration of all periods when the seal mechanism is broken, the bypass line valve position has changed, or the key for a lock-and-key type lock has been checked out, and records of any car-seal that has broken.

(b) Each owner or operator using a recovery device or other means to achieve and maintain a TRE index value greater than 1.0 but less than 4.0 as specified in §63.113(a)(3) or §63.113(d) of this subpart shall keep the following records up-to-date and readily accessible:

(1) Continuous records of the equipment operating parameters specified to be monitored under §63.114(b) of this subpart and listed in table 4 of this subpart or specified by the Administrator in accordance with §63.114(c) of this subpart and §63.114(e) of this subpart and

(2) Records of the daily average value of each continuously monitored parameter for each operating day determined according to the procedures specified in §63.152(f). If carbon adsorber regeneration stream flow and carbon bed regeneration temperature are monitored, the records specified in table 4 of this subpart shall be kept instead of the daily averages.

(c) Each owner or operator subject to the provisions of this subpart and who elects to demonstrate compliance with the TRE index value greater than 4.0 under §63.113(e) of this subpart or greater than 1.0 under §63.113(a)(3) or §63.113(d) of this subpart shall keep up-to-date, readily accessible records of:

(1) Any process changes as defined in §63.115(e) of this subpart; and

(2) Any recalculation of the TRE index value pursuant to §63.115(e) of this subpart.

(d) Each owner or operator who elects to comply by maintaining a flow rate less than 0.005 standard cubic meter per minute under §63.113(f) of this subpart, shall keep up-to-date, readily accessible records of:

(1) Any process changes as defined in §63.115(e) of this subpart that increase the vent stream flow rate,

(2) Any recalculation or measurement of the flow rate pursuant to §63.115(e) of this subpart, and

(3) If the flow rate increases to 0.005 standard cubic meter per minute or greater as a result of the process change, the TRE determination performed according to the procedures of §63.115(d) of this subpart.

(e) Each owner or operator who elects to comply by maintaining an organic HAP concentration less than 50 parts per million by volume organic HAP concentration under §63.113(g) of this subpart shall keep up-to-date, readily accessible records of:

(1) Any process changes as defined in §63.115(e) that increase the organic HAP concentration of the vent stream,

(2) Any recalculation or measurement of the concentration pursuant to §63.115(e) of this subpart, and

(3) If the organic HAP concentration increases to 50 parts per million by volume or greater as a result of the process change, the TRE determination performed according to the procedures of §63.115(d) of this subpart.

(f) Each owner or operator who elects to comply with the requirements of §63.113 of this subpart shall submit to the Administrator Periodic Reports of the following recorded information according to the schedule in §63.152 of this subpart.

(1) Reports of daily average values of monitored parameters for all operating days when the daily average values recorded under paragraphs (a) and (b) of this section were outside the ranges established in the Notification of Compliance Status or operating permit.

(2) For Group 1 points, reports of the duration of periods when monitoring data is not collected for each excursion caused by insufficient monitoring data as defined in §63.152(c)(2)(ii)(A) of this subpart.

(3) Reports of the times and durations of all periods recorded under paragraph (a)(3) of this section when the gas stream is diverted to the atmosphere through a bypass line.

(4) Reports of all periods recorded under paragraph (a)(4) of this section in which the seal mechanism is broken, the bypass line valve position has changed, or the key to unlock the bypass line valve was checked out.

(5) Reports of the times and durations of all periods recorded under paragraph (a)(2) of this section in which all pilot flames of a flare were absent.

(6) Reports of all carbon bed regeneration cycles during which the parameters recorded under paragraph (b)(2)(v) of this section were outside the ranges established in the Notification of Compliance Status or operating permit.

(g) Whenever a process change, as defined in §63.115(e) of this subpart, is made that causes a Group 2 process vent to become a Group 1 process vent, the owner or operator shall submit a report within 180 calendar days after the process change as specified in §63.151(j) of this subpart. The report shall include:

(1) A description of the process change;

(2) The results of the recalculation of the flow rate, organic HAP concentration, and TRE index value required under §63.115(e) of this subpart and recorded under paragraph (c), (d), or (e) of this section; and

(3) A statement that the owner or operator will comply with the provisions of §63.113 of this subpart for Group 1 process vents by the dates specified in subpart F of this part.

(h) Whenever a process change, as defined in §63.115(e) of this subpart, is made that causes a Group 2 process vent with a TRE greater than 4.0 to become a Group 2 process vent with a TRE less than 4.0, the owner or operator shall submit a report within 180 calendar days after the process change. The report may be submitted as part of the next periodic report. The report shall include:

(1) A description of the process change,

(2) The results of the recalculation of the TRE index value required under §63.115(e) of this subpart and recorded under paragraph (c) of this section, and

(3) A statement that the owner or operator will comply with the requirements specified in §63.113(d) of this subpart.

(i) Whenever a process change, as defined in §63.115(e) of this subpart, is made that causes a Group 2 process vent with a flow rate less than 0.005 standard cubic meter per minute to become a Group 2 process vent with a flow rate of 0.005 standard cubic meter per minute or greater and a TRE index value less than or equal to 4.0, the owner or operator shall submit a report within 180 calendar days after the process change. The report may be submitted as part of the next periodic report. The report shall include:

(1) A description of the process change,

(2) The results of the recalculation of the flow rate and the TRE determination required under §63.115(e) of this subpart and recorded under paragraph (d) of this section, and

(3) A statement that the owner or operator will comply with the requirements specified in §63.113(d) of this subpart.

(j) Whenever a process change, as defined in §63.115(e) of this subpart, is made that causes a Group 2 process vent with an organic HAP concentration less than 50 parts per million by volume to become a Group 2 process vent with an organic HAP concentration of 50 parts per million by volume or greater and a TRE index value less than or equal to 4.0, the owner or operator shall submit a report within 180 calendar days after the process change. The report may be submitted as part of the next periodic report. The report shall include:

(1) A description of the process change,

(2) The results of the recalculation of the organic HAP concentration and the TRE determination required under §63.115(e) of this subpart and recorded under paragraph (e) of this section, and

(3) A statement that the owner or operator will comply with the requirements specified in §63.113(d) of this subpart.

(k) The owner or operator is not required to submit a report of a process change if one of the conditions listed in paragraph (k)(1), (k)(2), (k)(3), or (k)(4) of this section is met.

(1) The process change does not meet the definition of a process change in §63.115(e) of this subpart, or

(2) The vent stream flow rate is recalculated according to §63.115(e) of this subpart and the recalculated value is less than 0.005 standard cubic meter per minute, or

(3) The organic HAP concentration of the vent stream is recalculated according to §63.115(e) of this subpart and the recalculated value is less than 50 parts per million by volume, or

(4) The TRE index value is recalculated according to §63.115(e) of this subpart and the recalculated value is greater than 4.0.

[59 FR 19468, Apr. 22, 1994, as amended at 62 FR 2747, Jan. 17, 1997; 66 FR 6932, Jan. 22, 2001]

**§63.119 Storage vessel provisions—reference control technology.**

(a) For each storage vessel to which this subpart applies, the owner or operator shall comply with the requirements of paragraphs (a)(1), (a)(2), (a)(3), and (a)(4) of this section according to the schedule provisions of §63.100 of subpart F of this part.

(1) For each Group 1 storage vessel (as defined in table 5 of this subpart for existing sources and table 6 of the subpart for new sources) storing a liquid for which the maximum true vapor pressure of the total organic hazardous air pollutants in the liquid is less than 76.6 kilopascals, the owner or operator shall reduce hazardous air pollutants emissions to the atmosphere either by operating and maintaining a fixed roof and internal floating roof, an external floating roof, an external floating roof converted to an internal floating roof, a closed vent system and control device, routing the emissions to a process or a fuel gas system, or vapor balancing in accordance with the requirements in paragraph (b), (c), (d), (e), (f), or (g) of this section, or equivalent as provided in §63.121 of this subpart.

(2) For each Group 1 storage vessel (as defined in table 5 of this subpart for existing sources and table 6 of this subpart for new sources) storing a liquid for which the maximum true vapor pressure of the total organic hazardous air pollutants in the liquid is greater than or equal to 76.6 kilopascals, the owner or operator shall operate and maintain a closed vent system and control device meeting the requirements specified in paragraph (e) of this section, route the emissions to a process or a fuel gas system as specified in paragraph (f) of this section, vapor balance as specified in paragraph (g) of this section, or equivalent as provided in §63.121 of this subpart.

(3) For each Group 2 storage vessel that is not part of an emissions average as described in §63.150 of this subpart, the owner or operator shall comply with the recordkeeping requirement in §63.123(a) of this subpart and is not required to comply with any other provisions in §§63.119 through 63.123 of this subpart.

(4) For each Group 2 storage vessel that is part of an emissions average, the owner or operator shall comply with the emissions averaging provisions in §63.150 of this subpart.

(b) The owner or operator who elects to use a fixed roof and an internal floating roof, as defined in §63.111 of this subpart, to comply with the requirements of paragraph (a)(1) of this section shall comply with the requirements specified in paragraphs (b)(1) through (b)(6) of this section.

NOTE: The intent of paragraphs (b)(1) and (b)(2) of this section is to avoid having a vapor space between the floating roof and the stored liquid for extended periods. Storage vessels may be emptied for purposes such as routine storage vessel maintenance, inspections, petroleum liquid deliveries, or transfer operations. Storage vessels where liquid is left on walls, as bottom clingage, or in pools due to floor irregularity are considered completely empty.

(1) The internal floating roof shall be floating on the liquid surface at all times except when the floating roof must be supported by the leg supports during the periods specified in paragraphs (b)(1)(i) through (b)(1)(iii) of this section.

(i) During the initial fill.

(ii) After the vessel has been completely emptied and degassed.

(iii) When the vessel is completely emptied before being subsequently refilled.

(2) When the floating roof is resting on the leg supports, the process of filling, emptying, or refilling shall be continuous and shall be accomplished as soon as practical.

(3) Each internal floating roof shall be equipped with a closure device between the wall of the storage vessel and the roof edge. Except as provided in paragraph (b)(3)(iv) of this section, the closure device shall consist of one of the devices listed in paragraph (b)(3)(i), (b)(3)(ii), or (b)(3)(iii) of this section.

(i) A liquid-mounted seal as defined in §63.111 of this subpart.

(ii) A metallic shoe seal as defined in §63.111 of this subpart.

(iii) Two seals mounted one above the other so that each forms a continuous closure that completely covers the space between the wall of the storage vessel and the edge of the internal floating roof. The lower seal may be vapor-mounted, but both must be continuous seals.

(iv) If the internal floating roof is equipped with a vapor-mounted seal as of December 31, 1992, the requirement for one of the seal options specified in paragraphs (b)(3)(i), (b)(3)(ii), and (b)(3)(iii) of this section does not apply until the earlier of the dates specified in paragraphs (b)(3)(iv)(A) and (b)(3)(iv)(B) of this section.

(A) The next time the storage vessel is emptied and degassed.

(B) No later than 10 years after April 22, 1994.

(4) Automatic bleeder vents are to be closed at all times when the roof is floating, except when the roof is being floated off or is being landed on the roof leg supports.

(5) Except as provided in paragraph (b)(5)(viii) of this section, each internal floating roof shall meet the specifications listed in paragraphs (b)(5)(i) through (b)(5)(vii) of this section.

(i) Each opening in a noncontact internal floating roof except for automatic bleeder vents (vacuum breaker vents) and rim space vents is to provide a projection below the liquid surface.

(ii) Each opening in the internal floating roof except for leg sleeves, automatic bleeder vents, rim space vents, column wells, ladder wells, sample wells, and stub drains shall be equipped with a cover or lid. The cover or lid shall be equipped with a gasket.

(iii) Each penetration of the internal floating roof for the purposes of sampling shall be a sample well. Each sample well shall have a slit fabric cover that covers at least 90 percent of the opening.

(iv) Each automatic bleeder vent shall be gasketed.

(v) Each rim space vent shall be gasketed.

(vi) Each penetration of the internal floating roof that allows for passage of a ladder shall have a gasketed sliding cover.

(vii) Each penetration of the internal floating roof that allows for passage of a column supporting the fixed roof shall have a flexible fabric sleeve seal or a gasketed sliding cover.

(viii) If the internal floating roof does not meet any one of the specifications listed in paragraphs (b)(5)(i) through (b)(5)(vii) of this section as of December 31, 1992, the requirement for meeting those specifications does not apply until the earlier of the dates specified in paragraphs (b)(5)(viii)(A) and (b)(5)(viii)(B) of this section.

(A) The next time the storage vessel is emptied and degassed.

(B) No later than 10 years after April 22, 1994.

(6) Each cover or lid on any opening in the internal floating roof shall be closed (i.e., no visible gaps), except when the cover or lid must be open for access. Covers on each access hatch and each gauge float well shall be bolted or fastened so as to be air-tight when they are closed. Rim space vents are to be set to open only when the internal floating roof is not floating or when the pressure beneath the rim seal exceeds the manufacturer's recommended setting.

(c) The owner or operator who elects to use an external floating roof, as defined in §63.111 of this subpart, to comply with the requirements of paragraph (a)(1) of this section shall comply with the requirements specified in paragraphs (c)(1) through (c)(4) of this section.

(1) Each external floating roof shall be equipped with a closure device between the wall of the storage vessel and the roof edge.

(i) Except as provided in paragraph (c)(1)(iv) of this section, the closure device is to consist of two seals, one above the other. The lower seal is referred to as the primary seal and the upper seal is referred to as the secondary seal.

(ii) Except as provided in paragraph (c)(1)(v) of this section, the primary seal shall be either a metallic shoe seal or a liquid-mounted seal.

(iii) Except during the inspections required by §63.120(b) of this subpart, both the primary seal and the secondary seal shall completely cover the annular space between the external floating roof and the wall of the storage vessel in a continuous fashion.

(iv) If the external floating roof is equipped with a liquid-mounted or metallic shoe primary seal as of December 31, 1992, the requirement for a secondary seal in paragraph (c)(1)(i) of this section does not apply until the earlier of the dates specified in paragraphs (c)(1)(iv)(A) and (c)(1)(iv)(B) of this section.

(A) The next time the storage vessel is emptied and degassed.

(B) No later than 10 years after April 22, 1994.

(v) If the external floating roof is equipped with a vapor-mounted primary seal and a secondary seal as of December 31, 1992, the requirement for a liquid-mounted or metallic shoe primary seal in paragraph (c)(1)(ii) of this section does not apply until the earlier of the dates specified in paragraphs (c)(1)(v)(A) and (c)(1)(v)(B) of this section.

(A) The next time the storage vessel is emptied and degassed.

(B) No later than 10 years after April 22, 1994.

(2) Each external floating roof shall meet the specifications listed in paragraphs (c)(2)(i) through (c)(2)(xii) of this section.

(i) Except for automatic bleeder vents (vacuum breaker vents) and rim space vents, each opening in the noncontact external floating roof shall provide a projection below the liquid surface except as provided in paragraph (c)(2)(xii) of this section.

(ii) Except for automatic bleeder vents, rim space vents, roof drains, and leg sleeves, each opening in the roof is to be equipped with a gasketed cover, seal or lid which is to be maintained in a closed position (i.e., no visible gap) at all times except when the cover or lid must be open for access. Covers on each access hatch and each gauge float well shall be bolted or fastened so as to be air-tight when they are closed.

(iii) Automatic bleeder vents are to be closed at all times when the roof is floating, except when the roof is being floated off or is being landed on the roof leg supports.

(iv) Rim space vents are to be set to open only when the roof is being floated off the roof leg supports or when the pressure beneath the rim seal exceeds the manufacturer's recommended setting.

(v) Automatic bleeder vents and rim space vents are to be gasketed.

(vi) Each roof drain that empties into the stored liquid is to be provided with a slotted membrane fabric cover that covers at least 90 percent of the area of the opening.

(vii) Each unslotted guide pole well shall have a gasketed sliding cover or a flexible fabric sleeve seal.

(viii) Each unslotted guide pole shall have on the end of the pole a gasketed cap which is closed at all times except when gauging the liquid level or taking liquid samples.

(ix) Each slotted guide pole well shall have a gasketed sliding cover or a flexible fabric sleeve seal.

(x) Each slotted guide pole shall have a gasketed float or other device which closes off the liquid surface from the atmosphere.

(xi) Each gauge hatch/sample well shall have a gasketed cover which is closed at all times except when the hatch or well must be open for access.

(xii) If each opening in a noncontact external floating roof except for automatic bleeder vents (vacuum breaker vents) and rim space vents does not provide a projection below the liquid surface as of December 31, 1992, the requirement for providing these projections below the liquid surface does not apply until the earlier of the dates specified in paragraphs (c)(2)(xii)(A) and (c)(2)(xii)(B) of this section.

(A) The next time the storage vessel is emptied and degassed.

(B) No later than 10 years after April 22, 1994.

NOTE: The intent of paragraphs (c)(3) and (c)(4) of this section is to avoid having a vapor space between the floating roof and the stored liquid for extended periods. Storage vessels may be emptied for purposes such as routine storage vessel maintenance, inspections, petroleum liquid deliveries, or transfer operations. Storage vessels where liquid is left on walls, as bottom clingage, or in pools due to floor irregularity are considered completely empty.

(3) The external floating roof shall be floating on the liquid surface at all times except when the floating roof must be supported by the leg supports during the periods specified in paragraphs (c)(3)(i) through (c)(3)(iii) of this section.

(i) During the initial fill.

(ii) After the vessel has been completely emptied and degassed.

(iii) When the vessel is completely emptied before being subsequently refilled.

(4) When the floating roof is resting on the leg supports, the process of filling, emptying, or refilling shall be continuous and shall be accomplished as soon as practical.



(d) The owner or operator who elects to use an external floating roof converted to an internal floating roof (i.e., fixed roof installed above external floating roof) to comply with paragraph (a)(1) of this section shall comply with paragraphs (d)(1) and (d)(2) of this section.

(1) Comply with the requirements for internal floating roof vessels specified in paragraphs (b)(1), (2), and (3) of this section; and

(2) Comply with the requirements for deck fittings that are specified for external floating roof vessels in paragraphs (c)(2)(i) through (c)(2)(xii) of this section.

(e) The owner or operator who elects to use a closed vent system and control device, as defined in §63.111 of this subpart, to comply with the requirements of paragraph (a)(1) or (a)(2) of this section shall comply with the requirements specified in paragraphs (e)(1) through (e)(5) of this section.

(1) Except as provided in paragraph (e)(2) of this section, the control device shall be designed and operated to reduce inlet emissions of total organic HAP by 95 percent or greater. If a flare is used as the control device, it shall meet the specifications described in the general control device requirements of §63.11(b) of subpart A of this part.

(2) If the owner or operator can demonstrate that a control device installed on a storage vessel on or before December 31, 1992 is designed to reduce inlet emissions of total organic HAP by greater than or equal to 90 percent but less than 95 percent, then the control device is required to be operated to reduce inlet emissions of total organic HAP by 90 percent or greater.

(3) Periods of planned routine maintenance of the control device, during which the control device does not meet the specifications of paragraph (e)(1) or (e)(2) of this section, as applicable, shall not exceed 240 hours per year.

(4) The specifications and requirements in paragraphs (e)(1) and (e)(2) of this section for control devices do not apply during periods of planned routine maintenance.

(5) The specifications and requirements in paragraphs (e)(1) and (e)(2) of this section for control devices do not apply during a control system malfunction.

(6) An owner or operator may use a combination of control devices to achieve the required reduction of total organic hazardous air pollutants specified in paragraph (e)(1) of this section. An owner or operator may use a combination of control devices installed on a storage vessel on or before December 31, 1992 to achieve the required reduction of total organic hazardous air pollutants specified in paragraph (e)(2) of this section.

(f) The owner or operator who elects to route emissions to a fuel gas system or to a process, as defined in §63.111 of this subpart, to comply with the requirements of paragraph (a)(1) or (a)(2) of this section shall comply with the requirements in paragraphs (f)(1) through (f)(3) of this section, as applicable.

(1) If emissions are routed to a fuel gas system, there is no requirement to conduct a performance test or design evaluation. If emissions are routed to a process, the organic hazardous air pollutants in the emissions shall predominantly meet one of, or a combination of, the ends specified in paragraphs (f)(1)(i) through (f)(1)(iv) of this section. The owner or operator shall comply with the compliance demonstration requirements in §63.120(f).

(i) Recycled and/or consumed in the same manner as a material that fulfills the same function in that process;

- (ii) Transformed by chemical reaction into materials that are not organic hazardous air pollutants;
- (iii) Incorporated into a product; and/or
- (iv) Recovered.

(2) If the emissions are conveyed by a system other than hard-piping, any conveyance system operated under positive pressure shall be subject to the requirements of §63.148 of this subpart.

(3) The fuel gas system or process shall be operating at all times when organic hazardous air pollutants emissions are routed to it except as provided in §63.102(a)(1) of subpart F of this part and in paragraphs (f)(3)(i) through (f)(3)(iii) of this section. Whenever the owner or operator by-passes the fuel gas system or process, the owner or operator shall comply with the recordkeeping requirement in §63.123(h) of this subpart. Bypassing is permitted if the owner or operator complies with one or more of the conditions specified in paragraphs (f)(3)(i) through (f)(3)(iii) of this section.

(i) The liquid level in the storage vessel is not increased;

(ii) The emissions are routed through a closed-vent system to a control device complying with §63.119(e) of this subpart; or

(iii) The total aggregate amount of time during which the emissions by-pass the fuel gas system or process during the calendar year without being routed to a control device, for all reasons (except start-ups/shutdowns/malfunctions or product changeovers of flexible operation units and periods when the storage vessel has been emptied and degassed), does not exceed 240 hours.

(g) The owner or operator who elects to vapor balance to comply with the requirements of paragraphs (a)(1) and (2) of this section shall comply with paragraphs (g)(1) through (7) of this section and the recordkeeping requirements of §63.123(i).

(1) The vapor balancing system must be designed and operated to route organic HAP vapors displaced from loading of the storage tank to the railcar, tank truck, or barge from which the storage tank is filled.

(2) Tank trucks and railcars must have a current certification in accordance with the U.S. Department of Transportation pressure test requirements of 49 CFR part 180 for tank trucks and 49 CFR 173.31 for railcars. Barges must have a current certification of vapor-tightness through testing in accordance with 40 CFR 63.565.

(3) Hazardous air pollutants must only be unloaded from tank trucks or railcars when vapor collection systems are connected to the storage tank's vapor collection system.

(4) No pressure relief device on the storage tank, or on the railcar or tank truck, shall open during loading or as a result of diurnal temperature changes (breathing losses).

(5) Pressure relief devices must be set to no less than 2.5 psig at all times to prevent breathing losses. Pressure relief devices may be set at values less than 2.5 psig if the owner or operator provides rationale in the notification of compliance status report explaining why the alternative value is sufficient to prevent breathing losses at all times. The owner or operator shall comply with paragraphs (g)(5)(i) through (iii) of this section for each pressure relief valve.

(i) The pressure relief valve shall be monitored quarterly using the method described in §63.180(b).

(ii) An instrument reading of 500 ppmv or greater defines a leak.

(iii) When a leak is detected, it shall be repaired as soon as practicable, but no later than 5 days after it is detected, and the owner or operator shall comply with the recordkeeping requirements of §63.181(d)(1) through (4).

(6) Railcars, tank trucks, or barges that deliver HAP to a storage tank must be reloaded or cleaned at a facility that utilizes the control techniques specified in paragraph (g)(6)(i) or (ii) of this section.

(i) The railcar, tank truck, or barge must be connected to a closed-vent system with a control device that reduces inlet emissions of HAP by 95 percent by weight or greater.

(ii) A vapor balancing system designed and operated to collect organic HAP vapor displaced from the tank truck, railcar, or barge during reloading must be used to route the collected HAP vapor to the storage tank from which the liquid being transferred originated.

(7) The owner or operator of the facility where the railcar, tank truck, or barge is reloaded or cleaned must comply with paragraphs (g)(7)(i) through (iii) of this section.

(i) Submit to the owner or operator of the storage tank and to the Administrator a written certification that the reloading or cleaning facility will meet the requirements of this section. The certifying entity may revoke the written certification by sending a written statement to the owner or operator of the storage tank giving at least 90 days notice that the certifying entity is rescinding acceptance of responsibility for compliance with the requirements of this paragraph (g)(7).

(ii) If complying with paragraph (g)(6)(i) of this section, comply with the requirements for closed vent system and control device specified in §§63.119 through 63.123. The notification and reporting requirements in §63.122 do not apply to the owner or operator of the offsite cleaning or reloading facility.

(iii) If complying with paragraph (g)(6)(ii) of this section, keep the records specified in §63.123(i)(3).

(iv) After the compliance dates specified in §63.100(k) at an offsite reloading or cleaning facility subject to paragraph (g) of this section, compliance with the monitoring, recordkeeping, and reporting provisions of any other subpart of this part 63 constitutes compliance with the monitoring, recordkeeping, and reporting provisions of paragraph (g)(7)(ii) or paragraph (g)(7)(iii) of this section. You must identify in your Notification of Compliance Status report required by §63.152(b), the subpart to the part 63 with which the owner or operator of the reloading or cleaning facility complies.

[59 FR 19468, Apr. 22, 1994, as amended at 62 FR 2747, Jan. 17, 1997; 69 FR 76863, Dec. 23, 2004; 71 FR 76614, Dec. 21, 2006]

### **§63.120 Storage vessel provisions—procedures to determine compliance.**

(a) To demonstrate compliance with §63.119(b) of this subpart (storage vessel equipped with a fixed roof and internal floating roof) or with §63.119(d) of this subpart (storage vessel equipped with an external floating roof converted to an internal floating roof), the owner or operator shall comply with the requirements in paragraphs (a)(1) through (a)(7) of this section.

(1) The owner or operator shall visually inspect the internal floating roof, the primary seal, and the secondary seal (if one is in service), according to the schedule specified in paragraphs (a)(2) and (a)(3) of this section.

(2) For vessels equipped with a single-seal system, the owner or operator shall perform the inspections specified in paragraphs (a)(2)(i) and (a)(2)(ii) of this section.

(i) Visually inspect the internal floating roof and the seal through manholes and roof hatches on the fixed roof at least once every 12 months after initial fill, or at least once every 12 months after the compliance date specified in §63.100 of subpart F of this part.

(ii) Visually inspect the internal floating roof, the seal, gaskets, slotted membranes, and sleeve seals (if any) each time the storage vessel is emptied and degassed, and at least once every 10 years after the compliance date specified in §63.100 of subpart F of this part.

(3) For vessels equipped with a double-seal system as specified in §63.119(b)(3)(iii) of this subpart, the owner or operator shall perform either the inspection required in paragraph (a)(3)(i) of this section or the inspections required in both paragraphs (a)(3)(ii) and (a)(3)(iii) of this section.

(i) The owner or operator shall visually inspect the internal floating roof, the primary seal, the secondary seal, gaskets, slotted membranes, and sleeve seals (if any) each time the storage vessel is emptied and degassed and at least once every 5 years after the compliance date specified in §63.100 of subpart F of this part; or

(ii) The owner or operator shall visually inspect the internal floating roof and the secondary seal through manholes and roof hatches on the fixed roof at least once every 12 months after initial fill, or at least once every 12 months after the compliance date specified in §63.100 of subpart F of this part, and

(iii) Visually inspect the internal floating roof, the primary seal, the secondary seal, gaskets, slotted membranes, and sleeve seals (if any) each time the vessel is emptied and degassed and at least once every 10 years after the compliance date specified in §63.100 of subpart F of this part.

(4) If during the inspections required by paragraph (a)(2)(i) or (a)(3)(ii) of this section, the internal floating roof is not resting on the surface of the liquid inside the storage vessel and is not resting on the leg supports; or there is liquid on the floating roof; or the seal is detached; or there are holes or tears in the seal fabric; or there are visible gaps between the seal and the wall of the storage vessel, the owner or operator shall repair the items or empty and remove the storage vessel from service within 45 calendar days. If a failure that is detected during inspections required by paragraph (a)(2)(i) or (a)(3)(ii) of this section cannot be repaired within 45 calendar days and if the vessel cannot be emptied within 45 calendar days, the owner or operator may utilize up to 2 extensions of up to 30 additional calendar days each. Documentation of a decision to utilize an extension shall include a description of the failure, shall document that alternate storage capacity is unavailable, and shall specify a schedule of actions that will ensure that the control equipment will be repaired or the vessel will be emptied as soon as practical.

(5) Except as provided in paragraph (a)(6) of this section, for all the inspections required by paragraphs (a)(2)(ii), (a)(3)(i), and (a)(3)(iii) of this section, the owner or operator shall notify the Administrator in writing at least 30 calendar days prior to the refilling of each storage vessel to afford the Administrator the opportunity to have an observer present.

(6) If the inspection required by paragraph (a)(2)(ii), (a)(3)(i), or (a)(3)(iii) of this section is not planned and the owner or operator could not have known about the inspection 30 calendar days in advance of refilling the vessel, the owner or operator shall notify the Administrator at least 7 calendar days prior to the refilling of the storage vessel. Notification may be made by telephone and immediately followed by written documentation demonstrating why the inspection was unplanned. Alternatively, the notification including the written documentation may be made in writing and sent so that it is received by the Administrator at least 7 calendar days prior to refilling.

(7) If during the inspections required by paragraph (a)(2)(ii), (a)(3)(i), or (a)(3)(iii) of this section, the internal floating roof has defects; or the primary seal has holes, tears, or other openings in the seal or the seal fabric; or the secondary seal has holes, tears, or other openings in the seal or the seal fabric; or the gaskets no longer close off the liquid surface from the atmosphere; or the slotted membrane has more than 10 percent open area, the owner or operator shall repair the items as necessary so that none of the conditions specified in this paragraph exist before refilling the storage vessel with organic HAP.

(b) To demonstrate compliance with §63.119(c) of this subpart (storage vessel equipped with an external floating roof), the owner or operator shall comply with the requirements specified in paragraphs (b)(1) through (b)(10) of this section.

(1) Except as provided in paragraph (b)(7) of this section, the owner or operator shall determine the gap areas and maximum gap widths between the primary seal and the wall of the storage vessel, and the secondary seal and the wall of the storage vessel according to the frequency specified in paragraphs (b)(1)(i) through (b)(1)(iii) of this section.

(i) For an external floating roof vessel equipped with primary and secondary seals, measurements of gaps between the vessel wall and the primary seal shall be performed during the hydrostatic testing of the vessel or by the compliance date specified in §63.100 of subpart F of this part, whichever occurs last, and at least once every 5 years thereafter.

(ii) For an external floating roof vessel equipped with a liquid-mounted or metallic shoe primary seal and without a secondary seal as provided for in §63.119(c)(1)(iv) of this subpart, measurements of gaps between the vessel wall and the primary seal shall be performed by the compliance date specified in §63.100 of subpart F of this part and at least once per year thereafter, until a secondary seal is installed. When a secondary seal is installed above the primary seal, measurements of gaps between the vessel wall and both the primary and secondary seals shall be performed within 90 calendar days of installation of the secondary seal, and according to the frequency specified in paragraphs (b)(1)(i) and (b)(1)(iii) of this section thereafter.

(iii) For an external floating roof vessel equipped with primary and secondary seals, measurements of gaps between the vessel wall and the secondary seal shall be performed by the compliance date specified in §63.100 of subpart F of this part and at least once per year thereafter.

(iv) If any storage vessel ceases to store organic HAP for a period of 1 year or more, or if the maximum true vapor pressure of the total organic HAP's in the stored liquid falls below the values defining Group 1 storage vessels specified in table 5 or table 6 of this subpart for a period of 1 year or more, measurements of gaps between the vessel wall and the primary seal, and gaps between the vessel wall and the secondary seal shall be performed within 90 calendar days of the vessel being refilled with organic HAP.

(2) Except as provided in paragraph (b)(7) of this section, the owner or operator shall determine gap widths and gap areas in the primary and secondary seals (seal gaps) individually by the procedures described in paragraphs (b)(2)(i) through (b)(2)(iii) of this section.

(i) Seal gaps, if any, shall be measured at one or more floating roof levels when the roof is not resting on the roof leg supports.

(ii) Seal gaps, if any, shall be measured around the entire circumference of the vessel in each place where an 0.32 centimeter ( $\frac{1}{8}$  inch) diameter uniform probe passes freely (without forcing or binding against the seal) between the seal and the wall of the storage vessel. The circumferential distance of each such location shall also be measured.

(iii) The total surface area of each gap described in paragraph (b)(2)(ii) of this section shall be determined by using probes of various widths to measure accurately the actual distance from the vessel wall to the seal and multiplying each such width by its respective circumferential distance.

(3) The owner or operator shall add the gap surface area of each gap location for the primary seal and divide the sum by the nominal diameter of the vessel. The accumulated area of gaps between the vessel wall and the primary seal shall not exceed 212 square centimeters per meter of vessel diameter and the width of any portion of any gap shall not exceed 3.81 centimeters.

(4) The owner or operator shall add the gap surface area of each gap location for the secondary seal and divide the sum by the nominal diameter of the vessel. The accumulated area of gaps between the vessel wall and the secondary seal shall not exceed 21.2 square centimeters per meter of vessel diameter and the width of any portion of any gap shall not exceed 1.27 centimeters. These seal gap requirements may be exceeded during the measurement of primary seal gaps as required by paragraph (b)(1)(i) and (b)(1)(ii) of this section.

(5) The primary seal shall meet the additional requirements specified in paragraphs (b)(5)(i) and (b)(5)(ii) of this section.

(i) Where a metallic shoe seal is in use, one end of the metallic shoe shall extend into the stored liquid and the other end shall extend a minimum vertical distance of 61 centimeters above the stored liquid surface.

(ii) There shall be no holes, tears, or other openings in the shoe, seal fabric, or seal envelope.

(6) The secondary seal shall meet the additional requirements specified in paragraphs (b)(6)(i) and (b)(6)(ii) of this section.

(i) The secondary seal shall be installed above the primary seal so that it completely covers the space between the roof edge and the vessel wall except as provided in paragraph (b)(4) of this section.

(ii) There shall be no holes, tears, or other openings in the seal or seal fabric.

(7) If the owner or operator determines that it is unsafe to perform the seal gap measurements required in paragraphs (b)(1) and (b)(2) of this section or to inspect the vessel to determine compliance with paragraphs (b)(5) and (b)(6) of this section because the floating roof appears to be structurally unsound and poses an imminent or potential danger to inspecting personnel, the owner or operator shall comply with the requirements in either paragraph (b)(7)(i) or (b)(7)(ii) of this section.

(i) The owner or operator shall measure the seal gaps or inspect the storage vessel no later than 30 calendar days after the determination that the roof is unsafe, or

(ii) The owner or operator shall empty and remove the storage vessel from service no later than 45 calendar days after determining that the roof is unsafe. If the vessel cannot be emptied within 45 calendar days, the owner or operator may utilize up to 2 extensions of up to 30 additional calendar days each. Documentation of a decision to utilize an extension shall include an explanation of why it was unsafe to perform the inspection or seal gap measurement, shall document that alternate storage capacity is unavailable, and shall specify a schedule of actions that will ensure that the vessel will be emptied as soon as practical.

(8) The owner or operator shall repair conditions that do not meet requirements listed in paragraphs (b)(3), (b)(4), (b)(5), and (b)(6) of this section (i.e., failures) no later than 45 calendar days after identification, or shall empty and remove the storage vessel from service no later than 45 calendar days

after identification. If during seal gap measurements required in paragraph (b)(1) and (b)(2) of this section or during inspections necessary to determine compliance with paragraphs (b)(5) and (b)(6) of this section a failure is detected that cannot be repaired within 45 calendar days and if the vessel cannot be emptied within 45 calendar days, the owner or operator may utilize up to 2 extensions of up to 30 additional calendar days each. Documentation of a decision to utilize an extension shall include a description of the failure, shall document that alternate storage capacity is unavailable, and shall specify a schedule of actions that will ensure that the control equipment will be repaired or the vessel will be emptied as soon as practical.

(9) The owner or operator shall notify the Administrator in writing 30 calendar days in advance of any gap measurements required by paragraph (b)(1) or (b)(2) of this section to afford the Administrator the opportunity to have an observer present.

(10) The owner or operator shall visually inspect the external floating roof, the primary seal, secondary seal, and fittings each time the vessel is emptied and degassed.

(i) If the external floating roof has defects; the primary seal has holes, tears, or other openings in the seal or the seal fabric; or the secondary seal has holes, tears, or other openings in the seal or the seal fabric; or the gaskets no longer close off the liquid surface from the atmosphere; or the slotted membrane has more than 10 percent open area, the owner or operator shall repair the items as necessary so that none of the conditions specified in this paragraph exist before filling or refilling the storage vessel with organic HAP.

(ii) Except as provided in paragraph (b)(10)(iii) of this section, for all the inspections required by paragraph (b)(10) of this section, the owner or operator shall notify the Administrator in writing at least 30 calendar days prior to filling or refilling of each storage vessel with organic HAP to afford the Administrator the opportunity to inspect the storage vessel prior to refilling.

(iii) If the inspection required by paragraph (b)(10) of this section is not planned and the owner or operator could not have known about the inspection 30 calendar days in advance of refilling the vessel with organic HAP, the owner or operator shall notify the Administrator at least 7 calendar days prior to refilling of the storage vessel. Notification may be made by telephone and immediately followed by written documentation demonstrating why the inspection was unplanned. Alternatively, this notification including the written documentation may be made in writing and sent so that it is received by the Administrator at least 7 calendar days prior to the refilling.

(c) To demonstrate compliance with §63.119(d) of this subpart (storage vessel equipped with an external floating roof converted to an internal floating roof), the owner or operator shall comply with the requirements of paragraph (a) of this section.

(d) To demonstrate compliance with §63.119(e) of this subpart (storage vessel equipped with a closed vent system and control device) using a control device other than a flare, the owner or operator shall comply with the requirements in paragraphs (d)(1) through (d)(7) of this section, except as provided in paragraph (d)(8) of this section.

(1) The owner or operator shall either prepare a design evaluation, which includes the information specified in paragraph (d)(1)(i) of this section, or submit the results of a performance test as described in paragraph (d)(1)(ii) of this section.

(i) The design evaluation shall include documentation demonstrating that the control device being used achieves the required control efficiency during reasonably expected maximum filling rate. This documentation is to include a description of the gas stream which enters the control device, including flow and organic HAP content under varying liquid level conditions, and the information specified in paragraphs (d)(1)(i)(A) through (d)(1)(i)(E) of this section, as applicable.

(A) If the control device receives vapors, gases or liquids, other than fuels, from emission points other than storage vessels subject to this subpart, the efficiency demonstration is to include consideration of all vapors, gases, and liquids, other than fuels, received by the control device.

(B) If an enclosed combustion device with a minimum residence time of 0.5 seconds and a minimum temperature of 760 °C is used to meet the emission reduction requirement specified in §63.119 (e)(1) or (e)(2), as applicable, documentation that those conditions exist is sufficient to meet the requirements of paragraph (d)(1)(i) of this section.

(C) Except as provided in paragraph (d)(1)(i)(B) of this section, for thermal incinerators, the design evaluation shall include the autoignition temperature of the organic HAP, the flow rate of the organic HAP emission stream, the combustion temperature, and the residence time at the combustion temperature.

(D) For carbon adsorbers, the design evaluation shall include the affinity of the organic HAP vapors for carbon, the amount of carbon in each bed, the number of beds, the humidity of the feed gases, the temperature of the feed gases, the flow rate of the organic HAP emission stream, the desorption schedule, the regeneration stream pressure or temperature, and the flow rate of the regeneration stream. For vacuum desorption, pressure drop shall be included.

(E) For condensers, the design evaluation shall include the final temperature of the organic HAP vapors, the type of condenser, and the design flow rate of the organic HAP emission stream.

(ii) If the control device used to comply with §63.119(e) of this subpart is also used to comply with §63.113(a)(2), §63.126(b)(1), or §63.139(c) of this subpart, the performance test required by §63.116(c), §63.128(a), or §63.139(d)(1) of this subpart is acceptable to demonstrate compliance with §63.119(e) of this subpart. The owner or operator is not required to prepare a design evaluation for the control device as described in paragraph (d)(1)(i) of this section, if the performance tests meets the criteria specified in paragraphs (d)(1)(ii)(A) and (d)(1)(ii)(B) of this section.

(A) The performance test demonstrates that the control device achieves greater than or equal to the required control efficiency specified in §63.119 (e)(1) or (e)(2) of this subpart, as applicable; and

(B) The performance test is submitted as part of the Notification of Compliance Status required by §63.151(b) of this subpart.

(2) The owner or operator shall submit, as part of the Notification of Compliance Status required by §63.151 (b) of this subpart, a monitoring plan containing the information specified in paragraph (d)(2)(i) of this section and in either (d)(2)(ii) or (d)(2)(iii) of this section.

(i) A description of the parameter or parameters to be monitored to ensure that the control device is being properly operated and maintained, an explanation of the criteria used for selection of that parameter (or parameters), and the frequency with which monitoring will be performed (e.g., when the liquid level in the storage vessel is being raised); and either

(ii) The documentation specified in paragraph (d)(1)(i) of this section, if the owner or operator elects to prepare a design evaluation; or

(iii) The information specified in paragraph (d)(2)(iii) (A) and (B) of this section if the owner or operator elects to submit the results of a performance test.

(A) Identification of the storage vessel and control device for which the performance test will be submitted, and



(B) Identification of the emission point(s) that share the control device with the storage vessel and for which the performance test will be conducted.

(3) The owner or operator shall submit, as part of the Notification of Compliance Status required by §63.152(b) of this subpart, the information specified in paragraphs (d)(3)(i) and, if applicable, (d)(3)(ii) of this section.

(i) The operating range for each monitoring parameter identified in the monitoring plan. The specified operating range shall represent the conditions for which the control device is being properly operated and maintained.

(ii) Results of the performance test described in paragraph (d)(1)(ii) of this section.

(4) The owner or operator shall demonstrate compliance with the requirements of §63.119(e)(3) of this subpart (planned routine maintenance of a control device, during which the control device does not meet the specifications of §63.119 (e)(1) or (e)(2) of this subpart, as applicable, shall not exceed 240 hours per year) by including in each Periodic Report required by §63.152(c) of this subpart the information specified in §63.122(g)(1) of this subpart.

(5) The owner or operator shall monitor the parameters specified in the Notification of Compliance Status required in §63.152(b) of this subpart or in the operating permit and shall operate and maintain the control device such that the monitored parameters remain within the ranges specified in the Notification of Compliance Status.

(6) Except as provided in paragraph (d)(7) of this section, each closed vent system shall be inspected as specified in §63.148 of this subpart. The initial and annual inspections required by §63.148(b) of this subpart shall be done during filling of the storage vessel.

(7) For any fixed roof tank and closed vent system that are operated and maintained under negative pressure, the owner or operator is not required to comply with the requirements specified in §63.148 of this subpart.

(8) A design evaluation or performance test is not required, if the owner or operator uses a combustion device meeting the criteria in paragraph (d)(8)(i), (d)(8)(ii), (d)(8)(iii), or (d)(8)(iv) of this section.

(i) A boiler or process heater with a design heat input capacity of 44 megawatts or greater.

(ii) A boiler or process heater burning hazardous waste for which the owner or operator:

(A) Has been issued a final permit under 40 CFR part 270 and complies with the requirements of 40 CFR part 266, subpart H, or

(B) Has certified compliance with the interim status requirements of 40 CFR part 266, subpart H.

(iii) A hazardous waste incinerator for which the owner or operator has been issued a final permit under 40 CFR part 270 and complies with the requirements of 40 CFR part 264, subpart O or has certified compliance with the interim status requirements of 40 CFR part 265, subpart O.

(iv) A boiler or process heater into which the vent stream is introduced with the primary fuel.

(e) To demonstrate compliance with §63.119(e) of this subpart (storage vessel equipped with a closed vent system and control device) using a flare, the owner or operator shall comply with the requirements in paragraphs (e)(1) through (e)(6) of this section.

(1) The owner or operator shall perform the compliance determination specified in §63.11(b) of subpart A of this part.

(2) The owner or operator shall submit, as part of the Notification of Compliance Status required by §63.152(b) of this subpart, the information specified in paragraphs (e)(2)(i) through (e)(2)(iii) of this section.

(i) Flare design (i.e., steam-assisted, air-assisted, or non-assisted);

(ii) All visible emission readings, heat content determinations, flow rate measurements, and exit velocity determinations made during the compliance determination required by paragraph (e)(1) of this section; and

(iii) All periods during the compliance determination when the pilot flame is absent.

(3) The owner or operator shall demonstrate compliance with the requirements of §63.119(e)(3) of this subpart (planned routine maintenance of a flare, during which the flare does not meet the specifications of §63.119(e)(1) of this subpart, shall not exceed 240 hours per year) by including in each Periodic Report required by §63.152(c) of this subpart the information specified in §63.122(g)(1) of this subpart.

(4) The owner or operator shall continue to meet the general control device requirements specified in §63.11(b) of subpart A of this part.

(5) Except as provided in paragraph (e)(6) of this section, each closed vent system shall be inspected as specified in §63.148 of this subpart. The inspections required to be performed in accordance with §63.148(c) of this subpart shall be done during filling of the storage vessel.

(6) For any fixed roof tank and closed vent system that is operated and maintained under negative pressure, the owner or operator is not required to comply with the requirements specified in §63.148 of this subpart.

(f) To demonstrate compliance with §63.119(f) of this subpart (storage vessel routed to a process), the owner or operator shall prepare a design evaluation (or engineering assessment) that demonstrates the extent to which one or more of the ends specified in §63.119(f)(1)(i) through (f)(1)(iv) are being met. The owner or operator shall submit the design evaluation as part of the Notification of Compliance Status required by §63.152(b) of this subpart.

[59 FR 19468, Apr. 22, 1994, as amended at 61 FR 64576, Dec. 5, 1996; 62 FR 2748, Jan. 17, 1997]

### **§63.121 Storage vessel provisions—alternative means of emission limitation.**

(a) Determination of equivalence to the reduction in emissions achieved by the requirements of §63.119 (b), (c), or (d) of this subpart will be evaluated according to §63.102(b) of subpart F of this part.

(b) The determination of equivalence referred to in paragraph (a) of this section will be based on the application to the Administrator which shall include the information specified in either paragraph (b)(1) or (b)(2) of this section.

(1) Actual emissions tests that use full-size or scale-model storage vessels that accurately collect and measure all organic HAP emissions from a given control technique, and that accurately simulate wind and account for other emission variables such as temperature and barometric pressure, or

(2) An engineering analysis that the Administrator determines is an accurate method of determining equivalence.

**§63.122 Storage vessel provisions—reporting.**

(a) For each Group 1 storage vessel, the owner or operator shall comply with the requirements of paragraphs (a)(1) through (a)(5) of this section.

(1) The owner or operator shall submit an Initial Notification as required by §63.151(b) of this subpart.

(2) [Reserved]

(3) The owner or operator shall submit a Notification of Compliance Status as required by §63.152(b) of this subpart and shall submit as part of the Notification of Compliance Status the information specified in paragraph (c) of this section.

(4) The owner or operator shall submit Periodic Reports as required by §63.152(c) of this subpart and shall submit as part of the Periodic Reports the information specified in paragraphs (d), (e), (f), and (g) of this section.

(5) The owner or operator shall submit, as applicable, other reports as required by §63.152(d) of this subpart, containing the information specified in paragraph (h) of this section.

(b) An owner or operator who elects to comply with §63.119(e) of this subpart by using a closed vent system and a control device other than a flare shall submit, as part of the Monitoring Plan, the information specified in §63.120(d)(2)(i) of this subpart and the information specified in either §63.120(d)(2)(ii) of this subpart or §63.120(d)(2)(iii) of this subpart.

(c) An owner or operator who elects to comply with §63.119(e) of this subpart by using a closed vent system and a control device shall submit, as part of the Notification of Compliance Status required by §63.152(b) of this subpart, the information specified in either paragraph (c)(1) or (c)(2) of this section. An owner or operator who elects to comply with §63.119(f) of this subpart by routing emissions to a process or to a fuel gas system shall submit, as part of the Notification of Compliance Status required by §63.152(b) of this subpart, the information specified in paragraph (c)(3) of this section.

(1) If a control device other than a flare is used, the owner or operator shall submit the information specified in §63.120(d)(3)(i) and, if applicable, (d)(3)(ii) of this subpart.

(2) If a flare is used, the owner or operator shall submit the information specified in §63.120(e)(2)(i), (e)(2)(ii), and (e)(2)(iii) of this subpart.

(3) If emissions are routed to a process, the owner or operator shall submit the information specified in §63.120(f). If emissions are routed to a fuel gas system, the owner or operator shall submit a statement that the emission stream is connected to the fuel gas system and whether the conveyance system is subject to the requirements of §63.148.

(d) An owner or operator who elects to comply with §63.119(b) of this subpart by using a fixed roof and an internal floating roof or with §63.119(d) of this subpart by using an external floating roof converted

to an internal floating roof shall submit, as part of the Periodic Report required under §63.152(c) of this subpart, the results of each inspection conducted in accordance with §63.120(a) of this subpart in which a failure is detected in the control equipment.

(1) For vessels for which annual inspections are required under §63.120 (a)(2)(i) or (a)(3)(ii) of this subpart, the specifications and requirements listed in paragraphs (d)(1)(i) through (d)(1)(iii) of this section apply.

(i) A failure is defined as any time in which the internal floating roof is not resting on the surface of the liquid inside the storage vessel and is not resting on the leg supports; or there is liquid on the floating roof; or the seal is detached from the internal floating roof; or there are holes, tears, or other openings in the seal or seal fabric; or there are visible gaps between the seal and the wall of the storage vessel.

(ii) Except as provided in paragraph (d)(1)(iii) of this section, each Periodic Report shall include the date of the inspection, identification of each storage vessel in which a failure was detected, and a description of the failure. The Periodic Report shall also describe the nature of and date the repair was made or the date the storage vessel was emptied.

(iii) If an extension is utilized in accordance with §63.120(a)(4) of this subpart, the owner or operator shall, in the next Periodic Report, identify the vessel; include the documentation specified in §63.120(a)(4) of this subpart; and describe the date the storage vessel was emptied and the nature of and date the repair was made.

(2) For vessels for which inspections are required under §63.120 (a)(2)(ii), (a)(3)(i), or (a)(3)(iii) of this subpart, the specifications and requirements listed in paragraphs (d)(2)(i) and (d)(2)(ii) of this section apply.

(i) A failure is defined as any time in which the internal floating roof has defects; or the primary seal has holes, tears, or other openings in the seal or the seal fabric; or the secondary seal (if one has been installed) has holes, tears, or other openings in the seal or the seal fabric; or the gaskets no longer close off the liquid surface from the atmosphere; or the slotted membrane has more than 10 percent open area.

(ii) Each Periodic Report required under §63.152(c) of this subpart shall include the date of the inspection, identification of each storage vessel in which a failure was detected, and a description of the failure. The Periodic Report shall also describe the nature of and date the repair was made.

(e) An owner or operator who elects to comply with §63.119(c) of this subpart by using an external floating roof shall meet the periodic reporting requirements specified in paragraphs (e)(1), (e)(2), and (e)(3) of this section.

(1) The owner or operator shall submit, as part of the Periodic Report required under §63.152(c) of this subpart, documentation of the results of each seal gap measurement made in accordance with §63.120(b) of this subpart in which the requirements of §63.120 (b)(3), (b)(4), (b)(5), or (b)(6) of this subpart are not met. This documentation shall include the information specified in paragraphs (e)(1)(i) through (e)(1)(iv) of this section.

(i) The date of the seal gap measurement.

(ii) The raw data obtained in the seal gap measurement and the calculations described in §63.120 (b)(3) and (b)(4) of this subpart.

(iii) A description of any condition specified in §63.120 (b)(5) or (b)(6) of this subpart that is not met.

(iv) A description of the nature of and date the repair was made, or the date the storage vessel was emptied.

(2) If an extension is utilized in accordance with §63.120(b)(7)(ii) or (b)(8) of this subpart, the owner or operator shall, in the next Periodic Report, identify the vessel; include the documentation specified in §63.120(b)(7)(ii) or (b)(8) of this subpart, as applicable; and describe the date the vessel was emptied and the nature of and date the repair was made.

(3) The owner or operator shall submit, as part of the Periodic Report required under §63.152(c) of this subpart, documentation of any failures that are identified during visual inspections required by §63.120(b)(10) of this subpart. This documentation shall meet the specifications and requirements in paragraphs (e)(3)(i) and (e)(3)(ii) of this section.

(i) A failure is defined as any time in which the external floating roof has defects; or the primary seal has holes, or other openings in the seal or the seal fabric; or the secondary seal has holes, tears, or other openings in the seal or the seal fabric; or the gaskets no longer close off the liquid surface from the atmosphere; or the slotted membrane has more than 10 percent open area.

(ii) Each Periodic Report required under §63.152(c) of this subpart shall include the date of the inspection, identification of each storage vessel in which a failure was detected, and a description of the failure. The periodic report shall also describe the nature of and date the repair was made.

(f) An owner or operator who elects to comply with §63.119(d) of this subpart by using an external floating roof converted to an internal floating roof shall comply with the periodic reporting requirements of paragraph (d) of this section.

(g) An owner or operator who elects to comply with §63.119(e) of this subpart by installing a closed vent system and control device shall submit, as part of the next Periodic Report required by §63.152(c) of this subpart, the information specified in paragraphs (g)(1) through (g)(3) of this section.

(1) As required by §63.120(d)(4) and §63.120(e)(3) of this subpart, the Periodic Report shall include the information specified in paragraphs (g)(1)(i) and (g)(1)(ii) of this section for those planned routine maintenance operations that would require the control device not to meet the requirements of §63.119 (e)(1) or (e)(2) of this subpart, as applicable.

(i) A description of the planned routine maintenance that is anticipated to be performed for the control device during the next 6 months. This description shall include the type of maintenance necessary, planned frequency of maintenance, and lengths of maintenance periods.

(ii) A description of the planned routine maintenance that was performed for the control device during the previous 6 months. This description shall include the type of maintenance performed and the total number of hours during those 6 months that the control device did not meet the requirements of §63.119 (e)(1) or (e)(2) of this subpart, as applicable, due to planned routine maintenance.

(2) If a control device other than a flare is used, the Periodic Report shall describe each occurrence when the monitored parameters were outside of the parameter ranges documented in the Notification of Compliance Status in accordance with §63.120(d)(3)(i) of this subpart. The description shall include the information specified in paragraphs (g)(2)(i) and (g)(2)(ii) of this section.

(i) Identification of the control device for which the measured parameters were outside of the established ranges, and

(ii) Cause for the measured parameters to be outside of the established ranges.

(3) If a flare is used, the Periodic Report shall describe each occurrence when the flare does not meet the general control device requirements specified in §63.11(b) of subpart A of this part and shall include the information specified in paragraphs (g)(3)(i) and (g)(3)(ii) of this section.

(i) Identification of the flare which does not meet the general requirements specified in §63.11(b) of subpart A of this part, and

(ii) Reason the flare did not meet the general requirements specified in §63.11(b) of subpart A of this part.

(h) An owner or operator who elects to comply with §63.119 (b), (c), or (d) of this subpart shall submit, as applicable, the reports specified in paragraphs (h)(1) and (h)(2) of this section.

(1) In order to afford the Administrator the opportunity to have an observer present, the owner or operator shall notify the Administrator of the refilling of a storage vessel that has been emptied and degassed.

(i) If the storage vessel is equipped with an internal floating roof as specified in §63.119(b) of this subpart, the notification shall meet the requirements of either §63.120 (a)(5) or (a)(6) of this subpart, as applicable.

(ii) If the storage vessel is equipped with an external floating roof as specified in §63.119(c) of this subpart, the notification shall meet the requirements of either §63.120 (b)(10)(ii) or (b)(10)(iii) of this subpart, as applicable.

(iii) If the storage vessel is equipped with an external floating roof converted into an internal floating roof as specified in §63.119(d) of this subpart, the notification shall meet the requirements of either §63.120 (a)(5) or (a)(6) of this subpart, as applicable.

(2) In order to afford the Administrator the opportunity to have an observer present, the owner or operator of a storage vessel equipped with an external floating roof as specified in §63.119(c) of this subpart shall notify the Administrator of any seal gap measurements. This notification shall meet the requirements of §63.120(b)(9) of this subpart.

[59 FR 19468, Apr. 22, 1996, as amended at 61 FR 64576, Dec. 5, 1996; 62 FR 2748, Jan. 17, 1997]

### **§63.123 Storage vessel provisions—recordkeeping.**

(a) Each owner or operator of a Group 1 or Group 2 storage vessel shall keep readily accessible records showing the dimensions of the storage vessel and an analysis showing the capacity of the storage vessel. This record shall be kept as long as the storage vessel retains Group 1 or Group 2 status and is in operation. For each Group 2 storage vessel, the owner or operator is not required to comply with any other provisions of §§63.119 through 63.123 of this subpart other than those required by this paragraph unless such vessel is part of an emissions average as described in §63.150 of this subpart.

(b) [Reserved]

(c) An owner or operator who elects to comply with §63.119(b) of this subpart shall keep a record that each inspection required by §63.120(a) of this subpart was performed.

(d) An owner or operator who elects to comply with §63.119(c) of this subpart shall keep records describing the results of each seal gap measurement made in accordance with §63.120(b) of this subpart.

The records shall include the date of the measurement, the raw data obtained in the measurement, and the calculations described in §63.120(b) (3) and (4) of this subpart.

(e) An owner or operator who elects to comply with §63.119(d) of this subpart shall keep a record that each inspection required by §63.120 (a) and (c) of this subpart was performed.

(f) An owner or operator who elects to comply with §63.119(e) of this subpart shall keep in a readily accessible location the records specified in paragraphs (f)(1) and (f)(2) of this section.

(1) A record of the measured values of the parameters monitored in accordance with §63.120(d)(5) of this subpart.

(2) A record of the planned routine maintenance performed on the control device including the duration of each time the control device does not meet the specifications of §63.119 (e)(1) or (e)(2) of this subpart, as applicable, due to the planned routine maintenance. Such a record shall include the information specified in paragraphs (f)(2)(i) and (f)(2)(ii) of this section.

(i) The first time of day and date the requirements of §63.119 (e)(1) or (e)(2) of this subpart, as applicable, were not met at the beginning of the planned routine maintenance, and

(ii) The first time of day and date the requirements of §63.119 (e)(1) or (e)(2) of this subpart, as applicable, were met at the conclusion of the planned routine maintenance.

(g) An owner or operator who elects to utilize an extension in emptying a storage vessel in accordance with §63.120 (a)(4), (b)(7)(ii), or (b)(8) of this subpart shall keep in a readily accessible location, the documentation specified in §63.120 (a)(4), (b)(7)(ii), or (b)(8), as applicable.

(h) An owner or operator who uses the by-pass provisions of §63.119(f)(3) of this subpart shall keep in a readily accessible location the records specified in paragraphs (h)(1) through (h)(3) of this section.

(1) The reason it was necessary to by-pass the process equipment or fuel gas system;

(2) The duration of the period when the process equipment or fuel gas system was by-passed;

(3) Documentation or certification of compliance with the applicable provisions of §63.119(f)(3)(i) through §63.119(f)(3)(iii).

(i) An owner or operator who elects to comply with §63.119(g) shall keep the records specified in paragraphs (i)(1) through (3) of this section.

(1) A record of the U.S. Department of Transportation certification required by §63.119(g)(2).

(2) A record of the pressure relief vent setting specified in §63.119(g)(5).

(3) If complying with §63.119(g)(6)(ii), keep the records specified in paragraphs (i)(3)(i) and (ii) of this section.

(i) A record of the equipment to be used and the procedures to be followed when reloading the railcar, tank truck, or barge and displacing vapors to the storage tank from which the liquid originates.

(ii) A record of each time the vapor balancing system is used to comply with §63.119(g)(6)(ii).

[59 FR 19468, Apr. 22, 1996, as amended at 61 FR 64576, Dec. 5, 1996; 62 FR 2748, Jan. 17, 1997; 69 FR 76863, Dec. 23, 2004]

**§§63.124-63.125 [Reserved]**

**§63.126 Transfer operations provisions—reference control technology.**

(a) For each Group 1 transfer rack the owner or operator shall equip each transfer rack with a vapor collection system and control device.

(1) Each vapor collection system shall be designed and operated to collect the organic hazardous air pollutants vapors displaced from tank trucks or railcars during loading, and to route the collected hazardous air pollutants vapors to a process, or to a fuel gas system, or to a control device as provided in paragraph (b) of this section.

(2) Each vapor collection system shall be designed and operated such that organic HAP vapors collected at one loading arm will not pass through another loading arm in the rack to the atmosphere.

(3) Whenever organic hazardous air pollutants emissions are vented to a process, fuel gas system, or control device used to comply with the provisions of this subpart, the process, fuel gas system, or control device shall be operating.

(b) For each Group 1 transfer rack the owner or operator shall comply with paragraph (b)(1), (b)(2), (b)(3), or (b)(4) of this section.

(1) Use a control device to reduce emissions of total organic hazardous air pollutants by 98 weight-percent or to an exit concentration of 20 parts per million by volume, whichever is less stringent. For combustion devices, the emission reduction or concentration shall be calculated on a dry basis, corrected to 3-percent oxygen. If a boiler or process heater is used to comply with the percent reduction requirement, then the vent stream shall be introduced into the flame zone of such a device. Compliance may be achieved by using any combination of combustion, recovery, and/or recapture devices.

(2) Reduce emissions of organic HAP's using a flare.

(i) The flare shall comply with the requirements of §63.11(b) of subpart A of this part.

(ii) Halogenated vent streams, as defined in §63.111 of this subpart, shall not be vented to a flare.

(3) Reduce emissions of organic hazardous air pollutants using a vapor balancing system designed and operated to collect organic hazardous air pollutants vapors displaced from tank trucks or railcars during loading; and to route the collected hazardous air pollutants vapors to the storage vessel from which the liquid being loaded originated, or to another storage vessel connected to a common header, or to compress and route to a process collected hazardous air pollutants vapors.

(4) Route emissions of organic hazardous air pollutants to a fuel gas system or to a process where the organic hazardous air pollutants in the emissions shall predominantly meet one of, or a combination of, the ends specified in paragraphs (b)(4)(i) through (b)(4)(iv) of this section.

(i) Recycled and/or consumed in the same manner as a material that fulfills the same function in that process;

(ii) Transformed by chemical reaction into materials that are not organic hazardous air pollutants;



(iii) Incorporated into a product; and/or

(iv) Recovered.

(c) For each Group 2 transfer rack, the owner or operator shall maintain records as required in §63.130(f). No other provisions for transfer racks apply to the Group 2 transfer rack.

(d) Halogenated emission streams from Group 1 transfer racks that are combusted shall be controlled according to paragraph (d)(1) or (d)(2) of this section. Determination of whether a vent stream is halogenated shall be made using procedures in (d)(3).

(1) If a combustion device is used to comply with paragraph (b)(1) of this section for a halogenated vent stream, then the vent stream exiting the combustion device shall be ducted to a halogen reduction device, including, but not limited to, a scrubber before it is discharged to the atmosphere.

(i) Except as provided in paragraph (d)(1)(ii) of this section, the halogen reduction device shall reduce overall emissions of hydrogen halides and halogens, as defined in §63.111 of this subpart, by 99 percent or shall reduce the outlet mass emission rate of total hydrogen halides and halogens to 0.45 kilograms per hour or less, whichever is less stringent.

(ii) If a scrubber or other halogen reduction device was installed prior to December 31, 1992, the halogen reduction device shall reduce overall emissions of hydrogen halides and halogens, as defined in §63.111 of this subpart, by 95 percent or shall reduce the outlet mass of total hydrogen halides and halogens to less than 0.45 kilograms per hour, whichever is less stringent.

(2) A halogen reduction device, such as a scrubber, or other technique may be used to make the vent stream non-halogenated by reducing the vent stream halogen atom mass emission rate to less than 0.45 kilograms per hour prior to any combustion control device used to comply with the requirements of paragraphs (b)(1) or (b)(2) of this section.

(3) In order to determine whether a vent stream is halogenated, the mass emission rate of halogen atoms contained in organic compounds shall be calculated.

(i) The vent stream concentration of each organic compound containing halogen atoms (parts per million by volume by compound) shall be determined based on the following procedures:

(A) Process knowledge that no halogen or hydrogen halides are present in the process, or

(B) Applicable engineering assessment as specified in §63.115(d)(1)(iii) of this subpart, or

(C) Concentration of organic compounds containing halogens measured by Method 18 of 40 CFR part 60, appendix A, or

(D) Any other method or data that has been validated according to the applicable procedures in Method 301 of appendix A of this part.

(ii) The following equation shall be used to calculate the mass emission rate of halogen atoms:

$$E = K_2 V_s \left( \sum_{j=1}^n \sum_{i=1}^m C_j * L_{ji} * M_{ji} \right)$$

where:

E = Mass of halogen atoms, dry basis, kilograms per hour.

$K_2$  = Constant,  $2.494 \times 10^{-6}$  (parts per million)<sup>-1</sup> (kilogram-mole per standard cubic meter) (minute/hour), where standard temperature is 20 °C.

$C_j$  = Concentration of halogenated compound j in the gas stream, dry basis, parts per million by volume.

$M_{ji}$  = Molecular weight of halogen atom i in compound j of the gas stream, kilogram per kilogram-mole.

$L_{ji}$  = Number of atoms of halogen i in compound j of the gas stream.

$V_s$  = Flow rate of gas stream, dry standard cubic meters per minute, determined according to §63.128(a)(8) of this subpart.

j = Halogenated compound j in the gas stream.

i = Halogen atom i in compound j of the gas stream.

n = Number of halogenated compounds j in the gas stream.

m = Number of different halogens i in each compound j of the gas stream.

(e) For each Group 1 transfer rack the owner or operator shall load organic HAP's into only tank trucks and railcars which:

(1) Have a current certification in accordance with the U. S. Department of Transportation pressure test requirements of 49 CFR part 180 for tank trucks and 49 CFR 173.31 for railcars; or

(2) Have been demonstrated to be vapor-tight within the preceding 12 months, as determined by the procedures in §63.128(f) of this subpart. Vapor-tight means that the truck or railcar tank will sustain a pressure change of not more than 750 pascals within 5 minutes after it is pressurized to a minimum of 4,500 pascals.

(f) The owner or operator of a transfer rack subject to the provisions of this subpart shall load organic HAP's to only tank trucks or railcars equipped with vapor collection equipment that is compatible with the transfer rack's vapor collection system.

(g) The owner or operator of a transfer rack subject to this subpart shall load organic HAP's to only tank trucks or railcars whose collection systems are connected to the transfer rack's vapor collection systems.

(h) The owner or operator of a transfer rack subject to the provisions of this subpart shall ensure that no pressure-relief device in the transfer rack's vapor collection system or in the organic hazardous air pollutants loading equipment of each tank truck or railcar shall begin to open during loading. Pressure relief devices needed for safety purposes are not subject to this paragraph.

(i) Each valve in the vent system that would divert the vent stream to the atmosphere, either directly or indirectly, shall be secured in a non-diverting position using a carseal or a lock-and-key type configuration, or shall be equipped with a flow indicator. Equipment such as low leg drains, high point bleeds, analyzer vents, open-ended valves or lines, and pressure relief devices needed for safety purposes is not subject to this paragraph.

[59 FR 19468, Apr. 22, 1994, as amended at 62 FR 2749, Jan. 17, 1997]

**§63.127 Transfer operations provisions—monitoring requirements.**

(a) Each owner or operator of a Group 1 transfer rack equipped with a combustion device used to comply with the 98 percent total organic hazardous air pollutants reduction or 20 parts per million by volume outlet concentration requirements in §63.126(b)(1) of this subpart shall install, calibrate, maintain, and operate according to the manufacturers' specifications (or other written procedures that provide adequate assurance that the equipment would reasonably be expected to monitor accurately) the monitoring equipment specified in paragraph (a)(1), (a)(2), (a)(3), or (a)(4) of this section, as appropriate.

(1) Where an incinerator is used, a temperature monitoring device equipped with a continuous recorder is required.

(i) Where an incinerator other than a catalytic incinerator is used, a temperature monitoring device shall be installed in the firebox or in the ductwork immediately downstream of the firebox in a position before any substantial heat exchange occurs.

(ii) Where a catalytic incinerator is used, temperature monitoring devices shall be installed in the gas stream immediately before and after the catalyst bed.

(2) Where a flare is used, a device (including but not limited to a thermocouple, infrared sensor, or an ultra-violet beam sensor) capable of continuously detecting the presence of a pilot flame is required.

(3) Where a boiler or process heater with a design heat input capacity less than 44 megawatts is used, a temperature monitoring device in the firebox equipped with a continuous recorder is required. Any boiler or process heater in which all vent streams are introduced with the primary fuel or are used as the primary fuel is exempt from this requirement.

(4) Where a scrubber is used with an incinerator, boiler, or process heater in the case of halogenated vent streams, the following monitoring equipment is required for the scrubber:

(i) A pH monitoring device equipped with a continuous recorder shall be installed to monitor the pH of the scrubber effluent.

(ii) A flow meter equipped with a continuous recorder shall be located at the scrubber influent for liquid flow. Gas stream flow shall be determined using one of the procedures specified in paragraphs (a)(4)(ii)(A) through (a)(4)(ii)(C) of this section.

(A) The owner or operator may determine gas stream flow using the design blower capacity, with appropriate adjustments for pressure drop.

(B) If the scrubber is subject to regulations in 40 CFR parts 264 through 266 that have required a determination of the liquid to gas (L/G) ratio prior to the applicable compliance date for this subpart specified in §63.100(k) of subpart F of this part, the owner or operator may determine gas stream flow by the method that had been utilized to comply with those regulations. A determination that was conducted prior to the compliance date for this subpart may be utilized to comply with this subpart if it is still representative.

(C) The owner or operator may prepare and implement a gas stream flow determination plan that documents an appropriate method which will be used to determine the gas stream flow. The plan shall require determination of gas stream flow by a method which will at least provide a value for either a representative or the highest gas stream flow anticipated in the scrubber during representative operating conditions other than start-ups, shutdowns, or malfunctions. The plan shall include a description of the methodology to be followed and an explanation of how the selected methodology will reliably determine the gas stream flow, and a description of the records that will be maintained to document the

determination of gas stream flow. The owner or operator shall maintain the plan as specified in §63.103(c).

(b) Each owner or operator of a Group 1 transfer rack that uses a recovery device or recapture device to comply with the 98-percent organic hazardous air pollutants reduction or 20 parts per million by volume hazardous air pollutants concentration requirements in §63.126(b)(1) of this subpart shall install either an organic monitoring device equipped with a continuous recorder, or the monitoring equipment specified in paragraph (b)(1), (b)(2), or (b)(3) of this section, depending on the type of recovery device or recapture device used. All monitoring equipment shall be installed, calibrated, and maintained according to the manufacturer's specifications or other written procedures that provide adequate assurance that the equipment would reasonably be expected to monitor accurately.

(1) Where an absorber is used, a scrubbing liquid temperature monitoring device equipped with a continuous recorder shall be used; and a specific gravity monitoring device equipped with a continuous recorder shall be used.

(2) Where a condenser is used, a condenser exit (product side) temperature monitoring device equipped with a continuous recorder shall be used.

(3) Where a carbon adsorber is used, an integrating regeneration stream flow monitoring device having an accuracy of  $\pm 10$  percent or better, capable of recording the total regeneration stream mass flow for each regeneration cycle; and a carbon bed temperature monitoring device, capable of recording the temperature of the carbon bed after regeneration and within 15 minutes of completing any cooling cycle shall be used.

(c) An owner or operator of a Group 1 transfer rack may request approval to monitor parameters other than those listed in paragraph (a) or (b) of this section. The request shall be submitted according to the procedures specified in §63.151(f) or §63.152(e) of this subpart. Approval shall be requested if the owner or operator:

(1) Seeks to demonstrate compliance with the standards specified in §63.126(b) of this subpart with a control device other than an incinerator, boiler, process heater, flare, absorber, condenser, or carbon adsorber; or

(2) Uses one of the control devices listed in paragraphs (a) and (b) of this section, but seeks to monitor a parameter other than those specified in paragraphs (a) and (b) of this subpart.

(d) The owner or operator of a Group 1 transfer rack using a vent system that contains by-pass lines that could divert a vent stream flow away from the control device used to comply with §63.126(b) of this subpart shall comply with paragraph (d)(1) or (d)(2) of this section. Equipment such as low leg drains, high point bleeds, analyzer vents, open-ended valves or lines, and pressure relief valves needed for safety purposes are not subject to this paragraph.

(1) Properly install, maintain, and operate a flow indicator that takes a reading at least once every 15 minutes. Records shall be generated as specified in §63.130(b) of this subpart. The flow indicator shall be installed at the entrance to any by-pass line that could divert the vent stream away from the control device to the atmosphere; or

(2) Secure the by-pass line valve in the closed position with a car-seal or a lock-and-key type configuration.

(i) A visual inspection of the seal or closure mechanism shall be performed at least once every month to ensure that the valve is maintained in the closed position and the vent stream is not diverted through the by-pass line.

(ii) If a car-seal has been broken or a valve position changed, the owner or operator shall record that the vent stream has been diverted. The car-seal or lock-and-key combination shall be returned to the secured position as soon as practicable but not later than 15 calendar days after the change in position is detected.

(e) The owner or operator shall establish a range that indicates proper operation of the control device for each parameter monitored under paragraphs (a), (b), and (c) of this section. In order to establish the range, the information required in §63.152(b)(2) of this subpart shall be submitted in the Notification of Compliance Status or the operating permit application or amendment.

[59 FR 19468, Apr. 22, 1994, as amended at 62 FR 2749, Jan. 17, 1997]

### **§63.128 Transfer operations provisions—test methods and procedures.**

(a) A performance test is required for determining compliance with the reduction of total organic HAP emissions in §63.126(b) of this subpart for all control devices except as specified in paragraph (c) of this section. Performance test procedures are as follows:

(1) For control devices shared between transfer racks and process vents, the performance test procedures in §63.116(c) of this subpart shall be followed.

(2) A performance test shall consist of three runs.

(3) All testing equipment shall be prepared and installed as specified in the appropriate test methods.

(4) For control devices shared between multiple arms that load simultaneously, the minimum sampling time for each run shall be 1 hour in which either an integrated sample or a minimum of four grab samples shall be taken. If grab sampling is used, then the samples shall be taken at approximately equal intervals in time, such as 15-minute intervals during the run.

(5) For control devices that are capable of continuous vapor processing but do not meet the conditions in (a)(7)(i)(B) of this section.

(A) Sampling sites shall be located at the inlet and outlet of the control device, except as provided in paragraph (a)(7)(i)(B) of this section.

(B) If a vent stream is introduced with the combustion air or as a secondary fuel into a boiler or process heater with a design capacity less than 44 megawatts, selection of paragraph (a)(1) or (a)(4) of this section, each run shall represent at least one complete filling period, during which liquid organic HAP's are loaded, and samples shall be collected using integrated sampling or grab samples taken at least four times per hour at approximately equal intervals of time, such as 15-minute intervals.

(6) For intermittent vapor processing systems that do not meet the conditions in paragraph (a)(1) or (a)(4) of this section, each run shall represent at least one complete control device cycle, and samples shall be collected using integrated sampling or grab samples taken at least four times per hour at approximately equal intervals of time, such as 15-minute intervals.

(7) Method 1 or 1A of 40 CFR part 60, appendix A, as appropriate, shall be used for selection of sampling sites.

(i) For an owner or operator complying with the 98-percent total organic HAP reduction requirements in §63.126(b)(1) of this subpart, sampling sites shall be located as specified in paragraph (a)(7)(i)(A) or (a)(7)(i)(B) of this section.

(A) Sampling sites shall be located at the inlet and outlet of the control device, except as provided in paragraph (a)(7)(i)(B) of this section.

(B) If a vent stream is introduced with the combustion air or as a secondary fuel into a boiler or process heater with a design capacity less than 44 megawatts, selection of the location of the inlet sampling sites shall ensure the measurement of total organic HAP or TOC (minus methane and ethane) concentrations in all vent streams and primary and secondary fuels introduced into the boiler or process heater. A sampling site shall also be located at the outlet of the boiler or process heater.

(ii) For an owner or operator complying with the 20 parts per million by volume limit in §63.126(b)(1) of this subpart, the sampling site shall be located at the outlet of the control device.

(8) The volumetric flow rate, in standard cubic meters per minute at 20 °C, shall be determined using Method 2, 2A, 2C, or 2D of 40 CFR part 60, appendix A as appropriate.

(9) For the purpose of determining compliance with the 20 parts per million by volume limit in §63.126(b)(1), Method 18 or Method 25A of 40 CFR part 60, appendix A shall be used to measure either organic compound concentration or organic HAP concentration, except as provided in paragraph (a)(11) of this section.

(i) If Method 25A of 40 CFR part 60, appendix A is used, the following procedures shall be used to calculate the concentration of organic compounds ( $C_T$ ):

(A) The principal organic HAP in the vent stream shall be used as the calibration gas.

(B) The span value for Method 25A of 40 CFR part 60, appendix A shall be between 1.5 and 2.5 times the concentration being measured.

(C) Use of Method 25A of 40 CFR part 60, appendix A is acceptable if the response from the high-level calibration gas is at least 20 times the standard deviation of the response from the zero calibration gas when the instrument is zeroed on the most sensitive scale.

(D) The concentration of TOC shall be corrected to 3 percent oxygen using the procedures and equation in paragraph (a)(9)(v) of this section.

(ii) If Method 18 of 40 CFR part 60, appendix A is used to measure the concentration of organic compounds, the organic compound concentration ( $C_T$ ) is the sum of the individual components and shall be computed for each run using the following equation:

$$C_T = \sum_{j=1}^n C_j$$

where:

$C_T$  = Total concentration of organic compounds (minus methane and ethane), dry basis, parts per million by volume.

$C_j$  = Concentration of sample components  $j$ , dry basis, parts per million by volume.

$n$  = Number of components in the sample.

(iii) If an owner or operator uses Method 18 of 40 CFR part 60, appendix A to compute total organic HAP concentration rather than organic compounds concentration, the equation in paragraph (a)(9)(ii) of this section shall be used except that only organic HAP species shall be summed. The list of organic HAP's is provided in table 2 of subpart F of this part.

(iv) The emission rate correction factor or excess air, integrated sampling and analysis procedures of Method 3B of 40 CFR part 60, appendix A shall be used to determine the oxygen concentration. The sampling site shall be the same as that of the organic hazardous air pollutants or organic compound samples, and the samples shall be taken during the same time that the organic hazardous air pollutants or organic compound samples are taken.

(v) The organic compound concentration corrected to 3 percent oxygen ( $C_c$ ) shall be calculated using the following equation:

$$C_c = C_T \left( \frac{17.9}{20.9 - \%O_{2d}} \right)$$

where:

$C_c$  = Concentration of organic compounds corrected to 3 percent oxygen, dry basis, parts per million by volume.

$C_T$  = Total concentration of organic compounds, dry basis, parts per million by volume.

$\%O_{2d}$  = Concentration of oxygen, dry basis, percent by volume.

(10) For the purpose of determining compliance with the 98-percent reduction requirement in §63.126(b)(1) of this subpart, Method 18 or Method 25A of 40 CFR part 60, appendix A shall be used, except as provided in paragraph (a)(11) of this section.

(i) For the purpose of determining compliance with the reduction efficiency requirement, organic compound concentration may be measured in lieu of organic HAP concentration.

(ii) If Method 25A of 40 CFR part 60, appendix A is used to measure the concentration of organic compounds ( $C_T$ ), the principal organic HAP in the vent stream shall be used as the calibration gas.

(A) An emission testing interval shall consist of each 15-minute period during the performance test. For each interval, a reading from each measurement shall be recorded.

(B) The average organic compound concentration and the volume measurement shall correspond to the same emissions testing interval.

(C) The mass at the inlet and outlet of the control device during each testing interval shall be calculated as follows:

$$M_j = FKV_s C_T$$

where:

$M_j$  = Mass of organic compounds emitted during testing interval  $j$ , kilograms.

$V_s$  = Volume of air-vapor mixture exhausted at standard conditions, 20 °C and 760 millimeters mercury, standard cubic meters.

$C_T$  = Total concentration of organic compounds (as measured) at the exhaust vent, parts per million by volume, dry basis.

$K$  = Density, kilograms per standard cubic meter organic HAP. 659 kilograms per standard cubic meter organic HAP.  
(Note: The density term cancels out when the percent reduction is calculated. Therefore, the density used has no effect. The density of hexane is given so that it can be used to maintain the units of  $M_{ij}$ .)

$F = 10^{-6}$  = Conversion factor, (cubic meters organic HAP per cubic meters air) \* (parts per million by volume)<sup>-1</sup>.

(D) The organic compound mass emission rates at the inlet and outlet of the control device shall be calculated as follows:

$$E_i = \frac{\sum_{j=1}^n M_{ij}}{T}$$

$$E_o = \frac{\sum_{j=1}^n M_{oj}}{T}$$

where:

$E_i, E_o$  = Mass flow rate of organic compounds at the inlet (i) and outlet (o) of the combustion or recovery device, kilograms per hour.

$M_{ij}, M_{oj}$  = Mass of organic compounds at the inlet (i) or outlet (o) during testing interval j, kilograms.

$T$  = Total time of all testing intervals, hours.

$n$  = Number of testing intervals.

(iii) If Method 18 of 40 CFR part 60, appendix A is used to measure organic compounds, the mass rates of organic compounds ( $E_i, E_o$ ) shall be computed using the following equations:

$$E_i = K_2 \left( \sum_{j=1}^n C_{ij} MW_{ij} \right) Q_i$$

$$E_o = K_2 \left( \sum_{j=1}^n C_{oj} MW_{oj} \right) Q_o$$

where:

$C_{ij}, C_{oj}$  = Concentration of sample component j of the gas stream at the inlet and outlet of the control device, respectively, dry basis, parts per million by volume.

$MW_{ij}, MW_{oj}$  = Molecular weight of sample component j of the gas stream at the inlet and outlet of the control device, respectively, gram/gram-mole.



$Q_i, Q_o$  = Flow rate of gas stream at the inlet and outlet of the control device, respectively, dry standard cubic meter per minute.

$K_2$  = Constant,  $2.494 \times 10^{-6}$  (parts per million)<sup>-1</sup> (gram-mole per standard cubic meter) (kilogram/gram) (minute/hour), where standard temperature for (gram-mole per standard cubic meter) is 20 °C.

(iv) Where Method 18 or 25A of 40 CFR part 60, appendix A is used to measure the percent reduction in organic compounds, the percent reduction across the control device shall be calculated as follows:

$$R = \frac{E_i - E_o}{E_i} (100)$$

where:

R = Control efficiency of control device, percent.

$E_i$  = Mass emitted or mass flow rate of organic compounds at the inlet to the combustion or recovery device as calculated under paragraph (a)(10)(ii)(D) or (a)(10)(iii) of this section, kilogram per hour.

$E_o$  = Mass emitted or mass flow rate of organic compounds at the outlet of the combustion or recovery device, as calculated under paragraph (a)(10)(ii)(D) or (a)(10)(iii) of this section, kilogram per hour.

(11) The owner or operator may use any methods or data other than Method 18 or Method 25A of 40 CFR part 60, appendix A, if the method or data has been validated according to Method 301 of appendix A of this part.

(b) When a flare is used to comply with §63.126(b)(2), the owner or operator shall comply with paragraphs (b)(1) through (3) of this section. The owner or operator is not required to conduct a performance test to determine percent emission reduction or outlet organic HAP or TOC concentration.

(1) Conduct a visible emission test using the techniques specified in §63.11(b)(4). The observation period shall be as specified in paragraph (b)(1)(i) or (ii) of this section instead of the 2-hour period specified in §63.11(b)(4).

(i) If the loading cycle is less than 2 hours, then the observation period for that run shall be for the entire loading cycle.

(ii) If additional loading cycles are initiated within the 2-hour period, then visible emission observations shall be conducted for the additional cycles.

(2) Determine the net heating value of the gas being combusted, using the techniques specified in §63.11(b)(6).

(3) Determine the exit velocity using the techniques specified in either §63.11(b)(7)(i) (and §63.11(b)(7)(iii), where applicable) or §63.11(b)(8), as appropriate.

(c) An owner or operator is not required to conduct a performance test when any of the conditions specified in paragraphs (c)(1) through (c)(7) of this section are met.

(1) When a boiler or process heater with a design heat input capacity of 44 megawatts or greater is used.

(2) When a boiler or process heater burning hazardous waste is used for which the owner or operator:

(i) Has been issued a final permit under 40 CFR part 270 and complies with the requirements of 40 CFR part 266, subpart H, or

(ii) Has certified compliance with the interim status requirements of 40 CFR part 266 subpart H.

(3) When emissions are routed to a fuel gas system or when a boiler or process heater is used and the vent stream is introduced with the primary fuel.

(4) When a vapor balancing system is used.

(5) When emissions are recycled to a chemical manufacturing process unit.

(6) When a transfer rack transfers less than 11.8 million liters per year and the owner or operator complies with the requirements in paragraph (h) of this section or uses a flare to comply with §63.126(b)(2) of this subpart.

(7) When a hazardous waste incinerator is used for which the owner or operator has been issued a final permit under 40 CFR part 270 and complies with the requirements of 40 CFR part 264, subpart O, or has certified compliance with the interim status requirements 40 CFR part 265, subpart O.

(d) An owner or operator using a combustion device followed by a scrubber or other halogen reduction device to control a halogenated transfer vent stream in compliance with §63.126(d) of this subpart shall conduct a performance test to determine compliance with the control efficiency or emission limits for hydrogen halides and halogens.

(1) For an owner or operator determining compliance with the percent reduction of total hydrogen halides and halogens, sampling sites shall be located at the inlet and outlet of the scrubber or other halogen reduction device used to reduce halogen emissions. For an owner or operator complying with the 0.45 kilogram per hour outlet mass emission rate limit for total hydrogen halides and halogens, the sampling site shall be located at the outlet of the scrubber or other halogen reduction device and prior to release to the atmosphere.

(2) Except as provided in paragraph (d)(5) of this section, Method 26 or 26A of 40 CFR part 60, appendix A, shall be used to determine the concentration in milligrams per dry standard cubic meter of the hydrogen halides and halogens that may be present in the stream. The mass emission rate of each hydrogen halide and halogen compound shall be calculated from the concentrations and the gas stream flow rate.

(3) To determine compliance with the percent emissions reduction limit, the mass emission rate for any hydrogen halides and halogens present at the scrubber inlet shall be summed together. The mass emission rate of the compounds present at the scrubber outlet shall be summed together. Percent reduction shall be determined by comparison of the summed inlet and outlet measurements.

(4) To demonstrate compliance with the 0.45 kilograms per hour mass emission rate limit, the test results must show that the mass emission rate of the total hydrogen halides and halogens measured at the scrubber outlet is below 0.45 kilograms per hour.

(5) The owner or operator may use any other method or data to demonstrate compliance if the method or data has been validated according to the protocol of Method 301 of appendix A of this part.

(e) The owner or operator shall inspect the vapor collection system and vapor balancing system, according to the requirements for vapor collection systems in §63.148 of this subpart.

(1) Inspections shall be performed only while a tank truck or railcar is being loaded.

(2) For vapor collection systems only, an inspection shall be performed prior to each performance test required to demonstrate compliance with §63.126(b)(1) of this subpart.

(3) For each vapor collection system that is operated and maintained under negative pressure, the owner or operator is not required to comply with the requirements specified in §63.148 of this subpart.

(f) For the purposes of demonstrating vapor tightness to determine compliance with §63.126(e)(2) of this subpart, the following procedures and equipment shall be used:

(1) The pressure test procedures specified in Method 27 of 40 CFR part 60, appendix A; and

(2) A pressure measurement device which has a precision of #1B2.5 millimeters of mercury or better and which is capable of measuring above the pressure at which the tank truck or railcar is to be tested for vapor tightness.

(g) An owner or operator using a scrubber or other halogen reduction device to reduce the vent stream halogen atom mass emission rate to less than 0.45 kilograms per hour prior to a combustion device used to comply with §63.126(d)(2) shall determine the halogen atom mass emission rate prior to the combustor according to the procedures in paragraph (d)(3) of this section.

(h) For transfer racks that transfer less than 11.8 million liters per year of liquid organic HAP's, the owner or operator may comply with the requirements in paragraphs (h)(1) through (h)(3) of this section instead of the requirements in paragraph (a) or (b) of this section.

(1) The owner or operator shall prepare, as part of the Notification of Compliance Status required by §63.152(b) of this subpart, a design evaluation that shall document that the control device being used achieves the required control efficiency during reasonably expected maximum loading conditions. This documentation is to include a description of the gas stream which enters the control device, including flow and organic HAP content, and the information specified in paragraphs (h)(1)(i) through (h)(1)(v) of this section, as applicable.

(i) If the control device receives vapors, gases, or liquids, other than fuels, from emission points other than transfer racks subject to this subpart, the efficiency demonstration is to include consideration of all vapors, gases, and liquids, other than fuels, received by the control device.

(ii) If an enclosed combustion device with a minimum residence time of 0.5 seconds and a minimum temperature of 760 degrees Celsius is used to meet the 98-percent emission reduction requirement, documentation that those conditions exist is sufficient to meet the requirements of paragraph (h)(1) of this section.

(iii) Except as provided in paragraph (h)(1)(ii) of this section, for thermal incinerators, the design evaluation shall include the autoignition temperature of the organic HAP, the flow rate of the organic HAP emission stream, the combustion temperature, and the residence time at the combustion temperature.

(iv) For carbon adsorbers, the design evaluation shall include the affinity of the organic HAP vapors for carbon, the amount of carbon in each bed, the number of beds, the humidity of the feed gases, the temperature of the feed gases, the flow rate of the organic HAP emission stream, the desorption

schedule, the regeneration stream pressure or temperature, and the flow rate of the regeneration stream. For vacuum desorption, pressure drop shall be included.

(v) For condensers, the design evaluation shall include the final temperature of the organic HAP vapors, the type of condenser, and the design flow rate of the organic HAP emission stream.

(2) The owner or operator shall submit, as part of the Notification of Compliance Status required by §63.152(b) of this subpart, the operating range for each monitoring parameter identified for each control device. The specified operating range shall represent the conditions for which the control device can achieve the 98-percent-or-greater emission reduction required by §63.126(b)(1) of this subpart.

(3) The owner or operator shall monitor the parameters specified in the Notification of Compliance Status required in §63.152(b) of this subpart or operating permit and shall operate and maintain the control device such that the monitored parameters remain within the ranges specified in the Notification of Compliance Status, except as provided in §§63.152(c) and 63.152(f) of this subpart.

[59 FR 19468, Apr. 22, 1994, as amended at 61 FR 64576, Dec. 5, 1996; 62 FR 2750, Jan. 17, 1997; 66 FR 6932, Jan. 22, 2001]

**§63.129 Transfer operations provisions—reporting and recordkeeping for performance tests and notification of compliance status.**

(a) Each owner or operator of a Group 1 transfer rack shall:

(1) Keep an up-to-date, readily accessible record of the data specified in paragraphs (a)(4) through (a)(8) of this section, as applicable.

(2) Include the data specified in paragraphs (a)(4) through (a)(7) of this section in the Notification of Compliance Status report as specified in §63.152(b) of this subpart.

(3) If any subsequent performance tests are conducted after the Notification of Compliance Status has been submitted, report the data in paragraphs (a)(4) through (a)(7) of this section in the next Periodic Report as specified in §63.152(c) of this subpart.

(4) Record and report the following when using a control device other than a flare to achieve a 98 weight percent reduction in total organic HAP or a total organic HAP concentration of 20 parts per million by volume, as specified in §63.126(b)(1) of this subpart:

(i) The parameter monitoring results for thermal incinerators, catalytic incinerators, boilers or process heaters, absorbers, condensers, or carbon adsorbers specified in table 7 of this subpart, recorded during the performance test, and averaged over the time period of the performance testing.

(ii) The percent reduction of total organic HAP or TOC achieved by the control device determined as specified in §63.128(a) of this subpart, or the concentration of total organic HAP or TOC (parts per million by volume, by compound) determined as specified in §63.128(a) of this subpart at the outlet of the control device. For combustion devices, the concentration shall be reported on a dry basis corrected to 3 percent oxygen.

(iii) The parameters shall be recorded at least every 15 minutes.

(iv) For a boiler or process heater, a description of the location at which the vent stream is introduced into the boiler or process heater.

(5) Record and report the following when using a flare to comply with §63.126(b)(2) of this subpart:

(i) Flare design (i.e., steam-assisted, air-assisted, or non-assisted);

(ii) All visible emission readings, heat content determinations, flow rate measurements, and exit velocity determinations made during the compliance determination required by §63.128(b) of this subpart; and

(iii) All periods during the compliance determination when the pilot flame is absent.

(6) Record and report the following when using a scrubber following a combustion device to control a halogenated vent stream, as specified in §63.126(d) of this subpart:

(i) The percent reduction or scrubber outlet mass emission rate of total hydrogen halides and halogens determined according to the procedures in §63.128(d) of this subpart;

(ii) The parameter monitoring results for scrubbers specified in table 7 of this subpart, and averaged over the time period of the performance test; and

(iii) The parameters shall be recorded at least every 15 minutes.

(7) Record and report the halogen concentration in the vent stream determined according to the procedures as specified in §63.128(d) of this subpart.

(8) Report that the emission stream is being routed to a fuel gas system or a process, when complying using §63.126(b)(4).

(b) If an owner or operator requests approval to use a control device other than those listed in table 7 of this subpart or to monitor a parameter other than those specified in table 7 of this subpart, the owner or operator shall submit a description of planned reporting and recordkeeping procedures as required under §63.151(f) or §63.152(e) of this subpart. The Administrator will specify appropriate reporting and recordkeeping requirements as part of the review of the permit application or by other appropriate means.

(c) For each parameter monitored according to table 7 of this subpart or paragraph (b) of this section, the owner or operator shall establish a range for the parameter that indicates proper operation of the control device. In order to establish the range, the information required in §63.152(b)(2) of this subpart shall be submitted in the Notification of Compliance Status or the operating permit application or amendment.

(d) Each owner or operator shall maintain a record describing in detail the vent system used to vent each affected transfer vent stream to a control device. This document shall list all valves and vent pipes that could vent the stream to the atmosphere, thereby by-passing the control device; identify which valves are secured by car-seals or lock-and-key type configurations; and indicate the position (open or closed) of those valves which have car-seals. Equipment leaks such as low leg drains, high point bleeds, analyzer vents, open-ended valves or lines, and pressure relief valves needed for safety purposes are not subject to this paragraph.

(e) An owner or operator meeting the requirements of §63.128(h) of this subpart shall submit, as part of the Notification of Compliance Status required by §63.152(b) of this subpart, the information specified in §63.128(h)(1) of this subpart.

(f) An owner or operator meeting the requirements of §63.128(h) of this subpart shall submit, as part of the Notification of Compliance Status required by §63.152(b) of this subpart, the operating range for each monitoring parameter identified for each control device.

[59 FR 19468, Apr. 22, 1994, as amended at 61 FR 64576, Dec. 5, 1996; 62 FR 2750, Jan. 17, 1997; 64 FR 20191, Apr. 26, 1999]

**§63.130 Transfer operations provisions—periodic recordkeeping and reporting.**

(a) Each owner or operator using a control device to comply with §63.126(b)(1) or (b)(2) of this subpart shall keep the following up-to-date, readily accessible records:

(1) While the transfer vent stream is being vented to the control device, continuous records of the equipment operating parameters specified to be monitored under §63.127 of this subpart, and listed in table 7 of this subpart or specified by the Administrator in accordance with §§63.127(c) and 63.129(b). For flares, the hourly records and records of pilot flame outages specified in table 7 shall be maintained in place of continuous records.

(2) Records of the daily average value of each monitored parameter for each operating day determined according to the procedures specified in §63.152(f), except as provided in paragraphs (a)(2)(i) through (a)(2)(iii) of this section.

(i) For flares, records of the times and duration of all periods during which the pilot flame is absent shall be kept rather than daily averages.

(ii) If carbon adsorber regeneration stream flow and carbon bed regeneration temperature are monitored, the records specified in table 7 of this subpart shall be kept instead of the daily averages.

(iii) Records of the duration of all periods when the vent stream is diverted through by-pass lines shall be kept rather than daily averages.

(3) For boilers or process heaters, records of any changes in the location at which the vent stream is introduced into the flame zone as required under the reduction of total organic HAP emissions in §63.126(b)(1) of this subpart.

(b) If a vapor collection system containing valves that could divert the emission stream away from the control device is used, each owner or operator of a Group 1 transfer rack subject to the provisions of §63.127(d) of this subpart shall keep up-to-date, readily accessible records of:

(1) Hourly records of whether the flow indicator specified under §63.127(d)(1) was operating and whether a diversion was detected at any time during the hour, as well as records of the times of all periods when the vent stream is diverted from the control device or the flow indicator is not operating.

(2) Where a seal mechanism is used to comply with §63.127(d)(2), hourly records of flow are not required. In such cases, the owner or operator shall record that the monthly visual inspection of the seals or closure mechanisms has been done, and shall record the occurrence of all periods when the seal mechanism is broken, the by-pass line valve position has changed, or the key for a lock-and-key type lock has been checked out, and records of any car-seal that has broken, as listed in table 7 of this subpart.

(c) Each owner or operator of a Group 1 transfer rack who uses a flare to comply with §63.126(b)(2) of this subpart shall keep up-to-date, readily accessible records of the flare pilot flame monitoring specified under §63.127(a)(2) of this subpart.

(d) Each owner or operator of a transfer rack subject to the requirements of §63.126 of this subpart shall submit to the Administrator Periodic Reports of the following information according to the schedule in §63.152(c) of this subpart:

(1) Reports of daily average values of monitored parameters for all operating days when the daily average values were outside the range established in the Notification of Compliance Status or operating permit.

(2) Reports of the duration of periods when monitoring data are not collected for each excursion caused by insufficient monitoring data as defined in §63.152(c)(2)(ii)(A) of this subpart.

(3) Reports of the times and durations of all periods recorded under paragraph (b)(1) of this section when the vent stream was diverted from the control device.

(4) Reports of all times recorded under paragraph (b)(2) of this section when maintenance is performed on car-sealed valves, when the car seal is broken, when the by-pass line valve position is changed, or the key for a lock-and-key type configuration has been checked out.

(5) Reports of the times and durations of all periods recorded under paragraph (a)(2)(i) of this section in which all pilot flames of a flare were absent.

(6) Reports of all carbon bed regeneration cycles during which the parameters recorded under paragraph (a)(2)(vi) of this section were outside the ranges established in the Notification of Compliance Status or operating permit.

(e) The owner or operator of a Group 1 transfer rack shall record that the verification of DOT tank certification or Method 27 testing, required in §63.126(e) of this subpart, has been performed. Various methods for the record of verification can be used, such as: A check off on a log sheet; a list of DOT serial numbers or Method 27 data; or a position description for gate security, showing that the security guard will not allow any trucks on site that do not have the appropriate documentation.

(f) Each owner or operator of a Group 1 or Group 2 transfer rack shall record, update annually, and maintain the information specified in paragraphs (f)(1) through (f)(3) of this section in a readily accessible location on site:

(1) An analysis demonstrating the design and actual annual throughput of the transfer rack;

(2) An analysis documenting the weight-percent organic HAP's in the liquid loaded. Examples of acceptable documentation include but are not limited to analyses of the material and engineering calculations.

(3) An analysis documenting the annual rack weighted average HAP partial pressure of the transfer rack.

(i) For Group 2 transfer racks that are limited to transfer of organic HAP's with partial pressures less than 10.3 kilopascals, documentation is required of the organic HAP's (by compound) that are transferred. The rack weighted average partial pressure does not need to be calculated.

(ii) For racks transferring one or more organic HAP's with partial pressures greater than 10.3 kilopascals, as well as one or more organic HAP's with partial pressures less than 10.3 kilopascals, a rack weighted partial pressure shall be documented. The rack weighted average HAP partial pressure shall be weighted by the annual throughput of each chemical transferred.

**§63.131 [Reserved]**

**§63.132 Process wastewater provisions—general.**

(a) *Existing sources.* This paragraph specifies the requirements applicable to process wastewater streams located at existing sources. The owner or operator shall comply with the requirements in paragraphs (a)(1) through (a)(3) of this section, no later than the applicable dates specified in §63.100 of subpart F of this part.

(1) *Determine wastewater streams to be controlled for Table 9 compounds.* Determine whether each wastewater stream requires control for Table 9 compounds by complying with the requirements in either paragraph (a)(1)(i) or (a)(1)(ii) of this section, and comply with the requirements in paragraph (a)(1)(iii) of this section.

(i) Comply with paragraph (c) of this section, determining whether the wastewater stream is Group 1 or Group 2 for Table 9 compounds; or

(ii) Comply with paragraph (e) of this section, designating the wastewater stream as a Group 1 wastewater stream.

(iii) Comply with paragraph (f) of this section.

(2) *Requirements for Group 1 wastewater streams.* For wastewater streams that are Group 1 for Table 9 compounds, comply with paragraphs (a)(2)(i) through (a)(2)(iv) of this section.

(i) Comply with the applicable requirements for wastewater tanks, surface impoundments, containers, individual drain systems, and oil/water separators as specified in §63.133 through §63.137 of this subpart, except as provided in paragraphs (a)(2)(i)(A) and (a)(2)(i)(B) of this section and §63.138(a)(3) of this subpart.

(A) The waste management units may be equipped with pressure relief devices that vent directly to the atmosphere provided the pressure relief device is not used for planned or routine venting of emissions.

(B) The pressure relief device remains in a closed position at all times except when it is necessary for the pressure relief device to open for the purpose of preventing physical damage or permanent deformation of the waste management unit in accordance with good engineering and safety practices.

(ii) Comply with the applicable requirements for control of Table 9 compounds as specified in §63.138 of this subpart. Alternatively, the owner or operator may elect to comply with the treatment provisions specified in §63.132(g) of this subpart.

(iii) Comply with the applicable monitoring and inspection requirements specified in §63.143 of this subpart.

(iv) Comply with the applicable recordkeeping and reporting requirements specified in §§63.146 and 63.147 of this subpart.

(3) *Requirements for Group 2 wastewater streams.* For wastewater streams that are Group 2 for table 9 compounds, comply with the applicable recordkeeping and reporting requirements specified in §§63.146(b)(1) and 63.147(b)(8).



(b) *New sources.* This paragraph specifies the requirements applicable to process wastewater streams located at new sources. The owner or operator shall comply with the requirements in paragraphs (b)(1) through (b)(4) of this section, no later than the applicable dates specified in §63.100 of subpart F of this part.

(1) *Determine wastewater streams to be controlled for Table 8 compounds.* Determine whether each wastewater stream requires control for Table 8 compounds by complying with the requirements in either paragraph (b)(1)(i) or (b)(1)(ii) of this section, and comply with the requirements in paragraph (b)(1)(iii) of this section.

(i) Comply with paragraph (d) of this section, determining whether the wastewater stream is Group 1 or Group 2 for Table 8 compounds; or

(ii) Comply with paragraph (e) of this section, designating the wastewater stream as a Group 1 wastewater stream for Table 8 compounds.

(iii) Comply with paragraph (f) of this section.

(2) *Determine wastewater streams to be controlled for Table 9 compounds.* Determine whether each wastewater stream requires control for Table 9 compounds by complying with the requirements in either paragraph (b)(2)(i) or (b)(2)(ii) of this section, and comply with the requirements in paragraph (b)(2)(iii) of this section.

(i) Comply with paragraph (c) of this section, determining whether the wastewater stream is Group 1 or Group 2 for Table 9 compounds; or

(ii) Comply with paragraph (e) of this section, designating the wastewater stream as a Group 1 wastewater stream.

(iii) Comply with paragraph (f) of this section.

(3) *Requirements for Group 1 wastewater streams.* For wastewater streams that are Group 1 for Table 8 compounds and/or Table 9 compounds, comply with paragraphs (b)(3)(i) through (b)(3)(iv) of this section.

(i) Comply with the applicable requirements for wastewater tanks, surface impoundments, containers, individual drain systems, and oil/water separators specified in the requirements of §63.133 through §63.137 of this subpart, except as provided in paragraphs (b)(3)(i)(A) and (b)(3)(i)(B) of this section and §63.138(a)(3) of this subpart.

(A) The waste management units may be equipped with pressure relief devices that vent directly to the atmosphere provided the pressure relief device is not used for planned or routine venting of emissions.

(B) The pressure relief device remains in a closed position at all times except when it is necessary for the pressure relief device to open for the purpose of preventing physical damage or permanent deformation of the waste management unit in accordance with good engineering and safety practices.

(ii) Comply with the applicable requirements for control of Table 8 compounds specified in §63.138 of this subpart. Alternatively, the owner or operator may elect to comply with the provisions specified in §63.132(g) of this subpart.

(iii) Comply with the applicable monitoring and inspection requirements specified in §63.143 of this subpart.

(iv) Comply with the applicable recordkeeping and reporting requirements specified in §§63.146 and 63.147 of this subpart.

(4) *Requirements for Group 2 wastewater streams.* For wastewater streams that are Group 2 for both table 8 and table 9 compounds, comply with the applicable recordkeeping and reporting requirements specified in §§63.146(b)(1) and 63.147(b)(8).

(c) *How to determine Group 1 or Group 2 status for Table 9 compounds.* This paragraph provides instructions for determining whether a wastewater stream is Group 1 or Group 2 for Table 9 compounds. Total annual average concentration shall be determined according to the procedures specified in §63.144(b) of this subpart. Annual average flow rate shall be determined according to the procedures specified in §63.144(c) of this subpart.

(1) A wastewater stream is a Group 1 wastewater stream for Table 9 compounds if:

(i) The total annual average concentration of Table 9 compounds is greater than or equal to 10,000 parts per million by weight at any flow rate; or

(ii) The total annual average concentration of Table 9 compounds is greater than or equal to 1,000 parts per million by weight and the annual average flow rate is greater than or equal to 10 liters per minute.

(2) A wastewater stream is a Group 2 wastewater stream for Table 9 compounds if it is not a Group 1 wastewater stream for Table 9 compounds by the criteria in paragraph (c)(1) of this section.

(3) The owner or operator of a Group 2 wastewater shall re-determine group status for each Group 2 stream, as necessary, to determine whether the stream is Group 1 or Group 2 whenever process changes are made that could reasonably be expected to change the stream to a Group 1 stream. Examples of process changes include, but are not limited to, changes in production capacity, production rate, feedstock type, or whenever there is a replacement, removal, or addition of recovery or control equipment. For purposes of this paragraph (c)(3), process changes do not include: Process upsets; unintentional, temporary process changes; and changes that are within the range on which the original determination was based.

(d) *How to determine Group 1 or Group 2 status for Table 8 compounds.* This paragraph provides instructions for determining whether a wastewater stream is Group 1 or Group 2 for Table 8 compounds. Annual average concentration for each Table 8 compound shall be determined according to the procedures specified in §63.144(b) of this subpart. Annual average flow rate shall be determined according to the procedures specified in §63.144(c) of this subpart.

(1) A wastewater stream is a Group 1 wastewater stream for Table 8 compounds if the annual average flow rate is 0.02 liter per minute or greater and the annual average concentration of any individual table 8 compound is 10 parts per million by weight or greater.

(2) A wastewater stream is a Group 2 wastewater stream for Table 8 compounds if the annual average flow rate is less than 0.02 liter per minute or the annual average concentration for each individual Table 8 compound is less than 10 parts per million by weight.

(3) The owner or operator of a Group 2 wastewater shall re-determine group status for each Group 2 stream, as necessary, to determine whether the stream is Group 1 or Group 2 whenever process

changes are made that could reasonably be expected to change the stream to a Group 1 stream. Examples of process changes include, but are not limited to, changes in production capacity, production rate, feedstock type, or whenever there is a replacement, removal, or addition of recovery or control equipment. For purposes of this paragraph (d)(3), process changes do not include: Process upsets; unintentional, temporary process changes; and changes that are within the range on which the original determination was based.

(e) *How to designate a Group 1 wastewater stream.* The owner or operator may elect to designate a wastewater stream a Group 1 wastewater stream in order to comply with paragraph (a)(1) or (b)(1) of this section. To designate a wastewater stream or a mixture of wastewater streams a Group 1 wastewater stream, the procedures specified in paragraphs (e)(1) and (e)(2) of this section and §63.144(a)(2) of this subpart shall be followed.

(1) From the point of determination for each wastewater stream that is included in the Group 1 designation to the location where the owner or operator elects to designate such wastewater stream(s) as a Group 1 wastewater stream, the owner or operator shall comply with all applicable emission suppression requirements specified in §§63.133 through 63.137.

(2) From the location where the owner or operator designates a wastewater stream or mixture of wastewater streams to be a Group 1 wastewater stream, such Group 1 wastewater stream shall be managed in accordance with all applicable emission suppression requirements specified in §§63.133 through 63.137 and with the treatment requirements in §63.138 of this part.

(f) Owners or operators of sources subject to this subpart shall not discard liquid or solid organic materials with a concentration of greater than 10,000 parts per million of Table 9 compounds (as determined by analysis of the stream composition, engineering calculations, or process knowledge, according to the provisions of §63.144(b) of this subpart) from a chemical manufacturing process unit to water or wastewater, unless the receiving stream is managed and treated as a Group 1 wastewater stream. This prohibition does not apply to materials from the activities listed in paragraphs (f)(1) through (f)(4) of this section.

(1) Equipment leaks;

(2) Activities included in maintenance or startup/shutdown/malfunction plans;

(3) Spills; or

(4) Samples of a size not greater than reasonably necessary for the method of analysis that is used.

(g) *Off-site treatment or on-site treatment not owned or operated by the source.* The owner or operator may elect to transfer a Group 1 wastewater stream or residual removed from a Group 1 wastewater stream to an on-site treatment operation not owned or operated by the owner or operator of the source generating the wastewater stream or residual, or to an off-site treatment operation.

(1) The owner or operator transferring the wastewater stream or residual shall:

(i) Comply with the provisions specified in §§63.133 through 63.137 of this subpart for each waste management unit that receives or manages a Group 1 wastewater stream or residual removed from a Group 1 wastewater stream prior to shipment or transport.

(ii) Include a notice with the shipment or transport of each Group 1 wastewater stream or residual removed from a Group 1 wastewater stream. The notice shall state that the wastewater stream or residual contains organic hazardous air pollutants that are to be treated in accordance with the provisions of this

subpart. When the transport is continuous or ongoing (for example, discharge to a publicly-owned treatment works), the notice shall be submitted to the treatment operator initially and whenever there is a change in the required treatment.

(2) The owner or operator may not transfer the wastewater stream or residual unless the transferee has submitted to the EPA a written certification that the transferee will manage and treat any Group 1 wastewater stream or residual removed from a Group 1 wastewater stream received from a source subject to the requirements of this subpart in accordance with the requirements of either §§63.133 through 63.147, or §63.102(b) of subpart F, or subpart D of this part if alternative emission limitations have been granted the transferor in accordance with those provisions. The certifying entity may revoke the written certification by sending a written statement to the EPA and the owner or operator giving at least 90 days notice that the certifying entity is rescinding acceptance of responsibility for compliance with the regulatory provisions listed in this paragraph. Upon expiration of the notice period, the owner or operator may not transfer the wastewater stream or residual to the treatment operation.

(3) By providing this written certification to the EPA, the certifying entity accepts responsibility for compliance with the regulatory provisions listed in paragraph (g)(2) of this section with respect to any shipment of wastewater or residual covered by the written certification. Failure to abide by any of those provisions with respect to such shipments may result in enforcement action by the EPA against the certifying entity in accordance with the enforcement provisions applicable to violations of these provisions by owners or operators of sources.

(4) Written certifications and revocation statements, to the EPA from the transferees of wastewater or residuals shall be signed by the responsible official of the certifying entity, provide the name and address of the certifying entity, and be sent to the appropriate EPA Regional Office at the addresses listed in 40 CFR 63.13. Such written certifications are not transferable by the treater.

[62 FR 2751, Jan. 17, 1997, as amended at 66 FR 6933, Jan. 22, 2001; 71 FR 76614, Dec. 21, 2006]

### **§63.133 Process wastewater provisions—wastewater tanks.**

(a) For each wastewater tank that receives, manages, or treats a Group 1 wastewater stream or a residual removed from a Group 1 wastewater stream, the owner or operator shall comply with the requirements of either paragraph (a)(1) or (a)(2) of this section as specified in table 10 of this subpart.

(1) The owner or operator shall operate and maintain a fixed roof except that if the wastewater tank is used for heating wastewater, or treating by means of an exothermic reaction or the contents of the tank is sparged, the owner or operator shall comply with the requirements specified in paragraph (a)(2) of this section.

(2) The owner or operator shall comply with the requirements in paragraphs (b) through (h) of this section and shall operate and maintain one of the emission control techniques listed in paragraphs (a)(2)(i) through (a)(2)(iv) of this section.

(i) A fixed roof and a closed-vent system that routes the organic hazardous air pollutants vapors vented from the wastewater tank to a control device.

(ii) A fixed roof and an internal floating roof that meets the requirements specified in §63.119(b) of this subpart;

(iii) An external floating roof that meets the requirements specified in §§63.119(c), 63.120(b)(5), and 63.120(b)(6) of this subpart; or

(iv) An equivalent means of emission limitation. Determination of equivalence to the reduction in emissions achieved by the requirements of paragraphs (a)(2)(i) through (a)(2)(iii) of this section will be evaluated according to §63.102(b) of subpart F of this part. The determination will be based on the application to the Administrator which shall include the information specified in either paragraph (a)(2)(iv)(A) or (a)(2)(iv)(B) of this section.

(A) Actual emissions tests that use full-size or scale-model wastewater tanks that accurately collect and measure all organic hazardous air pollutants emissions from a given control technique, and that accurately simulate wind and account for other emission variables such as temperature and barometric pressure, or

(B) An engineering evaluation that the Administrator determines is an accurate method of determining equivalence.

(b) If the owner or operator elects to comply with the requirements of paragraph (a)(2)(i) of this section, the fixed roof shall meet the requirements of paragraph (b)(1) of this section, the control device shall meet the requirements of paragraph (b)(2) of this section, and the closed-vent system shall meet the requirements of paragraph (b)(3) of this section.

(1) The fixed-roof shall meet the following requirements:

(i) Except as provided in paragraph (b)(4) of this section, the fixed roof and all openings (e.g., access hatches, sampling ports, and gauge wells) shall be maintained in accordance with the requirements specified in §63.148 of this subpart.

(ii) Each opening shall be maintained in a closed position (e.g., covered by a lid) at all times that the wastewater tank contains a Group 1 wastewater stream or residual removed from a Group 1 wastewater stream except when it is necessary to use the opening for wastewater sampling, removal, or for equipment inspection, maintenance, or repair.

(2) The control device shall be designed, operated, and inspected in accordance with the requirements of §63.139 of this subpart.

(3) Except as provided in paragraph (b)(4) of this section, the closed-vent system shall be inspected in accordance with the requirements of §63.148 of this subpart.

(4) For any fixed roof tank and closed-vent system that is operated and maintained under negative pressure, the owner or operator is not required to comply with the requirements specified in §63.148 of this subpart.

(c) If the owner or operator elects to comply with the requirements of paragraph (a)(2)(ii) of this section, the floating roof shall be inspected according to the procedures specified in §63.120(a)(2) and (a)(3) of this subpart.

(d) Except as provided in paragraph (e) of this section, if the owner or operator elects to comply with the requirements of paragraph (a)(2)(iii) of this section, seal gaps shall be measured according to the procedures specified in §63.120(b)(2)(i) through (b)(4) of this subpart and the wastewater tank shall be inspected to determine compliance with §63.120(b)(5) and (b)(6) of this subpart.

(e) If the owner or operator determines that it is unsafe to perform the seal gap measurements specified in §63.120(b)(2)(i) through (b)(4) of this subpart or to inspect the wastewater tank to determine compliance with §63.120(b)(5) and (b)(6) of this subpart because the floating roof appears to be

structurally unsound and poses an imminent or potential danger to inspecting personnel, the owner or operator shall comply with the requirements in either paragraph (e)(1) or (e)(2) of this section.

(1) The owner or operator shall measure the seal gaps or inspect the wastewater tank within 30 calendar days of the determination that the floating roof is unsafe, or

(2) The owner or operator shall empty and remove the wastewater tank from service within 45 calendar days of determining that the roof is unsafe. If the wastewater tank cannot be emptied within 45 calendar days, the owner or operator may utilize up to two extensions of up to 30 additional calendar days each. Documentation of a decision to utilize an extension shall include an explanation of why it was unsafe to perform the inspection or seal gap measurement, shall document that alternate storage capacity is unavailable, and shall specify a schedule of actions that will ensure that the wastewater tank will be emptied as soon as practical.

(f) Except as provided in paragraph (e) of this section, each wastewater tank shall be inspected initially, and semi-annually thereafter, for improper work practices in accordance with §63.143 of this subpart. For wastewater tanks, improper work practice includes, but is not limited to, leaving open any access door or other opening when such door or opening is not in use.

(g) Except as provided in paragraph (e) of this section, each wastewater tank shall be inspected for control equipment failures as defined in paragraph (g)(1) of this section according to the schedule in paragraphs (g)(2) and (g)(3) of this section.

(1) Control equipment failures for wastewater tanks include, but are not limited to, the conditions specified in paragraphs (g)(1)(i) through (g)(1)(ix) of this section.

(i) The floating roof is not resting on either the surface of the liquid or on the leg supports.

(ii) There is stored liquid on the floating roof.

(iii) A rim seal is detached from the floating roof.

(iv) There are holes, tears, cracks or gaps in the rim seal or seal fabric of the floating roof.

(v) There are visible gaps between the seal of an internal floating roof and the wall of the wastewater tank.

(vi) There are gaps between the metallic shoe seal or the liquid mounted primary seal of an external floating roof and the wall of the wastewater tank that exceed 212 square centimeters per meter of tank diameter or the width of any portion of any gap between the primary seal and the tank wall exceeds 3.81 centimeters.

(vii) There are gaps between the secondary seal of an external floating roof and the wall of the wastewater tank that exceed 21.2 square centimeters per meter of tank diameter or the width of any portion of any gap between the secondary seal and the tank wall exceeds 1.27 centimeters.

(viii) Where a metallic shoe seal is used on an external floating roof, one end of the metallic shoe does not extend into the stored liquid or one end of the metallic shoe does not extend a minimum vertical distance of 61 centimeters above the surface of the stored liquid.

(ix) A gasket, joint, lid, cover, or door has a crack or gap, or is broken.

(2) The owner or operator shall inspect for the control equipment failures in paragraphs (g)(1)(i) through (g)(1)(viii) of this section according to the schedule specified in paragraphs (c) and (d) of this section.

(3) The owner or operator shall inspect for the control equipment failures in paragraph (g)(1)(ix) of this section initially, and semi-annually thereafter.

(h) Except as provided in §63.140 of this subpart, when an improper work practice or a control equipment failure is identified, first efforts at repair shall be made no later than 5 calendar days after identification and repair shall be completed within 45 calendar days after identification. If a failure that is detected during inspections required by this section cannot be repaired within 45 calendar days and if the vessel cannot be emptied within 45 calendar days, the owner or operator may utilize up to 2 extensions of up to 30 additional calendar days each. Documentation of a decision to utilize an extension shall include a description of the failure, shall document that alternate storage capacity is unavailable, and shall specify a schedule of actions that will ensure that the control equipment will be repaired or the vessel will be emptied as soon as practical.

[62 FR 2753, Jan. 17, 1997, as amended at 64 FR 20191, Apr. 26, 1999]

#### **§63.134 Process wastewater provisions—surface impoundments.**

(a) For each surface impoundment that receives, manages, or treats a Group 1 wastewater stream or a residual removed from a Group 1 wastewater stream, the owner or operator shall comply with the requirements of paragraphs (b), (c), and (d) of this section.

(b) The owner or operator shall operate and maintain on each surface impoundment either a cover (e.g., air-supported structure or rigid cover) and a closed-vent system that routes the organic hazardous air pollutants vapors vented from the surface impoundment to a control device in accordance with paragraph (b)(1) of this section, or a floating flexible membrane cover as specified in paragraph (b)(2) of this section.

(1) The cover and all openings shall meet the following requirements:

(i) Except as provided in paragraph (b)(4) of this section, the cover and all openings (e.g., access hatches, sampling ports, and gauge wells) shall be maintained in accordance with the requirements specified in §63.148 of this subpart.

(ii) Each opening shall be maintained in a closed position (e.g., covered by a lid) at all times that a Group 1 wastewater stream or residual removed from a Group 1 wastewater stream is in the surface impoundment except when it is necessary to use the opening for sampling, removal, or for equipment inspection, maintenance, or repair.

(iii) The cover shall be used at all times that a Group 1 wastewater stream or residual removed from a Group 1 wastewater stream is in the surface impoundment except during removal of treatment residuals in accordance with 40 CFR 268.4 or closure of the surface impoundment in accordance with 40 CFR 264.228.

(2) Floating flexible membrane covers shall meet the requirements specified in paragraphs (b)(2)(i) through (b)(2)(vii) of this section.

(i) The floating flexible cover shall be designed to float on the liquid surface during normal operations, and to form a continuous barrier over the entire surface area of the liquid.

(ii) The cover shall be fabricated from a synthetic membrane material that is either:

(A) High density polyethylene (HDPE) with a thickness no less than 2.5 millimeters (100 mils); or

(B) A material or a composite of different materials determined to have both organic permeability properties that are equivalent to those of the material listed in paragraph (b)(2)(ii)(A) of this section, and chemical and physical properties that maintain the material integrity for the intended service life of the material.

(iii) The cover shall be installed in a manner such that there are no visible cracks, holes, gaps, or other open spaces between cover section seams or between the interface of the cover edge and its foundation mountings.

(iv) Except as provided for in paragraph (b)(2)(v) of this section, each opening in the floating membrane cover shall be equipped with a closure device designed to operate such that when the closure device is secured in the closed position there are no visible cracks, holes, gaps, or other open spaces in the closure device or between the perimeter of the cover opening and the closure device.

(v) The floating membrane cover may be equipped with one or more emergency cover drains for removal of stormwater. Each emergency cover drain shall be equipped with a slotted membrane fabric cover that covers at least 90 percent of the area of the opening or a flexible fabric sleeve seal.

(vi) The closure devices shall be made of suitable materials that will minimize exposure of organic hazardous air pollutants to the atmosphere, to the extent practical, and will maintain the integrity of the equipment throughout its intended service life. Factors to be considered in designing the closure devices shall include: The effects of any contact with the liquid and its vapor managed in the surface impoundment; the effects of outdoor exposure to wind, moisture, and sunlight; and the operating practices used for the surface impoundment on which the floating membrane cover is installed.

(vii) Whenever a Group 1 wastewater stream or residual from a Group 1 wastewater stream is in the surface impoundment, the floating membrane cover shall float on the liquid and each closure device shall be secured in the closed position. Opening of closure devices or removal of the cover is allowed to provide access to the surface impoundment for performing routine inspection, maintenance, or other activities needed for normal operations and/or to remove accumulated sludge or other residues from the bottom of surface impoundment. Openings shall be maintained in accordance with §63.148 of this subpart.

(3) The control device shall be designed, operated, and inspected in accordance with §63.139 of this subpart.

(4) Except as provided in paragraph (b)(5) of this section, the closed-vent system shall be inspected in accordance with §63.148 of this subpart.

(5) For any cover and closed-vent system that is operated and maintained under negative pressure, the owner or operator is not required to comply with the requirements specified in §63.148 of this subpart.

(c) Each surface impoundment shall be inspected initially, and semi-annually thereafter, for improper work practices and control equipment failures in accordance with §63.143 of this subpart.

(1) For surface impoundments, improper work practice includes, but is not limited to, leaving open any access hatch or other opening when such hatch or opening is not in use.



(2) For surface impoundments, control equipment failure includes, but is not limited to, any time a joint, lid, cover, or door has a crack or gap, or is broken.

(d) Except as provided in §63.140 of this subpart, when an improper work practice or a control equipment failure is identified, first efforts at repair shall be made no later than 5 calendar days after identification and repair shall be completed within 45 calendar days after identification.

[62 FR 2754, Jan. 17, 1997, as amended at 64 FR 20191, Apr. 26, 1999]

**§63.135 Process wastewater provisions—containers.**

(a) For each container that receives, manages, or treats a Group 1 wastewater stream or a residual removed from a Group 1 wastewater stream, the owner or operator shall comply with the requirements of paragraphs (b) through (f) of this section.

(b) The owner or operator shall operate and maintain a cover on each container used to handle, transfer, or store a Group 1 wastewater stream or residual removed from a Group 1 wastewater stream in accordance with the following requirements:

(1) Except as provided in paragraph (d)(4) of this section, if the capacity of the container is greater than 0.42 m<sup>3</sup>, the cover and all openings (e.g., bungs, hatches, sampling ports, and pressure relief devices) shall be maintained in accordance with the requirements specified in §63.148 of this subpart.

(2) If the capacity of the container is less than or equal to 0.42 m<sup>3</sup>, the owner or operator shall comply with either paragraph (b)(2)(i) or (b)(2)(ii) of this section.

(i) The container must meet existing Department of Transportation specifications and testing requirements under 49 CFR part 178; or

(ii) Except as provided in paragraph (d)(4) of this section, the cover and all openings shall be maintained without leaks as specified in §63.148 of this subpart.

(3) The cover and all openings shall be maintained in a closed position (e.g., covered by a lid) at all times that a Group 1 wastewater stream or residual removed from a Group 1 wastewater stream is in the container except when it is necessary to use the opening for filling, removal, inspection, sampling, or pressure relief events related to safety considerations.

(c) For containers with a capacity greater than or equal to 0.42 m<sup>3</sup>, a submerged fill pipe shall be used when a container is being filled by pumping with a Group 1 wastewater stream or residual removed from a Group 1 wastewater stream.

(1) The submerged fill pipe outlet shall extend to no more than 6 inches or within two fill pipe diameters of the bottom of the container while the container is being filled.

(2) The cover shall remain in place and all openings shall be maintained in a closed position except for those openings required for the submerged fill pipe and for venting of the container to prevent physical damage or permanent deformation of the container or cover.

(d) During treatment of a Group 1 wastewater stream or residual removed from a Group 1 wastewater stream, including aeration, thermal or other treatment, in a container, whenever it is necessary for the container to be open, the container shall be located within an enclosure with a closed-vent system that routes the organic hazardous air pollutants vapors vented from the container to a control device.

(1) Except as provided in paragraph (d)(4) of this section, the enclosure and all openings (e.g., doors, hatches) shall be maintained in accordance with the requirements specified in §63.148 of this subpart.

(2) The control device shall be designed, operated, and inspected in accordance with §63.139 of this subpart.

(3) Except as provided in paragraph (d)(4) of this section, the closed-vent system shall be inspected in accordance with §63.148 of this subpart.

(4) For any enclosure and closed-vent system that is operated and maintained under negative pressure, the owner or operator is not required to comply with the requirements specified in §63.148 of this subpart.

(e) Each container shall be inspected initially, and semi-annually thereafter, for improper work practices and control equipment failures in accordance with §63.143 of this subpart.

(1) For containers, improper work practice includes, but is not limited to, leaving open any access hatch or other opening when such hatch or opening is not in use.

(2) For containers, control equipment failure includes, but is not limited to, any time a cover or door has a gap or crack, or is broken.

(f) Except as provided in §63.140 of this subpart, when an improper work practice or a control equipment failure is identified, first efforts at repair shall be made no later than 5 calendar days after identification and repair shall be completed within 15 calendar days after identification.

[62 FR 2755, Jan. 17, 1997]

### **§63.136 Process wastewater provisions—individual drain systems.**

(a) For each individual drain system that receives or manages a Group 1 wastewater stream or a residual removed from a Group 1 wastewater stream, the owner or operator shall comply with the requirements of paragraphs (b), (c), and (d) or with paragraphs (e), (f), and (g) of this section.

(b) If the owner or operator elects to comply with this paragraph, the owner or operator shall operate and maintain on each opening in the individual drain system a cover and if vented, route the vapors to a process or through a closed vent system to a control device. The owner or operator shall comply with the requirements of paragraphs (b)(1) through (b)(5) of this section.

(1) The cover and all openings shall meet the following requirements:

(i) Except as provided in paragraph (b)(4) of this section, the cover and all openings (e.g., access hatches, sampling ports) shall be maintained in accordance with the requirements specified in §63.148 of this subpart.

(ii) The cover and all openings shall be maintained in a closed position at all times that a Group 1 wastewater stream or residual removed from a Group 1 wastewater stream is in the drain system except when it is necessary to use the opening for sampling or removal, or for equipment inspection, maintenance, or repair.

(2) The control device shall be designed, operated, and inspected in accordance with §63.139 of this subpart.

(3) Except as provided in paragraph (b)(4) of this section, the closed-vent system shall be inspected in accordance with §63.148 of this subpart.

(4) For any cover and closed-vent system that is operated and maintained under negative pressure, the owner or operator is not required to comply with the requirements specified in §63.148 of this subpart.

(5) The individual drain system shall be designed and operated to segregate the vapors within the system from other drain systems and the atmosphere.

(c) Each individual drain system shall be inspected initially, and semi-annually thereafter, for improper work practices and control equipment failures, in accordance with the inspection requirements specified in table 11 of this subpart.

(1) For individual drain systems, improper work practice includes, but is not limited to, leaving open any access hatch or other opening when such hatch or opening is not in use for sampling or removal, or for equipment inspection, maintenance, or repair.

(2) For individual drain systems, control equipment failure includes, but is not limited to, any time a joint, lid, cover, or door has a gap or crack, or is broken.

(d) Except as provided in §63.140 of this subpart, when an improper work practice or a control equipment failure is identified, first efforts at repair shall be made no later than 5 calendar days after identification and repair shall be completed within 15 calendar days after identification.

(e) If the owner or operator elects to comply with this paragraph, the owner or operator shall comply with the requirements in paragraphs (e)(1) through (e)(3) of this section:

(1) Each drain shall be equipped with water seal controls or a tightly fitting cap or plug. The owner or operator shall comply with paragraphs (e)(1)(i) and (e)(1)(ii) of this section.

(i) For each drain equipped with a water seal, the owner or operator shall ensure that the water seal is maintained. For example, a flow-monitoring device indicating positive flow from a main to a branch water line supplying a trap or water being continuously dripped into the trap by a hose could be used to verify flow of water to the trap. Visual observation is also an acceptable alternative.

(ii) If a water seal is used on a drain receiving a Group 1 wastewater, the owner or operator shall either extend the pipe discharging the wastewater below the liquid surface in the water seal of the receiving drain, or install a flexible shield (or other enclosure which restricts wind motion across the open area between the pipe and the drain) that encloses the space between the pipe discharging the wastewater to the drain receiving the wastewater. (Water seals which are used on hubs receiving Group 2 wastewater for the purpose of eliminating cross ventilation to drains carrying Group 1 wastewater are not required to have a flexible cap or extended subsurface discharging pipe.)

(2) Each junction box shall be equipped with a tightly fitting solid cover (i.e., no visible gaps, cracks, or holes) which shall be kept in place at all times except during inspection and maintenance. If the junction box is vented, the owner or operator shall comply with the requirements in paragraph (e)(2)(i) or (e)(2)(ii) of this section.

(i) The junction box shall be vented to a process or through a closed vent system to a control device. The closed vent system shall be inspected in accordance with the requirements of §63.148 and the control device shall be designed, operated, and inspected in accordance with the requirements of §63.139.

(ii) If the junction box is filled and emptied by gravity flow (i.e., there is no pump) or is operated with no more than slight fluctuations in the liquid level, the owner or operator may vent the junction box to the atmosphere provided that the junction box complies with the requirements in paragraphs (e)(2)(ii)(A) and (e)(2)(ii)(B) of this section.

(A) The vent pipe shall be at least 90 centimeters in length and no greater than 10.2 centimeters in nominal inside diameter.

(B) Water seals shall be installed and maintained at the wastewater entrance(s) to or exit from the junction box restricting ventilation in the individual drain system and between components in the individual drain system. The owner or operator shall demonstrate (e.g., by visual inspection or smoke test) upon request by the Administrator that the junction box water seal is properly designed and restricts ventilation.

(3) Each sewer line shall not be open to the atmosphere and shall be covered or enclosed in a manner so as to have no visible gaps or cracks in joints, seals, or other emission interfaces.

(f) Equipment used to comply with paragraphs (e)(1), (e)(2), or (e)(3) of this section shall be inspected as follows:

(1) Each drain using a tightly fitting cap or plug shall be visually inspected initially, and semi-annually thereafter, to ensure caps or plugs are in place and that there are no gaps, cracks, or other holes in the cap or plug.

(2) Each junction box shall be visually inspected initially, and semi-annually thereafter, to ensure that there are no gaps, cracks, or other holes in the cover.

(3) The unburied portion of each sewer line shall be visually inspected initially, and semi-annually thereafter, for indication of cracks or gaps that could result in air emissions.

(g) Except as provided in §63.140 of this subpart, when a gap, hole, or crack is identified in a joint or cover, first efforts at repair shall be made no later than 5 calendar days after identification, and repair shall be completed within 15 calendar days after identification.

[62 FR 2755, Jan. 17, 1997]

### **§63.137 Process wastewater provisions—oil-water separators.**

(a) For each oil-water separator that receives, manages, or treats a Group 1 wastewater stream or a residual removed from a Group 1 wastewater stream, the owner or operator shall comply with the requirements of paragraphs (c) and (d) of this section and shall operate and maintain one of the following:

(1) A fixed roof and a closed vent system that routes the organic hazardous air pollutants vapors vented from the oil-water separator to a control device. The fixed roof, closed-vent system, and control device shall meet the requirements specified in paragraph (b) of this section;

(2) A floating roof meeting the requirements in 40 CFR part 60, subpart QQQ §60.693-2 (a)(1)(i), (a)(1)(ii), (a)(2), (a)(3), and (a)(4). For portions of the oil-water separator where it is infeasible to construct and operate a floating roof, such as over the weir mechanism, the owner or operator shall operate and maintain a fixed roof, closed vent system, and control device that meet the requirements specified in paragraph (b) of this section.

(3) An equivalent means of emission limitation. Determination of equivalence to the reduction in emissions achieved by the requirements of paragraphs (a)(1) and (a)(2) of this section will be evaluated

according to §63.102(b) of subpart F of this part. The determination will be based on the application to the Administrator which shall include the information specified in either paragraph (a)(3)(i) or (a)(3)(ii) of this section.

(i) Actual emissions tests that use full-size or scale-model oil-water separators that accurately collect and measure all organic hazardous air pollutants emissions from a given control technique, and that accurately simulate wind and account for other emission variables such as temperature and barometric pressure, or

(ii) An engineering evaluation that the Administrator determines is an accurate method of determining equivalence.

(b) If the owner or operator elects to comply with the requirements of paragraphs (a)(1) or (a)(2) of this section, the fixed roof shall meet the requirements of paragraph (b)(1) of this section, the control device shall meet the requirements of paragraph (b)(2) of this section, and the closed-vent system shall meet the requirements of paragraph (b)(3) of this section.

(1) The fixed-roof shall meet the following requirements:

(i) Except as provided in paragraph (b)(4) of this section, the fixed roof and all openings (e.g., access hatches, sampling ports, and gauge wells) shall be maintained in accordance with the requirements specified in §63.148 of this subpart.

(ii) Each opening shall be maintained in a closed, sealed position (e.g., covered by a lid that is gasketed and latched) at all times that the oil-water separator contains a Group 1 wastewater stream or residual removed from a Group 1 wastewater stream except when it is necessary to use the opening for sampling or removal, or for equipment inspection, maintenance, or repair.

(2) The control device shall be designed, operated, and inspected in accordance with the requirements of §63.139 of this subpart.

(3) Except as provided in paragraph (b)(4) of this section, the closed-vent system shall be inspected in accordance with the requirements of §63.148 of this subpart.

(4) For any fixed roof and closed-vent system that is operated and maintained under negative pressure, the owner or operator is not required to comply with the requirements of §63.148 of this subpart.

(c) If the owner or operator elects to comply with the requirements of paragraph (a)(2) of this section, seal gaps shall be measured according to the procedures specified in 40 CFR part 60, subpart QQQ §60.696(d)(1) and the schedule specified in paragraphs (c)(1) and (c)(2) of this section.

(1) Measurement of primary seal gaps shall be performed within 60 calendar days after installation of the floating roof and introduction of a Group 1 wastewater stream or residual removed from a Group 1 wastewater stream and once every 5 years thereafter.

(2) Measurement of secondary seal gaps shall be performed within 60 calendar days after installation of the floating roof and introduction of a Group 1 wastewater stream or residual removed from a Group 1 wastewater stream and once every year thereafter.

(d) Each oil-water separator shall be inspected initially, and semi-annually thereafter, for improper work practices in accordance with §63.143 of this subpart. For oil-water separators, improper work

practice includes, but is not limited to, leaving open or ungasketed any access door or other opening when such door or opening is not in use.

(e) Each oil-water separator shall be inspected for control equipment failures as defined in paragraph (e)(1) of this section according to the schedule specified in paragraphs (e)(2) and (e)(3) of this section.

(1) For oil-water separators, control equipment failure includes, but is not limited to, the conditions specified in paragraphs (e)(1)(i) through (e)(1)(vii) of this section.

(i) The floating roof is not resting on either the surface of the liquid or on the leg supports.

(ii) There is stored liquid on the floating roof.

(iii) A rim seal is detached from the floating roof.

(iv) There are holes, tears, or other open spaces in the rim seal or seal fabric of the floating roof.

(v) There are gaps between the primary seal and the separator wall that exceed 67 square centimeters per meter of separator wall perimeter or the width of any portion of any gap between the primary seal and the separator wall exceeds 3.8 centimeters.

(vi) There are gaps between the secondary seal and the separator wall that exceed 6.7 square centimeters per meter of separator wall perimeter or the width of any portion of any gap between the secondary seal and the separator wall exceeds 1.3 centimeters.

(vii) A gasket, joint, lid, cover, or door has a gap or crack, or is broken.

(2) The owner or operator shall inspect for the control equipment failures in paragraphs (e)(1)(i) through (e)(1)(vi) of this section according to the schedule specified in paragraph (c) of this section.

(3) The owner or operator shall inspect for control equipment failures in paragraph (e)(1)(vii) of this section initially, and semi-annually thereafter.

(f) Except as provided in §63.140 of this subpart, when an improper work practice or a control equipment failure is identified, first efforts at repair shall be made no later than 5 calendar days after identification and repair shall be completed within 45 calendar days after identification.

[62 FR 2756, Jan. 17, 1997]

**§63.138 Process wastewater provisions—performance standards for treatment processes managing Group 1 wastewater streams and/or residuals removed from Group 1 wastewater streams.**

(a) *General requirements.* This section specifies the performance standards for treating Group 1 wastewater streams. The owner or operator shall comply with the requirements as specified in paragraphs (a)(1) through (a)(6) of this section. Where multiple compliance options are provided, the options may be used in combination for different wastewater streams and/or for different compounds (e.g., Table 8 versus Table 9 compounds) in the same wastewater streams, except where otherwise provided in this section. Once a Group 1 wastewater stream or residual removed from a Group 1 wastewater stream has been treated in accordance with this subpart, it is no longer subject to the requirements of this subpart.

(1) *Existing source.* If the wastewater stream, at an existing source, is Group 1 for Table 9 compounds, comply with §63.138(b).

(2) *New source.* If the wastewater stream, at a new source, is Group 1 for Table 8 compounds, comply with §63.138(c). If the wastewater stream, at a new source, is Group 1 for Table 9 compounds, comply with §63.138(b). If the wastewater stream, at a new source, is Group 1 for Table 8 and Table 9 compounds, comply with both §63.138(b) and §63.138(c).

NOTE TO PARAGRAPH (a)(2): The requirements for Table 8 and/or Table 9 compounds are similar and often identical.

(3) *Biological treatment processes.* Biological treatment processes in compliance with this section may be either open or closed biological treatment processes as defined in §63.111. An open biological treatment process in compliance with this section need not be covered and vented to a control device as required in §63.133 through §63.137 of this subpart. An open or a closed biological treatment process in compliance with this section and using §63.145(f) or §63.145(g) of this subpart to demonstrate compliance is not subject to the requirements of §63.133 through §63.137 of this subpart. A closed biological treatment process in compliance with this section and using §63.145(e) of this subpart to demonstrate compliance shall comply with the requirements of §63.133 through §63.137 of this subpart. Waste management units upstream of an open or closed biological treatment process shall meet the requirements of §63.133 through §63.137 of this subpart, as applicable.

(4) *Performance tests and design evaluations.* If design steam stripper option (§63.138(d)) or Resource Conservation and Recovery Act (RCRA) option (§63.138(h)) is selected to comply with this section, neither a design evaluation nor a performance test is required. For any other non-biological treatment process, and for closed biological treatment processes as defined in §63.111 of this subpart, the owner or operator shall conduct either a design evaluation as specified in §63.138(j), or a performance test as specified in §63.145, of this subpart. For each open biological treatment process as defined in §63.111 of this subpart, the owner or operator shall conduct a performance test as specified in §63.145 of this subpart.

NOTE TO PARAGRAPH (a)(4): Some open biological treatment processes may not require a performance test. Refer to §63.145(h) and table 36 of this subpart to determine whether the biological treatment process meets the criteria that exempt the owner or operator from conducting a performance test.

(5) *Control device requirements.* When gases are vented from the treatment process, the owner or operator shall comply with the applicable control device requirements specified in §63.139 and §63.145 (i) and (j), and the applicable leak inspection provisions specified in §63.148, of this subpart. This requirement does not apply to any open biological treatment process that meets the mass removal requirements. Vents from anaerobic biological treatment processes may be routed through hard-piping to a fuel gas system.

(6) *Residuals: general.* When residuals result from treating Group 1 wastewater streams, the owner or operator shall comply with the requirements for residuals specified in §63.138(k) of this subpart.

(7) *Treatment using a series of treatment processes.* In all cases where the wastewater provisions in this subpart allow or require the use of a treatment process or control device to comply with emissions limitations, the owner or operator may use multiple treatment processes or control devices, respectively. For combinations of treatment processes where the wastewater stream is conveyed by hard-piping, the owner or operator shall comply with either the requirements of paragraph (a)(7)(i) or (a)(7)(ii) of this section. For combinations of treatment processes where the wastewater stream is not conveyed by hard-piping, the owner or operator shall comply with the requirements of paragraph (a)(7)(ii) of this section. For combinations of control devices, the owner or operator shall comply with the requirements of paragraph (a)(7)(i) of this section.

(i)(A) For combinations of treatment processes, the wastewater stream shall be conveyed by hard-piping between the treatment processes. For combinations of control devices, the vented gas stream shall be conveyed by hard-piping between the control devices.

(B) For combinations of treatment processes, each treatment process shall meet the applicable requirements of §63.133 through §63.137 of this subpart except as provided in paragraph (a)(3) of this section.

(C) The owner or operator shall identify, and keep a record of, the combination of treatment processes or of control devices, including identification of the first and last treatment process or control device. The owner or operator shall include this information as part of the treatment process description reported in the Notification of Compliance Status.

(D) The performance test or design evaluation shall determine compliance across the combination of treatment processes or control devices. If a performance test is conducted, the "inlet" shall be the point at which the wastewater stream or residual enters the first treatment process, or the vented gas stream enters the first control device. The "outlet" shall be the point at which the treated wastewater stream exits the last treatment process, or the vented gas stream exits the last control device.

(ii)(A) For combinations of treatment processes, each treatment process shall meet the applicable requirements of §63.133 through §63.137 of this subpart except as provided in paragraph (a)(3) of this section.

(B) The owner or operator shall identify, and keep a record of, the combination of treatment processes, including identification of the first and last treatment process. The owner or operator shall include this information as part of the treatment process description reported in the Notification of Compliance Status.

(C) The owner or operator shall determine the mass removed or destroyed by each treatment process. The performance test or design evaluation shall determine compliance for the combination of treatment processes by adding together the mass removed or destroyed by each treatment process.

(b) *Control options: Group 1 wastewater streams for Table 9 compounds.* The owner or operator shall comply with either paragraph (b)(1) or (b)(2) of this section for the control of Table 9 compounds at new or existing sources.

(1) *50 ppmw concentration option.* The owner or operator shall comply with paragraphs (b)(1)(i) and (b)(1)(ii) of this section.

(i) Reduce, by removal or destruction, the total concentration of Table 9 compounds to a level less than 50 parts per million by weight as determined by the procedures specified in §63.145(b) of this subpart.

(ii) This option shall not be used when the treatment process is a biological treatment process. This option shall not be used when the wastewater stream is designated as a Group 1 wastewater stream as specified in §63.132(e). Dilution shall not be used to achieve compliance with this option.

(2) *Other compliance options.* Comply with the requirements specified in any one of paragraphs (d), (e), (f), (g), (h), or (i) of this section.

(c) *Control options: Group 1 wastewater streams for Table 8 compounds.* The owner or operator shall comply with either paragraph (c)(1) or (c)(2) of this section for the control of Table 8 compounds at new sources.



(1) *10 ppmw concentration option.* The owner or operator shall comply with paragraphs (c)(1)(i) and (c)(1)(ii) of this section.

(i) Reduce, by removal or destruction, the concentration of the individual Table 8 compounds to a level less than 10 parts per million by weight as determined in the procedures specified in §63.145(b) of this subpart.

(ii) This option shall not be used when the treatment process is a biological treatment process. This option shall not be used when the wastewater stream is designated as a Group 1 wastewater stream as specified in §63.132(e). Dilution shall not be used to achieve compliance with this option.

(2) *Other compliance options.* Comply with the requirements specified in any one of paragraphs (d), (e), (f), (g), (h), or (i) of this section.

(d) *Design steam stripper option.* The owner or operator shall operate and maintain a steam stripper that meets the requirements of paragraphs (d)(1) through (d)(6) of this section.

(1) Minimum active column height of 5 meters,

(2) Countercurrent flow configuration with a minimum of 10 actual trays,

(3) Minimum steam flow rate of 0.04 kilograms of steam per liter of wastewater feed within the column,

(4) Minimum wastewater feed temperature to the steam stripper of 95 °C, or minimum column operating temperature of 95 °C,

(5) Maximum liquid loading of 67,100 liters per hour per square meter, and

(6) Operate at nominal atmospheric pressure.

(e) *Percent mass removal/destruction option.* The owner or operator of a new or existing source shall comply with paragraph (e)(1) or (e)(2) of this section for control of Table 8 and/or Table 9 compounds for Group 1 wastewater streams. This option shall not be used for biological treatment processes.

(1) *Reduce mass flow rate of Table 8 and/or Table 9 compounds by 99 percent.* For wastewater streams that are Group 1, the owner or operator shall reduce, by removal or destruction, the mass flow rate of Table 8 and/or Table 9 compounds by 99 percent or more. The removal/destruction efficiency shall be determined by the procedures specified in §63.145(c), for noncombustion processes, or §63.145(d), for combustion processes.

(2) *Reduce mass flow rate of Table 8 and/or Table 9 compounds by Fr value.* For wastewater streams that are Group 1 for Table 8 and/or Table 9 compounds, the owner or operator shall reduce, by removal or destruction, the mass flow rate by at least the fraction removal (Fr) values specified in Table 9 of this subpart. (The Fr values for Table 8 compounds are all 0.99.) The removal/destruction efficiency shall be determined by the procedures specified in §63.145(c), for noncombustion treatment processes, or §63.145(d), for combustion treatment processes.

(f) *Required mass removal (RMR) option.* The owner or operator shall achieve the required mass removal (RMR) of Table 8 compounds at a new source for a wastewater stream that is Group 1 for Table 8 compounds and/or of Table 9 compounds at a new or existing source for a wastewater stream that is Group 1 for Table 9 compounds. For nonbiological treatment processes compliance shall be determined

using the procedures specified in §63.145(e) of this subpart. For aerobic biological treatment processes compliance shall be determined using the procedures specified in §63.145 (e) or (f) of this subpart. For closed anaerobic biological treatment processes compliance shall be determined using the procedures specified in §63.145(e) of this subpart. For open biological treatment processes compliance shall be determined using the procedures specified in §63.145(f) of this subpart.

(g) *95-percent RMR option, for biological treatment processes.* The owner or operator of a new or existing source using biological treatment for at least one wastewater stream that is Group 1 for Table 9 compounds shall achieve a RMR of at least 95 percent for all Table 9 compounds. The owner or operator of a new source using biological treatment for at least one wastewater stream that is Group 1 for Table 8 compounds shall achieve a RMR of at least 95 percent for all Table 8 compounds. All Group 1 and Group 2 wastewater streams entering a biological treatment unit that are from chemical manufacturing process units subject to subpart F shall be included in the demonstration of the 95-percent mass removal. The owner or operator shall comply with paragraphs (g)(1) through (g)(4) of this section.

(1) Except as provided in paragraph (g)(4) of this section, the owner or operator shall ensure that all Group 1 and Group 2 wastewater streams from chemical manufacturing process units subject to this rule entering a biological treatment unit are treated to destroy at least 95-percent total mass of all Table 8 and/or Table 9 compounds.

(2) For open biological treatment processes compliance shall be determined using the procedures specified in §63.145(g) of this subpart. For closed aerobic biological treatment processes compliance shall be determined using the procedures specified in §63.145 (e) or (g) of this subpart. For closed anaerobic biological treatment processes compliance shall be determined using the procedures specified in §63.145(e) of this subpart.

(3) For each treatment process or waste management unit that receives, manages, or treats wastewater streams subject to this paragraph, from the point of determination of each Group 1 or Group 2 wastewater stream to the biological treatment unit, the owner or operator shall comply with §§63.133 through §63.137 of this subpart for control of air emissions. When complying with this paragraph, the term Group 1, whether used alone or in combination with other terms, in §63.133 through §63.137 of this subpart shall mean both Group 1 and Group 2.

(4) If a wastewater stream is in compliance with the requirements in paragraph (b)(1), (c)(1), (d), (e), (f), or (h) of this section before entering the biological treatment unit, the hazardous air pollutants mass of that wastewater is not required to be included in the total mass flow rate entering the biological treatment unit for the purpose of demonstrating compliance.

(h) *Treatment in a RCRA unit option.* The owner or operator shall treat the wastewater stream or residual in a unit identified in, and complying with, paragraph (h)(1), (h)(2), or (h)(3) of this section. These units are exempt from the design evaluation or performance tests requirements specified in §63.138(a)(3) and §63.138(j) of this subpart, and from the monitoring requirements specified in §63.132(a)(2)(iii) and §63.132(b)(3)(iii) of this subpart, as well as recordkeeping and reporting requirements associated with monitoring and performance tests.

(1) The wastewater stream or residual is discharged to a hazardous waste incinerator for which the owner or operator has been issued a final permit under 40 CFR part 270 and complies with the requirements of 40 CFR part 264, subpart O, or has certified compliance with the interim status requirements of 40 CFR part 265, subpart O;

(2) The wastewater stream or residual is discharged to a process heater or boiler burning hazardous waste for which the owner or operator:

(i) Has been issued a final permit under 40 CFR part 270 and complies with the requirements of 40 CFR part 266, subpart H; or

(ii) Has certified compliance with the interim status requirements of 40 CFR part 266, subpart H.

(3) The wastewater stream or residual is discharged to an underground injection well for which the owner or operator has been issued a final permit under 40 CFR part 270 or 40 CFR part 144 and complies with the requirements of 40 CFR part 122. The owner or operator shall comply with all applicable requirements of this subpart prior to the point where the wastewater enters the underground portion of the injection well.

(i) *One megagram total source mass flow rate option.* A wastewater stream is exempt from the requirements of paragraphs (b) and (c) of this section if the owner or operator elects to comply with either paragraph (i)(1) or (2) of this section, and complies with paragraph (i)(3) of this section.

(1) *All Group 1 wastewater streams at the source.* The owner or operator shall demonstrate that the total source mass flow rate for Table 8 and/or Table 9 compounds is less than 1 megagram per year using the procedures in paragraphs (i)(1)(i) and (i)(1)(ii) of this section. The owner or operator shall include all Group 1 wastewater streams at the source in the total source mass flow rate. The total source mass flow rate shall be based on the mass as calculated before the wastewater stream is treated. The owner or operator who meets the requirements of this paragraph (i)(1) is exempt from the requirements of §§63.133 through 63.137.

(i) Calculate the annual average mass flow rate for each Group 1 wastewater stream by multiplying the annual average flow rate of the wastewater stream, as determined by procedures specified in §63.144(c), times the total annual average concentration of Table 8 and/or Table 9 compounds, as determined by procedures specified in §63.144(b) of this subpart. (The mass flow rate of compounds in a wastewater stream that is Group 1 for both Table 8 and Table 9 compounds should be included in the annual average mass flow rate only once.)

(ii) Calculate the total source mass flow rate from all Group 1 wastewater streams by adding together the annual average mass flow rate calculated for each Group 1 wastewater stream.

(2) *Untreated and partially treated Group 1 wastewater streams.* The owner or operator shall demonstrate that the total source mass flow rate for untreated Group 1 wastewater streams and Group 1 wastewater streams treated to levels less stringent than required in paragraph (b) or (c) of this section is less than 1 megagram per year using the procedures in paragraphs (i)(2)(i) and (i)(2)(ii) of this section. The owner or operator shall manage these wastewater streams in accordance with paragraph (i)(2)(iii) of this section, and shall comply with paragraph (i)(3) of this section.

(i) Calculate the annual average mass flow rate in each wastewater stream by multiplying the annual average flow rate of the wastewater stream, as determined by procedures specified in §63.144(c), times the total annual average concentration of Table 8 and/or Table 9 compounds, as determined by procedures specified in §63.144(b). (The mass flow rate of compounds in a wastewater stream that are Group 1 for both Table 8 and Table 9 compounds should be included in the annual average mass flow rate only once.) When determining the total source mass flow rate for the purposes of paragraph (i)(2)(i)(B) of this section, the concentration and flow rate shall be determined at the location specified in paragraph (i)(2)(i)(B) of this section and not at the location specified in §63.144(b) and (c).

(A) For each untreated Group 1 wastewater stream, the annual average flow rate and the total annual average concentration shall be determined for that stream's point of determination.

(B) For each Group 1 wastewater stream that is treated to levels less stringent than those required by paragraph (b) or (c) of this section, the annual average flow rate and total annual average

concentration shall be determined at the discharge from the treatment process or series of treatment processes.

(C) The annual average mass flow rate for Group 1 wastewater streams treated to the levels required by paragraph (b) or (c) of this section is not included in the calculation of the total source mass flow rate.

(ii) The total source mass flow rate shall be calculated by summing the annual average mass flow rates from all Group 1 wastewater streams, except those excluded by paragraph (i)(2)(i)(C) of this section.

(iii) The owner or operator of each waste management unit that receives, manages, or treats a partially treated wastewater stream prior to or during treatment shall comply with the requirements of §§63.133 through 63.137, as applicable. For a partially treated wastewater stream that is stored, conveyed, treated, or managed in a waste management unit meeting the requirements of §§63.133 through 63.137, the owner or operator shall follow the procedures in paragraph (i)(2)(i)(B) of this section to calculate mass flow rate. A wastewater stream, either untreated or partially treated, where the mass flow rate has been calculated following the procedures in paragraph (i)(2)(i)(A) of this section, is exempt from the requirements of §§63.133 through 63.137.

(3) Wastewater streams included in this option shall be identified in the Notification of Compliance Status required by §63.152(b).

(j) *Design evaluations or performance tests for treatment processes.* Except as provided in paragraph (j)(3) or (h) of this section, the owner or operator shall demonstrate by the procedures in either paragraph (j)(1) or (j)(2) of this section that each nonbiological treatment process used to comply with paragraphs (b)(1), (c)(1), (e), and/or (f) of this section achieves the conditions specified for compliance. The owner or operator shall demonstrate by the procedures in either paragraph (j)(1) or (j)(2) of this section that each closed biological treatment process used to comply with paragraphs (f) or (g) of this section achieves the conditions specified for compliance. If an open biological treatment unit is used to comply with paragraph (f) or (g) of this section, the owner or operator shall comply with §63.145(f) or §63.145(g), respectively, of this subpart. Some biological treatment processes may not require a performance test. Refer to §63.145(h) and table 36 of this subpart to determine whether the open biological treatment process meets the criteria that exempt the owner or operator from conducting a performance test.

(1) A design evaluation and supporting documentation that addresses the operating characteristics of the treatment process and that is based on operation at a representative wastewater stream flow rate and a concentration under which it would be most difficult to demonstrate compliance. For closed biological treatment processes, the actual mass removal shall be determined by a mass balance over the unit. The mass flow rate of Table 8 or Table 9 compounds exiting the treatment process shall be the sum of the mass flow rate of Table 8 or Table 9 compounds in the wastewater stream exiting the biological treatment process and the mass flow rate of the vented gas stream exiting the control device. The mass flow rate entering the treatment process minus the mass flow rate exiting the process determines the actual mass removal.

(2) Performance tests conducted using test methods and procedures that meet the applicable requirements specified in §63.145 of this subpart.

(3) The provisions of paragraphs (j)(1) and (j)(2) of this section do not apply to design stream strippers which meet the requirements of paragraph (d) of this section.

(k) *Residuals*. For each residual removed from a Group 1 wastewater stream, the owner or operator shall control for air emissions by complying with §§63.133-137 of this subpart and by complying with one of the provisions in paragraphs (k)(1) through (k)(4) of this section.

(1) Recycle the residual to a production process or sell the residual for the purpose of recycling. Once a residual is returned to a production process, the residual is no longer subject to this section.

(2) Return the residual to the treatment process.

(3) Treat the residual to destroy the total combined mass flow rate of Table 8 and/or Table 9 compounds by 99 percent or more, as determined by the procedures specified in §63.145(c) or (d) of this subpart.

(4) Comply with the requirements for RCRA treatment options specified in §63.138(h) of this subpart.

[62 FR 2757, Jan. 17, 1997, as amended at 66 FR 6933, Jan. 22, 2001]

### **§63.139 Process wastewater provisions—control devices.**

(a) For each control device or combination of control devices used to comply with the provisions in §§63.133 through 63.138 of this subpart, the owner or operator shall operate and maintain the control device or combination of control devices in accordance with the requirements of paragraphs (b) through (f) of this section.

(b) Whenever organic hazardous air pollutants emissions are vented to a control device which is used to comply with the provisions of this subpart, such control device shall be operating.

(c) The control device shall be designed and operated in accordance with paragraph (c)(1), (c)(2), (c)(3), (c)(4), or (c)(5) of this section.

(1) An enclosed combustion device (including but not limited to a vapor incinerator, boiler, or process heater) shall meet the conditions in paragraph (c)(1)(i), (c)(1)(ii), or (c)(1)(iii) of this section, alone or in combination with other control devices. If a boiler or process heater is used as the control device, then the vent stream shall be introduced into the flame zone of the boiler or process heater.

(i) Reduce the total organic compound emissions, less methane and ethane, or total organic hazardous air pollutants emissions vented to the control device by 95 percent by weight or greater;

(ii) Achieve an outlet total organic compound concentration, less methane and ethane, or total organic hazardous air pollutants concentration of 20 parts per million by volume on a dry basis corrected to 3 percent oxygen. The owner or operator shall use either Method 18 of 40 CFR part 60, appendix A, or any other method or data that has been validated according to the applicable procedures in Method 301 of appendix A of this part; or

(iii) Provide a minimum residence time of 0.5 seconds at a minimum temperature of 760 °C.

(2) A vapor recovery system (including but not limited to a carbon adsorption system or condenser), alone or in combination with other control devices, shall reduce the total organic compound emissions, less methane and ethane, or total organic hazardous air pollutants emissions vented to the control device of 95 percent by weight or greater or achieve an outlet total organic compound concentration, less methane and ethane, or total organic hazardous air pollutants concentration of 20 parts per million by

volume, whichever is less stringent. The 20 parts per million by volume performance standard is not applicable to compliance with the provisions of §63.134 or §63.135 of this subpart.

(3) A flare shall comply with the requirements of §63.11(b) of subpart A of this part.

(4) A scrubber, alone or in combination with other control devices, shall reduce the total organic compound emissions, less methane and ethane, or total organic hazardous air pollutants emissions in such a manner that 95 weight-percent is either removed, or destroyed by chemical reaction with the scrubbing liquid or achieve an outlet total organic compound concentration, less methane and ethane, or total organic hazardous air pollutants concentration of 20 parts per million by volume, whichever is less stringent. The 20 parts per million by volume performance standard is not applicable to compliance with the provisions of §63.134 or §63.135 of this subpart.

(5) Any other control device used shall, alone or in combination with other control devices, reduce the total organic compound emissions, less methane and ethane, or total organic hazardous air pollutants emissions vented to the control device by 95 percent by weight or greater or achieve an outlet total organic compound concentration, less methane and ethane, or total organic hazardous air pollutants concentration of 20 parts per million by volume, whichever is less stringent. The 20 parts per million by volume performance standard is not applicable to compliance with the provisions of §63.134 or §63.135 of this subpart.

(d) Except as provided in paragraph (d)(4) of this section, an owner or operator shall demonstrate that each control device or combination of control devices achieves the appropriate conditions specified in paragraph (c) of this section by using one or more of the methods specified in paragraphs (d)(1), (d)(2), or (d)(3) of this section.

(1) Performance tests conducted using the test methods and procedures specified in §63.145(i) of this subpart for control devices other than flares; or

(2) A design evaluation that addresses the vent stream characteristics and control device operating parameters specified in paragraphs (d)(2)(i) through (d)(2)(vii) of this section.

(i) For a thermal vapor incinerator, the design evaluation shall consider the vent stream composition, constituent concentrations, and flow rate and shall establish the design minimum and average temperature in the combustion zone and the combustion zone residence time.

(ii) For a catalytic vapor incinerator, the design evaluation shall consider the vent stream composition, constituent concentrations, and flow rate and shall establish the design minimum and average temperatures across the catalyst bed inlet and outlet.

(iii) For a boiler or process heater, the design evaluation shall consider the vent stream composition, constituent concentrations, and flow rate; shall establish the design minimum and average flame zone temperatures and combustion zone residence time; and shall describe the method and location where the vent stream is introduced into the flame zone.

(iv) For a condenser, the design evaluation shall consider the vent stream composition, constituent concentrations, flow rate, relative humidity, and temperature and shall establish the design outlet organic compound concentration level, design average temperature of the condenser exhaust vent stream, and the design average temperatures of the coolant fluid at the condenser inlet and outlet.

(v) For a carbon adsorption system that regenerates the carbon bed directly on-site in the control device such as a fixed-bed adsorber, the design evaluation shall consider the vent stream composition, constituent concentrations, flow rate, relative humidity, and temperature and shall establish the design

exhaust vent stream organic compound concentration level, adsorption cycle time, number and capacity of carbon beds, type and working capacity of activated carbon used for carbon beds, design total regeneration stream mass or volumetric flow over the period of each complete carbon bed regeneration cycle, design carbon bed temperature after regeneration, design carbon bed regeneration time, and design service life of carbon.

(vi) For a carbon adsorption system that does not regenerate the carbon bed directly on-site in the control device such as a carbon canister, the design evaluation shall consider the vent stream composition, constituent concentrations, mass or volumetric flow rate, relative humidity, and temperature and shall establish the design exhaust vent stream organic compound concentration level, capacity of carbon bed, type and working capacity of activated carbon used for carbon bed, and design carbon replacement interval based on the total carbon working capacity of the control device and source operating schedule.

(vii) For a scrubber, the design evaluation shall consider the vent stream composition; constituent concentrations; liquid-to-vapor ratio; scrubbing liquid flow rate and concentration; temperature; and the reaction kinetics of the constituents with the scrubbing liquid. The design evaluation shall establish the design exhaust vent stream organic compound concentration level and will include the additional information in paragraphs (d)(2)(vii)(A) and (d)(2)(vii)(B) of this section for trays and a packed column scrubber.

(A) Type and total number of theoretical and actual trays;

(B) Type and total surface area of packing for entire column, and for individual packed sections if column contains more than one packed section.

(3) For flares, the compliance determination specified in §63.11(b) of subpart A of this part and §63.145(j) of this subpart.

(4) An owner or operator using any control device specified in paragraphs (d)(4)(i) through (d)(4)(iv) of this section is exempt from the requirements in paragraphs (d)(1) through (d)(3) of this section and from the requirements in §63.6(f) of subpart A of this part, and from the requirements of paragraph (e) of this section.

(i) A boiler or process heater with a design heat input capacity of 44 megawatts or greater.

(ii) A boiler or process heater into which the emission stream is introduced with the primary fuel.

(iii) A boiler or process heater burning hazardous waste for which the owner or operator:

(A) Has been issued a final permit under 40 CFR part 270 and complies with the requirements of 40 CFR part 266, subpart H, or

(B) Has certified compliance with the interim status requirements of 40 CFR part 266, subpart H.

(iv) A hazardous waste incinerator for which the owner or operator has been issued a final permit under 40 CFR part 270 and complies with the requirements of 40 CFR part 264, subpart O, or has certified compliance with the interim status requirements of 40 CFR part 265, subpart O.

(e) The owner or operator of a control device that is used to comply with the provisions of this section shall monitor the control device in accordance with §63.143 of this subpart.

(f) Except as provided in §63.140 of this subpart, if gaps, cracks, tears, or holes are observed in ductwork, piping, or connections to covers and control devices during an inspection, a first effort to repair shall be made as soon as practical but no later than 5 calendar days after identification. Repair shall be completed no later than 15 calendar days after identification or discovery of the defect.

[62 FR 2760, Jan. 17, 1997, as amended at 64 FR 20192, Apr. 26, 1999]

**§63.140 Process wastewater provisions—delay of repair.**

(a) Delay of repair of equipment for which a control equipment failure or a gap, crack, tear, or hole has been identified, is allowed if the repair is technically infeasible without a shutdown, as defined in §63.101 of subpart F of this part, or if the owner or operator determines that emissions of purged material from immediate repair would be greater than the emissions likely to result from delay of repair. Repair of this equipment shall occur by the end of the next shutdown.

(b) Delay of repair of equipment for which a control equipment failure or a gap, crack, tear, or hole has been identified, is allowed if the equipment is emptied or is no longer used to treat or manage Group 1 wastewater streams or residuals removed from Group 1 wastewater streams.

(c) Delay of repair of equipment for which a control equipment failure or a gap, crack, tear, or hole has been identified is also allowed if additional time is necessary due to the unavailability of parts beyond the control of the owner or operator. Repair shall be completed as soon as practical. The owner or operator who uses this provision shall comply with the requirements of §63.147(b)(7) to document the reasons that the delay of repair was necessary.

[62 FR 2762, Jan. 17, 1997, as amended at 66 FR 6933, Jan. 22, 2001]

**§§63.141-63.142 [Reserved]**

**§63.143 Process wastewater provisions—inspections and monitoring of operations.**

(a) For each wastewater tank, surface impoundment, container, individual drain system, and oil-water separator that receives, manages, or treats a Group 1 wastewater stream, a residual removed from a Group 1 wastewater stream, a recycled Group 1 wastewater stream, or a recycled residual removed from a Group 1 wastewater stream, the owner or operator shall comply with the inspection requirements specified in table 11 of this subpart.

(b) For each design steam stripper and biological treatment unit used to comply with §63.138 of this subpart, the owner or operator shall comply with the monitoring requirements specified in table 12 of this subpart.

(c) If the owner or operator elects to comply with Item 1 in table 12 of this subpart, the owner or operator shall request approval to monitor appropriate parameters that demonstrate proper operation of the biological treatment unit. The request shall be submitted according to the procedures specified in §63.151(f) of this subpart, and shall include a description of planned reporting and recordkeeping procedures. The owner or operator shall include as part of the submittal the basis for the selected monitoring frequencies and the methods that will be used. The Administrator will specify appropriate reporting and recordkeeping requirements as part of the review of the permit application or by other appropriate means.

(d) If the owner or operator elects to comply with Item 3 in table 12 of this subpart, the owner or operator shall request approval to monitor appropriate parameters that demonstrate proper operation of the selected treatment process. The request shall be submitted according to the procedures specified in §63.151(f) of this subpart, and shall include a description of planned reporting and recordkeeping



procedures. The Administrator will specify appropriate reporting and recordkeeping requirements as part of the review of the permit application or by other appropriate means.

(e) Except as provided in paragraphs (e)(4) and (e)(5) of this section, for each control device used to comply with the requirements of §§63.133 through 63.139 of this subpart, the owner or operator shall comply with the requirements in §63.139(d) of this subpart, and with the requirements specified in paragraph (e)(1), (e)(2), or (e)(3) of this section.

(1) The owner or operator shall comply with the monitoring requirements specified in table 13 of this subpart; or

(2) The owner or operator shall use an organic monitoring device installed at the outlet of the control device and equipped with a continuous recorder. Continuous recorder is defined in §63.111 of this subpart; or

(3) The owner or operator shall request approval to monitor parameters other than those specified in paragraphs (e)(1) and (e)(2) of this section. The request shall be submitted according to the procedures specified in §63.151(f) of this subpart, and shall include a description of planned reporting and recordkeeping procedures. The Administrator will specify appropriate reporting and recordkeeping requirements as part of the review of the permit application or by other appropriate means.

(4) For a boiler or process heater in which all vent streams are introduced with primary fuel, the owner or operator shall comply with the requirements in §63.139(d) of this subpart but the owner or operator is exempt from the monitoring requirements specified in paragraphs (e)(1) through (e)(3) of this section.

(5) For a boiler or process heater with a design heat input capacity of 44 megawatts or greater, the owner or operator shall comply with the requirements in §63.139(d) of this subpart but the owner or operator is exempt from the monitoring requirements specified in paragraphs (e)(1) through (e)(3) of this section.

(f) For each parameter monitored in accordance with paragraph (c), (d), or (e) of this section, the owner or operator shall establish a range that indicates proper operation of the treatment process or control device. In order to establish the range, the owner or operator shall comply with the requirements specified in §§63.146(b)(7)(ii)(A) and (b)(8)(ii) of this subpart.

(g) Monitoring equipment shall be installed, calibrated, and maintained according to the manufacturer's specifications or other written procedures that provide adequate assurance that the equipment would reasonably be expected to monitor accurately.

[62 FR 2762, Jan. 17, 1997]

**§63.144 Process wastewater provisions—test methods and procedures for determining applicability and Group 1/Group 2 determinations (determining which wastewater streams require control).**

(a) *Procedures to determine applicability.* An owner or operator shall comply with paragraph (a)(1) or (a)(2) of this section for each wastewater stream to determine which wastewater streams require control for Table 8 and/or Table 9 compounds. The owner or operator may use a combination of the approaches in paragraphs (a)(1) and (a)(2) of this section for different wastewater streams generated at the source.

(1) *Determine Group 1 or Group 2 status.* Determine whether a wastewater stream is a Group 1 or Group 2 wastewater stream in accordance with paragraphs (b) and (c) of this section.

(2) *Designate as Group 1.* An owner or operator may designate as a Group 1 wastewater stream a single wastewater stream or a mixture of wastewater streams. The owner or operator is not required to determine the concentration or flow rate for each designated Group 1 wastewater stream for the purposes of this section.

(b) *Procedures to establish concentrations, when determining Group status under paragraph (a)(1) of this section.* An owner or operator who elects to comply with the requirements of paragraph (a)(1) of this section shall determine the annual average concentration for Table 8 and/or Table 9 compounds according to paragraph (b)(1) of this section for existing sources or paragraph (b)(2) of this section for new sources. The annual average concentration shall be a flow weighted average representative of actual or anticipated operation of the chemical manufacturing process unit generating the wastewater over a designated 12 month period. For flexible operation units, the owner or operator shall consider the anticipated production over the designated 12 month period and include all wastewater streams generated by the process equipment during this period. The owner/operator is not required to determine the concentration of Table 8 or Table 9 compounds that are not reasonably expected to be in the process.

(1) *Existing sources.* An owner or operator of an existing source who elects to comply with the requirements of paragraph (a)(1) of this section shall determine the flow weighted total annual average concentration for Table 9 compounds. For the purposes of this section, the term concentration, whether concentration is used alone or with other terms, may be adjusted by multiplying by the compound-specific fraction measured (Fm) factors listed in table 34 of this subpart unless determined by the methods in §63.144(b)(5)(i)(A) and/or (B). When concentration is determined by Method 305 as specified in §63.144(b)(5)(i)(B), concentration may be adjusted by dividing by the compound-specific Fm factors listed in table 34 of this subpart. When concentration is determined by Method 25D as specified in §63.144(b)(5)(i)(A), concentration may not be adjusted by the compound-specific Fm factors listed in table 34 of this subpart. Compound-specific Fm factors may be used only when concentrations of individual compounds are determined or when only one compound is in the wastewater stream. Flow weighted total annual average concentration for Table 9 compounds means the total mass of Table 9 compounds occurring in the wastewater stream during the designated 12-month period divided by the total mass of the wastewater stream during the same designated 12-month period. The total annual average concentration shall be determined for each wastewater stream either at the point of determination, or downstream of the point of determination with adjustment for concentration changes made according to paragraph (b)(6) of this section. The procedures specified in paragraphs (b)(3), (b)(4), and (b)(5) of this section are considered acceptable procedures for determining the annual average concentration. They may be used in combination, and no one procedure shall take precedence over another.

(2) *New sources.* An owner or operator of a new source who elects to comply with the requirements of paragraph (a)(1) of this section shall determine both the flow weighted total annual average concentration for Table 9 compounds and the flow weighted annual average concentration for each Table 8 compound. For the purposes of this section, the term concentration, whether concentration is used alone or with other terms, may be adjusted by multiplying by the compound-specific Fm factors listed in table 34 of this subpart unless determined by the methods in §63.144(b)(5)(i)(A) and/or (B). When concentration is determined by Method 305 as specified in §63.144(b)(5)(i)(B), concentration may be adjusted by dividing by the compound-specific Fm factors listed in table 34 of this subpart. When concentration is determined by Method 25D as specified in §63.144(b)(5)(i)(A), concentration may not be adjusted by the compound-specific Fm factors listed in table 34 of this subpart. Compound-specific fraction measured factors are compound specific and shall be used only when concentration of individual compounds are determined or when only one compound is in the wastewater stream. The flow weighted annual average concentration of each Table 8 compound means the mass of each Table 8 compound occurring in the wastewater stream during the designated 12-month period divided by the total mass of the wastewater stream during the same designated 12-month period. Flow weighted total annual average

concentration for Table 9 compounds means the total mass of Table 9 compounds occurring in the wastewater stream during the designated 12-month period divided by the total mass of the wastewater stream during the same designated 12-month period. The annual average concentration shall be determined for each wastewater stream either at the point of determination, or downstream of the point of determination with adjustment for concentration changes made according to paragraph (b)(6) of this section. Procedures specified in paragraphs (b)(3), (b)(4), and (b)(5) of this section are considered acceptable procedures for determining the annual average concentration. They may be used in combination, and no one procedure shall take precedence over another.

(3) *Knowledge of the wastewater.* Where knowledge is used to determine the annual average concentration, the owner or operator shall provide sufficient information to document the annual average concentration for wastewater streams determined to be Group 2 wastewater streams. Documentation to determine the annual average concentration is not required for Group 1 streams. Examples of acceptable documentation include material balances, records of chemical purchases, process stoichiometry, or previous test results. If test data are used, the owner or operator shall provide documentation describing the testing protocol and the means by which any losses of volatile compounds during sampling, and the bias and accuracy of the analytical method, were accounted for in the determination.

(4) *Bench-scale or pilot-scale test data.* Where bench-scale or pilot-scale test data are used to determine the annual average concentration, the owner or operator shall provide sufficient information to document that the data are representative of the actual annual average concentration, or are reliably indicative of another relevant characteristic of the wastewater stream that could be used to predict the annual average concentration. For concentration data, the owner or operator shall also provide documentation describing the testing protocol, and the means by which any losses of volatile compounds during sampling, and the bias and accuracy of the analytical method, were accounted for in the determination of annual average concentration.

(5) *Test data from sampling at the point of determination or at a location downstream of the point of determination.* Where an owner or operator elects to comply with paragraph (a)(1) of this section by measuring the concentration for the relevant Table 8 or Table 9 compounds, the owner or operator shall comply with the requirements of this paragraph. For each wastewater stream, measurements shall be made either at the point of determination, or downstream of the point of determination with adjustment for concentration changes made according to paragraph (b)(6) of this section. A minimum of three samples from each wastewater stream shall be taken. Samples may be grab samples or composite samples.

(i) *Methods.* The owner or operator shall use any of the methods specified in paragraphs (b)(5)(i)(A) through (b)(5)(i)(F) of this section.

(A) *Method 25D.* Use procedures specified in Method 25D of 40 CFR part 60, appendix A.

(B) *Method 305.* Use procedures specified in Method 305 of 40 CFR part 63, appendix A.

(C) *Methods 624 and 625.* Use procedures specified in Methods 624 and 625 of 40 CFR part 136, appendix A and comply with the sampling protocol requirements specified in paragraph (b)(5)(ii) of this section. If these methods are used to analyze one or more compounds that are not on the method's published list of approved compounds, the Alternative Test Procedure specified in 40 CFR 136.4 and 136.5 shall be followed. For Method 625, make corrections to the compounds for which the analysis is being conducted based on the accuracy as recovery factors in Table 7 of the method.

(D) *Method 1624 and Method 1625.* Use procedures specified in Method 1624 and Method 1625 of 40 CFR part 136, appendix A and comply with the requirements specified in paragraph (b)(5)(ii) of this section. If these methods are used to analyze one or more compounds that are not on the method's published list of approved compounds, the Alternative Test Procedure specified in 40 CFR 136.4 and 136.5 shall be followed.

(E) *Other EPA method(s)*. Use procedures specified in the method and comply with the requirements specified in paragraphs (b)(5)(ii) and either paragraph (b)(5)(iii)(A) or (b)(5)(iii)(B) of this section.

(F) *Method(s) other than EPA method*. Use procedures specified in the method and comply with the requirements specified in paragraphs (b)(5)(ii) and (b)(5)(iii)(A) of this section.

(G) *Method 8260B*. Use procedures specified in Method 8260B in the SW-846 Compendium of Methods.

(H) *Method 316*. Use Method 316 to determine formaldehyde concentration.

(ii) *Sampling plan*. The owner or operator who is expressly referred to this paragraph by provisions of this subpart shall prepare a sampling plan. Wastewater samples shall be collected using sampling procedures which minimize loss of organic compounds during sample collection and analysis and maintain sample integrity. The sample plan shall include procedures for determining recovery efficiency of the relevant hazardous air pollutants listed in table 8 or table 9 of this subpart. An example of an acceptable sampling plan would be one that incorporates similar sampling and sample handling requirements to those of Method 25D of 40 CFR part 60, appendix A. The sampling plan shall be maintained at the facility.

(iii) *Validation of methods*. The owner or operator shall validate EPA methods other than Methods 25D, 305, 624, 625, 1624, and 1625 using the procedures specified in paragraph (b)(5)(iii)(A) or (b)(5)(iii)(B) of this section. The owner or operator shall validate other methods as specified in paragraph (b)(5)(iii)(A) of this section.

(A) *Validation of EPA methods and other methods*. The method used to measure organic hazardous air pollutants concentrations in the wastewater shall be validated according to section 5.1 or 5.3, and the corresponding calculations in section 6.1 or 6.3, of Method 301 of appendix A of this part. The data are acceptable if they meet the criteria specified in section 6.1.5 or 6.3.3 of Method 301 of appendix A of this part. If correction is required under section 6.3.3 of Method 301 of appendix A of this part, the data are acceptable if the correction factor is within the range 0.7 to 1.30. Other sections of Method 301 of appendix A of this part are not required. The concentrations of the individual organic hazardous air pollutants measured in the water may be corrected to their concentrations had they been measured by Method 305 of appendix A of this part, by multiplying each concentration by the compound-specific fraction measured ( $F_m$ ) factor listed in table 34 of this subpart.

(B) *Validation for EPA methods*. Follow the procedures as specified in "Alternative Validation Procedure for EPA Waste Methods" 40 CFR part 63, appendix D.

(iv) *Calculations of average concentration*. The average concentration for each individually speciated Table 8 compound shall be calculated by adding the individual values determined for the specific compound in each sample and dividing by the number of samples. The total average concentration of Table 9 compounds shall be calculated by first summing the concentration of the individual compounds to obtain a total hazardous air pollutants concentration for the sample; add the sample totals and then divide by the number of samples in the run to obtain the sample average for the run. If the method used does not speciate the compounds, the sample results should be added and this total divided by the number of samples in the run to obtain the sample average for the run.

(6) *Adjustment for concentrations determined downstream of the point of determination*. The owner or operator shall make corrections to the annual average concentration or total annual average concentration when the concentration is determined downstream of the point of determination at a location where: two or more wastewater streams have been mixed; one or more wastewater streams

have been treated; or, losses to the atmosphere have occurred. The owner or operator shall make the adjustments either to the individual data points or to the final annual average concentration.

(c) *Procedures to determine flow rate, when evaluating Group status under paragraph (a)(1) of this section.* An owner or operator who elects to comply with paragraph (a)(1) of this section shall determine the annual average flow rate of the wastewater stream either at the point of determination for each wastewater stream, or downstream of the point of determination with adjustment for flow rate changes made according to paragraph (c)(4) of this section. These procedures may be used in combination for different wastewater streams at the source. The annual average flow rate for the wastewater stream shall be representative of actual or anticipated operation of the chemical manufacturing process unit generating the wastewater over a designated 12-month period. The owner or operator shall consider the total annual wastewater volume generated by the chemical manufacturing process unit. If the chemical manufacturing process unit is a flexible operation unit, the owner or operator shall consider all anticipated production in the process equipment over the designated 12-month period. The procedures specified in paragraphs (c)(1), (c)(2), and (c)(3) of this section are considered acceptable procedures for determining the flow rate. They may be used in combination, and no one procedure shall take precedence over another.

(1) *Knowledge of the wastewater.* The owner or operator may use knowledge of the wastewater stream and/or the process to determine the annual average flow rate. The owner or operator shall use the maximum expected annual average production capacity of the process unit, knowledge of the process, and/or mass balance information to either: Estimate directly the annual average wastewater flow rate; or estimate the total annual wastewater volume and then divide total volume by 525,600 minutes in a year. Where knowledge is used to determine the annual average flow rate, the owner or operator shall provide sufficient information to document the flow rate for wastewater streams determined to be Group 2 wastewater streams. Documentation to determine the annual average flow rate is not required for Group 1 streams.

(2) *Historical records.* The owner or operator may use historical records to determine the annual average flow rate. Derive the highest annual average flow rate of wastewater from historical records representing the most recent 5 years of operation or, if the process unit has been in service for less than 5 years but at least 1 year, from historical records representing the total operating life of the process unit. Where historical records are used to determine the annual average flow rate, the owner or operator shall provide sufficient information to document the flow rate for wastewater streams determined to be Group 2 wastewater streams. Documentation to determine the annual average flow rate is not required for Group 1 streams.

(3) *Measurements of flow rate.* Where an owner or operator elects to comply with paragraph (a)(1) of this section by measuring the flow rate, the owner or operator shall comply with the requirements of this paragraph. Measurements shall be made at the point of determination, or at a location downstream of the point of determination with adjustments for flow rate changes made according to paragraph (c)(4) of this section. Where measurement data are used to determine the annual average flow rate, the owner or operator shall provide sufficient information to document the flow rate for wastewater streams determined to be Group 2 wastewater streams. Documentation to determine the annual average flow rate is not required for Group 1 streams.

(4) *Adjustment for flow rates determined downstream of the point of determination.* The owner or operator shall make corrections to the annual average flow rate of a wastewater stream when it is determined downstream of the point of determination at a location where two or more wastewater streams have been mixed or one or more wastewater streams have been treated. The owner or operator shall make corrections for such changes in the annual average flow rate.

**§63.145 Process wastewater provisions—test methods and procedures to determine compliance.**

(a) *General.* This section specifies the procedures for performance tests that are conducted to demonstrate compliance of a treatment process or a control device with the control requirements specified in §63.138 of this subpart. Owners or operators conducting a design evaluation shall comply with the requirements of paragraph (a)(1) or (a)(2) of this section. Owners or operators conducting a performance test shall comply with the applicable requirements in paragraphs (a) through (i) of this section.

(1) *Performance tests and design evaluations for treatment processes.* If design steam stripper option (§63.138(d)) or RCRA option (§63.138(h)) is selected to comply with §63.138, neither a design evaluation nor a performance test is required. For any other non-biological treatment process, the owner or operator shall conduct either a design evaluation as specified in §63.138(j), or a performance test as specified in this section. For closed biological treatment processes, the owner or operator shall conduct either a design evaluation as specified in §63.138(j), or a performance test as specified in this section. For each open biological treatment process, the owner or operator shall conduct a performance test as specified in this section.

NOTE: Some open biological treatment processes may not require a performance test. Refer to §63.145(h) and table 36 of this subpart to determine whether the biological treatment process meets the criteria that exempt the owner or operator from conducting a performance test.

(2) *Performance tests and design evaluations for control devices.* The owner or operator shall conduct either a design evaluation as specified in §63.139(d), or a performance test as specified in paragraph (i) of this section for control devices other than flares and paragraph (j) of this section for flares.

(3) *Representative process unit operating conditions.* Compliance shall be demonstrated for representative operating conditions. Operations during periods of startup, shutdown, or malfunction and periods of nonoperation shall not constitute representative conditions. The owner or operator shall record the process information that is necessary to document operating conditions during the test.

(4) *Representative treatment process or control device operating conditions.* Performance tests shall be conducted when the treatment process or control device is operating at a representative inlet flow rate and concentration. If the treatment process or control device will be operating at several different sets of representative operating conditions, the owner or operator shall comply with paragraphs (a)(4)(i) and (a)(4)(ii) of this section. The owner or operator shall record information that is necessary to document treatment process or control device operating conditions during the test.

(i) *Range of operating conditions.* If the treatment process or control device will be operated at several different sets of representative operating conditions, performance testing over the entire range is not required. In such cases, the performance test results shall be supplemented with modeling and/or engineering assessments to demonstrate performance over the operating range.

(ii) *Consideration of residence time.* If concentration and/or flow rate to the treatment process or control device are not relatively constant (i.e., comparison of inlet and outlet data will not be representative of performance), the owner or operator shall consider residence time, when determining concentration and flow rate.

(5) *Testing equipment.* All testing equipment shall be prepared and installed as specified in the applicable test methods, or as approved by the Administrator.

(6) *Compounds not required to be considered in performance tests or design evaluations.* Compounds that meet the requirements specified in paragraph (a)(6)(i), (a)(6)(ii), or (a)(6)(iii)

of this section are not required to be included in the performance test. Concentration measurements based on Method 305 shall be adjusted by dividing each concentration by the compound-specific Fm factor listed in table 34 of this subpart. Concentration measurements based on methods other than Method 305 shall not be adjusted by the compound-specific Fm factor listed in table 34 of this subpart.

(i) Compounds not used or produced by the chemical manufacturing process unit; or

(ii) Compounds with concentrations at the point of determination that are below 1 part per million by weight; or

(iii) Compounds with concentrations at the point of determination that are below the lower detection limit where the lower detection limit is greater than 1 part per million by weight. The method shall be an analytical method for wastewater which has that compound as a target analyte.

(7) *Treatment using a series of treatment processes.* In all cases where the wastewater provisions in this subpart allow or require the use of a treatment process to comply with emissions limitations, the owner or operator may use multiple treatment processes. The owner or operator complying with the requirements of §63.138(a)(7)(i), when wastewater is conveyed by hard-piping, shall comply with either §§63.145(a)(7)(i) or 63.145(a)(7)(ii) of this subpart. The owner or operator complying with the requirements of §63.138(a)(7)(ii) of this subpart shall comply with the requirements of §63.145(a)(7)(ii) of this subpart.

(i) The owner or operator shall conduct the performance test across each series of treatment processes. For each series of treatment processes, inlet concentration and flow rate shall be measured either where the wastewater stream enters the first treatment process in a series of treatment processes, or prior to the first treatment process as specified in §63.145(a)(9) of this subpart. For each series of treatment processes, outlet concentration and flow rate shall be measured where the wastewater stream exits the last treatment process in the series of treatment processes, except when the last treatment process is an open or a closed aerobic biological treatment process demonstrating compliance by using the procedures in §63.145 (f) or (g) of this subpart. When the last treatment process is either an open or a closed aerobic biological treatment process demonstrating compliance by using the procedures in §63.145 (f) or (g) of this subpart, inlet and outlet concentrations and flow rates shall be measured as provided in paragraphs (a)(7)(i)(A) and (a)(7)(i)(B) of this section. The mass flow rates removed or destroyed by the series of treatment processes and by the biological treatment process are all used to calculate actual mass removal (AMR) as specified in §63.145(f)(5)(ii) of this subpart.

(A) The inlet and outlet to the series of treatment processes prior to the biological treatment process are the points at which the wastewater enters the first treatment process and exits the last treatment process in the series, respectively, except as provided in paragraph (a)(9)(ii) of this section.

(B) The inlet to the biological treatment process shall be the point at which the wastewater enters the biological treatment process or the outlet from the series of treatment processes identified in paragraph (a)(7)(i)(A) of this section, except as provided in paragraph (a)(9)(ii) of this section.

(ii) The owner or operator shall conduct the performance test across each treatment process in the series of treatment processes. The mass flow rate removed or destroyed by each treatment process shall be added together to determine whether compliance has been demonstrated using §63.145 (c), (d), (e), (f), and (g), as applicable. If a biological treatment process is one of the treatment processes in the series of treatment processes, the inlet to the biological treatment process shall be the point at which the wastewater enters the biological treatment process, or the inlet to the equalization tank if all the criteria of paragraph (a)(9)(ii) of this section are met.

(8) When using a biological treatment process to comply with §63.138 of this subpart, the owner or operator may elect to calculate the AMR using a subset of Table 8 and/or Table 9 compounds determined

at the point of determination or downstream of the point of determination with adjustment for concentration and flowrate changes made according to §63.144(b)(6) and §63.144(c)(4) of this subpart, respectively. All Table 8 and/or Table 9 compounds measured to determine the RMR, except as provided by §63.145(a)(6), shall be included in the RMR calculation.

(9) The owner or operator determining the inlet for purposes of demonstrating compliance with §63.145 (e), (f), or (g) of this subpart may elect to comply with paragraph (a)(9)(i) or (a)(9)(ii) of this section.

(i) When wastewater is conveyed exclusively by hard-piping from the point of determination to a treatment process that is either the only treatment process or the first in a series of treatment processes (i.e., no treatment processes or other waste management units are used upstream of this treatment process to store, handle, or convey the wastewater), the inlet to the treatment process shall be at any location from the point of determination to where the wastewater stream enters the treatment process. When samples are taken upstream of the treatment process and before wastewater streams have converged, the owner or operator shall ensure that the mass flow rate of all Group 1 wastewater streams is accounted for when using §63.138 (e) or (f) to comply and that the mass flow rate of all Group 1 and Group 2 wastewater streams is accounted for when using §63.138(g) to comply, except as provided in §63.145(a)(6).

(ii) The owner or operator may consider the inlet to the equalization tank as the inlet to the biological treatment process if all the criteria in paragraphs (a)(9)(ii)(A) through (a)(9)(ii)(C) of this section are met. The outlet from the series of treatment processes prior to the biological treatment process is the point at which the wastewater exits the last treatment process in the series prior to the equalization tank, if the equalization tank and biological treatment process are part of a series of treatment processes. The owner or operator shall ensure that the mass flow rate of all Group 1 wastewater streams is accounted for when using §63.138 (e) or (f) to comply and that the mass flow rate of all Group 1 and Group 2 wastewater streams is accounted for when using §63.138(g) to comply, except as provided in §63.145(a)(6).

(A) The wastewater is conveyed by hard-piping from either the last previous treatment process or the point of determination to the equalization tank.

(B) The wastewater is conveyed from the equalization tank exclusively by hard-piping to the biological treatment process and no treatment processes or other waste management units are used to store, handle, or convey the wastewater between the equalization tank and the biological treatment process.

(C) The equalization tank is equipped with a fixed roof and a closed vent system that routes emissions to a control device that meets the requirements of §63.133(a)(2)(i) and §63.133 (b)(1) through (b)(4) of this subpart.

(b) *Noncombustion treatment process—concentration limits.* This paragraph applies to performance tests that are conducted to demonstrate compliance of a noncombustion treatment process with the parts per million by weight wastewater stream concentration limits at the outlet of the treatment process. This compliance option is specified in §63.138(b)(1) and §63.138(c)(1). Wastewater samples shall be collected using sampling procedures which minimize loss of organic compounds during sample collection and analysis and maintain sample integrity per §63.144(b)(5)(ii). Samples shall be collected and analyzed using the procedures specified in §63.144 (b)(5)(i), (b)(5)(ii), and (b)(5)(iii) of this subpart. Samples may be grab samples or composite samples. Samples shall be taken at approximately equally spaced time intervals over a 1-hour period. Each 1-hour period constitutes a run, and the performance test shall consist of a minimum of 3 runs. Concentration measurements based on Method 305 may be adjusted by dividing each concentration by the compound-specific Fm factor listed in Table 34 of this subpart. Concentration measurements based on methods other than Method 305 may be adjusted by multiplying each concentration by the compound-specific Fm factor listed in table 34 of this subpart. (For wastewater



streams that are Group 1 for both Table 8 and Table 9 compounds, compliance is demonstrated only if the sum of the concentrations of Table 9 compounds is less than 50 ppmw, and the concentration of each Table 8 compound is less than 10 ppmw.)

(c) *Noncombustion, nonbiological treatment process: Percent mass removal/destruction option.* This paragraph applies to performance tests that are conducted to demonstrate compliance of a noncombustion, nonbiological treatment process with the percent mass removal limits specified in §63.138(e) (1) and (2) for Table 8 and/or Table 9 compounds. The owner or operator shall comply with the requirements specified in §63.145 (c)(1) through (c)(6) of this subpart.

(1) *Concentration.* The concentration of Table 8 and/or Table 9 compounds entering and exiting the treatment process shall be determined as provided in this paragraph. Wastewater samples shall be collected using sampling procedures which minimize loss of organic compounds during sample collection and analysis and maintain sample integrity per §63.144(b)(5)(ii). The method shall be an analytical method for wastewater which has that compound as a target analyte. Samples may be grab samples or composite samples. Samples shall be taken at approximately equally spaced time intervals over a 1-hour period. Each 1-hour period constitutes a run, and the performance test shall consist of a minimum of 3 runs. Concentration measurements based on Method 305 shall be adjusted by dividing each concentration by the compound-specific Fm factor listed in Table 34 of this subpart. Concentration measurements based on methods other than Method 305 shall not adjust by the compound-specific Fm factor listed in Table 34 of this subpart.

(2) *Flow rate.* The flow rate of the entering and exiting wastewater streams shall be determined using inlet and outlet flow measurement devices, respectively. Where the outlet flow is not greater than the inlet flow, a flow measurement device shall be used, and may be used at either the inlet or outlet. Flow rate measurements shall be taken at the same time as the concentration measurements.

(3) *Calculation of mass flow rate—for noncombustion, nonbiological treatment processes.* The mass flow rates of Table 8 and/or Table 9 compounds entering and exiting the treatment process are calculated as follows.

$$QMW_a = \frac{\rho}{p * 10^6} \left( \sum_{k=1}^p Q_{a,k} C_{T,a,k} \right) \quad (Eqn WW1)$$

$$QMW_b = \frac{\rho}{p * 10^6} \left( \sum_{k=1}^p Q_{b,k} C_{T,b,k} \right) \quad (Eqn WW2)$$

Where:

$QMW_a$ ,  $QMW_b$  = Mass flow rate of Table 8 or Table 9 compounds, average of all runs, in wastewater entering ( $QMW_a$ ) or exiting ( $QMW_b$ ) the treatment process, kilograms per hour.

$\rho$  = Density of the wastewater, kilograms per cubic meter.

$Q_{a,k}$ ,  $Q_{b,k}$  = Volumetric flow rate of wastewater entering ( $Q_{a,k}$ ) or exiting ( $Q_{b,k}$ ) the treatment process during each run k, cubic meters per hour.

$C_{T,a,k}$ ,  $C_{T,b,k}$  = Total concentration of Table 8 or Table 9 compounds in wastewater entering ( $C_{T,a,k}$ ) or exiting ( $C_{T,b,k}$ ) the treatment process during each run k, parts per million by weight.

p = Number of runs.

k = Identifier for a run.

10<sup>6</sup> = conversion factor, mg/kg

(4) *Percent removal calculation for mass flow rate.* The percent mass removal across the treatment process shall be calculated as follows:

$$E = \frac{QMW_a - QMW_b}{QMW_a} \times 100 \quad (\text{Eqn WW3})$$

Where:

E = Removal or destruction efficiency of the treatment process, percent.

QMW<sub>a</sub>, QMW<sub>b</sub> = Mass flow rate of Table 8 or Table 9 compounds in wastewater entering (QMW<sub>a</sub>) and exiting (QMW<sub>b</sub>) the treatment process, kilograms per hour (as calculated using Equations WW1 and WW2).

(5) *Calculation of flow-weighted average of Fr values.* If complying with §63.138(e)(2), use Equation WW8 to calculate the flow-weighted average of the Fr values listed in Table 9 of this subpart. When the term “combustion” is used in Equation WW8, the term “treatment process” shall be used for the purposes of this paragraph.

(6) *Compare mass removal efficiency to required efficiency.* Compare the mass removal efficiency (calculated in Equation WW3) to the required efficiency as specified in §63.138(e) of this subpart. If complying with §63.138(e)(1), compliance is demonstrated if the mass removal efficiency is 99 percent or greater. If complying with §63.138(e)(2), compliance is demonstrated if the mass removal efficiency is greater than or equal to the flow-weighted average of the Fr values calculated in Equation WW8.

(d) *Combustion treatment processes: percent mass removal/destruction option.* This paragraph applies to performance tests that are conducted to demonstrate compliance of a combustion treatment process with the percent mass destruction limits specified in §63.138(e) (1) and (2) for Table 9 compounds, and/or §63.138(e)(1) for Table 8 compounds. The owner or operator shall comply with the requirements specified in §63.145 (d)(1) through (d)(9) of this subpart. (Wastewater streams that are Group 1 for both Table 8 and Table 9 compounds need only do the compliance demonstration for Table 9 compounds.)

(1) *Concentration in wastewater stream entering the combustion treatment process.* The concentration of Table 8 and/or Table 9 compounds entering the treatment process shall be determined as provided in this paragraph. Wastewater samples shall be collected using sampling procedures which minimize loss of organic compounds during sample collection and analysis and maintain sample integrity per §63.144(b)(5)(ii). The method shall be an analytical method for wastewater which has that compound as a target analyte. Samples may be grab samples or composite samples. Samples shall be taken at approximately equally spaced time intervals over a 1-hour period. Each 1-hour period constitutes a run, and the performance test shall consist of a minimum of 3 runs. Concentration measurements based on Method 305 of appendix A of this part shall be adjusted by dividing each concentration by the compound-specific Fm factor listed in table 34 of this subpart. Concentration measurements based on methods other than Method 305 shall not adjust by the compound-specific Fm factor listed in table 34 of this subpart.

(2) *Flow rate of wastewater entering the combustion treatment process.* The flow rate of the wastewater stream entering the combustion treatment process shall be determined using an inlet flow meter. Flow rate measurements shall be taken at the same time as the concentration measurements.

(3) *Calculation of mass flow rate in wastewater stream entering combustion treatment processes.* The mass flow rate of Table 8 and/or Table 9 compounds entering the treatment process is calculated as follows:

$$QMW_a = \frac{\rho}{p * 10^6} \left( \sum_{k=1}^p Q_{a,k} * C_{T,a,k} \right) \quad (\text{Eqn WW4})$$

Where:

$QMW_a$  = Mass flow rate of Table 8 or Table 9 compounds entering the combustion unit, kilograms per hour.

$\rho$  = Density of the wastewater stream, kilograms per cubic meter.

$Q_{a,k}$  = Volumetric flow rate of wastewater entering the combustion unit during run k, cubic meters per hour.

$C_{T,a,k}$  = Total concentration of Table 8 or Table 9 compounds in the wastewater stream entering the combustion unit during run k, parts per million by weight.

$p$  = Number of runs.

$k$  = Identifier for a run.

(4) *Concentration in vented gas stream exiting the combustion treatment process.* The concentration of Table 8 and/or Table 9 compounds exiting the combustion treatment process in any vented gas stream shall be determined as provided in this paragraph. Samples may be grab samples or composite samples. Samples shall be taken at approximately equally spaced time intervals over a 1-hour period. Each 1-hour period constitutes a run, and the performance test shall consist of a minimum of 3 runs. Concentration measurements shall be determined using Method 18 of 40 CFR part 60, appendix A. Alternatively, any other test method validated according to the procedures in Method 301 of appendix A of this part may be used.

(5) *Volumetric flow rate of vented gas stream exiting the combustion treatment process.* The volumetric flow rate of the vented gas stream exiting the combustion treatment process shall be determined using Method 2, 2A, 2C, or 2D of 40 CFR part 60, appendix A, as appropriate. Volumetric flow rate measurements shall be taken at the same time as the concentration measurements.

(6) *Calculation of mass flow rate of vented gas stream exiting combustion treatment processes.* The mass flow rate of Table 8 and/or Table 9 compounds in a vented gas stream exiting the combustion treatment process shall be calculated as follows:

(Eqn WW5) [Reserved]

$$QMG_b = K_2 \left( \sum_{i=1}^n CG_{b,i} MW_i \right) QG_b \quad (\text{Eqn WW6})$$

Where:

$CG_{a,i}, CG_{b,i}$  = Concentration of total organic compounds (TOC) (minus methane and ethane) or total organic hazardous air pollutants, in vented gas stream, entering ( $CG_{a,i}$ ) and exiting ( $CG_{b,i}$ ) the control device, dry basis, parts per million by volume.

$QMG_a, QMG_b$  = Mass rate of TOC (minus methane and ethane) or total organic hazardous air pollutants, in vented gas stream, entering ( $QMG_a$ ) and exiting ( $QMG_b$ ) the control device, dry basis, kilograms per hour.

$MW_i$  = Molecular weight of a component, kilogram/kilogram-mole.

$QG_a, QG_b$  = Flow rate of gas stream entering ( $QG_a$ ) and exiting ( $QG_b$ ) the control device, dry standard cubic meters per hour.

$K_2$  = Constant,  $41.57 \times 10^{-9}$  (parts per million)<sup>-1</sup> (gram-mole per standard cubic meter) (kilogram/gram), where standard temperature (gram-mole per standard cubic meter) is 20 °Celsius.

$i$  = Identifier for a compound.

$n$  = Number of components in the sample.

(7) *Destruction efficiency calculation.* The destruction efficiency of the combustion unit for Table 8 and/or Table 9 compounds shall be calculated as follows:

$$E = \frac{QMW_a - QMG_b}{QMW_a} * 100 \quad (\text{Eqn WW7})$$

Where:

$E$  = Destruction efficiency of Table 8 or Table 9 compounds for the combustion unit, percent.

$QMW_a$  = Mass flow rate of Table 8 or Table 9 compounds entering the combustion unit, kilograms per hour.

$QMG_b$  = Mass flow rate of Table 8 or Table 9 compounds in vented gas stream exiting the combustion treatment process, kilograms per hour.

(8) *Calculation of flow-weighted average of Fr values.* Use Equation WW8 to calculate the flow-weighted average of the Fr values listed in table 9 of this subpart.

$$Fr_{avg} = \left[ \frac{\sum_{i=1}^n \sum_{k=1}^p Fr_i * C_{i,a,k} * Q_{a,k}}{\sum_{k=1}^p \sum_{i=1}^n C_{i,a,k} * Q_{a,k}} \right] * 100 \quad (\text{Eqn WW8})$$

Where:

$Fr_{avg}$  = Flow-weighted average of the Fr values.

$C_{i,a,k}$  = Concentration of Table 8 and/or Table 9 compounds in wastewater stream entering the combustion unit, during run  $k$ , parts per million by weight.

$Q_{a,k}$  = Volumetric flow rate of wastewater entering the combustion unit during run  $k$ , cubic meters per hour.

$Fr_i$  = Compound-specific Fr value listed in table 9 of this subpart.

(9) *Calculate flow-weighted average of Fr values and compare to mass destruction efficiency.* Compare the mass destruction efficiency (calculated in Equation WW 7) to the required efficiency as specified in §63.138(e). If complying with §63.138(e)(1), compliance is demonstrated if the mass destruction efficiency is 99 percent or greater. If complying with §63.138(e)(2), compliance is demonstrated if the mass destruction efficiency is greater than or equal to the flow-weighted average of the Fr value calculated in Equation WW8.

(e) *Non-combustion treatment processes including closed biological treatment processes: RMR option.* This paragraph applies to performance tests for non-combustion treatment processes other than open biological treatment processes to demonstrate compliance with the mass removal provisions for Table 8 and/or Table 9 compounds. Compliance options for noncombustion treatment processes are specified in §63.138(f) of this subpart. Compliance options for closed aerobic or anaerobic biological treatment processes are specified in §63.138(f) and §63.138(g) of this subpart. When complying with

§63.138(f), the owner or operator shall comply with the requirements specified in §63.145(e)(1) through (e)(6) of this subpart. When complying with §63.138(g), the owner or operator shall comply with the requirements specified in §63.145(e)(1) through (e)(6) of this subpart. (Wastewater streams that are Group 1 for both Table 8 and Table 9 compounds need only do the compliance demonstration for Table 9 compounds.)

(1) *Concentration in wastewater stream.* The concentration of Table 8 and/or Table 9 compounds shall be determined as provided in this paragraph. Concentration measurements to determine RMR shall be taken at the point of determination or downstream of the point of determination with adjustment for concentration change made according to §63.144(b)(6) of this subpart. Concentration measurements to determine AMR shall be taken at the inlet and outlet to the treatment process and as provided in §63.145(a)(7) for a series of treatment processes. Wastewater samples shall be collected using sampling procedures which minimize loss of organic compounds during sample collection and analysis and maintain sample integrity per §63.144(b)(5)(ii). The method shall be an analytical method for wastewater which has that compound as a target analyte. Samples may be grab samples or composite samples. Samples shall be taken at approximately equally spaced time intervals over a 1-hour period. Each 1-hour period constitutes a run, and the performance test shall consist of a minimum of 3 runs. Concentration measurements based on Method 305 shall be adjusted by dividing each concentration by the compound-specific Fm factor listed in table 34 of this subpart. Concentration measurements based on methods other than Method 305 shall not adjust by the compound-specific Fm factor listed in table 34 of this subpart.

(2) *Flow rate.* Flow rate measurements to determine RMR shall be taken at the point of determination or downstream of the point of determination with adjustment for flow rate change made according to §63.144(c)(4) of this subpart. Flow rate measurements to determine AMR shall be taken at the inlet and outlet to the treatment process and as provided in §63.145(a)(7) for a series of treatment processes. Flow rate shall be determined using inlet and outlet flow measurement devices. Where the outlet flow is not greater than the inlet flow, a flow measurement device shall be used, and may be used at either the inlet or outlet. Flow rate measurements shall be taken at the same time as the concentration measurements.

(3) *Calculation of RMR for non-combustion treatment processes including closed biological treatment processes.* When using §63.138(f) to comply, the required mass removal of Table 8 and/or Table 9 compounds for each Group 1 wastewater stream shall be calculated as specified in paragraph (e)(3)(i) of this section. When using §63.138(g) to comply, the required mass removal shall be calculated as specified in paragraph (e)(3)(ii) of this section.

(i) When using §63.138(f) to comply, the required mass removal of Table 8 and/or Table 9 compounds for each Group 1 wastewater stream shall be calculated using Equation WW9.

$$RMR = \frac{\rho}{10^9} Q \sum_{i=1}^n (C_i * Fr_i) \quad (\text{Eqn WW9})$$

[View or download PDF](#)

Where:

RMR = Required mass removal for treatment process or series of treatment processes, kilograms per hour.

$\rho$  = Density of the Group 1 wastewater stream, kilograms per cubic meter.

Q = Volumetric flow rate of wastewater stream at the point of determination, liters per hour.

i = Identifier for a compound.

n = Number of Table 8 or Table 9 compounds in stream.

C<sub>i</sub> = Concentration of Table 8 or Table 9 compounds at the point of determination, parts per million by weight.

Fr<sub>i</sub> = Fraction removal value of a Table 8 or Table 9 compound. Fr values are listed in table 9 of this subpart.

10<sup>9</sup> = Conversion factor, mg/kg \* l/m<sup>3</sup>.

(ii) When using §63.138(g) to comply, the required mass removal is 95 percent of the mass flow rate for all Group 1 and Group 2 wastewater streams combined for treatment. The required mass removal of Table 8 and/or Table 9 compounds for all Group 1 and Group 2 wastewater streams combined for treatment when complying with §63.138(g) shall be calculated using the following equation:

$$RMR = \frac{0.95\rho}{10^9} Q \sum_{i=1}^n (C_i) \quad (\text{Eqn WW9a})$$

Where:

RMR = Required mass removal for treatment process or series of treatment processes, kilograms per hour.

ρ = Density of the Group 1 wastewater stream, kilograms per cubic meter.

Q = Volumetric flow rate of wastewater stream at the point of determination, liters per hour.

i = Identifier for a compound.

n = Number of Table 8 or Table 9 compounds in stream.

C<sub>i</sub> = Concentration of Table 8 or Table 9 compounds at the point of determination, parts per million by weight.

10<sup>9</sup> = Conversion factor, mg/kg \* l/m<sup>3</sup>

(4)(i) The required mass removal is calculated by summing the required mass removal for each Group 1 wastewater stream to be combined for treatment when complying with §63.138(f).

(ii) The required mass removal is calculated by summing the required mass removal for all Group 1 and Group 2 wastewater streams combined for treatment when complying with §63.138(g).

(5) *The AMR calculation procedure for non-combustion treatment processes including closed biological treatment processes.* The AMR shall be calculated as follows:

$$AMR = (QMW_a - QMW_b) \quad (\text{Eqn WW10})$$

Where:

AMR = Actual mass removal of Table 8 or Table 9 compounds achieved by treatment process or series of treatment processes, kilograms per hour.

QMW<sub>a</sub> = Mass flow rate of Table 8 or Table 9 compounds in wastewater entering the treatment process or first treatment process in a series of treatment processes, kilograms per hour.

QMW<sub>b</sub> = Mass flow rate of Table 8 or Table 9 compounds in wastewater exiting the last treatment process in a series of treatment processes, kilograms per hour.

(6) *Compare RMR to AMR.* When complying with §63.138(f), compare the RMR calculated in Equation WW9 to the AMR calculated in Equation WW10. Compliance is demonstrated if the AMR is

greater than or equal to the RMR. When complying with §63.138(g), compare the RMR calculated in Equation WW-9a to the AMR calculated in Equation WW10. Compliance is demonstrated if the AMR is greater than or equal to 95-percent mass removal.

(f) *Open or closed aerobic biological treatment processes: Required mass removal (RMR) option.* This paragraph applies to the use of performance tests that are conducted for open or closed aerobic biological treatment processes to demonstrate compliance with the mass removal provisions for Table 8 and/or Table 9 compounds. These compliance options are specified in §63.138(f) of this subpart. The owner or operator shall comply with the requirements specified in §63.145 (f)(1) through (f)(6) of this subpart. Some compounds may not require a performance test. Refer to §63.145(h) and table 36 of this subpart to determine which compounds may be exempt from the requirements of this paragraph.

(1) *Concentration in wastewater stream.* The concentration of Table 8 and/or Table 9 compounds shall be determined as provided in this paragraph. Concentration measurements to determine RMR shall be taken at the point of determination or downstream of the point of determination with adjustment for concentration change made according to §63.144(b)(6) of this subpart. Concentration measurements to determine AMR shall be taken at the inlet and outlet to the treatment process and as provided in §63.145(a)(7) for a series of treatment processes. Wastewater samples shall be collected using sampling procedures which minimize loss of organic compounds during sample collection and analysis and maintain sample integrity per §63.144(b)(5)(ii). The method shall be an analytical method for wastewater which has that compound as a target analyte. Samples may be grab samples or composite samples. Samples shall be taken at approximately equally spaced time intervals over a 1-hour period. Each 1-hour period constitutes a run, and the performance test shall consist of a minimum of 3 runs. Concentration measurements based on Method 305 shall be adjusted by dividing each concentration by the compound-specific Fm factor listed in table 34 of this subpart. Concentration measurements based on methods other than Method 305 shall not adjust by the compound-specific Fm factor listed in table 34 of this subpart.

(2) *Flow rate.* Flow rate measurements to determine RMR shall be taken at the point of determination or downstream of the point of determination with adjustment for flow rate change made according to §63.144(c)(4) of this subpart. Flow rate measurements to determine AMR shall be taken at the inlet and outlet to the treatment process and as provided in §63.145(a)(7) for a series of treatment processes. Flow rate shall be determined using inlet and outlet flow measurement devices. Where the outlet flow is not greater than the inlet flow, a flow measurement device shall be used, and may be used at either the inlet or outlet. Flow rate measurements shall be taken at the same time as the concentration measurements.

(3) *Calculation of RMR for open or closed aerobic biological treatment processes.* The required mass removal of Table 8 and/or Table 9 compounds for each Group 1 wastewater stream shall be calculated using the following equation:

$$RMR = \frac{\rho}{10^9} Q \sum_{i=1}^n (C_i * Fr_i) \quad (\text{Eqn WW11})$$

Where:

RMR = Required mass removal for treatment process or series of treatment processes, kilograms per hour.

$\rho$  = Density of the Group 1 wastewater stream, kilograms per cubic meter.

Q = Volumetric flow rate of wastewater stream at the point of determination, liters per hour.

i = Identifier for a compound.

n = Number of Table 8 or Table 9 compounds in stream.

$C_i$  = Concentration of Table 8 or Table 9 compounds at the point of determination, parts per million by weight.

$F_r$  = Fraction removal value of a Table 8 or Table 9 compound.  $F_r$  values are listed in table 9 of this subpart.

$10^9$  = Conversion factor, mg/kg \* l/m<sup>3</sup>.

(4) The required mass removal is calculated by adding together the required mass removal for each Group 1 wastewater stream to be combined for treatment.

(5) *Actual mass removal calculation procedure for open or closed aerobic biological treatment processes.* The actual mass removal (AMR) shall be calculated using Equation WW12 as specified in paragraph (f)(5)(i) of this section when the performance test is performed across the open or closed aerobic biological treatment process only. If compliance is being demonstrated in accordance with §63.145(a)(7)(i), the AMR for the series shall be calculated using Equation WW13 in §63.145(f)(5)(ii). (This equation is for situations where treatment is performed in a series of treatment processes connected by hard-piping.) If compliance is being demonstrated in accordance with §63.145(a)(7)(ii), the AMR for the biological treatment process shall be calculated using Equation WW12 in §63.145(f)(5)(i). The AMR for the biological treatment process used in a series of treatment processes calculated using Equation WW12 shall be added to the AMR determined for each of the other individual treatment processes in the series of treatment processes.

(i) Calculate AMR for the open or closed aerobic biological treatment process as follows:

$$AMR = QMW_a * F_{bio} \quad (Eqn WW12)$$

Where:

AMR = Actual mass removal of Table 8 or Table 9 compounds achieved by open or closed biological treatment process, kilograms per hour.

$QMW_a$  = Mass flow rate of Table 8 or Table 9 compounds in wastewater entering the treatment process, kilograms per hour.

$F_{bio}$  = Site-specific fraction of Table 8 or Table 9 compounds biodegraded.  $F_{bio}$  shall be determined as specified in §63.145(h) and appendix C of this subpart.

(ii) Calculate AMR across a series of treatment units where the last treatment unit is an open or closed aerobic biological treatment process as follows:

$$AMR = QMW_a - (QMW_b)(1 - F_{bio}) \quad (Eqn WW13)$$

Where:

AMR = Actual mass removal of Table 8 or Table 9 compounds achieved by a series of treatment processes, kilograms per hour.

$QMW_a$  = Mass flow rate of Table 8 or Table 9 compounds in wastewater entering the first treatment process in a series of treatment processes, kilograms per hour.

$QMW_b$  = Mass flow rate of Table 8 or Table 9 compounds in wastewater exiting the last treatment process in a series of treatment processes prior to the biological treatment process, kilograms per hour.

$F_{bio}$  = Site-specific fraction of Table 8 or Table 9 compounds biodegraded.  $F_{bio}$  shall be determined as specified in §63.145(h) and appendix C of this subpart.



(6) *Compare RMR to AMR.* Compare the RMR calculated in Equation WW11 to the AMR calculated in either Equation WW12 or WW13, as applicable. Compliance is demonstrated if the AMR is greater than or equal to the RMR.

(g) *Open or closed aerobic biological treatment processes: 95-percent mass removal option.* This paragraph applies to performance tests that are conducted for open or closed aerobic biological treatment processes to demonstrate compliance with the 95-percent mass removal provisions for Table 8 and/or Table 9 compounds. This compliance option is specified in §63.138(g) of this subpart. The RMR for this option is 95-percent mass removal. The owner or operator shall comply with the requirements specified in §63.145(g)(1) to determine AMR, §63.145 (e)(3)(ii) and (e)(4)(ii) to determine RMR, and (g)(2) of this subpart to determine whether compliance has been demonstrated. Some compounds may not require a performance test. Refer to §63.145(h) and table 36 of this subpart to determine which compounds may be exempt from the requirements of this paragraph. (Wastewater streams that are Group 1 for both Table 8 and Table 9 compounds need only do the compliance demonstration for Table 9 compounds.)

(1) The owner or operator shall comply with the requirements specified in paragraphs (f)(1), (f)(2), and (f)(5) of this section to determine AMR. References to Group 1 wastewater streams shall be deemed Group 1 and Group 2 wastewater streams for the purposes of this paragraph.

(2) *Compare RMR to AMR.* Compliance is demonstrated if the AMR is greater than or equal to RMR.

(h) *Site-specific fraction biodegraded ( $F_{bio}$ ).* The compounds listed in table 9 of this subpart are divided into two sets for the purpose of determining whether  $F_{bio}$  must be determined, and if  $F_{bio}$  must be determined, which procedures may be used to determine compound-specific kinetic parameters. These sets are designated as lists 1 and 2 in table 36 of this subpart.

(1) *Performance test exemption.* If a biological treatment process meets the requirements specified in paragraphs (h)(1)(i) and (h)(1)(ii) of this section, the owner or operator is not required to determine  $F_{bio}$  and is exempt from the applicable performance test requirements specified in §63.138 of this subpart.

(i) The biological treatment process meets the definition of “enhanced biological treatment process” in §63.111 of this subpart.

(ii) At least 99 percent by weight of all compounds on table 36 of this subpart that are present in the aggregate of all wastewater streams using the biological treatment process to comply with §63.138 of this subpart are compounds on list 1 of table 36 of this subpart.

(2)  $F_{bio}$  determination. If a biological treatment process does not meet the requirement specified in paragraph (h)(1)(i) of this section, the owner or operator shall determine  $F_{bio}$  for the biological treatment process using the procedures in appendix C to part 63, and paragraph (h)(2)(ii) of this section. If a biological treatment process meets the requirements of paragraph (h)(1)(i) of this section but does not meet the requirement specified in paragraph (h)(1)(ii) of this section, the owner or operator shall determine  $F_{bio}$  for the biological treatment process using the procedures in appendix C to part 63, and paragraph (h)(2)(i) of this section.

(i) *Enhanced biological treatment processes.* If the biological treatment process meets the definition of “enhanced biological treatment process” in §63.111 of this subpart and the wastewater streams include one or more compounds on list 2 of table 36 of this subpart that do not meet the criteria in paragraph (h)(1)(ii) of this section, the owner or operator shall determine  $f_{bio}$  for the list 2 compounds using any of the procedures specified in appendix C of 40 CFR part 63. (The symbol “ $f_{bio}$ ” represents the site specific fraction of an individual Table 8 or Table 9 compound that is biodegraded.) The owner or operator shall calculate  $f_{bio}$  for the list 1 compounds using the defaults for first order biodegradation rate constants ( $K_1$ ) in

table 37 of subpart G and follow the procedure explained in form III of appendix C, 40 CFR part 63, or any of the procedures specified in appendix C, 40 CFR part 63.

(ii) *Biological treatment processes that are not enhanced biological treatment processes.* For biological treatment processes that do not meet the definition for “enhanced biological treatment process” in §63.111 of this subpart, the owner or operator shall determine the  $f_{\text{bio}}$  for the list 1 and 2 compounds using any of the procedures in appendix C to part 63, except procedure 3 (inlet and outlet concentration measurements). (The symbol “ $f_{\text{bio}}$ ” represents the site specific fraction of an individual Table 8 or Table 9 compound that is biodegraded.)

(i) *Performance tests for control devices other than flares.* This paragraph applies to performance tests that are conducted to demonstrate compliance of a control device with the efficiency limits specified in §63.139(c). If complying with the 95-percent reduction efficiency requirement, comply with the requirements specified in paragraphs (i)(1) through (i)(9) of this section. If complying with the 20 ppm by volume requirement, comply with the requirements specified in paragraphs (i)(1) through (i)(6) and (i)(9) of this section. The 20 ppm by volume limit or 95-percent reduction efficiency requirement shall be measured as either total organic hazardous air pollutants or as TOC minus methane and ethane.

(1) *Sampling sites.* Sampling sites shall be selected using Method 1 or 1A of 40 CFR part 60, appendix A, as appropriate. For determination of compliance with the 95 percent reduction requirement, sampling sites shall be located at the inlet and the outlet of the control device. For determination of compliance with the 20 parts per million by volume limit, the sampling site shall be located at the outlet of the control device.

(2) *Concentration in gas stream entering or exiting the control device.* The concentration of total organic hazardous air pollutants or TOC in a gas stream shall be determined as provided in this paragraph. Samples may be grab samples or composite samples (i.e., integrated samples). Samples shall be taken at approximately equally spaced time intervals over a 1-hour period. Each 1-hour period constitutes a run, and the performance test shall consist of a minimum of 3 runs. Concentration measurements shall be determined using Method 18 of 40 CFR part 60, appendix A. Alternatively, any other test method validated according to the procedures in Method 301 of appendix A of this part may be used.

(3) *Volumetric flow rate of gas stream entering or exiting the control device.* The volumetric flow rate of the gas stream shall be determined using Method 2, 2A, 2C, or 2D of 40 CFR part 60, appendix A, as appropriate. Volumetric flow rate measurements shall be taken at the same time as the concentration measurements.

(4) *Calculation of TOC concentration.* The TOC concentration ( $CG_{\tau}$ ) is the sum of the concentrations of the individual components. If compliance is being determined based on TOC, the owner or operator shall compute TOC for each run using the following equation:

$$CG_{\tau} = \frac{1}{m} \sum_{j=1}^m \left( \sum_{i=1}^n CGS_{i,j} \right) \quad (\text{Eqn WW14})$$

Where:

$CG_{\tau}$  = Total concentration of TOC (minus methane and ethane) in vented gas stream, average of samples, dry basis, parts per million by volume.

$CGS^j$  = Concentration of sample components in vented gas stream for sample  $j$ , dry basis, parts per million by volume.

$i$  = Identifier for a compound.

n = Number of components in the sample.

j = Identifier for a sample.

m = Number of samples in the sample run.

(5) *Calculation of total organic hazardous air pollutants concentration.* The owner or operator determining compliance based on total organic hazardous air pollutants concentration ( $C_{\text{HAP}}$ ) shall compute  $C_{\text{HAP}}$  according to the Equation WW14, except that only Table 9 compounds shall be summed.

(6) *Percent oxygen correction for combustion control devices.* If the control device is a combustion device, comply with the requirements specified in paragraph (i)(6)(i) of this section to determine oxygen concentration, and in paragraph (i)(6)(ii) of this section to calculate the percent oxygen correction.

(i) *Oxygen concentration.* The concentration of TOC or total organic hazardous air pollutants shall be corrected to 3 percent oxygen if the control device is a combustion device. The emission rate correction factor for excess air, composite sampling (i.e., integrated sampling) and analysis procedures of Method 3B of 40 CFR part 60, appendix A shall be used to determine the actual oxygen concentration ( $\%O_{2d}$ ). The samples shall be taken during the same time that the TOC (minus methane or ethane) or total organic hazardous air pollutants samples are taken.

(ii) *3 percent oxygen calculation.* The concentration corrected to 3 percent oxygen ( $CG_c$ ), when required, shall be computed using the following equation:

$$CG_c = CG_T \left( \frac{17.9}{20.9 - \%O_{2d}} \right) \quad (\text{Eqn WW15})$$

Where:

$CG_c$  = Concentration of TOC or organic hazardous air pollutants corrected to 3 percent oxygen, dry basis, parts per million by volume.

$CG_T$  = Total concentration of TOC (minus methane and ethane) in vented gas stream, average of samples, dry basis, parts per million by volume.

$\%O_{2d}$  = Concentration of oxygen measured in vented gas stream, dry basis, percent by volume.

(7) *Mass rate calculation.* The mass rate of either TOC (minus methane and ethane) or total organic hazardous air pollutants shall be calculated using the following equations. Where the mass rate of TOC is being calculated, all organic compounds (minus methane and ethane) measured by methods specified in paragraph (i)(2) of this section are summed using Equations WW16 and WW17. Where the mass rate of total organic hazardous air pollutants is being calculated, only Table 9 compounds shall be summed using Equations WW16 and WW17.

$$QMG_a = K_2 \left( \sum_{i=1}^n CG_{aj} MW_i \right) QG_a \quad (\text{Eqn WW16})$$

$$QMG_b = K_2 \left( \sum_{i=1}^n CG_{bj} MW_i \right) QG_b \quad (\text{Eqn WW17})$$

Where:

$CG_{a,i}$ ,  $CG_{b,i}$  = Concentration of TOC (minus methane and ethane) or total organic hazardous air pollutants, in vented gas stream, entering ( $CG_{a,i}$ ) and exiting ( $CG_{b,i}$ ) the control device, dry basis, parts per million by volume.

$QMG_a$ ,  $QMG_b$  = Mass rate of TOC (minus methane and ethane) or total organic hazardous air pollutants, in vented gas stream, entering ( $QMG_a$ ) and exiting ( $QMG_b$ ) the control device, dry basis, kilograms per hour.

$MW_i$  = Molecular weight of a component, kilogram/kilogram-mole.

$QG_a$ ,  $QG_b$  = Flow rate of gas stream entering ( $QG_a$ ) and exiting ( $QG_b$ ) the control device, dry standard cubic meters per hour.

$K_2$  = Constant,  $41.57 \times 10^{-9}$  (parts per million)<sup>-1</sup> (gram-mole per standard cubic meter) (kilogram/gram), where standard temperature (gram-mole per standard cubic meter) is 20 °Celsius.

$i$  = Identifier for a compound.

$n$  = Number of components in the sample.

(8) *Percent reduction calculation.* The percent reduction in TOC (minus methane and ethane) or total organic hazardous air pollutants shall be calculated as follows:

$$E = \frac{QMG_a - QMG_b}{QMG_a} (100\%) \quad (\text{Eqn WW18})$$

Where:

$E$  = Destruction efficiency of control device, percent.

$QMG_a$ ,  $QMG_b$  = Mass rate of TOC (minus methane and ethane) or total organic hazardous air pollutants, in vented gas stream entering and exiting ( $QMG_b$ ) the control device, dry basis, kilograms per hour.

(9) *Compare mass destruction efficiency to required efficiency.* If complying with the 95 percent reduction efficiency requirement, compliance is demonstrated if the mass destruction efficiency (calculated in Equation WW18) is 95 percent or greater. If complying with the 20 parts per million by volume limit in §63.139 (c)(1)(ii) of this subpart, compliance is demonstrated if the outlet total organic compound concentration, less methane and ethane, or total organic hazardous air pollutants concentration is 20 parts per million by volume, or less. For combustion control devices, the concentration shall be calculated on a dry basis, corrected to 3 percent oxygen.

(j) When a flare is used to comply with §63.139(c), the owner or operator shall comply with paragraphs (j)(1) through (3) of this section. The owner or operator is not required to conduct a performance test to determine percent emission reduction or outlet organic HAP or TOC concentration.

(1) Conduct a visible emission test using the techniques specified in §63.11(b)(4).

(2) Determine the net heating value of the gas being combusted using the techniques specified in §63.11(b)(6).

(3) Determine the exit velocity using the techniques specified in either §63.11(b)(7)(i) (and §63.11(b)(7)(iii), where applicable) or §63.11(b)(8), as appropriate.

[62 FR 2765, Jan. 17, 1997, as amended at 63 FR 67793, Dec. 9, 1998; 64 FR 20192, Apr. 26, 1999; 66 FR 6933, Jan. 22, 2001]

#### **§63.146 Process wastewater provisions—reporting.**

(a) For each waste management unit, treatment process, or control device used to comply with §§63.138 (b)(1), (c)(1), (d), (e), (f), or (g) of this subpart for which the owner or operator seeks to monitor a parameter other than those specified in table 11, table 12, or table 13 of this subpart, the owner or operator shall submit a request for approval to monitor alternative parameters according to the procedures specified in §63.151(f) or (g) of this subpart.

(b) The owner or operator shall submit the information specified in paragraphs (b)(1) through (b)(9) of this section as part of the Notification of Compliance Status required by §63.152(b) of this subpart.

(1) *Requirements for Group 2 wastewater streams.* This paragraph does not apply to Group 2 wastewater streams that are used to comply with §63.138(g). For Group 2 wastewater streams, the owner or operator shall include the information specified in paragraphs (b)(1)(i) through (iv) of this section in the Notification of Compliance Status Report. This information may be submitted in any form. Table 15 of this subpart is an example.

(i) Process unit identification and description of the process unit.

(ii) Stream identification code.

(iii) For existing sources, concentration of table 9 compound(s) in parts per million, by weight. For new sources, concentration of table 8 and/or table 9 compound(s) in parts per million, by weight. Include documentation of the methodology used to determine concentration.

(iv) Flow rate in liter per minute.

(2) For each new and existing source, the owner or operator shall submit the information specified in table 15 of this subpart for Table 8 and/or Table 9 compounds.

(3) [Reserved]

(4) For each treatment process identified in table 15 of this subpart that receives, manages, or treats a Group 1 wastewater stream or residual removed from a Group 1 wastewater stream, the owner or operator shall submit the information specified in table 17 of this subpart.

(5) For each waste management unit identified in table 15 of this subpart that receives or manages a Group 1 wastewater stream or residual removed from a Group 1 wastewater stream, the owner or operator shall submit the information specified in table 18 of this subpart.

(6) For each residual removed from a Group 1 wastewater stream, the owner or operator shall report the information specified in table 19 of this subpart.

(7) For each control device used to comply with §§63.133 through 63.139 of this subpart, the owner or operator shall report the information specified in paragraphs (b)(7)(i) and (b)(7)(ii) of this section.

(i) For each flare, the owner or operator shall submit the information specified in paragraphs (b)(7)(i)(A) through (b)(7)(i)(C) of this section.

(A) Flare design (i.e., steam-assisted, air-assisted, or non-assisted);

(B) All visible emission readings, heat content determinations, flow rate measurements, and exit velocity determinations made during the compliance determination required by §63.139(c)(3) of this subpart; and

(C) Reports of the times and durations of all periods during the compliance determination when the pilot flame is absent or the monitor is not operating.

(ii) For each control device other than a flare, the owner or operator shall submit the information specified in paragraph (b)(7)(ii)(A) of this section and in either paragraph (b)(7)(ii)(B) or (b)(7)(ii)(C) of this section.

(A) The information on parameter ranges specified in §63.152(b)(2) of this subpart for the applicable parameters specified in table 13 of this subpart, unless the parameter range has already been established in the operating permit; and either

(B) The design evaluation specified in §63.139(d)(2) of this subpart; or

(C) Results of the performance test specified in §63.139(d)(1) of this subpart. Performance test results shall include operating ranges of key process and control parameters during the performance test; the value of each parameter being monitored in accordance with §63.143 of this subpart; and applicable supporting calculations.

(8) For each treatment process used to comply with §63.138(b)(1), (c)(1), (d), (e), (f), or (g) of this subpart, the owner or operator shall submit the information specified in paragraphs (b)(8)(i) and (b)(8)(ii) of this section.

(i) For Items 1 and 2 in table 12 of this subpart, the owner or operator shall submit the information specified in paragraphs (b)(8)(i)(A) and (b)(8)(i)(B) of this section. An owner or operator using the design steam stripper compliance option specified §63.138(d) of this subpart does not have to submit the information specified in paragraph (b)(8)(i)(A) or (b)(8)(i)(B) of this section. However, the monitoring requirements specified in Item 2 of table 12 of this subpart still apply.

(A) The information on parameter ranges specified in §63.152(b)(2) of this subpart for the parameters approved by the Administrator, unless the parameter range has already been established in the operating permit.

(B) Results of the initial measurements of the parameters approved by the Administrator and any applicable supporting calculations.

(ii) For Item 3 in table 12 of this subpart, the owner or operator shall submit the information on parameter ranges specified in §63.152(b)(2) of this subpart for the parameters specified in Item 3 of table 12 of this subpart, unless the parameter range has already been established in the operating permit.

(9) For each waste management unit or treatment process used to comply with §63.138(b)(1), (c)(1), (e), (f), or (g), the owner or operator shall submit the information specified in either paragraph (b)(9)(i) or (ii) of this section.

(i) The design evaluation and supporting documentation specified in §63.138(j)(1) of this subpart.

(ii) Results of the performance test specified in §63.138(j)(2) of this subpart. Performance test results shall include operating ranges of key process and control parameters during the performance test; the value of each parameter being monitored in accordance with §63.143 of this subpart; and applicable supporting calculations.

(c) For each waste management unit that receives, manages, or treats a Group 1 wastewater stream or residual removed from a Group 1 wastewater stream, the owner or operator shall submit as part of the next Periodic Report required by §63.152(c) of this subpart the results of each inspection

required by §63.143(a) of this subpart in which a control equipment failure was identified. Control equipment failure is defined for each waste management unit in §§63.133 through 63.137 of this subpart. Each Periodic Report shall include the date of the inspection, identification of each waste management unit in which a control equipment failure was detected, description of the failure, and description of the nature of and date the repair was made.

(d) Except as provided in paragraph (f) of this section, for each treatment process used to comply with §63.138(b)(1), (c)(1), (d), (e), (f), or (g), the owner or operator shall submit as part of the next Periodic Report required by §63.152(c) the information specified in paragraphs (d)(1), (2), and (3) of this section for the monitoring required by §63.143(b), (c), and (d).

(1) For Item 1 in table 12, the owner or operator shall submit the results of measurements that indicate that the biological treatment unit is outside the range established in the Notification of Compliance Status or operating permit.

(2) For Item 2 in table 12, the owner or operator shall submit the monitoring results for each operating day during which the daily average value of a continuously monitored parameter is outside the range established in the Notification of Compliance Status or operating permit.

(3) For Item 3 in table 12 of this subpart, the owner or operator shall submit the monitoring results for each operating day during which the daily average value of any monitored parameter approved in accordance with §63.151 (f) was outside the range established in the Notification of Compliance Status or operating permit.

(e) Except as provided in paragraph (f) of this section, for each control device used to comply with §§63.133 through 63.139 of this subpart, the owner or operator shall submit as part of the next Periodic Report required by §63.152(c) of this subpart the information specified in either paragraph (e)(1) or (e)(2) of this section.

(1) The information specified in table 20 of this subpart, or

(2) If the owner or operator elects to comply with §63.143(e)(2) of this subpart, i.e., an organic monitoring device installed at the outlet of the control device, the owner or operator shall submit the monitoring results for each operating day during which the daily average concentration level or reading is outside the range established in the Notification of Compliance Status or operating permit.

(f) Where the owner or operator obtains approval to use a treatment process or control device other than one for which monitoring requirements are specified in §63.143 of this subpart, or to monitor parameters other than those specified in table 12 or 13 of this subpart, the Administrator will specify appropriate reporting requirements.

(g) If an extension is utilized in accordance with §63.133(e)(2) or §63.133(h) of this subpart, the owner or operator shall include in the next periodic report the information specified in §63.133 (e)(2) or §63.133(h).

[62 FR 2774, Jan. 17, 1997, as amended at 64 FR 20192, Apr. 26, 1999; 66 FR 6933, Jan. 22, 2001]

#### **§63.147 Process wastewater provisions—recordkeeping.**

(a) The owner or operator transferring a Group 1 wastewater stream or residual removed from a Group 1 wastewater stream in accordance with §63.132(g) of this subpart shall keep a record of the notice sent to the treatment operator stating that the wastewater stream or residual contains organic

hazardous air pollutants which are required to be managed and treated in accordance with the provisions of this subpart.

(b) The owner or operator shall keep in a readily accessible location the records specified in paragraphs (b)(1) through (8) of the section.

(1) A record that each waste management unit inspection required by §§63.133 through 63.137 of this subpart was performed.

(2) A record that each inspection for control devices required by §63.139 of this subpart was performed.

(3) A record of the results of each seal gap measurement required by §§63.133(d) and 63.137(c) of this subpart. The records shall include the date of the measurement, the raw data obtained in the measurement, and the calculations described in §63.120(b)(2), (3), and (4) of this subpart.

(4) For Item 1 and Item 3 of table 12 of this subpart, the owner or operator shall keep the records approved by the Administrator.

(5) Except as provided in paragraph (e) of this section, continuous records of the monitored parameters specified in Item 2 of table 12 and table 13 of this subpart, and in §63.143(e)(2) of this subpart.

(6) Documentation of a decision to use an extension, as specified in §63.133(e)(2) or (h) of this subpart, which shall include a description of the failure, documentation that alternate storage capacity is unavailable, and specification of a schedule of actions that will ensure that the control equipment will be repaired or the vessel will be emptied as soon as practical.

(7) Documentation of a decision to use a delay of repair due to unavailability of parts, as specified in §63.140(c), shall include a description of the failure, the reason additional time was necessary (including a statement of why replacement parts were not kept on site and when the manufacturer promised delivery), and the date when repair was completed.

(8) *Requirements for Group 2 wastewater streams.* This paragraph (b)(8) does not apply to Group 2 wastewater streams that are used to comply with §63.138(g). For all other Group 2 wastewater streams, the owner or operator shall keep in a readily accessible location the records specified in paragraphs (b)(8)(i) through (iv) of this section.

(i) Process unit identification and description of the process unit.

(ii) Stream identification code.

(iii) For existing sources, concentration of table 9 compound(s) in parts per million, by weight. For new sources, concentration of table 8 and/or table 9 compound(s) in parts per million, by weight. Include documentation of the methodology used to determine concentration.

(iv) Flow rate in liter per minute.

(c) For each boiler or process heater used to comply with §§63.133 through 63.139 of this subpart, the owner or operator shall keep a record of any changes in the location at which the vent stream is introduced into the flame zone as required in §63.139(c)(1) of this subpart.



(d) The owner or operator shall keep records of the daily average value of each continuously monitored parameter for each operating day as specified in §63.152(f), except as provided in paragraphs (d)(1) through (3) of this section.

(1) For flares, records of the times and duration of all periods during which the pilot flame is absent shall be kept rather than daily averages.

(2) *Regenerative carbon adsorbers.* For regenerative carbon adsorbers, the owner or operator shall keep the records specified in paragraphs (d)(2)(i) and (ii) of this section instead of daily averages.

(i) Records of the total regeneration stream mass flow for each carbon bed regeneration cycle.

(ii) Records of the temperature of the carbon bed after each regeneration cycle.

(3) *Non-regenerative carbon adsorbers.* For non-regenerative carbon adsorbers using organic monitoring equipment, the owner or operator shall keep the records specified in paragraph (d)(3)(i) of this section instead of daily averages. For non-regenerative carbon adsorbers replacing the carbon adsorption system with fresh carbon at a regular predetermined time interval that is less than the carbon replacement interval that is determined by the maximum design flow rate and organic concentration in the gas stream vented to the carbon adsorption system, the owner or operator shall keep the records specified in paragraph (d)(3)(ii) of this section instead of daily averages.

(i)(A) Record of how the monitoring frequency, as specified in table 13 of this subpart, was determined.

(B) Records of when organic compound concentration of adsorber exhaust was monitored.

(C) Records of when the carbon was replaced.

(ii)(A) Record of how the carbon replacement interval, as specified in table 13 of this subpart, was determined.

(B) Records of when the carbon was replaced.

(e) Where the owner or operator obtains approval to use a control device other than one for which monitoring requirements are specified in §63.143 of this subpart, or to monitor parameters other than those specified in table 12 or table 13 of this subpart, the Administrator will specify appropriate recordkeeping requirements.

(f) If the owner or operator uses process knowledge to determine the annual average concentration of a wastewater stream as specified in §63.144(b)(3) of this subpart and/or uses process knowledge to determine the annual average flow rate as specified in §63.144(c)(1) of this subpart, and determines that the wastewater stream is not a Group 1 wastewater stream, the owner or operator shall keep in a readily accessible location the documentation of how process knowledge was used to determine the annual average concentration and/or the annual average flow rate of the wastewater stream.

[62 FR 2775, Jan. 17, 1997, as amended at 64 FR 20192, Apr. 26, 1999; 66 FR 6933, Jan. 22, 2001]

### **§63.148 Leak inspection provisions.**

(a) Except as provided in paragraph (k) of this section, for each vapor collection system, closed-vent system, fixed roof, cover, or enclosure required to comply with this section, the owner or operator shall comply with the requirements of paragraphs (b) through (j) of this section.

(b) Except as provided in paragraphs (g) and (h) of this section, each vapor collection system and closed-vent system shall be inspected according to the procedures and schedule specified in paragraphs (b)(1) and (b)(2) of this section and each fixed roof, cover, and enclosure shall be inspected according to the procedures and schedule specified in paragraph (b)(3) of this section.

(1) If the vapor collection system or closed vent system is constructed of hard-piping, the owner or operator shall:

- (i) Conduct an initial inspection according to the procedures in paragraph (c) of this section, and
- (ii) Conduct annual visual inspections for visible, audible, or olfactory indications of leaks.

(2) If the vapor collection system or closed vent system is constructed of ductwork, the owner or operator shall:

- (i) Conduct an initial inspection according to the procedures in paragraph (c) of this section, and
- (ii) Conduct annual inspections according to the procedures in paragraph (c) of this section.
- (iii) Conduct annual visual inspections for visible, audible, or olfactory indications of leaks.

(3) For each fixed roof, cover, and enclosure, the owner or operator shall conduct initial visual inspections and semi-annual visual inspections for visible, audible, or olfactory indications of leaks as specified in §§63.133 through 63.137 of this subpart.

(c) Each vapor collection system and closed vent system shall be inspected according to the procedures specified in paragraphs (c)(1) through (c)(5) of this section.

(1) Inspections shall be conducted in accordance with Method 21 of 40 CFR part 60, appendix A.

(2)(i) Except as provided in paragraph (c)(2)(ii) of this section, the detection instrument shall meet the performance criteria of Method 21 of 40 CFR part 60, appendix A, except the instrument response factor criteria in section 3.1.2(a) of Method 21 shall be for the average composition of the process fluid not each individual volatile organic compound in the stream. For process streams that contain nitrogen, air, or other inerts which are not organic hazardous air pollutants or volatile organic compounds, the average stream response factor shall be calculated on an inert-free basis.

(ii) If no instrument is available at the plant site that will meet the performance criteria specified in paragraph (c)(2)(i) of this section, the instrument readings may be adjusted by multiplying by the average response factor of the process fluid, calculated on an inert-free basis as described in paragraph (c)(2)(i) of this section.

(3) The detection instrument shall be calibrated before use on each day of its use by the procedures specified in Method 21 of 40 CFR part 60, appendix A.

(4) Calibration gases shall be as follows:

- (i) Zero air (less than 10 parts per million hydrocarbon in air); and
- (ii) Mixtures of methane in air at a concentration less than 10,000 parts per million. A calibration gas other than methane in air may be used if the instrument does not respond to methane or if the instrument

does not meet the performance criteria specified in paragraph (c)(2)(i) of this section. In such cases, the calibration gas may be a mixture of one or more of the compounds to be measured in air.

(5) An owner or operator may elect to adjust or not adjust instrument readings for background. If an owner or operator elects to not adjust readings for background, all such instrument readings shall be compared directly to the applicable leak definition to determine whether there is a leak. If an owner or operator elects to adjust instrument readings for background, the owner or operator shall measure background concentration using the procedures in §§63.180(b) and (c) of subpart H of this part. The owner or operator shall subtract background reading from the maximum concentration indicated by the instrument.

(6) The arithmetic difference between the maximum concentration indicated by the instrument and the background level shall be compared with 500 parts per million for determining compliance.

(d) Leaks, as indicated by an instrument reading greater than 500 parts per million above background or by visual inspections, shall be repaired as soon as practicable, except as provided in paragraph (e) of this section.

(1) A first attempt at repair shall be made no later than 5 calendar days after the leak is detected.

(2) Repair shall be completed no later than 15 calendar days after the leak is detected, except as provided in paragraph (d)(3) of this section.

(3) For leaks found in vapor collection systems used for transfer operations, repairs shall be completed no later than 15 calendar days after the leak is detected or at the beginning of the next transfer loading operation, whichever is later.

(e) Delay of repair of a vapor collection system, closed vent system, fixed roof, cover, or enclosure for which leaks have been detected is allowed if the repair is technically infeasible without a shutdown, as defined in §63.101 of subpart F of this part, or if the owner or operator determines that emissions resulting from immediate repair would be greater than the fugitive emissions likely to result from delay of repair. Repair of such equipment shall be complete by the end of the next shutdown.

(f) For each vapor collection system or closed vent system that contains bypass lines that could divert a vent stream away from the control device and to the atmosphere, the owner or operator shall comply with the provisions of either paragraph (f)(1) or (f)(2) of this section, except as provided in paragraph (f)(3) of this section.

(1) Install, calibrate, maintain, and operate a flow indicator that determines whether vent stream flow is present at least once every 15 minutes. Records shall be generated as specified in §63.118(a)(3) of this subpart. The flow indicator shall be installed at the entrance to any bypass line; or

(2) Secure the bypass line valve in the closed position with a car-seal or a lock-and-key type configuration. A visual inspection of the seal or closure mechanism shall be performed at least once every month to ensure the valve is maintained in the closed position and the vent stream is not diverted through the bypass line.

(3) Equipment such as low leg drains, high point bleeds, analyzer vents, open-ended valves or lines, and pressure relief valves needed for safety purposes are not subject to this paragraph.

(g) Any parts of the vapor collection system, closed vent system, fixed roof, cover, or enclosure that are designated, as described in paragraph (i)(1) of this section, as unsafe to inspect are exempt from the inspection requirements of paragraphs (b)(1), (b)(2), and (b)(3)(i) of this section if:

(1) The owner or operator determines that the equipment is unsafe to inspect because inspecting personnel would be exposed to an imminent or potential danger as a consequence of complying with paragraphs (b)(1), (b)(2), or (b)(3)(i) of this section; and

(2) The owner or operator has a written plan that requires inspection of the equipment as frequently as practicable during safe-to-inspect times.

(h) Any parts of the vapor collection system, closed vent system, fixed roof, cover, or enclosure that are designated, as described in paragraph (i)(2) of this section, as difficult to inspect are exempt from the inspection requirements of paragraphs (b)(1), (b)(2), and (b)(3)(i) of this section if:

(1) The owner or operator determines that the equipment cannot be inspected without elevating the inspecting personnel more than 2 meters above a support surface; and

(2) The owner or operator has a written plan that requires inspection of the equipment at least once every 5 years.

(i) The owner or operator shall record the information specified in paragraphs (i)(1) through (i)(5) of this section.

(1) Identification of all parts of the vapor collection system, closed vent system, fixed roof, cover, or enclosure that are designated as unsafe to inspect, an explanation of why the equipment is unsafe to inspect, and the plan for inspecting the equipment.

(2) Identification of all parts of the vapor collection system, closed vent system, fixed roof, cover, or enclosure that are designated as difficult to inspect, an explanation of why the equipment is difficult to inspect, and the plan for inspecting the equipment.

(3) For each vapor collection system or closed vent system that contains bypass lines that could divert a vent stream away from the control device and to the atmosphere, the owner or operator shall keep a record of the information specified in either paragraph (i)(3)(i) or (i)(3)(ii) of this section.

(i) Hourly records of whether the flow indicator specified under paragraph (f)(1) of this section was operating and whether a diversion was detected at any time during the hour, as well as records of the times of all periods when the vent stream is diverted from the control device or the flow indicator is not operating.

(ii) Where a seal mechanism is used to comply with paragraph (f)(2) of this section, hourly records of flow are not required. In such cases, the owner or operator shall record whether the monthly visual inspection of the seals or closure mechanisms has been done, and shall record the occurrence of all periods when the seal mechanism is broken, the bypass line valve position has changed, or the key for a lock-and-key type configuration has been checked out, and records of any car-seal that has broken.

(4) For each inspection during which a leak is detected, a record of the information specified in paragraphs (i)(4)(i) through (i)(4)(viii) of this section.

(i) The instrument identification numbers; operator name or initials; and identification of the equipment.

(ii) The date the leak was detected and the date of the first attempt to repair the leak.

(iii) Maximum instrument reading measured by the method specified in paragraph (d) of this section after the leak is successfully repaired or determined to be nonrepairable.

(iv) "Repair delayed" and the reason for the delay if a leak is not repaired within 15 calendar days after discovery of the leak.

(v) The name, initials, or other form of identification of the owner or operator (or designee) whose decision it was that repair could not be effected without a shutdown.

(vi) The expected date of successful repair of the leak if a leak is not repaired within 15 calendar days.

(vii) Dates of shutdowns that occur while the equipment is unrepaired.

(viii) The date of successful repair of the leak.

(5) For each inspection conducted in accordance with paragraph (c) of this section during which no leaks are detected, a record that the inspection was performed, the date of the inspection, and a statement that no leaks were detected.

(6) For each visual inspection conducted in accordance with paragraph (b)(1)(ii) or (b)(3)(ii) of this section during which no leaks are detected, a record that the inspection was performed, the date of the inspection, and a statement that no leaks were detected.

(j) The owner or operator shall submit with the reports required by §63.182(b) of subpart H of this part or with the reports required by §63.152(c) of this subpart, the information specified in paragraphs (j)(1) through (j)(3) of this section.

(1) The information specified in paragraph (i)(4) of this section;

(2) Reports of the times of all periods recorded under paragraph (i)(3)(i) of this section when the vent stream is diverted from the control device through a bypass line; and

(3) Reports of all periods recorded under paragraph (i)(3)(ii) of this section in which the seal mechanism is broken, the bypass line valve position has changed, or the key to unlock the bypass line valve was checked out.

(k) If a closed-vent system subject to this section is also subject to §63.172 of subpart H of this part, the owner or operator shall comply with the provisions of §63.172 of subpart H of this part and is exempt from the requirements of this section.

[59 FR 19468, Apr. 22, 1994, as amended at 60 FR 63628, Dec. 12, 1995; 62 FR 2775, Jan. 17, 1997; 64 FR 20192, Apr. 26, 1999]

**§63.149 Control requirements for certain liquid streams in open systems within a chemical manufacturing process unit.**

(a) The owner or operator shall comply with the provisions of table 35 of this subpart, for each item of equipment meeting all the criteria specified in paragraphs (b) through (d) and either paragraph (e)(1) or (e)(2) of this section.

(b) The item of equipment is of a type identified in table 35 of this subpart;

(c) The item of equipment is part of a chemical manufacturing process unit that meets the criteria of §63.100(b) of subpart F of this part;

(d) The item of equipment is controlled less stringently than in table 35 and is not listed in §63.100(f) of subpart F of this part, and the item of equipment is not otherwise exempt from controls by the provisions of subparts A, F, G, or H of this part; and

(e) The item of equipment:

(1) is a drain, drain hub, manhole, lift station, trench, pipe, or oil/water separator that conveys water with a total annual average concentration greater than or equal to 10,000 parts per million by weight of Table 9 compounds at any flowrate; or a total annual average concentration greater than or equal to 1,000 parts per million by weight of Table 9 compounds at an annual average flow rate greater than or equal to 10 liters per minute. At a chemical manufacturing process unit subject to the new source requirements of 40 CFR 63.100(l)(1) or 40 CFR 63.100(l)(2), the criteria of this paragraph are also met if the item of equipment conveys water with an annual average concentration greater than or equal to 10 parts per million by weight of any Table 8 compound at an annual average flow rate greater than or equal to 0.02 liter per minute, or

(2) Is a tank that receives one or more streams that contain water with a total annual average concentration greater than or equal to 1,000 ppm (by weight) of Table 9 compounds at an annual average flowrate greater than or equal to 10 liters per minute. At a chemical manufacturing process unit subject to the new source requirements of 40 CFR 63.100(l)(1) or 40 CFR 63.100(l)(2), the criteria of this paragraph are also met if the tank receives one or more streams that contain water with an annual average concentration greater than or equal to 10 parts per million by weight of any Table 8 compound at an annual average flow rate greater than or equal to 0.02 liter per minute. The owner or operator of the source shall determine the characteristics of the stream as specified in paragraphs (e)(2)(i) and (ii) of this section.

(i) The characteristics of the stream being received shall be determined at the inlet to the tank.

(ii) The characteristics shall be determined according to the procedures in §63.144 (b) and (c).

[62 FR 2776, Jan. 17, 1997]

### **§63.150 Emissions averaging provisions.**

(a) This section applies to owners or operators of existing sources who seek to comply with the emission standard in §63.112(a) of this subpart by using emissions averaging according to §63.112(f) of this subpart rather than following the provisions of §§63.113 through 63.148 of this subpart. Notwithstanding the definition of process vent in §63.101 and the sampling site designation in §63.115(a), for purposes of this section the location of a process vent shall be defined, and the characteristics of its gas stream shall be determined, consistent with paragraph (g)(2)(i) of this section.

(b) Unless an operating permit application has been submitted, the owner or operator shall develop and submit for approval an Implementation Plan containing all of the information required in §63.151(d) of this subpart for all points to be included in an emissions average. The Implementation Plan or operating permit application shall identify all emission points to be included in the emissions average. This must include any Group 1 emission points to which the reference control technology (defined in §63.111 of this subpart) is not applied and all other emission points being controlled as part of the average.

(c) The following emission points can be used to generate emissions averaging credits, if control was applied after November 15, 1990 and if sufficient information is available to determine the appropriate value of credits for the emission point:

(1) Group 2 emission points.

(2) Group 1 emission points that are controlled by a technology that the Administrator or permitting authority agrees has a higher nominal efficiency than the reference control technology. Information on the nominal efficiencies for such technologies must be submitted and approved as provided in paragraph (i) of this section.

(3) Emission points from which emissions are reduced by pollution prevention measures. Percent reductions for pollution prevention measures shall be determined as specified in paragraph (j) of this section.

(i) For a Group 1 emission point, the pollution prevention measure must reduce emissions more than the reference control technology would have had the reference control technology been applied to the emission point instead of the pollution prevention measure except as provided in paragraph (c)(3)(ii) of this section.

(ii) If a pollution prevention measure is used in conjunction with other controls for a Group 1 emission point, the pollution prevention measure alone does not have to reduce emissions more than the reference control technology, but the combination of the pollution prevention measure and other controls must reduce emissions more than the reference control technology would have had it been applied instead.

(d) The following emission points cannot be used to generate emissions averaging credits:

(1) Emission points already controlled on or before November 15, 1990, unless the level of control is increased after November 15, 1990, in which case credit will be allowed only for the increase in control after November 15, 1990.

(2) Group 1 emission points that are controlled by a reference control technology, unless the reference control technology has been approved for use in a different manner and a higher nominal efficiency has been assigned according to the procedures in paragraph (i) of this section. For example, it is not allowable to claim that an internal floating roof meeting the specifications of §63.119(b) of this subpart applied to a storage vessel is achieving greater than 95 percent control.

(3) Emission points on shut-down process units. Process units that are shut down cannot be used to generate credits or debits.

(4) Wastewater that is not process wastewater or wastewater streams treated in biological treatment units. These two types of wastewater cannot be used to generate credits or debits. For the purposes of this section, the terms wastewater and wastewater stream are used to mean process wastewater.

(5) Emission points controlled to comply with a State or Federal rule other than this subpart, unless the level of control has been increased after November 15, 1990 above what is required by the other State or Federal rule. Only the control above what is required by the other State or Federal rule will be credited. However, if an emission point has been used to generate emissions averaging credit in an approved emissions average, and the point is subsequently made subject to a State or Federal rule other than this subpart, the point can continue to generate emissions averaging credit for the purpose of complying with the previously approved average.

(e) For all points included in an emissions average, the owner or operator shall:

(1) Calculate and record monthly debits for all Group 1 emission points that are controlled to a level less stringent than the reference control technology for those emission points. Equations in paragraph (g) of this section shall be used to calculate debits.

(2) Calculate and record monthly credits for all Group 1 or Group 2 emission points that are overcontrolled to compensate for the debits. Equations in paragraph (h) of this section shall be used to calculate credits. Emission points and controls that meet the criteria of paragraph (c) of this section may be included in the credit calculation, whereas those described in paragraph (d) of this section shall not be included.

(3) Demonstrate that annual credits calculated according to paragraph (h) of this section are greater than or equal to debits calculated for the same annual compliance period according to paragraph (g) of this section.

(i) The owner or operator may choose to include more than the required number of credit-generating emission points in an average in order to increase the likelihood of being in compliance.

(ii) The initial demonstration in the Implementation Plan or operating permit application that credit-generating emission points will be capable of generating sufficient credits to offset the debits from the debit-generating emission points must be made under representative operating conditions. After the compliance date, actual operating data will be used for all debit and credit calculations.

(4) Demonstrate that debits calculated for a quarterly (3-month) period according to paragraph (g) of this section are not more than 1.30 times the credits for the same period calculated according to paragraph (h) of this section. Compliance for the quarter shall be determined based on the ratio of credits and debits from that quarter, with 30 percent more debits than credits allowed on a quarterly basis.

(5) Record and report quarterly and annual credits and debits in the Periodic Reports as specified in §63.152(c) of this subpart. Every fourth Periodic Report shall include a certification of compliance with the emissions averaging provisions as required by §63.152(c)(5)(iv)(B) of this subpart.

(f) Debits and credits shall be calculated in accordance with the methods and procedures specified in paragraphs (g) and (h) of this section, respectively, and shall not include emissions from the following:

(1) More than 20 individual Group 1 or Group 2 emission points. Where pollution prevention measures (as specified in paragraph (j)(1) of this section) are used to control emission points to be included in an emissions average, no more than 25 emission points may be included in the average. For example, if two emission points to be included in an emissions average are controlled by pollution prevention measures, the average may include up to 22 emission points.

(2) Periods of start-up, shutdown, and malfunction as described in the source's start-up, shutdown, and malfunction plan required by §63.6(e)(3) of subpart A of this part.

(3) Periods of monitoring excursions as defined in §63.152(c)(2)(ii)(A) of this subpart. For these periods, the calculation of monthly credits and debits shall be adjusted as specified in paragraphs (f)(3)(i) through (f)(3)(iii) of this section.

(i) No credits would be assigned to the credit-generating emission point.

(ii) Maximum debits would be assigned to the debit-generating emission point.

(iii) The owner or operator may demonstrate to the Administrator that full or partial credits or debits should be assigned using the procedures in paragraph (l) of this section.

(g) Debits are generated by the difference between the actual emissions from a Group 1 emission point that is uncontrolled or is controlled to a level less stringent than the reference control technology, and the emissions allowed for the Group 1 emission point. Debits shall be calculated as follows:



(1) The overall equation for calculating source-wide debits is:

$$\begin{aligned}
 \text{Debits} = & \sum_{i=1}^n (EPV_{iACTUAL} - (0.02)EPV_{iu}) + \sum_{i=1}^n (ES_{iACTUAL} \\
 & - (0.05)ES_{iu}) + \sum_{i=1}^n (ETR_{iACTUAL} - (0.02)ETR_{iu}) \\
 & + \sum_{i=1}^n (EWW_{iACTUAL} - EWW_{ic})
 \end{aligned}$$

where:

Debits and all terms of the equation are in units of megagrams per month, and

$EPV_{iACTUAL}$  = Emissions from each Group 1 process vent  $i$  that is uncontrolled or is controlled to a level less stringent than the reference control technology. This is calculated according to paragraph (g)(2) of this section.

(0.02)  $EPV_{iu}$  = Emissions from each Group 1 vent  $i$  if the reference control technology had been applied to the uncontrolled emissions, calculated according to paragraph (g)(2) of this section.

$ES_{iACTUAL}$  = Emissions from each Group 1 storage vessel  $i$  that is uncontrolled or is controlled to a level less stringent than the reference control technology. This is calculated according to paragraph (g)(3) of this section.

(0.05)  $ES_{iu}$  = Emissions from each Group 1 storage vessel  $i$  if the reference control technology had been applied to the uncontrolled emissions, calculated according to paragraph (g)(3) of this section.

$ETR_{iACTUAL}$  = Emissions from each Group 1 transfer rack  $i$  that is uncontrolled or is controlled to a level less stringent than the reference control technology. This is calculated according to paragraph (g)(4) of this section.

(0.02)  $ETR_{iu}$  = Emissions from each Group 1 transfer rack  $i$  if the reference control technology had been applied to the uncontrolled emissions, calculated according to paragraph (g)(4) of this section.

$EWW_{iACTUAL}$  = Emissions from each Group 1 wastewater stream  $i$  that is uncontrolled or is controlled to a level less stringent than the reference control technology. This is calculated according to paragraph (g)(5) of this section.

$EWW_{ic}$  = Emissions from each Group 1 wastewater stream  $i$  if the reference control technology had been applied to the uncontrolled emissions. This is calculated according to paragraph (g)(5) of this section.

$n$  = The number of emission points being included in the emissions average. The value of  $n$  is not necessarily the same for process vents, storage vessels, transfer racks, and wastewater.

(2) Emissions from process vents shall be calculated according to paragraphs (g)(2)(i) through (iii) of this section.

(i) The location of a process vent shall be defined, and the characteristics of its gas stream shall be determined at a point that meets the conditions in either paragraph (g)(2)(i)(A) or (B) of this section and the conditions in paragraphs (g)(2)(i)(C) through (E) of this section.

(A) The point is after the final recovery device (if any recovery devices are present).

(B) If a gas stream included in an emissions average is combined with one or more other gas streams after a final recovery device (if any recovery devices are present), then for each gas stream, the point is at a representative point after any final recovery device and as near as feasible to, but before, the point of combination of the gas streams.

(C) The point is before any control device (for process vents, recovery devices shall not be considered control devices).

(D) The point is before discharge to the atmosphere.

(E) The measurement site for determination of the characteristics of the gas stream was selected using Method 1 or 1A of 40 CFR part 60, appendix A.

(ii) The following equation shall be used for each process vent  $i$  to calculate  $EPV_{iu}$ :

$$EPV_{iu} = (2.494 \times 10^{-9}) Qh \left( \sum_{j=1}^n C_j M_j \right)$$

where:

$EPV_{iu}$  = Uncontrolled process vent emission rate from process vent  $i$ , megagrams per month.

$Q$  = Vent stream flow rate, dry standard cubic meters per minute, measured using Method 2, 2A, 2C, or 2D of part 60, appendix A, as appropriate.

$h$  = Monthly hours of operation during which positive flow is present in the vent, hours per month.

$C_j$  = Concentration, parts per million by volume, dry basis, of organic HAP  $j$  as measured by Method 18 of part 60, appendix A.

$M_j$  = Molecular weight of organic HAP  $j$ , gram per gram-mole.

$n$  = Number of organic HAP's.

(A) The values of  $Q$ ,  $C_j$ , and  $M_j$  shall be determined during a performance test conducted under representative operating conditions. The values of  $Q$ ,  $C_j$ , and  $M_j$  shall be established in the Notification of Compliance Status and must be updated as provided in paragraph (g)(2)(ii)(B) of this section.

(B) If there is a change in capacity utilization other than a change in monthly operating hours, or if any other change is made to the process or product recovery equipment or operation such that the previously measured values of  $Q$ ,  $C_j$ , and  $M_j$  are no longer representative, a new performance test shall be conducted to determine new representative values of  $Q$ ,  $C_j$ , and  $M_j$ . These new values shall be used to calculate debits and credits from the time of the change forward, and the new values shall be reported in the next Periodic Report.

(iii) The following procedures and equations shall be used to calculate  $EPV_{iACTUAL}$ :

(A) If the vent is not controlled by a control device or pollution prevention measure,  $EPV_{iACTUAL} = EPV_{iu}$ , where  $EPV_{iu}$  is calculated according to the procedures in paragraphs (g)(2)(i) and (g)(2)(ii) of this section.

(B) If the vent is controlled using a control device or a pollution prevention measure achieving less than 98-percent reduction,

$$EPV_{iACTUAL} = EPV_{iu} \times \left( 1 - \frac{\text{Percent reduction}}{100\%} \right)$$

(1) The percent reduction shall be measured according to the procedures in §63.116 of this subpart if a combustion control device is used. For a flare meeting the criteria in §63.116(a) of this subpart, or a boiler or process heater meeting the criteria in §63.116(b) of this subpart, the percent reduction shall be 98 percent. If a non-combustion control device is used, percent reduction shall be demonstrated by a performance test at the inlet and outlet of the device, or, if testing is not feasible, by a control design evaluation and documented engineering calculations.

(2) For determining debits from Group 1 process vents, recovery devices shall not be considered control devices and cannot be assigned a percent reduction in calculating  $EPV_{\text{ACTUAL}}$ . The sampling site for measurement of uncontrolled emissions is after the final recovery device. However, as provided in §63.113(a)(3), a Group 1 process vent may add sufficient recovery to raise the TRE index value above 1.0, thereby becoming a Group 2 process vent.

(3) Procedures for calculating the percent reduction of pollution prevention measures are specified in paragraph (j) of this section.

(3) Emissions from storage vessels shall be calculated as follows:

(i) The following equation shall be used for each storage vessel  $i$  to calculate  $ES_{i_u}$ :

$$ES_{i_u} = \frac{L_B + L_W}{12}$$

where:

$ES_{i_u}$  = Uncontrolled emissions, defined as emissions from a fixed roof vessel having identical dimensions and vessel color as vessel  $i$ , megagrams per month.

$L_B$  = Breathing loss emissions, megagrams per year, calculated according to paragraph (g)(3)(i)(A) of this section.

$L_W$  = Working loss emissions, megagrams per year, calculated according to paragraph (g)(3)(i)(B) of this section.

12 = Constant, months per year.

(A) Breathing loss emissions shall be calculated using the following equation:

$$L_B = 1.02 \times 10^{-5} M_v \left( \frac{P}{P_A - P} \right) 0.68_D^{1.73} H^{0.51} \Delta T^{0.50} F_p C K_C$$

where:

$M_v$  = Molecular weight of vapor in storage vessel, pound per pound-mole.

$P_A$  = Average atmospheric pressure, pounds per square inch absolute.

$P$  = True vapor pressure of the HAP at liquid storage temperature, pounds per square inch absolute. See table 21 of this subpart.

$D$  = Tank diameter, feet.

$H$  = Average vapor space height, feet. Use vessel-specific values or an assumed value of one-half the height.

$\Delta T$  = Average ambient diurnal temperature change, °F. A typical value of 20 °F may be used.

$F_p$  = Paint factor, dimensionless, from table 22 of this subpart; use  $F_p = 1$  for vessels located indoors.

C = Adjustment factor for small diameter tanks, dimensionless; use C = 1 for diameter ≥30 feet; use C = 0.0771D – 0.0013D<sup>2</sup> – 0.1334 for diameter <30 feet.

K<sub>c</sub> = Product factor, dimensionless. Use 1.0 for organic HAP's.

(B) Working losses shall be calculated using the following equation:

$$L_w = 1.089 \times 10^{-8} M_v (P)(V)(N) (K_N) (K_c)$$

where:

V = Tank capacity, gallon.

N = Number of turnovers per year.

K<sub>N</sub> = Turnover factor, dimensionless, and

$$K_N = \frac{180 + N}{6N} \text{ for turnovers } > 36$$

$$K_N = 1 \text{ for turnovers } \leq 36.$$

M<sub>v</sub>, P, and K<sub>c</sub> as defined in paragraph (g)(3)(i)(A) of this section.

(C) The owner or operator may elect to calculate ES<sub>iu</sub> in accordance with the methods described in American Petroleum Institute Publication 2518, Evaporative Loss from Fixed-Roof Tanks (incorporated by reference as specified in §63.14 of this part).

(1) The owner or operator who elects to use these alternative methods must use them for all storage vessels included in the emissions average as debit or credit generating points.

(2) The equations of paragraphs (g)(3)(i)(A) and (g)(3)(i)(B) of this section shall not be used in conjunction with the alternative methods provided under paragraph (g)(3)(i)(C) of this section.

(ii) The following procedures and equations shall be used for each fixed roof storage vessel i that is not controlled with a floating roof to calculate ES<sub>IACTUAL</sub>:

(A) If the vessel is not controlled, ES<sub>IACTUAL</sub> = ES<sub>iu</sub>, where ES<sub>iu</sub> is calculated according to the procedures in paragraph (g)(3)(i) of this section.

(B) Except as provided in paragraph (g)(3)(ii)(C) of this section, if the vessel is controlled using a control device or pollution prevention measure achieving less than 95-percent reduction,

$$ES_{IACTUAL} = ES_{iu} * \left( \frac{1 - \text{Percent reduction}}{100} \right)$$

(1) The percent reduction for a control device shall be determined through a design evaluation according to the procedures specified in §63.120(d) of this subpart.

(2) Procedures for calculating the percent reduction for pollution prevention measures are specified in paragraph (j) of this section.

(C) If the vessel is controlled according to the provisions of §63.119(e)(2) of this section whereby the control device is only required to achieve at least 90-percent reduction, the vessel shall not be considered to be generating debits.

(iii) The following equation shall be used for each internal floating roof vessel *i* that does not meet the specifications of §63.119(b) or (d) of this subpart to calculate  $ES_{ACTUAL}$ :

$$ES_{ACTUAL} = \frac{L_W + L_R + L_F + L_D}{12}$$

where:

$L_W$  = Withdrawal loss emissions, megagrams per year, calculated according to paragraph (g)(3)(iii)(A) of this section.

$L_R$  = Rim seal loss emissions, megagrams per year, calculated according to paragraph (g)(3)(iii)(B) of this section.

$L_F$  = Fitting loss emissions, megagrams per year, calculated according to paragraph (g)(3)(iii)(C) of this section.

$L_D$  = Deck seam loss emissions, megagrams per year, calculated according to paragraph (g)(3)(iii)(D) of this section.

12 = Constant, months per year.

(A) Withdrawal loss emissions shall be calculated using the following equation:

$$L_W = \frac{1.018 \times 10^{-5} Q C W_L}{D} \left[ 1 + \left( \frac{N_c F_c}{D} \right) \right]$$

where:

Q = Throughput, gallon per year; (gallon/turnover) \* (turnovers per year).

C = Shell clingage factor, barrel per 1,000 square foot, see table 23 of this subpart.

WL = Average liquid density, pound per gallon.

D = Tank diameter, feet.

$N_c$  = Number of columns, dimensionless, see table 24 of this subpart.

$F_c$  = Effective column diameter, feet [column perimeter (feet) ÷ 3.1416], see table 25 of this subpart.

(B) Rim seal loss emissions shall be calculated using the following equation:

$$L_R = \frac{K_s V^* P^* D M_v K_c}{2,205}$$

where:

$M_v$  = Molecular weight of vapor in storage vessel, pound per pound-mole.

D = Tank diameter, feet.

$K_c$  = Product factor, dimensionless; use 1.0 for organic HAP's.

$K_s$  = Seal factor, pound-mole per [foot (miles per hour)<sup>n</sup> year], see table 26 of this subpart.

V = Average wind speed at the source, miles per hour. A value of 10 miles per hour may be assumed if source-specific data are not available.

n = Seal related wind speed exponent, dimensionless, see table 26 of this subpart.

2,205 = Constant, pounds per megagram.

P\* = Vapor pressure function, dimensionless, and

$$P^* = \frac{\frac{P}{P_A}}{\left[1 + \left(1 - \frac{P}{P_A}\right)0.5\right]^2}$$

where:

P<sub>A</sub> = Average atmospheric pressure, pounds per square inch absolute.

P = True vapor pressure at liquid storage temperature, pounds per square inch absolute.

(C) Fitting loss emissions shall be calculated using the following equation:

$$L_F = \frac{F_f P^* M_v K_c}{2,205}$$

where:

F<sub>f</sub> = The total deck fitting loss factor, pound-mole per year, and

where:

$$F_f = \sum_{i=1}^n (N_{F_i} K_{F_i}) = \left[ (N_{F_1} K_{F_1}) + (N_{F_2} K_{F_2}) + \dots + (N_{F_n} K_{F_n}) \right]$$

N<sub>F<sub>i</sub></sub> = Number of fittings of a particular type, dimensionless. N<sub>F<sub>i</sub></sub> is determined for the specific tank or estimated from tables 24 and 27 of this subpart.

K<sub>F<sub>i</sub></sub> = Deck fitting loss factor for a particular type fitting, pound-mole per year. K<sub>F<sub>i</sub></sub> is determined for each fitting type from table 27 of this subpart.

n = Number of different types of fittings, dimensionless.

P\*, M<sub>v</sub>, K<sub>c</sub>, and 2,205 as defined in paragraph (g)(3)(iii)(B) of this section.

(D) Deck seam loss emissions shall be calculated using the following equation:

$$L_D = \frac{K_D S_D D^2 P^* M_v K_c}{2,205}$$

where:

K<sub>D</sub> = Deck seam loss factor, pound-mole per foot per year, and

$K_D = 0.34$  for non-welded decks.

$K_D = 0$  for welded decks.

$S_D$  = Deck seam length factor, feet per square foot, see table 28 of this subpart.

$D$ ,  $P^*$ ,  $M_v$ ,  $K_c$ , and 2,205 as defined in paragraph (g)(3)(iii)(B) of this section.

(iv) The following equation shall be used for each external floating roof vessel  $i$  that does not meet the specifications of §63.119(c) of this subpart to calculate  $ES_{ACTUAL}$ :

$$ES_{ACTUAL} = \frac{L_W + L_R + L_F}{12}$$

where:

$L_W$  = Withdrawal loss emissions, megagrams per year, calculated according to paragraph (g)(3)(iv)(A) of this section.

$L_R$  = Rim seal loss emissions, megagrams per year, calculated according to paragraph (g)(3)(iv)(B) of this section.

$L_F$  = Fitting loss emissions, megagrams per year, calculated according to paragraph (g)(3)(iv)(C) of this section.

12 = Constant, months per year.

(A) Withdrawal loss emissions shall be calculated using the following equation:

$$L_W = \frac{4.28 * 10^{-4} Q C W_L}{D}$$

where:

$Q$  = Throughput, gallons per year.

$C$  = Shell clingage factor, barrel per 1,000 square foot, see table 23 of this subpart.

$W_L$  = Average liquid density, pound per gallon.

$D$  = Vessel diameter, feet.

(B) Rim seal loss emissions shall be calculated using the following equation:

$$L_R = \frac{K_s V^N P^* D M_v K_c}{2,205}$$

where:

$K_s$  = Seal factor, pound-mole per [foot (miles per hour) <sup>$N$</sup>  year], see table 29 of this subpart.

$V$  = Average wind speed, miles per hour, at the source. A value of 10 miles per hour may be assumed if source-specific data are not available.

$N$  = Seal wind speed exponent, dimensionless, see table 29 of this subpart.

$P^*$  = Vapor pressure function, dimensionless, as defined in paragraph (g)(3)(iii)(B) of this section.

D = Vessel diameter, feet.

M<sub>v</sub> = Molecular weight of the HAP, pound per pound-mole.

K<sub>c</sub> = Product factor, dimensionless; use 1.0 for organic HAP's.

2,205 = Constant, pounds per megagram.

(C) Fitting loss emissions shall be calculated using the following equation:

$$L_F = \frac{F_F P^* M_v K_c}{2,205}$$

where:

F<sub>F</sub> = The total deck fitting loss factor, pound-mole per year, and

$$F_F = \sum_{i=1}^n (N_{F_i} K_{F_i}) = \left[ (N_{F_1} K_{F_1}) + (N_{F_2} K_{F_2}) + \dots + (N_{F_n} K_{F_n}) \right]$$

where:

N<sub>F<sub>i</sub></sub> = Number of fittings of a particular type, dimensionless. N<sub>F<sub>i</sub></sub> is determined for the specific tank or estimated from tables 30 through 32 of this subpart.

K<sub>F<sub>i</sub></sub> = Deck fitting loss factor for a particular type fitting, pound-mole per year, and

K<sub>F<sub>i</sub></sub> = K<sub>F<sub>ai</sub></sub> + K<sub>F<sub>bi</sub></sub> V<sup>m</sup>, pound-mole per year, see table 30 of this subpart for the appropriate values of K<sub>F<sub>a</sub></sub>, K<sub>F<sub>b</sub></sub>, and m for each fitting type.

V, P\*, M<sub>v</sub>, K<sub>c</sub>, and 2,205 as defined in paragraph (g)(3)(iv)(B) of this section.

(4) Emissions from transfer racks shall be calculated as follows:

(i) The following equation shall be used for each transfer rack i to calculate ETR<sub>iw</sub>:

$$ETR_{iw} = (1.20 \times 10^{-7}) \frac{SPMG}{T}$$

where:

ETR<sub>iw</sub> = Uncontrolled transfer HAP emission rate from transfer rack i, megagrams per month.

S = Saturation factor, dimensionless (see table 33 of this subpart).

P = Weighted average rack partial pressure of organic HAP's transferred at the rack during the month, kilopascals.

M = Weighted average molecular weight of organic HAP's transferred at the transfer rack during the month, gram per gram-mole.

G = Monthly volume of organic HAP's transferred, liters per month.

T = Weighted rack bulk liquid loading temperature during the month, Kelvin ( °C + 273).

(ii) The following equation shall be used for each transfer rack i to calculate the weighted average rack partial pressure:



$$P = \frac{\sum_{j=1}^{j=n} (P_j)(G_j)}{G}$$

where:

$P_j$  = Maximum true vapor pressure of individual organic HAP transferred at the rack, kilopascals.

$G$  = Monthly volume of organic HAP transferred, liters per month, and

$$G = \sum_{j=1}^{j=n} G_j$$

$G_j$  = Monthly volume of individual organic HAP transferred at the transfer rack, liters per month.

$n$  = Number of organic HAP's transferred at the transfer rack.

(iii) The following equation shall be used for each transfer rack  $i$  to calculate the weighted average rack molecular weight:

$$M = \frac{\sum_{j=1}^{j=n} (M_j)(G_j)}{G}$$

where:

$M_j$  = Molecular weight of individual organic HAP transferred at the rack, gram per gram-mole.

$G$ ,  $G_j$ , and  $n$  as defined in paragraph (g)(4)(ii) of this section.

(iv) The following equation shall be used for each transfer rack  $i$  to calculate the monthly weighted rack bulk liquid loading temperature:

$$T = \frac{\sum_{j=1}^{j=n} (T_j)(G_j)}{G}$$

where:

$T_j$  = Average annual bulk temperature of individual organic HAP loaded at the transfer rack, Kelvin ( $(^{\circ}\text{C} + 273)$ ).

$G$ ,  $G_j$ , and  $n$  as defined in paragraph (g)(4)(ii) of this section.

(v) The following procedures and equations shall be used to calculate  $\text{ETR}_{\text{ACTUAL}}$ :

(A) If the transfer rack is not controlled,  $\text{ETR}_{\text{ACTUAL}} = \text{ETR}_{\text{IU}}$ , where  $\text{ETR}_{\text{IU}}$  is calculated using the equations specified in paragraphs (g)(4)(i) through (g)(4)(iv) of this section.

(B) If the transfer rack is controlled using a control device or a pollution prevention measure achieving less than the 98-percent reduction,

$$ETR_{ACTUAL} = ETR_w \left( \frac{1 - \text{Percent reduction}}{100\%} \right)$$

(1) The percent reduction for a control device shall be measured according to the procedures and test methods specified in §63.128(a) of this subpart. For a flare meeting the criteria in §63.128(b) of this subpart or a boiler or process heater meeting the criteria in §63.128(c) of this subpart, the percent reduction shall be 98 percent. If testing is not feasible, percent reduction shall be determined through a design evaluation according to the procedures specified in §63.128(h) of this subpart.

(2) Procedures for calculating the percent reduction for pollution prevention measures are specified in paragraph (j) of this section.

(5) Emissions from wastewater shall be calculated as follows:

(i) The following equation shall be used for each wastewater stream i to calculate  $EWW_{ic}$ :

$$EWW_{ic} = (6.0 * 10^{-8}) Q_i H_i \sum_{m=1}^s (1 - Fr_m) Fe_m HAP_{im} \\ + (0.05) (6.0 * 10^{-8}) Q_i H_i \sum_{m=1}^s (Fr_m HAP_{im})$$

where:

$EWW_{ic}$  = Monthly wastewater stream emission rate if wastewater stream i is controlled by the reference control technology, megagrams per month.

$Q_i$  = Average flow rate for wastewater stream i, as determined by the procedure in §63.144(c)(3), liters per minute.

$H_i$  = Number of hours during the month that wastewater stream i was generated, hours per month.

s = Total number of table 9 HAP in wastewater stream i.

$Fr_m$  = Fraction removed of table 9 HAP m in wastewater, from table 9, dimensionless.

$Fe_m$  = Fraction emitted of table 9 HAP m in wastewater, from table 34, dimensionless.

$HAP_{im}$  = Average concentration of table 9 HAP m in wastewater stream i, parts per million by weight.

(A)  $HAP_{im}$  shall be determined for the point of determination or, at a location downstream of the point of determination and adjusted according as specified in §63.144(b)(6) of this subpart, by developing and using the sampling plan specified in §63.144(b)(5)(ii) of this subpart. The samples collected may be analyzed by any of the methods specified in §63.144(b)(5)(i)(B) through (b)(5)(i)(F) of this subpart. Concentration measurements based on Method 305 shall be adjusted by dividing each concentration by the compound-specific Fm factor listed on table 34 of this subpart. Concentration measurements other than Method 305 shall not be adjusted by the compound-specific Fm factor listed in table 34 of this subpart.

(B) Values for  $Q_i$ ,  $HAP_{im}$ , and  $C_{im}$  shall be determined during a performance test conducted under representative conditions as specified in §63.145(a)(3) and (a)(4) of this subpart. The average value obtained from three test runs shall be used. The values of  $Q_i$ ,  $HAP_{im}$ , and  $C_{im}$  shall be established in the Notification of Compliance Status and must be updated as provided in paragraph (g)(5)(i)(C) of this section.

(C) If there is a change to the process or operation such that the previously measured values of  $Q_i$ ,  $HAP_{im}$ , and  $C_{im}$  are no longer representative, a new performance test shall be conducted to determine new representative values of  $Q_i$ ,  $HAP_{im}$ , and  $C_{im}$ . These new values shall be used to calculate debits and credits from the time of the change forward, and the new values shall be reported in the next Periodic Report.

(ii) The following equation shall be used to calculate  $EWW_{iACTUAL}$  for each wastewater stream  $i$  that is not managed according to the provisions for waste management units of §§63.133 through 63.137 of this subpart, as applicable, which specify equipment and work practices for suppressing and controlling vapors.  $Q_i$ ,  $H_i$ ,  $s$ ,  $Fe_m$ , and  $HAP_{im}$  are as defined and determined according to paragraph (g)(5)(i) of this section.

$$EWW_{iACTUAL} = (6.0 \times 10^{-8}) Q_i H_i \sum_{m=1}^5 Fe_m HAP_{im}$$

Where:

$EWW_{iACTUAL}$  = Monthly wastewater stream emission rate if wastewater stream  $i$  is uncontrolled or is controlled to a level less stringent than the reference control technology, megagrams per month.

(iii) The following equation shall be used to calculate  $EWW_{iACTUAL}$  for each wastewater stream  $i$  that is managed according to the requirements of §§63.133 through 63.137 of this subpart, as applicable, and wastewater stream  $i$  is uncontrolled or is controlled to a level less stringent than the reference control technology (for the purposes of the wastewater emissions averaging provisions, the term control is used to mean treatment).  $Q_i$ ,  $H_i$ ,  $s$ ,  $Fe_m$ , and  $HAP_{im}$  are as defined and determined according to paragraph (g)(5)(i) of this section.

$$EWW_{iACTUAL} = (6.0 * 10^{-8}) Q_i H_i \sum_{m=1}^5 [Fe_m HAP_{im} (1 - PR_{im})] + \left(1 - \frac{R_i}{100\%}\right) (6.0 * 10^{-8}) Q_i H_i \sum_{m=1}^5 (HAP_{im} PR_{im})$$

Where:

$EWW_{iACTUAL}$  = Monthly wastewater stream emission rate if wastewater stream  $i$  is uncontrolled or is controlled to a level less stringent than the reference control technology, megagrams per month.

$PR_{im}$  = The efficiency of the treatment process, or series of treatment processes, which treat wastewater stream  $i$ , in reducing the emission potential of table 9 HAP  $m$  in wastewater, dimensionless, as calculated by:

$$PR_{im} = \frac{HAP_{im-in} - HAP_{im-out}}{HAP_{im-in}}$$

Where:

$HAP_{im-in}$  = Average concentration of table 9 HAP  $m$ , parts per million by weight, as defined and determined according to paragraph (g)(5)(i) of this section, in the wastewater entering the first treatment process in the series.

$HAP_{im-out}$  = Average concentration of table 9 HAP  $m$ , parts per million by weight, as defined and determined according to paragraph (g)(5)(i) of this section, in the wastewater exiting the last treatment process in the series.

$R_i$  = Reduction efficiency of the device used to control any vapor streams emitted and collected from wastewater stream  $i$  during treatment, dimensionless, as determined according to the procedures in §63.145(i) or (j) of this subpart.

(h) Credits are generated by the difference between emissions that are allowed for each Group 1 and Group 2 emission point and the actual emissions from a Group 1 or Group 2 emission point that has been controlled after November 15, 1990 to a level more stringent than what is required by this subpart or any other State or Federal rule or statute. Credits shall be calculated as follows:

(1) The overall equation for calculating source-wide credits is:

$$\begin{aligned} Credits = & D \sum_{i=1}^n ((0.02) EPV1_{1i} - EPV1_{1ACTUAL}) + D \sum_{i=1}^m (EPV2_{2BASE} - EPV2_{2ACTUAL}) + D \sum_{i=1}^n \\ & ((0.05) ES1_{1i} - ES1_{1ACTUAL}) + D \sum_{i=1}^m (ES2_{2BASE} - ES2_{2ACTUAL}) + D \sum_{i=1}^n ((0.02) ETR1_{1i} - ETR1_{1ACTUAL}) \\ & + D \sum_{i=1}^m (ETR2_{2BASE} - ETR2_{2ACTUAL}) + D \sum_{i=1}^n (EWW1_{1i} - EWW1_{1ACTUAL}) + D \sum_{i=1}^m (EWW2_{2BASE} - EWW2_{2ACTUAL}) \end{aligned}$$

where:

Credits and all terms of the equation are in units of megagrams per month, the baseline date is November 15, 1990, and:

$D$  = Discount factor = 0.9 for all credit generating emission points except those controlled by a pollution prevention measure, which will not be discounted.

$EPV1_{1ACTUAL}$  = Emissions for each Group 1 process vent  $i$  that is controlled to a level more stringent than the reference control technology, calculated according to paragraph (h)(2) of this section.

(0.02)  $EPV1_{1i}$  = Emissions from each Group 1 process vent  $i$  if the reference control technology had been applied to the uncontrolled emissions.  $EPV1_{1i}$  is calculated according to paragraph (h)(2) of this section.

$EPV2_{2ACTUAL}$  = Emissions from each Group 2 process vent  $i$  that is controlled, calculated according to paragraph (h)(2) of this section.

$EPV2_{2BASE}$  = Emissions from each Group 2 process vent  $i$  at the baseline date, as calculated in paragraph (h)(2) of this section.

$ES1_{1ACTUAL}$  = Emissions from each Group 1 storage vessel  $i$  that is controlled to a level more stringent than the reference control technology, calculated according to paragraph (h)(3) of this section.

(0.05)  $ES1_{1i}$  = Emissions from each Group 1 storage vessel  $i$  if the reference control technology had been applied to the uncontrolled emissions.  $ES1_{1i}$  is calculated according to paragraph (h)(3) of this section.

$ES2_{2ACTUAL}$  = Emissions from each Group 2 storage vessel  $i$  that is controlled, calculated according to paragraph (h)(3) of this section.

$ES2_{2BASE}$  = Emissions from each Group 2 storage vessel  $i$  at the baseline date, as calculated in paragraph (h)(3) of this section.

$ETR1_{1ACTUAL}$  = Emissions from each Group 1 transfer rack  $i$  that is controlled to a level more stringent than the reference control technology, calculated according to paragraph (h)(4) of this section.

(0.02)  $ETR1_{1i}$  = Emissions from each Group 1 transfer rack  $i$  if the reference control technology had been applied to the uncontrolled emissions.  $ETR1_{1i}$  is calculated according to paragraph (h)(4) of this section.

$ETR2_{ACTUAL}$  = Emissions from each Group 2 transfer rack i that are controlled, calculated according to paragraph (h)(4) of this section.

$ETR2_{BASE}$  = Emissions from each Group 2 transfer rack i at the baseline date, as calculated in paragraph (h)(4) of this section.

$EW1_{ACTUAL}$  = Emissions from each Group 1 wastewater stream i that is controlled to a level more stringent than the reference control technology, calculated according to paragraph (h)(5) of this section.

$EW1_{ic}$  = Emissions from each Group 1 wastewater stream i if the reference control technology had been applied to the uncontrolled emissions, calculated according to paragraph (h)(5) of this section.

$EW2_{ACTUAL}$  = Emissions from each Group 2 wastewater stream i that is controlled, calculated according to paragraph (h)(5) of this section.

$EW2_{BASE}$  = Emissions from each Group 2 wastewater stream i at the baseline date, calculated according to paragraph (h)(5) of this section.

n = Number of Group 1 emission points included in the emissions average. The value of n is not necessarily the same for process vents, storage vessels, transfer racks, and wastewater.

m = Number of Group 2 emission points included in the emissions average. The value of m is not necessarily the same for process vents, storage vessels, transfer racks, and wastewater.

(i) For an emission point controlled using a reference control technology, the percent reduction for calculating credits shall be no greater than the nominal efficiency associated with the reference control technology, unless a higher nominal efficiency is assigned as specified in paragraph (h)(1)(ii) of this section.

(ii) For an emission point controlled to a level more stringent than the reference control technology, the nominal efficiency for calculating credits shall be assigned as described in paragraph (i) of this section. A reference control technology may be approved for use in a different manner and assigned a higher nominal efficiency according to the procedures in paragraph (i) of this section.

(iii) For an emission point controlled using a pollution prevention measure, the nominal efficiency for calculating credits shall be as determined as described in paragraph (j) of this section.

(2) Emissions from process vents shall be determined as follows:

(i) Uncontrolled emissions from Group 1 process vents,  $EPV1_{iu}$ , shall be calculated according to the procedures and equation for  $EPV_{iu}$  in paragraphs (g)(2)(i) and (g)(2)(ii) of this section.

(ii) Actual emissions from Group 1 process vents controlled using a technology with an approved nominal efficiency greater than 98 percent or a pollution prevention measure achieving greater than 98 percent emission reduction,  $EPV1_{ACTUAL}$ , shall be calculated according to the following equation:

$$EPV1_{ACTUAL} = EPV1_{iu} \left( 1 - \frac{\text{Nominal efficiency \%}}{100\%} \right)$$

(iii) The following procedures shall be used to calculate actual emissions from Group 2 process vents,  $EPV2_{ACTUAL}$ :

(A) For a Group 2 process vent controlled by a control device, a recovery device applied as a pollution prevention project, or a pollution prevention measure, if the control achieves a percent reduction less than or equal to 98 percent reduction,

$$EPV2_{ACTUAL} = EPV2_{iw} \times \left( 1 - \frac{\text{Percent reduction}}{100\%} \right)$$

(1)  $EPV2_{iw}$  shall be calculated according to the equations and procedures for  $EPV_{iw}$  in paragraphs (g)(2)(i) and (g)(2)(ii) of this section, except as provided in paragraph (h)(2)(iii)(A)(3) of this section.

(2) The percent reduction shall be calculated according to the procedures in paragraphs (g)(2)(iii)(B)(1) through (g)(2)(iii)(B)(3) of this section, except as provided in paragraph (h)(2)(iii)(A)(4) of this section.

(3) If a recovery device was added as part of a pollution prevention project,  $EPV2_{iw}$  shall be calculated prior to that recovery device. The equation for  $EPV_{iw}$  in paragraph (g)(2)(ii) of this section shall be used to calculate  $EPV2_{iw}$ ; however, the sampling site for measurement of vent stream flow rate and organic HAP concentration shall be at the inlet of the recovery device.

(4) If a recovery device was added as part of a pollution prevention project, the percent reduction shall be demonstrated by conducting a performance test at the inlet and outlet of that recovery device.

(B) For a Group 2 process vent controlled using a technology with an approved nominal efficiency greater than 98 percent or a pollution prevention measure achieving greater than 98 percent reduction,

$$EPV2_{ACTUAL} = EPV2_{iw} \left( 1 - \frac{\text{Nominal efficiency \%}}{100\%} \right)$$

(iv) Emissions from Group 2 process vents at baseline,  $EPV2_{iBASE}$ , shall be calculated as follows:

(A) If the process vent was uncontrolled on November 15, 1990,  $EPV2_{iBASE} = EPV2_{iw}$  and shall be calculated according to the procedures and equation for  $EPV_{iw}$  in paragraphs (g)(2)(i) and (g)(2)(ii) of this section.

(B) If the process vent was controlled on November 15, 1990,

$$EPV2_{iBASE} = EPV2_{iw} \left( 1 - \frac{\text{Percent reduction \%}}{100\%} \right)$$

where  $EPV2_{iw}$  is calculated according to the procedures and equation for  $EPV_{iw}$  in paragraphs (g)(2)(i) and (g)(2)(ii) of this section. The percent reduction shall be calculated according to the procedures specified in paragraphs (g)(2)(iii)(B)(1) through (g)(2)(iii)(B)(3) of this section.

(C) If a recovery device was added to a process vent as part of a pollution prevention project initiated after November 15, 1990,  $EPV2_{iBASE} = EPV2_{iw}$ , where  $EPV2_{iw}$  is calculated according to paragraph (h)(2)(iii)(A)(3) of this section.

(3) Emissions from storage vessels shall be determined as follows:

(i) Uncontrolled emissions from Group 1 storage vessels,  $ES1_{iw}$ , shall be calculated according to the equations and procedures for  $ES_{iw}$  in paragraph (g)(3)(i) of this section.

(ii) Actual emissions from Group 1 storage vessels controlled using a technology with an approved nominal efficiency greater than 95 percent or a pollution prevention measure achieving greater than 95 percent emission reduction,  $ES1_{ACTUAL}$ , shall be calculated according to the following equation:

$$ES1_{ACTUAL} = ES1_{iw} \left( 1 - \frac{\text{Nominal efficiency \%}}{100\%} \right)$$

(iii) The following procedures shall be used to calculate actual emissions from Group 2 storage vessels,  $ES2_{ACTUAL}$ :

(A) For a Group 2 storage vessel controlled using a control device or a pollution prevention measure (other than an internal or external floating roof) achieving a percent reduction less than or equal to 95-percent reduction,

$$ES2_{ACTUAL} = ES2_{iw} \times \left( 1 - \frac{\text{Percent reduction}}{100\%} \right)$$

(1)  $ES2_{iw}$  is calculated according to the equations and procedures for  $ES_{iw}$  in paragraph (g)(3)(i) of this section.

(2) The percent reduction shall be calculated according to the procedures in paragraphs (g)(3)(ii)(B)(1) and (g)(3)(ii)(B)(2) of this section.

(3) If an internal or external floating roof meeting the specifications of §63.119 (b), (c), or (d) of this subpart is used to control the vessel, the percent reduction shall be 95 percent.

(B) If a Group 2 storage vessel is controlled with an internal or external floating roof not meeting the specifications of §63.119 (b), (c), or (d) of this subpart,  $ES2_{ACTUAL}$  shall be calculated as specified for  $ES_{ACTUAL}$  in paragraph (g)(3)(iii) or (g)(3)(iv) of this section.

(C) For a Group 2 storage vessel controlled using a technology with an approved nominal efficiency greater than 95 percent or a pollution prevention measure achieving greater than 95 percent reduction,

$$ES2_{ACTUAL} = ES2_{iw} \left( 1 - \frac{\text{Nominal efficiency \%}}{100\%} \right)$$

(iv) Emissions from Group 2 storage vessels at baseline,  $ES2_{IBASE}$ , shall be calculated as follows:

(A) If the fixed-roof vessel was uncontrolled on November 15, 1990,  $ES2_{IBASE} = ES2_{iw}$  and shall be calculated according to the procedures and equations for  $ES_{iw}$  in paragraph (g)(3)(i) of this section.

(B) If the storage vessel was controlled on November 15, 1990:

(1) The equations for  $ES_{ACTUAL}$  in paragraph (g)(3)(iii) of this section shall be used to calculate  $ES2_{IBASE}$  for vessels controlled with an internal floating roof that does not meet the specifications of §63.119 (b) or (d) of this subpart.

(2) The equations for  $ES_{ACTUAL}$  in paragraph (g)(3)(iv) of this section shall be used to calculate  $ES2_{IBASE}$  for vessels controlled with an external floating roof that does not meet the specifications of §63.119(c) of this subpart.

(3) The following equations shall be used to calculate  $ES2_{iBASE}$  for vessels controlled with a control device,

$$ES2_{iBASE} = ES2_{iw} \left( 1 - \frac{\text{Percent reduction \%}}{100\%} \right)$$

where  $ES2_{iw}$  shall be calculated according to the equations for  $ES_{iw}$  in paragraph (g)(3)(i) of this section. The percent reduction shall be calculated according to the procedures in paragraphs (g)(3)(ii)(B)(1) and (g)(3)(ii)(B)(2) of this section.

(4) Emissions from transfer racks shall be determined as follows:

(i) Uncontrolled emissions from Group 1 transfer racks,  $ETR1_{iw}$ , shall be calculated according to the procedures and equations for  $ETR_{iw}$  as described in paragraphs (g)(4)(i) through (g)(4)(iv) of this section.

(ii) Actual emissions from Group 1 transfer racks controlled using a technology with an approved nominal efficiency greater than 98 percent or a pollution prevention measure achieving greater than 98 percent emission reduction,  $ETR1_{iACTUAL}$ , shall be calculated according to the following equation:

$$ETR1_{iACTUAL} = ETR1_{iw} \left( 1 - \frac{\text{Nominal efficiency}}{100\%} \right)$$

(iii) The following procedures shall be used to calculate actual emissions from Group 2 transfer racks,  $ETR2_{iACTUAL}$ :

(A) For a Group 2 transfer rack controlled by a control device or a pollution prevention measure achieving a percent reduction less than or equal to 98 percent reduction,

$$ETR2_{iACTUAL} = ETR2_{iw} \left( 1 - \frac{\text{Percent reduction}}{100\%} \right)$$

(1)  $ETR2_{iw}$  shall be calculated according to the equations and procedures for  $ETR_{iw}$  in paragraphs (g)(4)(i) through (g)(4)(iv) of this section.

(2) The percent reduction shall be calculated according to the procedures in paragraph (g)(4)(v)(B)(1) and (g)(4)(v)(B)(2) of this section.

(B) For a Group 2 transfer rack controlled using a technology with an approved nominal efficiency greater than 98 percent or a pollution prevention measure achieving greater than 98 percent reduction,

$$ETR2_{iACTUAL} = ETR2_{iw} \left( 1 - \frac{\text{Nominal efficiency}}{100\%} \right)$$

(iv) Emissions from Group 2 transfer racks at baseline,  $ETR2_{iBASE}$ , shall be calculated as follows:

(A) If the transfer rack was uncontrolled on November 15, 1990,  $ETR2_{iBASE} = ETR2_{iw}$  and shall be calculated according to the procedures and equations for  $ETR_{iw}$  in paragraphs (g)(4)(i) through (g)(4)(iv) of this section.



(B) If the transfer rack was controlled on November 15, 1990,

$$ETR2_{iBASE} = ETR2_{iU} \left( 1 - \frac{\text{Percent reduction}}{100\%} \right)$$

where  $ETR2_{iU}$  is calculated according to the procedures and equations for  $ETR_{iU}$  in paragraphs (g)(4)(i) through (g)(4)(iv) of this section. Percent reduction shall be calculated according to the procedures in paragraphs (g)(4)(v)(B)(1) and (g)(4)(v)(B)(2) of this section.

(5) Emissions from wastewater shall be determined as follows:

(i)  $EWW1_{iC}$  shall be calculated according to the equation for  $EWW_{iC}$  in paragraph (g)(5)(i) of this section.

(ii)  $EWW2_{iBASE}$  shall be calculated according to the equation for  $EWW_{iACTUAL}$  in paragraph (g)(5)(ii) of this section for each Group 2 wastewater stream  $i$ , which on November 15, 1990, was not managed according to the requirements of §§63.133 through 63.137 of this subpart, as applicable.

(iii)  $EWW2_{iBASE}$  shall be calculated according to the equation for  $EWW_{iACTUAL}$  in paragraph (g)(5)(iii) of this section for each Group 2 wastewater stream  $i$ , which on November 15, 1990, was managed according to the requirements of §§63.133 through 63.137 of this subpart, as applicable, and was uncontrolled or controlled to a level less stringent than the reference control technology.

(iv) For Group 2 wastewater streams that are managed according to the requirements of §§63.133 through 63.137 of this subpart, as applicable,  $EWW2_{iACTUAL}$  shall be calculated as follows:

(A)  $EWW2_{iACTUAL}$  shall be calculated according to the equation for  $EWW_{iACTUAL}$  in paragraph (g)(5)(iii) of this section for each Group 2 wastewater stream  $i$  that is controlled to a level less stringent than, or equivalent to, the reference control technology.

(B)  $EWW2_{iACTUAL}$  shall be calculated according to the procedures for calculating  $EWW1_{iACTUAL}$  in paragraph (h)(5)(v) of this section for each Group 2 wastewater stream that is controlled to a level more stringent than the reference control technology.

(v) The following equations for  $EWW1_{iACTUAL}$  shall be used to calculate emissions from each Group 1 wastewater stream  $i$  that is managed according to the requirements of §§63.133 through 63.137 of this subpart, as applicable, and is controlled to a level more stringent than the reference control technology.

(A) If the Group 1 wastewater stream  $i$  is controlled using a treatment process or series of treatment processes with an approved nominal reduction efficiency in the concentration of table 9 HAP for stream  $i$  greater than that of the design steam stripper specified in §63.138(d) of this subpart, and the control device used to reduce table 9 HAP emissions from the vapor stream(s) vented from the treatment process(es) achieves a percent reduction equal to 95 percent, the following equation shall be used. All terms in this equation are as defined and determined in paragraph (g)(5) of this section.

$$EWW1_{iACTUAL} = (6.0 \times 10^{-8}) Q_i H_i \sum_{m=1}^5 [Fe_m HAP_{im} (1 - PR_m)] \\ + 0.05 (6.0 \times 10^{-8}) Q_i H_i \sum_{m=1}^5 [HAP_m PR_m]$$

(B) If the Group 1 wastewater stream  $i$  is not controlled using a treatment process or series of treatment processes with a nominal reduction efficiency in the table 9 HAP concentration greater than that of the design steam stripper specified in §63.138(d) of this subpart, but the vapor stream(s) vented from the treatment process(es) are controlled using a device with an approved nominal efficiency greater than 95 percent, the following equation shall be used. All terms other than nominal efficiency are as defined and determined in paragraph (g)(5) of this section.

$$EWW1_{ACTUAL} = (6.0 \cdot 10^{-8}) Q_i H_i \sum_{m=1}^5 [Fe_m HAP_{im} (1 - Fr_m)] \\ + \left(1 - \frac{\text{Nominal efficiency \%}}{100}\right) (6.0 \cdot 10^{-8}) Q_i H_i \sum_{m=1}^5 [HAP_{im} Fr_m]$$

(C) If the Group 1 wastewater stream  $i$  is controlled using a treatment process or series of treatment processes with an approved nominal reduction efficiency in the table 9 HAP concentration greater than that of the design steam stripper specified in §63.138(d) of this subpart, and the vapor stream(s) vented from the treatment process are controlled using a device with an approved nominal efficiency greater than 95 percent, the following equation shall be used. All terms other than nominal efficiency are as defined and determined in paragraph (g)(5) of this section.

$$EWW1_{ACTUAL} = (6.0 \cdot 10^{-8}) Q_i H_i \sum_{m=1}^5 [Fe_m HAP_{im} (1 - PR_{im})] \\ + \left(1 - \frac{\text{Nominal efficiency \%}}{100}\right) (6.0 \cdot 10^{-8}) Q_i H_i \sum_{m=1}^5 [HAP_{im} PR_{im}]$$

(i) The following procedures shall be followed to establish nominal efficiencies. The procedures in paragraphs (i)(1) through (i)(6) of this section shall be followed for control technologies that are different in use or design from the reference control technologies and achieve greater percent reductions than the percent efficiencies assigned to the reference control technologies in §63.111 of this subpart.

(1) In those cases where the owner or operator is seeking permission to take credit for use of a control technology that is different in use or design from the reference control technology, and the different control technology will be used in more than three applications at a single plant-site, the owner or operator shall submit the information specified in paragraphs (i)(1)(i) through (i)(1)(iv) of this section to the Director of the EPA Office of Air Quality Planning and Standards in writing:

(i) Emission stream characteristics of each emission point to which the control technology is or will be applied including the kind of emission point, flow, organic HAP concentration, and all other stream characteristics necessary to design the control technology or determine its performance.

(ii) Description of the control technology including design specifications.

(iii) Documentation demonstrating to the Administrator's satisfaction the control efficiency of the control technology. This may include performance test data collected using an appropriate EPA method or any other method validated according to Method 301 of appendix A of this part. If it is infeasible to obtain test data, documentation may include a design evaluation and calculations. The engineering basis of the calculation procedures and all inputs and assumptions made in the calculations shall be documented.

(iv) A description of the parameter or parameters to be monitored to ensure that the control technology will be operated in conformance with its design and an explanation of the criteria used for selection of that parameter (or parameters).

(2) The Administrator shall determine within 120 calendar days whether an application presents sufficient information to determine nominal efficiency. The Administrator reserves the right to request specific data in addition to the items listed in paragraph (i)(1) of this section.

(3) The Administrator shall determine within 120 calendar days of the submittal of sufficient data whether a control technology shall have a nominal efficiency and the level of that nominal efficiency. If, in the Administrator's judgment, the control technology achieves a level of emission reduction greater than the reference control technology for a particular kind of emission point, the Administrator will publish a FEDERAL REGISTER notice establishing a nominal efficiency for the control technology.

(4) The Administrator may condition permission to take emission credits for use of the control technology on requirements that may be necessary to ensure operation and maintenance to achieve the specified nominal efficiency.

(5) In those cases where the owner or operator is seeking permission to take credit for use of a control technology that is different in use or design from the reference control technology and the different control technology will be used in no more than three applications at a single plant site, the information listed in paragraphs (i)(1)(i) through (i)(1)(iv) can be submitted to the permitting authority for the source for approval instead of the Administrator.

(i) In these instances, use and conditions for use of the control technology can be approved by the permitting authority as part of an operating permit application or modification. The permitting authority shall follow the procedures specified in paragraphs (i)(2) through (i)(4) of this section except that, in these instances, a FEDERAL REGISTER notice is not required to establish the nominal efficiency for the different technology.

(ii) If, in reviewing the application, the permitting authority believes the control technology has broad applicability for use by other sources, the permitting authority shall submit the information provided in the application to the Director of the EPA Office of Air Quality Planning and Standards. The Administrator shall review the technology for broad applicability and may publish a FEDERAL REGISTER notice; however, this review shall not affect the permitting authority's approval of the nominal efficiency of the control technology for the specific application.

(6) If, in reviewing an application for a control technology for an emission point, the Administrator or permitting authority determines the control technology is not different in use or design from the reference control technology, the Administrator or permitting authority shall deny the application.

(j) The following procedures shall be used for calculating the efficiency (percent reduction) of pollution prevention measures:

(1) A pollution prevention measure is any practice which meets the criteria of paragraphs (j)(1)(i) and (j)(1)(ii) of this section.

(i) A pollution prevention measure is any practice that results in a lesser quantity of organic HAP emissions per unit of product released to the atmosphere prior to out-of-process recycling, treatment, or control of emissions, while the same product is produced.

(ii) Pollution prevention measures may include: substitution of feedstocks that reduce HAP emissions; alterations to the production process to reduce the volume of materials released to the

environment; equipment modifications; housekeeping measures; and in-process recycling that returns waste materials directly to production as raw materials. Production cutbacks do not qualify as pollution prevention.

(2) The emission reduction efficiency of pollution prevention measures implemented after November 15, 1990, can be used in calculating the actual emissions from an emission point in the debit and credit equations in paragraphs (g) and (h) of this section. When the term "organic HAP" is used in §63.150(j)(2) in reference to wastewater emission points, the term "table 9 HAP" shall apply for the purposes of this paragraph.

(i) For pollution prevention measures, the percent reduction used in the equations in paragraphs (g)(2) through (g)(5) of this section and paragraphs (h)(2) through (h)(5) of this section is the percent difference between the monthly organic HAP emissions for each emission point after the pollution prevention measure for the most recent month versus monthly emissions from the same emission point before the pollution prevention measure, adjusted by the volume of product produced during the two monthly periods.

(ii) The following equation shall be used to calculate the percent reduction of a pollution prevention measure for each emission point.

$$\text{Percent reduction} = \frac{E_B - \frac{(E_{pp} \times P_B)}{P_{pp}}}{E_B} \times 100\%$$

where:

Percent reduction = Efficiency of pollution prevention measure (percent organic HAP reduction).

$E_B$  = Monthly emissions before the pollution prevention measure, megagrams per month, determined as specified in paragraphs (j)(2)(ii)(A), (j)(2)(ii)(B), and (j)(2)(ii)(C) of this section.

$E_{pp}$  = Monthly emissions after the pollution prevention measure, megagrams per month, as determined for the most recent month, determined as specified in paragraphs (j)(2)(ii)(D) or (j)(2)(ii)(E) of this section.

$P_B$  = Monthly production before the pollution prevention measure, megagrams per month, during the same period over which  $E_B$  is calculated.

$P_{pp}$  = Monthly production after the pollution prevention measure, megagrams per month, as determined for the most recent month.

(A) The monthly emissions before the pollution prevention measure,  $E_B$ , shall be determined in a manner consistent with the equations and procedures in paragraphs (g)(2), (g)(3), and (g)(4) of this section for process vents, storage vessels, and transfer operations.

(B) For wastewater,  $E_B$  shall be calculated as follows:

$$E_B = \sum_{i=1}^n \left[ (6.0 \times 10^{-8}) Q_{B_i} H_{B_i} \sum_{m=1}^j Fe_m HAP_{B_m} \right]$$

Where:

n = Number of wastewater streams.

$Q_{Bi}$  = Average flow rate for wastewater stream i before the pollution prevention measure, defined and determined according to paragraph (g)(5)(i) of this section, liters per minute, before implementation of the pollution prevention measure.

$H_{Bi}$  = Number of hours per month that wastewater stream i was discharged before the pollution prevention measure, hours per month.

s = Total number of table 9 HAP in wastewater stream i.

$Fe_m$  = Fraction emitted of table 9 HAP m in wastewater of this subpart, dimensionless.

$HAP_{Bim}$  = Average concentration of table 9 HAP m in wastewater stream i, defined and determined according to paragraph (g)(5)(i) of this section, before the pollution prevention measure, parts per million by weight, as measured before the implementation of the pollution measure.

(C) If the pollution prevention measure was implemented prior to April 22, 1994, records may be used to determine  $E_B$ .

(D) The monthly emissions after the pollution prevention measure,  $E_{pp}$ , may be determined during a performance test or by a design evaluation and documented engineering calculations. Once an emissions-to-production ratio has been established, the ratio can be used to estimate monthly emissions from monthly production records.

(E) For wastewater,  $E_{pp}$  shall be calculated using the following equation:

$$E_{pp} = \sum_{i=1}^n \left[ (6.0 * 10^{-8}) Q_{ppi} H_{ppi} \sum_{m=1}^s Fe_m HAP_{ppim} \right]$$

where n,  $Q_{ppi}$ ,  $H_{ppi}$ , s,  $Fe_m$ , and  $HAP_{ppim}$  are defined and determined as described in paragraph (j)(2)(ii)(B) of this section except that  $Q_{ppi}$ ,  $H_{ppi}$ , and  $HAP_{ppim}$  shall be determined after the pollution prevention measure has been implemented.

(iii) All equations, calculations, test procedures, test results, and other information used to determine the percent reduction achieved by a pollution prevention measure for each emission point shall be fully documented.

(iv) The same pollution prevention measure may reduce emissions from multiple emission points. In such cases, the percent reduction in emissions for each emission point must be calculated.

(v) For the purposes of the equations in paragraphs (h)(2) through (h)(5) of this section, used to calculate credits for emission points controlled more stringently than the reference control technology, the nominal efficiency of a pollution prevention measure is equivalent to the percent reduction of the pollution prevention measure. When a pollution prevention measure is used, the owner or operator of a source is not required to apply to the Administrator for a nominal efficiency and is not subject to paragraph (i) of this section.

(k) The owner or operator must demonstrate that the emissions from the emission points proposed to be included in the average will not result in greater hazard or, at the option of the operating permit authority, greater risk to human health or the environment than if the emission points were controlled according to the provisions in §§63.113 through 63.148.

(1) This demonstration of hazard or risk equivalency shall be made to the satisfaction of the operating permit authority.

(i) The Administrator may require owners and operators to use specific methodologies and procedures for making a hazard or risk determination.

(ii) The demonstration and approval of hazard or risk equivalency shall be made according to any guidance that the Administrator makes available for use.

(2) Owners and operators shall provide documentation demonstrating the hazard or risk equivalency of their proposed emissions average in their operating permit application or in their Implementation Plan if an operating permit application has not yet been submitted.

(3) An emissions averaging plan that does not demonstrate hazard or risk equivalency to the satisfaction of the Administrator shall not be approved. The Administrator may require such adjustments to the emissions averaging plan as are necessary in order to ensure that the average will not result in greater hazard or risk to human health or the environment than would result if the emission points were controlled according to §§63.113 through 63.148 of this subpart.

(4) A hazard or risk equivalency demonstration must:

(i) Be a quantitative, bona fide chemical hazard or risk assessment;

(ii) Account for differences in chemical hazard or risk to human health or the environment; and

(iii) Meet any requirements set by the Administrator for such demonstrations.

(l) For periods of excursions, an owner or operator may request that the provisions of paragraphs (l)(1) through (l)(4) of this section be followed instead of the procedures in paragraphs (f)(3)(i) and (f)(3)(ii) of this section.

(1) The owner or operator shall notify the Administrator of excursions in the Periodic Reports as required in §63.152 of this subpart.

(2) The owner or operator shall demonstrate that other types of monitoring data or engineering calculations are appropriate to establish that the control device for the emission point was operating in such a fashion to warrant assigning full or partial credits and debits. This demonstration shall be made to the Administrator's satisfaction, and the Administrator may establish procedures of demonstrating compliance that are acceptable.

(3) The owner or operator shall provide documentation of the excursion and the other type of monitoring data or engineering calculations to be used to demonstrate that the control device for the emission point was operating in such a fashion to warrant assigning full or partial credits and debits.

(4) The Administrator may assign full or partial credit and debits upon review of the information provided.

(m) For each Group 1 or Group 2 emission point included in an emissions average, the owner or operator shall perform testing, monitoring, recordkeeping, and reporting equivalent to that required for Group 1 emission points complying with §§63.113 through 63.148 of this subpart. The specific requirements for process vents, storage vessels, transfer racks, and wastewater are identified in paragraphs (m)(1) through (m)(6) of this section.

(1) The source shall implement the following testing, monitoring, recordkeeping, and reporting procedures for each process vent equipped with a flare, incinerator, boiler, or process heater.

(i) Determine, consistent with paragraph (g)(2)(i) of this section, whether the process vent is Group 1 or Group 2 according to the procedures in §63.115.

(ii) Conduct initial performance tests to determine percent reduction as specified in §63.116 of this subpart;

(iii) Monitor the operating parameters, keep records, and submit reports specified in §63.114, §63.117(a), and §63.118 (a), (f), and (g) of this subpart, as appropriate for the specific control device.

(2) The source shall implement the following procedures for each process vent equipped with a carbon adsorber, absorber, or condenser but not equipped with a control device:

(i) Determine, consistent with paragraph (g)(2)(i) of this section, the flow rate, organic HAP concentration, and TRE index value using the methods specified in §63.115;

(ii) Monitor the operating parameters, keep records, and submit reports specified in §63.114, §63.117(a), and §63.118(b), (f), and (g) of this subpart, as appropriate for the specific recovery device.

(3) The source shall implement the following procedures for each storage vessel controlled with an internal floating roof, external roof, or a closed vent system with a control device, as appropriate to the control technique:

(i) Perform the monitoring or inspection procedures in §63.120 of this subpart,

(ii) Perform the reporting and recordkeeping procedures in §§63.122 and 63.123 of this subpart, and

(iii) For closed vent systems with control devices, conduct an initial design evaluation and submit an operating plan as specified in §63.120(d) and §63.122(a)(2) and (b) of this subpart.

(4) The source shall implement the following procedures for each transfer rack controlled with a vapor balancing system, or a vapor collection system and an incinerator, flare, boiler, process heater, adsorber, condenser, or absorber, as appropriate to the control technique:

(i) The monitoring and inspection procedures in §63.127 of this subpart,

(ii) The testing and compliance procedures in §63.128 of this subpart, and

(iii) The reporting and recordkeeping procedures in §63.129 and §63.130 of this subpart.

(5) The source shall implement the following procedures for wastewater emission points, as appropriate to the control techniques:

(i) For wastewater treatment processes, conduct tests as specified in §63.138(j) of this subpart.

(ii) Conduct inspections and monitoring as specified in §63.143 of this subpart.

(iii) A recordkeeping program as specified in §63.147 of this subpart.

(iv) A reporting program as specified in §63.146 of this subpart.

(6) If an emission point in an emissions average is controlled using a pollution prevention measure or a device or technique for which no monitoring parameters or inspection procedures are specified in

§63.114, §63.120, §63.127, or §63.143 of this subpart, the owner or operator shall submit the information specified in §63.151(f) of this subpart in the Implementation Plan or operating permit application.

(n) Records of all information required to calculate emission debits and credits shall be retained for five years.

(o) Initial Notifications, Implementation Plans, Notifications of Compliance Status, Periodic Reports, and other reports shall be submitted as required by §63.151 and §63.152 of this subpart.

[59 FR 19468, Apr. 22, 1994, as amended at 60 FR 63628, Dec. 12, 1995; 64 FR 20192, Apr. 26, 1999; 66 FR 6934, Jan. 22, 2001]

### **§63.151 Initial notification.**

(a) Each owner or operator of a source subject to this subpart shall submit the reports listed in paragraphs (a)(1) through (a)(5) of this section. Owners or operators requesting an extension of compliance shall also submit the report listed in paragraph (a)(6) of this section.

(1) An Initial Notification described in paragraph (b) of this section, and

(2) An Implementation Plan for new sources subject to this subpart or for emission points to be included in an emissions average, unless an operating permit application has been submitted prior to the date the Implementation Plan is due and the owner or operator has elected to include the information specified in §63.152(e) in that application. The submittal date and contents of the Implementation Plan are specified in paragraphs (c) and (d) of this section.

(3) A Notification of Compliance Status described in §63.152 of this subpart,

(4) Periodic Reports described in §63.152 of this subpart, and

(5) Other reports described in §63.152 of this subpart.

(6) Pursuant to section 112(i)(3)(B) of the Act, an owner or operator may request an extension allowing the existing source up to 1 additional year to comply with section 112(d) standards.

(i) For purposes of this subpart, a request for an extension shall be submitted to the permitting authority as part of the operating permit application or as part of the Initial Notification or as a separate submittal. Requests for extensions shall be submitted no later than 120 days prior to the compliance dates specified in §63.100(k)(2), §63.100(l)(4), and §63.100(m) of subpart F of this part, except as provided for in paragraph (a)(6)(iv) of this section. The dates specified in §63.6(i) of subpart A of this part for submittal of requests for extensions shall not apply to sources subject to this subpart G.

(ii) A request for an extension of compliance must include the data described in §63.6(i)(6)(i) (A), (B), and (D) of subpart A of this part.

(iii) The requirements in §63.6(i)(8) through (i)(14) of subpart A will govern the review and approval of requests for extensions of compliance with this subpart.

(iv) An owner or operator may submit a compliance extension request after the date specified in paragraph (a)(6)(i) of this section provided the need for the compliance extension arose after that date and before the otherwise applicable compliance date, and the need arose due to circumstances beyond reasonable control of the owner or operator. This request shall include, in addition to the information in



paragraph (a)(6)(ii) of this section, a statement of the reasons additional time is needed and the date when the owner or operator first learned of the problem.

(7) The reporting requirements for storage vessels are located in §63.122 of this subpart.

(b) Each owner or operator of an existing or new source subject to subpart G shall submit a written Initial Notification to the Administrator, containing the information described in paragraph (b)(1) of this section, according to the schedule in paragraph (b)(2) of this section. The Initial Notification provisions in §63.9(b)(2), (b)(3), and (b)(6) of subpart A shall not apply to owners or operators of sources subject to subpart G.

(1) The Initial Notification shall include the following information:

(i) The name and address of the owner or operator;

(ii) The address (physical location) of the affected source;

(iii) An identification of the kinds of emission points within the source that are subject to this subpart;

(iv) An identification of the chemical manufacturing processes subject to subpart G; and

(v) A statement of whether the source can achieve compliance by the relevant compliance date specified in §63.100 of subpart F.

(2) The Initial Notification shall be submitted according to the schedule in paragraph (b)(2)(i), (b)(2)(ii), or (b)(2)(iii) of this section, as applicable.

(i) For an existing source, the Initial Notification shall be submitted within 120 calendar days after the date of promulgation.

(ii) For a new source that has an initial start-up 90 calendar days after the date of promulgation of this subpart or later, the application for approval of construction or reconstruction required by §63.5(d) of subpart A shall be submitted in lieu of the Initial Notification. The application shall be submitted as soon as practicable before construction or reconstruction is planned to commence (but it need not be sooner than 90 calendar days after the date of promulgation of this subpart).

(iii) For a new source that has an initial start-up prior to 90 calendar days after the date of promulgation, the Initial Notification shall be submitted within 90 calendar days after the date of promulgation of this subpart. The application for approval of construction or reconstruction described in §63.5(d) of subpart A is not required for these sources.

(c) Each owner or operator of an existing source with emission points that will be included in an emissions average or new source subject to this subpart must submit an Implementation Plan to the Administrator by the dates specified in paragraphs (c)(1) and (c)(2) of this section, unless an operating permit application accompanied by the information specified in §63.152(e) of this subpart has been submitted. The Implementation Plan for emissions averaging is subject to Administrator approval.

(1) Each owner or operator of an existing source subject to this subpart who elects to comply with §63.112 of this subpart by using emissions averaging for any emission points, and who has not submitted an operating permit application accompanied by the information specified in §63.152(e) of this subpart at least 18 months prior to the compliance dates specified in §63.100 of subpart F of this part, shall develop an Implementation Plan for emissions averaging. For existing sources, the Implementation Plan for those

emission points to be included in an emissions average shall be submitted no later than 18 months prior to the compliance dates in §63.100 of subpart F of this part.

(2) Each owner or operator of a new source shall submit an Implementation Plan by the date specified in paragraphs (c)(2)(i) or (c)(2)(ii) of this section, as applicable, unless an operating permit application containing the information in paragraph (e) of this section has been submitted by that date.

(i) For a new source that has an initial start-up 90 calendar days after the date of promulgation of this subpart or later, the Implementation Plan shall be submitted with the application for approval of construction or reconstruction by the date specified in paragraph (b)(2)(ii) of this section.

(ii) For a new source that has an initial start-up prior to 90 calendar days after the date of promulgation, the Implementation Plan shall be submitted within 90 calendar days after the date of promulgation of this subpart.

(3) The Administrator shall determine within 120 calendar days whether the Implementation Plan submitted by sources using emissions averaging presents sufficient information. The Administrator shall either approve the Implementation Plan, request changes, or request that the owner or operator submit additional information. Once the Administrator receives sufficient information, the Administrator shall approve, disapprove, or request changes to the plan within 120 calendar days.

(d) Each owner or operator required to submit an Implementation Plan for emissions averaging shall include in the plan, for all emission points included in the emissions average, the information listed in paragraphs (d)(1) through (d)(8) of this section.

(1) The identification of all emission points in the planned emissions average and notation of whether each point is a Group 1 or Group 2 emission point as defined in §63.111 of this subpart.

(2) The projected emission debits and credits for each emission point and the sum for the emission points involved in the average calculated according to §63.150 of this subpart. The projected credits must be greater than the projected debits, as required under §63.150(e)(3) of this subpart.

(3) The specific control technology or pollution prevention measure that will be used for each emission point included in the average and date of application or expected date of application.

(4) The specific identification of each emission point affected by a pollution prevention measure. To be considered a pollution prevention measure, the criteria in §63.150(j)(1) of this subpart must be met. If the same pollution prevention measure reduces or eliminates emissions from multiple emission points in the average, the owner or operator must identify each of these emission points.

(5) A statement that the compliance demonstration, monitoring, inspection, recordkeeping, and reporting provisions in §63.150(m), (n), and (o) of this subpart that are applicable to each emission point in the emissions average will be implemented beginning on the date of compliance.

(6) Documentation of the information listed in paragraph (d)(6)(i) through (d)(6)(v) of this section for each process vent, storage vessel, or transfer rack included in the average.

(i) The values of the parameters used to determine whether the emission point is Group 1 or Group 2. Where TRE index value is used for process vent group determination, the estimated or measured values of the parameters used in the TRE equation in §63.115(d) of this subpart (flow rate, organic HAP emission rate, TOC emission rate, and net heating value) and the resulting TRE index value shall be submitted.

(ii) The estimated values of all parameters needed for input to the emission debit and credit calculations in §63.150 (g) and (h) of this subpart. These parameter values, or as appropriate, limited ranges for the parameter values, shall be specified in the source's Implementation Plan (or operating permit) as enforceable operating conditions. Changes to these parameters must be reported as required by paragraph (i)(2)(ii) of this section.

(iii) The estimated percent reduction if a control technology achieving a lower percent reduction than the efficiency of the reference control technology, as defined in §63.111 of this subpart, is or will be applied to the emission point.

(iv) The anticipated nominal efficiency if a control technology achieving a greater percent emission reduction than the efficiency of the reference control technology is or will be applied to the emission point. The procedures in §63.150(i) of this subpart shall be followed to apply for a nominal efficiency.

(v) The operating plan required in §63.122(a)(2) and (b) of this subpart for each storage vessel controlled with a closed-vent system with a control device other than a flare.

(7) The information specified in §63.151(f) of this subpart shall be included in the Implementation Plan for:

(i) Each process vent or transfer rack controlled by a pollution prevention measure or control technique for which monitoring parameters or inspection procedures are not specified in §63.114, §63.126(b)(3), or §63.127 of this subpart, and

(ii) Each storage vessel controlled by pollution prevention or a control technique other than an internal or external floating roof or a closed vent system with a control device.

(8) Documentation of the information listed in paragraph (d)(8)(i) through (d)(8)(iv) for each process wastewater stream included in the average.

(i) The information used to determine whether the wastewater stream is a Group 1 or Group 2 wastewater stream.

(ii) The estimated values of all parameters needed for input to the wastewater emission credit and debit calculations in §63.150 (g)(5) and (h)(5) of this subpart.

(iii) The estimated percent reduction if:

(A) A control technology that achieves an emission reduction less than or equal to the emission reduction achieved by the design steam stripper, as specified in §63.138(g) of this subpart, is or will be applied to the wastewater stream, or

(B) A control technology achieving less than or equal to 95 percent emission reduction is or will be applied to the vapor stream(s) vented and collected from the treatment processes, or

(C) A pollution prevention measure is or will be applied.

(iv) The anticipated nominal efficiency if the owner or operator plans to apply for a nominal efficiency under §63.150(i) of this subpart. A nominal efficiency shall be applied for if:

(A) A control technology is or will be applied to the wastewater stream and achieves an emission reduction greater than the emission reduction achieved by the design steam stripper as specified in §63.138(g) of this subpart, or

(B) A control technology achieving greater than 95 percent emission reduction is or will be applied to the vapor stream(s) vented and collected from the treatment processes.

(v) For each pollution prevention measure, treatment process, or control device used to reduce air emissions of organic HAP's from wastewater and for which no monitoring parameters or inspection procedures are specified in §63.143 of this subpart, the information specified in §63.151(f) of this subpart shall be included in the Implementation Plan.

(e) An owner or operator expressly referred to this paragraph shall report, in an Implementation Plan, operating permit application, or as otherwise specified by the permitting authority, the information listed in paragraphs (e)(1) through (e)(5) of this section.

(1) A list designating each emission point complying with §§63.113 through 63.149 and whether each emission point is Group 1 or Group 2, as defined in §63.111. For each process vent within the source, provide the information listed in paragraphs (e)(1)(i) through (iv) of this section.

(i) The chemical manufacturing process unit(s) that is the origin of all or part of the vent stream that exits the process vent.

(ii) The type(s) of unit operations (i.e., an air oxidation reactor, distillation unit, or reactor) that creates the vent stream that exits the process vent.

(iii) For a Group 2 process vent, the last recovery device, if any.

(iv) For a Group 1 process vent, the control device, or other equipment used for compliance.

(2) The control technology or method of compliance that will be applied to each Group 1 emission point.

(3) A statement that the compliance demonstration, monitoring, inspection, recordkeeping, and reporting provisions in §§63.113 through 63.149 of this subpart that are applicable to each emission point will be implemented beginning on the date of compliance.

(4) The operating plan required in §63.122(a)(2) and (b) of this subpart for each storage vessel controlled with a closed vent system with a control device other than a flare.

(5) The monitoring information in §63.151(f) of this subpart if, for any emission point, the owner or operator of a source seeks to comply through use of a control technique other than those for which monitoring parameters are specified in §63.114 for process vents, §63.127 for transfer, and §63.143 for process wastewater.

(f) The owner or operator who has been directed by any section of this subpart that expressly references this paragraph to set unique monitoring parameters or who requests approval to monitor a different parameter than those listed in §63.114 for process vents, §63.127 for transfer, or §63.143 for process wastewater of this subpart shall submit the information specified in paragraphs (f)(1), (f)(2), and (f)(3) of this section with the operating permit application or as otherwise specified by the permitting authority.

(1) A description of the parameter(s) to be monitored to ensure the control technology or pollution prevention measure is operated in conformance with its design and achieves the specified emission limit, percent reduction, or nominal efficiency, and an explanation of the criteria used to select the parameter(s).

(2) A description of the methods and procedures that will be used to demonstrate that the parameter indicates proper operation of the control device, the schedule for this demonstration, and a statement that the owner or operator will establish a range for the monitored parameter as part of the Notification of Compliance Status report required in §63.152(b) of this subpart, unless this information has already been included in the operating permit application.

(3) The frequency and content of monitoring, recording, and reporting if monitoring and recording is not continuous, or if reports of daily average values when the monitored parameter value is outside the range established in the operating permit or Notification of Compliance Status will not be included in Periodic Reports required under §63.152(c) of this subpart. The rationale for the proposed monitoring, recording, and reporting system shall be included.

(g) An owner or operator may request approval to use alternatives to the continuous operating parameter monitoring and recordkeeping provisions listed in §§63.114, 63.117, and 63.118 for process vents, §§63.127, 63.129, and 63.130 for transfer operations, and §§63.143, 63.146, and 63.147 for wastewater.

(1) Requests shall be included in the operating permit application or as otherwise specified by the permitting authority and shall contain the information specified in paragraphs (g)(3) through (g)(5) of this section, as applicable.

(2) The provisions in §63.8(f)(5)(i) of subpart A shall govern the review and approval of requests.

(3) An owner or operator of a source that does not have an automated monitoring and recording system capable of measuring parameter values at least once every 15 minutes and generating continuous records may request approval to use a non-automated system with less frequent monitoring.

(i) The requested system shall include manual reading and recording of the value of the relevant operating parameter no less frequently than once per hour. Daily average values shall be calculated from these hourly values and recorded.

(ii) The request shall contain:

(A) A description of the planned monitoring and recordkeeping system;

(B) Documentation that the source does not have an automated monitoring and recording system;

(C) Justification for requesting an alternative monitoring and recordkeeping system; and

(D) Demonstration to the Administrator's satisfaction that the proposed monitoring frequency is sufficient to represent control device operating conditions considering typical variability of the specific process and control device operating parameter being monitored.

(4) An owner or operator may request approval to use an automated data compression recording system that does not record monitored operating parameter values at a set frequency (for example once every 15 minutes) but records all values that meet set criteria for variation from previously recorded values.

(i) The requested system shall be designed to:

(A) Measure the operating parameter value at least once every 15 minutes.

(B) Record at least four values each hour during periods of operation.

(C) Record the date and time when monitors are turned off or on.

(D) Recognize unchanging data that may indicate the monitor is not functioning properly, alert the operator, and record the incident.

(E) Compute daily average values of the monitored operating parameter based on recorded data.

(F) If the daily average is not an excursion, as defined in §63.152(c)(2)(ii), the data for that operating day may be converted to hourly average values and the four or more individual records for each hour in the operating day may be discarded.

(ii) The request shall contain a description of the monitoring system and data compression recording system, including the criteria used to determine which monitored values are recorded and retained, the method for calculating daily averages, and a demonstration that the system meets all criteria in paragraph (g)(4)(i) of this section.

(5) An owner or operator may request approval to use other alternative monitoring systems according to the procedures specified in §63.8(f) of subpart A of this part.

(h) The owner or operator required to prepare an Implementation Plan, or otherwise required to submit a report, under paragraph (c), (d), or (e) of this section shall also submit a supplement for any additional alternative controls or operating scenarios that may be used to achieve compliance.

(i) The owner or operator of a source required to submit an Implementation Plan for emissions averaging under paragraphs (c) and (d) of this section shall also submit written updates of the Implementation Plan to the Administrator for approval under the circumstances described in paragraphs (i)(1) and (i)(2) of this section unless the relevant information has been included and submitted in an operating permit application or amendment.

(1) The owner or operator who plans to make a change listed in paragraph (i)(1)(i) or (i)(1)(ii) of this section shall submit an Implementation Plan update at least 120 calendar days prior to making the change.

(i) Whenever an owner or operator elects to achieve compliance with the emissions averaging provisions in §63.150 of this subpart by using a control technique other than that specified in the Implementation Plan or plans to monitor a different parameter or operate a control device in a manner other than that specified in the Implementation Plan.

(ii) Whenever an emission point or a chemical manufacturing process unit is added to an existing source and is planned to be included in an emissions average, or whenever an emission point not included in the emissions average described in the Implementation Plan is to be added to an emissions average. The information in paragraph (d) of this section shall be updated to include the additional emission point.

(2) The owner or operator who has made a change listed in paragraph (i)(2)(i) or (i)(2)(ii) of this section shall submit an Implementation Plan update within 90 calendar days after the information regarding the change is known to the source. The update may be submitted in the next quarterly Periodic Report if the change is made after the date the Notification of Compliance status is due.

(i) Whenever a process change is made such that the group status of any emission point in an emissions average changes.

(ii) Whenever a value of a parameter in the emission credit or debit equations in §63.150(g) or (h) changes such that it is outside the range specified in the Implementation Plan and causes a decrease in the projected credits or an increase in the projected debits.

(3) The Administrator shall approve or request changes to the Implementation Plan update within 120 calendar days of receipt of sufficient information regarding the change for emission points included in emissions averages.

(j) The owner or operator of a source subject to this subpart, for emission points that are not included in an emissions average, shall report to the Administrator under the circumstances described in paragraphs (j)(1), (j)(2), and (j)(3) of this section unless the relevant information has been included and submitted in an operating permit application or amendment, or as otherwise specified by the permitting authority. The information shall be submitted within 180 calendar days after the change is made or the information regarding the change is known to the source. The update may be submitted in the next Periodic Report if the change is made after the date the Notification of Compliance Status is due.

(1) Whenever a deliberate change is made such that the group status of any emission point changes. The information submitted shall include a compliance schedule as specified in §63.100 of subpart F of this part if the emission point becomes Group 1.

(2) Whenever an owner or operator elects to achieve compliance with this subpart by using a control technique other than that previously reported to the Administrator or to the permitting authority, or plans to monitor a different parameter, or operate a control device in a manner other than that previously reported.

(3) Whenever an emission point or a chemical manufacturing process unit is added to a source, written information specified under paragraphs (e)(1) through (e)(5) of this section, containing information on the new emission point(s) shall be submitted to the EPA regional office where the source is located.

[59 FR 19468, Apr. 22, 1994, as amended at 60 FR 63628, Dec. 12, 1995; 61 FR 7718, Feb. 29, 1996; 61 FR 64576, Dec. 5, 1996; 64 FR 20195, Apr. 26, 1999; 66 FR 6934, Jan. 22, 2001]

### **§63.152 General reporting and continuous records.**

(a) The owner or operator of a source subject to this subpart shall submit the reports listed in paragraphs (a)(1) through (a)(5) of this section and keep continuous records of monitored parameters as specified in paragraph (f) of this section. Owners or operators requesting an extension of compliance shall also submit the report described in §63.151(a)(6) of this subpart.

(1) An Initial Notification described in §63.151(b) of this subpart.

(2) An Implementation Plan described in §63.151(c), (d), and (e) of this subpart for existing sources with emission points that are included in an emissions average or for new sources.

(3) A Notification of Compliance Status described in paragraph (b) of this section.

(4) Periodic Reports described in paragraph (c) of this section.

(5) Other reports described in paragraphs (d) and (e) of this section.

(b) Each owner or operator of a source subject to this subpart shall submit a Notification of Compliance Status within 150 calendar days after the compliance dates specified in §63.100 of subpart F of this part.

(1) The notification shall include the results of any emission point group determinations, performance tests, inspections, continuous monitoring system performance evaluations, values of monitored parameters established during performance tests, and any other information used to demonstrate compliance or required to be included in the Notification of Compliance Status under §63.110 (h) for regulatory overlaps, under §63.117 for process vents, §63.122 for storage vessels, §63.129 for transfer operations, §63.146 for process wastewater, and §63.150 for emission points included in an emissions average.

(i) For performance tests and group determinations that are based on measurements, the Notification of Compliance Status shall include one complete test report for each test method used for a particular kind of emission point. For additional tests performed for the same kind of emission point using the same method, the results and any other information required in §63.117 for process vents, §63.129 for transfer, and §63.146 for process wastewater shall be submitted, but a complete test report is not required.

(ii) A complete test report shall include a brief process description, sampling site description, description of sampling and analysis procedures and any modifications to standard procedures, quality assurance procedures, record of operating conditions during the test, record of preparation of standards, record of calibrations, raw data sheets for field sampling, raw data sheets for field and laboratory analyses, documentation of calculations, and any other information required by the test method.

(2) For each monitored parameter for which a range is required to be established under §63.114 for process vents, §63.127 for transfer, §63.143 for process wastewater, §63.150(m) for emission points in emissions averages, or §63.151(f), or §63.152(e), the Notification of Compliance Status shall include the information in paragraphs (b)(2)(i), (b)(2)(ii), and (b)(2)(iii) of this section, unless the range and the operating day definition have been established in the operating permit. The recordkeeping and reporting requirements applicable to storage vessels are located in §§63.122 and 63.123.

(i) The specific range of the monitored parameter(s) for each emission point;

(ii) The rationale for the specific range for each parameter for each emission point, including any data and calculations used to develop the range and a description of why the range indicates proper operation of the control device.

(A) If a performance test is required by this subpart for a control device, the range shall be based on the parameter values measured during the performance test and may be supplemented by engineering assessments and/or manufacturer's recommendations. Performance testing is not required to be conducted over the entire range of permitted parameter values.

(B) If a performance test is not required by this subpart for a control device, the range may be based solely on engineering assessments and/or manufacturer's recommendations.

(iii) A definition of the source's operating day for purposes of determining daily average values of monitored parameters. The definition shall specify the times at which an operating day begins and ends.

(3) For emission points included in an emissions average, the Notification of Compliance Status shall include the values of all parameters needed for input to the emission credit and debit equations in §63.150 (g) and (h), calculated or measured according to the procedures in §63.150 (g) and (h) of this subpart, and the resulting calculation of credits and debits for the first quarter of the year. The first quarter begins on the compliance date specified in §63.100 of subpart F.

(4) If any emission point is subject to this subpart and to other standards as specified in §63.110 of this subpart and if the provisions of §63.110 of this subpart allow the owner or operator to choose which testing, monitoring, reporting, and recordkeeping provisions will be followed, then the Notification of



Compliance Status shall indicate which rule's requirements will be followed for testing, monitoring, reporting, and recordkeeping.

(5) An owner or operator who transfers a Group 1 wastewater stream or residual removed from a Group 1 wastewater stream for treatment pursuant to §63.132(g) shall include in the Notification of Compliance Status the name and location of the transferee and a description of the Group 1 wastewater stream or residual sent to the treatment facility.

(6) An owner or operator complying with §63.113(i) shall include in the Notification of Compliance Status, or where applicable, a supplement to the Notification of Compliance Status, the name and location of the transferee, and the identification of the Group 1 process vent.

(c) The owner or operator of a source subject to this subpart shall submit Periodic Reports.

(1) Except as specified under paragraphs (c)(5) and (c)(6) of this section, a report containing the information in paragraphs (c)(2), (c)(3), and (c)(4) of this section shall be submitted semiannually no later than 60 calendar days after the end of each 6-month period. The first report shall be submitted no later than 8 months after the date the Notification of Compliance Status is due and shall cover the 6-month period beginning on the date the Notification of Compliance Status is due.

(2) Except as provided in paragraph (c)(2)(iv) of this section, for an owner or operator of a source complying with the provisions of §§63.113 through 63.147 for any emission points, Periodic Reports shall include all information specified in §§63.117 and 63.118 for process vents, §63.122 for storage vessels, §§63.129 and 63.130 for transfer operations, and §63.146 for process wastewater, including reports of periods when monitored parameters are outside their established ranges.

(i) For each parameter or parameters required to be monitored for a control device, the owner or operator shall establish a range of parameter values to ensure that the device is being applied, operated and maintained properly. As specified in paragraph (b)(2) of this section, these parameter values and the definition of an operating day shall be approved as part of and incorporated into the source's Notification of Compliance Status or operating permit, as appropriate.

(ii) The parameter monitoring data for Group 1 emission points and emission points included in emissions averages that are required to perform continuous monitoring shall be used to determine compliance with the required operating conditions for the monitored control devices or recovery devices. For each excursion, except for excused excursions, the owner or operator shall be deemed to have failed to have applied the control in a manner that achieves the required operating conditions.

(A) An excursion means any of the three cases listed in paragraph (c)(2)(ii)(A)(1), (c)(2)(ii)(A)(2), or (c)(2)(ii)(A)(3) of this section. For a control device or recovery device where multiple parameters are monitored, if one or more of the parameters meets the excursion criteria in paragraph (c)(2)(ii)(A)(1), (c)(2)(ii)(A)(2), or (c)(2)(ii)(A)(3) of this section, this is considered a single excursion for the control device or recovery device.

(1) When the daily average value of one or more monitored parameters is outside the permitted range.

(2) When the period of control device or recovery device operation is 4 hours or greater in an operating day and monitoring data are insufficient to constitute a valid hour of data for at least 75 percent of the operating hours.

(3) When the period of control device or recovery device operation is less than 4 hours in an operating day and more than one of the hours during the period of operation does not constitute a valid hour of data due to insufficient monitoring data.

(4) Monitoring data are insufficient to constitute a valid hour of data, as used in paragraphs (c)(2)(ii)(A)(2) and (c)(2)(ii)(A)(3) of this section, if measured values are unavailable for any of the 15-minute periods within the hour. For data compression systems approved under §63.151(g)(4), monitoring data are insufficient to calculate a valid hour of data if there are less than 4 data values recorded during the hour.

(B) The number of excused excursions for each control device or recovery device for each semiannual period is specified in paragraphs (c)(2)(ii)(B)(1) through (c)(2)(ii)(B)(6) of this section. This paragraph applies to sources required to submit Periodic Reports semiannually or quarterly. The first semiannual period is the 6-month period starting the date the Notification of Compliance Status is due.

(1) For the first semiannual period—six excused excursions.

(2) For the second semiannual period—five excused excursions.

(3) For the third semiannual period—four excused excursions.

(4) For the fourth semiannual period—three excused excursions.

(5) For the fifth semiannual period—two excused excursions.

(6) For the sixth and all subsequent semiannual periods—one excused excursion.

(C) A monitored parameter that is outside its established range or monitoring data that are not collected are excursions. However, if the conditions in paragraph (c)(2)(ii)(C)(1) or (c)(2)(ii)(C)(2) of this section are met, these excursions are not violations and do not count toward the number of excused excursions for determining compliance.

(1) *Periods of startup, shutdown, or malfunction.* During periods of startup, shutdown, or malfunction when the source is operated during such periods in accordance with §63.102(a)(4).

(2) *Periods of nonoperation.* During periods of nonoperation of the chemical manufacturing process unit, or portion thereof, that results in cessation of the emissions to which the monitoring applies.

(D) Nothing in paragraph (c)(2)(ii) of this section shall be construed to allow or excuse a monitoring parameter excursion caused by any activity that violates other applicable provisions of subpart A, F, or G of this part.

(E) Paragraph (c)(2)(ii) of this section, except paragraph (c)(2)(ii)(C) of this section, shall apply only to emission points and control devices or recovery devices for which continuous monitoring is required by §§63.113 through 63.150.

(iii) Periodic Reports shall include the daily average values of monitored parameters for both excused and unexcused excursions, as defined in paragraph (c)(2)(ii)(A) of this section. For excursions caused by lack of monitoring data, the duration of periods when monitoring data were not collected shall be specified.

(iv) The provisions of paragraphs (c)(2), (c)(2)(i), (c)(2)(ii), and (c)(2)(iii) of this section do not apply to any storage vessel for which the owner or operator is not required, by the applicable monitoring plan

established under §63.120(d)(2), to keep continuous records. If continuous records are required, the owner or operator shall specify, in the monitoring plan, whether the provisions of paragraphs (c)(2), (c)(2)(i), (c)(2)(ii), and (c)(2)(iii) of this section apply.

(3) If any performance tests are reported in a Periodic Report, the following information shall be included:

(i) One complete test report shall be submitted for each test method used for a particular kind of emission point tested. A complete test report shall contain the information specified in paragraph (b)(1)(ii) of this section.

(ii) For additional tests performed for the same kind of emission point using the same method, results and any other information required in §63.117 for process vents, §63.129 for transfer, and §63.146 for process wastewater shall be submitted, but a complete test report is not required.

(4) Periodic Reports shall include the information in paragraphs (c)(4)(i) through (c)(4)(iv) of this section, as applicable:

(i) For process vents, reports of process changes as required under §63.118 (g), (h), (i), and (j) of this subpart,

(ii) Any supplements required under §63.151(i) and (j) of this subpart,

(iii) Notification if any Group 2 emission point becomes a Group 1 emission point, including a compliance schedule as required in §63.100 of subpart F of this part, and

(iv) For gas streams sent for disposal pursuant to §63.113(i) or for process wastewater streams sent for treatment pursuant to §63.132(g), reports of changes in the identity of the transferee.

(5) The owner or operator of a source shall submit quarterly reports for all emission points included in an emissions average.

(i) The quarterly reports shall be submitted no later than 60 calendar days after the end of each quarter. The first report shall be submitted with the Notification of Compliance Status no later than 5 months after the compliance date specified in §63.100 of subpart F.

(ii) The quarterly reports shall include the information specified in this paragraph for all emission points included in an emissions average.

(A) The credits and debits calculated each month during the quarter;

(B) A demonstration that debits calculated for the quarter are not more than 1.30 times the credits calculated for the quarter, as required under §63.150(e)(4) of this subpart.

(C) The values of any inputs to the credit and debit equations in §63.150 (g) and (h) of this subpart that change from month to month during the quarter or that have changed since the previous quarter;

(D) Results of any performance tests conducted during the reporting period including one complete report for each test method used for a particular kind of emission point as described in paragraph (c)(3) of this section;

(E) Reports of daily average values of monitored parameters for both excused and unexcused excursions as defined in paragraph (c)(2)(ii)(A) of this section. For excursions caused by lack of monitoring data, the duration of periods when monitoring data were not collected shall be specified.

(iii) Paragraphs (c)(2)(i) through (c)(2)(iii) of this section shall govern the use of monitoring data to determine compliance for Group 1 and Group 2 points included in emissions averages. For storage vessels to which the provisions of paragraphs (c)(2)(i) through (c)(2)(iii) of this section do not apply (as specified in paragraph (c)(2)(iv) of this section), the owner or operator is required to comply with the provisions of the applicable monitoring plan, and monitoring records may be used to determine compliance.

(iv) Every fourth quarterly report shall include the following:

(A) A demonstration that annual credits are greater than or equal to annual debits as required by §63.150(e)(3) of this subpart; and

(B) A certification of compliance with all the emissions averaging provisions in §63.150 of this subpart.

(6) The owner or operator of a source shall submit reports quarterly for particular emission points not included in an emissions average under the circumstances described in paragraphs (c)(6)(i) through (c)(6)(v) of this section.

(i) The owner or operator of a source subject to this subpart shall submit quarterly reports for a period of one year for an emission point that is not included in an emissions average if:

(A) The emission point has more excursions, as defined in paragraph (c)(2)(ii) of this section, than the number of excused excursions allowed under paragraph (c)(2)(ii)(B) of this section for a semiannual reporting period; and

(B) The Administrator requests the owner or operator to submit quarterly reports for the emission point.

(ii) The quarterly reports shall include all information in paragraphs (c)(2), (c)(3), and (c)(4) of this section applicable to the emission point(s) for which quarterly reporting is required under paragraph (c)(6)(i) of this section. Information applicable to other emission points within the source shall be submitted in the semiannual reports required under paragraph (c)(1) of this section.

(iii) Quarterly reports shall be submitted no later than 60 calendar days after the end of each quarter.

(iv) After quarterly reports have been submitted for an emission point for one year, the owner or operator may return to semiannual reporting for the emission point unless the Administrator requests the owner or operator to continue to submit quarterly reports.

(v) Paragraphs (c)(2)(i) through (c)(2)(iii) of this section shall govern the use of monitoring data to determine compliance for Group 1 emission points. For storage vessels to which the provisions of paragraphs (c)(2)(i) through (c)(2)(iii) of this section do not apply (as specified in paragraph (c)(2)(iv) of this section), the owner or operator is required to comply with the provisions of the applicable monitoring plan, and monitoring records may be used to determine compliance.

(d) Other reports shall be submitted as specified in subpart A of this part or in §§63.113 through 63.151 of this subpart. These reports are:

(1) Reports of start-up, shutdown, and malfunction required by §63.10(d)(5) of subpart A. The start-up, shutdown and malfunction reports may be submitted on the same schedule as the Periodic Reports required under paragraph (c) of this section instead of the schedule specified in §63.10(d)(5) of subpart A.

(2) For storage vessels, the notifications of inspections required by §63.122 (h)(1) and (h)(2) of this subpart.

(3) For owners or operators of sources required to request approval for a nominal control efficiency for use in calculating credits for an emissions average, the information specified in §63.150(i) of this subpart.

(4) If an owner or operator transfers for disposal a gas stream that has the characteristics specified in §63.107(b) through (h) or meets the criteria specified in §63.107(i) to an off-site location or an on-site location not owned or operated by the owner or operator of the source and the vent stream was not included in the information submitted with the Notification of Compliance Status or a previous periodic report, the owner or operator shall submit a supplemental report. The supplemental report shall be submitted no later than July 23, 2001 or with the next periodic report, whichever is later. The report shall provide the information listed in paragraphs (d)(4)(i) through (iv) of this section.

(i) The chemical manufacturing process unit(s) that is the origin of all or part of the vent stream that exits the process vent.

(ii) The type(s) of unit operations (i.e., an air oxidation reactor, distillation unit, or reactor) that creates the vent stream that exits the process vent.

(iii) For a Group 2 process vent, the last recovery device, if any.

(iv) For a Group 1 process vent, the identity of the transferee.

(e) An owner or operator subject to this subpart shall submit the information specified in paragraphs (e)(1) through (e)(4) of this section with the operating permit application or as otherwise specified by the permitting authority. The owner or operator shall submit written updates as amendments to the operating permit application on the schedule and under the circumstances described in §63.151(j) of this subpart. Notwithstanding, if the owner or operator has an operating permit under 40 CFR part 70 or 71, the owner or operator shall follow the schedule and format required by the permitting authority.

(1) The information specified in §63.151 (f) or (g) of this subpart for any emission points for which the owner or operator requests approval to monitor a unique parameter or use an alternative monitoring and recording system, and

(2) The information specified in §63.151(d) of this subpart for points included in an emissions average.

(3) The information specified in §63.151(e) of this subpart for points not included in an emissions average.

(4) The information specified in §63.151(h) as applicable.

(f) Owners or operators required to keep continuous records by §§63.118, 63.130, 63.147, 63.150, or other sections of this subpart shall keep records as specified in paragraphs (f)(1) through (f)(7) of this section, unless an alternative recordkeeping system has been requested and approved under §63.151(f) or (g) or §63.152(e) or under §63.8(f) of subpart A of this part, and except as provided in paragraph (c)(2)(ii)(C) of this section or in paragraph (g) of this section. If a monitoring plan for storage vessels

pursuant to §63.120(d)(2)(i) requires continuous records, the monitoring plan shall specify which provisions, if any, of paragraphs (f)(1) through (f)(7) of this section apply.

(1) The monitoring system shall measure data values at least once every 15 minutes.

(2) The owner or operator shall record either:

(i) Each measured data value; or

(ii) Block average values for 15-minute or shorter periods calculated from all measured data values during each period or at least one measured data value per minute if measured more frequently than once per minute.

(3) If the daily average value of a monitored parameter for a given operating day is within the range established in the Notification of Compliance Status or operating permit, the owner or operator shall either:

(i) Retain block hourly average values for that operating day for 5 years and discard, at or after the end of that operating day, the 15-minute or more frequent average values and readings recorded under paragraph (f)(2) of this section; or

(ii) Retain the data recorded in paragraph (f)(2) of this section for 5 years.

(4) If the daily average value of a monitored parameter for a given operating day is outside the range established in the Notification of Compliance Status or operating permit, the owner or operator shall retain the data recorded that operating day under paragraph (f)(2) of this section for 5 years.

(5) Daily average values of each continuously monitored parameter shall be calculated for each operating day, and retained for 5 years, except as specified in paragraphs (f)(6) and (f)(7) of this section.

(i) The daily average shall be calculated as the average of all values for a monitored parameter recorded during the operating day. The average shall cover a 24-hour period if operation is continuous, or the number of hours of operation per operating day if operation is not continuous.

(ii) The operating day shall be the period defined in the operating permit or the Notification of Compliance Status. It may be from midnight to midnight or another daily period.

(6) If all recorded values for a monitored parameter during an operating day are within the range established in the Notification of Compliance Status or operating permit, the owner or operator may record that all values were within the range and retain this record for 5 years rather than calculating and recording a daily average for that operating day. For these operating days, the records required in paragraph (f)(3) of this section shall also be retained for 5 years.

(7) Monitoring data recorded during periods identified in paragraphs (f)(7)(i) through (f)(7)(v) of this section shall not be included in any average computed under this subpart. Records shall be kept of the times and durations of all such periods and any other periods during process or control device operation when monitors are not operating.

(i) Monitoring system breakdowns, repairs, calibration checks, and zero (low-level) and high-level adjustments;

(ii) Start-ups;

(iii) Shutdowns;

(iv) Malfunctions;

(v) Periods of non-operation of the chemical manufacturing process unit (or portion thereof), resulting in cessation of the emissions to which the monitoring applies.

(g) For any parameter with respect to any item of equipment, the owner or operator may implement the recordkeeping requirements in paragraph (g)(1) or (g)(2) of this section as alternatives to the continuous operating parameter monitoring and recordkeeping provisions listed in §§63.114, 63.117, and 63.118 for process vents, §§63.127, 63.129, and 63.130 for transfer operations, §§63.143, 63.146, and 63.147 for wastewater, and/or §63.152(f), except that §63.152(f)(7) shall apply. The owner or operator shall retain each record required by paragraph (g)(1) or (g)(2) of this section as provided in §63.103(c) of subpart F of this part, except as provided otherwise in paragraph (g)(1) or (g)(2) of this section.

(1) The owner or operator may retain only the daily average value, and is not required to retain more frequent monitored operating parameter values, for a monitored parameter with respect to an item of equipment, if the requirements of paragraphs (g)(1)(i) through (g)(1)(vi) of this section are met. An owner or operator electing to comply with the requirements of paragraph (g)(1) of this section shall notify the Administrator in the Notification of Compliance Status or, if the Notification of Compliance Status has already been submitted, in the periodic report immediately preceding implementation of the requirements of paragraph (g)(1) of this section.

(i) The monitoring system is capable of detecting unrealistic or impossible data during periods of operation other than startups, shutdowns, or malfunctions (e.g., a temperature reading of  $-200^{\circ}\text{C}$  on a boiler), and will alert the operator by alarm or other means. The owner or operator shall record the occurrence. All instances of the alarm or other alert in an operating day constitute a single occurrence.

(ii) The monitoring system generates, updated at least hourly throughout each operating day, a running average of the monitoring values that have been obtained during that operating day, and the capability to observe this average is readily available to the Administrator on-site during the operating day. The owner or operator shall record the occurrence of any period meeting the criteria in paragraphs (g)(1)(ii)(A) through (g)(1)(iii)(C) of this section. All instances in an operating day constitute a single occurrence.

(A) The running average is above the maximum or below the minimum established limits;

(B) The running average is based on at least 6 1-hour average values; and

(C) The running average reflects a period of operation other than a startup, shutdown, or malfunction.

(iii) The monitoring system is capable of detecting unchanging data during periods of operation other than startups, shutdowns, or malfunctions, except in circumstances where the presence of unchanging data is the expected operating condition based on past experience (e.g., pH in some scrubbers), and will alert the operator by alarm or other means. The owner or operator shall record the occurrence. All instances of the alarm or other alert in an operating day constitute a single occurrence.

(iv) The monitoring system will alert the owner or operator by an alarm or other means, if the running average parameter value calculated under paragraph (g)(1)(ii) of this section reaches a set point that is appropriately related to the established limit for the parameter that is being monitored.

(v) The owner or operator shall verify the proper functioning of the monitoring system, including its ability to comply with the requirements of paragraph (g)(1) of this section, at the times specified in paragraphs (g)(1)(v)(A) through (g)(1)(v)(C) of this section. The owner or operator shall document that the required verifications occurred.

(A) Upon initial installation.

(B) Annually after initial installation.

(C) After any change to the programming or equipment constituting the monitoring system, which might reasonably be expected to alter the monitoring system's ability to comply with the requirements of this section.

(vi) The owner or operator shall retain the records identified in paragraphs (g)(1)(vi) (A) through (C) of this section.

(A) Identification of each parameter, for each item of equipment, for which the owner or operator has elected to comply with the requirements of paragraph (g) of this section.

(B) A description of the applicable monitoring system(s), and of how compliance will be achieved with each requirement of paragraph (g)(1)(i) through (g)(1)(v) of this section. The description shall identify the location and format (e.g., on-line storage; log entries) for each required record. If the description changes, the owner or operator shall retain both the current and the most recent superseded description. The description, and the most recent superseded description, shall be retained as provided in §63.103(c) of subpart F of this part, except as provided in paragraph (g)(1)(vi)(D) of this section.

(C) A description, and the date, of any change to the monitoring system that would reasonably be expected to affect its ability to comply with the requirements of paragraph (g)(1) of this section.

(D) Owners and operators subject to paragraph (g)(1)(vi)(B) of this section shall retain the current description of the monitoring system as long as the description is current, but not less than 5 years from the date of its creation. The current description shall, at all times, be retained on-site or be accessible from a central location by computer or other means that provides access within 2 hours after a request. The owner or operator shall retain the most recent superseded description at least until 5 years from the date of its creation. The superseded description shall be retained on-site (or accessible from a central location by computer that provides access within 2 hours after a request) at least 6 months after its creation. Thereafter, the superseded description may be stored off-site.

(2) If an owner or operator has elected to implement the requirements of paragraph (g)(1) of this section, and a period of 6 consecutive months has passed without an excursion as defined in paragraph (g)(2)(iv) of this section, the owner or operator is no longer required to record the daily average value for that parameter for that unit of equipment, for any operating day when the daily average value is less than the maximum, or greater than the minimum established limit. With approval by the Administrator, monitoring data generated prior to the compliance date of this subpart shall be credited toward the period of 6 consecutive months, if the parameter limit and the monitoring was required and/or approved by the Administrator.

(i) If the owner or operator elects not to retain the daily average values, the owner or operator shall notify the Administrator in the next periodic report. The notification shall identify the parameter and unit of equipment.

(ii) If, on any operating day after the owner or operator has ceased recording daily averages as provided in paragraph (g)(2) of this section, there is an excursion as defined in paragraph (g)(2)(iv) of this



section, the owner or operator shall immediately resume retaining the daily average value for each day, and shall notify the Administrator in the next periodic report. The owner or operator shall continue to retain each daily average value until another period of 6 consecutive months has passed without an excursion as defined in paragraph (g)(2)(iv) of this section.

(iii) The owner or operator shall retain the records specified in paragraphs (g)(1) (i), (ii), (iii), (iv), (v), and (vi) of this section. For any calendar week, if compliance with paragraphs (g)(1) (i), (ii), (iii), and (iv) of this section does not result in retention of a record of at least one occurrence or measured parameter value, the owner or operator shall record and retain at least one parameter value during a period of operation other than a startup, shutdown, or malfunction.

(iv) For purposes of paragraph (g) of this section, an excursion means that the daily average value of monitoring data for a parameter is greater than the maximum, or less than the minimum established value, except as provided in paragraphs (g)(2)(iv)(A) and (g)(2)(iv)(B) of this section.

(A) The daily average value during any startup, shutdown, or malfunction shall not be considered an excursion for purposes of this paragraph (g)(2), if the owner or operator operates the source during such periods in accordance with §63.102(a)(4).

(B) An excused excursion, as described in §63.152(c)(2)(ii) (B) and (C), shall not be considered an excursion for purposes of this paragraph (g)(2).

[59 FR 19468, Apr. 22, 1994, as amended at 60 FR 63629, Dec. 12, 1995; 61 FR 64577, Dec. 5, 1996; 62 FR 2776, Jan. 17, 1997; 64 FR 20195, Apr. 26, 1999; 66 FR 6934, Jan. 22, 2001; 71 FR 20456, Apr. 20, 2006]

### **§63.153 Implementation and enforcement.**

(a) This subpart can be implemented and enforced by the U.S. EPA, or a delegated authority such as the applicable State, local, or Tribal agency. If the U.S. EPA Administrator has delegated authority to a State, local, or Tribal agency, then that agency, in addition to the U.S. EPA, has the authority to implement and enforce this subpart. Contact the applicable U.S. EPA Regional Office to find out if implementation and enforcement of this subpart is delegated to a State, local, or Tribal agency.

(b) In delegating implementation and enforcement authority of this subpart to a State, local, or Tribal agency under subpart E of this part, the authorities contained in paragraph (c) of this section are retained by the Administrator of U.S. EPA and cannot be transferred to the State, local, or Tribal agency.

(c) The authorities that cannot be delegated to State, local, or Tribal agencies are as specified in paragraphs (c)(1) through (4) of this section.

(1) Approval of alternatives to the requirements in §§63.110, 63.112 through 63.113, 63.119, 63.126, 63.132 through 63.140, 63.148 through 63.149, and 63.150(i)(1) through (4). Follow the requirements in §63.121 to request permission to use an alternative means of emission limitation for storage vessels. Where these standards reference another subpart, the cited provisions will be delegated according to the delegation provisions of the referenced subpart. Where these standards reference another subpart and modify the requirements, the requirements shall be modified as described in this subpart. Delegation of the modified requirements will also occur according to the delegation provisions of the referenced subpart.

(2) Approval of major alternatives to test methods under §63.7(e)(2)(ii) and (f), as defined in §63.90, and as required in this subpart.

(3) Approval of major alternatives to monitoring under §63.8(f), as defined in §63.90, and as required in this subpart.

(4) Approval of major alternatives to recordkeeping and reporting under §63.10(f), as defined in §63.90, and as required in this subpart.

[68 FR 37344, June 23, 2003]

**Table 1 to Subpart G of Part 63—Process Vents—Coefficients for Total Resource Effectiveness for Existing Source Nonhalogenated and Halogenated Vent Streams**

| Type of Stream | Control Device Basis                         | Values of Coefficients |                        |                         |                         |
|----------------|--|------------------------|------------------------|-------------------------|-------------------------|
|                |  | a                      | b                      | c                       | d                       |
| Nonhalogenated | Flare  | 1.935                  | $3.660 \times 10^{-1}$ | $-7.687 \times 10^{-3}$ | $-7.333 \times 10^{-4}$ |
|                | Thermal Incinerator 0 Percent Heat Recovery  | 1.492                  | $6.267 \times 10^{-2}$ | $3.177 \times 10^{-2}$  | $-1.159 \times 10^{-3}$ |
|                | Thermal Incinerator 70 Percent Heat Recovery | 2.519                  | $1.183 \times 10^{-2}$ | $1.300 \times 10^{-2}$  | $4.790 \times 10^{-2}$  |
| Halogenated    | Thermal Incinerator and Scrubber             | 3.995                  | $5.200 \times 10^{-2}$ | $-1.769 \times 10^{-3}$ | $9.700 \times 10^{-4}$  |

**Table 1A to Subpart G of Part 63—Applicable 40 CFR Part 63 General Provisions**

| 40 CFR part 63, subpart A, provisions applicable to subpart G  |
|--|
| §63.1(a)(1), (a)(2), (a)(3), (a)(13), (a)(14), (b)(2) and (c)(4)   |
| §63.2  |
| §63.5(a)(1), (a)(2), (b), (d)(1)(ii), (d)(3)(i), (d)(3)(iii) through (d)(3)(vi), (d)(4), (e), (f)(1), and (f)(2) |
| §63.6(a), (b)(3), (c)(5), (i)(1), (i)(2), (i)(4)(i)(A), (i)(5) through (i)(14), (i)(16) and (j)                  |
| §63.9(a)(2), (b)(4)(i) <sup>a</sup> , (b)(4)(ii), (b)(4)(iii), (b)(5) <sup>a</sup> , (c), (d)                    |
| §63.10(d)(4)   |
| §63.11 (c), (d), and (e)   |
| §63.12(b)  |

<sup>a</sup>The notifications specified in §63.9(b)(4)(i) and (b)(5) shall be submitted at the times specified in 40 CFR part 65.

[59 FR 19468, Apr. 22, 1994, as amended at 73 FR 78213, Dec. 22, 2008]

**Table 2 to Subpart G of Part 63—Process Vents—Coefficients for Total Resource Effectiveness for New Source Nonhalogenated and Halogenated Vent Streams**

| Type of stream | Control device basis                         | Values of Coefficients |                        |                         |                         |
|----------------|--|------------------------|------------------------|-------------------------|-------------------------|
|                |  | a                      | b                      | c                       | d                       |
| Nonhalogenated | Flare  | 0.5276                 | 0.0998                 | $2.096 \times 10^{-3}$  | $-2.000 \times 10^{-4}$ |
|                | Thermal Incinerator 0 Percent Heat Recovery  | 0.4068                 | 0.0171                 | $8.664 \times 10^{-3}$  | $-3.162 \times 10^{-4}$ |
|                | Thermal Incinerator 70 Percent Heat Recovery | 0.6868                 | $3.209 \times 10^{-3}$ | $3.546 \times 10^{-3}$  | $1.306 \times 10^{-2}$  |
| Halogenated    | Thermal Incinerator and Scrubber             | 1.0895                 | $1.417 \times 10^{-2}$ | $-4.822 \times 10^{-4}$ | $2.645 \times 10^{-4}$  |

**Table 3 to Subpart G of Part 63—Process Vents—Monitoring, Recordkeeping, and Reporting Requirements for Complying With 98 Weight-Percent Reduction of Total Organic Hazardous Air Pollutants Emissions or a Limit of 20 Parts Per Million by Volume**

| Control device        | Parameters to be monitored <sup>a</sup>                                    | Recordkeeping and reporting requirements for monitored parameters   |
|-----------------------|--|---|
| Thermal incinerator   | Firebox temperature <sup>b</sup> [63.114(a)(1)(i)]                         | <ol style="list-style-type: none"> <li>1. Continuous records.<sup>c</sup></li> <li>2. Record and report the firebox temperature averaged over the full period of the performance test—NCS.<sup>d</sup></li> <li>3. Record the daily average firebox temperature for each operating day.<sup>e</sup></li> <li>4. Report all daily average temperatures that are outside the range established in the NCS or operating permit and all operating days when insufficient monitoring data are collected<sup>f</sup>—PR.<sup>g</sup></li> </ol> |
| Catalytic incinerator | Temperature upstream and downstream of the catalyst bed [63.114(a)(1)(ii)] | <ol style="list-style-type: none"> <li>1. Continuous records.</li> <li>2. Record and report the upstream and downstream temperatures and the temperature difference across the catalyst bed averaged over the full period of the performance test—NCS.</li> <li>3. Record the daily average upstream temperature and</li> </ol>   |

|  |   |  |
|--|---|--|
|  |   | <p>temperature difference across the catalyst bed for each operating day.<sup>e</sup></p> <p>4. Report all daily average upstream temperatures that are outside the range established in the NCS or operating permit—PR.</p> <p>5. Report all daily average temperature differences across the catalyst bed that are outside the range established in the NCS or operating permit—PR.</p> <p>6. Report all operating days when insufficient monitoring data are collected.<sup>f</sup></p> |
| Boiler or process heater with a design heat input capacity less than 44 megawatts and vent stream is <i>not</i> introduced with or as the primary fuel | Firebox temperature <sup>b</sup> [63.114(a)(3)]       | <p>1. Continuous records.</p> <p>2. Record and report the firebox temperature averaged over the full period of the performance test—NCS.</p> <p>3. Record the daily average firebox temperature for each operating day.<sup>e</sup></p> <p>4. Report all daily average firebox temperatures that are outside the range established in the NCS or operating permit and all operating days when insufficient monitoring data are collected<sup>f</sup>—PR.</p>                               |
| Flare  | Presence of a flame at the pilot light [63.114(a)(2)] | <p>1. Hourly records of whether the monitor was continuously operating and whether the pilot flame was continuously present during each hour.</p> <p>2. Record and report the presence of a flame at the pilot light over the full period of the compliance determination—NCS.</p> <p>3. Record the times and durations of all periods when all pilot flames are absent or the monitor is not operating.</p>   |

|  |  |  |
|--|--|--|
|  |  | 4. Report the times and durations of all periods when all pilot flames of a flare are absent—PR.   |
| Recapture devices  | The appropriate monitoring device identified in table 4 when, in the table, the term “recapture” is substituted for “recovery.” [63.114(a)(5)] | 1. The recordkeeping and reporting requirements for monitored parameters identified for the appropriate monitoring device in table 4 of this subpart.  |
| Scrubber for halogenated vent streams (Note: Controlled by a combustion device other than a flare)             | pH of scrubber effluent [63.114(a)(4)(i)], and   | <ol style="list-style-type: none"> <li>1. Continuous records.</li> <li>2. Record and report the pH of the scrubber effluent averaged over the full period of the performance test—NCS.</li> <li>3. Record the daily average pH of the scrubber effluent for each operating day.<sup>e</sup></li> <li>4. Report all daily average pH values of the scrubber effluent that are outside the range established in the NCS or operating permit and all operating days when insufficient monitoring data are collected<sup>f</sup>—PR.</li> </ol>                  |
| Scrubber for halogenated vent streams (Note: Controlled by a combustion device other than a flare) (Continued) | Scrubber liquid and gas flow rates [63.114(a)(4)(ii)]  | <ol style="list-style-type: none"> <li>1. Continuous records of scrubber liquid flow rate.</li> <li>2. Record and report the scrubber liquid/gas ratio averaged over the full period of the performance test—NCS.</li> <li>3. Record the daily average scrubber liquid/gas ratio for each operating day.<sup>e</sup></li> <li>4. Report all daily average scrubber liquid/gas ratios that are outside the range established in the NCS or operating permit and all operating days when insufficient monitoring data are collected<sup>f</sup>—PR.</li> </ol> |
| All control devices  | Presence of flow diverted to the   | 1. Hourly records of whether   |

|  |   |   |
|--|---|---|
|  | atmosphere from the control device [63.114(d)(1)] <i>or</i> | the flow indicator was operating and whether diversion was detected at any time during each hour.<br>2. Record and report the times and durations of all periods when the vent stream is diverted through a bypass line or the monitor is not operating—PR. |
|  | Monthly inspections of sealed valves [63.114(d)(2)]         | 1. Records that monthly inspections were performed.<br>2. Record and report all monthly inspections that show the valves are moved to the diverting position or the seal has been changed—PR.   |

<sup>a</sup>Regulatory citations are listed in brackets.

<sup>b</sup>Monitor may be installed in the firebox or in the ductwork immediately downstream of the firebox before any substantial heat exchange is encountered.

<sup>c</sup>“Continuous records” is defined in §63.111 of this subpart.

<sup>d</sup>NCS = Notification of Compliance Status described in §63.152 of this subpart.

<sup>e</sup>The daily average is the average of all recorded parameter values for the operating day. If all recorded values during an operating day are within the range established in the NCS or operating permit, a statement to this effect can be recorded instead of the daily average.

<sup>f</sup>The periodic reports shall include the duration of periods when monitoring data is not collected for each excursion as defined in §63.152(c)(2)(ii)(A) of this subpart.

<sup>g</sup>PR = Periodic Reports described in §63.152 of this subpart.

**Table 4 to Subpart G of Part 63—Process Vents—Monitoring, Recordkeeping, and Reporting Requirements For Maintaining a TRE Index Value >1.0 and. ≤4.0**

| <b>Final recovery device</b> | <b>Parameters to be monitored<sup>a</sup></b>                | <b>Recordkeeping and reporting requirements for monitored parameters</b>   |
|------------------------------|--|--|
| Absorber <sup>b</sup>        | Exit temperature of the absorbing liquid [63.114(b)(1)], and | 1. Continuous records <sup>c</sup> .<br>2. Record and report the exit temperature of the absorbing liquid averaged over the full period of the TRE determination—NCS. <sup>d</sup> |
|                              |  | 3. Record the daily average exit   |

|                              |   |  |
|------------------------------|---|--|
|                              |   | temperature of the absorbing liquid for each operating day <sup>e</sup> .  |
|                              |   | 4. Report all the daily average exit temperatures of the absorbing liquid that are outside the range established in the NCS or operating permit—PR <sup>f</sup> .  |
|                              | Exit specific gravity [63.114(b)(1)]  | 1. Continuous records.<br>2. Record and report the exit specific gravity averaged over the full period of the TRE determination—NCS.   |
|                              |   | 3. Record the daily average exit specific gravity for each operating day <sup>e</sup> .  |
|                              |   | 4. Report all daily average exit specific gravity values that are outside the range established in the NCS or operating permit—PR.   |
| Condenser <sup>d</sup>       | Exit (product side) temperature [63.114(b)(2)]  | 1. Continuous records.<br>2. Record and report the exit temperature averaged over the full period of the TRE determination—NCS.  |
|                              |   | 3. Record the daily average exit temperature for each operating day <sup>e</sup> .   |
|                              |   | 4. Report all daily average exit temperatures that are outside the range established in the NCS or operating permit—PR.  |
| Carbon adsorber <sup>d</sup> | Total regeneration stream mass or volumetric flow during carbon bed regeneration cycle(s) [63.114(b)(3)], and | 1. Record of total regeneration stream mass or volumetric flow for each carbon bed regeneration cycle.<br>2. Record and report the total regeneration stream mass or volumetric flow during each carbon bed regeneration cycle during the period of the TRE determination—NCS. |
|                              |   | 3. Report all carbon bed regeneration cycles when the total regeneration stream mass or volumetric flow is outside the range established in the NCS or operating permit—PR.  |
|                              | Temperature of the carbon bed after regeneration [and within 15   | 1. Records of the temperature of the carbon bed after each regeneration.   |

|   |  |  |
|---|--|--|
|   | minutes of completing any cooling cycle(s)] [63.114(b)(3)]   | 2. Record and report the temperature of the carbon bed after each regeneration during the period of the TRE determination—NCS.   |
|   |  | 3. Report all carbon bed regeneration cycles during which temperature of the carbon bed after regeneration is outside the range established in the NCS or operating permit—PR. |
| All recovery devices (as an alternative to the above) | Concentration level or reading indicated by an organic monitoring device at the outlet of the recovery device [63.114 (b)] | 1. Continuous records.<br>2. Record and report the concentration level or reading averaged over the full period of the TRE determination—NCS.                                  |
|   |  | 3. Record the daily average concentration level or reading for each operating day <sup>e</sup> .   |
|   |  | 4. Report all daily average concentration levels or readings that are outside the range established in the NCS or operating permit—PR.   |

<sup>a</sup>Regulatory citations are listed in brackets.

<sup>b</sup>Alternatively, these devices may comply with the organic monitoring device provisions listed at the end of this table under “All Recovery Devices.”

<sup>c</sup>“Continuous records” is defined in §63.111 of this subpart.

<sup>d</sup>NCS = Notification of Compliance Status described in §63.152 of this subpart.

<sup>e</sup>The daily average is the average of all values recorded during the operating day. If all recorded values during an operating day are within the range established in the NCS or operating permit, a statement to this effect can be recorded instead of the daily average.

<sup>f</sup>PR= Periodic Reports described in §63.152 of this subpart.

**Table 5 to Subpart G of Part 63—Group 1 Storage Vessels at Existing Sources**

| Vessel capacity (cubic meters) | Vapor Pressure <sup>1</sup> (kilopascals) |
|--------------------------------|---|
| 75 ≤ capacity < 151            | ≥ 13.1                                    |
| 151 ≤ capacity                 | ≥ 5.2                                     |

<sup>1</sup>Maximum true vapor pressure of total organic HAP at storage temperature.

**Table 6 to Subpart G of Part 63—Group 1 Storage Vessels at New Sources**



| Vessel capacity<br>(cubic meters) | Vapor pressure <sup>a</sup><br>(kilopascals) |
|-----------------------------------|--|
| 38 ≤ capacity < 151               | ≥ 13.1                                       |
| 151 ≤ capacity                    | ≥ 0.7  |

<sup>a</sup>Maximum true vapor pressure of total organic HAP at storage temperature.

**Table 7 to Subpart G of Part 63—Transfer Operations—Monitoring, Recordkeeping, and Reporting Requirements for Complying With 98 Weight-Percent Reduction of Total Organic Hazardous Air Pollutants Emissions or a Limit of 20 Parts Per Million by Volume**

| Control device        | Parameters to be monitored <sup>a</sup>                                    | Recordkeeping and reporting requirements for monitored parameters   |
|-----------------------|--|---|
| Thermal incinerator   | Firebox temperature <sup>b</sup> [63.127(a)(1)(i)]                         | 1. Continuous records <sup>c</sup> during loading.  |
|                       |  | 2. Record and report the firebox temperature averaged over the full period of the performance test—NCS. <sup>d</sup>  |
|                       |  | 3. Record the daily average firebox temperature for each operating day <sup>e</sup>   |
|                       |  | 4. Report daily average temperatures that are outside the range established in the NCS or operating permit and all operating days when insufficient monitoring data are collected <sup>f</sup> —PR <sup>g</sup> |
| Catalytic incinerator | Temperature upstream and downstream of the catalyst bed [63.127(a)(1)(ii)] | 1. Continuous records during loading.   |
|                       |  | 2. Record and report the upstream and downstream temperatures and the temperature difference across the catalyst bed averaged over the full period of the performance test—NCS.                                 |
|                       |  | 3. Record the daily average upstream temperature and temperature difference across catalyst bed for each operating day. <sup>e</sup>  |
|                       |  | 4. Report all daily average upstream temperatures that are outside the  |

|   |   |  |
|---|---|--|
|   |   | range established in the NCS or operating permit—PR.   |
|   |   | 5. Report all daily average temperature differences across the catalyst bed that are outside the range established in the NCS or operating permit—PR.  |
|   |   | 6. Report all operating days when insufficient monitoring data are collected. <sup>f</sup>   |
| Boiler or process heater with a design heat input capacity less than 44 megawatts and vent stream is not introduced with or as the primary fuel | Firebox temperature <sup>b</sup> [63.127(a)(3)]       | 1. Continuous records during loading.<br>2. Record and report the firebox temperature averaged over the full period of the performance test—NCS.   |
|   |   | 3. Record the daily average firebox temperature for each operating day. <sup>e</sup>   |
|   |   | 4. Report all daily average firebox temperatures that are outside the range established in the NCS or operating permit and all operating days when insufficient data are collected <sup>f</sup> —PR. |
| Flare   | Presence of a flame at the pilot light [63.127(a)(2)] | 1. Hourly records of whether the monitor was continuously operating and whether the pilot flame was continuously present during each hour.   |
|   |   | 2. Record and report the presence of a flame at the pilot light over the full period of the compliance determination—NCS.  |
|   |   | 3. Record the times and durations of all periods when all pilot flames are absent or the monitor is not operating.   |
|   |   | 4. Report the duration of all periods when all pilot flames of a flare are   |

|  |  |   |
|--|--|---|
|  |  | absent—PR.  |
| Scrubber for halogenated vent streams (Note: Controlled by a combustion device other than a flare) | pH of scrubber effluent [63.127(a)(4)(i)], and               | 1. Continuous records during loading.<br>2. Record and report the pH of the scrubber effluent averaged over the full period of the performance test—NCS.  |
|  |  | 3. Record the daily average pH of the scrubber effluent for each operating day. <sup>e</sup>  |
|  |  | 4. Report all daily average pH values of the scrubber effluent that are outside the range established in the NCS or operating permit and all operating days when insufficient monitoring data are collected <sup>f</sup> —PR. |
|  | Scrubber liquid and gas flow rates [63.127(a)(4)(ii)]        | 1. Continuous records during loading of scrubber liquid flow rate.<br>2. Record and report the scrubber liquid/gas ratio averaged over the full period of the performance test—NCS.   |
|  |  | 3. Record the daily average scrubber liquid/gas ratio for each operating day. <sup>e</sup>  |
|  |  | 4. Report all daily average scrubber liquid/gas ratios that are outside the range established in the NCS or operating permit and all operating days when insufficient monitoring data are collected <sup>f</sup> —PR.         |
| Absorber <sup>h</sup>  | Exit temperature of the absorbing liquid [63.127(b)(1)], and | 1. Continuous records during loading.<br>2. Record and report the exit temperature of the absorbing liquid averaged over the full period of the performance test—NCS.   |
|  |  | 3. Record the daily average exit temperature of the absorbing liquid for each operating day. <sup>e</sup>   |
|  |  | 4. Report all daily average exit  |

|                              |   |   |
|------------------------------|---|---|
|                              |   | temperatures of the absorbing liquid that are outside the range established in the NCS or operating permit and all operating days when insufficient monitoring data are collected <sup>f</sup> —PR.                                       |
|                              | Exit specific gravity [63.127(b)(1)]  | 1. Continuous records during loading.<br>2. Record and report the exit specific gravity averaged over the full period of the performance test—NCS.  |
|                              |   | 3. Record the daily average exit specific gravity for each operating day. <sup>e</sup>  |
|                              |   | 4. Report all daily average exit specific gravity values that are outside the range established in the NCS or operating permit and all operating days when insufficient monitoring data are collected <sup>f</sup> —PR.                   |
| Condenser <sup>h</sup>       | Exit (product side) temperature [63.127(b)(2)]  | 1. Continuous records during loading.<br>2. Record and report the exit temperature averaged over the full period of the performance test—NCS.   |
|                              |   | 3. Record the daily average exit temperature for each operating day. <sup>e</sup>   |
|                              |   | 4. Report all daily average exit temperatures that are outside the range established in the NCS or operating permit and all operating days when insufficient monitoring data are collected <sup>f</sup> —PR.                              |
| Carbon adsorber <sup>h</sup> | Total regeneration stream mass or volumetric or volumetric flow during carbon bed regeneration cycle(s) [63.127(b)(3)], and | 1. Record of total regeneration stream mass or volumetric flow for each carbon bed regeneration cycle.<br>2. Record and report the total regeneration stream mass or volumetric flow during each carbon bed regeneration cycle during the |

|   |  |   |
|---|--|---|
|   |  | period of the performance test—NCS.   |
|   |  | 3. Report all carbon bed regeneration cycles when the total regeneration stream mass or volumetric flow is outside the range established in the NCS or operating permit and all operating days when insufficient monitoring data are collected <sup>f</sup> —PR.            |
|   | Temperature of the carbon bed after regeneration [and within 15 minutes of completing any cooling cycle(s)] [63.127(b)(3)] | 1. Records of the temperature of the carbon bed after each regeneration.<br>2. Record and report the temperature of the carbon bed after each regeneration during the period of the performance test—NCS.   |
|   |  | 3. Report all the carbon bed regeneration cycles during which the temperature of the carbon bed after regeneration is outside the range established in the NCS or operating permit and all operating days when insufficient monitoring data are collected <sup>f</sup> —PR. |
| All recovery devices (as an alternative to the above) | Concentration level or reading indicated by an organic monitoring device at the outlet of the recovery device [63.127(b)]  | 1. Continuous records during loading.<br>2. Record and report the concentration level or reading averaged over the full period of the performance test—NCS.   |
|   |  | 3. Record the daily average concentration level or reading for each operating day. <sup>d</sup>   |
|   |  | 4. Report all daily average concentration levels or readings that are outside the range established in the NCS or operating permit and all operating days when insufficient monitoring data are collected <sup>f</sup> —PR.   |
| All control devices and vapor balancing systems       | Presence of flow diverted to the atmosphere from the control device [63.127(d)(1)] or                                      | 1. Hourly records of whether the flow indicator was operating and whether a diversion was detected at   |

|  |   |  |
|--|---|--|
|  |   | any time during each hour.   |
|  |   | 2. Record and report the duration of all periods when the vent stream is diverted through a bypass line or the monitor is not operating—PR.  |
|  | Monthly inspections of sealed valves [63.127(d)(2)] | 1. Records that monthly inspections were performed.<br>2. Record and report all monthly inspections that show the valves are moved to the diverting position or the seal has been changed. |

<sup>a</sup>Regulatory citations are listed in brackets.

<sup>b</sup>Monitor may be installed in the firebox or in the ductwork immediately downstream of the firebox before any substantial heat exchange is encountered.

<sup>c</sup>“Continuous records” is defined in §63.111 of this subpart.

<sup>d</sup>NCS = Notification of Compliance Status described in §63.152 of this subpart.

<sup>e</sup>The daily average is the average of all recorded parameter values for the operating day. If all recorded values during an operating day are within the range established in the NCS or operating permit, a statement to this effect can be recorded instead of the daily average.

<sup>f</sup>The periodic reports shall include the duration of periods when monitoring data are not collected for each excursion as defined in §63.152(c)(2)(ii)(A) of this subpart.

<sup>g</sup>PR = Periodic Reports described in §63.152 of this subpart.

<sup>h</sup>Alternatively, these devices may comply with the organic monitoring device provisions listed at the end of this table under “All Recovery Devices.”

**Table 8 to Subpart G of Part 63—Organic HAP's Subject to the Wastewater Provisions for Process Units at New Sources**

| Chemical name        | CAS No. <sup>a</sup> |
|----------------------|----------------------|
| Allyl chloride       | 107051               |
| Benzene              | 71432                |
| Butadiene (1,3-)     | 106990               |
| Carbon disulfide     | 75150                |
| Carbon tetrachloride | 56235                |
| Cumene               | 98828                |

|  |        |
|--|--------|
| Ethylbenzene                                   | 100414 |
| Ethyl chloride (Chloroethane)                  | 75003  |
| Ethylidene dichloride<br>(1,1-Dichloroethane). | 75343  |
| Hexachlorobutadiene                            | 87683  |
| Hexachloroethane                               | 67721  |
| Hexane   | 100543 |
| Methyl bromide (Bromomethane)                  | 74839  |
| Methyl chloride (Chloromethane)                | 74873  |
| Phosgene                                       | 75445  |
| Tetrachloroethylene (Perchloroethylene)        | 127184 |
| Toluene  | 108883 |
| Trichloroethane (1,1,1-) (Methyl chloroform)   | 71556  |
| Trichloroethylene                              | 79016  |
| Trimethylpentane (2,2,4-)                      | 540841 |
| Vinyl chloride (chloroethylene)                | 75014  |
| Vinylidene chloride<br>(1,1-Dichloroethylene). | 75354  |
| Xylene (m-)                                    | 108383 |
| Xylene (p-)                                    | 106423 |

<sup>a</sup>CAS numbers refer to the Chemical Abstracts Service registry number assigned to specific compounds, isomers, or mixtures of compounds.

NOTE. The list of organic HAP's on table 8 is a subset of the list of organic HAP's on table 9 of this subpart.

**Table 9 to Subpart G of Part 63—Organic HAP's Subject to the Wastewater Provisions for Process Units at New and Existing Sources and Corresponding Fraction Removed (Fr) Values**

| Chemical name | CAS No. <sup>a</sup> | Fr   |
|---------------|----------------------|------|
| Acetaldehyde  | 75070                | 0.95 |
| Acetonitrile  | 75058                | 0.62 |
| Acetophenone  | 98862                | 0.72 |

|   |        |      |
|---|--------|------|
| Acrolein                                      | 107028 | 0.96 |
| Acrylonitrile                                 | 107131 | 0.96 |
| Allyl chloride                                | 107051 | 0.99 |
| Benzene                                       | 71432  | 0.99 |
| Benzyl chloride                               | 100447 | 0.99 |
| Biphenyl                                      | 92524  | 0.99 |
| Bromoform                                     | 75252  | 0.99 |
| Butadiene (1,3-)                              | 106990 | 0.99 |
| Carbon disulfide                              | 75150  | 0.99 |
| Carbon tetrachloride                          | 56235  | 0.99 |
| Chlorobenzene                                 | 108907 | 0.99 |
| Chloroform                                    | 67663  | 0.99 |
| Chloroprene (2-Chloro-1,3-butadiene)          | 126998 | 0.99 |
| Cumene  | 98828  | 0.99 |
| Dichlorobenzene (p-)                          | 106467 | 0.99 |
| Dichloroethane (1,2-) (Ethylene dichloride)   | 107062 | 0.99 |
| Dichloroethyl ether (Bis(2-chloroethyl)ether) | 111444 | 0.87 |
| Dichloropropene (1,3-)                        | 542756 | 0.99 |
| Diethyl sulfate                               | 64675  | 0.90 |
| Dimethyl sulfate                              | 77781  | 0.53 |
| Dimethylaniline (N,N-)                        | 121697 | 0.99 |
| Dimethylhydrazine (1,1-)                      | 57147  | 0.57 |
| Dinitrophenol (2,4-)                          | 51285  | 0.99 |
| Dinitrotoluene (2,4-)                         | 121142 | 0.38 |
| Dioxane (1,4-) (1,4-Diethyleneoxide)          | 123911 | 0.37 |
| Epichlorohydrin(1-Chloro-2,3-epoxypropane)    | 106898 | 0.91 |
| Ethyl acrylate                                | 140885 | 0.99 |
| Ethylbenzene                                  | 100414 | 0.99 |
| Ethyl chloride (Chloroethane)                 | 75003  | 0.99 |
| Ethylene dibromide (Dibromomethane)           | 106934 | 0.99 |



|  |         |      |
|--|---------|------|
| Ethylene glycol dimethyl ether             | 110714  | 0.90 |
| Ethylene glycol monobutyl ether acetate    | 112072  | 0.76 |
| Ethylene glycol monomethyl ether acetate   | 110496  | 0.28 |
| Ethylene oxide                             | 75218   | 0.98 |
| Ethylidene dichloride (1,1-Dichloroethane) | 75343   | 0.99 |
| Hexachlorobenzene                          | 118741  | 0.99 |
| Hexachlorobutadiene                        | 87683   | 0.99 |
| Hexachloroethane                           | 67721   | 0.99 |
| Hexane                                     | 110543  | 0.99 |
| Isophorone                                 | 78591   | 0.60 |
| Methanol                                   | 67561   | 0.31 |
| Methyl bromide (Bromomethane)              | 74839   | 0.99 |
| Methyl chloride (Chloromethane)            | 74873   | 0.99 |
| Methyl isobutyl ketone (Hexone)            | 108101  | 0.99 |
| Methyl methacrylate                        | 80626   | 0.98 |
| Methyl tert-butyl ether                    | 1634044 | 0.99 |
| Methylene chloride (Dichloromethane)       | 75092   | 0.99 |
| Naphthalene                                | 91203   | 0.99 |
| Nitrobenzene                               | 98953   | 0.80 |
| Nitropropane (2-)                          | 79469   | 0.98 |
| Phosgene                                   | 75445   | 0.99 |
| Propionaldehyde                            | 123386  | 0.99 |
| Propylene dichloride (1,2-Dichloropropane) | 78875   | 0.99 |
| Propylene oxide                            | 75569   | 0.99 |
| Styrene                                    | 100425  | 0.99 |
| Tetrachloroethane (1,1,2,2-)               | 79345   | 0.99 |
| Tetrachloroethylene (Perchloroethylene)    | 127184  | 0.99 |
| Toluene                                    | 108883  | 0.99 |
| Toluidine (o-)                             | 95534   | 0.44 |
| Trichlorobenzene (1,2,4-)                  | 120821  | 0.99 |

|  |        |      |
|--|--------|------|
| Trichloroethane (1,1,1-) (Methyl chloroform) | 71556  | 0.99 |
| Trichloroethane (1,1,2-) (Vinyl trichloride) | 79005  | 0.99 |
| Trichloroethylene                            | 79016  | 0.99 |
| Trichlorophenol (2,4,5-)                     | 95954  | 0.96 |
| Triethylamine                                | 121448 | 0.99 |
| Trimethylpentane (2,2,4-)                    | 540841 | 0.99 |
| Vinyl acetate                                | 108054 | 0.99 |
| Vinyl chloride (Chloroethylene)              | 75014  | 0.99 |
| Vinylidene chloride (1,1-Dichloroethylene)   | 75354  | 0.99 |
| Xylene (m-)                                  | 108383 | 0.99 |
| Xylene (o-)                                  | 95476  | 0.99 |
| Xylene (p-)                                  | 106423 | 0.99 |

<sup>a</sup>CAS numbers refer to the Chemical Abstracts Service registry number assigned to specific compounds, isomers, or mixtures of compounds.

[59 FR 19468, Apr. 22, 1994, as amended at 71 FR 76615, Dec. 21, 2006]

**Table 10 to Subpart G of Part 63—Wastewater—Compliance Options for Wastewater Tanks**

| Capacity (m <sup>3</sup> ) | Maximum true vapor pressure (kPa) | Control requirements           |
|----------------------------|-----------------------------------|--------------------------------|
| <75                        |                                   | §63.133(a)(1)                  |
| “75 and <151               | <13.1<br>”13.1                    | §63.133(a)(1)<br>§63.133(a)(2) |
| “151                       | <5.2<br>”5.2                      | §63.133(a)(1)<br>§63.133(a)(2) |

**Table 11 to Subpart G of Part 63—Wastewater—Inspection and Monitoring Requirements for Waste Management Units**

| To comply with | Inspection or monitoring requirement              | Frequency of inspection or monitoring | Method  |
|----------------|---|---------------------------------------|---------|
| Tanks:         |   |                                       |         |
| 63.133(b)(1)   | Inspect fixed roof and all openings for leaks     | Initially Semi-annually               | Visual. |
| 63.133(c)      | Inspect floating roof in accordance with §§63.120 | See §63.120 (a)(2) and (a)(3)         | Visual. |

|   |  |  |                                       |
|---|--|--|---------------------------------------|
|   | (a)(2) and (a)(3)  |  |                                       |
| 63.133(d)                               | Measure floating roof seal gaps in accordance with §§63.120 (b)(2)(i) through (b)(4)       |  | See §63.120 (b)(2)(i) through (b)(4). |
|   | —Primary seal gaps   | Once every 5 years<br>Initially Annually |                                       |
|   | —Secondary seal gaps   |  |                                       |
| 63.133(f) 63.133(g)                     | Inspect wastewater tank for control equipment failures and improper work practices         | Initially Semi-annually                  | Visual.                               |
| Surface impoundments:                   |  |  |                                       |
| 63.134(b)(1)                            | Inspect cover and all openings for leaks   | Initially Semi-annually                  | Visual.                               |
| 63.134(c)                               | Inspect surface impoundment for control equipment failures and improper work practices     | Initially Semi-annually                  | Visual.                               |
| Containers:                             |  |  |                                       |
| 63.135(b)(1),<br>63.135(b)(2)<br>(ii)   | Inspect cover and all openings for leaks   | Initially Semi-annually                  | Visual.                               |
| 63.135(d)(1)                            | Inspect enclosure and all openings for leaks   | Initially Semi-annually                  | Visual.                               |
| 63.135(e)                               | Inspect container for control equipment failures and improper work practices               | Initially Semi-annually                  | Visual.                               |
| Individual Drain Systems <sup>a</sup> : |  |  |                                       |
| 63.136(b)(1)                            | Inspect cover and all openings to ensure there are no gaps, cracks, or holes               | Initially Semi-annually                  | Visual.                               |
| 63.136(c)                               | Inspect individual drain system for control equipment failures and improper work practices | Initially Semi-annually                  | Visual.                               |
| 63.136(e)(1)                            | Verify that sufficient water is present to properly  | Initially Semi-annually                  | Visual.                               |

|                               |  |                                 |   |
|-------------------------------|--|---------------------------------|---|
|                               | maintain integrity of water seals  |                                 |   |
| 63.136(e)(2),<br>63.136(f)(1) | Inspect all drains using tightly-fitted caps or plugs to ensure caps and plugs are in place and properly installed | Initially Semi-annually         | Visual.   |
| 63.136(f)(2)                  | Inspect all junction boxes to ensure covers are in place and have no visible gaps, cracks, or holes                | Initially Semi-annually         | Visual or smoke test or other means as specified. |
| 63.136(f)(3)                  | Inspect unburied portion of all sewer lines for cracks and gaps  | Initially Semi-annually         | Visual.   |
| Oil-water separators:         |  |                                 |   |
| 63.137(b)(1)                  | Inspect fixed roof and all openings for leaks  | Initially Semi-annually         | Visual.   |
| 63.137(c)                     | Measure floating roof seal gaps in accordance with 40 CFR 60.696(d)(1)   | Initially <sup>b</sup>          | See 40 CFR 60.696(d)(1).                          |
|                               | —Primary seal gaps   | Once every 5 years              |   |
| 63.137(c)                     | —Secondary seal gaps   | Initially <sup>b</sup> Annually |   |
| 63.137(d)                     | Inspect oil-water separator for control equipment failures and improper work practices                             | Initially Semi-annually         | Visual.   |

<sup>a</sup>As specified in §63.136(a), the owner or operator shall comply with either the requirements of §63.136 (b) and (c) or §63.136 (e) and (f).

<sup>b</sup>Within 60 days of installation as specified in §63.137(c).

**Table 12 to Subpart G of Part 63—Monitoring Requirements for Treatment Processes**

| <b>To comply with</b>  | <b>Parameters to be monitored</b>  | <b>Frequency</b>   | <b>Methods</b>   |
|--|--|--|--|
| 1. Required mass removal of Table 8 and/or Table 9 compound(s) from wastewater treated in a properly operated biological treatment unit, | Appropriate parameters as specified in §63.143(c) and approved by permitting authority | Appropriate frequency as specified in §63.143 and approved by permitting | Appropriate methods as specified in §63.143 and as approved by permitting authority. |

|   |  |              |  |
|---|--|--------------|--|
| §63.138(f), and §63.138(g)  |  | authority    |  |
| 2. Steam stripper   | (i) Steam flow rate; and   | Continuously | Integrating steam flow monitoring device equipped with a continuous recorder.  |
|   | (ii) Wastewater feed mass flow rate; and   | Continuously | Liquid flow meter installed at stripper influent and equipped with a continuous recorder.  |
|   | (iii) Wastewater feed temperature; or<br>(iv) Column operating temperature   | Continuously | (A) Liquid temperature monitoring device installed at stripper influent and equipped with a continuous or recorder; or<br>(B) Liquid temperature monitoring device installed in the column top tray liquid phase (i.e., at the downcomer) and equipped with a continuous recorder. |
| 3. Other treatment processes or alternative monitoring parameters to those listed in item 2 of this table | Other parameters may be monitored upon approval from the Administrator with the requirements specified in §63.151(f) |              |  |

**Table 13 to Subpart G of Part 63—Wastewater—Monitoring Requirements for Control Devices**

| <b>Control Device</b> | <b>Monitoring equipment required</b>  | <b>Parameters to be monitored</b>  | <b>Frequency</b>   |
|-----------------------|---|--|--|
| All control devices   | 1. Flow indicator installed at all bypass lines to the atmosphere and equipped with continuous recorder <sup>b</sup> or | 1. Presence of flow diverted from the control device to the atmosphere <sup>or</sup> | Hourly records of whether the flow indicator was operating and whether a diversion was detected at any time during each hour |
|                       | 2. Valves sealed closed with car-seal or lock-and-key configuration   | 2. Monthly inspections of sealed valves  | Monthly.   |

|   |   |   |   |
|---|---|---|---|
| Thermal Incinerator   | Temperature monitoring device installed in firebox or in ductwork immediately downstream of firebox <sup>a</sup> and equipped with a continuous recorder <sup>b</sup> | Firebox temperature   | Continuous.   |
| Catalytic Incinerator   | Temperature monitoring device installed in gas stream immediately before and after catalyst bed and equipped with a continuous recorder <sup>b</sup>                  | 1. Temperature upstream of catalyst bed <i>or</i><br>2. Temperature difference across catalyst bed      | Continuous.   |
| Flare   | Heat sensing device installed at the pilot light and equipped with a continuous recorder <sup>a</sup>   | Presence of a flame at the pilot light  | Hourly records of whether the monitor was continuously operating and whether the pilot flame was continuously present during each hour. |
| Boiler or process heater <44 megawatts and vent stream is not mixed with the primary fuel | Temperature monitoring device installed in firebox <sup>a</sup> and equipped with continuous recorder <sup>b</sup>  | Combustion temperature  | Continuous.   |
| Condenser   | Temperature monitoring device installed at condenser exit and equipped with continuous recorder <sup>b</sup>  | Condenser exit (product side) temperature   | Continuous.   |
| Carbon adsorber (regenerative)  | Integrating regeneration stream flow monitoring device having an accuracy of $\pm 10$ percent, <i>and</i>   | Total regeneration stream mass or volumetric flow during carbon bed regeneration cycle(s)               | For each regeneration cycle, record the total regeneration stream mass or volumetric flow.  |
|   | Carbon bed temperature monitoring device  | Temperature of carbon bed after regeneration [and within 15 minutes of completing any cooling cycle(s)] | For each regeneration cycle and within 15 minutes of completing any cooling cycle, record the carbon bed temperature.                   |
| Carbon adsorber   | Organic compound  | Organic compound  | Daily or at intervals no  |

|                                   |   |                                   |  |
|-----------------------------------|---|-----------------------------------|--|
| (Non-regenerative)                | concentration monitoring device. <sup>c</sup>   | concentration of adsorber exhaust | greater than 20 percent of the design carbon replacement interval, whichever is greater. |
| Alternative monitoring parameters | Other parameters may be monitored upon approval from the Administrator in accordance with the requirements in §63.143(e)(3) |                                   |  |

<sup>a</sup>Monitor may be installed in the firebox or in the ductwork immediately downstream of the firebox before any substantial heat exchange is encountered.

<sup>b</sup>“Continuous recorder” is defined in §63.111 of this subpart.

<sup>c</sup>As an alternative to conducting this monitoring, an owner or operator may replace the carbon in the carbon adsorption system with fresh carbon at a regular predetermined time interval that is less than the carbon replacement interval that is determined by the maximum design flow rate and organic concentration in the gas stream vented to the carbon adsorption system.

**Tables 14-14b to Subpart G of Part 63 [Reserved]**

**Table 15 to Subpart G of Part 63—Wastewater—Information on Table 8 and/or Table 9 Compounds To Be Submitted With Notification of Compliance Status for Process Units at New and/or Existing Sources<sup>a,b</sup>**

| Process unit identification code <sup>c</sup> | Stream identification code | Concentration of table 8 and/or table 9 compound(s) (ppmw) <sup>d,e</sup> | Flow rate (lpm) <sup>e,f</sup> | Group 1 or Group 2 <sup>g</sup> | Compliance approach <sup>h</sup> | Treatment process(es) identification <sup>i</sup> | Waste management unit(s) identification | Intended control device |
|---|----------------------------|---|--------------------------------|---------------------------------|----------------------------------|---|---|-------------------------|
|   |                            |   |                                |                                 |                                  |   |   |                         |
|   |                            |   |                                |                                 |                                  |   |   |                         |
|   |                            |   |                                |                                 |                                  |   |   |                         |
|   |                            |   |                                |                                 |                                  |   |   |                         |

<sup>a</sup>The information specified in this table must be submitted; however, it may be submitted in any format. This table presents an example format.

<sup>b</sup>Other requirements for the NCS are specified in §63.152(b) of this subpart.

<sup>c</sup>Also include a description of the process unit (e.g., benzene process unit).

<sup>d</sup>Except when §63.132(e) is used, annual average concentration as specified in §63.132 (c) or (d) and §63.144.

<sup>e</sup>When §63.132(e) is used, indicate the wastewater stream is a designated Group 1 wastewater stream.

<sup>f</sup>Except when §63.132(e) is used, annual average flow rate as specified in §63.132 (c) or (d) and in §63.144.

<sup>g</sup>Indicate whether stream is Group 1 or Group 2. If Group 1, indicate whether it is Group 1 for Table 8 or Table 9 compounds or for both Table 8 and Table 9 compounds.

<sup>h</sup>Cite §63.138 compliance option used.

**Table 16 to Subpart G of Part 63 [Reserved]**

**Table 17 to Subpart G of Part 63—Information for Treatment Processes To Be Submitted With Notification of Compliance Status<sup>a,b</sup>**

| <b>Treatment process identification<sup>c</sup></b> | <b>Description<sup>d</sup></b> | <b>Wastewater stream(s) treated<sup>e</sup></b> | <b>Monitoring parameters<sup>f</sup></b> |
|---|--------------------------------|---|--|
|   |                                |   |  |
|   |                                |   |  |
|   |                                |   |  |

<sup>a</sup>The information specified in this table must be submitted; however, it may be submitted in any format. This table presents an example format.

<sup>b</sup>Other requirements for the Notification of Compliance Status are specified in §63.152(b) of this Subpart.

<sup>c</sup>Identification codes should correspond to those listed in Table 15.

<sup>d</sup>Description of treatment process.

<sup>e</sup>Stream identification code for each wastewater stream treated by each treatment unit. Identification codes should correspond to entries listed in Table 15.

<sup>f</sup>Parameter(s) to be monitored or measured in accordance with Table 12 and §63.143.

**Table 18 to Subpart G of Part 63—Information for Waste Management Units To Be Submitted With Notification of Compliance Status<sup>a,b</sup>**

| <b>Waste management unit identification<sup>c</sup></b> | <b>Description<sup>d</sup></b> | <b>Wastewater stream(s) received or managed<sup>e</sup></b> |
|---|--------------------------------|---|
|   |                                |   |
|   |                                |   |



|  |  |  |
|--|--|--|
|  |  |  |
|--|--|--|

<sup>a</sup>The information specified in this table must be submitted; however, it may be submitted in any format. This table presents an example format.

<sup>b</sup>Other requirements for the Notification of Compliance Status are specified in §63.152(b) of this Subpart.

<sup>c</sup>Identification codes should correspond to those listed in Table 15.

<sup>d</sup>Description of waste management unit.

<sup>e</sup>Stream identification code for each wastewater stream received or managed by each waste management unit. Identification codes should correspond to entries listed in Table 15.

**Table 19 to Subpart G of Part 63—Wastewater—Information on Residuals To Be Submitted With Notification of Compliance Status<sup>a,b</sup>**

| <b>Residual<br/>identification<br/>c</b> | <b>Residual<br/>description<br/>d</b> | <b>Wastewater<br/>stream<br/>identification<br/>e</b> | <b>Treatment<br/>process<br/>f</b> | <b>Fate<br/>g</b> | <b>Control<br/>device<br/>identification<br/>code</b> | <b>Control<br/>device<br/>description<br/>h</b> | <b>Control<br/>device<br/>efficiency<br/>i</b> |
|--|---------------------------------------|---|------------------------------------|-------------------|---|---|--|
|  |                                       |   |                                    |                   |   |   |  |
|  |                                       |   |                                    |                   |   |   |  |
|  |                                       |   |                                    |                   |   |   |  |
|  |                                       |   |                                    |                   |   |   |  |

<sup>a</sup>The information specified in this table must be submitted; however, it may be submitted in any format. This table presents an example format.

<sup>b</sup>Other requirements for the Notification of Compliance Status are specified in §63.152(b) of this subpart.

<sup>c</sup>Name or identification code of residual removed from Group 1 wastewater stream.

<sup>d</sup>Description of residual (e.g., steam stripper A-13 overhead condensates).

<sup>e</sup>Identification of stream from which residual is removed.

<sup>f</sup>Treatment process from which residual originates.

<sup>g</sup>Indicate whether residual is sold, returned to production process, or returned to waste management unit or treatment process; or whether HAP mass of residual is destroyed by 99 percent.

<sup>h</sup>If the fate of the residual is such that the HAP mass is destroyed by 99 percent, give description of device used for HAP destruction.

If the fate of the residual is such that the HAP mass is destroyed by 99 percent, provide an estimate of control device efficiency and attach substantiation in accordance with §63.146(b)(9) of this subpart.

**Table 20 to Subpart G of Part 63—Wastewater—Periodic Reporting Requirements for Control Devices Subject to §63.139 Used To Comply With §§63.13 Through 63.139**

| Control device   | Reporting requirements   |
|--|--|
| (1) Thermal Incinerator  | Report all daily average <sup>a</sup> temperatures that are outside the range established in the NCS <sup>b</sup> or operating permit and all operating days when insufficient monitoring data are collected. <sup>c</sup>         |
| (2) Catalytic Incinerator  | (i) Report all daily average <sup>a</sup> upstream temperatures that are outside the range established in the NCS <sup>b</sup> or operating permit.  |
|  | (ii) Report all daily average <sup>a</sup> temperature differences across the catalyst bed that are outside the range established in the NCS <sup>b</sup> or operating permit.   |
|  | (iii) Report all operating days when insufficient monitoring data are collected. <sup>c</sup>  |
| (3) Boiler or Process Heater with a design heat input capacity less than 44 megawatts and vent stream is not mixed with the primary fuel | Report all daily average <sup>a</sup> firebox temperatures that are outside the range established in the NCS <sup>b</sup> or operating permit and all operating days when insufficient monitoring data are collected. <sup>c</sup> |
| (4) Flare  | Report the duration of all periods when all pilot flames are absent.   |
| (5) Condenser  | Report all daily average <sup>a</sup> exit temperatures that are outside the range established in the NCS <sup>b</sup> or operating permit and all operating days when insufficient monitoring data are collected. <sup>c</sup>    |
| (6) Carbon Adsorber (Regenerative)   | (i) Report all carbon bed regeneration cycles when the total regeneration stream mass or volumetric flow is outside the range established in the NCS <sup>b</sup> or operating permit.   |
|  | (ii) Report all carbon bed regeneration cycles during which the temperature of the carbon bed after regeneration is outside the range established in the NCS <sup>b</sup> or operating permit.                                     |
|  | (iii) Report all operating days when insufficient monitoring data are collected. <sup>c</sup>  |
| (7) Carbon Adsorber (Non-Regenerative)   | (i) Report all operating days when inspections not done according to the schedule developed as specified in table  |

|                         |  |
|-------------------------|--|
|                         | 13 of this subpart.  |
|                         | (ii) Report all operating days when carbon has not been replaced at the frequency specified in table 13 of this subpart.                     |
| (8) All Control Devices | (i) Report the times and durations of all periods when the vent stream is diverted through a bypass line or the monitor is not operating, or |
|                         | (ii) Report all monthly inspections that show the valves are moved to the diverting position or the seal has been changed.                   |

<sup>a</sup>The daily average is the average of all values recorded during the operating day, as specified in §63.147(d).

<sup>b</sup>NCS = Notification of Compliance Status described in §63.152.

<sup>c</sup>The periodic reports shall include the duration of periods when monitoring data are not collected for each excursion as defined in §63.152(c)(2)(ii)(A).

**Table 21 to Subpart G of Part 63—Average Storage Temperature ( $T_s$ ) as a Function of Tank Paint Color**

| <b>Tank Color</b> | <b>Average Storage Temperature (<math>T_s</math>)</b> |
|-------------------|---|
| White             | $T_A - a = 0$   |
| Aluminum          | $T_A = 2.5$   |
| Gray              | $T_A = 3.5$   |
| Black             | $T_A = 5.0$   |

<sup>a</sup>  $T_A$  is the average annual ambient temperature in degrees Fahrenheit.

**Table 22 to Subpart G of Part 63—Paint Factors for Fixed Roof Tanks**

| <b>Tank color</b>   |                     | <b>Paint factors (<math>F_p</math>)<br/>Paint Condition</b> |             |
|---------------------|---------------------|---|-------------|
| <b>Roof</b>         | <b>Shell</b>        | <b>Good</b>   | <b>Poor</b> |
| White               | White               | 1.00  | 1.15        |
| Aluminum (specular) | White               | 1.04  | 1.18        |
| White               | Aluminum (specular) | 1.16  | 1.24        |
| Aluminum (specular) | Aluminum (specular) | 1.20  | 1.29        |
| White               | Aluminum (diffuse)  | 1.30  | 1.38        |

|                    |                    |      |      |
|--------------------|--------------------|------|------|
| Aluminum (diffuse) | Aluminum (diffuse) | 1.39 | 1.46 |
| White              | Gray               | 1.30 | 1.38 |
| Light gray         | Light gray         | 1.33 | 1.44 |
| Medium gray        | Medium gray        | 1.40 | 1.58 |

**Table 23 to Subpart G of Part 63—Average Clingage Factors (c)<sup>a</sup>**

| Liquid                  | Shell condition         |            |              |
|-------------------------|-------------------------|------------|--------------|
|                         | Light rust <sup>b</sup> | Dense rust | Gunite lined |
| Gasoline                | 0.0015                  | 0.0075     | 0.15         |
| Single component stocks | 0.0015                  | 0.0075     | 0.15         |
| Crude oil               | 0.0060                  | 0.030      | 0.60         |

<sup>a</sup>Units for average clingage factors are barrels per 1,000 square feet.

<sup>b</sup>If no specific information is available, these values can be assumed to represent the most common condition of tanks currently in use.

**Table 24 to Subpart G of Part 63—Typical Number of Columns as a Function of Tank Diameter for Internal Floating Roof Tanks With Column Supported Fixed Roofs<sup>a</sup>**

| Tank diameter range (D in feet) | Typical number of columns, (N <sub>c</sub> ) |
|---------------------------------|--|
| 0 <D ≤85                        | 1  |
| 85 <D ≤100                      | 6  |
| 100 <D ≤120                     | 7  |
| 120 <D ≤135                     | 8  |
| 135 <D ≤150                     | 9  |
| 150 <D ≤170                     | 16   |
| 170 <D ≤190                     | 19   |
| 190 <D ≤220                     | 22   |
| 220 <D ≤235                     | 31   |
| 235 <D ≤270                     | 37   |
| 270 <D ≤275                     | 43   |
| 275 <D ≤290                     | 49   |
| 290 <D ≤330                     | 61   |
| 330 <D ≤360                     | 71   |

|             |    |
|-------------|----|
| 360 <D ≤400 | 81 |
|-------------|----|

<sup>a</sup>Data in this table should not supersede information on actual tanks.

**Table 25 to Subpart G of Part 63—Effective Column Diameter (F<sub>c</sub>)**

| Column type                       | F <sub>c</sub> (feet) |
|-----------------------------------|-----------------------|
| 9-inch by 7-inch built-up columns | 1.1                   |
| 8-inch-diameter pipe columns      | 0.7                   |
| No construction details known     | 1.0                   |

**Table 26 to Subpart G of Part 63—Seal Related Factors for Internal Floating Roof Vessels**

| Seal type                                    | K <sub>s</sub> | n |
|--|----------------|---|
| Liquid mounted resilient seal:               |                |   |
| Primary seal only                            | 3.0            | 0 |
| With rim-mounted secondary seal <sup>a</sup> | 1.6            | 0 |
| Vapor mounted resilient seal:                |                |   |
| Primary seal only                            | 6.7            | 0 |
| With rim-mounted secondary seal <sup>a</sup> | 2.5            | 0 |

<sup>a</sup>If vessel-specific information is not available about the secondary seal, assume only a primary seal is present.

**Table 27 to Subpart G of Part 63—Summary of Internal Floating Deck Fitting Loss Factors (K<sub>F</sub>) and Typical Number of Fittings (N<sub>F</sub>)**

| Deck fitting type          | Deck fitting loss factor (K <sub>F</sub> ) <sup>a</sup> | Typical number of fittings (N <sub>F</sub> ) |
|----------------------------|---|--|
| Access hatch               |   | 1.   |
| Bolted cover, gasketed     | 1.6   |  |
| Unbolted cover, gasketed   | 11  |  |
| Unbolted cover, ungasketed | <sup>b</sup> 25   |  |
| Automatic gauge float well |   | 1.   |
| Bolted cover, gasketed     | 5.1   |  |
| Unbolted cover, gasketed   | 15  |  |
| Unbolted cover, ungasketed | <sup>b</sup> 28   |  |
| Column well                |   | (see Table 24).                              |

|  |                       |                            |
|--|-----------------------|----------------------------|
| Builtup column-sliding cover, gasketed             | 33                    |                            |
| Builtup column-sliding cover, ungasketed           | <sup>b</sup> 47<br>10 |                            |
| Pipe column-flexible fabric sleeve seal            | 19                    |                            |
| Pipe column-sliding cover, gasketed                | 32                    |                            |
| Pipe column-sliding cover, ungasketed              |                       |                            |
| Ladder well  |                       | 1.                         |
| Sliding cover, gasketed                            | 56                    |                            |
| Sliding cover, ungasketed                          | <sup>b</sup> 76       |                            |
| Roof leg or hanger well                            |                       | $(5 + D/10 + D^2/600)^c$ . |
| Adjustable   | <sup>b</sup> 7.9      |                            |
| Fixed  | 0                     |                            |
| Sample pipe or well                                |                       | 1.                         |
| Slotted pipe-sliding cover, gasketed               | 44                    |                            |
| Slotted pipe-sliding cover, ungasketed             | 57                    |                            |
| Sample well-slit fabric seal, 10 percent open area | <sup>b</sup> 12       |                            |
| Stub drain, 1-in diameter <sup>d</sup>             | 1.2                   | $(D^2/125)^c$ .            |
| Vacuum breaker                                     |                       | 1.                         |
| Weighted mechanical actuation, gasketed            | <sup>b</sup> 0.7      |                            |
| Weighted mechanical actuation, ungasketed          | 0.9                   |                            |

<sup>a</sup>Units for  $K_F$  are pound-moles per year.

<sup>b</sup>If no specific information is available, this value can be assumed to represent the most common/typical deck fittings currently used.

<sup>c</sup>D = Tank diameter (feet).

<sup>d</sup>Not used on welded contact internal floating decks.

**Table 28 to Subpart G of Part 63—Deck Seam Length Factors<sup>a</sup> ( $S_D$ ) for Internal Floating Roof Tanks**

| Deck construction                            | Typical deck seam length factor |
|--|---------------------------------|
| Continuous sheet construction <sup>b</sup> : |                                 |
| 5-foot wide sheets                           | 0.2 <sup>c</sup>                |
| 6-foot wide sheets                           | 0.17                            |
| 7-foot wide sheets                           | 0.14                            |
| Panel construction <sup>d</sup> :            |                                 |
| 5 × 7.5 feet rectangular                     | 0.33                            |
| 5 × 12 feet rectangular                      | 0.28                            |

<sup>a</sup>Deck seam loss applies to bolted decks only. Units for  $S_D$  are feet per square feet.

<sup>b</sup>  $S_D = 1/W$ , where  $W$  = sheet width (feet).

<sup>c</sup>If no specific information is available, these factors can be assumed to represent the most common bolted decks currently in use.

<sup>d</sup>  $S_D = (L + W)/LW$ , where  $W$  = panel width (feet), and  $L$  = panel length (feet).

**Table 29 to Subpart G of Part 63—Seal Related Factors for External Floating Roof Vessels**

| Seal type                        | Welded vessels |     | Riveted vessels |     |
|----------------------------------|----------------|-----|-----------------|-----|
|                                  | $K_s$          | N   | $K_s$           | N   |
| Metallic shoe seal:              |                |     |                 |     |
| Primary seal only                | 1.2            | 1.5 | 1.3             | 1.5 |
| With shoe-mounted secondary seal | 0.8            | 1.2 | 1.4             | 1.2 |
| With rim-mounted secondary seal  | 0.2            | 1.0 | 0.2             | 1.6 |
| Liquid mounted resilient seal:   |                |     |                 |     |
| Primary seal only                | 1.1            | 1.0 | <sup>a</sup> NA | NA  |
| With weather shield              | 0.8            | 0.9 | NA              | NA  |
| With rim-mounted secondary seal  | 0.7            | 0.4 | NA              | NA  |
| Vapor mounted resilient seal:    |                |     |                 |     |
| Primary seal only                | 1.2            | 2.3 | NA              | NA  |
| With weather shield              | 0.9            | 2.2 | NA              | NA  |
| With rim-mounted secondary seal  | 0.2            | 2.6 | NA              | NA  |

<sup>a</sup>NA = Not applicable.

**Table 30 to Subpart G of Part 63—Roof Fitting Loss Factors,  $K_{Fa}$ ,  $K_{Fb}$ , and  $m$ ,<sup>a</sup> and Typical Number of Fittings,  $N_T$**

| Fitting type and construction details  | Loss factors <sup>b</sup> |   |                     | Typical number of fittings, $N_T$ |
|--|---------------------------|---|---------------------|-----------------------------------|
|  | $K_{Fa}$ (lb-mole/yr)     | $K_{Fb}$ (lb-mole/[mi/hr] <sup>m</sup> -yr) | $m$ (dimensionless) |                                   |
| Access hatch (24-in-diameter well)   |                           |   |                     | 1.                                |
| Bolted cover, gasketed   | 0                         | 0   | <sup>c</sup> 0      |                                   |
| Unbolted cover, ungasketed   | 2.7                       | 7.1   | 1.0                 |                                   |
| Unbolted cover, gasketed   | 2.9                       | 0.41  | 1.0                 |                                   |
| Unslotted guide-pole well (8-in-diameter unslotted pole, 21-in-diameter well)      |                           |   |                     | 1.                                |
| Ungasketed sliding cover   | 0                         | 67  | <sup>c</sup> 0.98   |                                   |
| Gasketed sliding cover   | 0                         | 3.0   | 1.4                 |                                   |
| Slotted guide-pole/sample well (8-in-diameter unslotted pole, 21-in-diameter well) |                           |   |                     | ( <sup>d</sup> ).                 |
| Ungasketed sliding cover, without float  | 0                         | 310   | 1.2                 |                                   |
| Ungasketed sliding cover, with float   | 0                         | 29  | 2.0                 |                                   |
| Gasketed sliding cover, without float  | 0                         | 260   | 1.2                 |                                   |
| Gasketed sliding cover, with float   | 0                         | 8.5   | 1.4                 |                                   |
| Gauge-float well (20-inch diameter)  |                           |   |                     | 1.                                |
| Unbolted cover, ungasketed   | 2.3                       | 5.9   | <sup>c</sup> 1.0    |                                   |
| Unbolted cover, gasketed   | 2.4                       | 0.34  | 1.0                 |                                   |
| Bolted cover, gasketed   | 0                         | 0   | 0                   |                                   |
| Gauge-hatch/sample well (8-inch  |                           |   |                     | 1.                                |



|   |      |       |                  |   |
|---|------|-------|------------------|---|
| diameter)                                 |      |       |                  |   |
| Weighted mechanical actuation, gasketed   | 0.95 | 0.14  | <sup>c</sup> 1.0 |   |
| Weighted mechanical actuation, ungasketed | 0.91 | 2.4   | 1.0              |   |
| Vacuum breaker (10-in-diameter well)      |      |       |                  | N <sub>F6</sub> (Table 31).               |
| Weighted mechanical actuation, gasketed   | 1.2  | 0.17  | <sup>c</sup> 1.0 |   |
| Weighted mechanical actuation, ungasketed | 1.2  | 3.0   | 1.0              |   |
| Roof drain (3-in-diameter)                |      |       |                  | N <sub>F7</sub> (Table 31).               |
| Open                                      | 0    | 7.0   | <sup>e</sup> 1.4 | N <sub>F8</sub> (Table 32 <sup>f</sup> ). |
| 90 percent closed                         | 0.51 | 0.81  | 1.0              |   |
| Roof leg (3-in-diameter)                  |      |       |                  | N <sub>F8</sub> (Table 32 <sup>f</sup> ). |
| Adjustable, pontoon area                  | 1.5  | 0.20  | <sup>c</sup> 1.0 |   |
| Adjustable, center area                   | 0.25 | 0.067 | <sup>c</sup> 1.0 |   |
| Adjustable, double-deck roofs             | 0.25 | 0.067 | 1.0              |   |
| Fixed                                     | 0    | 0     | 0                |   |
| Roof leg (2 1/2-in-diameter)              |      |       |                  | N <sub>F8</sub> (Table 32 <sup>f</sup> ). |
| Adjustable, pontoon area                  | 1.7  | 0     | 0                |   |
| Adjustable, center area                   | 0.41 | 0     | 0                |   |
| Adjustable, double-deck roofs             | 0.41 | 0     | 0                |   |
| Fixed                                     | 0    | 0     | 0                |   |
| Rim vent (6-in-diameter)                  |      |       |                  | 1 <sup>g</sup> .                          |
| Weighted mechanical actuation, gasketed   | 0.71 | 0.10  | <sup>c</sup> 1.0 |   |
| Weighted mechanical actuation, ungasketed | 0.68 | 1.8   | 1.0              |   |

<sup>a</sup>The roof fitting loss factors,  $K_{Fa}$ ,  $K_{Fb}$ , and  $m$ , may only be used for wind speeds from 2 to 15 miles per hour.

<sup>b</sup>Unit abbreviations are as follows: lb = pound; mi = miles; hr = hour; yr = year.

<sup>c</sup>If no specific information is available, this value can be assumed to represent the most common or typical roof fittings currently in use.

<sup>d</sup>A slotted guide-pole/sample well is an optional fitting and is not typically used.

<sup>e</sup>Roof drains that drain excess rainwater into the product are not used on pontoon floating roofs. They are, however, used on double-deck floating roofs and are typically left open.

<sup>f</sup>The most common roof leg diameter is 3 inches. The loss factors for 2 1/2-inch diameter roof legs are provided for use if this smaller size roof is used on a particular floating roof.

<sup>g</sup>Rim vents are used only with mechanical-shoe primary seals.

**Table 31 to Subpart G of Part 63—Typical Number of Vacuum Breakers,  $N_{F6}$  and Roof Drains,<sup>a</sup>  $N_{F7}$**

| Tank diameter D<br>(feet) <sup>b</sup> | No. of vacuum breakers, $N_{F6}$ |                     | No. of roof drains, $N_{F7}$ double-deck<br>roof <sup>c</sup> |
|--|----------------------------------|---------------------|---|
|  | Pontoon<br>roof                  | Double-deck<br>roof |   |
| 50                                     | 1                                | 1                   | 1   |
| 100                                    | 1                                | 1                   | 1   |
| 150                                    | 2                                | 2                   | 2   |
| 200                                    | 3                                | 2                   | 3   |
| 250                                    | 4                                | 3                   | 5   |
| 300                                    | 5                                | 3                   | 7   |
| 350                                    | 6                                | 4                   | <sup>d</sup>  |
| 400                                    | 7                                | 4                   | <sup>d</sup>  |

<sup>a</sup>This table should not supersede information based on actual tank data.

<sup>b</sup>If the actual diameter is between the diameters listed, the closest diameter listed should be used. If the actual diameter is midway between the diameters listed, the next larger diameter should be used.

<sup>c</sup>Roof drains that drain excess rainwater into the product are not used on pontoon floating roofs. They are, however, used on double-deck floating roofs, and are typically left open.

<sup>d</sup>For tanks more than 300 feet in diameter, actual tank data or the manufacturer's recommendations may be needed for the number of roof drains.

**Table 32 to Subpart G of Part 63—Typical Number of Roof Legs,<sup>a</sup>  $N_{F8}$**

| Tank diameter D<br>(feet) <sup>b</sup> | Pontoon roof           |                       | No. of legs on double-deck<br>roof |
|--|------------------------|-----------------------|------------------------------------|
|  | No. of pontoon<br>legs | No. of center<br>legs |                                    |
| 30                                     | 4                      | 2                     | 6                                  |
| 40                                     | 4                      | 4                     | 7                                  |
| 50                                     | 6                      | 6                     | 8                                  |
| 60                                     | 9                      | 7                     | 10                                 |
| 70                                     | 13                     | 9                     | 13                                 |
| 80                                     | 15                     | 10                    | 16                                 |
| 90                                     | 16                     | 12                    | 20                                 |
| 100                                    | 17                     | 16                    | 25                                 |
| 110                                    | 18                     | 20                    | 29                                 |
| 120                                    | 19                     | 24                    | 34                                 |
| 130                                    | 20                     | 28                    | 40                                 |
| 140                                    | 21                     | 33                    | 46                                 |
| 150                                    | 23                     | 38                    | 52                                 |
| 160                                    | 26                     | 42                    | 58                                 |
| 170                                    | 27                     | 49                    | 66                                 |
| 180                                    | 28                     | 56                    | 74                                 |
| 190                                    | 29                     | 62                    | 82                                 |
| 200                                    | 30                     | 69                    | 90                                 |
| 210                                    | 31                     | 77                    | 98                                 |
| 220                                    | 32                     | 83                    | 107                                |
| 230                                    | 33                     | 92                    | 115                                |
| 240                                    | 34                     | 101                   | 127                                |
| 250                                    | 34                     | 109                   | 138                                |
| 260                                    | 36                     | 118                   | 149                                |
| 270                                    | 36                     | 128                   | 162                                |
| 280                                    | 37                     | 138                   | 173                                |
| 290                                    | 38                     | 148                   | 186                                |

|     |    |     |     |
|-----|----|-----|-----|
| 300 | 38 | 156 | 200 |
| 310 | 39 | 168 | 213 |
| 320 | 39 | 179 | 226 |
| 330 | 40 | 190 | 240 |
| 340 | 41 | 202 | 255 |
| 350 | 42 | 213 | 270 |
| 360 | 44 | 226 | 285 |
| 370 | 45 | 238 | 300 |
| 380 | 46 | 252 | 315 |
| 390 | 47 | 266 | 330 |
| 400 | 48 | 281 | 345 |

<sup>a</sup>This table should not supersede information based on actual tank data.

<sup>b</sup>If the actual diameter is between the diameters listed, the closest diameter listed should be used. If the actual diameter is midway between the diameters listed, the next larger diameter should be used.

**Table 33 to Subpart G of Part 63—Saturation Factors**

| <b>Cargo carrier</b>           | <b>Mode of operation</b>                           | <b>S factor</b> |
|--------------------------------|--|-----------------|
| Tank trucks and rail tank cars | Submerged loading of a clean cargo tank            | 0.50            |
|                                | Submerged loading: dedicated normal service        | 0.60            |
|                                | Submerged loading: dedicated vapor balance service | 1.00            |
|                                | Splash loading of a clean cargo tank               | 1.45            |
|                                | Splash loading: dedicated normal service           | 1.45            |
|                                | Splash loading: dedicated vapor balance service    | 1.00            |

**Table 34 to Subpart G of Part 63—Fraction Measured ( $F_m$ ) and Fraction Emitted ( $F_e$ ) For HAP Compounds in Wastewater Streams**

| <b>Chemical name</b> | <b>CAS Number<sup>a</sup></b> | <b><math>F_m</math></b> | <b><math>F_e</math></b> |
|----------------------|-------------------------------|-------------------------|-------------------------|
| Acetaldehyde         | 75070                         | 1.00                    | 0.48                    |
| Acetonitrile         | 75058                         | 0.99                    | 0.36                    |
| Acetophenone         | 98862                         | 0.31                    | 0.14                    |
| Acrolein             | 107028                        | 1.00                    | 0.43                    |
| Acrylonitrile        | 107131                        | 1.00                    | 0.43                    |

|  |        |         |       |
|--|--------|---------|-------|
| Allyl chloride                                 | 107051 | 1.00    | 0.89  |
| Benzene  | 71432  | 1.00    | 0.80  |
| Benzyl chloride                                | 100447 | 1.00    | 0.47  |
| Biphenyl                                       | 92524  | 0.86    | 0.45  |
| Bromoform                                      | 75252  | 1.00    | 0.49  |
| Butadiene (1,3-)                               | 106990 | 1.00    | 0.98  |
| Carbon disulfide                               | 75150  | 1.00    | 0.92  |
| Carbon tetrachloride                           | 56235  | 1.00    | 0.94  |
| Chlorobenzene                                  | 108907 | 1.00    | 0.73  |
| Chloroform                                     | 67663  | 1.00    | 0.78  |
| Chloroprene (2-Chloro-1,3-butadiene)           | 126998 | 1.00    | 0.68  |
| Cumene   | 98828  | 1.00    | 0.88  |
| Dichlorobenzene (p-)                           | 106467 | 1.00    | 0.72  |
| Dichloroethane (1,2-) (Ethylene dichloride)    | 107062 | 1.00    | 0.64  |
| Dichloroethyl ether (Bis(2-Chloroethyl ether)) | 111444 | 0.76    | 0.21  |
| Dichloropropene (1,3-)                         | 542756 | 1.00    | 0.76  |
| Diethyl sulfate                                | 64675  | 0.0025  | 0.11  |
| Dimethyl sulfate                               | 77781  | 0.086   | 0.079 |
| Dimethylaniline (N,N-)                         | 121697 | 0.00080 | 0.34  |
| Dimethylhydrazine (1,1-)                       | 57147  | 0.38    | 0.054 |
| Dinitrophenol (2,4-)                           | 51285  | 0.0077  | 0.060 |
| Dinitrotoluene (2,4-)                          | 121142 | 0.085   | 0.18  |
| Dioxane (1,4-) (1,4-Diethyleneoxide)           | 123911 | 0.87    | 0.18  |
| Epichlorohydrin(1-Chloro-2,3-epoxypropane)     | 106898 | 0.94    | 0.35  |
| Ethyl acrylate                                 | 140885 | 1.00    | 0.48  |
| Ethylbenzene                                   | 100414 | 1.00    | 0.83  |
| Ethyl chloride (Chloroethane)                  | 75003  | 1.00    | 0.90  |
| Ethylene dibromide (Dibromomethane)            | 106934 | 1.00    | 0.57  |
| Ethylene glycol dimethyl ether                 | 110714 | 0.86    | 0.32  |
| Ethylene glycol monobutyl ether acetate        | 112072 | 0.043   | 0.067 |

|  |         |       |       |
|--|---------|-------|-------|
| Ethylene glycol monomethyl ether acetate     | 110496  | 0.093 | 0.048 |
| Ethylene oxide                               | 75218   | 1.00  | 0.50  |
| Ethylidene dichloride (1,1-Dichloroethane)   | 75343   | 1.00  | 0.79  |
| Hexachlorobenzene                            | 118741  | 0.97  | 0.64  |
| Hexachlorobutadiene                          | 87683   | 0.88  | 0.86  |
| Hexachloroethane                             | 67721   | 0.50  | 0.85  |
| Hexane                                       | 110543  | 1.00  | 1.00  |
| Isophorone                                   | 78591   | 0.51  | 0.11  |
| Methanol                                     | 67561   | 0.85  | 0.17  |
| Methyl bromide (Bromomethane)                | 74839   | 1.00  | 0.85  |
| Methyl chloride (Chloromethane)              | 74873   | 1.00  | 0.84  |
| Methyl isobutyl ketone (Hexone)              | 108101  | 0.98  | 0.53  |
| Methyl methacrylate                          | 80626   | 1.00  | 0.37  |
| Methyl tert-butyl ether                      | 1634044 | 1.00  | 0.57  |
| Methylene chloride (Dichloromethane)         | 75092   | 1.00  | 0.77  |
| Naphthalene                                  | 91203   | 0.99  | 0.51  |
| Nitrobenzene                                 | 98953   | 0.39  | 0.23  |
| Nitropropane (2-)                            | 79469   | 0.99  | 0.44  |
| Phosgene                                     | 75445   | 1.00  | 0.87  |
| Propionaldehyde                              | 123386  | 1.00  | 0.41  |
| Propylene dichloride (1,2-Dichloropropane)   | 78875   | 1.00  | 0.72  |
| Propylene oxide                              | 75569   | 1.00  | 0.60  |
| Styrene                                      | 100425  | 1.00  | 0.80  |
| Tetrachloroethane (1,1,2,2-)                 | 79345   | 1.00  | 0.46  |
| Tetrachloroethylene (Perchloroethylene)      | 127184  | 1.00  | 0.92  |
| Toluene                                      | 108883  | 1.00  | 0.80  |
| Toluidine (o-)                               | 95534   | 0.15  | 0.052 |
| Trichlorobenzene (1,2,4-)                    | 120821  | 1.00  | 0.64  |
| Trichloroethane (1,1,1-) (Methyl chloroform) | 71556   | 1.00  | 0.91  |
| Trichloroethane (1,1,2-) (Vinyl Trichloride) | 79005   | 1.00  | 0.60  |

|  |        |      |       |
|--|--------|------|-------|
| Trichloroethylene                          | 79016  | 1.00 | 0.87  |
| Trichlorophenol (2,4,5-)                   | 95954  | 0.11 | 0.086 |
| Triethylamine                              | 121448 | 1.00 | 0.38  |
| Trimethylpentane (2,2,4-)                  | 540841 | 1.00 | 1.00  |
| Vinyl acetate                              | 108054 | 1.00 | 0.59  |
| Vinyl chloride (Chloroethylene)            | 75014  | 1.00 | 0.97  |
| Vinylidene chloride (1,1-Dichloroethylene) | 75354  | 1.00 | 0.94  |
| Xylene (m-)                                | 108383 | 1.00 | 0.82  |
| Xylene (o-)                                | 95476  | 1.00 | 0.79  |
| Xylene (p-)                                | 106423 | 1.00 | 0.82  |

<sup>a</sup>CAS numbers refer to the Chemical Abstracts Service registry number assigned to specific compounds, isomers, or mixtures of compounds.

[59 FR 19468, Apr. 22, 1994, as amended at 71 FR 76615, Dec. 21, 2006]

**Table 35 to Subpart G of Part 63—Control Requirements for Items of Equipment That Meet the Criteria of §63.149 of Subpart G**

| <b>Item of equipment</b> | <b>Control requirement<sup>a</sup></b>   |
|--------------------------|--|
| Drain or drain hub       | (a) Tightly fitting solid cover (TFSC); or<br>(b) TFSC with a vent to either a process, or to a fuel gas system, or to a control device meeting the requirements of §63.139(c); or<br>(c) Water seal with submerged discharge or barrier to protect discharge from wind.   |
| Manhole <sup>b</sup>     | (a) TFSC; or<br>(b) TSFC with a vent to either a process, or to a fuel gas system, or to a control device meeting the requirements of §63.139(c); or<br>(c) If the item is vented to the atmosphere, use a TFSC with a properly operating water seal at the entrance or exit to the item to restrict ventilation in the collection system. The vent pipe shall be at least 90 cm in length and not exceeding 10.2 cm in nominal inside diameter.   |
| Lift station             | (a) TFSC; or<br>(b) TFSC with a vent to either a process, or to a fuel gas system, or to a control device meeting the requirements of §63.139(c); or<br>(c) If the lift station is vented to the atmosphere, use a TFSC with a properly operating water seal at the entrance or exit to the item to restrict ventilation in the collection system. The vent pipe shall be at least 90 cm in length and not exceeding 10.2 cm in nominal inside diameter. The lift station shall be level controlled to minimize changes in the liquid level. |

|                     |  |
|---------------------|--|
| Trench              | (a) TFSC; or<br>(b) TFSC with a vent to either a process, or to a fuel gas system, or to a control device meeting the requirements of §63.139(c); or<br>(c) If the item is vented to the atmosphere, use a TFSC with a properly operating water seal at the entrance or exit to the item to restrict ventilation in the collection system. The vent pipe shall be at least 90 cm in length and not exceeding 10.2 cm in nominal inside diameter. |
| Pipe                | Each pipe shall have no visible gaps in joints, seals, or other emission interfaces.   |
| Oil/Water separator | (a) Equip with a fixed roof and route vapors to a process or to a fuel gas system, or equip with a closed vent system that routes vapors to a control device meeting the requirements of §63.139(c); or<br>(b) Equip with a floating roof that meets the equipment specifications of §60.693 (a)(1)(i), (a)(1)(ii), (a)(2), (a)(3), and (a)(4).  |
| Tank <sup>c</sup>   | Maintain a fixed roof. <sup>d</sup> If the tank is sparged <sup>e</sup> or used for heating or treating by means of an exothermic reaction, a fixed roof and a system shall be maintained that routes the organic hazardous air pollutants vapors to other process equipment or a fuel gas system, or a closed vent system that routes vapors to a control device that meets the requirements of 40 CFR §63.119 (e)(1) or (e)(2).                |

<sup>a</sup>Where a tightly fitting solid cover is required, it shall be maintained with no visible gaps or openings, except during periods of sampling, inspection, or maintenance.

<sup>b</sup>Manhole includes sumps and other points of access to a conveyance system.

<sup>c</sup>Applies to tanks with capacities of 38 m<sup>3</sup> or greater.

<sup>d</sup>A fixed roof may have openings necessary for proper venting of the tank, such as pressure/vacuum vent, j-pipe vent.

<sup>e</sup>The liquid in the tank is agitated by injecting compressed air or gas.

**Table 36 to Subpart G of Part 63—Compound Lists Used for Compliance Demonstrations for Enhanced Biological Treatment Processes (See §63.145(h))**

| List 1              | List 2           |
|---------------------|------------------|
| Acetonitrile        | Acetaldehyde.    |
| Acetophenone        | Acrolein.        |
| Acrylonitrile       | Allyl Chloride.  |
| Biphenyl            | Benzene.         |
| Chlorobenzene       | Benzyl Chloride, |
| Dichloroethyl Ether | Bromoform.       |
| Diethyl Sulfate     | Bromomethane.    |



|  |   |
|--|---|
| Dimethyl Sulfate                         | Butadiene 1,3.                              |
| Dimethyl Hydrazine 1,1                   | Carbon Disulfide.                           |
| Dinitrophenol 2,4                        | Carbon Tetrachloride                        |
| Dinitrotoluene 2,4                       | Chloroethane (ethyl chloride).              |
| Dioxane 1,4                              | Chloroform.                                 |
| Ethylene Glycol Monobutyl Ether Acetate  | Chloroprene.                                |
| Ethylene Glycol Monomethyl Ether Acetate | Cumene (isopropylbenzene).                  |
| Ethylene Glycol Dimethyl Ether           | Dibromoethane 1,2.                          |
| Hexachlorobenzene                        | Dichlorobenzene 1,4.                        |
| Isophorone                               | Dichloroethane 1,2.                         |
| Methanol                                 | Dichloroethane 1,1 (ethylidene dichloride). |
| Methyl Methacrylate                      | Dichloroethene 1,1 (vinylidene chloride).   |
| Nitrobenzene                             | Dichloropropane 1,2.                        |
| Toluidine                                | Dichloropropene 1,3.                        |
| Trichlorobenzene 1,2,4.                  | Dimethylaniline N,N.                        |
| Trichlorophenol 2,4,6                    | Epichlorohydrin.                            |
| Triethylamine                            | Ethyl Acrylate.                             |
|  | Ethylbenzene.                               |
|  | Ethylene Oxide.                             |
|  | Ethylene Dibromide.                         |
|  | Hexachlorobutadiene.                        |
|  | Hexachloroethane.                           |
|  | Hexane-n.                                   |
|  | Methyl Isobutyl Ketone.                     |
|  | Methyl Tertiary Butyl Ether.                |
|  | Methyl Chloride.                            |
|  | Methylene Chloride (dichloromethane).       |
|  | Naphthalene.                                |
|  | Nitropropane 2                              |

|  |   |
|--|---|
|  | Phosgene.   |
|  | Propionaldehyde.                                  |
|  | Propylene Oxide.                                  |
|  | Styrene.  |
|  | Tetrachloroethane 1,1,2,2.                        |
|  | TolueneTrichloroethane 1,1,1 (methyl chloroform). |
|  | Trichloroethane 1,1,2.                            |
|  | Trichloroethylene.                                |
|  | Trimethylpentane 2,2,4.                           |
|  | Vinyl Chloride.                                   |
|  | Vinyl Acetate.                                    |
|  | Xylene-m.   |
|  | Xylene-o.   |
|  | Xylene-p.   |

[59 FR 19468, Apr. 22, 1994, as amended at 71 FR 76615, Dec. 21, 2006]

**Table 37 to Subpart G of Part 63—Default Biorates for List 1 Compounds**

| <b>Compound name</b>    | <b>Biorate, K1<br/>L/g MLVSS-hr</b> |
|-------------------------|-------------------------------------|
| Acetonitrile            | 0.100                               |
| Acetophenone            | 0.538                               |
| Acrylonitrile           | 0.750                               |
| Biphenyl                | 5.643                               |
| Chlorobenzene           | 10.000                              |
| Dichloroethyl ether     | 0.246                               |
| Diethyl sulfate         | 0.105                               |
| Dimethyl hydrazine(1,1) | 0.227                               |
| DIMethyl sulfate        | 0.178                               |
| Dinitrophenol 2,4       | 0.620                               |
| Dinitrotoluene(2,4)     | 0.784                               |
| Dioxane(1,4)            | 0.393                               |

|  |        |
|--|--------|
| Ethylene glycol dimethyl ether           | 0.364  |
| Ethylene glycol monomethyl ether acetate | 0.159  |
| Ethylene glycol monobutyl ether acetate  | 0.496  |
| Hexachlorobenzene                        | 16.179 |
| ISophorone                               | 0.598  |
| Methanol                                 | 0.200  |
| Methyl methacrylate                      | 4.300  |
| Nitrobenzene                             | 2.300  |
| Toluidine (-0)                           | 0.859  |
| Trichlorobenzene 1,2,4                   | 4.393  |
| Trichlorophenol 2,4,5                    | 4.477  |
| Triethylamine                            | 1.064  |

**Figure 1 to Subpart G of Part 63—Definitions of Terms Used in Wastewater Equations**

*Main Terms*

AMR = Actual mass removal of Table 8 and/or Table 9 compounds achieved by treatment process or a series of treatment processes, kg/hr.

C = Concentration of Table 8 and/or Table 9 compounds in wastewater, ppmw.

CG = Concentration of TOC (minus methane and ethane) or total organic hazardous air pollutants, in vented gas stream, dry basis, ppmv.

CG<sub>c</sub> = Concentration of TOC or organic hazardous air pollutants corrected to 3-percent oxygen, in vented gas stream, dry basis, ppmv.

CGS = Concentration of sample compounds in vented gas stream, dry basis, ppmv.

E = Removal or destruction efficiency, percent.

F<sub>bio</sub> = Site-specific fraction of Table 8 and/or Table 9 compounds biodegraded, unitless.

f<sup>bio</sup> = Site-specific fraction of an individual Table 8 or Table 9 compound biodegraded, unitless.

F<sub>m</sub> = Compound-specific fraction measured factor, unitless (listed in table 34).

Fr = Fraction removal value for Table 8 and/or Table 9 compounds, unitless (listed in Table 9).

Fr<sub>avg</sub> = Flow-weighted average of the Fr values.

i = Identifier for a compound.

j = Identifier for a sample.

k = Identifier for a run.

$K_2$  = Constant,  $41.57 * 10^{-9}$ , (ppm)<sup>-1</sup> (gram-mole per standard m<sup>3</sup>) (kg/g), where standard temperature (gram-mole per standard m<sup>3</sup>) is 20 °C.

m = Number of samples.

M = Mass, kg.

MW = Molecular weight, kg/kg-mole.

n = Number of compounds.

p = Number of runs.

%O<sub>2d</sub> = Concentration of oxygen, dry basis, percent by volume.

Q = Volumetric flowrate of wastewater, m<sup>3</sup>/hr.

QG = Volumetric flow rate of vented gas stream, dry standard, m<sup>3</sup>/min.

QMG = Mass flowrate of TOC (minus methane and ethane) or organic hazardous air pollutants, in vented gas stream, kg/hr.

QMW = Mass flowrate of Table 8 and/or Table 9 compounds in wastewater, kg/hr.

ρ = Density, kg/m<sup>3</sup>.

RMR = Required mass removal achieved by treatment process or a series of treatment processes, kg/hr.

t<sub>r</sub> = Total time of all runs, hr.

#### Subscripts

a = Entering.

b = Exiting.

i = Identifier for a compound.

j = Identifier for a sample.

k = Identifier for a run.

m = Number of samples.

n = Number of compounds.

p = Number of runs.

T = Total; sum of individual.

[59 FR 19468, Apr. 22, 1994, as amended at 59 FR 29201, June 6, 1994; 61 FR 63629, Dec. 12, 1995; 62 FR 2779, Jan. 17, 1997; 63 FR 67793, Dec. 9, 1998; 64 FR 20195, Apr. 26, 1999; 65 FR 78284, Dec. 14, 2000; 66 FR 6935, Jan. 22, 2001]

**Appendix E**  
40 C.F.R. Part 63, Subpart H – *National Emission Standards for Organic Hazardous Air  
Pollutants for Equipment Leaks*

## Subpart H—National Emission Standards for Organic Hazardous Air Pollutants for Equipment Leaks

SOURCE: 59 FR 19568, Apr. 22, 1994, unless otherwise noted.

### §63.160 Applicability and designation of source.

(a) The provisions of this subpart apply to pumps, compressors, agitators, pressure relief devices, sampling connection systems, open-ended valves or lines, valves, connectors, surge control vessels, bottoms receivers, instrumentation systems, and control devices or closed vent systems required by this subpart that are intended to operate in organic hazardous air pollutant service 300 hours or more during the calendar year within a source subject to the provisions of a specific subpart in 40 CFR part 63 that references this subpart.

(b) After the compliance date for a process unit, equipment to which this subpart applies that are also subject to the provisions of:

(1) 40 CFR part 60 will be required to comply only with the provisions of this subpart.

(2) 40 CFR part 61 will be required to comply only with the provisions of this subpart.

(c) If a process unit subject to the provisions of this subpart has equipment to which this subpart does not apply, but which is subject to a standard identified in paragraph (c)(1), (c)(2), or (c)(3) of this section, the owner or operator may elect to apply this subpart to all such equipment in the process unit. If the owner or operator elects this method of compliance, all VOC in such equipment shall be considered, for purposes of applicability and compliance with this subpart, as if it were organic hazardous air pollutant (HAP). Compliance with the provisions of this subpart, in the manner described in this paragraph, shall be deemed to constitute compliance with the standard identified in paragraph (c)(1), (c)(2), or (c)(3) of this section.

(1) 40 CFR part 60, subpart VV, GGG, or KKK; (2) 40 CFR part 61, subpart F or J; or (3) 40 CFR part 264, subpart BB or 40 CFR part 265, subpart BB.

(2) [Reserved]

(d) The provisions in §63.1(a)(3) of subpart A of this part do not alter the provisions in paragraph (b) of this section.

(e) Except as provided in any subpart that references this subpart, lines and equipment not containing process fluids are not subject to the provisions of this subpart. Utilities, and other non-process lines, such as heating and cooling systems which do not combine their materials with those in the processes they serve, are not considered to be part of a process unit.

(f) The provisions of this subpart do not apply to research and development facilities or to bench-scale batch processes, regardless of whether the facilities or processes are located at the same plant site as a process subject to the provisions of this subpart.

(g) *Alternative means of compliance*—(1) *Option to comply with part 65*. Owners or operators of CMPU that are subject to §63.100 may choose to comply with the provisions of 40 CFR part 65 for all

Group 1 and Group 2 process vents, Group 1 storage vessels, Group 1 transfer operations, and equipment that are subject to §63.100, that are part of the CMPU. Other provisions applying to an owner or operator who chooses to comply with 40 CFR part 65 are provided in 40 CFR 65.1.

(i) For equipment, 40 CFR part 65 satisfies the requirements of §§63.102, 63.103, and 63.162 through 63.182. When choosing to comply with 40 CFR part 65, the requirements of §63.180(d) continue to apply.

(ii) For Group 1 and Group 2 process vents, Group 1 storage vessels, and Group 1 transfer operations, comply with §63.110(i)(1).

(2) *Part 65, subpart C or F.* For owners or operators choosing to comply with 40 CFR part 65, each surge control vessel and bottoms receiver subject to §63.100 that meets the conditions specified in table 2 or table 3 of this subpart shall meet the requirements for storage vessels in 40 CFR part 65, subpart C; all other equipment subject to §63.100 shall meet the requirements in 40 CFR part 65, subpart F.

(3) *Part 63, subpart A.* Owners or operators who choose to comply with 40 CFR part 65, subpart C or F, for equipment subject to §63.100 must also comply with the applicable general provisions of this part 63 listed in table 4 of this subpart. All sections and paragraphs of subpart A of this part that are not mentioned in table 4 of this subpart do not apply to owners or operators of equipment subject to §63.100 of subpart F complying with 40 CFR part 65, subpart C or F, except that provisions required to be met prior to implementing 40 CFR part 65 still apply. Owners and operators who choose to comply with 40 CFR part 65, subpart C or F, must comply with 40 CFR part 65, subpart A.

[59 FR 19568, Apr. 22, 1994, as amended at 59 FR 48176, Sept. 20, 1994; 59 FR 53360, Oct. 24, 1994; 60 FR 18029, Apr. 10, 1995; 61 FR 31439, June 20, 1996; 64 FR 20198, Apr. 26, 1999; 65 FR 78285, Dec. 14, 2000]

### **§63.161 Definitions.**

All terms used in this subpart shall have the meaning given them in the Act and in this section as follows, except as provided in any subpart that references this subpart.

*Batch process* means a process in which the equipment is fed intermittently or discontinuously. Processing then occurs in this equipment after which the equipment is generally emptied. Examples of industries that use batch processes include pharmaceutical production and pesticide production.

*Batch product-process equipment train* means the collection of equipment (e.g., connectors, reactors, valves, pumps, etc.) configured to produce a specific product or intermediate by a batch process.

*Bench-scale batch process* means a batch process (other than a research and development facility) that is operated on a small scale, such as one capable of being located on a laboratory bench top. This bench-scale equipment will typically include reagent feed vessels, a small reactor and associated product separator, recovery and holding equipment. These processes are only capable of producing small quantities of product.

*Bottoms receiver* means a tank that collects distillation bottoms before the stream is sent for storage or for further downstream processing.

*Closed-loop system* means an enclosed system that returns process fluid to the process and is not vented to the atmosphere except through a closed-vent system.

*Closed-purge system* means a system or combination of system and portable containers, to capture

purged liquids. Containers must be covered or closed when not being filled or emptied.

*Closed-vent system* means a system that is not open to the atmosphere and that is composed of hard-piping, ductwork, connections and, if necessary, flow-inducing devices that transport gas or vapor from a piece or pieces of equipment to a control device or back into a process.

*Combustion device* means an individual unit of equipment, such as a flare, incinerator, process heater, or boiler, used for the combustion of organic hazardous air pollutant emissions.

*Compliance date* means the dates specified in §63.100(k) or §63.100(l)(3) of subpart F of this part for process units subject to subpart F of this part; the dates specified in §63.190(e) of subpart I of this part for process units subject to subpart I of this part. For sources subject to other subparts in 40 CFR part 63 that reference this subpart, compliance date will be defined in those subparts. However, the compliance date for §63.170 shall be no later than 3 years after the effective date of those subparts unless otherwise specified in such other subparts.

*Connector* means flanged, screwed, or other joined fittings used to connect two pipe lines or a pipe line and a piece of equipment. A common connector is a flange. Joined fittings welded completely around the circumference of the interface are not considered connectors for the purpose of this regulation. For the purpose of reporting and recordkeeping, connector means joined fittings that are not inaccessible, glass, or glass-lined as described in §63.174(h) of this subpart.

*Control device* means any equipment used for recovering, recapturing, or oxidizing organic hazardous air pollutant vapors. Such equipment includes, but is not limited to, absorbers, carbon adsorbers, condensers, flares, boilers, and process heaters.

*Double block and bleed system* means two block valves connected in series with a bleed valve or line that can vent the line between the two block valves.

*Duct work* means a conveyance system such as those commonly used for heating and ventilation systems. It is often made of sheet metal and often has sections connected by screws or crimping. Hard-piping is not ductwork.

*Equipment* means each pump, compressor, agitator, pressure relief device, sampling connection system, open-ended valve or line, valve, connector, surge control vessel, bottoms receiver, and instrumentation system in organic hazardous air pollutant service; and any control devices or systems required by this subpart.

*First attempt at repair* means to take action for the purpose of stopping or reducing leakage of organic material to the atmosphere, followed by monitoring as specified in §63.180 (b) and (c), as appropriate, to verify whether the leak is repaired, unless the owner or operator determines by other means that the leak is not repaired.

*Flow indicator* means a device which indicates whether gas flow is, or whether the valve position would allow gas flow to be, present in a line.

*Fuel gas* means gases that are combusted to derive useful work or heat.

*Fuel gas system* means the offsite and onsite piping and control system that gathers gaseous stream(s) generated by onsite operations, may blend them with other sources of gas, and transports the gaseous stream for use as fuel gas in combustion devices or in in-process combustion equipment such as furnaces and gas turbines, either singly or in combination.



*Hard-piping* means pipe or tubing that is manufactured and properly installed using good engineering judgement and standards, such as ANSI B31-3.

*In food/medical service* means that a piece of equipment in organic hazardous air pollutant service contacts a process stream used to manufacture a Food and Drug Administration regulated product where leakage of a barrier fluid into the process stream would cause any of the following:

- (1) A dilution of product quality so that the product would not meet written specifications,
- (2) An exothermic reaction which is a safety hazard,
- (3) The intended reaction to be slowed down or stopped, or
- (4) An undesired side reaction to occur.

*In gas/vapor service* means that a piece of equipment in organic hazardous air pollutant service contains a gas or vapor at operating conditions.

*In heavy liquid service* means that a piece of equipment in organic hazardous air pollutant service is not in gas/vapor service or in light liquid service.

*In light liquid service* means that a piece of equipment in organic hazardous air pollutant service contains a liquid that meets the following conditions:

- (1) The vapor pressure of one or more of the organic compounds is greater than 0.3 kilopascals at 20 °C,
- (2) The total concentration of the pure organic compounds constituents having a vapor pressure greater than 0.3 kilopascals at 20 °C is equal to or greater than 20 percent by weight of the total process stream, and
- (3) The fluid is a liquid at operating conditions.

NOTE: Vapor pressures may be determined by the methods described in 40 CFR 60.485(e)(1).

*In liquid service* means that a piece of equipment in organic hazardous air pollutant service is not in gas/vapor service.

*In organic hazardous air pollutant or in organic HAP service* means that a piece of equipment either contains or contacts a fluid (liquid or gas) that is at least 5 percent by weight of total organic HAP's as determined according to the provisions of §63.180(d) of this subpart. The provisions of §63.180(d) of this subpart also specify how to determine that a piece of equipment is not in organic HAP service.

*In vacuum service* means that equipment is operating at an internal pressure which is at least 5 kilopascals below ambient pressure.

*In volatile organic compound or in VOC service* means, for the purposes of this subpart, that:

- (1) The piece of equipment contains or contacts a process fluid that is at least 10 percent VOC by weight (see 40 CFR 60.2 for the definition of VOC, and 40 CFR 60.485(d) to determine whether a piece of equipment is not in VOC service); and

(2) The piece of equipment is not in heavy liquid service as defined in 40 CFR 60.481.

*In-situ sampling systems* means nonextractive samplers or in-line samplers.

*Initial start-up* means the first time a new or reconstructed source begins production. Initial start-up does not include operation solely for testing equipment. Initial start-up does not include subsequent start-ups (as defined in this section) of process units following malfunctions or process unit shutdowns.

*Instrumentation system* means a group of equipment components used to condition and convey a sample of the process fluid to analyzers and instruments for the purpose of determining process operating conditions (e.g., composition, pressure, flow, etc.). Valves and connectors are the predominant type of equipment used in instrumentation systems; however, other types of equipment may also be included in these systems. Only valves nominally 0.5 inches and smaller, and connectors nominally 0.75 inches and smaller in diameter are considered instrumentation systems for the purposes of this subpart. Valves greater than nominally 0.5 inches and connectors greater than nominally 0.75 inches associated with instrumentation systems are not considered part of instrumentation systems and must be monitored individually.

*Liquids dripping* means any visible leakage from the seal including dripping, spraying, misting, clouding, and ice formation. Indications of liquid dripping include puddling or new stains that are indicative of an existing evaporated drip.

*Nonrepairable* means that it is technically infeasible to repair a piece of equipment from which a leak has been detected without a process unit shutdown.

*On-site or On site* means, with respect to records required to be maintained by this subpart, that the records are stored at a location within a major source which encompasses the affected source. On-site includes, but is not limited to, storage at the chemical manufacturing process unit to which the records pertain, or storage in central files elsewhere at the major source.

*Open-ended valve or line* means any valve, except pressure relief valves, having one side of the valve seat in contact with process fluid and one side open to atmosphere, either directly or through open piping.

*Plant site* means all contiguous or adjoining property that is under common control, including properties that are separated only by a road or other public right-of-way. Common control includes properties that are owned, leased, or operated by the same entity, parent entity, subsidiary, or any combination thereof.

*Polymerizing monomer* means a molecule or compound usually containing carbon and of relatively low molecular weight and simple structure (e.g., hydrogen cyanide, acrylonitrile, styrene), which is capable of conversion to polymers, synthetic resins, or elastomers by combination with itself due to heat generation caused by a pump mechanical seal surface, contamination by a seal fluid (e.g., organic peroxides or chemicals that will form organic peroxides), or a combination of both with the resultant polymer buildup causing rapid mechanical seal failure.

*Pressure release* means the emission of materials resulting from the system pressure being greater than the set pressure of the pressure relief device. This release can be one release or a series of releases over a short time period due to a malfunction in the process.

*Pressure relief device or valve* means a safety device used to prevent operating pressures from exceeding the maximum allowable working pressure of the process equipment. A common pressure relief device is a spring-loaded pressure relief valve. Devices that are actuated either by a pressure of less than

or equal to 2.5 psig or by a vacuum are not pressure relief devices.

*Process unit* means a chemical manufacturing process unit as defined in subpart F of this part, a process subject to the provisions of subpart I of this part, or a process subject to another subpart in 40 CFR part 63 that references this subpart.

*Process unit shutdown* means a work practice or operational procedure that stops production from a process unit or part of a process unit during which it is technically feasible to clear process material from a process unit or part of a process unit consistent with safety constraints and during which repairs can be effected. An unscheduled work practice or operational procedure that stops production from a process unit or part of a process unit for less than 24 hours is not a process unit shutdown. An unscheduled work practice or operational procedure that would stop production from a process unit or part of a process unit for a shorter period of time than would be required to clear the process unit or part of the process unit of materials and start up the unit, and would result in greater emissions than delay of repair of leaking components until the next scheduled process unit shutdown, is not a process unit shutdown. The use of spare equipment and technically feasible bypassing of equipment without stopping production are not process unit shutdowns.

*Recapture device* means an individual unit of equipment capable of and used for the purpose of recovering chemicals, but not normally for use, reuse, or sale. Recapture devices include, but are not limited to, absorbers, carbon absorbers, and condensers.

*Recovery device* means an individual unit of equipment capable of and normally used for the purpose of recovering chemicals for fuel value (i.e., net positive heating value), use, reuse, or for sale for fuel value, use or reuse. Recovery devices include, but are not limited to, absorbers, carbon absorbers, and condensers. For purposes of the monitoring, recordkeeping, and reporting requirements of this subpart, recapture devices are considered recovery devices.

*Repaired* means that equipment:

(1) Is adjusted, or otherwise altered, to eliminate a leak as defined in the applicable sections of this subpart, and

(2) Unless otherwise specified in applicable provisions of this subpart, is monitored as specified in §63.180 (b) and (c), as appropriate, to verify that emissions from the equipment are below the applicable leak definition.

*Routed to a process or route to a process* means the emissions are conveyed by hard-piping or a closed vent system to any enclosed portion of a process unit where the emissions are predominately recycled and/or consumed in the same manner as a material that fulfills the same function in the process; and/or transformed by chemical reaction into materials that are not organic hazardous air pollutants; and/or incorporated into a product; and/or recovered.

*Sampling connection system* means an assembly of equipment within a process unit used during periods of representative operation to take samples of the process fluid. Equipment used to take non-routine grab samples is not considered a sampling connection system.

*Screwed connector* means a threaded pipe fitting where the threads are cut on the pipe wall and the fitting requires only two pieces to make the connection (i.e., the pipe and the fitting).

*Sensor* means a device that measures a physical quantity or the change in a physical quantity, such as temperature, pressure, flow rate, pH, or liquid level.

*Set pressure* means the pressure at which a properly operating pressure relief device begins to open to relieve atypical process system operating pressure.

*Start-up* means the setting in operation of a piece of equipment or a control device that is subject to this subpart.

*Surge control vessel* means feed drums, recycle drums, and intermediate vessels. Surge control vessels are used within a process unit (as defined in the specific subpart that references this subpart) when in-process storage, mixing, or management of flow rates or volumes is needed to assist in production of a product.

[59 FR 19568, Apr. 22, 1994, as amended at 59 FR 48176, Sept. 20, 1994; 60 FR 18024, 18029, Apr. 10, 1995; 61 FR 31439, June 20, 1996; 62 FR 2788, Jan. 17, 1997]

### **§63.162 Standards: General.**

(a) Compliance with this subpart will be determined by review of the records required by §63.181 of this subpart and the reports required by §63.182 of this subpart, review of performance test results, and by inspections.

(b)(1) An owner or operator may request a determination of alternative means of emission limitation to the requirements of §§63.163 through 63.170, and §§63.172 through 63.174 of this subpart as provided in §63.177.

(2) If the Administrator makes a determination that a means of emission limitation is a permissible alternative to the requirements of §§63.163 through 63.170, and §§63.172 through 63.174 of this subpart, the owner or operator shall comply with the alternative.

(c) Each piece of equipment in a process unit to which this subpart applies shall be identified such that it can be distinguished readily from equipment that is not subject to this subpart. Identification of the equipment does not require physical tagging of the equipment. For example, the equipment may be identified on a plant site plan, in log entries, or by designation of process unit boundaries by some form of weatherproof identification.

(d) Equipment that is in vacuum service is excluded from the requirements of this subpart.

(e) Equipment that is in organic HAP service less than 300 hours per calendar year is excluded from the requirements of §§63.163 through 63.174 of this subpart and §63.178 of this subpart if it is identified as required in §63.181(j) of this subpart.

(f) When each leak is detected as specified in §§63.163 and 63.164; §§63.168 and 63.169; and §§63.172 through 63.174 of this subpart, the following requirements apply:

(1) Clearly identify the leaking equipment.

(2) The identification on a valve may be removed after it has been monitored as specified in §§63.168(f)(3), and 63.175(e)(7)(i)(D) of this subpart, and no leak has been detected during the follow-up monitoring. If the owner or operator elects to comply using the provisions of §63.174(c)(1)(i) of this subpart, the identification on a connector may be removed after it is monitored as specified in §63.174(c)(1)(i) and no leak is detected during that monitoring.

(3) The identification which has been placed on equipment determined to have a leak, except for a valve or for a connector that is subject to the provisions of §63.174(c)(1)(i), may be removed after it is

repaired.

(g) Except as provided in paragraph (g)(1) of this section, all terms in this subpart that define a period of time for completion of required tasks (e.g., weekly, monthly, quarterly, annual), refer to the standard calendar periods unless specified otherwise in the section or subsection that imposes the requirement.

(1) If the initial compliance date does not coincide with the beginning of the standard calendar period, an owner or operator may elect to utilize a period beginning on the compliance date, or may elect to comply in accordance with the provisions of paragraphs (g)(2) or (g)(3) of this section.

(2) Time periods specified in this subpart for completion of required tasks may be changed by mutual agreement between the owner or operator and the Administrator, as specified in subpart A of this part. For each time period that is changed by agreement, the revised period shall remain in effect until it is changed. A new request is not necessary for each recurring period.

(3) Except as provided in paragraph (g)(1) or (g)(2) of this section, where the period specified for compliance is a standard calendar period, if the initial compliance date does not coincide with the beginning of the calendar period, compliance shall be required according to the schedule specified in paragraphs (g)(3)(i) or (g)(3)(ii) of this section, as appropriate.

(i) Compliance shall be required before the end of the standard calendar period within which the compliance deadline occurs, if there remain at least 3 days for tasks that must be performed weekly, at least 2 weeks for tasks that must be performed monthly, at least 1 month for tasks that must be performed each quarter, or at least 3 months for tasks that must be performed annually; or

(ii) In all other cases, compliance shall be required before the end of the first full standard calendar period after the period within which the initial compliance deadline occurs.

(4) In all instances where a provision of this subpart requires completion of a task during each of multiple successive periods, an owner or operator may perform the required task at any time during each period, provided the task is conducted at a reasonable interval after completion of the task during the previous period.

(h) In all cases where the provisions of this subpart require an owner or operator to repair leaks by a specified time after the leak is detected, it is a violation of this subpart to fail to take action to repair the leaks within the specified time. If action is taken to repair the leaks within the specified time, failure of that action to successfully repair the leak is not a violation of this subpart. However, if the repairs are unsuccessful, a leak is detected and the owner or operator shall take further action as required by applicable provisions of this subpart.

[59 FR 19568, Apr. 22, 1994, as amended at 59 FR 48176, Sept. 20, 1994; 62 FR 2789, Jan. 17, 1997; 68 FR 37345, June 23, 2003]

### **§63.163 Standards: Pumps in light liquid service.**

(a) The provisions of this section apply to each pump that is in light liquid service.

(1) The provisions are to be implemented on the dates specified in the specific subpart in 40 CFR part 63 that references this subpart in the phases specified below:

(i) For each group of existing process units at existing sources subject to the provisions of subparts F or I of this part, the phases of the standard are:

- (A) Phase I, beginning on the compliance date;
- (B) Phase II, beginning no later than 1 year after the compliance date; and
- (C) Phase III, beginning no later than 2½ years after the compliance date.

(ii) For new sources subject to the provisions of subparts F or I of this part, the applicable phases of the standard are:

- (A) After initial start-up, comply with the Phase II requirements; and
- (B) Beginning no later than 1 year after initial start-up, comply with the Phase III requirements.

(2) The owner or operator of a source subject to the provisions of subparts F or I of this part may elect to meet the requirements of a later phase during the time period specified for an earlier phase.

(3) Sources subject to other subparts in 40 CFR part 63 that reference this subpart shall comply on the dates specified in the applicable subpart.

(b)(1) The owner or operator of a process unit subject to this subpart shall monitor each pump monthly to detect leaks by the method specified in §63.180(b) of this subpart and shall comply with the requirements of paragraphs (a) through (d) of this section, except as provided in §63.162(b) of this subpart and paragraphs (e) through (j) of this section.

(2) The instrument reading, as determined by the method as specified in §63.180(b) of this subpart, that defines a leak in each phase of the standard is:

- (i) For Phase I, an instrument reading of 10,000 parts per million or greater.
- (ii) For Phase II, an instrument reading of 5,000 parts per million or greater.
- (iii) For Phase III, an instrument reading of:

- (A) 5,000 parts per million or greater for pumps handling polymerizing monomers;
- (B) 2,000 parts per million or greater for pumps in food/medical service; and
- (C) 1,000 parts per million or greater for all other pumps.

(3) Each pump shall be checked by visual inspection each calendar week for indications of liquids dripping from the pump seal. If there are indications of liquids dripping from the pump seal, a leak is detected.

(c)(1) When a leak is detected, it shall be repaired as soon as practicable, but not later than 15 calendar days after it is detected, except as provided in paragraph (c)(3) of this section or §63.171 of this subpart.

(2) A first attempt at repair shall be made no later than 5 calendar days after the leak is detected. First attempts at repair include, but are not limited to, the following practices where practicable:

- (i) Tightening of packing gland nuts.

(ii) Ensuring that the seal flush is operating at design pressure and temperature.

(3) For pumps in Phase III to which a 1,000 parts per million leak definition applies, repair is not required unless an instrument reading of 2,000 parts per million or greater is detected.

(d)(1) The owner or operator shall decide no later than the first monitoring period whether to calculate percent leaking pumps on a process unit basis or on a source-wide basis. Once the owner or operator has decided, all subsequent percent calculations shall be made on the same basis.

(2) If, in Phase III, calculated on a 6-month rolling average, the greater of either 10 percent of the pumps in a process unit or three pumps in a process unit leak, the owner or operator shall implement a quality improvement program for pumps that complies with the requirements of §63.176 of this subpart.

(3) The number of pumps at a process unit shall be the sum of all the pumps in organic HAP service, except that pumps found leaking in a continuous process unit within 1 month after start-up of the pump shall not count in the percent leaking pumps calculation for that one monitoring period only.

(4) Percent leaking pumps shall be determined by the following equation:

$$\%P_L = ((P_L - P_s) / (P_T - P_s)) \times 100$$

where:

$\%P_L$  = Percent leaking pumps

$P_L$  = Number of pumps found leaking as determined through monthly monitoring as required in paragraphs (b)(1) and (b)(2) of this section.

$P_T$  = Total pumps in organic HAP service, including those meeting the criteria in paragraphs (e) and (f) of this section.

$P_s$  = Number of pumps leaking within 1 month of start-up during the current monitoring period.

(e) Each pump equipped with a dual mechanical seal system that includes a barrier fluid system is exempt from the requirements of paragraphs (a) through (d) of this section, provided the following requirements are met:

(1) Each dual mechanical seal system is:

(i) Operated with the barrier fluid at a pressure that is at all times greater than the pump stuffing box pressure; or

(ii) Equipped with a barrier fluid degassing reservoir that is routed to a process or fuel gas system or connected by a closed-vent system to a control device that complies with the requirements of §63.172 of this subpart; or

(iii) Equipped with a closed-loop system that purges the barrier fluid into a process stream.

(2) The barrier fluid is not in light liquid service.

(3) Each barrier fluid system is equipped with a sensor that will detect failure of the seal system, the barrier fluid system, or both.

(4) Each pump is checked by visual inspection each calendar week for indications of liquids dripping

from the pump seal.

(i) If there are indications of liquids dripping from the pump seal at the time of the weekly inspection, the pump shall be monitored as specified in §63.180(b) of this subpart to determine if there is a leak of organic HAP in the barrier fluid.

(ii) If an instrument reading of 1,000 parts per million or greater is measured, a leak is detected.

(5) Each sensor as described in paragraph (e)(3) of this section is observed daily or is equipped with an alarm unless the pump is located within the boundary of an unmanned plant site.

(6)(i) The owner or operator determines, based on design considerations and operating experience, criteria applicable to the presence and frequency of drips and to the sensor that indicates failure of the seal system, the barrier fluid system, or both.

(ii) If indications of liquids dripping from the pump seal exceed the criteria established in paragraph (e)(6)(i) of this section, or if, based on the criteria established in paragraph (e)(6)(i) of this section, the sensor indicates failure of the seal system, the barrier fluid system, or both, a leak is detected.

(iii) When a leak is detected, it shall be repaired as soon as practicable, but not later than 15 calendar days after it is detected, except as provided in §63.171 of this subpart.

(iv) A first attempt at repair shall be made no later than 5 calendar days after each leak is detected.

(f) Any pump that is designed with no externally actuated shaft penetrating the pump housing is exempt from the requirements of paragraphs (a) through (c) of this section.

(g) Any pump equipped with a closed-vent system capable of capturing and transporting any leakage from the seal or seals to a process or to a fuel gas system or to a control device that complies with the requirements of §63.172 of this subpart is exempt from the requirements of paragraphs (b) through (e) of this section.

(h) Any pump that is located within the boundary of an unmanned plant site is exempt from the weekly visual inspection requirement of paragraphs (b)(3) and (e)(4) of this section, and the daily requirements of paragraph (e)(5) of this section, provided that each pump is visually inspected as often as practicable and at least monthly.

(i) If more than 90 percent of the pumps at a process unit meet the criteria in either paragraph (e) or (f) of this section, the process unit is exempt from the requirements of paragraph (d) of this section.

(j) Any pump that is designated, as described in §63.181(b)(7)(i) of this subpart, as an unsafe-to-monitor pump is exempt from the requirements of paragraphs (b) through (e) of this section if:

(1) The owner or operator of the pump determines that the pump is unsafe to monitor because monitoring personnel would be exposed to an immediate danger as a consequence of complying with paragraphs (b) through (d) of this section; and

(2) The owner or operator of the pump has a written plan that requires monitoring of the pump as frequently as practical during safe-to-monitor times, but not more frequently than the periodic monitoring schedule otherwise applicable.



**§63.164 Standards: Compressors.**

(a) Each compressor shall be equipped with a seal system that includes a barrier fluid system and that prevents leakage of process fluid to the atmosphere, except as provided in §63.162(b) of this subpart and paragraphs (h) and (i) of this section.

(b) Each compressor seal system as required in paragraph (a) of this section shall be:

(1) Operated with the barrier fluid at a pressure that is greater than the compressor stuffing box pressure; or

(2) Equipped with a barrier fluid system degassing reservoir that is routed to a process or fuel gas system or connected by a closed-vent system to a control device that complies with the requirements of §63.172 of this subpart; or

(3) Equipped with a closed-loop system that purges the barrier fluid directly into a process stream.

(c) The barrier fluid shall not be in light liquid service.

(d) Each barrier fluid system as described in paragraphs (a) through (c) of this section shall be equipped with a sensor that will detect failure of the seal system, barrier fluid system, or both.

(e)(1) Each sensor as required in paragraph (d) of this section shall be observed daily or shall be equipped with an alarm unless the compressor is located within the boundary of an unmanned plant site.

(2) The owner or operator shall determine, based on design considerations and operating experience, a criterion that indicates failure of the seal system, the barrier fluid system, or both.

(f) If the sensor indicates failure of the seal system, the barrier fluid system, or both based on the criterion determined under paragraph (e)(2) of this section, a leak is detected.

(g)(1) When a leak is detected, it shall be repaired as soon as practicable, but not later than 15 calendar days after it is detected, except as provided in §63.171 of this subpart.

(2) A first attempt at repair shall be made no later than 5 calendar days after each leak is detected.

(h) A compressor is exempt from the requirements of paragraphs (a) through (g) of this section if it is equipped with a closed-vent system to capture and transport leakage from the compressor drive shaft seal back to a process or a fuel gas system or to a control device that complies with the requirements of §63.172 of this subpart.

(i) Any compressor that is designated, as described in §63.181(b)(2)(ii) of this subpart, to operate with an instrument reading of less than 500 parts per million above background, is exempt from the requirements of paragraphs (a) through (h) of this section if the compressor:

(1) Is demonstrated to be operating with an instrument reading of less than 500 parts per million above background, as measured by the method specified in §63.180(c) of this subpart; and

(2) Is tested for compliance with paragraph (i)(1) of this section initially upon designation, annually, and at other times requested by the Administrator.

[59 FR 19568, Apr. 22, 1994, as amended at 59 FR 48176, Sept. 20, 1994; 62 FR 2790, Jan. 17, 1997; 64 FR 20198, Apr. 26, 1999]

**§63.165 Standards: Pressure relief devices in gas/vapor service.**

(a) Except during pressure releases, each pressure relief device in gas/vapor service shall be operated with an instrument reading of less than 500 parts per million above background except as provided in paragraph (b) of this section, as measured by the method specified in §63.180(c) of this subpart.

(b)(1) After each pressure release, the pressure relief device shall be returned to a condition indicated by an instrument reading of less than 500 parts per million above background, as soon as practicable, but no later than 5 calendar days after each pressure release, except as provided in §63.171 of this subpart.

(2) No later than 5 calendar days after the pressure release and being returned to organic HAP service, the pressure relief device shall be monitored to confirm the condition indicated by an instrument reading of less than 500 parts per million above background, as measured by the method specified in §63.180(c) of this subpart.

(c) Any pressure relief device that is routed to a process or fuel gas system or equipped with a closed-vent system capable of capturing and transporting leakage from the pressure relief device to a control device as described in §63.172 of this subpart is exempt from the requirements of paragraphs (a) and (b) of this section.

(d)(1) Any pressure relief device that is equipped with a rupture disk upstream of the pressure relief device is exempt from the requirements of paragraphs (a) and (b) of this section, provided the owner or operator complies with the requirements in paragraph (d)(2) of this section.

(2) After each pressure release, a rupture disk shall be installed upstream of the pressure relief device as soon as practicable, but no later than 5 calendar days after each pressure release, except as provided in §63.171 of this subpart.

[59 FR 19568, Apr. 22, 1994, as amended at 59 FR 48176, Sept. 20, 1994; 62 FR 2790, Jan. 17, 1997]

**§63.166 Standards: Sampling connection systems.**

(a) Each sampling connection system shall be equipped with a closed-purge, closed-loop, or closed-vent system, except as provided in §63.162(b) of this subpart. Gases displaced during filling of the sample container are not required to be collected or captured.

(b) Each closed-purge, closed-loop, or closed-vent system as required in paragraph (a) of this section shall:

(1) Return the purged process fluid directly to the process line; or

(2) Collect and recycle the purged process fluid to a process; or

(3) Be designed and operated to capture and transport the purged process fluid to a control device that complies with the requirements of §63.172 of this subpart; or

(4) Collect, store, and transport the purged process fluid to a system or facility identified in

paragraph (b)(4)(i), (ii), or (iii) of this section.

(i) A waste management unit as defined in §63.111 of subpart G of this part, if the waste management unit is subject to, and operated in compliance with the provisions of subpart G of this part applicable to group 1 wastewater streams. If the purged process fluid does not contain any organic HAP listed in Table 9 of subpart G of part 63, the waste management unit need not be subject to, and operated in compliance with the requirements of 40 CFR part 63, subpart G applicable to group 1 wastewater streams provided the facility has an NPDES permit or sends the wastewater to an NPDES permitted facility.

(ii) A treatment, storage, or disposal facility subject to regulation under 40 CFR part 262, 264, 265, or 266; or

(iii) A facility permitted, licensed, or registered by a State to manage municipal or industrial solid waste, if the process fluids are not hazardous waste as defined in 40 CFR part 261.

(c) *In-situ* sampling systems and sampling systems without purges are exempt from the requirements of paragraphs (a) and (b) of this section.

[59 FR 19568, Apr. 22, 1994, as amended at 61 FR 31439, June 20, 1996]

#### **§63.167 Standards: Open-ended valves or lines.**

(a)(1) Each open-ended valve or line shall be equipped with a cap, blind flange, plug, or a second valve, except as provided in §63.162(b) of this subpart and paragraphs (d) and (e) of this section.

(2) The cap, blind flange, plug, or second valve shall seal the open end at all times except during operations requiring process fluid flow through the open-ended valve or line, or during maintenance or repair.

(b) Each open-ended valve or line equipped with a second valve shall be operated in a manner such that the valve on the process fluid end is closed before the second valve is closed.

(c) When a double block and bleed system is being used, the bleed valve or line may remain open during operations that require venting the line between the block valves but shall comply with paragraph (a) of this section at all other times.

(d) Open-ended valves or lines in an emergency shutdown system which are designed to open automatically in the event of a process upset are exempt from the requirements of paragraphs (a), (b) and (c) of this section.

(e) Open-ended valves or lines containing materials which would autocatalytically polymerize or, would present an explosion, serious overpressure, or other safety hazard if capped or equipped with a double block and bleed system as specified in paragraphs (a) through (c) of this section are exempt from the requirements of paragraph (a) through (c) of this section.

[59 FR 19568, Apr. 22, 1994, as amended at 61 FR 31440, June 20, 1996]

#### **§63.168 Standards: Valves in gas/vapor service and in light liquid service.**

(a) The provisions of this section apply to valves that are either in gas service or in light liquid service.

(1) The provisions are to be implemented on the dates set forth in the specific subpart in 40 CFR part 63 that references this subpart as specified in paragraph (a)(1)(i), (a)(1)(ii), or (a)(1)(iii) of this section.

(i) For each group of existing process units at existing sources subject to the provisions of subpart F or I of this part, the phases of the standard are:

- (A) Phase I, beginning on the compliance date;
- (B) Phase II, beginning no later than 1 year after the compliance date; and
- (C) Phase III, beginning no later than 2½ years after the compliance date.

(ii) For new sources subject to the provisions of subpart F or I of this part, the applicable phases of the standard are:

- (A) After initial start-up, comply with the Phase II requirements; and
- (B) Beginning no later than 1 year after initial start-up, comply with the Phase III requirements.

(iii) Sources subject to other subparts in 40 CFR part 63 that reference this subpart shall comply on the dates specified in the applicable subpart.

(2) The owner or operator of a source subject to this subpart may elect to meet the requirements of a later phase during the time period specified for an earlier phase.

(3) The use of monitoring data generated before April 22, 1994 to qualify for less frequent monitoring is governed by the provisions of §63.180(b)(6) of this subpart.

(b) The owner or operator of a source subject to this subpart shall monitor all valves, except as provided in §63.162(b) of this subpart and paragraphs (h) and (i) of this section, at the intervals specified in paragraphs (c) and (d) of this section and shall comply with all other provisions of this section, except as provided in §63.171, §63.177, §63.178, and §63.179 of this subpart.

(1) The valves shall be monitored to detect leaks by the method specified in §63.180(b) of this subpart.

(2) The instrument reading that defines a leak in each phase of the standard is:

- (i) For Phase I, an instrument reading of 10,000 parts per million or greater.
- (ii) For Phase II, an instrument reading of 500 parts per million or greater.
- (iii) For Phase III, an instrument reading of 500 parts per million or greater.

(c) In Phases I and II, each valve shall be monitored quarterly.

(d) In Phase III, the owner or operator shall monitor valves for leaks at the intervals specified below:

(1) At process units with 2 percent or greater leaking valves, calculated according to paragraph (e) of this section, the owner or operator shall either:

(i) Monitor each valve once per month; or

(ii) Within the first year after the onset of Phase III, implement a quality improvement program for valves that complies with the requirements of §63.175 (d) or (e) of this subpart and monitor quarterly.

(2) At process units with less than 2 percent leaking valves, the owner or operator shall monitor each valve once each quarter, except as provided in paragraphs (d)(3) and (d)(4) of this section.

(3) At process units with less than 1 percent leaking valves, the owner or operator may elect to monitor each valve once every 2 quarters.

(4) At process units with less than 0.5 percent leaking valves, the owner or operator may elect to monitor each valve once every 4 quarters.

(e)(1) Percent leaking valves at a process unit shall be determined by the following equation:

$$\%V_L = (V_L / (V_T + V_c)) \times 100$$

where:

$\%V_L$  = Percent leaking valves as determined through periodic monitoring required in paragraphs (b) through (d) of this section.

$V_L$  = Number of valves found leaking excluding nonrepairables as provided in paragraph (e)(3)(i) of this section.

$V_T$  = Total valves monitored, in a monitoring period excluding valves monitored as required by (f)(3) of this section.

$V_c$  = Optional credit for removed valves =  $0.67 \times$  net number (i.e., total removed–total added) of valves in organic HAP service removed from process unit after the date set forth in §63.100(k) of subpart F for existing process units, and after the date of initial start-up for new sources. If credits are not taken, then  $V_c = 0$ .

(2) For use in determining monitoring frequency, as specified in paragraph (d) of this section, the percent leaking valves shall be calculated as a rolling average of two consecutive monitoring periods for monthly, quarterly, or semiannual monitoring programs; and as an average of any three out of four consecutive monitoring periods for annual monitoring programs.

(3)(i) Nonrepairable valves shall be included in the calculation of percent leaking valves the first time the valve is identified as leaking and nonrepairable and as required to comply with paragraph (e)(3)(ii) of this section. Otherwise, a number of nonrepairable valves (identified and included in the percent leaking calculation in a previous period) up to a maximum of 1 percent of the total number of valves in organic HAP service at a process unit may be excluded from calculation of percent leaking valves for subsequent monitoring periods.

(ii) If the number of nonrepairable valves exceeds 1 percent of the total number of valves in organic HAP service at a process unit, the number of nonrepairable valves exceeding 1 percent of the total number of valves in organic HAP service shall be included in the calculation of percent leaking valves.

(f)(1) When a leak is detected, it shall be repaired as soon as practicable, but no later than 15 calendar days after the leak is detected, except as provided in §63.171 of this subpart.

(2) A first attempt at repair shall be made no later than 5 calendar days after each leak is detected.

(3) When a leak has been repaired, the valve shall be monitored at least once within the first 3 months after its repair.

(i) The monitoring shall be conducted as specified in §63.180 (b) and (c), as appropriate, to determine whether the valve has resumed leaking.

(ii) Periodic monitoring required by paragraphs (b) through (d) of this section may be used to satisfy the requirements of this paragraph (f)(3), if the timing of the monitoring period coincides with the time specified in this paragraph (f)(3). Alternatively, other monitoring may be performed to satisfy the requirements of this paragraph (f)(3), regardless of whether the timing of the monitoring period for periodic monitoring coincides with the time specified in this paragraph (f)(3).

(iii) If a leak is detected by monitoring that is conducted pursuant to paragraph (f)(3) of this section, the owner or operator shall follow the provisions of paragraphs (f)(3)(iii)(A) and (f)(3)(iii)(B) of this section, to determine whether that valve must be counted as a leaking valve for purposes of §63.168(e) of this subpart.

(A) If the owner or operator elected to use periodic monitoring required by paragraphs (b) through (d) of this section to satisfy the requirements of paragraph (f)(3) of this section, then the valve shall be counted as a leaking valve.

(B) If the owner or operator elected to use other monitoring, prior to the periodic monitoring required by paragraphs (b) through (d) of this section, to satisfy the requirements of paragraph (f)(3) of this section, then the valve shall be counted as a leaking valve unless it is repaired and shown by periodic monitoring not to be leaking.

(g) First attempts at repair include, but are not limited to, the following practices where practicable:

(1) Tightening of bonnet bolts,

(2) Replacement of bonnet bolts,

(3) Tightening of packing gland nuts, and

(4) Injection of lubricant into lubricated packing.

(h) Any valve that is designated, as described in §63.181(b)(7)(i) of this subpart, as an unsafe-to-monitor valve is exempt from the requirements of paragraphs (b) through (f) of this section if:

(1) The owner or operator of the valve determines that the valve is unsafe to monitor because monitoring personnel would be exposed to an immediate danger as a consequence of complying with paragraphs (b) through (d) of this section; and

(2) The owner or operator of the valve has a written plan that requires monitoring of the valve as frequently as practicable during safe-to-monitor times, but not more frequently than the periodic monitoring schedule otherwise applicable.

(i) Any valve that is designated, as described in §63.181(b)(7)(ii) of this subpart, as a difficult-to-monitor valve is exempt from the requirements of paragraphs (b) through (d) of this section if:

(1) The owner or operator of the valve determines that the valve cannot be monitored without elevating the monitoring personnel more than 2 meters above a support surface or it is not accessible at anytime in a safe manner;

(2) The process unit within which the valve is located is an existing source or the owner or operator

designates less than 3 percent of the total number of valves in a new source as difficult-to-monitor; and

(3) The owner or operator of the valve follows a written plan that requires monitoring of the valve at least once per calendar year.

(j) Any equipment located at a plant site with fewer than 250 valves in organic HAP service is exempt from the requirements for monthly monitoring and a quality improvement program specified in paragraph (d)(1) of this section. Instead, the owner or operator shall monitor each valve in organic HAP service for leaks once each quarter, or comply with paragraph (d)(3) or (d)(4) of this section except as provided in paragraphs (h) and (i) of this section.

[59 FR 19568, Apr. 22, 1994, as amended at 59 FR 48176, Sept. 20, 1994; 61 FR 31440, June 20, 1996; 62 FR 2790, Jan. 17, 1997]

**§63.169 Standards: Pumps, valves, connectors, and agitators in heavy liquid service; instrumentation systems; and pressure relief devices in liquid service.**

(a) Pumps, valves, connectors, and agitators in heavy liquid service, pressure relief devices in light liquid or heavy liquid service, and instrumentation systems shall be monitored within 5 calendar days by the method specified in §63.180(b) of this subpart if evidence of a potential leak to the atmosphere is found by visual, audible, olfactory, or any other detection method. If such a potential leak is repaired as required in paragraphs (c) and (d) of this section, it is not necessary to monitor the system for leaks by the method specified in §63.180(b) of this subpart.

(b) If an instrument reading of 10,000 parts per million or greater for agitators, 5,000 parts per million or greater for pumps handling polymerizing monomers, 2,000 parts per million or greater for all other pumps (including pumps in food/medical service), or 500 parts per million or greater for valves, connectors, instrumentation systems, and pressure relief devices is measured, a leak is detected.

(c)(1) When a leak is detected, it shall be repaired as soon as practicable, but not later than 15 calendar days after it is detected, except as provided in §63.171 of this subpart.

(2) The first attempt at repair shall be made no later than 5 calendar days after each leak is detected.

(3) For equipment identified in paragraph (a) of this section that is not monitored by the method specified in §63.180(b), repaired shall mean that the visual, audible, olfactory, or other indications of a leak to the atmosphere have been eliminated; that no bubbles are observed at potential leak sites during a leak check using soap solution; or that the system will hold a test pressure.

(d) First attempts at repair include, but are not limited to, the practices described under §§63.163(c)(2) and 63.168(g) of this subpart, for pumps and valves, respectively.

[59 FR 19568, Apr. 22, 1994, as amended at 59 FR 48177, Sept. 20, 1994; 60 FR 18029, Apr. 10, 1995; 62 FR 2790, Jan. 17, 1997; 65 FR 78285, Dec. 14, 2000]

**§63.170 Standards: Surge control vessels and bottoms receivers.**

Each surge control vessel or bottoms receiver that is not routed back to the process and that meets the conditions specified in table 2 or table 3 of this subpart shall be equipped with a closed-vent system that routes the organic vapors vented from the surge control vessel or bottoms receiver back to the process or to a control device that complies with the requirements in §63.172 of this subpart, except as provided in §63.162(b) of this subpart, or comply with the requirements of §63.119(b) or (c) of subpart G

of this part.

[60 FR 18024, Apr. 10, 1995]

**§63.171 Standards: Delay of repair.**

(a) Delay of repair of equipment for which leaks have been detected is allowed if repair within 15 days is technically infeasible without a process unit shutdown. Repair of this equipment shall occur by the end of the next process unit shutdown.

(b) Delay of repair of equipment for which leaks have been detected is allowed for equipment that is isolated from the process and that does not remain in organic HAP service.

(c) Delay of repair for valves, connectors, and agitators is also allowed if:

(1) The owner or operator determines that emissions of purged material resulting from immediate repair would be greater than the fugitive emissions likely to result from delay of repair, and

(2) When repair procedures are effected, the purged material is collected and destroyed or recovered in a control device complying with §63.172 of this subpart.

(d) Delay of repair for pumps is also allowed if:

(1) Repair requires replacing the existing seal design with a new system that the owner or operator has determined under the provisions of §63.176(d) of this subpart will provide better performance or:

(i) A dual mechanical seal system that meets the requirements of §63.163(e) of this subpart,

(ii) A pump that meets the requirements of §63.163(f) of this subpart, or

(iii) A closed-vent system and control device that meets the requirements of §63.163(g) of this subpart; and

(2) Repair is completed as soon as practicable, but not later than 6 months after the leak was detected.

(e) Delay of repair beyond a process unit shutdown will be allowed for a valve if valve assembly replacement is necessary during the process unit shutdown, valve assembly supplies have been depleted, and valve assembly supplies had been sufficiently stocked before the supplies were depleted. Delay of repair beyond the second process unit shutdown will not be allowed unless the third process unit shutdown occurs sooner than 6 months after the first process unit shutdown.

[59 FR 19568, Apr. 22, 1994, as amended at 59 FR 48177, Sept. 20, 1994; 65 FR 78285, Dec. 14, 2000]

**§63.172 Standards: Closed-vent systems and control devices.**

(a) Owners or operators of closed-vent systems and control devices used to comply with provisions of this subpart shall comply with the provisions of this section, except as provided in §63.162(b) of this subpart.

(b) Recovery or recapture devices (e.g., condensers and absorbers) shall be designed and operated to recover the organic hazardous air pollutant emissions or volatile organic compounds emissions vented



to them with an efficiency of 95 percent or greater, or to an exit concentration of 20 parts per million by volume, whichever is less stringent. The 20 parts per million by volume performance standard is not applicable to the provisions of §63.179.

(c) Enclosed combustion devices shall be designed and operated to reduce the organic hazardous air pollutant emissions or volatile organic compounds emissions vented to them with an efficiency of 95 percent or greater, or to an exit concentration of 20 parts per million by volume, on a dry basis, corrected to 3 percent oxygen, whichever is less stringent, or to provide a minimum residence time of 0.50 seconds at a minimum temperature of 760 °C.

(d) Flares used to comply with this subpart shall comply with the requirements of §63.11(b) of subpart A of this part.

(e) Owners or operators of control devices that are used to comply with the provisions of this subpart shall monitor these control devices to ensure that they are operated and maintained in conformance with their design.

NOTE: The intent of this provision is to ensure proper operation and maintenance of the control device.

(f) Except as provided in paragraphs (k) and (l) of this section, each closed-vent system shall be inspected according to the procedures and schedule specified in paragraphs (f)(1) and (f)(2) of this section.

(1) If the closed-vent system is constructed of hard-piping, the owner or operator shall:

- (i) Conduct an initial inspection according to the procedures in paragraph (g) of this section, and
- (ii) Conduct annual visual inspections for visible, audible, or olfactory indications of leaks.

(2) If the vapor collection system or closed-vent system is constructed of duct work, the owner or operator shall:

- (i) Conduct an initial inspection according to the procedures in paragraph (g) of this section, and
- (ii) Conduct annual inspections according to the procedures in paragraph (g) of this section.

(g) Each closed-vent system shall be inspected according to the procedures in §63.180(b) of this subpart.

(h) Leaks, as indicated by an instrument reading greater than 500 parts per million above background or by visual inspections, shall be repaired as soon as practicable, except as provided in paragraph (i) of this section.

(1) A first attempt at repair shall be made no later than 5 calendar days after the leak is detected.

(2) Repair shall be completed no later than 15 calendar days after the leak is detected, except as provided in paragraph (i) of this section.

(i) Delay of repair of a closed-vent system for which leaks have been detected is allowed if the repair is technically infeasible without a process unit shutdown or if the owner or operator determines that emissions resulting from immediate repair would be greater than the fugitive emissions likely to result from delay of repair. Repair of such equipment shall be complete by the end of the next process unit

shutdown.

(j) For each closed-vent system that contains bypass lines that could divert a vent stream away from the control device and to the atmosphere, the owner or operator shall comply with the provisions of either paragraph (j)(1) or (j)(2) of this section, except as provided in paragraph (j)(3) of this section.

(1) Install, set or adjust, maintain, and operate a flow indicator that takes a reading at least once every 15 minutes. Records shall be generated as specified in §63.118(a)(3) of subpart G of this part. The flow indicator shall be installed at the entrance to any bypass line; or

(2) Secure the bypass line valve in the non-diverting position with a car-seal or a lock-and-key type configuration. A visual inspection of the seal or closure mechanism shall be performed at least once every month to ensure the valve is maintained in the non-diverting position and the vent stream is not diverted through the bypass line.

(3) Equipment such as low leg drains, high point bleeds, analyzer vents, open-ended valves or lines, and pressure relief valves needed for safety purposes are not subject to this paragraph.

(k) Any parts of the closed-vent system that are designated, as described in paragraph 63.181(b)(7)(i), as unsafe to inspect are exempt from the inspection requirements of paragraphs (f)(1) and (f)(2) of this section if:

(1) The owner or operator determines that the equipment is unsafe to inspect because inspecting personnel would be exposed to an imminent or potential danger as a consequence of complying with paragraph (f)(1) or (f)(2) of this section; and

(2) The owner or operator has a written plan that requires inspection of the equipment as frequently as practicable during safe-to-inspect times, but not more frequently than annually.

(l) Any parts of the closed-vent system that are designated, as described in §63.181 (b)(7)(i) of this subpart, as difficult to inspect are exempt from the inspection requirements of paragraphs (f)(1) and (f)(2) of this section if:

(1) The owner or operator determines that the equipment cannot be inspected without elevating the inspecting personnel more than 2 meters above a support surface; and

(2) The owner or operator has a written plan that requires inspection of the equipment at least once every 5 years.

(m) Whenever organic HAP emissions are vented to a closed-vent system or control device used to comply with the provisions of this subpart, such system or control device shall be operating.

(n) After the compliance dates specified in §63.100 of subpart F of this part, the owner or operator of any control device subject to this subpart that is also subject to monitoring, recordkeeping, and reporting requirements in 40 CFR part 264, subpart BB, or is subject to monitoring and recordkeeping requirements in 40 CFR part 265, subpart BB, may elect to comply either with the monitoring, recordkeeping, and reporting requirements of this subpart, or with the monitoring, recordkeeping, and reporting requirements in 40 CFR parts 264 and/or 265, as described in this paragraph, which shall constitute compliance with the monitoring, recordkeeping and reporting requirements of this subpart. The owner or operator shall identify which option has been chosen, in the next periodic report required by §63.182(d).

**§63.173 Standards: Agitators in gas/vapor service and in light liquid service.**

(a)(1) Each agitator shall be monitored monthly to detect leaks by the methods specified in §63.180(b) of this subpart, except as provided in §63.162(b) of this subpart.

(2) If an instrument reading of 10,000 parts per million or greater is measured, a leak is detected.

(b)(1) Each agitator shall be checked by visual inspection each calendar week for indications of liquids dripping from the agitator.

(2) If there are indications of liquids dripping from the agitator, a leak is detected.

(c)(1) When a leak is detected, it shall be repaired as soon as practicable, but not later than 15 calendar days after it is detected, except as provided in §63.171 of this subpart.

(2) A first attempt at repair shall be made no later than 5 calendar days after each leak is detected.

(d) Each agitator equipped with a dual mechanical seal system that includes a barrier fluid system is exempt from the requirements of paragraph (a) of this section, provided the requirements specified in paragraphs (d)(1) through (d)(6) of this section are met:

(1) Each dual mechanical seal system is:

(i) Operated with the barrier fluid at a pressure that is at all times greater than the agitator stuffing box pressure; or

(ii) Equipped with a barrier fluid degassing reservoir that is routed to a process or fuel gas system or connected by a closed-vent system to a control device that complies with the requirements of §63.172 of this subpart; or

(iii) Equipped with a closed-loop system that purges the barrier fluid into a process stream.

(2) The barrier fluid is not in light liquid organic HAP service.

(3) Each barrier fluid system is equipped with a sensor that will detect failure of the seal system, the barrier fluid system, or both.

(4) Each agitator is checked by visual inspection each calendar week for indications of liquids dripping from the agitator seal.

(i) If there are indications of liquids dripping from the agitator seal at the time of the weekly inspection, the agitator shall be monitored as specified in §63.180(b) of this subpart to determine the presence of organic HAP in the barrier fluid.

(ii) If an instrument reading of 10,000 parts per million or greater is measured, a leak is detected.

(5) Each sensor as described in paragraph (d)(3) of this section is observed daily or is equipped with an alarm unless the agitator is located within the boundary of an unmanned plant site.

(6)(i) The owner or operator determines, based on design considerations and operating experience, criteria applicable to the presence and frequency of drips and to the sensor that indicates failure of the seal system, the barrier fluid system, or both.

(ii) If indications of liquids dripping from the agitator seal exceed the criteria established in paragraph (d)(6)(i) of this section, or if, based on the criteria established in paragraph (d)(6)(i) of this section, the sensor indicates failure of the seal system, the barrier fluid system, or both, a leak is detected.

(iii) When a leak is detected, it shall be repaired as soon as practicable, but not later than 15 calendar days after it is detected, except as provided in §63.171 of this subpart.

(iv) A first attempt at repair shall be made no later than 5 calendar days after each leak is detected.

(e) Any agitator that is designed with no externally actuated shaft penetrating the agitator housing is exempt from paragraphs (a) through (c) of this section.

(f) Any agitator equipped with a closed-vent system capable of capturing and transporting any leakage from the seal or seals to a process or fuel gas system or to a control device that complies with the requirements of §63.172 of this subpart is exempt from the requirements of paragraphs (a) through (c) of the section.

(g) Any agitator that is located within the boundary of an unmanned plant site is exempt from the weekly visual inspection requirement of paragraphs (b)(1) and (d)(4) of this section, and the daily requirements of paragraph (d)(5) of this section, provided that each agitator is visually inspected as often as practical and at least monthly.

(h) Any agitator that is difficult-to-monitor is exempt from the requirements of paragraphs (a) through (d) of this section if:

(1) The owner or operator determines that the agitator cannot be monitored without elevating the monitoring personnel more than two meters above a support surface or it is not accessible at anytime in a safe manner;

(2) The process unit within which the agitator is located is an existing source or the owner or operator designates less than three percent of the total number of agitators in a new source as difficult-to-monitor; and

(3) The owner or operator follows a written plan that requires monitoring of the agitator at least once per calendar year.

(i) Any agitator that is obstructed by equipment or piping that prevents access to the agitator by a monitor probe is exempt from the monitoring requirements of paragraphs (a) through (d) of this section.

(j) Any agitator that is designated, as described in §63.181(b)(7)(i) of this subpart, as an unsafe-to-monitor agitator is exempt from the requirements of paragraphs (a) through (d) of this section if:

(1) The owner or operator of the agitator determines that the agitator is unsafe to monitor because monitoring personnel would be exposed to an immediate danger as a consequence of complying with paragraphs (a) through (d) of this section; and

(2) The owner or operator of the agitator has a written plan that requires monitoring of the agitator as frequently as practical during safe-to-monitor times, but not more frequently than the periodic monitoring schedule otherwise applicable.

**§63.174 Standards: Connectors in gas/vapor service and in light liquid service.**

(a) The owner or operator of a process unit subject to this subpart shall monitor all connectors in gas/vapor and light liquid service, except as provided in §63.162(b) of this subpart, and in paragraphs (f) through (h) of this section, at the intervals specified in paragraph (b) of this section.

(1) The connectors shall be monitored to detect leaks by the method specified in §63.180(b) of this subpart.

(2) If an instrument reading greater than or equal to 500 parts per million is measured, a leak is detected.

(b) The owner or operator shall monitor for leaks at the intervals specified in either paragraph (b)(1) or (b)(2) of this section and in paragraph (b)(3) of this section.

(1) For each group of existing process units within an existing source, by no later than 12 months after the compliance date, the owner or operator shall monitor all connectors, except as provided in paragraphs (f) through (h) of this section.

(2) For new sources, within the first 12 months after initial start-up or by no later than 12 months after the date of promulgation of a specific subpart that references this subpart, whichever is later, the owner or operator shall monitor all connectors, except as provided in paragraphs (f) through (h) of this section.

(3) After conducting the initial survey required in paragraph (b)(1) or (b)(2) of this section, the owner or operator shall perform all subsequent monitoring of connectors at the frequencies specified in paragraphs (b)(3)(i) through (b)(3)(v) of this section, except as provided in paragraph (c)(2) of this section:

(i) Once per year (i.e., 12-month period), if the percent leaking connectors in the process unit was 0.5 percent or greater during the last required annual or biennial monitoring period.

(ii) Once every 2 years, if the percent leaking connectors was less than 0.5 percent during the last required monitoring period. An owner or operator may comply with this paragraph by monitoring at least 40 percent of the connectors in the first year and the remainder of the connectors in the second year. The percent leaking connectors will be calculated for the total of all monitoring performed during the 2-year period.

(iii) If the owner or operator of a process unit in a biennial leak detection and repair program calculates less than 0.5 percent leaking connectors from the 2-year monitoring period, the owner or operator may monitor the connectors one time every 4 years. An owner or operator may comply with the requirements of this paragraph by monitoring at least 20 percent of the connectors each year until all connectors have been monitored within 4 years.

(iv) If a process unit complying with the requirements of paragraph (b) of this section using a 4-year monitoring interval program has greater than or equal to 0.5 percent but less than 1 percent leaking connectors, the owner or operator shall increase the monitoring frequency to one time every 2 years. An owner or operator may comply with the requirements of this paragraph by monitoring at least 40 percent of the connectors in the first year and the remainder of the connectors in the second year. The owner or operator may again elect to use the provisions of paragraph (b)(3)(iii) of this section when the percent leaking connectors decreases to less than 0.5 percent.

(v) If a process unit complying with requirements of paragraph (b)(3)(iii) of this section using a 4-year monitoring interval program has 1 percent or greater leaking connectors, the owner or operator shall

increase the monitoring frequency to one time per year. The owner or operator may again elect to use the provisions of paragraph (b)(3)(iii) of this section when the percent leaking connectors decreases to less than 0.5 percent.

(4) The use of monitoring data generated before April 22, 1994 to qualify for less frequent monitoring is governed by the provisions of §63.180(b)(6).

(c)(1)(i) Except as provided in paragraph (c)(1)(ii) of this section, each connector that has been opened or has otherwise had the seal broken shall be monitored for leaks when it is reconnected or within the first 3 months after being returned to organic hazardous air pollutants service. If the monitoring detects a leak, it shall be repaired according to the provisions of paragraph (d) of this section, unless it is determined to be nonrepairable, in which case it is counted as a nonrepairable connector for the purposes of paragraph (i)(2) of this section.

(ii) As an alternative to the requirements in paragraph (c)(1)(i) of this section, an owner or operator may choose not to monitor connectors that have been opened or otherwise had the seal broken. In this case, the owner or operator may not count nonrepairable connectors for the purposes of paragraph (i)(2) of this section. The owner or operator shall calculate the percent leaking connectors for the monitoring periods described in paragraph (b) of this section, by setting the nonrepairable component,  $C_{AN}$ , in the equation in paragraph (i)(2) of this section to zero for all monitoring periods.

(iii) An owner or operator may switch alternatives described in paragraphs (c)(1) (i) and (ii) of this section at the end of the current monitoring period he is in, provided that it is reported as required in §63.182 of this subpart and begin the new alternative in annual monitoring. The initial monitoring in the new alternative shall be completed no later than 12 months after reporting the switch.

(2) As an alternative to the requirements of paragraph (b)(3) of this section, each screwed connector 2 inches or less in nominal inside diameter installed in a process unit before the dates specified in paragraph (c)(2)(iii) or (c)(2)(iv) of this section may:

(i) Comply with the requirements of §63.169 of this subpart, and

(ii) Be monitored for leaks within the first 3 months after being returned to organic hazardous air pollutants service after having been opened or otherwise had the seal broken. If that monitoring detects a leak, it shall be repaired according to the provisions of paragraph (d) of this section.

(iii) For sources subject to subparts F and I of this part, the provisions of paragraph (c)(2) of this section apply to screwed connectors installed before December 31, 1992.

(iv) For sources not identified in paragraph (c)(2)(iii) of this section, the provisions of paragraph (c)(2) of this section apply to screwed connectors installed before the date of proposal of the applicable subpart of this part that references this subpart.

(d) When a leak is detected, it shall be repaired as soon as practicable, but no later than 15 calendar days after the leak is detected, except as provided in paragraph (g) of this section and in §63.171 of this subpart. A first attempt at repair shall be made no later than 5 calendar days after the leak is detected.

(e) [Reserved]

(f) Any connector that is designated, as described in §63.181(b)(7)(i) of this subpart, as an unsafe-to-monitor connector is exempt from the requirements of paragraph (a) of this section if:

(1) The owner or operator determines that the connector is unsafe to monitor because personnel would be exposed to an immediate danger as a result of complying with paragraphs (a) through (e) of this section; and

(2) The owner or operator has a written plan that requires monitoring of the connector as frequently as practicable during safe to monitor periods, but not more frequently than the periodic schedule otherwise applicable.

(g) Any connector that is designated, as described in §63.181(b)(7)(iii) of this subpart, as an unsafe-to-repair connector is exempt from the requirements of paragraphs (a), (d), and (e) of this section if:

(1) The owner or operator determines that repair personnel would be exposed to an immediate danger as a consequence of complying with paragraph (d) of this section; and

(2) The connector will be repaired before the end of the next scheduled process unit shutdown.

(h)(1) Any connector that is inaccessible or is ceramic or ceramic-lined (e.g., porcelain, glass, or glass-lined), is exempt from the monitoring requirements of paragraphs (a) and (c) of this section and from the recordkeeping and reporting requirements of §63.181 and §63.182 of this subpart. An inaccessible connector is one that is:

(i) Buried;

(ii) Insulated in a manner that prevents access to the connector by a monitor probe;

(iii) Obstructed by equipment or piping that prevents access to the connector by a monitor probe;

(iv) Unable to be reached from a wheeled scissor-lift or hydraulic-type scaffold which would allow access to connectors up to 7.6 meters (25 feet) above the ground;

(v) Inaccessible because it would require elevating the monitoring personnel more than 2 meters above a permanent support surface or would require the erection of scaffold; or

(vi) Not able to be accessed at any time in a safe manner to perform monitoring. Unsafe access includes, but is not limited to, the use of a wheeled scissor-lift on unstable or uneven terrain, the use of a motorized man-lift basket in areas where an ignition potential exists, or access would require near proximity to hazards such as electrical lines, or would risk damage to equipment.

(2) If any inaccessible or ceramic or ceramic-lined connector is observed by visual, audible, olfactory, or other means to be leaking, the leak shall be repaired as soon as practicable, but no later than 15 calendar days after the leak is detected, except as provided in §63.171 of this subpart and paragraph (g) of this section.

(3) A first attempt at repair shall be made no later than 5 calendar days after the leak is detected.

(i) For use in determining the monitoring frequency, as specified in paragraph (b) of this section, the percent leaking connectors shall be calculated as specified in paragraphs (i)(1) and (i)(2) of this section.

(1) For the first monitoring period, use the following equation:

$$\% C_L = C_L / (C_i + C_c) \times 100$$

where:

%  $C_L$  = Percent leaking connectors as determined through periodic monitoring required in paragraphs (a) and (b) of this section.

$C_L$  = Number of connectors measured at 500 parts per million or greater, by the method specified in §63.180(b) of this subpart.

$C_t$  = Total number of monitored connectors in the process unit.

$C_c$  = Optional credit for removed connectors =  $0.67 \times$  net (i.e., total removed—total added) number of connectors in organic hazardous air pollutants service removed from the process unit after the compliance date set forth in the applicable subpart for existing process units, and after the date of initial start-up for new process units. If credits are not taken, then  $C_c = 0$ .

(2) For subsequent monitoring periods, use the following equation:

$$\% C_L = [(C_L - C_{AN}) / (C_t + C_c)] \times 100$$

where:

%  $C_L$  = Percent leaking connectors as determined through periodic monitoring required in paragraphs (a) and (b) of this section.

$C_L$  = Number of connectors, including nonrepairables, measured at 500 parts per million or greater, by the method specified in §63.180(b) of this subpart.

$C_{AN}$  = Number of allowable nonrepairable connectors, as determined by monitoring required in paragraphs (b)(3) and (c) of this section, not to exceed 2 percent of the total connector population,  $C_t$ .

$C_t$  = Total number of monitored connectors, including nonrepairables, in the process unit.

$C_c$  = Optional credit for removed connectors =  $0.67 \times$  net number (i.e., total removed—total added) of connectors in organic hazardous air pollutants service removed from the process unit after the compliance date set forth in the applicable subpart for existing process units, and after the date of initial start-up for new process units. If credits are not taken, then  $C_c = 0$ .

(j) Optional credit for removed connectors. If an owner or operator eliminates a connector subject to monitoring under paragraph (b) of this section, the owner or operator may receive credit for elimination of the connector, as described in paragraph (i) of this section, provided the requirements in paragraphs (j)(1) through (j)(4) are met.

(1) The connector was welded after the date of proposal of the specific subpart that references this subpart.

(2) The integrity of the weld is demonstrated by monitoring it according to the procedures in §63.180(b) of this subpart or by testing using X-ray, acoustic monitoring, hydrotesting, or other applicable method.

(3) Welds created after the date of proposal but before the date of promulgation of a specific subpart that references this subpart are monitored or tested by 3 months after the compliance date specified in the applicable subpart.

(4) Welds created after promulgation of the subpart that references this subpart are monitored or tested within 3 months after being welded.



(5) If an inadequate weld is found or the connector is not welded completely around the circumference, the connector is not considered a welded connector and is therefore not exempt from the provisions of this subpart.

[59 FR 19568, Apr. 22, 1994, as amended at 59 FR 48177, Sept. 20, 1994; 61 FR 31440, June 20, 1996; 62 FR 2791, Jan. 17, 1997]

### **§63.175 Quality improvement program for valves.**

(a) In Phase III, an owner or operator may elect to comply with one of the alternative quality improvement programs specified in paragraphs (d) and (e) of this section. The decision to use one of these alternative provisions to comply with the requirements of §63.168(d)(1)(ii) of this subpart must be made during the first year of Phase III for existing process units and for new process units.

(b) An owner or operator of a process unit subject to the requirements of paragraph (d) or (e) of this section shall comply with those requirements until the process unit has fewer than 2 percent leaking valves, calculated as a rolling average of 2 consecutive quarters, as specified in §63.168(e) of this subpart.

(c) After the process unit has fewer than 2 percent leaking valves, the owner or operator may elect to comply with the requirements in §63.168 of this subpart, to continue to comply with the requirements in paragraph (e) (or (d), if appropriate) of this section, or comply with both the requirements in §63.168 and §63.175.

(1) If the owner or operator elects to continue the quality improvement program, the owner or operator is exempt from the requirements for performance trials as specified in paragraph (e)(6) of this section, or further progress as specified in paragraph (d)(4) of this section, as long as the process unit has fewer than 2 percent leaking valves calculated according to §63.168(e).

(2) If the owner or operator elects to comply with both paragraph (e) of this section and §63.168 of this subpart, he may also take advantage of the lower monitoring frequencies associated with lower leak rates in §63.168 (d)(2), (d)(3), and (d)(4) of this subpart.

(3) If the owner or operator elects not to continue the quality improvement program, the program is no longer an option if the process unit again exceeds 2 percent leaking valves, and in such case, monthly monitoring will be required.

(d) The following requirements shall be met if an owner or operator elects to use a quality improvement program to demonstrate further progress:

(1) The owner or operator shall continue to comply with the requirements in §63.168 of this subpart except each valve shall be monitored quarterly.

(2) The owner or operator shall collect the following data, and maintain records as required in §63.181(h)(1) of this subpart, for each valve in each process unit subject to the quality improvement program:

(i) The maximum instrument reading observed in each monitoring observation before repair, the response factor for the stream if appropriate, the instrument model number, and date of the observation.

(ii) Whether the valve is in gas or light liquid service.

(iii) If a leak is detected, the repair methods used and the instrument readings after repair.

(3) The owner or operator shall continue to collect data on the valves as long as the process unit remains in the quality improvement program.

(4) The owner or operator must demonstrate progress in reducing the percent leaking valves each quarter the process unit is subject to the requirements of paragraph (d) of this section, except as provided in paragraphs (d)(4)(ii) and (d)(4)(iii) of this section.

(i) Demonstration of progress shall mean that for each quarter there is at least a 10-percent reduction in the percent leaking valves from the percent leaking valves determined for the preceding monitoring period. The percent leaking valves shall be calculated as a rolling average of two consecutive quarters of monitoring data. The percent reduction shall be calculated using the rolling average percent leaking valves, according to the following:

$$\%LV_R = (\%LV_{AVG1} - \%LV_{AVG2} / \%LV_{AVG1} \times 100$$

where:

$\%LV_R$  = Percent leaking valve reduction.

$$\%LV_{AVG1} = (\%V_{L_i} + \%V_{L_{i-1}})/2.$$

$$\%LV_{AVG2} = (\%V_{L_{i-1}} + \%V_{L_{i-2}})/2.$$

where:

$\%V_{L_i}$ ,  $\%V_{L_{i-1}}$ ,  $\%V_{L_{i-2}}$  are percent leaking valves calculated for subsequent monitoring periods,  $i$ ,  $i + 1$ ,  $i + 2$ .

(ii) An owner or operator who fails for two consecutive rolling averages to demonstrate at least a 10-percent reduction per quarter in percent leaking valves, and whose overall average percent reduction based on two or more rolling averages is less than 10 percent per quarter, shall either comply with the requirements in §63.168(d)(1)(i) of this subpart using monthly monitoring or shall comply using a quality improvement program for technology review as specified in paragraph (e) of this section. If the owner or operator elects to comply with the requirements of paragraph (e) of this section, the schedule for performance trials and valve replacements remains as specified in paragraph (e) of this section.

(iii) As an alternative to the provisions in paragraph (d)(4)(i), an owner or operator may use the procedure specified in paragraphs (d)(4)(iii)(A) and (d)(4)(iii)(B) of this section to demonstrate progress in reducing the percent leaking valves.

(A) The percent reduction that must be achieved each quarter shall be calculated as follows:

$$\%RR = \frac{\%V_L - 2\%}{0.10}$$

$\%RR$  = percent reduction required each quarter, as calculated according to §63.168(e)

$\%V_L$  = percent leaking valves, calculated according to §63.168(e), at the time elected to use provisions of §63.168(d)(1)(ii)

(B) The owner or operator shall achieve less than 2 percent leaking valves no later than 2 years after electing to use the demonstration of progress provisions in §63.175(d) of this subpart.

(e) The following requirements shall be met if an owner or operator elects to use a quality improvement program of technology review and improvement:

(1) The owner or operator shall comply with the requirements in §63.168 of this subpart except the requirement for monthly monitoring in §63.168(d)(1)(i) of this subpart does not apply.

(2) The owner or operator shall collect the data specified below, and maintain records as required in §63.181(h)(2), for each valve in each process unit subject to the quality improvement program. The data may be collected and the records may be maintained on a process unit or group of process units basis. The data shall include the following:

(i) Valve type (e.g., ball, gate, check); valve manufacturer; valve design (e.g., external stem or actuating mechanism, flanged body); materials of construction; packing material; and year installed.

(ii) Service characteristics of the stream such as operating pressure, temperature, line diameter, and corrosivity.

(iii) Whether the valve is in gas or light liquid service.

(iv) The maximum instrument readings observed in each monitoring observation before repair, response factor for the stream if adjusted, instrument model number, and date of the observation.

(v) If a leak is detected, the repair methods used and the instrument readings after repair.

(vi) If the data will be analyzed as part of a larger analysis program involving data from other plants or other types of process units, a description of any maintenance or quality assurance programs used in the process unit that are intended to improve emission performance.

(3) The owner or operator shall continue to collect data on the valves as long as the process unit remains in the quality improvement program.

(4) The owner or operator shall inspect all valves removed from the process unit due to leaks. The inspection shall determine which parts of the valve have failed and shall include recommendations, as appropriate, for design changes or changes in specifications to reduce leak potential.

(5)(i) The owner or operator shall analyze the data collected to comply with the requirements of paragraph (e)(2) of this section to determine the services, operating or maintenance practices, and valve designs or technologies that have poorer than average emission performance and those that have better than average emission performance. The analysis shall determine if specific trouble areas can be identified on the basis of service, operating conditions or maintenance practices, equipment design, or other process specific factors.

(ii) The analysis shall also be used to identify any superior performing valve technologies that are applicable to the service(s), operating conditions, or valve designs associated with poorer than average emission performance. A superior performing valve technology is one for which a group of such valves has a leak frequency of less than 2 percent for specific applications in such a process unit. A candidate superior performing valve technology is one demonstrated or reported in the available literature or through a group study as having low emission performance and as being capable of achieving less than 2 percent leaking valves in the process unit.

(iii) The analysis shall include consideration of:

(A) The data obtained from the inspections of valves removed from the process unit due to leaks,

(B) Information from the available literature and from the experience of other plant sites that will

identify valve designs or technologies and operating conditions associated with low emission performance for specific services, and

(C) Information on limitations on the service conditions for the valve design and operating conditions as well as information on maintenance procedures to ensure continued low emission performance.

(iv) The data analysis may be conducted through an inter- or intra-company program (or through some combination of the two approaches) and may be for a single process unit, a company, or a group of process units.

(v) The first analysis of the data shall be completed no later than 18 months after the start of Phase III. The first analysis shall be performed using a minimum of two quarters of data. An analysis of the data shall be done each year the process unit is in the quality improvement program.

(6) A trial evaluation program shall be conducted at each plant site for which the data analysis does not identify superior performing valve designs or technologies that can be applied to the operating conditions and services identified as having poorer than average performance, except as provided in paragraph (e)(6)(v) of this section. The trial program shall be used to evaluate the feasibility of using in the process unit the valve designs or technologies that have been identified by others as having low emission performance.

(i) The trial program shall include on-line trials of valves or operating and maintenance practices that have been identified in the available literature or in analysis by others as having the ability to perform with leak rates below 2 percent in similar services, as having low probability of failure, or as having no external actuating mechanism in contact with the process fluid. If any of the candidate superior performing valve technologies is not included in the performance trials, the reasons for rejecting specific technologies from consideration shall be documented as required in §63.181(h)(5)(ii) of this subpart.

(ii) The number of valves in the trial evaluation program shall be the lesser of 1 percent or 20 valves for programs involving single process units and the lesser of 1 percent or 50 valves for programs involving groups of process units.

(iii) The trial evaluation program shall specify and include documentation of:

(A) The candidate superior performing valve designs or technologies to be evaluated, the stages for evaluating the identified candidate valve designs or technologies, including the estimated time period necessary to test the applicability;

(B) The frequency of monitoring or inspection of the equipment;

(C) The range of operating conditions over which the component will be evaluated; and

(D) Conclusions regarding the emission performance and the appropriate operating conditions and services for the trial valves.

(iv) The performance trials shall initially be conducted for, at least, a 6-month period beginning not later than 18 months after the start of Phase III. Not later than 24 months after the start of Phase III, the owner or operator shall have identified valve designs or technologies that, combined with appropriate process, operating, and maintenance practices, operate with low emission performance for specific applications in the process unit. The owner or operator shall continue to conduct performance trials as long as no superior performing design or technology has been identified, except as provided in paragraph (e)(6)(vi) of this section. The compilation of candidate and demonstrated superior emission performance valve designs or technologies shall be amended in the future, as appropriate, as additional information

and experience is obtained.

(v) Any plant site with fewer than 400 valves and owned by a corporation with fewer than 100 total employees shall be exempt from trial evaluations of valves. Plant sites exempt from the trial evaluations of valves shall begin the program at the start of the fourth year of Phase III.

(vi) An owner or operator who has conducted performance trials on all candidate superior emission performance technologies suitable for the required applications in the process unit may stop conducting performance trials provided that a superior performing design or technology has been demonstrated or there are no technically feasible candidate superior technologies remaining. The owner or operator shall prepare an engineering evaluation documenting the physical, chemical, or engineering basis for the judgment that the superior emission performance technology is technically infeasible or demonstrating that it would not reduce emissions.

(7) Each owner or operator who elects to use a quality improvement program for technology review and improvement shall prepare and implement a valve quality assurance program that details purchasing specifications and maintenance procedures for all valves in the process unit. The quality assurance program may establish any number of categories, or classes, of valves as needed to distinguish among operating conditions and services associated with poorer than average emission performance as well as those associated with better than average emission performance. The quality assurance program shall be developed considering the findings of the data analysis required under paragraph (e)(5) of this section, if applicable, the findings of the trial evaluation required in paragraph (e)(6) of this section, and the operating conditions in the process unit. The quality assurance program shall be reviewed and, as appropriate, updated each year as long as the process unit has 2 percent or more leaking valves.

(i) The quality assurance program shall:

(A) Establish minimum design standards for each category of valves. The design standards shall specify known critical parameters such as tolerance, manufacturer, materials of construction, previous usage, or other applicable identified critical parameters;

(B) Require that all equipment orders specify the design standard (or minimum tolerances) for the valve;

(C) Include a written procedure for bench testing of valves that specifies performance criteria for acceptance of valves and specifies criteria for the precision and accuracy of the test apparatus. All valves repaired off-line after preparation of the quality assurance plan shall be bench-tested for leaks. This testing may be conducted by the owner or operator of the process unit, by the vendor, or by a designated representative. The owner or operator shall install only those valves that have been documented through bench-testing to be nonleaking.

(D) Require that all valves repaired on-line be monitored using the method specified in §63.180(b) of this subpart for leaks for 2 successive months, after repair.

(E) Provide for an audit procedure for quality control of purchased equipment to ensure conformance with purchase specifications. The audit program may be conducted by the owner or operator of the process unit or by a designated representative.

(F) Detail off-line valve maintenance and repair procedures. These procedures shall include provisions to ensure that rebuilt or refurbished valves will meet the design specifications for the valve type and will operate such that emissions are minimized.

(ii) The quality assurance program shall be established no later than the start of the third year of

Phase III for plant sites with 400 or more valves or owned by a corporation with 100 or more employees; and no later than the start of the fourth year of Phase III for plant sites with less than 400 valves and owned by a corporation with less than 100 employees.

(8) Beginning at the start of the third year of Phase III for plant sites with 400 or more valves or owned by a corporation with 100 or more employees and at the start of the fourth year of Phase III for plant sites with less than 400 valves and owned by a corporation with less than 100 employees, each valve that is replaced for any reason shall be replaced with a new or modified valve that complies with the quality assurance standards for the valve category and that is identified as superior emission performance technology. Superior emission performance technology means valves or valve technologies identified with emission performance that, combined with appropriate process, operating, and maintenance practices, will result in less than 2 percent leaking valves for specific applications in a large population, except as provided in paragraph (e)(8)(ii) of this section.

(i) The valves shall be maintained as specified in the quality assurance program.

(ii) If a superior emission performance technology cannot be identified, then valve replacement shall be with one of (if several) the lowest emission performance technologies that has been identified for the specific application.

[59 FR 19568, Apr. 22, 1994, as amended at 60 FR 63631, Dec. 12, 1995]

#### **§63.176 Quality improvement program for pumps.**

(a) In Phase III, if, on a 6-month rolling average, the greater of either 10 percent of the pumps in a process unit (or plant site) or three pumps in a process unit (or plant site) leak, the owner or operator shall comply with the requirements of this section as specified below:

(1) Pumps that are in food/medical service or in polymerizing monomer service shall comply with all requirements except for those specified in paragraph (d)(8) of this section.

(2) Pumps that are not in food/medical or polymerizing monomer service shall comply with all requirements of this section.

(b) The owner or operator shall comply with the requirements of this section until the number of leaking pumps is less than the greater of either 10 percent of the pumps or three pumps, calculated as a 6-month rolling average, in the process unit (or plant site). Once the performance level is achieved, the owner or operator shall comply with the requirements in §63.163 of this subpart.

(c) If in a subsequent monitoring period, the process unit (or plant site) has greater than 10 percent of the pumps leaking or three pumps leaking (calculated as a 6-month rolling average), the owner or operator shall resume the quality improvement program starting at performance trials.

(d) The quality improvement program shall include the following:

(1) The owner or operator shall comply with the requirements in §63.163 of this subpart.

(2) The owner or operator shall collect the following data, and maintain records as required in §63.181(h)(3), for each pump in each process unit (or plant site) subject to the quality improvement program. The data may be collected and the records may be maintained on a process unit or plant site basis.

(i) Pump type (e.g., piston, horizontal or vertical centrifugal, gear, bellows); pump manufacturer; seal

type and manufacturer; pump design (e.g., external shaft, flanged body); materials of construction; if applicable, barrier fluid or packing material; and year installed.

(ii) Service characteristics of the stream such as discharge pressure, temperature, flow rate, corrosivity, and annual operating hours.

(iii) The maximum instrument readings observed in each monitoring observation before repair, response factor for the stream if appropriate, instrument model number, and date of the observation.

(iv) If a leak is detected, the repair methods used and the instrument readings after repair.

(v) If the data will be analyzed as part of a larger analysis program involving data from other plants or other types of process units, a description of any maintenance or quality assurance programs used in the process unit that are intended to improve emission performance.

(3) The owner or operator shall continue to collect data on the pumps as long as the process unit (or plant site) remains in the quality improvement program.

(4) The owner or operator shall inspect all pumps or pump seals which exhibited frequent seal failures and were removed from the process unit due to leaks. The inspection shall determine the probable cause of the pump seal failure or of the pump leak and shall include recommendations, as appropriate, for design changes or changes in specifications to reduce leak potential.

(5)(i) The owner or operator shall analyze the data collected to comply with the requirements of paragraph (d)(2) of this section to determine the services, operating or maintenance practices, and pump or pump seal designs or technologies that have poorer than average emission performance and those that have better than average emission performance. The analysis shall determine if specific trouble areas can be identified on the basis of service, operating conditions or maintenance practices, equipment design, or other process specific factors.

(ii) The analysis shall also be used to determine if there are superior performing pump or pump seal technologies that are applicable to the service(s), operating conditions, or pump or pump seal designs associated with poorer than average emission performance. A superior performing pump or pump seal technology is one with a leak frequency of less than 10 percent for specific applications in the process unit or plant site. A candidate superior performing pump or pump seal technology is one demonstrated or reported in the available literature or through a group study as having low emission performance and as being capable of achieving less than 10 percent leaking pumps in the process unit (or plant site).

(iii) The analysis shall include consideration of:

(A) The data obtained from the inspections of pumps and pump seals removed from the process unit due to leaks;

(B) Information from the available literature and from the experience of other plant sites that will identify pump designs or technologies and operating conditions associated with low emission performance for specific services; and

(C) Information on limitations on the service conditions for the pump seal technology operating conditions as well as information on maintenance procedures to ensure continued low emission performance.

(iv) The data analysis may be conducted through an inter- or intra-company program (or through some combination of the two approaches) and may be for a single process unit, a plant site, a company,

or a group of process units.

(v) The first analysis of the data shall be completed no later than 18 months after the start of the quality improvement program. The first analysis shall be performed using a minimum of 6 months of data. An analysis of the data shall be done each year the process unit is in the quality improvement program.

(6) A trial evaluation program shall be conducted at each plant site for which the data analysis does not identify use of superior performing pump seal technology or pumps that can be applied to the areas identified as having poorer than average performance, except as provided in paragraph (d)(6)(v) of this section. The trial program shall be used to evaluate the feasibility of using in the process unit (or plant site) the pump designs or seal technologies, and operating and maintenance practices that have been identified by others as having low emission performance.

(i) The trial program shall include on-line trials of pump seal technologies or pump designs and operating and maintenance practices that have been identified in the available literature or in analysis by others as having the ability to perform with leak rates below 10 percent in similar services, as having low probability of failure, or as having no external actuating mechanism in contact with the process fluid. If any of the candidate superior performing pump seal technologies or pumps is not included in the performance trials, the reasons for rejecting specific technologies from consideration shall be documented as required in §63.181(h)(5)(ii).

(ii) The number of pump seal technologies or pumps in the trial evaluation program shall be the lesser of 1 percent or two pumps for programs involving single process units and the lesser of 1 percent or five pumps for programs involving a plant site or groups of process units. The minimum number of pumps or pump seal technologies in a trial program shall be one.

(iii) The trial evaluation program shall specify and include documentation of:

(A) The candidate superior performing pump seal designs or technologies to be evaluated, the stages for evaluating the identified candidate pump designs or pump seal technologies, including the time period necessary to test the applicability;

(B) The frequency of monitoring or inspection of the equipment;

(C) The range of operating conditions over which the component will be evaluated; and

(D) Conclusions regarding the emission performance and the appropriate operating conditions and services for the trial pump seal technologies or pumps.

(iv) The performance trials shall initially be conducted, at least, for a 6-month period beginning not later than 18 months after the start of the quality improvement program. No later than 24 months after the start of the quality improvement program, the owner or operator shall have identified pump seal technologies or pump designs that, combined with appropriate process, operating, and maintenance practices, operate with low emission performance for specific applications in the process unit. The owner or operator shall continue to conduct performance trials as long as no superior performing design or technology has been identified, except as provided in paragraph (d)(6)(vi) of this section. The initial list of superior emission performance pump designs or pump seal technologies shall be amended in the future, as appropriate, as additional information and experience is obtained.

(v) Any plant site with fewer than 400 valves and owned by a corporation with fewer than 100 employees shall be exempt from trial evaluations of pump seals or pump designs. Plant sites exempt from the trial evaluations of pumps shall begin the pump seal or pump replacement program at the start of the fourth year of the quality improvement program.



(vi) An owner or operator who has conducted performance trials on all alternative superior emission performance technologies suitable for the required applications in the process unit may stop conducting performance trials provided that a superior performing design or technology has been demonstrated or there are no technically feasible alternative superior technologies remaining. The owner or operator shall prepare an engineering evaluation documenting the physical, chemical, or engineering basis for the judgment that the superior emission performance technology is technically infeasible or demonstrating that it would not reduce emissions.

(7) Each owner or operator shall prepare and implement a pump quality assurance program that details purchasing specifications and maintenance procedures for all pumps and pump seals in the process unit. The quality assurance program may establish any number of categories, or classes, of pumps as needed to distinguish among operating conditions and services associated with poorer than average emission performance as well as those associated with better than average emission performance. The quality assurance program shall be developed considering the findings of the data analysis required under paragraph (d)(5) of this section, if applicable, the findings of the trial evaluation required in paragraph (d)(6) of this section, and the operating conditions in the process unit. The quality assurance program shall be updated each year as long as the process unit has the greater of either 10 percent or more leaking pumps or has three leaking pumps.

(i) The quality assurance program shall:

(A) Establish minimum design standards for each category of pumps or pump seal technology. The design standards shall specify known critical parameters such as tolerance, manufacturer, materials of construction, previous usage, or other applicable identified critical parameters;

(B) Require that all equipment orders specify the design standard (or minimum tolerances) for the pump or the pump seal;

(C) Provide for an audit procedure for quality control of purchased equipment to ensure conformance with purchase specifications. The audit program may be conducted by the owner or operator of the plant site or process unit or by a designated representative; and

(D) Detail off-line pump maintenance and repair procedures. These procedures shall include provisions to ensure that rebuilt or refurbished pumps and pump seals will meet the design specifications for the pump category and will operate such that emissions are minimized.

(ii) The quality assurance program shall be established no later than the start of the third year of the quality improvement program for plant sites with 400 or more valves or 100 or more employees; and no later than the start of the fourth year of the quality improvement program for plant sites with less than 400 valves and less than 100 employees.

(8) Beginning at the start of the third year of the quality improvement program for plant sites with 400 or more valves or 100 or more employees and at the start of the fourth year of the quality improvement program for plant sites with less than 400 valves and less than 100 employees, the owner or operator shall replace, as described in paragraphs (d)(8)(i) and (d)(8)(ii) of this section, the pumps or pump seals that are not superior emission performance technology with pumps or pump seals that have been identified as superior emission performance technology and that comply with the quality assurance standards for the pump category. Superior emission performance technology is that category or design of pumps or pump seals with emission performance which, when combined with appropriate process, operating, and maintenance practices, will result in less than 10 percent leaking pumps for specific applications in the process unit or plant site. Superior emission performance technology includes material or design changes to the existing pump, pump seal, seal support system, installation of multiple mechanical seals or equivalent, or pump replacement.

(i) Pumps or pump seals shall be replaced at the rate of 20 percent per year based on the total number of pumps in light liquid service. The calculated value shall be rounded to the nearest nonzero integer value. The minimum number of pumps or pump seals shall be one. Pump replacement shall continue until all pumps subject to the requirements of §63.163 of this subpart are pumps determined to be superior performance technology.

(ii) The owner or operator may delay replacement of pump seals or pumps with superior technology until the next planned process unit shutdown, provided the number of pump seals and pumps replaced is equivalent to the 20 percent or greater annual replacement rate.

(iii) The pumps shall be maintained as specified in the quality assurance program.

**§63.177 Alternative means of emission limitation: General.**

(a) Permission to use an alternative means of emission limitation under section 112(h)(3) of the Act shall be governed by the following procedures in paragraphs (b) through (e) of this section.

(b) Where the standard is an equipment, design, or operational requirement:

(1) Each owner or operator applying for permission to use an alternative means of emission limitation under §63.6(g) of subpart A of this part shall be responsible for collecting and verifying emission performance test data for an alternative means of emission limitation.

(2) The Administrator will compare test data for the means of emission limitation to test data for the equipment, design, and operational requirements.

(3) The Administrator may condition the permission on requirements that may be necessary to ensure operation and maintenance to achieve the same emission reduction as the equipment, design, and operational requirements.

(c) Where the standard is a work practice:

(1) Each owner or operator applying for permission shall be responsible for collecting and verifying test data for an alternative means of emission limitation.

(2) For each kind of equipment for which permission is requested, the emission reduction achieved by the required work practices shall be demonstrated for a minimum period of 12 months.

(3) For each kind of equipment for which permission is requested, the emission reduction achieved by the alternative means of emission limitation shall be demonstrated.

(4) Each owner or operator applying for permission shall commit, in writing, for each kind of equipment to work practices that provide for emission reductions equal to or greater than the emission reductions achieved by the required work practices.

(5) The Administrator will compare the demonstrated emission reduction for the alternative means of emission limitation to the demonstrated emission reduction for the required work practices and will consider the commitment in paragraph (c)(4) of this section.

(6) The Administrator may condition the permission on requirements that may be necessary to ensure operation and maintenance to achieve the same or greater emission reduction as the required work practices of this subpart.

(d) An owner or operator may offer a unique approach to demonstrate the alternative means of emission limitation.

(e)(1) Manufacturers of equipment used to control equipment leaks of an organic HAP may apply to the Administrator for permission for an alternative means of emission limitation that achieves a reduction in emissions of the organic HAP achieved by the equipment, design, and operational requirements of this subpart.

(2) The Administrator will grant permission according to the provisions of paragraphs (b), (c), and (d) of this section.

**§63.178 Alternative means of emission limitation: Batch processes.**

(a) As an alternative to complying with the requirements of §§63.163 through 63.171 and §§63.173 through 63.176, an owner or operator of a batch process that operates in organic HAP service during the calendar year may comply with one of the standards specified in paragraphs (b) and (c) of this section, or the owner or operator may petition for approval of an alternative standard under the provisions of §63.177 of this subpart. The alternative standards of this section provide the options of pressure testing or monitoring the equipment for leaks. The owner or operator may switch among the alternatives provided the change is documented as specified in §63.181.

(b) The following requirements shall be met if an owner or operator elects to use pressure testing of batch product-process equipment to demonstrate compliance with this subpart. An owner or operator who complies with the provisions of this paragraph is exempt from the monitoring provisions of §63.163, §§63.168 and 63.169, and §§63.173 through 63.176 of this subpart.

(1) Each time equipment is reconfigured for production of a different product or intermediate, the batch product-process equipment train shall be pressure-tested for leaks before organic HAP is first fed to the equipment and the equipment is placed in organic HAP service.

(i) When the batch product-process train is reconfigured to produce a different product, pressure testing is required only for the new or disturbed equipment.

(ii) Each batch product process that operates in organic HAP service during a calendar year shall be pressure tested at least once during that calendar year.

(iii) Pressure testing is not required for routine seal breaks, such as changing hoses or filters, which are not part of the reconfiguration to produce a different product or intermediate.

(2) The batch product process equipment shall be tested either using the procedures specified in §63.180(f) of this subpart for pressure or vacuum loss or with a liquid using the procedures specified in §63.180(g) of this subpart.

(3)(i) For pressure or vacuum tests, a leak is detected if the rate of change in pressure is greater than 6.9 kilopascals (1 psig) in 1 hour or if there is visible, audible, or olfactory evidence of fluid loss.

(ii) For pressure tests using a liquid, a leak is detected if there are indications of liquids dripping or if there is other evidence of fluid loss.

(4)(i) If a leak is detected, it shall be repaired and the batch product-process equipment shall be retested before start-up of the process.

(ii) If a batch product-process fails the retest or the second of two consecutive pressure tests, it shall be repaired as soon as practicable, but not later than 30 calendar days after the second pressure test, provided the conditions specified in paragraph (d) of this section are met.

(c) The following requirements shall be met if an owner or operator elects to monitor the equipment to detect leaks by the method specified in §63.180(b) of this subpart to demonstrate compliance with this subpart.

(1) The owner or operator shall comply with the requirements of §§63.163 through 63.170, and §§63.172 through 63.176 of this subpart.

(2) The equipment shall be monitored for leaks by the method specified in §63.180(b) of this subpart when the equipment is in organic HAP service, in use with an acceptable surrogate volatile organic compound which is not an organic HAP, or is in use with any other detectable gas or vapor.

(3) The equipment shall be monitored for leaks as specified below:

(i) Each time the equipment is reconfigured for the production of a new product, the reconfigured equipment shall be monitored for leaks within 30 days of start-up of the process. This initial monitoring of reconfigured equipment shall not be included in determining percent leaking equipment in the process unit.

(ii) Connectors shall be monitored in accordance with the requirements in §63.174 of this subpart.

(iii) Equipment other than connectors shall be monitored at the frequencies specified in table 1 of this subpart. The operating time shall be determined as the proportion of the year the batch product-process that is subject to the provisions of this subpart is operating.

(iv) The monitoring frequencies specified in table 1 of this subpart are not requirements for monitoring at specific intervals and can be adjusted to accommodate process operations. An owner or operator may monitor anytime during the specified monitoring period (e.g., month, quarter, year), provided the monitoring is conducted at a reasonable interval after completion of the last monitoring campaign. For example, if the equipment is not operating during the scheduled monitoring period, the monitoring can be done during the next period when the process is operating.

(4) If a leak is detected, it shall be repaired as soon as practicable but not later than 15 calendar days after it is detected, except as provided in paragraph (d) of this section.

(d) Delay of repair of equipment for which leaks have been detected is allowed if the replacement equipment is not available providing the following conditions are met:

(1) Equipment supplies have been depleted and supplies had been sufficiently stocked before the supplies were depleted.

(2) The repair is made no later than 10 calendar days after delivery of the replacement equipment.

#### **§63.179 Alternative means of emission limitation: Enclosed-vented process units.**

Process units enclosed in such a manner that all emissions from equipment leaks are vented through a closed-vent system to a control device meeting the requirements of §63.172 of this subpart are exempt from the requirements of §63.163, through 63.171, and §§63.173 and 63.174 of this subpart. The enclosure shall be maintained under a negative pressure at all times while the process unit is in operation

to ensure that all emissions are routed to a control device.

**§63.180 Test methods and procedures.**

(a) Each owner or operator subject to the provisions of this subpart shall comply with the test methods and procedures requirements provided in this section.

(b) Monitoring, as required under this subpart, shall comply with the following requirements:

(1) Monitoring shall comply with Method 21 of 40 CFR part 60, appendix A.

(2)(i) Except as provided for in paragraph (b)(2)(ii) of this section, the detection instrument shall meet the performance criteria of Method 21 of 40 CFR part 60, appendix A, except the instrument response factor criteria in Section 3.1.2(a) of Method 21 shall be for the average composition of the process fluid not each individual VOC in the stream. For process streams that contain nitrogen, water, air, or other inerts which are not organic HAP's or VOC's, the average stream response factor may be calculated on an inert-free basis. The response factor may be determined at any concentration for which monitoring for leaks will be conducted.

(ii) If no instrument is available at the plant site that will meet the performance criteria specified in paragraph (b)(2)(i) of this section, the instrument readings may be adjusted by multiplying by the average response factor of the process fluid, calculated on an inert-free basis as described in paragraph (b)(2)(i) of this section.

(3) The instrument shall be calibrated before use on each day of its use by the procedures specified in Method 21 of 40 CFR part 60, appendix A.

(4) Calibration gases shall be:

(i) Zero air (less than 10 parts per million of hydrocarbon in air); and

(ii) Mixtures of methane in air at the concentrations specified in paragraphs (b)(4)(ii)(A) through (b)(4)(ii)(C) of this section. A calibration gas other than methane in air may be used if the instrument does not respond to methane or if the instrument does not meet the performance criteria specified in paragraph (b)(2)(i) of this section. In such cases, the calibration gas may be a mixture of one or more of the compounds to be measured in air.

(A) For Phase I, a mixture of methane or other compounds, as applicable, in air at a concentration of approximately, but less than, 10,000 parts per million.

(B) For Phase II, a mixture of methane or other compounds, as applicable, and air at a concentration of approximately, but less than, 10,000 parts per million for agitators, 5,000 parts per million for pumps, and 500 parts per million for all other equipment, except as provided in paragraph (b)(4)(iii) of this section.

(C) For Phase III, a mixture of methane or other compounds, as applicable, and air at a concentration of approximately, but less than, 10,000 parts per million methane for agitators; 2,000 parts per million for pumps in food/medical service; 5,000 parts per million for pumps in polymerizing monomer service; 1,000 parts per million for all other pumps; and 500 parts per million for all other equipment, except as provided in paragraph (b)(4)(iii) of this section.

(iii) The instrument may be calibrated at a higher methane concentration than the concentration

specified for that piece of equipment. The concentration of the calibration gas may exceed the concentration specified as a leak by no more than 2,000 parts per million. If the monitoring instrument's design allows for multiple calibration scales, then the lower scale shall be calibrated with a calibration gas that is no higher than 2,000 parts per million above the concentration specified as a leak and the highest scale shall be calibrated with a calibration gas that is approximately equal to 10,000 parts per million. If only one scale on an instrument will be used during monitoring, the owner or operator need not calibrate the scales that will not be used during that day's monitoring.

(5) Monitoring shall be performed when the equipment is in organic HAP service, in use with an acceptable surrogate volatile organic compound which is not an organic HAP, or is in use with any other detectable gas or vapor.

(6) Monitoring data that do not meet the criteria specified in paragraphs (b)(1) through (b)(5) of this section may be used to qualify for less frequent monitoring under the provisions in §63.168(d)(2) and (d)(3) or §63.174(b)(3)(ii) or (b)(3)(iii) of this subpart provided the data meet the conditions specified in paragraphs (b)(6)(i) and (b)(6)(ii) of this section.

(i) The data were obtained before April 22, 1994.

(ii) The departures from the criteria specified in paragraphs (b)(1) through (b)(5) of this section or from the specified monitoring frequency of §63.168(c) are minor and do not significantly affect the quality of the data. Examples of minor departures are monitoring at a slightly different frequency (such as every six weeks instead of monthly or quarterly), following the performance criteria of section 3.1.2(a) of Method 21 of appendix A of 40 CFR part 60 instead of paragraph (b)(2) of this section, or monitoring at a different leak definition if the data would indicate the presence or absence of a leak at the concentration specified in this subpart. Failure to use a calibrated instrument is not considered a minor departure.

(c) When equipment is monitored for compliance as required in §§63.164(i), 63.165(a), and 63.172(f) or when equipment subject to a leak definition of 500 ppm is monitored for leaks as required by this subpart, the owner or operator may elect to adjust or not to adjust the instrument readings for background. If an owner or operator elects to not adjust instrument readings for background, the owner or operator shall monitor the equipment according to the procedures specified in paragraphs (b)(1) through (b)(4) of this section. In such case, all instrument readings shall be compared directly to the applicable leak definition to determine whether there is a leak. If an owner or operator elects to adjust instrument readings for background, the owner or operator shall monitor the equipment according to the procedures specified in paragraphs (c)(1) through (c)(4) of this section.

(1) The requirements of paragraphs (b) (1) through (4) of this section shall apply.

(2) The background level shall be determined, using the same procedures that will be used to determine whether the equipment is leaking.

(3) The instrument probe shall be traversed around all potential leak interfaces as close to the interface as possible as described in Method 21 of 40 CFR part 60, appendix A.

(4) The arithmetic difference between the maximum concentration indicated by the instrument and the background level is compared with 500 parts per million for determining compliance.

(d)(1) Each piece of equipment within a process unit that can reasonably be expected to contain equipment in organic HAP service is presumed to be in organic HAP service unless an owner or operator demonstrates that the piece of equipment is not in organic HAP service. For a piece of equipment to be considered not in organic HAP service, it must be determined that the percent organic HAP content can be reasonably expected not to exceed 5 percent by weight on an annual average basis. For purposes of

determining the percent organic HAP content of the process fluid that is contained in or contacts equipment, Method 18 of 40 CFR part 60, appendix A shall be used.

(2)(i) An owner or operator may use good engineering judgment rather than the procedures in paragraph (d)(1) of this section to determine that the percent organic HAP content does not exceed 5 percent by weight. When an owner or operator and the Administrator do not agree on whether a piece of equipment is not in organic HAP service, however, the procedures in paragraph (d)(1) of this section shall be used to resolve the disagreement.

(ii) Conversely, the owner or operator may determine that the organic HAP content of the process fluid does not exceed 5 percent by weight by, for example, accounting for 98 percent of the content and showing that organic HAP is less than 3 percent.

(3) If an owner or operator determines that a piece of equipment is in organic HAP service, the determination can be revised after following the procedures in paragraph (d)(1) of this section, or by documenting that a change in the process or raw materials no longer causes the equipment to be in organic HAP service.

(4) Samples used in determining the percent organic HAP content shall be representative of the process fluid that is contained in or contacts the equipment.

(e) When a flare is used to comply with §63.172(d), the owner or operator shall comply with paragraphs (e)(1) through (3) of this section. The owner or operator is not required to conduct a performance test to determine percent emission reduction or outlet organic HAP or TOC concentration.

(1) Conduct a visible emission test using the techniques specified in §63.11(b)(4).

(2) Determine the net heating value of the gas being combusted using the techniques specified in §63.11(b)(6).

(3) Determine the exit velocity using the techniques specified in either §63.11(b)(7)(i) (and §63.11(b)(7)(iii), where applicable) or §63.11(b)(8), as appropriate.

(f) The following procedures shall be used to pressure test batch product-process equipment for pressure or vacuum loss to demonstrate compliance with the requirements of §63.178(b)(3)(i) of this subpart.

(1) The batch product-process equipment train shall be pressurized with a gas to a pressure less than the set pressure of any safety relief devices or valves or to a pressure slightly above the operating pressure of the equipment, or alternatively, the equipment shall be placed under a vacuum.

(2) Once the test pressure is obtained, the gas source or vacuum source shall be shut off.

(3) The test shall continue for not less than 15 minutes unless it can be determined in a shorter period of time that the allowable rate of pressure drop or of pressure rise was exceeded. The pressure in the batch product-process equipment shall be measured after the gas or vacuum source is shut off and at the end of the test period. The rate of change in pressure in the batch product-process equipment shall be calculated using the following equation:

$$\Delta \frac{P}{t} = \frac{(P_f - P_i)}{(t_f - t_i)}$$

where:

$\Delta P/t$  = Change in pressure, psig/hr.

$P_f$  = Final pressure, psig.

$P_i$  = Initial pressure, psig.

$t_f - t_i$  = Elapsed time, hours.

(4) The pressure shall be measured using a pressure measurement device (gauge, manometer, or equivalent) which has a precision of  $\pm 2.5$  millimeter mercury in the range of test pressure and is capable of measuring pressures up to the relief set pressure of the pressure relief device. If such a pressure measurement device is not reasonably available, the owner or operator shall use a pressure measurement device with a precision of at least + 10 percent of the test pressure of the equipment and shall extend the duration of the test for the time necessary to detect a pressure loss or rise that equals a rate of one psig per hour.

(5) An alternative procedure may be used for leak testing the equipment if the owner or operator demonstrates the alternative procedure is capable of detecting a pressure loss or rise.

(g) The following procedures shall be used to pressure-test batch product-process equipment using a liquid to demonstrate compliance with the requirements of §63.178(b)(3)(ii) of this subpart.

(1) The batch product-process equipment train, or section of the train, shall be filled with the test liquid (e.g., water, alcohol) until normal operating pressure is obtained. Once the equipment is filled, the liquid source shall be shut off.

(2) The test shall be conducted for a period of at least 60 minutes, unless it can be determined in a shorter period of time that the test is a failure.

(3) Each seal in the equipment being tested shall be inspected for indications of liquid dripping or other indications of fluid loss. If there are any indications of liquids dripping or of fluid loss, a leak is detected.

(4) An alternative procedure may be used for leak testing the equipment, if the owner or operator demonstrates the alternative procedure is capable of detecting losses of fluid.

[59 FR 19568, Apr. 22, 1994, as amended at 59 FR 48177, Sept. 20, 1994; 61 FR 31440, June 20, 1996; 62 FR 2792, Jan. 17, 1997; 66 FR 6936, Jan. 22, 2001]

### **§63.181 Recordkeeping requirements.**

(a) An owner or operator of more than one process unit subject to the provisions of this subpart may comply with the recordkeeping requirements for these process units in one recordkeeping system if the system identifies each record by process unit and the program being implemented (e.g., quarterly monitoring, quality improvement) for each type of equipment. All records and information required by this section shall be maintained in a manner that can be readily accessed at the plant site. This could include physically locating the records at the plant site or accessing the records from a central location by computer at the plant site.

(b) Except as provided in paragraph (e) of this section, the following information pertaining to all equipment in each process unit subject to the requirements in §§63.162 through 63.174 of this subpart



shall be recorded:

(1)(i) A list of identification numbers for equipment (except connectors exempt from monitoring and recordkeeping identified in §63.174 of this subpart and instrumentation systems) subject to the requirements of this subpart. Connectors need not be individually identified if all connectors in a designated area or length of pipe subject to the provisions of this subpart are identified as a group, and the number of connectors subject is indicated. With respect to connectors, the list shall be complete no later than the completion of the initial survey required by §63.174 (b)(1) or (b)(2) of this subpart.

(ii) A schedule by process unit for monitoring connectors subject to the provisions of §63.174(a) of this subpart and valves subject to the provisions of §63.168(d) of this subpart.

(iii) Physical tagging of the equipment to indicate that it is in organic HAP service is not required. Equipment subject to the provisions of this subpart may be identified on a plant site plan, in log entries, or by other appropriate methods.

(2)(i) A list of identification numbers for equipment that the owner or operator elects to equip with a closed-vent system and control device, under the provisions of §63.163(g), §63.164(h), §63.165(c), or §63.173(f) of this subpart.

(ii) A list of identification numbers for compressors that the owner or operator elects to designate as operating with an instrument reading of less than 500 parts per million above background, under the provisions of §63.164(i) of this subpart.

(iii) Identification of surge control vessels or bottoms receivers subject to the provisions of this subpart that the owner or operator elects to equip with a closed-vent system and control device, under the provisions of §63.170 of this subpart.

(3)(i) A list of identification numbers for pressure relief devices subject to the provisions in §63.165(a) of this subpart.

(ii) A list of identification numbers for pressure relief devices equipped with rupture disks, under the provisions of §63.165(d) of this subpart.

(4) Identification of instrumentation systems subject to the provisions of this subpart. Individual components in an instrumentation system need not be identified.

(5) Identification of screwed connectors subject to the requirements of §63.174(c)(2) of this subpart. Identification can be by area or grouping as long as the total number within each group or area is recorded.

(6) The following information shall be recorded for each dual mechanical seal system:

(i) Design criteria required in §§63.163(e)(6)(i), 63.164(e)(2), and 63.173(d)(6)(i) of this subpart and an explanation of the design criteria; and

(ii) Any changes to these criteria and the reasons for the changes.

(7) The following information pertaining to all pumps subject to the provisions of §63.163(j), valves subject to the provisions of §63.168(h) and (i) of this subpart, agitators subject to the provisions of §63.173(h) through (j), and connectors subject to the provisions of §63.174(f) and (g) of this subpart shall be recorded:

(i) Identification of equipment designated as unsafe to monitor, difficult to monitor, or unsafe to inspect and the plan for monitoring or inspecting this equipment.

(ii) A list of identification numbers for the equipment that is designated as difficult to monitor, an explanation of why the equipment is difficult to monitor, and the planned schedule for monitoring this equipment.

(iii) A list of identification numbers for connectors that are designated as unsafe to repair and an explanation why the connector is unsafe to repair.

(8)(i) A list of valves removed from and added to the process unit, as described in §63.168(e)(1) of this subpart, if the net credits for removed valves is expected to be used.

(ii) A list of connectors removed from and added to the process unit, as described in §63.174(i)(1) of this subpart, and documentation of the integrity of the weld for any removed connectors, as required in §63.174(j) of this subpart. This is not required unless the net credits for removed connectors is expected to be used.

(9)(i) For batch process units that the owner or operator elects to monitor as provided under §63.178(c) of this subpart, a list of equipment added to batch product process units since the last monitoring period required in §63.178(c)(3)(ii) and (3)(iii) of this subpart.

(ii) Records demonstrating the proportion of the time during the calendar year the equipment is in use in a batch process that is subject to the provisions of this subpart. Examples of suitable documentation are records of time in use for individual pieces of equipment or average time in use for the process unit. These records are not required if the owner or operator does not adjust monitoring frequency by the time in use, as provided in §63.178(c)(3)(iii) of this subpart.

(10) For any leaks detected as specified in §§63.163 and 63.164; §§63.168 and 63.169; and §§63.172 through 63.174 of this subpart, a weatherproof and readily visible identification, marked with the equipment identification number, shall be attached to the leaking equipment.

(c) For visual inspections of equipment subject to the provisions of this subpart (e.g., §63.163(b)(3), §63.163(e)(4)(i)), the owner or operator shall document that the inspection was conducted and the date of the inspection. The owner or operator shall maintain records as specified in paragraph (d) of this section for leaking equipment identified in this inspection, except as provided in paragraph (e) of this section. These records shall be retained for 2 years.

(d) When each leak is detected as specified in §§63.163 and 63.164; §§63.168 and 63.169; and §§63.172 through 63.174 of this subpart, the following information shall be recorded and kept for 2 years:

(1) The instrument and the equipment identification number and the operator name, initials, or identification number.

(2) The date the leak was detected and the date of first attempt to repair the leak.

(3) The date of successful repair of the leak.

(4) Maximum instrument reading measured by Method 21 of 40 CFR part 60, appendix A after it is successfully repaired or determined to be nonrepairable.

(5) "Repair delayed" and the reason for the delay if a leak is not repaired within 15 calendar days

after discovery of the leak.

(i) The owner or operator may develop a written procedure that identifies the conditions that justify a delay of repair. The written procedures may be included as part of the startup/shutdown/malfunction plan, required by §63.6(e)(3), for the source or may be part of a separate document that is maintained at the plant site. In such cases, reasons for delay of repair may be documented by citing the relevant sections of the written procedure.

(ii) If delay of repair was caused by depletion of stocked parts, there must be documentation that the spare parts were sufficiently stocked on-site before depletion and the reason for depletion.

(6) Dates of process unit shutdowns that occur while the equipment is unrepaired.

(7)(i) Identification, either by list, location (area or grouping), or tagging of connectors that have been opened or otherwise had the seal broken since the last monitoring period required in §63.174(b) of this subpart, as described in §63.174(c)(1) of this subpart, unless the owner or operator elects to comply with the provisions of §63.174(c)(1)(ii) of this subpart.

(ii) The date and results of monitoring as required in §63.174(c) of this subpart. If identification of connectors that have been opened or otherwise had the seal broken is made by location under paragraph (d)(7)(i) of this section, then all connectors within the designated location shall be monitored.

(8) The date and results of the monitoring required in §63.178(c)(3)(i) of this subpart for equipment added to a batch process unit since the last monitoring period required in §63.178 (c)(3)(ii) and (c)(3)(iii) of this subpart. If no leaking equipment is found in this monitoring, the owner or operator shall record that the inspection was performed. Records of the actual monitoring results are not required.

(9) Copies of the periodic reports as specified in §63.182(d) of this subpart, if records are not maintained on a computerized database capable of generating summary reports from the records.

(e) The owner or operator of a batch product process who elects to pressure test the batch product process equipment train to demonstrate compliance with this subpart is exempt from the requirements of paragraphs (b), (c), (d), and (f) of this section. Instead, the owner or operator shall maintain records of the following information:

(1) The identification of each product, or product code, produced during the calendar year. It is not necessary to identify individual items of equipment in a batch product process equipment train.

(2) [Reserved]

(3) Physical tagging of the equipment to identify that it is in organic HAP service and subject to the provisions of this subpart is not required. Equipment in a batch product process subject to the provisions of this subpart may be identified on a plant site plan, in log entries, or by other appropriate methods.

(4) The dates of each pressure test required in §63.178(b) of this subpart, the test pressure, and the pressure drop observed during the test.

(5) Records of any visible, audible, or olfactory evidence of fluid loss.

(6) When a batch product process equipment train does not pass two consecutive pressure tests, the following information shall be recorded in a log and kept for 2 years:

(i) The date of each pressure test and the date of each leak repair attempt.

(ii) Repair methods applied in each attempt to repair the leak.

(iii) The reason for the delay of repair.

(iv) The expected date for delivery of the replacement equipment and the actual date of delivery of the replacement equipment.

(v) The date of successful repair.

(f) The dates and results of each compliance test required for compressors subject to the provisions in §63.164(i) and the dates and results of the monitoring following a pressure release for each pressure relief device subject to the provisions in §§63.165 (a) and (b) of this subpart. The results shall include:

(1) The background level measured during each compliance test.

(2) The maximum instrument reading measured at each piece of equipment during each compliance test.

(g) The owner or operator shall maintain records of the information specified in paragraphs (g)(1) through (g)(3) of this section for closed-vent systems and control devices subject to the provisions of §63.172 of this subpart. The records specified in paragraph (g)(1) of this section shall be retained for the life of the equipment. The records specified in paragraphs (g)(2) and (g)(3) of this section shall be retained for 2 years.

(1) The design specifications and performance demonstrations specified in paragraphs (g)(1)(i) through (g)(1)(iv) of this section.

(i) Detailed schematics, design specifications of the control device, and piping and instrumentation diagrams.

(ii) The dates and descriptions of any changes in the design specifications.

(iii) The flare design (i.e., steam-assisted, air-assisted, or non-assisted) and the results of the compliance demonstration required by §63.11(b) of subpart A of this part.

(iv) A description of the parameter or parameters monitored, as required in §63.172(e) of this subpart, to ensure that control devices are operated and maintained in conformance with their design and an explanation of why that parameter (or parameters) was selected for the monitoring.

(2) Records of operation of closed-vent systems and control devices, as specified in paragraphs (g)(2)(i) through (g)(2)(iii) of this section.

(i) Dates and durations when the closed-vent systems and control devices required in §§63.163 through 63.166, and §63.170 of this subpart are not operated as designed as indicated by the monitored parameters, including periods when a flare pilot light system does not have a flame.

(ii) Dates and durations during which the monitoring system or monitoring device is inoperative.

(iii) Dates and durations of start-ups and shutdowns of control devices required in §§63.163 through 63.166, and §63.170 of this subpart.

(3) Records of inspections of closed-vent systems subject to the provisions of §63.172 of this subpart, as specified in paragraphs (g)(3)(i) and (g)(3)(ii) of this section.

(i) For each inspection conducted in accordance with the provisions of §63.172(f)(1) or (f)(2) of this subpart during which no leaks were detected, a record that the inspection was performed, the date of the inspection, and a statement that no leaks were detected.

(ii) For each inspection conducted in accordance with the provisions of §63.172(f)(1) or (f)(2) of this subpart during which leaks were detected, the information specified in paragraph (d) of this section shall be recorded.

(h) Each owner or operator of a process unit subject to the requirements of §§63.175 and 63.176 of this subpart shall maintain the records specified in paragraphs (h)(1) through (h)(9) of this section for the period of the quality improvement program for the process unit.

(1) For owners or operators who elect to use a reasonable further progress quality improvement program, as specified in §63.175(d) of this subpart:

(i) All data required in §63.175(d)(2) of this subpart.

(ii) The percent leaking valves observed each quarter and the rolling average percent reduction observed in each quarter.

(iii) The beginning and ending dates while meeting the requirements of §63.175(d) of this subpart.

(2) For owners or operators who elect to use a quality improvement program of technology review and improvement, as specified in §63.175(e) of this subpart:

(i) All data required in §63.175(e)(2) of this subpart.

(ii) The percent leaking valves observed each quarter.

(iii) Documentation of all inspections conducted under the requirements of §63.175(e)(4) of this subpart, and any recommendations for design or specification changes to reduce leak frequency.

(iv) The beginning and ending dates while meeting the requirements of §63.175(e) of this subpart.

(3) For owners or operators subject to the requirements of the pump quality improvement program as specified in §63.176 of this subpart:

(i) All data required in §63.176(d)(2) of this subpart.

(ii) The rolling average percent leaking pumps.

(iii) Documentation of all inspections conducted under the requirements of §63.176(d)(4) of this subpart, and any recommendations for design or specification changes to reduce leak frequency.

(iv) The beginning and ending dates while meeting the requirements of §63.176(d) of this subpart.

(4) If a leak is not repaired within 15 calendar days after discovery of the leak, the reason for the delay and the expected date of successful repair.

(5) Records of all analyses required in §§63.175(e) and 63.176(d) of this subpart. The records will include the following:

(i) A list identifying areas associated with poorer than average performance and the associated service characteristics of the stream, the operating conditions and maintenance practices.

(ii) The reasons for rejecting specific candidate superior emission performing valve or pump technology from performance trials.

(iii) The list of candidate superior emission performing valve or pump technologies, and documentation of the performance trial program items required under §§63.175(e)(6)(iii) and 63.176(d)(6)(iii) of this subpart.

(iv) The beginning date and duration of performance trials of each candidate superior emission performing technology.

(6) All records documenting the quality assurance program for valves or pumps as specified in §§63.175(e)(7) and 63.176(d)(7) of this subpart.

(7) Records indicating that all valves or pumps replaced or modified during the period of the quality improvement program are in compliance with the quality assurance requirements in §63.175(e)(7) and §63.176(d)(7) of this subpart.

(8) Records documenting compliance with the 20 percent or greater annual replacement rate for pumps as specified in §63.176(d)(8) of this subpart.

(9) Information and data to show the corporation has fewer than 100 employees, including employees providing professional and technical contracted services.

(i) The owner or operator of equipment in heavy liquid service shall comply with the requirements of either paragraph (i)(1) or (i)(2) of this section, as provided in paragraph (i)(3) of this section.

(1) Retain information, data, and analyses used to determine that a piece of equipment is in heavy liquid service.

(2) When requested by the Administrator, demonstrate that the piece of equipment or process is in heavy liquid service.

(3) A determination or demonstration that a piece of equipment or process is in heavy liquid service shall include an analysis or demonstration that the process fluids do not meet the definition of "in light liquid service." Examples of information that could document this include, but are not limited to, records of chemicals purchased for the process, analyses of process stream composition, engineering calculations, or process knowledge.

(j) Identification, either by list, location (area or group) of equipment in organic HAP service less than 300 hours per year within a process unit subject to the provisions of this subpart under §63.160 of this subpart.

(k) Owners and operators choosing to comply with the requirements of §63.179 of this subpart shall maintain the following records:

(1) Identification of the process unit(s) and the organic HAP's they handle.

(2) A schematic of the process unit, enclosure, and closed-vent system.

(3) A description of the system used to create a negative pressure in the enclosure to ensure that all emissions are routed to the control device.

[59 FR 19568, Apr. 22, 1994, as amended at 59 FR 48177, Sept. 20, 1994; 60 FR 18030, Apr. 10, 1995; 61 FR 31441, June 20, 1996; 62 FR 2792, Jan. 17, 1997; 64 FR 20198, Apr. 26, 1999; 68 FR 37344, June 23, 2003]

### **§63.182 Reporting requirements.**

(a) Each owner or operator of a source subject to this subpart shall submit the reports listed in paragraphs (a)(1) through (a)(5) of this section. Owners or operators requesting an extension of compliance shall also submit the report listed in paragraph (a)(6) of this section.

(1) An Initial Notification described in paragraph (b) of this section, and

(2) A Notification of Compliance Status described in paragraph (c) of this section,

(3) Periodic Reports described in paragraph (d) of this section, and

(4)-(5) [Reserved]

(6) Pursuant to section 112(i)(3)(B) of the Act, an owner or operator may request an extension allowing an existing source up to 1 additional year beyond the compliance date specified in the subpart that references this subpart.

(i) For purposes of this subpart, a request for an extension shall be submitted to the operating permit authority as part of the operating permit application. If the State in which the source is located does not have an approved operating permit program, a request for an extension shall be submitted to the Administrator as a separate submittal. The dates specified in §63.6(i) of subpart A of this part for submittal of requests for extensions shall not apply to sources subject to this subpart.

(ii) A request for an extension of compliance must include the data described in §63.6(i)(6)(i) (A), (B), and (D) of subpart A of this part.

(iii) The requirements in §63.6(i)(8) through (i)(14) of subpart A of this part will govern the review and approval of requests for extensions of compliance with this subpart.

(b) Each owner or operator of an existing or new source subject to the provisions of this subpart shall submit a written Initial Notification to the Administrator, containing the information described in paragraph (b)(1), according to the schedule in paragraph (b)(2) of this section. The Initial Notification provisions in §63.9(b)(1) through (b)(3) of subpart A of this part shall not apply to owners or operators of sources subject to this subpart.

(1) The Initial Notification shall include the following information:

(i) The name and address of the owner or operator;

(ii) The address (physical location) of the affected source;

(iii) An identification of the chemical manufacturing processes subject to this subpart; and

(iv) A statement of whether the source can achieve compliance by the applicable compliance date specified in the subpart in 40 CFR part 63 that references this subpart.

(2) The Initial Notification shall be submitted according to the schedule in paragraph (b)(2)(i), (b)(2)(ii), or (b)(2)(iii) of this section, as applicable.

(i) For an existing source, the Initial Notification shall be submitted within 120 days after the date of promulgation of the subpart that references this subpart.

(ii) For a new source that has an initial start-up 90 days after the date of promulgation of this subpart or later, the application for approval of construction or reconstruction required by §63.5(d) of subpart A of this part shall be submitted in lieu of the Initial Notification. The application shall be submitted as soon as practicable before the construction or reconstruction is planned to commence (but it need not be sooner than 90 days after the date of promulgation of the subpart that references this subpart).

(iii) For a new source that has an initial start-up prior to 90 days after the date of promulgation of the applicable subpart, the Initial Notification shall be submitted within 90 days after the date of promulgation of the subpart that references this subpart.

(c) Each owner or operator of a source subject to this subpart shall submit a Notification of Compliance Status within 90 days after the compliance dates specified in the subpart in 40 CFR part 63 that references this subpart, except as provided in paragraph (c)(4) of this section.

(1) The notification shall provide the information listed in paragraphs (c)(1)(i) through (c)(1)(iv) of this section for each process unit subject to the requirements of §63.163 through §63.174 of this subpart.

(i) Process unit identification.

(ii) Number of each equipment type (e.g., valves, pumps) excluding equipment in vacuum service.

(iii) Method of compliance with the standard (for example, "monthly leak detection and repair" or "equipped with dual mechanical seals").

(iv) Planned schedule for each phase of the requirements in §63.163 and §63.168 of this subpart.

(2) The notification shall provide the information listed in paragraphs (c)(2)(i) and (c)(2)(ii) of this section for each process unit subject to the requirements of §63.178(b) of this subpart.

(i) Batch products or product codes subject to the provisions of this subpart, and

(ii) Planned schedule for pressure testing when equipment is configured for production of products subject to the provisions of this subpart.

(3) The notification shall provide the information listed in paragraphs (c)(3)(i) and (c)(3)(ii) of this section for each process unit subject to the requirements in §63.179 of this subpart.

(i) Process unit identification.

(ii) A description of the system used to create a negative pressure in the enclosure and the control device used to comply with the requirements of §63.172 of this subpart.

(4) For existing sources subject to subpart F of this part, the Notification of Compliance Status shall



be submitted for the group of process units with the earliest compliance date specified in §63.100(k) of subpart F of this part, by no later than 90 days after the compliance date for that group. The Notification of Compliance Status for each subsequent group shall be submitted as part of the first periodic report that is due not less than 90 days after the compliance date for that group.

(d) The owner or operator of a source subject to this subpart shall submit Periodic Reports.

(1) A report containing the information in paragraphs (d)(2), (d)(3), and (d)(4) of this section shall be submitted semiannually starting 6 months after the Notification of Compliance Status, as required in paragraph (c) of this section. The first periodic report shall cover the first 6 months after the compliance date specified in §63.100(k)(3) of subpart F. Each subsequent periodic report shall cover the 6 month period following the preceding period.

(2) For each process unit complying with the provisions of §63.163 through §63.174 of this subpart, the summary information listed in paragraphs (i) through (xvi) of this paragraph for each monitoring period during the 6-month period.

(i) The number of valves for which leaks were detected as described in §63.168(b) of this subpart, the percent leakers, and the total number of valves monitored;

(ii) The number of valves for which leaks were not repaired as required in §63.168(f) of this subpart, identifying the number of those that are determined nonrepairable;

(iii) The number of pumps for which leaks were detected as described in §63.163(b) of this subpart, the percent leakers, and the total number of pumps monitored;

(iv) The number of pumps for which leaks were not repaired as required in §63.163(c) of this subpart;

(v) The number of compressors for which leaks were detected as described in §63.164(f) of this subpart;

(vi) The number of compressors for which leaks were not repaired as required in §63.164(g) of this subpart;

(vii) The number of agitators for which leaks were detected as described in §63.173(a) and (b) of this subpart;

(viii) The number of agitators for which leaks were not repaired as required in §63.173(c) of this subpart;

(ix) The number of connectors for which leaks were detected as described in §63.174(a) of this subpart, the percent of connectors leaking, and the total number of connectors monitored;

(x) [Reserved]

(xi) The number of connectors for which leaks were not repaired as required in §63.174(d) of this subpart, identifying the number of those that are determined nonrepairable;

(xii) [Reserved]

(xiii) The facts that explain any delay of repairs and, where appropriate, why a process unit

shutdown was technically infeasible.

(xiv) The results of all monitoring to show compliance with §§63.164(i), 63.165(a), and 63.172(f) of this subpart conducted within the semiannual reporting period.

(xv) If applicable, the initiation of a monthly monitoring program under §63.168(d)(1)(i) of this subpart, or a quality improvement program under either §§63.175 or 63.176 of this subpart.

(xvi) If applicable, notification of a change in connector monitoring alternatives as described in §63.174(c)(1) of this subpart.

(xvii) If applicable, the compliance option that has been selected under §63.172(n).

(3) For owners or operators electing to meet the requirements of §63.178(b) of this subpart, the report shall include the information listed in paragraphs (i) through (v) of this paragraph for each process unit.

(i) Batch product process equipment train identification;

(ii) The number of pressure tests conducted;

(iii) The number of pressure tests where the equipment train failed the pressure test;

(iv) The facts that explain any delay of repairs; and

(v) The results of all monitoring to determine compliance with §63.172(f) of this subpart.

(4) The information listed in paragraph (c) of this section for the Notification of Compliance Status for process units with later compliance dates. Any revisions to items reported in earlier Notification of Compliance Status, if the method of compliance has changed since the last report.

[59 FR 19568, Apr. 22, 1994, as amended at 59 FR 48178, Sept. 20, 1994; 60 FR 18030, Apr. 10, 1995; 60 FR 63631, Dec. 12, 1995; 62 FR 2792, Jan. 17, 1997]

### **§63.183 Implementation and enforcement.**

(a) This subpart can be implemented and enforced by the U.S. EPA, or a delegated authority such as the applicable State, local, or Tribal agency. If the U.S. EPA Administrator has delegated authority to a State, local, or Tribal agency, then that agency, in addition to the U.S. EPA, has the authority to implement and enforce this subpart. Contact the applicable U.S. EPA Regional Office to find out if implementation and enforcement of this subpart is delegated to a State, local, or Tribal agency.

(b) In delegating implementation and enforcement authority of this subpart to a State, local, or Tribal agency under subpart E of this part, the authorities contained in paragraph (c) of this section are retained by the Administrator of U.S. EPA and cannot be transferred to the State, local, or Tribal agency.

(c) The authorities that cannot be delegated to State, local, or Tribal agencies are as specified in paragraphs (c)(1) through (4) of this section.

(1) Approval of alternatives to the requirements in §§63.160, 63.162 through 63.176, 63.178 through 63.179. Follow the applicable procedures of §63.177 to request an alternative means of emission limitation for batch processes and enclosed-vented process units. Where these standards reference

another subpart, the cited provisions will be delegated according to the delegation provisions of the referenced subpart. Where these standards reference another subpart and modify the requirements, the requirements shall be modified as described in this subpart. Delegation of the modified requirements will also occur according to the delegation provisions of the referenced subpart.

(2) Approval of major alternatives to test methods under §63.7(e)(2)(ii) and (f), as defined in §63.90, and as required in this subpart.

(3) Approval of major alternatives to monitoring under §63.8(f), as defined in §63.90, and as required in this subpart.

(4) Approval of major alternatives to recordkeeping and reporting under §63.10(f), as defined in §63.90, and as required in this subpart.

[68 FR 37345, June 23, 2003]

**Table 1 to Subpart H of Part 63—Batch Processes**

Monitoring Frequency for Equipment Other than Connectors

| Operating time (% of year) | Equivalent continuous process monitoring frequency time in use |              |               |
|----------------------------|--|--------------|---------------|
|                            | Monthly  | Quarterly    | Semiannually  |
| 0 to <25                   | Quarterly  | Annually     | Annually.     |
| 25 to <50                  | Quarterly  | Semiannually | Annually.     |
| 50 to <75                  | Bimonthly  | Three times  | Semiannually. |
| 75 to 100                  | Monthly  | Quarterly    | Semiannually. |

**Table 2 to Subpart H of Part 63—Surge Control Vessels and Bottoms Receivers at Existing Sources**

| Vessel capacity (cubic meters)  | Vapor pressure <sup>1</sup> (kilopascals) |
|---------------------------------|---|
| $75 \leq \text{capacity} < 151$ | $\geq 13.1$                               |
| $151 \leq \text{capacity}$      | $\geq 5.2^a$                              |

<sup>1</sup>Maximum true vapor pressure of total organic HAP at operating temperature as defined in subpart G of this part.

[60 FR 18025, Apr. 10, 1995]

**Table 3 to Subpart H of Part 63—Surge Control Vessels and Bottoms Receivers at New Sources**

| Vessel capacity (cubic meters)  | Vapor pressure <sup>1</sup> (kilopascals) |
|---------------------------------|---|
| $38 \leq \text{capacity} < 151$ | $\geq 13.1$                               |

|               |      |
|---------------|------|
| 151 ≤capacity | ≥0.7 |
|---------------|------|

<sup>1</sup>Maximum true vapor pressure of total organic HAP at operating temperature as defined in subpart G of this part.

[60 FR 18025, Apr. 10, 1995]

**Table 4 to Subpart H of Part 63—Applicable 40 CFR Part 63 General Provisions**

| <b>40 CFR part 63, subpart A, provisions applicable to subpart H</b>                            |
|---|
| §63.1(a)(1), (a)(2), (a)(3), (a)(13), (a)(14), (b)(2) and (c)(4)                                |
| §63.2   |
| §63.5(a)(1), (a)(2), (b), (d)(1)(ii), (d)(4), (e), (f)(1) and (f)(2)                            |
| §63.6(a), (b)(3), (c)(5), (i)(1), (i)(2), (i)(4)(i)(A), (i)(5) through (i)(14), (i)(16) and (j) |
| §63.9(a)(2), (b)(4)(i) <sup>a</sup> , (b)(4)(ii), (b)(4)(iii), (b)(5)a, (c) and (d)             |
| §63.10(d)(4)  |
| §63.11 (c), (d), and (e)  |
| §63.12(b)   |

<sup>a</sup>The notifications specified in §63.9(b)(4)(i) and (b)(5) shall be submitted at the times specified in 40 CFR part 65.

[65 FR 78285, Dec. 14, 2000, as amended at 73 FR 78213, Dec. 22, 2008]

**Appendix F**

40 C.F.R. Part 63, Subpart W – *National Emission Standards for Hazardous Air Pollutants for Epoxy Resins Production and Non - Nylon Polyamides Production*

## Subpart W—National Emission Standards for Hazardous Air Pollutants for Epoxy Resins Production and Non-Nylon Polyamides Production

SOURCE: 60 FR 12676, Mar. 8, 1995, unless otherwise noted.

### §63.520 Applicability and designation of sources.

The provisions of this subpart apply to all existing, new, and reconstructed manufacturers of basic liquid epoxy resins (BLR) and manufacturers of wet strength resins (WSR) that are located at a plant site that is a major source, as defined in section 112(a) of the Clean Air Act. Research and development facilities, as defined in §63.522, are exempt from the provisions of this subpart. The affected source is also defined in §63.522. If a change occurs to an existing source that does not constitute reconstruction then the additions have to meet the existing source requirements of the MACT standards. Any reconstruction of an existing source, or construction of a new source, must meet the new source standard. Affected sources are also subject to certain requirements of subpart A of this part, as specified in Table 1 of this subpart.

### §63.521 Compliance schedule.

(a) Owners or operators of existing affected BLR and WSR sources shall comply with the applicable provisions of this subpart within 3 years of the promulgation date.

(b) New and reconstructed sources subject to this subpart shall be in compliance with the applicable provisions of this subpart upon startup.

### §63.522 Definitions.

Terms used in this subpart are defined in the Act, in subpart A of this part, or in this section as follows:

*Administrator* means the Administrator of the U.S. Environmental Protection Agency, or any official designee of the Administrator.

*Affected source* means all HAP emission points within a facility that are related to the production of BLR or WSR, including process vents, storage tanks, wastewater systems, and equipment leaks.

*Basic liquid epoxy resins (BLR)* means resins made by reacting epichlorohydrin and bisphenol A to form diglycidyl ether of bisphenol-A (DGEBA).

*Batch emission episode* means a discrete venting episode that may be associated with a single unit operation. For example, a displacement of vapor resulting from the charging of a vessel with HAP will result in a discrete emission episode that will last through the duration of the charge and will have an average flow rate equal to the rate of the charge. If the vessel is then

heated, there will also be another discrete emission episode resulting from the expulsion of expanded vessel vapor space. Both emission episodes may occur in the same vessel or unit operation. There are possibly other emission episodes that may occur from the vessel or other process equipment, depending on process operations.

*Batch process* refers to a discontinuous process involving the bulk movement of material through sequential manufacturing steps. Mass, temperature, concentration, and other properties of a system vary with time. Addition of raw material and withdrawal of product do not typically occur simultaneously in a batch process.

*Closed-vent system* means a system that is not open to the atmosphere and is composed of piping, ductwork, connections, and, if necessary, flow-inducing devices that transport gas or vapor from an emission point to a control device or back into the process.

*Continuous process* means a process where the inputs and outputs flow continuously throughout the duration of the process. Continuous processes are typically steady-state.

*Drain system* means the system used to convey wastewater streams from a process unit, product storage tank, or feed storage tank to a waste management unit. The term includes all process drains and junction boxes, together with their associated sewer lines and other junction boxes, manholes, sumps, and lift stations, down to the receiving waste management unit. A segregated stormwater sewer system, which is a drain and collection system designed and operated for the sole purpose of collecting rainfall-runoff at a facility, and which is segregated from all other drain systems, is excluded from this definition.

*Equipment leaks* means emissions of hazardous air pollutants from a connector, pump, compressor, agitator, pressure relief device, sampling connection system, open-ended valve or line, or instrumentation system in organic hazardous air pollutant service.

*Process vent* means a point of emission from a unit operation. Typical process vents include condenser vents, vacuum pumps, steam ejectors, and atmospheric vents from reactors and other process vessels.

*Production-based emission rate* means a ratio of the amount of HAP emitted to the amount of BLR or WSR produced.

*Research and development facility* means laboratory operations whose primary purpose is to conduct research and development into new processes and products, where the operations are under the close supervision of technically trained personnel, and is not engaged in the manufacture of products for commercial sale, except in a de minimis manner.

*Storage tank* means a tank or other vessel that is used to store liquids that contain one or more HAP compounds.

*Unit operation* means those processing steps that occur within distinct equipment that are used, among other things, to prepare reactants, facilitate reactions, separate and purify products,

and recycle materials. There may be several emission episodes within a single unit operation.

*Waste management unit* means any component, piece of equipment, structure, or transport mechanism used in storing, treating, or disposing of wastewater streams, or conveying wastewater between storage, treatment, or disposal operations.

*Wastewater* means aqueous liquid waste streams exiting equipment at an affected source.

*Wastewater system* means a system made up of a drain system and one or more waste management units.

*Wet strength resins (WSR)* means polyamide/ epichlorohydrin condensates which are used to increase the tensile strength of paper products.

[60 FR 12676, Mar. 8, 1995, as amended at 65 FR 26497, May 8, 2000]

**§63.523 Standards for basic liquid resins manufacturers.**

(a) Owners or operators of existing affected BLR sources shall operate sources such that the rate of emissions of hazardous air pollutants from all process vents, storage tanks, and wastewater systems combined shall not exceed 130 pounds per 1 million pounds of BLR produced.

(b) Owners or operators of new or reconstructed affected BLR sources shall reduce uncontrolled emissions from the sum of uncontrolled process vents, storage tanks, and wastewater systems by 98 percent, or limit the total emissions from these emission points to 5,000 pounds per year.

(1) For process vents, uncontrolled emissions are defined as gaseous emission streams past the last recovery device.

(2) For storage tanks, uncontrolled emissions are defined as emissions calculated according to the methodology specified in §63.150(g)(3).

(3) For wastewater systems, uncontrolled emissions are the total amount of HAP discharged to the drain system.

(c) Owners or operators of existing, new, or reconstructed affected BLR sources shall comply with the requirements of subpart H of this part to control emissions from equipment leaks.

**§63.524 Standards for wet strength resins manufacturers.**

(a) Owners or operators of existing affected WSR sources shall either:

(1) Limit the total emissions of hazardous air pollutants from all process vents, storage



tanks, and wastewater systems to 10 pounds per 1 million pounds of wet strength resins produced; or

(2) Comply with the requirements of subpart H of this part to control emissions from equipment leaks.

(b) Owners or operators of new or reconstructed affected WSR sources shall either:

(1) Limit the total emissions of hazardous air pollutants from all process vents, storage tanks, and wastewater systems to 7 pounds per 1 million pounds of wet strength resins produced; or

(2) Comply with the requirements of subpart H of this part to control emissions from equipment leaks.

**§63.525 Compliance and performance testing.**

(a) The owner or operator of any existing affected BLR source shall, in order to demonstrate initial compliance with the applicable emission limit, determine the emission rate from all process vent, storage tank, and wastewater system emission points using the methods described below. Compliance tests shall be performed under normal operating conditions.

(1) The owner or operator shall use the EPA Test Methods from 40 CFR part 60, appendix A, listed in paragraphs (a)(1) (i) through (iii) of this section, to determine emissions from process vents. Testing of process vents on equipment operating as part of a continuous process will consist of conducting three 1-hour runs. Gas stream volumetric flow rates shall be measured every 15 minutes during each 1-hour run. Organic HAP or TOC concentration shall be determined from samples collected in an integrated sample over the duration of each 1-hour test run, or from grab samples collected simultaneously with the flow rate measurements (every 15 minutes). If an integrated sample is collected for laboratory analysis, the sampling rate shall be adjusted proportionally to reflect variations in flow rate. If the flow of gaseous emissions is intermittent, determination of emissions from process vents shall be performed according to the methods specified in paragraph (e) of this section. For process vents with continuous gas streams, the emission rate used to determine compliance shall be the average emission rate of the 3 test runs. For process vents with intermittent emission streams, the calculated emission rate or the emission rate from a single test run may be used to determine compliance.

(i) Method 1 or 1A of 40 CFR part 60, appendix A, as appropriate, shall be used for selection of the sampling sites if the flow measuring device is a pitot tube. A traverse shall be conducted before and after each 1-hour sampling period. No traverse is necessary when using Method 2A or 2D to determine flow rate.

(ii) Method 2, 2A, 2C or 2D of 40 CFR part 60, appendix A, as appropriate, shall be used for the determination of gas stream volumetric flow rate. If Method 2 or 2C is used, the velocity measurements shall be made at a single point, in conjunction with the traverse, to establish an

average velocity across the stack.

(iii) Method 25A and/or Methods 18 and 25A of 40 CFR part 60, appendix A, as appropriate, shall be used to determine the concentration of HAP in the streams.

(iv) Initial determination of de minimis status for process vents may be made by engineering assessment, as specified in §63.526(a)(1)(iv).

(2) Emissions from wastewater treatment systems shall be determined in accordance with the methods described in 40 CFR part 63, appendix C.

(3) Emissions from storage tanks shall be calculated in accordance with the methods specified in §63.150(g)(3).

(b) The owner or operator of any existing affected BLR source shall determine a production-based emission rate for each emission point by dividing the emission rate of each emission point by the BLR production rate of the source. The production rate shall be based on normal operations.

(1) The production-based emission rate for process vents shall be calculated by dividing the average emission rate the average production rate.

(2) The production-based emission rate for storage tanks shall be calculated by dividing annual emissions for each storage tank emission point by the production rate for a one-year period. The production rate shall be calculated using the same data used to calculate the production-based emission rate in paragraph (b)(1) of this section, converted to an annual rate.

(3) The production-based emission rate for wastewater systems shall be calculated by dividing annual emissions for each wastewater system emission point by the production rate for one-year period. The production rate shall be calculated using the same data used to calculate the production-based emission rate in paragraph (b)(1) of this section, converted to an annual rate.

(c) The owner or operator of an existing affected BLR source shall calculate the total emissions per product produced by summing the production-based emissions for all process vent, storage tank, and wastewater system emission points according to the following equation:

$$E = \sum PV + \sum ST + \sum WW$$

where:

E = emissions, pounds (lb) HAP per million (MM) lb product;

PV = process vent emissions, lb HAP/MM lb product;

ST = storage tank emissions, lb HAP/MM lb product; and

WW = wastewater system emissions, lb HAP/MM lb product.

The source is in compliance with the standard for process vents, storage tanks, and wastewater systems if the sum of the equation is less than the applicable emission limit from §63.523(a).

(d) The owner or operator of any new or reconstructed affected BLR source shall demonstrate compliance using the methods described in this section.

(1) Any owner or operator who elects to comply with §63.523(b) by achieving 98 percent control of emissions from process vents, storage tanks, and wastewater systems shall demonstrate compliance according to the requirements of paragraphs (d)(1) (i) through (iv) of this section.

(i) The owner or operator shall perform testing as specified in paragraph (a)(1) of this section to determine controlled and uncontrolled emissions from process vents. Sampling points for determining uncontrolled emissions shall be located based on the definition of uncontrolled process vents in §63.523(b)(1).

(ii) The owner or operator shall calculate controlled and uncontrolled emissions from storage tanks in accordance with the methods specified in §63.150(g)(3).

(iii) The owner or operator shall determine controlled and uncontrolled emissions from wastewater systems using the methodology of 40 CFR part 63, appendix C. Uncontrolled emission calculations shall be consistent with the definition of uncontrolled wastewater system emissions in §63.523(b)(3).

(iv) The owner or operator shall calculate the percent reduction in emissions from process vents, storage tanks, and wastewater systems combined. The affected source is in compliance if the emission reduction is greater than or equal to 98 percent.

(2) Any owner or operator who elects to comply with §63.523(b) by limiting HAP emissions from process vents, storage tanks, and wastewater systems to 5,000 pounds per year or less shall demonstrate compliance according to the requirements of paragraphs (d)(2) (i) and (ii) of this section.

(i) Emissions from process vents, storage tanks, and wastewater systems shall be determined according to paragraphs (a) (1) through (3) of this section. Emissions shall be converted to annual emissions. Annual emission calculations shall reflect production levels representative of normal operating conditions.

(ii) The owner or operator shall calculate total emissions from all process vent, storage tank, and wastewater system emission points. The affected source is in compliance with the standard if total emissions are less than or equal to 5,000 lb/yr.

(e) The owner or operator of any existing, new, or reconstructed WSR source that chooses to comply with the emission limit for process vents, storage tanks, and wastewater systems shall

demonstrate initial compliance by determining emissions for all process vent, storage tank, and wastewater systems emission points using the methods described in this section.

(1) Emissions of HAP reactor process vents shall be calculated for each batch emission episode according to the methodologies described in paragraph (e)(1) of this section.

(i) Emissions from vapor displacement due to transfer of material into or out of the reactor shall be calculated according to the following equation:

$$E = \frac{(y_i)(V)(P_r)(MW)}{(R)(T)}$$

where:

E = mass emission rate;

y<sub>i</sub> = saturated mole fraction of HAP in the vapor phase;

V = volume of gas displaced from the vessel;

R = ideal gas law constant;

T = temperature of the vessel vapor space; absolute;

P<sub>r</sub> = pressure of the vessel vapor space; and

MW = molecular weight of the HAP.

(ii) Emissions from reactor purging shall be calculated using the methodology described in paragraph (e)(1)(i) of this section, except that for purge flow rates greater than 100 standard cubic feet per minute (scfm), the mole fraction of HAP will be assumed to be 25 percent of the saturated value.

(iii) Emissions caused by heating of the reactor vessel shall be calculated according to the following methodology:

$$E = \frac{\sum (P_i)_{T1} + \sum (P_i)_{T2}}{2} \times \Delta T \times MW_{HAP}$$

where:

E = mass of HAP vapor displaced from the vessel being heated up;

(P<sub>i</sub>)<sub>Tn</sub> = partial pressure of each HAP in the vessel headspace at initial (n = 1) and final (n = 2) temperature;

Pa<sub>1</sub> = initial gas pressure in the vessel;

Pa<sub>2</sub> = final gas pressure; and

MW<sub>HAP</sub> = the average molecular weight of HAP present in the vessel.

The moles of gas displaced is represented by:

$$\Delta\eta = \frac{V}{R} \left[ \left( \frac{Pa_1}{T_1} \right) - \left( \frac{Pa_2}{T_2} \right) \right]$$

where:

$\Delta\eta$  = number of lb-moles of gas displaced;

V = volume of free space in the vessel;

R = ideal gas law constant;

$Pa_1$  = initial gas pressure in the vessel;

$Pa_2$  = final gas pressure;

$T_1$  = initial temperature of vessel; and

$T_2$  = final temperature of vessel.

The initial pressure of the noncondensable gas in the vessel shall be calculated according to the following equation:

$$Pa_1 = P_{atm} - \sum (P_k)_{T_1}$$

where:

$Pa_1$  = initial partial pressure of gas in the vessel headspace;

$P_{atm}$  = atmospheric pressure; and

$(P_k)_{T_1}$  = initial partial pressure of each condensable volatile organic compound (including HAP) in the vessel headspace, at the initial temperature ( $T_1$ ).

The average molecular weight of HAP in the displaced gas shall be calculated as follows:

$$MW_{HAP} = \frac{\sum_{i=1}^n (\text{mass of HAP})_i}{\sum_{i=1}^n \frac{(\text{mass of HAP})_i}{(\text{HAP molecular weight})_i}}$$

where n is the number of different HAP compounds in the emission stream.

(2) Emissions of HAP from process vents may be measured directly. The EPA Test Methods listed in paragraph (e)(2) (i) through (iii) of this section, from 40 CFR part 60, appendix A, shall be used to demonstrate compliance with the requirements of §63.524 by direct measurement. Testing shall be performed for every batch emission episode of the unit operation. Gas stream volumetric flow rates shall be measured at 15-minute intervals, or at least once during each batch emission episode. Organic HAP or TOC concentration shall be determined

from samples collected in an integrated sample over the duration of each episode, or from grab samples collected simultaneously with the flow rate measurements (every 15 minutes). If an integrated sample is collected for laboratory analysis, the sampling rate shall be adjusted proportionally to reflect variations in flow rate. Test conditions shall represent the normal operating conditions under which the data used to calculate the production rate are taken.

(i) Method 1 or 1A of 40 CFR part 60, appendix A, as appropriate, shall be used for selection of the sampling sites if the flow measuring device is a pitot tube. A traverse shall be conducted before and after each sampling period. No traverse is necessary when using Method 2A or 2D.

(ii) Method 2, 2A, 2C or 2D of 40 CFR part 60, appendix A, as appropriate, shall be used for the determination of gas stream volumetric flow rate. If Method 2 or 2C is used, the velocity measurements shall be made at a single point than can be used, in conjunction with the traverse, to establish an average velocity across the stack.

(iii) Method 25A and/or Methods 18 and 25A of 40 CFR part 60, appendix A, as appropriate, shall be used to determine the concentration of HAP in the streams.

(iv) The owner or operator may choose to perform tests only during those periods of the episode in which the emission rate for the entire episode can be determined, or when the emissions are greater than the average emission rate of the episode. The owner or operator who chooses either of these options must develop an emission profile for the entire batch emission episode, based on either process knowledge or test data collected, to demonstrate that test periods are representative. Examples of information that could constitute process knowledge include calculations based on material balances, and process stoichiometry. Previous test results may be used provided the results are still relevant to the current process vent stream conditions.

(v) For batch emission episodes of duration greater than 8 hours, the owner or operator is required to perform a maximum of 8 hours of testing. The test period must include the period of time in which the emission rate is predicted by the emission profile to be greater than average emission rate for the batch emission episode.

(f) The owner or operator of any affected WSR source that chooses to comply with the emissions limit for process vents, storage tanks, and wastewater systems shall calculate emissions from storage tanks in accordance with the methods specified in §63.150(g)(3).

(g) The owner or operator of any affected WSR source that chooses to comply with the emission limit for process vents, storage tanks, and wastewater systems shall calculate emissions from wastewater treatment systems (if applicable) in accordance with the methods described in 40 CFR part 63, appendix C.

(h) The owner or operator of any affected WSR source that chooses to comply with the emission limit for process vents, storage tanks, and wastewater systems shall calculate the average amount of WSR product manufactured per batch, using data from performance tests or from emission calculations, as applicable, to determine the average WSR production per-batch

production data for an annual period representing normal operating conditions.

(1) The owner or operator shall calculate an average emission rate per batch as the average of the results from the performance tests or calculations. The production-based emission rate shall be calculated by dividing the emissions per batch by the average production per batch.

(2) Compliance shall be determined according to the methodology described in paragraph (c) of this section. The source is in compliance with the standard for process vents, storage tanks, and wastewater systems if the sum of the equation in paragraph (c) of this section is less than the applicable emission limit from §63.524.

(i) The owner or operator of any affected BLR source or any affected WSR source that chooses to comply with the requirements of subpart H of this part must demonstrate the ability of its specific program to meet the compliance requirements therein to achieve initial compliance.

**§63.526 Monitoring requirements.**

(a) The owner or operator of any existing, new, or reconstructed affected BLR source shall provide evidence of continued compliance with the standard. During the initial compliance demonstration, maximum or minimum operating parameters, as appropriate, shall be established for processes and control devices that will indicate the source is in compliance. If the operating parameter to be established is a maximum, the value of the parameter shall be the average of the maximum values from each of the three test runs. If the operating parameter to be established is a minimum, the value of the parameter shall be the average of the minimum values from each of the three test runs. Parameter values for process vents with intermittent emission streams shall be determined as specified in paragraph (b)(1) of this section. The owner or operator shall operate processes and control devices within these parameters to ensure continued compliance with the standard. A de minimis level is specified in paragraph (a)(1) of this section. Monitoring parameters are specified for various process vent control scenarios in paragraphs (a) (2) through (6) of this section.

(1) For affected BLR sources, uncontrolled emission points emitting less than one pound per year of HAP are not subject to the monitoring requirements of paragraphs (a) (2) through (6) of this section. The owner or operator shall use the methods specified in §63.525(a), as applicable, or as specified in paragraph (a)(1)(i) of this section, to demonstrate which emission points satisfy the de minimis criteria, to the satisfaction of the Administrator.

(i) For the purpose of determining de minimis status for emission points, engineering assessment may be used to determine process vent stream flow rate and/or concentration for the representative operating conditions expected to yield the highest flow rate and concentration. Engineering assessment includes, but is not limited to, the following:

(A) Previous test results provided the tests are representative of current operating practices at the process unit.

(B) Bench-scale or pilot-scale test data representative of the process under representative

operating conditions.

(C) Maximum flow rate, HAP emission rate, concentration, or other relevant parameter specified or implied within a permit limit applicable to the process vent.

(D) Design analysis based on accepted chemical engineering principles, measurable process parameters, or physical or chemical laws or properties. Examples of analytical methods include, but are not limited to:

(1) Use of material balances based on process stoichiometry to estimate maximum organic HAP concentrations,

(2) Estimation of maximum flow rate based on physical equipment design such as pump or blower capacities,

(3) Estimation of HAP concentrations based on saturation conditions.

(ii) All data, assumptions, and procedures used in the engineering assessment shall be documented in accordance with §63.527(c).

(2) For affected sources using water scrubbers, the owner or operator shall establish a minimum scrubber water flow rate as a site-specific operating parameter which must be measured and recorded every 15 minutes. The affected source will be considered to be out of compliance if the scrubber water flow rate, averaged over any continuous 24-hour period, is below the minimum value established during the initial compliance demonstration.

(3) For affected sources using condensers, the owner or operator shall establish the maximum condenser outlet gas temperature as a site-specific operating parameter which must be measured and recorded every 15 minutes. The affected source will be considered to be out of compliance if the condenser outlet gas temperature, averaged over any continuous 24-hour period, is greater than the maximum value established during the initial compliance demonstration.

(4) For affected sources using carbon adsorbers or having uncontrolled process vents, the owner or operator shall establish a maximum outlet HAP concentration as the site-specific operating parameter which must be measured and recorded every 15 minutes. The affected source will be considered to be out of compliance if the outlet HAP concentration, averaged over any continuous 24-hour period, is greater than the maximum value established during the initial compliance demonstration.

(5) For affected sources using flares, the presence of the pilot flame shall be monitored every 15 minutes. The affected source will be considered to be out of compliance upon loss of pilot flame.

(6) Wastewater system parameters to be monitored are the parameters specified under 40 CFR part 414, subpart E. The affected source will be considered to be out of compliance with



this subpart W if it is found to be out of compliance with 40 CFR part 414, subpart E.

(b) The owner or operator of any existing, new, or reconstructed affected WSR source that chooses to comply with the emission limit for process vents, storage tanks, and wastewater systems shall provide evidence of continued compliance with the standard. As part of the initial compliance demonstrations for batch process vents, test data or compliance calculations shall be used to establish a maximum or minimum level of a relevant operating parameter for each unit operation. The parameter value for each unit operation shall represent the worst case value of the operating parameter from all episodes in the unit operation. The owner or operator shall operate processes and control devices within these parameters to ensure continued compliance with the standard.

(1) For batch process vents, the level shall be established in accordance with paragraphs (b)(1) (i) through (iv) of this section if compliance testing is performed.

(i) If testing is used to demonstrate initial compliance, the appropriate parameter shall be monitored during all batch emission episodes in the unit operation.

(ii) An average monitored parameter value shall be determined for each of the batch emission episodes in the unit operation.

(iii) If the level to be established for the unit operation is a maximum operating parameter, the level shall be defined as the minimum of the average parameter values determined in paragraph (b)(1)(ii) of this section.

(iv) If the level to be established for the unit operation is a minimum operating parameter, the level shall be defined as the maximum of the average parameter values determined in paragraph (b)(1)(ii) of this section.

(2) Affected sources with condensers on process vents shall establish the maximum condenser outlet gas temperature as a site-specific operating parameter, which must be measured every 15 minutes, or at least once for batch emission episodes less than 15 minutes in duration. The affected source will be considered to be out of compliance if the maximum condenser outlet gas temperature, averaged over the duration of the batch emission episode or unit operation, is greater than the value established during the initial compliance demonstration.

(3) For affected sources using water scrubbers, the owner or operator shall establish a minimum scrubber water flow rate as a site-specific operating parameter which must be measured and recorded every 15 minutes, or at least once for batch emission episodes less than 15 minutes in duration. The affected source will be considered to be out of compliance if the scrubber water flow rate, averaged over the duration of the batch emission episode or unit operation, is below the minimum flow rate established during the initial compliance demonstration.

(4) For affected sources using carbon adsorbers or having uncontrolled process vents, the owner or operator shall establish a maximum outlet HAP concentration as the site-specific

operating parameter which must be measured and recorded every 15 minutes, or at least once for batch emission episodes of duration shorter than 15 minutes. The affected source will be considered to be out of compliance if the outlet HAP concentration, averaged over the duration of the batch emission episode or unit operation, is greater than the value established during the initial compliance demonstration.

(5) For affected sources using flares, the presence of the pilot flame shall be monitored every 15 minutes, or at least once for batch emission episodes less than 15 minutes in duration. The affected source will be considered to be out of compliance upon loss of pilot flame.

(6) Wastewater system parameters to be monitored are the parameters specified by 40 CFR part 414, subpart E. The affected source will be considered to be out of compliance with this subpart W if it is found to be out of compliance with 40 CFR part 414, subpart E.

(c) Periods of time when monitoring measurements exceed the parameter values do not constitute a violation if they occur during a startup, shutdown, or malfunction, and the facility is operated in accordance with §63.6(e)(1).

(d) The owner or operator of any affected WSR source that chooses to comply with the requirements of subpart H of this part shall meet the monitoring requirements of subpart H of this part.

[60 FR 12676, Mar. 8, 1995, as amended at 71 FR 20457, Apr. 20, 2006]

**§63.527 Recordkeeping requirements.**

(a) The owner or operator of any affected BLR source shall keep records of daily average values of equipment operating parameters specified to be monitored under §63.526(a) or specified by the Administrator. Records shall be kept in accordance with the requirements of applicable paragraphs of §63.10 of subpart A of this part, as specified in the General Provisions applicability table of this subpart. The owner or operator shall keep records up-to-date and readily accessible.

(1) A daily (24-hour) average shall be calculated as the average of all values for a monitored parameter recorded during the operating day. The average shall cover a 24-hour period if operation is continuous, or the number of hours of operation per operating day if operation is not continuous.

(2) The operating day shall be the period defined in the operating permit or the Notification of Compliance Status in §63.9(h) of subpart A of this part. It may be from midnight to midnight or another continuous 24-hour period.

(3) In the event of an excursion, the owner or operator must keep records of each 15-minute reading during the period in which the excursion occurred.

(b) The owner or operator of any affected WSR source that elects to comply with the

emission limit for process vents, storage tanks, and wastewater systems shall keep records of values of equipment operating parameters specified to be monitored under §63.526(b) or specified by the Administrator. The records that shall be kept are the average values of operating parameters, determined for the duration of each unit operation. Records shall be kept in accordance with the requirements of applicable paragraphs of §63.10 of subpart A of this part, as specified in the General Provisions applicability table in this subpart. The owner or operator shall keep records up-to-date and readily accessible. In the event of an excursion, the owner or operator must keep records of each 15-minute reading for the entire unit operation in which the excursion occurred.

(c) The owner or operator of any affected BLR source, as well the owner or operator of any affected WSR source that chooses to comply with the emission limit for process vents, storage tanks, and wastewater systems, who demonstrates that certain process vents are below the de minimis cutoff for continuous monitoring specified in §63.526(a)(1)(i), shall maintain up-to-date, readily accessible records of the following information to document that a HAP emission rate of less than one pound per year is maintained:

(1) The information used to determine de minimis status for each de minimis process vent, as specified in §63.526(a)(1)(i);

(2) Any process changes as defined in §63.115(e) of subpart G of this part that increase the HAP emission rate;

(3) Any recalculation or measurement of the HAP emission rate pursuant to §63.115(e) of subpart G of this part; and

(4) Whether or not the HAP emission rate increases to one pound per year or greater as a result of the process change.

(d) The owner or operator of any affected BLR source, as well as the owner or operator of any affected WSR source who elects to implement the leak detection and repair program specified in subpart H of this part, shall implement the recordkeeping requirements outlined therein. All records shall be retained for a period of 5 years, in accordance with the requirements of 40 CFR 63.10(b)(1).

(e) Any excursion from the required monitoring parameter, unless otherwise excused, shall be considered a violation of the emission standard.

#### **§63.528 Reporting requirements.**

(a) The owner or operator of any affected BLR source, as well as the owner or operator of any affected WSR source that elects to comply with the emission limit for process vents, storage tanks, and wastewater systems, shall comply with the reporting requirements of applicable paragraphs of §63.10 of subpart A of this part, as specified in the General Provisions applicability table in this subpart. The owner or operator shall also submit to the Administrator, as part of the quarterly excess emissions and continuous monitoring system performance report

and summary report required by §63.10(e)(3) of subpart A of this part, the following recorded information.

(1) Reports of monitoring data, including 15-minute monitoring values as well as daily average values or per-unit operation average values, as applicable, of monitored parameters for all operating days or unit operations when the average values were outside the ranges established in the Notification of Compliance Status or operating permit.

(2) Reports of the duration of periods when monitoring data is not collected for each excursion caused by insufficient monitoring data. An excursion means any of the three cases listed in paragraph (a)(2)(i) or (a)(2)(ii) of this section. For a control device where multiple parameters are monitored, if one or more of the parameters meets the excursion criteria in paragraph (a)(2)(i) or (a)(2)(ii) of this section, this is considered a single excursion for the control device.

(i) When the period of control device operation is 4 hours or greater in an operating day and monitoring data are insufficient to constitute a valid hour of data, as defined in paragraph (a)(2)(iii) of this section, for at least 75 percent of the operating hours.

(ii) When the period of control device operation is less than 4 hours in an operating day and more than one of the hours during the period of operation does not constitute a valid hour of data due to insufficient monitoring data.

(iii) Monitoring data are insufficient to constitute a valid hour of data, as used in paragraphs (a)(2) (i) and (ii) of this section, if measured values are unavailable for any of the 15-minute periods within the hour.

(3) Whenever a process change, as defined in §63.115(e) of subpart G of this part, is made that causes the emission rate from a de minimis emission point to become a process vent with an emission rate of one pound per year or greater, the owner or operator shall submit a report within 180 calendar days after the process change. The report may be submitted as part of the next summary report required under §63.10(e)(3) of subpart A of this part. The report shall include:

(i) A description of the process change; and

(ii) The results of the recalculation of the emission rate.

(b) The owner or operator of any affected BLR source, as well as the owner or operator of any affected WSR source who elects to implement the leak detection and repair program specified in subpart H of this part, shall implement the reporting requirements outlined therein. Copies of all reports shall be retained as records for a period of 5 years, in accordance with the requirements of 40 CFR 63.10(b)(1).

(c) The owner or operator of any affected BLR source, as well as the owner or operator of any affected WSR source that elects to comply with the emission limit for process vents, storage tanks, and wastewater systems shall include records of wastewater system monitoring parameters

in the Notification of Compliance Status and summary reports required by subpart A of this part.

**§63.529 Implementation and enforcement.**

(a) This subpart can be implemented and enforced by the U.S. EPA, or a delegated authority such as the applicable State, local, or Tribal agency. If the U.S. EPA Administrator has delegated authority to a State, local, or Tribal agency, then that agency, in addition to the U.S. EPA, has the authority to implement and enforce this subpart. Contact the applicable U.S. EPA Regional Office to find out if implementation and enforcement of this subpart is delegated to a State, local, or Tribal agency.

(b) In delegating implementation and enforcement authority of this subpart to a State, local, or Tribal agency under subpart E of this part, the authorities contained in paragraph (c) of this section are retained by the Administrator of U.S. EPA and cannot be transferred to the State, local, or Tribal agency.

(c) The authorities that cannot be delegated to State, local, or Tribal agencies are as specified in paragraphs (c)(1) through (4) of this section.

(1) Approval of alternatives to the requirements in §§63.520, 63.521, 63.523, and 63.524. Where these standards reference another rule, the cited provisions in that rule will be delegated according to the delegation provisions of that rule.

(2) Approval of major alternatives to test methods for under §63.7(e)(2)(ii) and (f), as defined in §63.90, and as required in this subpart.

(3) Approval of major alternatives to monitoring under §63.8(f), as defined in §63.90, and as required in this subpart.

(4) Approval of major alternatives to recordkeeping and reporting under §63.10(f), as defined in §63.90, and as required in this subpart.

[68 FR 37350, June 23, 2003]

**Table 1 to Subpart W of Part 63—General Provisions Applicability to Subpart W**

| Reference   | Applies to subpart W |     |   | Comment                              |
|-------------|----------------------|-----|---|--------------------------------------|
|             | BLR                  | WSR | WSR alternative standard, and BLR equipment leak standard (40 CFR part 63, subpart H) |                                      |
| §63.1(a)(1) | Yes                  | Yes | Yes   | Additional terms defined in §63.522. |
| §63.1(a)(2) | Yes                  | Yes | Yes   |                                      |

|                   |     |     |     |   |
|-------------------|-----|-----|-----|---|
| §63.1(a)(3)       | Yes | Yes | Yes |   |
| §63.1(a)(4)       | Yes | Yes | Yes | Subpart W specifies applicability of each paragraph in subpart A to subpart W.  |
| §63.1(a)(5)       | N/A | N/A | N/A | Reserved.   |
| §63.1(a)(6)       | Yes | Yes | Yes |   |
| §63.1(a)(7)       | Yes | Yes | Yes |   |
| §63.1(a)(8)       | No  | No  | No  | Discusses State programs.   |
| §63.1(a)(9)       | N/A | N/A | N/A | Reserved.   |
| §63.1(a)(10)      | Yes | Yes | Yes |   |
| §63.1(a)(11)      | Yes | Yes | Yes |   |
| §63.1(a)(12)-(14) | Yes | Yes | Yes |   |
| §63.1(b)(1)       | No  | No  | No  | §63.521 of subpart W specifies applicability.   |
| §63.1(b)(2)       | Yes | Yes | Yes |   |
| §63.1(b)(3)       | Yes | Yes | Yes |   |
| §63.1(c)(1)       | Yes | Yes | Yes | Subpart W specifies applicability of each paragraph in subpart A to sources subject to subpart W.                               |
| §63.1(c)(2)       | No  | No  | No  | Area sources are not subject to subpart W.  |
| §63.1(c)(3)       | N/A | N/A | N/A | Reserved.   |
| §63.1(c)(4)       | Yes | Yes | Yes |   |
| §63.1(c)(5)       | Yes | Yes | No  | Subpart H specifies applicable notification requirements.   |
| §63.1(d)          | N/A | N/A | N/A | Reserved.   |
| §63.1(e)          | Yes | Yes | Yes |   |
| §63.2             | Yes | Yes | Yes | Additional terms are defined in §63.522 of subpart W; when overlap between subparts A and W occurs, subpart W takes precedence. |
| §63.3             | Yes | Yes | No  | Other units used in subpart W are defined in that subpart; units of measure   |

|                  |     |     |     |   |
|------------------|-----|-----|-----|---|
|                  |     |     |     | are spelled out for subpart H.  |
| §63.4(a)(1)-(3)  | Yes | Yes | Yes |   |
| §63.4(a)(4)      | N/A | N/A | N/A | Reserved.   |
| §63.4(a)(5)      | Yes | Yes | Yes |   |
| §63.4(b)         | Yes | Yes | Yes |   |
| §63.4(c)         | Yes | Yes | Yes |   |
| §63.5(a)         | Yes | Yes | Yes | Except replace the terms “source” and “stationary source” in §63.5(a)(1) of subpart A with “affected source”. |
| §63.5(b)(1)      | Yes | Yes | Yes |   |
| §63.5(b)(2)      | N/A | N/A | N/A | Reserved.   |
| §63.5(b)(3)      | Yes | Yes | Yes |   |
| §63.5(b)(4)      | Yes | Yes | Yes |   |
| §63.5(b)(5)      | Yes | Yes | Yes |   |
| §63.5(b)(6)      | Yes | Yes | Yes |   |
| §63.5(c)         | N/A | N/A | N/A | Reserved.   |
| §63.5(d)(1)(i)   | Yes | Yes | Yes |   |
| §63.5(d)(1)(ii)  | Yes | Yes | Yes |   |
| §63.5(d)(1)(iii) | Yes | Yes | Yes |   |
| §63.5(d)(2)      | Yes | Yes | Yes |   |
| §63.5(d)(3)-(4)  | Yes | Yes | Yes |   |
| §63.5(e)         | Yes | Yes | Yes |   |
| §63.5(f)(1)      | Yes | Yes | Yes | Except replace “source” in §63.5(f)(1) of subpart A with “affected source”.                                   |
| §63.5(f)(2)      | Yes | Yes | Yes |   |
| §63.6(a)         | Yes | Yes | Yes |   |
| §63.6(b)(1)-(2)  | No  | No  | No  | Subpart W specifies compliance dates.   |
| §63.6(b)(3)-(4)  | Yes | Yes | Yes |   |
| §63.6(b)(5)      |     | Yes | No  | Subpart H includes notification requirements.   |
| §63.6(b)(6)      | N/A | N/A | N/A | Reserved.   |

|                     |     |     |     |  |
|---------------------|-----|-----|-----|--|
| §63.6(b)(7)         | No  | Yes | No  | Sources subject to subpart H must comply according to the schedule in §63.520 of subpart W for new sources subject to subpart H.                               |
| §63.6(c)(1)-(2)     | Yes | Yes | Yes | Except replace “source” in §63.6(c)(1)-(2) of subpart A with “affected source”.  |
| §63.6(c)(3)-(4)     | N/A | N/A | N/A | Reserved.  |
| §63.6(c)(5)         | Yes | Yes | Yes |  |
| §63.6(d)            | N/A | N/A | N/A | Reserved.  |
| §63.6(e)            | Yes | Yes | Yes |  |
| §63.6(f)(1)         | Yes | Yes | Yes |  |
| §63.6(f)(2)(i)-(ii) | Yes | Yes | Yes |  |
| §63.6(f)(2)(iii)    | Yes | Yes | Yes |  |
| §63.6(f)(2)(iv)     | Yes | Yes | Yes |  |
| §63.6(f)(3)         | Yes | Yes | Yes |  |
| §63.6(g)            | Yes | Yes | Yes | An alternative standard has been proposed for WSR; however, affected sources will have the opportunity to demonstrate other alternatives to the Administrator. |
| §63.6(h)            | No  | No  | No  | Subpart W does not contain any opacity or visible emissions standards.   |
| §63.6(i)(1)         | Yes | Yes | Yes |  |
| §63.6(i)(2)         | Yes | Yes | Yes | Except replace “source” in §63.6(2) (i) and (ii) of subpart A with “affected source”.  |
| §63.6(i)(3)         | Yes | Yes | Yes |  |
| §63.6(i)(4)(i)      | Yes | Yes | Yes |  |
| §63.6(i)(4)(ii)     | Yes | Yes | Yes |  |
| §63.6(i)(5)-(14)    | Yes | Yes | Yes |  |
| §63.6(i)(15)        | N/A | N/A | N/A | Reserved.  |
| §63.6(i)(16)        | Yes | Yes | Yes |  |
| §63.6(j)            | Yes | Yes | Yes |  |
| §63.7(a)(1)         | Yes | Yes | No  | Subpart H specifies required testing and   |



|                         |     |     |     |  |
|-------------------------|-----|-----|-----|--|
|                         |     |     |     | compliance procedures.   |
| §63.7(a)(2)(i)-(vi)     | Yes | Yes | No  | Subpart H specifies that test results must be submitted in the Notification of Compliance Status due 150 days after the compliance date. |
| §63.7(a)(2)(vii)-(viii) | N/A | N/A | N/A | Reserved.  |
| §63.7(a)(2)(ix)         | Yes | Yes | Yes |  |
| §63.7(a)(3)             | Yes | Yes | Yes |  |
| §63.7(b)(1)             | Yes | Yes | Yes |  |
| §63.7(b)(2)             | Yes | Yes | Yes |  |
| §63.7(c)                | No  | No  | No  |  |
| §63.7(d)                | Yes | Yes | Yes | Except replace “source” in §63.7(d) of subpart A with “affected source”.   |
| §63.7(e)(1)             | Yes | Yes | Yes | Subpart W also contains test methods specific to BLR and WSR sources.  |
| §63.7(e)(2)             | Yes | Yes | Yes |  |
| §63.7(e)(3)             | Yes | Yes | No  | Subpart H specifies test methods and procedures.   |
| §63.7(f)                | Yes | Yes | No  | Subpart H specifies applicable methods and provides alternatives.  |
| §63.7(g)(1)             | Yes | Yes | No  | Subpart H specifies performance test reporting.  |
| §63.7(g)(2)             | N/A | N/A | N/A | Reserved.  |
| §63.7(g)(3)             | Yes | Yes | Yes |  |
| §63.7(h)(1)-(2)         | Yes | Yes | Yes |  |
| §63.7(h)(3)(i)          | Yes | Yes | Yes |  |
| §63.7(h)(3)(ii)-(iii)   | Yes | Yes | Yes |  |
| §63.7(h)(4)-(5)         | Yes | Yes | Yes |  |
| §63.8(a)(1)             | Yes | Yes | Yes |  |
| §63.8(a)(2)             | Yes | Yes | Yes |  |
| §63.8(a)(3)             | N/A | N/A | N/A | Reserved.  |

|                     |     |     |     |  |
|---------------------|-----|-----|-----|--|
| §63.8(a)(4)         | Yes | Yes | Yes |  |
| §63.8(b)(1)         | Yes | Yes | Yes |  |
| §63.8(b)(2)         | Yes | Yes | No  | Subpart H specifies locations to conduct monitoring. |
| §63.8(b)(3)         | Yes | Yes | Yes |  |
| §63.8(c)(1)(i)      | Yes | Yes | Yes |  |
| §63.8(c)(1)(ii)     | Yes | Yes | Yes |  |
| §63.8(c)(1)(iii)    | Yes | Yes | Yes |  |
| §63.8(c)(2)-(3)     | Yes | Yes | Yes |  |
| §63.8(c)(4)-(8)     | No  | No  | No  | Subpart W specifies monitoring frequencies.          |
| §63.8(d)            | No  | No  | No  |  |
| §63.8(e)            | No  | No  | No  |  |
| §63.8(f)(1)         | Yes | Yes | Yes |  |
| §63.8(f)(2)         | Yes | Yes | Yes |  |
| §63.8(f)(3)         | Yes | Yes | Yes |  |
| §63.8(f)(4)         | Yes | Yes | Yes |  |
| §63.8(f)(5)         | Yes | Yes | Yes |  |
| §63.8(f)(6)         | Yes | Yes | No  |  |
| §63.8(g)            | Yes | Yes | Yes |  |
| §63.9(a)            | Yes | Yes | Yes |  |
| §63.9(b)(1)(i)-(ii) | Yes | Yes | Yes |  |
| §63.9(b)(1)(iii)    | Yes | Yes | Yes |  |
| §63.9(b)(2)         | Yes | Yes | Yes |  |
| §63.9(b)(3)         | Yes | Yes | Yes |  |
| §63.9(b)(4)         | Yes | Yes | Yes |  |
| §63.9(b)(5)         | Yes | Yes | Yes |  |
| §63.9(c)            | Yes | Yes | Yes |  |
| §63.9(d)            | Yes | Yes | Yes |  |
| §63.9(e)            | No  | No  | No  |  |

|                   |     |     |     |  |
|-------------------|-----|-----|-----|--|
| §63.9(f)          | No  | No  | No  |  |
| §63.9(g)          | No  | No  | No  |  |
| §63.9(h)(1)-(3)   | Yes | Yes | No  | Separate Notification of Compliance Status requirements are specified for subpart H. |
| §63.9(h)(4)       | N/A | N/A | N/A | Reserved.  |
| §63.9(h)(5)-(6)   | Yes | Yes | No  | Subpart H specifies Notification of Compliance Status requirements.                  |
| §63.9(i)          | Yes | Yes | Yes |  |
| §63.9(j)          | Yes | Yes | Yes |  |
| §63.10(a)         | Yes | Yes | Yes |  |
| §63.10(b)(1)      | Yes | Yes | Yes |  |
| §63.10(b)(2)      | No  | No  | No  | Subparts H and W specify recordkeeping requirements.                                 |
| §63.10(b)(3)      | Yes | Yes | Yes |  |
| §63.10(c)(1)-(6)  | No  | No  | No  |  |
| §63.10(c)(7)-(8)  | Yes | Yes | Yes |  |
| §63.10(c)(9)-(15) | No  | No  | No  |  |
| §63.10(d)(1)      | Yes | Yes | No  | Subpart H specifies performance test reporting requirements.                         |
| §63.10(d)(2)      | Yes | Yes | No  | Subpart H specifies performance test reporting requirements.                         |
| §63.10(d)(3)      | No  | No  | No  |  |
| §63.10(d)(4)      | Yes | Yes | Yes |  |
| §63.10(d)(5)      | Yes | Yes | Yes |  |
| §63.10(e)(1)-(2)  | No  | No  | No  |  |
| §63.10(e)(3)      | Yes | Yes | No  |  |
| §63.10(e)(4)      | No  | No  | No  |  |
| §63.10(f)         | Yes | Yes | Yes |  |
| §63.11-63.15      | Yes | Yes | Yes |  |

**Appendix G**

40 C.F.R. Part 63, Subpart SS – *National Emission Standard for Closed Vent Systems, Control Devices, Recovery Devices and Routing to a Fuel Gas System or a Process*

## Subpart SS—National Emission Standards for Closed Vent Systems, Control Devices, Recovery Devices and Routing to a Fuel Gas System or a Process

SOURCE: 64 FR 34866, June 29, 1999, unless otherwise noted.

### §63.980 Applicability.

The provisions of this subpart include requirements for closed vent systems, control devices and routing of air emissions to a fuel gas system or process. These provisions apply when another subpart references the use of this subpart for such air emission control. These air emission standards are placed here for administrative convenience and only apply to those owners and operators of facilities subject to a referencing subpart. The provisions of 40 CFR part 63, subpart A (General Provisions) do not apply to this subpart except as specified in a referencing subpart.

### §63.981 Definitions.

*Alternative test method* means any method of sampling and analyzing for an air pollutant that is not a reference test or equivalent method, and that has been demonstrated to the Administrator's satisfaction, using Method 301 in appendix A of this part 63, or previously approved by the Administrator prior to the promulgation date of standards for an affected source or affected facility under a referencing subpart, to produce results adequate for the Administrator's determination that it may be used in place of a test method specified in this subpart.

*Boiler* means any enclosed combustion device that extracts useful energy in the form of steam and is not an incinerator or a process heater.

*By compound* means by individual stream components, not carbon equivalents.

*Closed vent system* means a system that is not open to the atmosphere and is composed of piping, ductwork, connections, and, if necessary, flow inducing devices that transport gas or vapor from an emission point to a control device. Closed vent system does not include the vapor collection system that is part of any tank truck or railcar.

*Closed vent system shutdown* means a work practice or operational procedure that stops production from a process unit or part of a process unit during which it is technically feasible to clear process material from a closed vent system or part of a closed vent system consistent with safety constraints and during which repairs can be effected. An unscheduled work practice or operational procedure that stops production from a process unit or part of a process unit for less than 24 hours is not a closed vent system shutdown. An unscheduled work practice or operational procedure that would stop production from a process unit or part of a process unit for a shorter period of time than would be required to clear the closed vent system or part of the closed vent system of materials and start up the unit, and would result in greater emissions than delay of repair of leaking components until the next scheduled closed vent system shutdown, is not a closed vent system shutdown. The use of spare equipment and technically feasible bypassing of equipment without stopping production are not closed vent system shutdowns.

*Combustion device* means an individual unit of equipment, such as a flare, incinerator, process heater, or boiler, used for the combustion of organic emissions.

*Continuous parameter monitoring system (CPMS)* means the total equipment that may be required to meet the data acquisition and availability requirements of this part, used to sample, condition (if applicable), analyze, and provide a record of process or control system parameters.

*Continuous record* means documentation, either in hard copy or computer readable form, of data values measured at least once every 15 minutes and recorded at the frequency specified in §63.998(b).

*Control device* means, with the exceptions noted below, a combustion device, recovery device, recapture device, or any combination of these devices used to comply with this subpart or a referencing subpart. For process vents from continuous unit operations at affected sources in subcategories where the applicability criteria includes a TRE index value, recovery devices are not considered to be control devices. Primary condensers on steam strippers or fuel gas systems are not considered to be control devices.

*Control System* means the combination of the closed vent system and the control devices used to collect and control vapors or gases from a regulated emission source.

*Day* means a calendar day.

*Ductwork* means a conveyance system such as those commonly used for heating and ventilation systems. It is often made of sheet metal and often has sections connected by screws or crimping. Hard-piping is not ductwork.

*Final recovery device* means the last recovery device on a process vent stream from a continuous unit operation at an affected source in a subcategory where the applicability criteria includes a TRE index value. The final recovery device usually discharges to a combustion device, recapture device, or directly to the atmosphere.

*First attempt at repair*, for the purposes of this subpart, means to take action for the purpose of stopping or reducing leakage of organic material to the atmosphere, followed by monitoring as specified in §63.983(c) to verify whether the leak is repaired, unless the owner or operator determines by other means that the leak is not repaired.

*Flame zone* means the portion of the combustion chamber in a boiler or process heater occupied by the flame envelope.

*Flow indicator* means a device which indicates whether gas flow is, or whether the valve position would allow gas flow to be, present in a line.

*Fuel gas* means gases that are combusted to derive useful work or heat.

*Fuel gas system* means the offsite and onsite piping and flow and pressure control system that gathers gaseous streams generated by onsite operations, may blend them with other sources of gas, and transports the gaseous streams for use as fuel gas in combustion devices or in-process combustion equipment such as furnaces and gas turbines, either singly or in combination.

*Hard-piping* means pipe or tubing that is manufactured and properly installed using good engineering judgment and standards, such as ANSI B31.3.

*High throughput transfer rack* means those transfer racks that transfer a total of 11.8 million liters per year or greater of liquid containing regulated material.

*Incinerator* means an enclosed combustion device that is used for destroying organic compounds. Auxiliary fuel may be used to heat waste gas to combustion temperatures. Any energy recovery section present is not physically formed into one manufactured or assembled unit with the combustion section; rather, the energy recovery section is a separate section following the combustion section and the two are joined by ducts or connections carrying flue gas. The above energy recovery section limitation does not apply to an energy recovery section used solely to preheat the incoming vent stream or combustion air.

*Low throughput transfer rack* means those transfer racks that transfer less than a total of 11.8 million liters per year of liquid containing regulated material.

*Operating parameter value* means a minimum or maximum value established for a control device parameter which, if achieved by itself or in combination with one or more other operating parameter values, determines that an owner or operator has complied with an applicable emission limit or operating limit.

*Organic monitoring device* means a unit of equipment used to indicate the concentration level of organic compounds based on a detection principle such as infra-red, photo ionization, or thermal conductivity.

*Owner or operator* means any person who owns, leases, operates, controls, or supervises a regulated source or a stationary source of which a regulated source is a part.

*Performance level* means the level at which the regulated material in the gases or vapors vented to a control or recovery device is removed, recovered, or destroyed. Examples of control device performance levels include: achieving a minimum organic reduction efficiency expressed as a percentage of regulated material removed or destroyed in the control device inlet stream on a weight-basis; achieving an organic concentration in the control device exhaust stream that is less than a maximum allowable limit expressed in parts per million by volume on a dry basis corrected to 3 percent oxygen if a combustion device is the control device and supplemental combustion air is used to combust the emissions; or maintaining appropriate control device operating parameters indicative of the device performance at specified values.

*Performance test* means the collection of data resulting from the execution of a test method (usually three emission test runs) used to demonstrate compliance with a relevant emission limit as specified in the performance test section of this subpart or in the referencing subpart.

*Primary fuel* means the fuel that provides the principal heat input to a device. To be considered primary, the fuel must be able to sustain operation without the addition of other fuels.

*Process heater* means an enclosed combustion device that transfers heat liberated by burning fuel directly to process streams or to heat transfer liquids other than water. A process heater may, as a secondary function, heat water in unfired heat recovery sections.

*Recapture device* means an individual unit of equipment capable of and used for the purpose of recovering chemicals, but not normally for use, reuse, or sale. For example, a recapture device may recover chemicals primarily for disposal. Recapture devices include, but are not limited to, absorbers, carbon adsorbers, and condensers. For purposes of the monitoring, recordkeeping and reporting requirements of this subpart, recapture devices are considered recovery devices.

*Recovery device* means an individual unit of equipment capable of and normally used for the purpose of recovering chemicals for fuel value (i.e., net positive heating value), use, reuse, or for sale for fuel value, use, or reuse. Examples of equipment that may be recovery devices include absorbers, carbon adsorbers, condensers, oil-water separators or organic-water separators, or organic removal devices such as decanters, strippers, or thin-film evaporation units. For purposes of the monitoring,

recordkeeping, and reporting requirements of this subpart, recapture devices are considered recovery devices.

*Recovery operations equipment* means the equipment used to separate the components of process streams. Recovery operations equipment includes distillation units, condensers, etc. Equipment used for wastewater treatment shall not be considered recovery operations equipment.

*Referencing subpart* means the subpart which refers an owner or operator to this subpart.

*Regulated material*, for purposes of this subpart, refers to vapors from volatile organic liquids (VOL), volatile organic compounds (VOC), or hazardous air pollutants (HAP), or other chemicals or groups of chemicals that are regulated by a referencing subpart.

*Regulated source* for the purposes of this subpart, means the stationary source, the group of stationary sources, or the portion of a stationary source that is regulated by a relevant standard or other requirement established pursuant to a referencing subpart.

*Repaired*, for the purposes of this subpart, means that equipment; is adjusted, or otherwise altered, to eliminate a leak as defined in the applicable sections of this subpart; and unless otherwise specified in applicable provisions of this subpart, is inspected as specified in §63.983(c) to verify that emissions from the equipment are below the applicable leak definition.

*Routed to a process or route to a process* means the gas streams are conveyed to any enclosed portion of a process unit where the emissions are recycled and/or consumed in the same manner as a material that fulfills the same function in the process; and/or transformed by chemical reaction into materials that are not regulated materials; and/or incorporated into a product; and/or recovered.

*Run* means one of a series of emission or other measurements needed to determine emissions for a representative operating period or cycle as specified in this subpart. Unless otherwise specified, a run may be either intermittent or continuous within the limits of good engineering practice.

*Secondary fuel* means a fuel fired through a burner other than the primary fuel burner that provides supplementary heat in addition to the heat provided by the primary fuel.

*Sensor* means a device that measures a physical quantity or the change in a physical quantity, such as temperature, pressure, flow rate, pH, or liquid level.

*Specific gravity monitoring device* means a unit of equipment used to monitor specific gravity and having a minimum accuracy of  $\pm 0.02$  specific gravity units.

*Supplemental combustion air* means the air that is added to a vent stream after the vent stream leaves the unit operation. Air that is part of the vent stream as a result of the nature of the unit operation is not considered supplemental combustion air. Air required to operate combustion device burner(s) is not considered supplemental combustion air. Air required to ensure the proper operation of catalytic oxidizers, to include the intermittent addition of air upstream of the catalyst bed to maintain a minimum threshold flow rate through the catalyst bed or to avoid excessive temperatures in the catalyst bed, is not considered to be supplemental combustion air.

*Temperature monitoring device* means a unit of equipment used to monitor temperature and having a minimum accuracy of  $\pm 1$  percent of the temperature being monitored expressed in degrees Celsius or  $\pm 1.2$  degrees Celsius ( $^{\circ}\text{C}$ ), whichever is greater.



## **§63.982 Requirements.**

(a) *General compliance requirements for storage vessels, process vents, transfer racks, and equipment leaks.* An owner or operator who is referred to this subpart for controlling regulated material emissions from storage vessels, process vents, low and high throughput transfer racks, or equipment leaks by venting emissions through a closed vent system to a flare, nonflare control device or routing to a fuel gas system or process shall comply with the applicable requirements of paragraphs (a)(1) through (4) of this section.

(1) *Storage vessels.* The owner or operator shall comply with the applicable provisions of paragraphs (b), (c)(1), and (d) of this section.

(2) *Process vents.* The owner or operator shall comply with the applicable provisions of paragraphs (b), (c)(2), and (e) of this section.

(3) *Transfer racks.* (i) For low throughput transfer racks, the owner or operator shall comply with the applicable provisions of paragraphs (b), (c)(1), and (d) of this section.

(ii) For high throughput transfer racks, the owner or operator shall comply with the applicable provisions of paragraphs (b), (c)(2), and (d) of this section.

(4) *Equipment leaks.* The owner or operator shall comply with the applicable provisions of paragraphs (b), (c)(3), and (d) of this section.

(b) *Closed vent system and flare.* Owners or operators that vent emissions through a closed vent system to a flare shall meet the requirements in §63.983 for closed vent systems; §63.987 for flares; §63.997 (a), (b) and (c) for provisions regarding flare compliance assessments; the monitoring, recordkeeping, and reporting requirements referenced therein; and the applicable recordkeeping and reporting requirements of §§63.998 and 63.999. No other provisions of this subpart apply to emissions vented through a closed vent system to a flare.

(c) *Closed vent system and nonflare control device.* Owners or operators who control emissions through a closed vent system to a nonflare control device shall meet the requirements in §63.983 for closed vent systems, the applicable recordkeeping and reporting requirements of §§63.998 and 63.999, and the applicable requirements listed in paragraphs (c)(1) through (3) of this section.

(1) For storage vessels and low throughput transfer racks, the owner or operator shall meet the requirements in §63.985 for nonflare control devices and the monitoring, recordkeeping, and reporting requirements referenced therein. No other provisions of this subpart apply to low throughput transfer rack emissions or storage vessel emissions vented through a closed vent system to a nonflare control device unless specifically required in the monitoring plan submitted under §63.985(c).

(2) For process vents and high throughput transfer racks, the owner or operator shall meet the requirements applicable to the control devices being used in §63.988, §63.990 or §63.995; the applicable general monitoring requirements of §63.996 and the applicable performance test requirements and procedures of §63.997; and the monitoring, recordkeeping and reporting requirements referenced therein. Owners or operators subject to halogen reduction device requirements under a referencing subpart must also comply with §63.994 and the monitoring, recordkeeping, and reporting requirements referenced therein. The requirements of §§63.984 through 63.986 do not apply to process vents or high throughput transfer racks.

(3) For equipment leaks, owners or operators shall meet the requirements in §63.986 for nonflare control devices used for equipment leak emissions and the monitoring, recordkeeping, and reporting

requirements referenced therein. No other provisions of this subpart apply to equipment leak emissions vented through a closed vent system to a nonflare control device.

(d) *Route to a fuel gas system or process.* Owners or operators that route emissions to a fuel gas system or to a process shall meet the requirements in §63.984, the monitoring, recordkeeping, and reporting requirements referenced therein, and the applicable recordkeeping and reporting requirements of §§63.998 and 63.999. No other provisions of this subpart apply to emissions being routed to a fuel gas system or process.

(e) *Final recovery devices.* Owners or operators who use a final recovery device to maintain a TRE above a level specified in a referencing subpart shall meet the requirements in §63.993 and the monitoring, recordkeeping, and reporting requirements referenced therein that are applicable to the recovery device being used; the applicable monitoring requirements in §63.996 and the recordkeeping and reporting requirements referenced therein; and the applicable recordkeeping and reporting requirements of §§63.998 and 63.999. No other provisions of this subpart apply to process vent emissions routed to a final recovery device.

(f) *Combined emissions.* When emissions from different emission types (e.g., emissions from process vents, transfer racks, and/or storage vessels) are combined, an owner or operator shall comply with the requirements of either paragraph (f)(1) or (2) of this section.

(1) Comply with the applicable requirements of this subpart for each kind of emissions in the stream (e.g., the requirements of paragraph (a)(2) of this section for process vents, and the requirements of paragraph (a)(3) of this section for transfer racks); or

(2) Comply with the first set of requirements identified in paragraphs (f)(2)(i) through (iii) of this section which applies to any individual emission stream that is included in the combined stream. Compliance with paragraphs (f)(2)(i) through (iii) of this section constitutes compliance with all other emissions requirements for other emission streams.

(i) The requirements of §63.982(a)(2) for process vents, including applicable monitoring, recordkeeping, and reporting;

(ii) The requirements of §63.982(a)(3)(ii) for high throughput transfer racks, including applicable monitoring, recordkeeping, and reporting;

(iii) The requirements of §63.982(a)(1) or (a)(3)(i) for control of emissions from storage vessels or low throughput transfer racks, including applicable monitoring, recordkeeping, and reporting.

[64 FR 34866, June 29, 1999, as amended at 64 FR 63705, Nov. 22, 1999]

### **§63.983 Closed vent systems.**

(a) *Closed vent system equipment and operating requirements.* Except for closed vent systems operated and maintained under negative pressure, the provisions of this paragraph apply to closed vent systems collecting regulated material from a regulated source.

(1) *Collection of emissions.* Each closed vent system shall be designed and operated to collect the regulated material vapors from the emission point, and to route the collected vapors to a control device.

(2) *Period of operation.* Closed vent systems used to comply with the provisions of this subpart shall be operated at all times when emissions are vented to, or collected by, them.

(3) *Bypass monitoring.* Except for equipment needed for safety purposes such as pressure relief devices, low leg drains, high point bleeds, analyzer vents, and open-ended valves or lines, the owner or operator shall comply with the provisions of either paragraphs (a)(3)(i) or (ii) of this section for each closed vent system that contains bypass lines that could divert a vent stream to the atmosphere.

(i) Properly install, maintain, and operate a flow indicator that is capable of taking periodic readings. Records shall be generated as specified in §63.998(d)(1)(ii)(A). The flow indicator shall be installed at the entrance to any bypass line.

(ii) Secure the bypass line valve in the non-diverting position with a car-seal or a lock-and-key type configuration. Records shall be generated as specified in §63.998(d)(1)(ii)(B).

(4) *Loading arms at transfer racks.* Each closed vent system collecting regulated material from a transfer rack shall be designed and operated so that regulated material vapors collected at one loading arm will not pass through another loading arm in the rack to the atmosphere.

(5) *Pressure relief devices in a transfer rack's closed vent system.* The owner or operator of a transfer rack subject to the provisions of this subpart shall ensure that no pressure relief device in the transfer rack's closed vent system shall open to the atmosphere during loading. Pressure relief devices needed for safety purposes are not subject to this paragraph.

(b) *Closed vent system inspection and monitoring requirements.* The provisions of this subpart apply to closed vent systems collecting regulated material from a regulated source. Inspection records shall be generated as specified in §63.998(d)(1)(iii) and (iv) of this section.

(1) Except for any closed vent systems that are designated as unsafe or difficult to inspect as provided in paragraphs (b)(2) and (3) of this section, each closed vent system shall be inspected as specified in paragraph (b)(1)(i) or (ii) of this section.

(i) If the closed vent system is constructed of hard-piping, the owner or operator shall comply with the requirements specified in paragraphs (b)(1)(i)(A) and (B) of this section.

(A) Conduct an initial inspection according to the procedures in paragraph (c) of this section; and

(B) Conduct annual inspections for visible, audible, or olfactory indications of leaks.

(ii) If the closed vent system is constructed of ductwork, the owner or operator shall conduct an initial and annual inspection according to the procedures in paragraph (c) of this section.

(2) Any parts of the closed vent system that are designated, as described in §63.998(d)(1)(i), as unsafe to inspect are exempt from the inspection requirements of paragraph (b)(1) of this section if the conditions of paragraphs (b)(2)(i) and (ii) of this section are met.

(i) The owner or operator determines that the equipment is unsafe-to-inspect because inspecting personnel would be exposed to an imminent or potential danger as a consequence of complying with paragraph (b)(1) of this section; and

(ii) The owner or operator has a written plan that requires inspection of the equipment as frequently as practical during safe-to-inspect times. Inspection is not required more than once annually.

(3) Any parts of the closed vent system that are designated, as described in §63.998(d)(1)(i), as difficult-to-inspect are exempt from the inspection requirements of paragraph (b)(1) of this section if the provisions of paragraphs (b)(3)(i) and (ii) of this section apply.

(i) The owner or operator determines that the equipment cannot be inspected without elevating the inspecting personnel more than 2 meters (7 feet) above a support surface; and

(ii) The owner or operator has a written plan that requires inspection of the equipment at least once every 5 years.

(4) For each bypass line, the owner or operator shall comply with paragraph (b)(4)(i) or (ii) of this section.

(i) If a flow indicator is used, take a reading at least once every 15 minutes.

(ii) If the bypass line valve is secured in the non-diverting position, visually inspect the seal or closure mechanism at least once every month to verify that the valve is maintained in the non-diverting position, and the vent stream is not diverted through the bypass line.

(c) *Closed vent system inspection procedures.* The provisions of this paragraph apply to closed vent systems collecting regulated material from a regulated source.

(1) Each closed vent system subject to this paragraph shall be inspected according to the procedures specified in paragraphs (c)(1)(i) through (vii) of this section.

(i) Inspections shall be conducted in accordance with Method 21 of 40 CFR part 60, appendix A, except as specified in this section.

(ii) Except as provided in (c)(1)(iii) of this section, the detection instrument shall meet the performance criteria of Method 21 of 40 CFR part 60, appendix A, except the instrument response factor criteria in section 3.1.2(a) of Method 21 must be for the representative composition of the process fluid and not of each individual VOC in the stream. For process streams that contain nitrogen, air, water, or other inerts that are not organic HAP or VOC, the representative stream response factor must be determined on an inert-free basis. The response factor may be determined at any concentration for which the monitoring for leaks will be conducted.

(iii) If no instrument is available at the plant site that will meet the performance criteria of Method 21 specified in paragraph (c)(1)(ii) of this section, the instrument readings may be adjusted by multiplying by the representative response factor of the process fluid, calculated on an inert-free basis as described in paragraph (c)(1)(ii) of this section.

(iv) The detection instrument shall be calibrated before use on each day of its use by the procedures specified in Method 21 of 40 CFR part 60, appendix A.

(v) Calibration gases shall be as specified in paragraphs (c)(1)(v)(A) through (C) of this section.

(A) Zero air (less than 10 parts per million hydrocarbon in air); and

(B) Mixtures of methane in air at a concentration less than 10,000 parts per million. A calibration gas other than methane in air may be used if the instrument does not respond to methane or if the instrument does not meet the performance criteria specified in paragraph (c)(1)(ii) of this section. In such cases, the calibration gas may be a mixture of one or more of the compounds to be measured in air.

(C) If the detection instrument's design allows for multiple calibration scales, then the lower scale shall be calibrated with a calibration gas that is no higher than 2,500 parts per million.

(vi) An owner or operator may elect to adjust or not adjust instrument readings for background. If an owner or operator elects not to adjust readings for background, all such instrument readings shall be compared directly to 500 parts per million to determine whether there is a leak. If an owner or operator elects to adjust instrument readings for background, the owner or operator shall measure background concentration using the procedures in this section. The owner or operator shall subtract the background reading from the maximum concentration indicated by the instrument.

(vii) If the owner or operator elects to adjust for background, the arithmetic difference between the maximum concentration indicated by the instrument and the background level shall be compared with 500 parts per million for determining whether there is a leak.

(2) The instrument probe shall be traversed around all potential leak interfaces as described in Method 21 of 40 CFR part 60, appendix A.

(3) Except as provided in paragraph (c)(4) of this section, inspections shall be performed when the equipment is in regulated material service, or in use with any other detectable gas or vapor.

(4) Inspections of the closed vent system collecting regulated material from a transfer rack shall be performed only while a tank truck or railcar is being loaded or is otherwise pressurized to normal operating conditions with regulated material or any other detectable gas or vapor.

(d) *Closed vent system leak repair provisions.* The provisions of this paragraph apply to closed vent systems collecting regulated material from a regulated source.

(1) If there are visible, audible, or olfactory indications of leaks at the time of the annual visual inspections required by paragraph (b)(1)(i)(B) of this section, the owner or operator shall follow the procedure specified in either paragraph (d)(1)(i) or (ii) of this section.

(i) The owner or operator shall eliminate the leak.

(ii) The owner or operator shall monitor the equipment according to the procedures in paragraph (c) of this section.

(2) Leaks, as indicated by an instrument reading greater than 500 parts per million by volume above background or by visual inspections, shall be repaired as soon as practical, except as provided in paragraph (d)(3) of this section. Records shall be generated as specified in §63.998(d)(1)(iii) when a leak is detected.

(i) A first attempt at repair shall be made no later than 5 days after the leak is detected.

(ii) Except as provided in paragraph (d)(3) of this section, repairs shall be completed no later than 15 days after the leak is detected or at the beginning of the next introduction of vapors to the system, whichever is later.

(3) Delay of repair of a closed vent system for which leaks have been detected is allowed if repair within 15 days after a leak is detected is technically infeasible or unsafe without a closed vent system shutdown, as defined in §63.981, or if the owner or operator determines that emissions resulting from immediate repair would be greater than the emissions likely to result from delay of repair. Repair of such equipment shall be completed as soon as practical, but not later than the end of the next closed vent system shutdown.

**§63.984 Fuel gas systems and processes to which storage vessel, transfer rack, or equipment leak regulated material emissions are routed.**

(a) *Equipment and operating requirements for fuel gas systems and processes.* (1) Except during periods of start-up, shutdown and malfunction as specified in the referencing subpart, the fuel gas system or process shall be operating at all times when regulated material emissions are routed to it.

(2) The owner or operator of a transfer rack subject to the provisions of this subpart shall ensure that no pressure relief device in the transfer rack's system returning vapors to a fuel gas system or process shall open to the atmosphere during loading. Pressure relief devices needed for safety purposes are not subject to this paragraph.

(b) *Fuel gas system and process compliance assessment.* (1) If emissions are routed to a fuel gas system, there is no requirement to conduct a performance test or design evaluation.

(2) If emissions are routed to a process, the regulated material in the emissions shall meet one or more of the conditions specified in paragraphs (b)(2)(i) through (iv) of this section. The owner or operator of storage vessels subject to this paragraph shall comply with the compliance demonstration requirements in paragraph (b)(3) of this section.

(i) Recycled and/or consumed in the same manner as a material that fulfills the same function in that process;

(ii) Transformed by chemical reaction into materials that are not regulated materials;

(iii) Incorporated into a product; and/or

(iv) Recovered.

(3) To demonstrate compliance with paragraph (b)(2) of this section for a storage vessel, the owner or operator shall prepare a design evaluation (or engineering assessment) that demonstrates the extent to which one or more of the conditions specified in paragraphs (b)(2)(i) through (iv) of this section are being met.

(c) *Statement of connection.* For storage vessels and transfer racks, the owner or operator shall submit the statement of connection reports for fuel gas systems specified in §63.999(b)(1)(ii), as appropriate.

**§63.985 Nonflare control devices used to control emissions from storage vessels and low throughput transfer racks.**

(a) *Nonflare control device equipment and operating requirements.* The owner or operator shall operate and maintain the nonflare control device so that the monitored parameters defined as required in paragraph (c) of this section remain within the ranges specified in the Notification of Compliance Status whenever emissions of regulated material are routed to the control device except during periods of start-up, shutdown, and malfunction as specified in the referencing subpart.

(b) *Nonflare control device design evaluation or performance test requirements.* When using a control device other than a flare, the owner or operator shall comply with the requirements in paragraphs (b)(1)(i) or (ii) of this section, except as provided in paragraphs (b)(2) and (3) of this section.

(1) *Design evaluation or performance test results.* The owner or operator shall prepare and submit with the Notification of Compliance Status, as specified in §63.999(b)(2), either a design evaluation that

includes the information specified in paragraph (b)(1)(i) of this section, or the results of the performance test as described in paragraph (b)(1)(ii) of this section.

(i) *Design evaluation.* The design evaluation shall include documentation demonstrating that the control device being used achieves the required control efficiency during the reasonably expected maximum storage vessel filling or transfer loading rate. This documentation is to include a description of the gas stream that enters the control device, including flow and regulated material content, and the information specified in paragraphs (b)(1)(i)(A) through (E) of this section, as applicable. For storage vessels, the description of the gas stream that enters the control device shall be provided for varying liquid level conditions. This documentation shall be submitted with the Notification of Compliance Status as specified in §63.999(b)(2).

(A) The efficiency determination is to include consideration of all vapors, gases, and liquids, other than fuels, received by the control device.

(B) If an enclosed combustion device with a minimum residence time of 0.5 seconds and a minimum temperature of 760 °C is used to meet an emission reduction requirement specified in a referencing subpart for storage vessels and transfer racks, documentation that those conditions exist is sufficient to meet the requirements of paragraph (b)(1)(i) of this section.

(C) Except as provided in paragraph (b)(1)(i)(B) of this section for enclosed combustion devices, the design evaluation shall include the estimated autoignition temperature of the stream being combusted, the flow rate of the stream, the combustion temperature, and the residence time at the combustion temperature.

(D) For carbon adsorbers, the design evaluation shall include the estimated affinity of the regulated material vapors for carbon, the amount of carbon in each bed, the number of beds, the humidity, the temperature, the flow rate of the inlet stream and, if applicable, the desorption schedule, the regeneration stream pressure or temperature, and the flow rate of the regeneration stream. For vacuum desorption, pressure drop shall be included.

(E) For condensers, the design evaluation shall include the final temperature of the stream vapors, the type of condenser, and the design flow rate of the emission stream.

(ii) *Performance test.* A performance test, whether conducted to meet the requirements of this section, or to demonstrate compliance for a process vent or high throughput transfer rack as required by §63.988(b), §63.990(b), or §63.995(b), is acceptable to demonstrate compliance with emission reduction requirements for storage vessels and transfer racks. The owner or operator is not required to prepare a design evaluation for the control device as described in paragraph (b)(1)(i) of this section if a performance test will be performed that meets the criteria specified in paragraphs (b)(1)(ii)(A) and (B) of this section.

(A) The performance test will demonstrate that the control device achieves greater than or equal to the required control device performance level specified in a referencing subpart for storage vessels or transfer racks; and

(B) The performance test meets the applicable performance test requirements and the results are submitted as part of the Notification of Compliance Status as specified in §63.999(b)(2).

(2) *Exceptions.* A design evaluation or performance test is not required if the owner or operator uses a combustion device meeting the criteria in paragraph (b)(2)(i), (ii), (iii), or (iv) of this section.

(i) A boiler or process heater with a design heat input capacity of 44 megawatts (150 million British thermal units per hour) or greater.

(ii) A boiler or process heater burning hazardous waste for which the owner or operator meets the requirements specified in paragraph (b)(2)(ii)(A) or (B) of this section.

(A) The boiler or process heater has been issued a final permit under 40 CFR part 270 and complies with the requirements of 40 CFR part 266, subpart H, or

(B) The boiler or process heater has certified compliance with the interim status requirements of 40 CFR part 266, subpart H.

(iii) A hazardous waste incinerator for which the owner or operator meets the requirements specified in paragraph (b)(2)(iii)(A) or (B) of this section.

(A) The incinerator has been issued a final permit under 40 CFR part 270 and complies with the requirements of 40 CFR part 264, subpart O; or

(B) The incinerator has certified compliance with the interim status requirements of 40 CFR part 265, subpart O; or

(iv) A boiler or process heater into which the vent stream is introduced with the primary fuel.

(3) *Prior design evaluations or performance tests.* If a design evaluation or performance test is required in the referencing subpart or was previously conducted and submitted for a storage vessel or low throughput transfer rack, then a performance test or design evaluation is not required.

(c) *Nonflare control device monitoring requirements.* (1) The owner or operator shall submit with the Notification of Compliance Status, a monitoring plan containing the information specified in §63.999(b)(2)(i) and (ii) to identify the parameters that will be monitored to assure proper operation of the control device.

(2) The owner or operator shall monitor the parameters specified in the Notification of Compliance Status or in the operating permit application or amendment. Records shall be generated as specified in §63.998(d)(2)(i).

#### **§63.986 Nonflare control devices used for equipment leaks only.**

(a) *Equipment and operating requirements.* (1) Owners or operators using a nonflare control device to meet the applicable requirements of a referencing subpart for equipment leaks shall meet the requirements of this section.

(2) Control devices used to comply with the provisions of this subpart shall be operated at all times when emissions are vented to them.

(b) *Performance test requirements.* A performance test is not required for any nonflare control device used only to control emissions from equipment leaks.

(c) *Monitoring requirements.* Owners or operators of control devices that are used to comply only with the provisions of a referencing subpart for control of equipment leak emissions shall monitor these control devices to ensure that they are operated and maintained in conformance with their design. The owner or operator shall maintain the records as specified in §63.998(d)(4).

#### **§63.987 Flare requirements.**



(a) *Flare equipment and operating requirements.* Flares subject to this subpart shall meet the performance requirements in 40 CFR 63.11(b) (General Provisions).

(b) *Flare compliance assessment.* (1) The owner or operator shall conduct an initial flare compliance assessment of any flare used to comply with the provisions of this subpart. Flare compliance assessment records shall be kept as specified in §63.998(a)(1) and a flare compliance assessment report shall be submitted as specified in §63.999(a)(2). An owner or operator is not required to conduct a performance test to determine percent emission reduction or outlet regulated material or total organic compound concentration when a flare is used.

(2) [Reserved]

(3) Flare compliance assessments shall meet the requirements specified in paragraphs (b)(3)(i) through (iv) of this section.

(i) Method 22 of appendix A of part 60 shall be used to determine the compliance of flares with the visible emission provisions of this subpart. The observation period is 2 hours, except for transfer racks as provided in (b)(3)(i)(A) or (B) of this section.

(A) For transfer racks, if the loading cycle is less than 2 hours, then the observation period for that run shall be for the entire loading cycle.

(B) For transfer racks, if additional loading cycles are initiated within the 2-hour period, then visible emissions observations shall be conducted for the additional cycles.

(ii) The net heating value of the gas being combusted in a flare shall be calculated using Equation 1:

$$H_T = K_1 \sum_{j=1}^n D_j H_j \quad [Eq. 1]$$

Where:

$H_T$  = Net heating value of the sample, megajoules per standard cubic meter; where the net enthalpy per mole of offgas is based on combustion at 25 °C and 760 millimeters of mercury (30 inches of mercury), but the standard temperature for determining the volume corresponding to one mole is 20 °C;

$K_1$  =  $1.740 \times 10^{-7}$  (parts per million by volume)<sup>-1</sup> (gram-mole per standard cubic meter) (megajoules per kilocalories), where the standard temperature for gram mole per standard cubic meter is 20 °C;

$n$  = number of sample components;

$D_j$  = Concentration of sample component  $j$ , in parts per million by volume on a wet basis, as measured for organics by Method 18 of 40 CFR part 60, appendix A, or by American Society for Testing and Materials (ASTM) D6420-99 (available for purchase from at least one of the following addresses: 100 Barr Harbor Drive, West Conshohocken, PA 19428-2959; or University Microfilms International, 300 North Zeeb Road, Ann Arbor, MI 48106) under the conditions specified in §63.997(e)(2)(iii)(D)(1) through (3). Hydrogen and carbon monoxide are measured by ASTM D1946-90; and

$H_j$  = Net heat of combustion of sample component  $j$ , kilocalories per gram mole at 25 °C and 760 millimeters of mercury (30 inches of mercury).

(iii) The actual exit velocity of a flare shall be determined by dividing the volumetric flow rate (in unit of standard temperature and pressure), as determined by Method 2, 2A, 2C, 2D, 2F, or 2G of 40 CFR part 60, appendix A, as appropriate, by the unobstructed (free) cross sectional area of the flare tip.

(iv) Flare flame or pilot monitors, as applicable, shall be operated during any flare compliance assessment.

(c) *Flare monitoring requirements.* Where a flare is used, the following monitoring equipment is required: a device (including but not limited to a thermocouple, ultra-violet beam sensor, or infrared sensor) capable of continuously detecting that at least one pilot flame or the flare flame is present. Flare flame monitoring and compliance records shall be kept as specified in §63.998(a)(1) and reported as specified in §63.999(a).

[64 FR 34866, June 29, 1999, as amended at 64 FR 63705, Nov. 22, 1999; 67 FR 46277, July 12, 2002]

### **§63.988 Incinerators, boilers, and process heaters.**

(a) *Equipment and operating requirements.* (1) Owners or operators using incinerators, boilers, or process heaters to meet a weight-percent emission reduction or parts per million by volume outlet concentration requirement specified in a referencing subpart shall meet the requirements of this section.

(2) Incinerators, boilers, or process heaters used to comply with the provisions of a referencing subpart and this subpart shall be operated at all times when emissions are vented to them.

(3) For boilers and process heaters, the vent stream shall be introduced into the flame zone of the boiler or process heater.

(b) *Performance test requirements.* (1) Except as specified in §63.997(b), and paragraph (b)(2) of this section, the owner or operator shall conduct an initial performance test of any incinerator, boiler, or process heater used to comply with the provisions of a referencing subpart and this subpart according to the procedures in §63.997. Performance test records shall be kept as specified in §63.998(a)(2) and a performance test report shall be submitted as specified in §63.999(a)(2). As provided in §63.985(b)(1), a design evaluation may be used as an alternative to the performance test for storage vessels and low throughput transfer rack controls. As provided in §63.986(b), no performance test is required for equipment leaks.

(2) An owner or operator is not required to conduct a performance test when any of the control devices specified in paragraphs (b)(2)(i) through (iv) of this section are used.

(i) A hazardous waste incinerator for which the owner or operator has been issued a final permit under 40 CFR part 270 and complies with the requirements of 40 CFR part 264, subpart O, or has certified compliance with the interim status requirements of 40 CFR part 265, subpart O;

(ii) A boiler or process heater with a design heat input capacity of 44 megawatts (150 million British thermal units per hour) or greater;

(iii) A boiler or process heater into which the vent stream is introduced with the primary fuel or is used as the primary fuel; or

(iv) A boiler or process heater burning hazardous waste for which the owner or operator meets the requirements specified in paragraph (b)(2)(iv)(A) or (B) of this section.

(A) The boiler or process heater has been issued a final permit under 40 CFR part 270 and complies with the requirements of 40 CFR part 266, subpart H; or

(B) The boiler or process heater has certified compliance with the interim status requirements of 40 CFR part 266, subpart H.

(c) *Incinerator, boiler, and process heater monitoring requirements.* Where an incinerator, boiler, or process heater is used, a temperature monitoring device capable of providing a continuous record that meets the provisions specified in paragraph (c)(1), (2), or (3) of this section is required. Any boiler or process heater in which all vent streams are introduced with primary fuel or are used as the primary fuel is exempt from monitoring. Monitoring results shall be recorded as specified in §63.998(b) and (c), as applicable. General requirements for monitoring and continuous parameter monitoring systems are contained in the referencing subpart and §3.996.

(1) Where an incinerator other than a catalytic incinerator is used, a temperature monitoring device shall be installed in the fire box or in the ductwork immediately downstream of the fire box in a position before any substantial heat exchange occurs.

(2) Where a catalytic incinerator is used, temperature monitoring devices shall be installed in the gas stream immediately before and after the catalyst bed.

(3) Where a boiler or process heater of less than 44 megawatts (150 million British thermal units per hour) design heat input capacity is used and the regulated vent stream is not introduced as or with the primary fuel, a temperature monitoring device shall be installed in the fire box.

#### **§63.989 [Reserved]**

#### **§63.990 Absorbers, condensers, and carbon adsorbers used as control devices.**

(a) *Equipment and operating requirements.* (1) Owners or operators using absorbers, condensers, or carbon adsorbers to meet a weight-percent emission reduction or parts per million by volume outlet concentration requirement specified in a referencing subpart shall meet the requirements of this section.

(2) Absorbers, condensers, and carbon adsorbers used to comply with the provisions of a referencing subpart and this subpart shall be operated at all times when emissions are vented to them.

(b) *Performance test requirements.* Except as specified in §63.997(b), the owner or operator shall conduct an initial performance test of any absorber, condenser, or carbon adsorber used as a control device to comply with the provisions of the referencing subpart and this subpart according to the procedures in §63.997. Performance test records shall be kept as specified in §63.998(a)(2) and a performance test report shall be submitted as specified in §63.999(a)(2). As provided in §63.985(b)(1), a design evaluation may be used as an alternative to the performance test for storage vessels and low throughput transfer rack controls. As provided in §63.986(b), no performance test is required to demonstrate compliance for equipment leaks.

(c) *Monitoring requirements.* Where an absorber, condenser, or carbon adsorber is used as a control device, either an organic monitoring device capable of providing a continuous record, or the monitoring devices specified in paragraphs (c)(1) through (3), as applicable, shall be used. Monitoring results shall be recorded as specified in §63.998(b) and (c), as applicable. General requirements for monitoring and continuous parameter monitoring systems are contained in a referencing subpart and §63.996.

(1) Where an absorber is used, a scrubbing liquid temperature monitoring device and a specific gravity monitoring device, each capable of providing a continuous record, shall be used. If the difference between the specific gravity of the saturated scrubbing fluid and specific gravity of the fresh scrubbing fluid is less than 0.02 specific gravity units, an organic monitoring device capable of providing a continuous record shall be used.

(2) Where a condenser is used, a condenser exit (product side) temperature monitoring device capable of providing a continuous record shall be used.

(3) Where a carbon adsorber is used, an integrating regeneration stream flow monitoring device having an accuracy of  $\pm 10$  percent or better, capable of recording the total regeneration stream mass or volumetric flow for each regeneration cycle; and a carbon bed temperature monitoring device, capable of recording the carbon bed temperature after each regeneration and within 15 minutes of completing any cooling cycle, shall be used.

**§63.991 [Reserved]**

**§63.992 Implementation and enforcement.**

(a) This subpart can be implemented and enforced by the U.S. Environmental Protection Agency (EPA), or a delegated authority such as the applicable State, local, or tribal agency. If the EPA Administrator has delegated authority to a State, local, or tribal agency, then that agency has the authority to implement and enforce this subpart. Contact the applicable EPA Regional Office to find out if this subpart is delegated to a State, local, or tribal agency.

(b) In delegating implementation and enforcement authority of this subpart to a State, local, or tribal agency under section 40 CFR part 63, subpart E, the authorities contained in paragraphs (b)(1) through (5) of this section are retained by the EPA Administrator and are not transferred to the State, local, or tribal agency.

(1) Approval of alternatives to the nonopacity emissions standards in §§63.983(a) and (d), 63.984, 63.985(a), 63.986(a), 63.987(a), 63.988(a), 63.990(a), 63.993(a), 63.994(a), and 63.995(a) under §63.6(g). Where these standards reference another subpart, the cited provisions will be delegated according to the delegation provisions of the referenced subpart.

(2) [Reserved]

(3) Approval of major changes to test methods under §63.7(e)(2)(ii) and (f) and as defined in §63.90.

(4) Approval of major changes to monitoring under §63.8(f) and as defined in §63.90.

(5) Approval of major changes to recordkeeping and reporting under §63.10(f) and as defined in §63.90.

[67 FR 46277, July 12, 2002]

**§63.993 Absorbers, condensers, carbon adsorbers and other recovery devices used as final recovery devices.**

(a) *Final recovery device equipment and operating requirements.* (1) Owners or operators using a final recovery device to maintain a TRE above a level specified in a referencing subpart shall meet the requirements of this section.

(2) Recovery devices used to comply with the provisions of a referencing subpart and this subpart shall be operated at all times when emissions are vented to them.

(b) *Recovery device performance test requirements.* There are no performance test requirements for recovery devices. TRE index value determination information shall be recorded as specified in §63.998(a)(3).

(c) *Recovery device monitoring requirements.* (1) Where an absorber is the final recovery device in the recovery system and the TRE index value is between the level specified in a referencing subpart and

4.0, either an organic monitoring device capable of providing a continuous record or a scrubbing liquid temperature monitoring device and a specific gravity monitoring device, each capable of providing a continuous record, shall be used. If the difference between the specific gravity of the saturated scrubbing fluid and specific gravity of the fresh scrubbing fluid is less than 0.02 specific gravity units, an organic monitoring device capable of providing a continuous record shall be used. Monitoring results shall be recorded as specified in §63.998(b) and (c), as applicable. General requirements for monitoring and continuous parameter monitoring systems are contained in §63.996.

(2) Where a condenser is the final recovery device in the recovery system and the TRE index value is between the level specified in a referencing subpart and 4.0, an organic monitoring device capable of providing a continuous record or a condenser exit (product side) temperature monitoring device capable of providing a continuous record shall be used. Monitoring results shall be recorded as specified in §63.998(b) and (c), as applicable. General requirements for monitoring and continuous parameter monitoring systems are contained in a referencing subpart and §63.996.

(3) Where a carbon adsorber is the final recovery device in the recovery system and the TRE index value is between the level specified in a referencing subpart and 4.0, an organic monitoring device capable of providing a continuous record or an integrating regeneration stream flow monitoring device having an accuracy of  $\pm 10$  percent or better, capable of recording the total regeneration stream mass or volumetric flow for each regeneration cycle; and a carbon-bed temperature monitoring device, capable of recording the carbon-bed temperature after each regeneration and within 15 minutes of completing any cooling cycle shall be used. Monitoring results shall be recorded as specified in §63.998(b) and (c), as applicable. General requirements for monitoring and continuous parameter monitoring systems are contained in a referencing subpart and §63.996.

(4) If an owner or operator uses a recovery device other than those listed in this subpart, the owner or operator shall submit a description of planned monitoring, reporting and recordkeeping procedures as specified in a referencing subpart. The Administrator will approve, deny, or modify based on the reasonableness of the proposed monitoring, reporting and recordkeeping requirements as part of the review of the submission or permit application or by other appropriate means.

#### **§63.994 Halogen scrubbers and other halogen reduction devices.**

*(a) Halogen scrubber and other halogen reduction device equipment and operating requirements.* (1) An owner or operator of a halogen scrubber or other halogen reduction device subject to this subpart shall reduce the overall emissions of hydrogen halides and halogens by the control device performance level specified in a referencing subpart.

(2) Halogen scrubbers and other halogen reduction devices used to comply with the provisions of a referencing subpart and this subpart shall be operated at all times when emissions are vented to them.

*(b) Halogen scrubber and other halogen reduction device performance test requirements.* (1) An owner or operator of a combustion device followed by a halogen scrubber or other halogen reduction device to control halogenated vent streams in accordance with a referencing subpart and this subpart shall conduct an initial performance test to determine compliance with the control efficiency or emission limits for hydrogen halides and halogens according to the procedures in §63.997. Performance test records shall be kept as specified in §63.998(a)(2) and a performance test report shall be submitted as specified in §63.999(a)(2).

(2) An owner or operator of a halogen scrubber or other halogen reduction technique used to reduce the vent stream halogen atom mass emission rate prior to a combustion device to comply with a performance level specified in a referencing subpart shall determine the halogen atom mass emission rate prior to the combustion device according to the procedures specified in the referencing subpart. Records of the halogen concentration in the vent stream shall be generated as specified in §63.998(a)(4).

(c) *Halogen scrubber and other halogen reduction device monitoring requirements.* (1) Where a halogen scrubber is used, the monitoring equipment specified in paragraphs (c)(1)(i) and (ii) of this section is required for the scrubber. Monitoring results shall be recorded as specified in §63.998(b) and (c), as applicable. General requirements for monitoring and continuous parameter monitoring systems are contained in a referencing subpart and §63.996.

(i) A pH monitoring device capable of providing a continuous record shall be installed to monitor the pH of the scrubber effluent.

(ii) A flow meter capable of providing a continuous record shall be located at the scrubber influent for liquid flow. Gas stream flow shall be determined using one of the procedures specified in paragraphs (c)(1)(ii)(A) through (D) of this section.

(A) The owner or operator may determine gas stream flow using the design blower capacity, with appropriate adjustments for pressure drop.

(B) The owner or operator may measure the gas stream flow at the scrubber inlet.

(C) If the scrubber is subject to regulations in 40 CFR parts 264 through 266 that have required a determination of the liquid to gas (L/G) ratio prior to the applicable compliance date for the process unit of which it is part as specified in a referencing subpart, the owner or operator may determine gas stream flow by the method that had been utilized to comply with those regulations. A determination that was conducted prior to that compliance date may be utilized to comply with this subpart if it is still representative.

(D) The owner or operator may prepare and implement a gas stream flow determination plan that documents an appropriate method that will be used to determine the gas stream flow. The plan shall require determination of gas stream flow by a method that will at least provide a value for either a representative or the highest gas stream flow anticipated in the scrubber during representative operating conditions other than start-ups, shutdowns, or malfunctions. The plan shall include a description of the methodology to be followed and an explanation of how the selected methodology will reliably determine the gas stream flow, and a description of the records that will be maintained to document the determination of gas stream flow. The owner or operator shall maintain the plan as specified in a referencing subpart.

(2) Where a halogen reduction device other than a scrubber is used, the owner or operator shall follow the procedures specified in a referencing subpart in order to establish monitoring parameters.

#### **§63.995 Other control devices.**

(a) *Other control device equipment and operating requirements.* (1) Owners or operators using a control device other than one listed in §§63.985 through 63.990 to meet a weight-percent emission reduction or parts per million by volume outlet concentration requirement specified in a referencing subpart shall meet the requirements of this section.

(2) Other control devices used to comply with the provisions of a referencing subpart and this subpart shall be operated at all times when emissions are vented to them.

(b) *Other control device performance test requirements.* An owner or operator using a control device other than those specified in §§63.987 through 63.990 to comply with a performance level specified in a referencing subpart, shall perform an initial performance test according to the procedures in §63.997. Performance test records shall be kept as specified in §63.998(a)(2) and a performance test report shall be submitted as specified in §63.999(a)(2).

(c) *Other control device monitoring requirements.* If an owner or operator uses a control device other than those listed in this subpart, the owner or operator shall submit a description of planned monitoring, recordkeeping and reporting procedures as specified in a referencing subpart. The Administrator will approve, deny, or modify based on the reasonableness of the proposed monitoring, reporting and recordkeeping requirements as part of the review of the submission or permit application or by other appropriate means.

**§63.996 General monitoring requirements for control and recovery devices.**

(a) *General monitoring requirements applicability.* (1) This section applies to the owner or operator of a regulated source required to monitor under this subpart.

(2) Flares subject to §63.987(c) are not subject to the requirements of this section.

(3) Flow indicators are not subject to the requirements of this section.

(b) *Conduct of monitoring.* (1) Monitoring shall be conducted as set forth in this section and in the relevant sections of this subpart unless the provision in either paragraph (b)(1)(i) or (ii) of this section applies.

(i) The Administrator specifies or approves the use of minor changes in methodology for the specified monitoring requirements and procedures; or

(ii) The Administrator approves the use of alternatives to any monitoring requirements or procedures as provided in the referencing subpart or paragraph (d) of this section.

(2) When one CPMS is used as a backup to another CPMS, the owner or operator shall report the results from the CPMS used to meet the monitoring requirements of this subpart. If both such CPMS's are used during a particular reporting period to meet the monitoring requirements of this subpart, then the owner or operator shall report the results from each CPMS for the time during the six month period that the instrument was relied upon to demonstrate compliance.

(c) *Operation and maintenance of continuous parameter monitoring systems.* (1) All monitoring equipment shall be installed, calibrated, maintained, and operated according to manufacturer's specifications or other written procedures that provide adequate assurance that the equipment would reasonably be expected to monitor accurately.

(2) The owner or operator of a regulated source shall maintain and operate each CPMS as specified in this section, or in a relevant subpart, and in a manner consistent with good air pollution control practices.

(i) The owner or operator of a regulated source shall ensure the immediate repair or replacement of CPMS parts to correct "routine" or otherwise predictable CPMS malfunctions. The necessary parts for routine repairs of the affected equipment shall be readily available.

(ii) If under the referencing subpart, an owner or operator has developed a start-up, shutdown, and malfunction plan, the plan is followed, and the CPMS is repaired immediately, this action shall be recorded as specified in §63.998(c)(1)(ii)(E).

(iii) The Administrator's determination of whether acceptable operation and maintenance procedures are being used for the CPMS will be based on information that may include, but is not limited to, review of operation and maintenance procedures, operation and maintenance records as specified in

§63.998(c)(1)(i) and (ii), manufacturer's recommendations and specifications, and inspection of the CPMS.

(3) All CPMS's shall be installed and operational, and the data verified as specified in this subpart either prior to or in conjunction with conducting performance tests. Verification of operational status shall, at a minimum, include completion of the manufacturer's written specifications or recommendations for installation, operation, and calibration of the system or other written procedures that provide adequate assurance that the equipment would reasonably be expected to monitor accurately.

(4) All CPMS's shall be installed such that representative measurements of parameters from the regulated source are obtained.

(5) In accordance with the referencing subpart, except for system breakdowns, repairs, maintenance periods, instrument adjustments, or checks to maintain precision and accuracy, calibration checks, and zero and span adjustments, all continuous parameter monitoring systems shall be in continuous operation when emissions are being routed to the monitored device.

(6) The owner or operator shall establish a range for monitored parameters that indicates proper operation of the control or recovery device. In order to establish the range, the information required in §63.999(b)(3) shall be submitted in the Notification of Compliance Status or the operating permit application or amendment. The range may be based upon a prior performance test meeting the specifications of §63.997(b)(1) or a prior TRE index value determination, as applicable, or upon existing ranges or limits established under a referencing subpart. Where the regeneration stream flow and carbon bed temperature are monitored, the range shall be in terms of the total regeneration stream flow per regeneration cycle and the temperature of the carbon bed determined within 15 minutes of the completion of the regeneration cooling cycle.

(d) *Alternatives to monitoring requirements—(1) Alternatives to the continuous operating parameter monitoring and recordkeeping provisions.* An owner or operator may request approval to use alternatives to the continuous operating parameter monitoring and recordkeeping provisions listed in §§63.988(c), 63.990(c), 63.993(c), 63.994(c), 63.998(a)(2) through (4), 63.998(c)(2) and (3), as specified in §63.999(d)(1).

(2) *Monitoring a different parameter than those listed.* An owner or operator may request approval to monitor a different parameter than those established in paragraph (c)(6) of this section or to set unique monitoring parameters if directed by §63.994(c)(2) or §63.995(c), as specified in §63.999(d)(2).

### **§63.997 Performance test and compliance assessment requirements for control devices.**

(a) *Performance tests and flare compliance assessments.* Where §§63.985 through 63.995 require, or the owner or operator elects to conduct, a performance test of a control device or a halogen reduction device, or a compliance assessment for a flare, the requirements of paragraphs (b) through (d) of this section apply.

(b) *Prior test results and waivers.* Initial performance tests and initial flare compliance assessments are required only as specified in this subpart or a referencing subpart.

(1) Unless requested by the Administrator, an owner or operator is not required to conduct a performance test or flare compliance assessment under this subpart if a prior performance test or compliance assessment was conducted using the same methods specified in §63.997(e) or §63.987(b)(3), as applicable, and either no process changes have been made since the test, or the owner or operator can demonstrate that the results of the performance test or compliance demonstration, with or without adjustments, reliably demonstrate compliance despite process changes. An owner or operator



may request permission to substitute a prior performance test or compliance assessment by written application to the Administrator as specified in §63.999(a)(1)(iv).

(2) Individual performance tests and flare compliance assessments may be waived upon written application to the Administrator, per §63.999(a)(1)(iii), if, in the Administrator's judgment, the source is meeting the relevant standard(s) on a continuous basis, the source is being operated under an extension or waiver of compliance, or the owner or operator has requested an extension or waiver of compliance and the Administrator is still considering that request.

(3) Approval of any waiver granted under this section shall not abrogate the Administrator's authority under the Act or in any way prohibit the Administrator from later canceling the waiver. The cancellation will be made only after notification is given to the owner or operator of the source.

(c) *Performance tests and flare compliance assessments schedule.* (1) Unless a waiver of performance testing or flare compliance assessment is obtained under this section or the conditions of a referencing subpart, the owner or operator shall perform such tests as specified in paragraphs (c)(1)(i) through (vii) of this section.

(i) Within 180 days after the effective date of a relevant standard for a new source that has an initial start-up date before the effective date of that standard; or

(ii) Within 180 days after initial start-up for a new source that has an initial start-up date after the effective date of a relevant standard; or

(iii) Within 180 days after the compliance date specified in a referencing subpart for an existing source, or within 180 days after start-up of an existing source if the source begins operation after the effective date of the relevant emission standard; or

(iv) Within 180 days after the compliance date for an existing source subject to an emission standard established pursuant to section 112(f) of the Act; or

(v) Within 180 days after the termination date of the source's extension of compliance or a waiver of compliance for an existing source that obtains an extension of compliance under §63.1112(a), or waiver of compliance under 40 CFR 61.11; or

(vi) Within 180 days after the compliance date for a new source, subject to an emission standard established pursuant to section 112(f) of the Act, for which construction or reconstruction is commenced after the proposal date of a relevant standard established pursuant to section 112(d) of the Act but before the proposal date of the relevant standard established pursuant to section 112(f); or

(vii) When the promulgated emission standard in a referencing subpart is more stringent than the standard that was proposed, the owner or operator of a new or reconstructed source subject to that standard for which construction or reconstruction is commenced between the proposal and promulgation dates of the standard shall comply with performance testing requirements within 180 days after the standard's effective date, or within 180 days after start-up of the source, whichever is later. If a promulgated standard in a referencing subpart is more stringent than the proposed standard, the owner or operator may choose to demonstrate compliance initially with either the proposed or the promulgated standard. If the owner or operator chooses to comply with the proposed standard initially, the owner or operator shall conduct a second performance test within 3 years and 180 days after the effective date of the standard, or after start-up of the source, whichever is later, to demonstrate compliance with the promulgated standard.

(2) The Administrator may require an owner or operator to conduct performance tests and compliance assessments at the regulated source at any time when the action is authorized by section 114 of the Act.

(3) Unless already permitted by the applicable title V permit, if an owner or operator elects to use a recovery device to replace an existing control device at a later date, or elects to use a different flare, nonflare control device or recovery device to replace an existing flare, nonflare control device or final recovery device at a later date, the owner or operator shall notify the Administrator, either by amendment of the regulated source's title V permit or, if title V is not applicable, by submission of the notice specified in §63.999(c)(7) before implementing the change. Upon implementing the change, a compliance demonstration or performance test shall be performed according to the provisions of paragraphs (c)(3)(i) through (v) of this section, as applicable, within 180 days. The compliance assessment report shall be submitted to the Administrator within 60 days of completing the determination, as provided in §63.999(a)(1)(ii).

(i) For flares used to replace an existing control device, a flare compliance demonstration shall be performed using the methods specified in §63.987(b);

(ii) For flares used to replace an existing final recovery device that is used on an applicable process vent, the owner or operator shall comply with the applicable provisions in a referencing subpart and in this subpart;

(iii) For incinerators, boilers, or process heaters used to replace an existing control device, a performance test shall be performed, using the methods specified in §63.997;

(iv) For absorbers, condensers, or carbon adsorbers used to replace an existing control device on a process vent or a transfer rack, a performance test shall be performed, using the methods specified in §63.997;

(v) For absorbers, condensers, or carbon adsorbers used to replace an existing final recovery device on a process vent, the owner or operator shall comply with the applicable provisions of a referencing subpart and this subpart;

(d) *Performance testing facilities.* If required to do performance testing, the owner or operator of each new regulated source and, at the request of the Administrator, the owner or operator of each existing regulated source, shall provide performance testing facilities as specified in paragraphs (d)(1) through (5) of this section.

(1) Sampling ports adequate for test methods applicable to such source. This includes, as applicable, the requirements specified in (d)(1)(i) and (ii) of this section.

(i) Constructing the air pollution control system such that volumetric flow rates and pollutant emission rates can be accurately determined by applicable test methods and procedures; and

(ii) Providing a stack or duct free of cyclonic flow during performance tests, as demonstrated by applicable test methods and procedures;

(2) Safe sampling platform(s);

(3) Safe access to sampling platform(s);

(4) Utilities for sampling and testing equipment; and

(5) Any other facilities that the Administrator deems necessary for safe and adequate testing of a source.

(e) *Performance test procedures.* Where §§63.985 through 63.995 require the owner or operator to conduct a performance test of a control device or a halogen reduction device, the owner or operator shall follow the requirements of paragraphs (e)(1)(i) through (v) of this section, as applicable.

(1) *General procedures.* (i) *Continuous unit operations.* For continuous unit operations, performance tests shall be conducted at maximum representative operating conditions for the process, unless the Administrator specifies or approves alternate operating conditions. During the performance test, an owner or operator may operate the control or halogen reduction device at maximum or minimum representative operating conditions for monitored control or halogen reduction device parameters, whichever results in lower emission reduction. Operations during periods of start-up, shutdown, and malfunction shall not constitute representative conditions for the purpose of a performance test.

(ii) [Reserved]

(iii) *Combination of both continuous and batch unit operations.* For a combination of both continuous and batch unit operations, performance tests shall be conducted at maximum representative operating conditions. For the purpose of conducting a performance test on a combined vent stream, maximum representative operating conditions shall be when batch emission episodes are occurring that result in the highest organic HAP emission rate (for the combined vent stream) that is achievable during the 6-month period that begins 3 months before and ends 3 months after the compliance assessment (e.g. TRE calculation, performance test) without causing any of the situations described in paragraphs (e)(1)(iii)(A) through (C) of this section.

(A) Causing damage to equipment;

(B) Necessitating that the owner or operator make product that does not meet an existing specification for sale to a customer; or

(C) Necessitating that the owner or operator make product in excess of demand.

(iv) *Alternatives to performance test requirements.* Performance tests shall be conducted and data shall be reduced in accordance with the test methods and procedures set forth in this subpart, in each relevant standard, and, if required, in applicable appendices of 40 CFR parts 51, 60, 61, and 63 unless the Administrator specifies one of the provisions in paragraphs (e)(1)(iv)(A) through (E) of this section.

(A) Specifies or approves, in specific cases, the use of a test method with minor changes in methodology; or

(B) Approves the use of an alternative test method, the results of which the Administrator has determined to be adequate for indicating whether a specific regulated source is in compliance. The alternate method or data shall be validated using the applicable procedures of Method 301 of appendix A of 40 CFR part 63; or

(C) Approves shorter sampling times and smaller sample volumes when necessitated by process variables or other factors; or

(D) Waives the requirement for the performance test as specified in paragraph (b)(2) of this section because the owner or operator of a regulated source has demonstrated by other means to the Administrator's satisfaction that the regulated source is in compliance with the relevant standard; or

(E) Approves the use of an equivalent method.

(v) *Performance test runs.* Except as provided in paragraphs (e)(1)(v)(A) and (B) of this section, each performance test shall consist of three separate runs using the applicable test method. Each run shall be conducted for at least 1 hour and under the conditions specified in this section. For the purpose of determining compliance with an applicable standard, the arithmetic means of results of the three runs shall apply. In the event that a sample is accidentally lost or conditions occur in which one of the three runs must be discontinued because of forced shutdown, failure of an irreplaceable portion of the sample train, extreme meteorological conditions, or other circumstances, beyond the owner or operator's control, compliance may, upon the Administrator's approval, be determined using the arithmetic mean of the results of the two other runs.

(A) For control devices used to control emissions from transfer racks (except low throughput transfer racks that are capable of continuous vapor processing but do not handle continuous emissions or multiple loading arms of a transfer rack that load simultaneously), each run shall represent at least one complete tank truck or tank car loading period, during which regulated materials are loaded, and samples shall be collected using integrated sampling or grab samples taken at least four times per hour at approximately equal intervals of time, such as 15-minute intervals.

(B) For intermittent vapor processing systems used for controlling transfer rack emissions (except low throughput transfer racks that do not handle continuous emissions or multiple loading arms of a transfer rack that load simultaneously), each run shall represent at least one complete control device cycle, and samples shall be collected using integrated sampling or grab samples taken at least four times per hour at approximately equal intervals of time, such as 15-minute intervals.

(2) *Specific procedures.* Where §§63.985 through 63.995 require the owner or operator to conduct a performance test of a control device, or a halogen reduction device, an owner or operator shall conduct that performance test using the procedures in paragraphs (e)(2)(i) through (iv) of this section, as applicable. The regulated material concentration and percent reduction may be measured as either total organic regulated material or as TOC minus methane and ethane according to the procedures specified.

(i) *Selection of sampling sites.* Method 1 or 1A of 40 CFR part 60, appendix A, as appropriate, shall be used for selection of the sampling sites.

(A) For determination of compliance with a percent reduction requirement of total organic regulated material or TOC, sampling sites shall be located as specified in paragraphs (e)(2)(i)(A)(1) and (e)(2)(i)(A)(2) of this section, and at the outlet of the control device.

(1) With the exceptions noted below in paragraphs (e)(2)(i)(A)(2) and (3), the control device inlet sampling site shall be located at the exit from the unit operation before any control device.

(2) For process vents from continuous unit operations at affected sources in subcategories where the applicability criteria includes a TRE index value, the control device inlet sampling site shall be located after the final recovery device.

(3) If a vent stream is introduced with the combustion air or as a secondary fuel into a boiler or process heater with a design capacity less than 44 megawatts, selection of the location of the inlet sampling sites shall ensure the measurement of total organic regulated material or TOC (minus methane and ethane) concentrations, as applicable, in all vent streams and primary and secondary fuels introduced into the boiler or process heater.

(B) For determination of compliance with a parts per million by volume total regulated material or TOC limit in a referencing subpart, the sampling site shall be located at the outlet of the control device.

(ii) *Gas volumetric flow rate.* The gas volumetric flow rate shall be determined using Method 2, 2A, 2C, 2D, 2F, or 2G of 40 CFR part 60, appendix A, as appropriate.

(iii) *Total organic regulated material or TOC concentration.* To determine compliance with a parts per million by volume total organic regulated material or TOC limit, the owner or operator shall use Method 18 or 25A of 40 CFR part 60, appendix A, as applicable. The ASTM D6420-99 may be used in lieu of Method 18 of 40 CFR part 60, appendix A, under the conditions specified in paragraphs (e)(2)(iii)(D)(1) through (3) of this section. Alternatively, any other method or data that have been validated according to the applicable procedures in Method 301 of appendix A of 40 CFR part 63 may be used. The procedures specified in paragraphs (e)(2)(iii)(A), (B), (D), and (E) of this section shall be used to calculate parts per million by volume concentration. The calculated concentration shall be corrected to 3 percent oxygen using the procedures specified in paragraph (e)(2)(iii)(C) of this section if a combustion device is the control device and supplemental combustion air is used to combust the emissions.

(A) *Sampling time.* For continuous unit operations and for a combination of both continuous and batch unit operations, the minimum sampling time for each run shall be 1 hour in which either an integrated sample or a minimum of four grab samples shall be taken. If grab sampling is used, then the samples shall be taken at approximately equal intervals in time, such as 15 minute intervals during the run.

(B) *Concentration calculation.* The concentration of either TOC (minus methane or ethane) or total organic regulated material shall be calculated according to paragraph (e)(2)(iii)(B) (1) or (2) of this section.

(1) The TOC concentration ( $C_{\text{TOC}}$ ) is the sum of the concentrations of the individual components and shall be computed for each run using Equation 2.

$$C_{\text{TOC}} = \sum_{i=1}^x \left[ \frac{\sum_{j=1}^n C_{ji}}{x} \right] \quad [\text{Eq. 2}]$$

Where:

$C_{\text{TOC}}$  = Concentration of TOC (minus methane and ethane), dry basis, parts per million by volume.

$x$  = Number of samples in the sample run.

$n$  = Number of components in the sample.

$C_{ji}$  = Concentration of sample components  $j$  of sample  $i$ , dry basis, parts per million by volume.

(2) The total organic regulated material ( $C_{\text{REG}}$ ) shall be computed according to Equation 2 in paragraph (e)(2)(iii)(B) (1) of this section except that only the regulated species shall be summed.

(C) *Concentration correction calculation.* The concentration of TOC or total organic regulated material, as applicable, shall be corrected to 3 percent oxygen if a combustion device is the control device and supplemental combustion air is used to combust the emissions.

(1) The emission rate correction factor (or excess air), integrated sampling and analysis procedures of Method 3B of 40 CFR part 60, appendix A, or American Society of Mechanical Engineers (ASME) PTC 19-10-1981-Part 10 (available for purchase from: ASME International, Three Park Avenue, New York, NY 10016-5990, 800-843-2763 or 212-591-7722), shall be used to determine the oxygen concentration. The sampling site shall be the same as that of the organic regulated material or organic compound samples,

and the samples shall be taken during the same time that the organic regulated material or organic compound samples are taken.

(2) The concentration corrected to 3 percent oxygen ( $C_c$ ) shall be computed using Equation 3.

$$C_c = C_m \left( \frac{17.9}{20.9 - \%O_{2d}} \right) \quad [Eq. 3]$$

Where:

$C_c$  = Concentration of TOC or organic regulated material corrected to 3 percent oxygen, dry basis, parts per million by volume.

$C_m$  = Concentration of TOC (minus methane and ethane) or organic regulated material, dry basis, parts per million by volume.

$\%O_{2d}$  = Concentration of oxygen, dry basis, percentage by volume.

(D) To measure the total organic regulated material concentration at the outlet of a control device, use Method 18 of 40 CFR part 60, appendix A, or ASTM D6420-99. If you have a combustion control device, you must first determine which regulated material compounds are present in the inlet gas stream using process knowledge or the screening procedure described in Method 18. In conducting the performance test, analyze samples collected at the outlet of the combustion control device as specified in Method 18 or ASTM D6420-99 for the regulated material compounds present at the inlet of the control device. The method ASTM D6420-99 may be used only under the conditions specified in paragraphs (e)(2)(iii)(D)(1) through (3) of this section.

(1) If the target compound(s) is listed in Section 1.1 of ASTM D6420-99 and the target concentration is between 150 parts per billion by volume and 100 parts per million by volume.

(2) If the target compound(s) is not listed in Section 1.1 of ASTM D6420-99 but is potentially detected by mass spectrometry, an additional system continuing calibration check after each run, as detailed in Section 10.5.3 of ASTM D6420-99, must be followed, met, documented, and submitted with the performance test report even if you do not use a moisture condenser or the compound is not considered soluble.

(3) If a minimum of one sample/analysis cycle is completed at least every 15 minutes.

(E) To measure the TOC concentration, use Method 18 of 40 CFR part 60, appendix A, or use Method 25A of 40 CFR part 60, appendix A, according to the procedures in paragraphs (e)(2)(iii)(E)(1) through (4) of this section.

(1) Calibrate the instrument on the predominant regulated material compound.

(2) The test results are acceptable if the response from the high level calibration gas is at least 20 times the standard deviation for the response from the zero calibration gas when the instrument is zeroed on its most sensitive scale.

(3) The span value of the analyzer must be less than 100 parts per million by volume.

(4) Report the results as carbon, calculated according to Equation 25A-1 of Method 25A of 40 CFR part 60, appendix A.

(iv) *Percent reduction calculation.* To determine compliance with a percent reduction requirement, the owner or operator shall use Method 18, 25, or 25A of 40 CFR part 60, appendix A, as applicable. The method ASTM D6420-99 may be used in lieu of Method 18 of 40 CFR part 60, appendix A, under the conditions specified in paragraphs (e)(2)(iii)(D)(1) through (3) of this section. Alternatively, any other method or data that have been validated according to the applicable procedures in Method 301 of appendix A of 40 CFR part 63 may be used. The procedures specified in paragraphs (e)(2)(iv)(A) through (I) of this section shall be used to calculate percent reduction efficiency.

(A) *Sampling time.* The minimum sampling time for each run shall be 1 hour in which either an integrated sample or a minimum of four grab samples shall be taken. If grab sampling is used, then the samples shall be taken at approximately equal intervals in time, such as 15-minute intervals during the run.

(B) *Mass rate of TOC or total organic regulated material.* The mass rate of either TOC (minus methane and ethane) or total organic regulated material ( $E_i$ ,  $E_o$ ) shall be computed as applicable.

(1) Equations 4 and 5 shall be used.

$$E_i = K_2 \left( \sum_{j=1}^n C_{i,j} M_{i,j} \right) Q_i \quad [Eq. 4]$$

$$E_o = K_2 \left( \sum_{j=1}^n C_{o,j} M_{o,j} \right) Q_o \quad [Eq. 5]$$

Where:

$E_i$ ,  $E_o$  = Emission rate of TOC (minus methane and ethane) ( $E_{TOC}$ ) or emission rate of total organic regulated material ( $E_{RM}$ ) in the sample at the inlet and outlet of the control device, respectively, dry basis, kilogram per hour.

$K_2$  = Constant,  $2.494 \times 10^{-6}$  (parts per million)<sup>-1</sup> (gram-mole per standard cubic meter) (kilogram per gram) (minute per hour), where standard temperature (gram-mole per standard cubic meter) is 20 °C.

$n$  = Number of components in the sample.

$C_i$ ,  $C_o$  = Concentration on a dry basis of organic compound  $j$  in parts per million by volume of the gas stream at the inlet and outlet of the control device, respectively. If the TOC emission rate is being calculated,  $C_i$  and  $C_o$  include all organic compounds measured minus methane and ethane; if the total organic regulated material emissions rate is being calculated, only organic regulated material are included.

$M_i$ ,  $M_o$  = Molecular weight of organic compound  $j$ , gram per gram-mole, of the gas stream at the inlet and outlet of the control device, respectively.

$Q_i$ ,  $Q_o$  = Process vent flow rate, dry standard cubic meter per minute, at a temperature of 20 °C, at the inlet and outlet of the control device, respectively.

(2)-(3) [Reserved]

(C) *Percent reduction in TOC or total organic regulated material for continuous unit operations and a combination of both continuous and batch unit operations.* For continuous unit operations and for a combination of both continuous and batch unit operations, the percent reduction in TOC (minus methane and ethane) or total organic regulated material shall be calculated using Equation 6.

$$R = \frac{E_i - E_o}{E_i} (100) \quad [Eq. 6]$$

Where:

R = Control efficiency of control device, percent.

$E_i$  = Mass rate of TOC (minus methane and ethane) or total organic regulated material at the inlet to the control device as calculated under paragraph (e)(2)(iv)(B) of this section, kilograms TOC per hour or kilograms organic regulated material per hour.

$E_o$  = Mass rate of TOC (minus methane and ethane) or total organic regulated material at the outlet of the control device, as calculated under paragraph (e)(2)(iv)(B) of this section, kilograms TOC per hour or kilograms total organic regulated material per hour.

(D) *Vent stream introduced with combustion air or as secondary fuel.* If the vent stream entering a boiler or process heater with a design capacity less than 44 megawatts is introduced with the combustion air or as a secondary fuel, the weight-percent reduction of total organic regulated material or TOC (minus methane and ethane) across the device shall be determined by comparing the TOC (minus methane and ethane) or total organic regulated material in all combusted vent streams and primary and secondary fuels with the TOC (minus methane and ethane) or total organic regulated material exiting the combustion device, respectively.

(E) *Transfer racks.* Method 25A of 40 CFR part 60, appendix A, may also be used for the purpose of determining compliance with the percent reduction requirement for transfer racks.

(1) If Method 25A of 40 CFR part 60, appendix A, is used to measure the concentration of organic compounds ( $C_{\text{TOC}}$ ), the principal organic regulated material in the vent stream shall be used as the calibration gas.

(2) An emission testing interval shall consist of each 15-minute period during the performance test. For each interval, a reading from each measurement shall be recorded.

(3) The average organic compound concentration and the volume measurement shall correspond to the same emissions testing interval.

(4) The mass at the inlet and outlet of the control device during each testing interval shall be calculated using Equation 7.

$$M_j = FKV_j C_j \quad [Eq. 7]$$

Where:

$M_j$  = Mass of organic compounds emitted during testing interval j, kilograms.

F =  $10^{-6}$  = Conversion factor, (cubic meters regulated material per cubic meters air) \* (parts per million by volume)<sup>-1</sup>.

K = Density, kilograms per standard cubic meter organic regulated material.

= 659 kilograms per standard cubic meter organic regulated material. (Note: The density term cancels out when the percent reduction is calculated. Therefore, the density used has no effect. The density of hexane is given so that it can be used to maintain the units of  $M_j$ .)

$V_s$  = Volume of air-vapor mixture exhausted at standard conditions, 20 °C and 760 millimeters mercury, standard cubic meters.



$C_i$  = Total concentration of organic compounds (as measured) at the exhaust vent, parts per million by volume, dry basis.

(5) The organic compound mass emission rates at the inlet and outlet of the control device shall be calculated using Equations 8 and 9 as follows:

$$E_i = \frac{\sum_{j=1}^n M_{i,j}}{T} \quad [Eq. 8]$$

$$E_o = \frac{\sum_{j=1}^n M_{o,j}}{T} \quad [Eq. 9]$$

Where:

$E_i$ ,  $E_o$  = Mass flow rate of organic compounds at the inlet (i) and outlet (o) of the control device, kilograms per hour.

$n$  = Number of testing intervals.

$M_i$ ,  $M_o$  = Mass of organic compounds at the inlet (i) or outlet (o) during testing interval  $j$ , kilograms.

$T$  = Total time of all testing intervals, hours.

(F) To measure inlet and outlet concentrations of total organic regulated material, use Method 18 of 40 CFR part 60, appendix A, or ASTM D6420-99, under the conditions specified in paragraphs (e)(2)(iii)(D)(1) through (3) of this section. In conducting the performance test, collect and analyze samples as specified in Method 18 or ASTM D6420-99. You must collect samples simultaneously at the inlet and outlet of the control device. If the performance test is for a combustion control device, you must first determine which regulated material compounds are present in the inlet gas stream (i.e., uncontrolled emissions) using process knowledge or the screening procedure described in Method 18. Quantify the emissions for the regulated material compounds present in the inlet gas stream for both the inlet and outlet gas streams for the combustion device.

(G) To determine inlet and outlet concentrations of TOC, use Method 25 of 40 CFR part 60, appendix A. Measure the total gaseous non-methane organic (TGNMO) concentration of the inlet and outlet vent streams using the procedures of Method 25. Use the TGNMO concentration in Equations 4 and 5 of paragraph (e)(2)(iv)(B) of this section.

(H) Method 25A of 40 CFR part 60, appendix A, may be used instead of Method 25 to measure inlet and outlet concentrations of TOC if the condition in either paragraph (e)(2)(iv)(H)(1) or (2) of this section is met.

(1) The concentration at the inlet to the control system and the required level of control would result in exhaust TGNMO concentrations of 50 parts per million by volume or less.

(2) Because of the high efficiency of the control device, the anticipated TGNMO concentration of the control device exhaust is 50 parts per million by volume or less, regardless of the inlet concentration.

(I) If the uncontrolled or inlet gas stream to the control device contains formaldehyde, you must conduct emissions testing according to paragraph (e)(2)(iv)(I)(1) or (2) of this section.

(1) If you elect to comply with a percent reduction requirement and formaldehyde is the principal regulated material compound (i.e., greater than 50 percent of the regulated material compounds in the stream by volume), you must use Method 316 or 320 of 40 CFR part 63, appendix A, to measure formaldehyde at the inlet and outlet of the control device. Use the percent reduction in formaldehyde as a surrogate for the percent reduction in total regulated material emissions.

(2) If you elect to comply with an outlet total organic regulated material concentration or TOC concentration limit, and the uncontrolled or inlet gas stream to the control device contains greater than 10 percent (by volume) formaldehyde, you must use Method 316 or 320 of 40 CFR part 63, appendix A, to separately determine the formaldehyde concentration. Calculate the total organic regulated material concentration or TOC concentration by totaling the formaldehyde emissions measured using Method 316 or 320 and the other regulated material compound emissions measured using Method 18 or 25/25A.

(3) An owner or operator using a halogen scrubber or other halogen reduction device to control process vent and transfer rack halogenated vent streams in compliance with a referencing subpart, who is required to conduct a performance test to determine compliance with a control efficiency or emission limit for hydrogen halides and halogens, shall follow the procedures specified in paragraphs (e)(3) (i) through (iv) of this section.

(i) For an owner or operator determining compliance with the percent reduction of total hydrogen halides and halogens, sampling sites shall be located at the inlet and outlet of the scrubber or other halogen reduction device used to reduce halogen emissions. For an owner or operator determining compliance with a kilogram per hour outlet emission limit for total hydrogen halides and halogens, the sampling site shall be located at the outlet of the scrubber or other halogen reduction device and prior to any releases to the atmosphere.

(ii) Except as provided in paragraph (e)(1)(iv) of this section, Method 26 or Method 26A of 40 CFR part 60, appendix A, shall be used to determine the concentration, in milligrams per dry standard cubic meter, of total hydrogen halides and halogens that may be present in the vent stream. The mass emissions of each hydrogen halide and halogen compound shall be calculated from the measured concentrations and the gas stream flow rate.

(iii) To determine compliance with the percent removal efficiency, the mass emissions for any hydrogen halides and halogens present at the inlet of the halogen reduction device shall be summed together. The mass emissions of the compounds present at the outlet of the scrubber or other halogen reduction device shall be summed together. Percent reduction shall be determined by comparison of the summed inlet and outlet measurements.

(iv) To demonstrate compliance with a kilogram per hour outlet emission limit, the test results must show that the mass emission rate of total hydrogen halides and halogens measured at the outlet of the scrubber or other halogen reduction device is below the kilogram per hour outlet emission limit specified in a referencing subpart.

[64 FR 34866, June 29, 1999, as amended at 67 FR 46277, July 12, 2002]

### **§63.998 Recordkeeping requirements.**

(a) *Compliance assessment, monitoring, and compliance records*—(1) *Conditions of flare compliance assessment, monitoring, and compliance records.* Upon request, the owner or operator shall make available to the Administrator such records as may be necessary to determine the conditions of flare compliance assessments performed pursuant to §63.987(b).

(i) *Flare compliance assessment records.* When using a flare to comply with this subpart, record the information specified in paragraphs (a)(1)(i)(A) through (C) of this section for each flare compliance

assessment performed pursuant to §63.987(b). As specified in §63.999(a)(2)(iii)(A), the owner or operator shall include this information in the flare compliance assessment report.

(A) Flare design (i.e., steam-assisted, air-assisted, or non-assisted);

(B) All visible emission readings, heat content determinations, flow rate measurements, and exit velocity determinations made during the flare compliance assessment; and

(C) All periods during the flare compliance assessment when all pilot flames are absent or, if only the flare flame is monitored, all periods when the flare flame is absent.

(ii) *Monitoring records.* Each owner or operator shall keep up to date and readily accessible hourly records of whether the monitor is continuously operating and whether the flare flame or at least one pilot flame is continuously present. For transfer racks, hourly records are required only while the transfer rack vent stream is being vented.

(iii) *Compliance records.* (A) Each owner or operator shall keep records of the times and duration of all periods during which the flare flame or all the pilot flames are absent. This record shall be submitted in the periodic reports as specified in §63.999(c)(3).

(B) Each owner or operator shall keep records of the times and durations of all periods during which the monitor is not operating.

(2) *Nonflare control device performance test records.* (i) *Availability of performance test records.* Upon request, the owner or operator shall make available to the Administrator such records as may be necessary to determine the conditions of performance tests performed pursuant to §63.988(b), §63.990(b), §63.994(b), or §63.995(b).

(ii) *Nonflare control device and halogen reduction device performance test records.*

(A) *General requirements.* Each owner or operator subject to the provisions of this subpart shall keep up-to-date, readily accessible continuous records of the data specified in paragraphs (a)(2)(ii)(B) through (C) of this section, as applicable, measured during each performance test performed pursuant to §63.988(b), §63.990(b), §63.994(b), or §63.995(b), and also include that data in the Notification of Compliance Status required under §63.999(b). The same data specified in this section shall be submitted in the reports of all subsequently required performance tests where either the emission control efficiency of a combustion device, or the outlet concentration of TOC or regulated material is determined.

(B) *Nonflare combustion device.* Where an owner or operator subject to the provisions of this paragraph seeks to demonstrate compliance with a percent reduction requirement or a parts per million by volume requirement using a nonflare combustion device the information specified in (a)(2)(ii)(B)(1) through (6) of this section shall be recorded.

(1) For thermal incinerators, record the fire box temperature averaged over the full period of the performance test.

(2) For catalytic incinerators, record the upstream and downstream temperatures and the temperature difference across the catalyst bed averaged over the full period of the performance test.

(3) For a boiler or process heater with a design heat input capacity less than 44 megawatts and a vent stream that is not introduced with or as the primary fuel, record the fire box temperature averaged over the full period of the performance test.

(4) For an incinerator, record the percent reduction of organic regulated material, if applicable, or TOC achieved by the incinerator determined as specified in §63.997(e)(2)(iv), as applicable, or the concentration of organic regulated material (parts per million by volume, by compound) determined as specified in §63.997(e)(2)(iii) at the outlet of the incinerator.

(5) For a boiler or process heater, record a description of the location at which the vent stream is introduced into the boiler or process heater.

(6) For a boiler or process heater with a design heat input capacity of less than 44 megawatts and where the process vent stream is introduced with combustion air or used as a secondary fuel and is not mixed with the primary fuel, record the percent reduction of organic regulated material or TOC, or the concentration of regulated material or TOC (parts per million by volume, by compound) determined as specified in §63.997(e)(2)(iii) at the outlet of the combustion device.

(C) *Other nonflare control devices.* Where an owner or operator seeks to use an absorber, condenser, or carbon adsorber as a control device, the information specified in paragraphs (a)(2)(ii)(C)(1) through (5) of this section shall be recorded, as applicable.

(1) Where an absorber is used as the control device, the exit specific gravity and average exit temperature of the absorbing liquid averaged over the same time period as the performance test (both measured while the vent stream is normally routed and constituted); or

(2) Where a condenser is used as the control device, the average exit (product side) temperature averaged over the same time period as the performance test while the vent stream is routed and constituted normally; or

(3) Where a carbon adsorber is used as the control device, the total regeneration stream mass flow during each carbon-bed regeneration cycle during the period of the performance test, and temperature of the carbon-bed after each regeneration during the period of the performance test (and within 15 minutes of completion of any cooling cycle or cycles; or

(4) As an alternative to paragraph (a)(2)(ii)(C)(1), (2), or (3) of this section, the concentration level or reading indicated by an organics monitoring device at the outlet of the absorber, condenser, or carbon adsorber averaged over the same time period as the performance test while the vent stream is normally routed and constituted.

(5) For an absorber, condenser, or carbon adsorber used as a control device, the percent reduction of regulated material achieved by the control device or concentration of regulated material (parts per million by volume, by compound) at the outlet of the control device.

(D) *Halogen reduction devices.* When using a scrubber following a combustion device to control a halogenated vent stream, record the information specified in paragraphs (a)(2)(ii)(D)(1) through (3) of this section.

(1) The percent reduction or scrubber outlet mass emission rate of total hydrogen halides and halogens as specified in §63.997(e)(3).

(2) The pH of the scrubber effluent averaged over the time period of the performance test; and

(3) The scrubber liquid-to-gas ratio averaged over the time period of the performance test.

(3) *Recovery device monitoring records during TRE index value determination.* For process vents that require control of emissions under a referencing subpart, owners or operators using a recovery

device to maintain a TRE above a level specified in the referencing subpart shall maintain the continuous records specified in paragraph (a)(3)(i) through (v) of this section, as applicable, and submit reports as specified in §63.999(a)(2)(iii)(C).

(i) Where an absorber is the final recovery device in the recovery system and the saturated scrubbing fluid and specific gravity of the scrubbing fluid is greater than or equal to 0.02 specific gravity units, the exit specific gravity (or alternative parameter that is a measure of the degree of absorbing liquid saturation if approved by the Administrator) and average exit temperature of the absorbing liquid averaged over the same time period as the TRE index value determination (both measured while the vent stream is normally routed and constituted); or

(ii) Where a condenser is the final recovery device in the recovery system, the average exit (product side) temperature averaged over the same time period as the TRE index value determination while the vent stream is routed and constituted normally; or

(iii) Where a carbon adsorber is the final recovery device in the recovery system, the total regeneration stream mass flow during each carbon-bed regeneration cycle during the period of the TRE index value determination, and temperature of the carbon-bed after each regeneration during the period of the TRE index value determination (and within 15 minutes of completion of any cooling cycle or cycles); or

(iv) As an alternative to paragraph (a)(3)(i), (ii), or (iii) of this section, the concentration level or reading indicated by an organics monitoring device at the outlet of the absorber, condenser, or carbon adsorber averaged over the same time period as the TRE index value determination while the vent stream is normally routed and constituted.

(v) All measurements and calculations performed to determine the TRE index value of the vent stream as specified in a referencing subpart.

(4) *Halogen concentration records.* Record the halogen concentration in the vent stream determined according to the procedures specified in a referencing subpart. Submit this record in the Notification of Compliance Status, as specified in §63.999(b)(4). If the owner or operator designates the vent stream as halogenated, then this shall be recorded and reported in the Notification of Compliance Status report.

(b) *Continuous records and monitoring system data handling—(1) Continuous records.* Where this subpart requires a continuous record, the owner or operator shall maintain a record as specified in paragraphs (b)(1)(i) through (iv) of this section, as applicable:

(i) A record of values measured at least once every 15 minutes or each measured value for systems which measure more frequently than once every 15 minutes; or

(ii) A record of block average values for 15-minute or shorter periods calculated from all measured data values during each period or from at least one measured data value per minute if measured more frequently than once per minute.

(iii) Where data is collected from an automated continuous parameter monitoring system, the owner or operator may calculate and retain block hourly average values from each 15-minute block average period or from at least one measured value per minute if measured more frequently than once per minute, and discard all but the most recent three valid hours of continuous (15-minute or shorter) records, if the hourly averages do not exclude periods of CPMS breakdown or malfunction. An automated CPMS records the measured data and calculates the hourly averages through the use of a computerized data acquisition system.

(iv) A record as required by an alternative approved under a referencing subpart.

(2) *Excluded data.* Monitoring data recorded during periods identified in paragraphs (b)(2)(i) through (iii) of this section shall not be included in any average computed to determine compliance with an emission limit in a referencing subpart.

(i) Monitoring system breakdowns, repairs, preventive maintenance, calibration checks, and zero (low-level) and high-level adjustments;

(ii) Periods of non-operation of the process unit (or portion thereof), resulting in cessation of the emissions to which the monitoring applies; and

(iii) Startups, shutdowns, and malfunctions, if the owner or operator operates the source during such periods in accordance with §63.1111(a) and maintains the records specified in paragraph (d)(3) of this section.

(3) *Records of daily averages.* In addition to the records specified in paragraph (a), owners or operators shall keep records as specified in paragraphs (b)(3)(i) and (ii) of this section and submit reports as specified in §63.999(c), unless an alternative recordkeeping system has been requested and approved under a referencing subpart.

(i) Except as specified in paragraph (b)(3)(ii) of this section, daily average values of each continuously monitored parameter shall be calculated from data meeting the specifications of paragraph (b)(2) of this section for each operating day and retained for 5 years.

(A) The daily average shall be calculated as the average of all values for a monitored parameter recorded during the operating day. The average shall cover a 24-hour period if operation is continuous, or the period of operation per operating day if operation is not continuous (e.g., for transfer racks the average shall cover periods of loading). If values are measured more frequently than once per minute, a single value for each minute may be used to calculate the daily average instead of all measured values.

(B) The operating day shall be the period defined in the operating permit or in the Notification of Compliance Status. It may be from midnight to midnight or another daily period.

(ii) If all recorded values for a monitored parameter during an operating day are within the range established in the Notification of Compliance Status or in the operating permit, the owner or operator may record that all values were within the range and retain this record for 5 years rather than calculating and recording a daily average for that operating day. In such cases, the owner or operator may not discard the recorded values as allowed in paragraph (b)(1)(iii) of this section.

(4) [Reserved]

(5) *Alternative recordkeeping.* For any parameter with respect to any item of equipment associated with a process vent or transfer rack (except low throughput transfer loading racks), the owner or operator may implement the recordkeeping requirements in paragraphs (b)(5)(i) or (ii) of this section as alternatives to the recordkeeping provisions listed in paragraphs (b)(1) through (3) of this section. The owner or operator shall retain each record required by paragraphs (b)(5)(i) or (ii) of this section as provided in a referencing subpart.

(i) The owner or operator may retain only the daily average value, and is not required to retain more frequently monitored operating parameter values, for a monitored parameter with respect to an item of equipment, if the requirements of paragraphs (b)(5)(i)(A) through (F) of this section are met. The owner or operator shall notify the Administrator in the Notification of Compliance Status as specified in

§63.999(b)(5) or, if the Notification of Compliance Status has already been submitted, in the Periodic Report immediately preceding implementation of the requirements of this paragraph, as specified in §63.999(c)(6)(iv).

(A) The monitoring system is capable of detecting unrealistic or impossible data during periods of operation other than start-ups, shutdowns or malfunctions (e.g., a temperature reading of  $-200^{\circ}\text{C}$  on a boiler), and will alert the operator by alarm or other means. The owner or operator shall record the occurrence. All instances of the alarm or other alert in an operating day constitute a single occurrence.

(B) The monitoring system generates a running average of the monitoring values, updated at least hourly throughout each operating day, that have been obtained during that operating day, and the capability to observe this average is readily available to the Administrator on-site during the operating day. The owner or operator shall record the occurrence of any period meeting the criteria in paragraphs (b)(5)(i)(B)(1) through (3) of this section. All instances in an operating day constitute a single occurrence.

(1) The running average is above the maximum or below the minimum established limits;

(2) The running average is based on at least six one-hour average values; and

(3) The running average reflects a period of operation other than a start-up, shutdown, or malfunction.

(C) The monitoring system is capable of detecting unchanging data during periods of operation other than start-ups, shutdowns or malfunctions, except in circumstances where the presence of unchanging data is the expected operating condition based on past experience (e.g., pH in some scrubbers), and will alert the operator by alarm or other means. The owner or operator shall record the occurrence. All instances of the alarm or other alert in an operating day constitute a single occurrence.

(D) The monitoring system will alert the owner or operator by an alarm, if the running average parameter value calculated under paragraph (b)(5)(i)(B) of this section reaches a set point that is appropriately related to the established limit for the parameter that is being monitored.

(E) The owner or operator shall verify the proper functioning of the monitoring system, including its ability to comply with the requirements of paragraph (b)(5)(i) of this section, at the times specified in paragraphs (b)(5)(i)(E)(1) through (3) of this section. The owner or operator shall document that the required verifications occurred.

(1) Upon initial installation.

(2) Annually after initial installation.

(3) After any change to the programming or equipment constituting the monitoring system that might reasonably be expected to alter the monitoring system's ability to comply with the requirements of this section.

(F) The owner or operator shall retain the records identified in paragraphs (b)(5)(i)(F)(1) through (4) of this section.

(1) Identification of each parameter, for each item of equipment, for which the owner or operator has elected to comply with the requirements of paragraph (b)(5)(i) of this section.

(2) A description of the applicable monitoring system(s), and of how compliance will be achieved with each requirement of paragraph (b)(5)(i)(A) through (E) of this section. The description shall identify

the location and format (e.g., on-line storage; log entries) for each required record. If the description changes, the owner or operator shall retain both the current and the most recent superseded description. The description, and the most recent superseded description, shall be retained as provided in the subpart that references this subpart, except as provided in paragraph (b)(5)(i)(F)(1) of this section.

(3) A description, and the date, of any change to the monitoring system that would reasonably be expected to affect its ability to comply with the requirements of paragraph (b)(5)(i) of this section.

(4) Owners and operators subject to paragraph (b)(5)(i)(F)(2) of this section shall retain the current description of the monitoring system as long as the description is current, but not less than 5 years from the date of its creation. The current description shall be retained on-site at all times or be accessible from a central location by computer or other means that provides access within 2 hours after a request. The owner or operator shall retain the most recent superseded description at least until 5 years from the date of its creation. The superseded description shall be retained on-site (or accessible from a central location by computer that provides access within 2 hours after a request) at least 6 months after being superseded. Thereafter, the superseded description may be stored off-site.

(ii) If an owner or operator has elected to implement the requirements of paragraph (b)(5)(i) of this section, and a period of 6 consecutive months has passed without an excursion as defined in paragraph (b)(6)(i) of this section, the owner or operator is no longer required to record the daily average value for that parameter for that unit of equipment, for any operating day when the daily average value is less than the maximum, or greater than the minimum established limit. With approval by the Administrator, monitoring data generated prior to the compliance date of this subpart shall be credited toward the period of 6 consecutive months, if the parameter limit and the monitoring were required and/or approved by the Administrator.

(A) If the owner or operator elects not to retain the daily average values, the owner or operator shall notify the Administrator in the next Periodic Report, as specified in §63.999(c)(6)(i). The notification shall identify the parameter and unit of equipment.

(B) If there is an excursion as defined in paragraph (b)(6)(i) of this section on any operating day after the owner or operator has ceased recording daily averages as provided in paragraph (b)(5)(ii) of this section, the owner or operator shall immediately resume retaining the daily average value for each operating day, and shall notify the Administrator in the next Periodic Report, as specified in §63.999(c). The owner or operator shall continue to retain each daily average value until another period of 6 consecutive months has passed without an excursion as defined in paragraph (b)(6)(i) of this section.

(C) The owner or operator shall retain the records specified in paragraphs (b)(5)(i)(A) through (F) of this section for the duration specified in a referencing subpart. For any week, if compliance with paragraphs (b)(5)(i)(A) through (D) of this section does not result in retention of a record of at least one occurrence or measured parameter value, the owner or operator shall record and retain at least one parameter value during a period of operation other than a start-up, shutdown, or malfunction.

(6)(i) For the purposes of this section, an excursion means that the daily average value of monitoring data for a parameter is greater than the maximum, or less than the minimum established value, except as provided in paragraphs (b)(6)(i)(A) and (B) of this section.

(A) The daily average value during any startup, shutdown, or malfunction shall not be considered an excursion if the owner or operator operates the source during such periods in accordance with §63.1111(a) and maintains the records specified in paragraph (d)(3) of this section.

(B) An excused excursion, as described in paragraph (b)(6)(ii), does not count toward the number of excursions for the purposes of this subpart.



(ii) One excused excursion for each control device or recovery device for each semiannual period is allowed. If a source has developed a startup, shutdown and malfunction plan, and a monitored parameter is outside its established range or monitoring data are not collected during periods of start-up, shutdown, or malfunction (and the source is operated during such periods in accordance with §63.1111(a)) or during periods of nonoperation of the process unit or portion thereof (resulting in cessation of the emissions to which monitoring applies), then the excursion is not a violation and, in cases where continuous monitoring is required, the excursion does not count as the excused excursion for determining compliance.

(c) *Nonflare control and recovery device regulated source monitoring records—(1) Monitoring system records.* For process vents and high throughput transfer racks, the owner or operator subject to this subpart shall keep the records specified in this paragraph, as well as records specified elsewhere in this subpart.

(i) For a CPMS used to comply with this part, a record of the procedure used for calibrating the CPMS.

(ii) For a CPMS used to comply with this subpart, records of the information specified in paragraphs (c)(ii)(A) through (H) of this section, as indicated in a referencing subpart.

(A) The date and time of completion of calibration and preventive maintenance of the CPMS.

(B) The “as found” and “as left” CPMS readings, whenever an adjustment is made that affects the CPMS reading and a “no adjustment” statement otherwise.

(C) The start time and duration or start and stop times of any periods when the CPMS is inoperative.

(D) Records of the occurrence and duration of each start-up, shutdown, and malfunction of CPMS used to comply with this subpart during which excess emissions (as defined in a referencing subpart) occur.

(E) For each start-up, shutdown, and malfunction during which excess emissions as defined in a referencing subpart occur, records whether the procedures specified in the source's start-up, shutdown, and malfunction plan were followed, and documentation of actions taken that are not consistent with the plan. These records may take the form of a “checklist,” or other form of recordkeeping that confirms conformance with the start-up, shutdown, and malfunction plan for the event.

(F) Records documenting each start-up, shutdown, and malfunction event.

(G) Records of CPMS start-up, shutdown, and malfunction event that specify that there were no excess emissions during the event, as applicable.

(H) Records of the total duration of operating time.

(2) *Combustion control and halogen reduction device monitoring records.* (i) Each owner or operator using a combustion control or halogen reduction device to comply with this subpart shall keep the following records up-to-date and readily accessible, as applicable. Continuous records of the equipment operating parameters specified to be monitored under §§63.988(c) (incinerator, boiler, and process heater monitoring), 63.994(c) (halogen reduction device monitoring), and 63.995(c) (other combustion systems used as control device monitoring) or approved by the Administrator in accordance with a referencing subpart.

(ii) Each owner or operator shall keep records of the daily average value of each continuously monitored parameter for each operating day determined according to the procedures specified in

paragraph (b)(3)(i) of this section. For catalytic incinerators, record the daily average of the temperature upstream of the catalyst bed and the daily average of the temperature differential across the bed. For halogen scrubbers record the daily average pH and the liquid-to-gas ratio.

(iii) Each owner or operator subject to the provisions of this subpart shall keep up-to-date, readily accessible records of periods of operation during which the parameter boundaries are exceeded. The parameter boundaries are established pursuant to §63.996(c)(6).

(3) *Monitoring records for recovery devices, absorbers, condensers, carbon adsorbers or other noncombustion systems used as control devices.* (i) Each owner or operator using a recovery device to achieve and maintain a TRE index value greater than the control applicability level specified in the referencing subpart but less than 4.0 or using an absorber, condenser, carbon adsorber or other non-combustion system as a control device shall keep readily accessible, continuous records of the equipment operating parameters specified to be monitored under §§63.990(c) (absorber, condenser, and carbon adsorber monitoring), 63.993(c) (recovery device monitoring), or 63.995(c) (other noncombustion systems used as a control device monitoring) or as approved by the Administrator in accordance with a referencing subpart. For transfer racks, continuous records are required while the transfer vent stream is being vented.

(ii) Each owner or operator shall keep records of the daily average value of each continuously monitored parameter for each operating day determined according to the procedures specified in paragraph (b)(3)(i) of this section. If carbon adsorber regeneration stream flow and carbon bed regeneration temperature are monitored, the records specified in paragraphs (c)(3)(ii)(A) and (B) of this section shall be kept instead of the daily averages.

(A) Records of total regeneration stream mass or volumetric flow for each carbon-bed regeneration cycle.

(B) Records of the temperature of the carbon bed after each regeneration and within 15 minutes of completing any cooling cycle.

(iii) Each owner or operator subject to the provisions of this subpart shall keep up-to-date, readily accessible records of periods of operation during which the parameter boundaries are exceeded. The parameter boundaries are established pursuant to §63.996(c)(6).

(d) *Other records—(1) Closed vent system records.* For closed vent systems the owner or operator shall record the information specified in paragraphs (d)(1)(i) through (iv) of this section, as applicable.

(i) For closed vent systems collecting regulated material from a regulated source, the owner or operator shall record the identification of all parts of the closed vent system, that are designated as unsafe or difficult to inspect, an explanation of why the equipment is unsafe or difficult to inspect, and the plan for inspecting the equipment required by §63.983(b)(2)(ii) or (iii) of this section.

(ii) For each closed vent system that contains bypass lines that could divert a vent stream away from the control device and to the atmosphere, the owner or operator shall keep a record of the information specified in either paragraph (d)(1)(ii)(A) or (B) of this section, as applicable.

(A) Hourly records of whether the flow indicator specified under §63.983(a)(3)(i) was operating and whether a diversion was detected at any time during the hour, as well as records of the times of all periods when the vent stream is diverted from the control device or the flow indicator is not operating.

(B) Where a seal mechanism is used to comply with §63.983(a)(3)(ii), hourly records of flow are not required. In such cases, the owner or operator shall record that the monthly visual inspection of the seals

or closure mechanisms has been done, and shall record the occurrence of all periods when the seal mechanism is broken, the bypass line valve position has changed, or the key for a lock-and-key type lock has been checked out, and records of any car-seal that has been broken.

(iii) For a closed vent system collecting regulated material from a regulated source, when a leak is detected as specified in §63.983(d)(2), the information specified in paragraphs (d)(1)(iii)(A) through (F) of this section shall be recorded and kept for 5 years.

(A) The instrument and the equipment identification number and the operator name, initials, or identification number.

(B) The date the leak was detected and the date of the first attempt to repair the leak.

(C) The date of successful repair of the leak.

(D) The maximum instrument reading measured by the procedures in §63.983(c) after the leak is successfully repaired or determined to be nonrepairable.

(E) "Repair delayed" and the reason for the delay if a leak is not repaired within 15 days after discovery of the leak. The owner or operator may develop a written procedure that identifies the conditions that justify a delay of repair. In such cases, reasons for delay of repair may be documented by citing the relevant sections of the written procedure.

(F) Copies of the Periodic Reports as specified in §63.999(c), if records are not maintained on a computerized database capable of generating summary reports from the records.

(iv) For each instrumental or visual inspection conducted in accordance with §63.983(b)(1) for closed vent systems collecting regulated material from a regulated source during which no leaks are detected, the owner or operator shall record that the inspection was performed, the date of the inspection, and a statement that no leaks were detected.

(2) *Storage vessel and transfer rack records.* An owner or operator shall keep readily accessible records of the information specified in paragraphs (d)(2)(i) and (ii) of this section, as applicable.

(i) A record of the measured values of the parameters monitored in accordance with §63.985(c) or §63.987(c).

(ii) A record of the planned routine maintenance performed on the control system during which the control system does not meet the applicable specifications of §63.983(a), §63.985(a), or §63.987(a), as applicable, due to the planned routine maintenance. Such a record shall include the information specified in paragraphs (d)(2)(ii)(A) through (C) of this section. This information shall be submitted in the Periodic Reports as specified in §63.999(c)(4).

(A) The first time of day and date the requirements of §63.983(a), §63.985(a), or §63.987(a), as applicable, were not met at the beginning of the planned routine maintenance, and

(B) The first time of day and date the requirements of §63.983(a), §63.985(a), or §63.987(a), as applicable, were met at the conclusion of the planned routine maintenance.

(C) A description of the type of maintenance performed.

(3) *Regulated source and control equipment start-up, shutdown and malfunction records.* (i) Records of the occurrence and duration of each start-up, shutdown, and malfunction of operation of

process equipment or of air pollution control equipment used to comply with this part during which excess emissions (as defined in a referencing subpart) occur.

(ii) For each start-up, shutdown, and malfunction during which excess emissions occur, records that the procedures specified in the source's start-up, shutdown, and malfunction plan were followed, and documentation of actions taken that are not consistent with the plan. For example, if a start-up, shutdown, and malfunction plan includes procedures for routing control device emissions to a backup control device (e.g., the incinerator for a halogenated stream could be routed to a flare during periods when the primary control device is out of service), records must be kept of whether the plan was followed. These records may take the form of a "checklist," or other form of recordkeeping that confirms conformance with the start-up, shutdown, and malfunction plan for the event.

(4) *Equipment leak records.* The owner or operator shall maintain records of the information specified in paragraphs (d)(4)(i) and (ii) of this section for closed vent systems and control devices if specified by the equipment leak provisions in a referencing subpart. The records specified in paragraph (d)(4)(i) of this section shall be retained for the life of the equipment. The records specified in paragraph (d)(4)(ii) of this section shall be retained for 5 years.

(i) The design specifications and performance demonstrations specified in paragraphs (d)(4)(i)(A) through (C) of this section.

(A) Detailed schematics, design specifications of the control device, and piping and instrumentation diagrams.

(B) The dates and descriptions of any changes in the design specifications.

(C) A description of the parameter or parameters monitored, as required in a referencing subpart, to ensure that control devices are operated and maintained in conformance with their design and an explanation of why that parameter (or parameters) was selected for the monitoring.

(ii) Records of operation of closed vent systems and control devices, as specified in paragraphs (d)(4)(ii)(A) through (C) of this section.

(A) Dates and durations when the closed vent systems and control devices required are not operated as designed as indicated by the monitored parameters.

(B) Dates and durations during which the monitoring system or monitoring device is inoperative.

(C) Dates and durations of start-ups and shutdowns of control devices required in this subpart.

(5) *Records of monitored parameters outside of range.* The owner or operator shall record the occurrences and the cause of periods when the monitored parameters are outside of the parameter ranges documented in the Notification of Compliance Status report. This information shall also be reported in the Periodic Report.

[64 FR 34866, June 29, 1999, as amended at 64 FR 63705, Nov. 22, 1999; 71 FR 20458, Apr. 20, 2006]

### **§63.999 Notifications and other reports.**

(a) *Performance test and flare compliance assessment notifications and reports—(1) General requirements.* General requirements for performance test and flare compliance assessment notifications and reports are specified in paragraphs (a)(1)(i) through (iii) of this section.

(i) The owner or operator shall notify the Administrator of the intention to conduct a performance test or flare compliance assessment at least 30 days before such a compliance demonstration is scheduled to allow the Administrator the opportunity to have an observer present. If after 30 days notice for such an initially scheduled compliance demonstration, there is a delay (due to operational problems, etc.) in conducting the scheduled compliance demonstration, the owner or operator of an affected facility shall notify the Administrator as soon as possible of any delay in the original demonstration date. The owner or operator shall provide at least 7 days prior notice of the rescheduled date of the compliance demonstration, or arrange a rescheduled date with the Administrator by mutual agreement.

(ii) Unless specified differently in this subpart or a referencing subpart, performance test and flare compliance assessment reports, not submitted as part of a Notification of Compliance Status report, shall be submitted to the Administrator within 60 days of completing the test or determination.

(iii) Any application for a waiver of an initial performance test or flare compliance assessment, as allowed by §63.997(b)(2), shall be submitted no later than 90 days before the performance test or compliance assessment is required. The application for a waiver shall include information justifying the owner or operator's request for a waiver, such as the technical or economic infeasibility, or the impracticality, of the source performing the test.

(iv) Any application to substitute a prior performance test or compliance assessment for an initial performance test or compliance assessment, as allowed by §63.997(b)(1), shall be submitted no later than 90 days before the performance test or compliance test is required. The application for substitution shall include information demonstrating that the prior performance test or compliance assessment was conducted using the same methods specified in §63.997(e) or §63.987(b)(3), as applicable. The application shall also include information demonstrating that no process changes have been made since the test, or that the results of the performance test or compliance assessment reliably demonstrate compliance despite process changes.

(2) *Performance test and flare compliance assessment report submittal and content requirements.* Performance test and flare compliance assessment reports shall be submitted as specified in paragraphs (a)(2)(i) through (iii) of this section.

(i) For performance tests or flare compliance assessments, the Notification of Compliance Status or performance test and flare compliance assessment report shall include one complete test report as specified in paragraph (a)(2)(ii) of this section for each test method used for a particular kind of emission point and other applicable information specified in (a)(2)(iii) of this section. For additional tests performed for the same kind of emission point using the same method, the results and any other information required in applicable sections of this subpart shall be submitted, but a complete test report is not required.

(ii) A complete test report shall include a brief process description, sampling site description, description of sampling and analysis procedures and any modifications to standard procedures, quality assurance procedures, record of operating conditions during the test, record of preparation of standards, record of calibrations, raw data sheets for field sampling, raw data sheets for field and laboratory analyses, documentation of calculations, and any other information required by the test method.

(iii) The performance test or flare compliance assessment report shall also include the information specified in (a)(2)(iii)(A) through (C) of this section, as applicable.

(A) For flare compliance assessments, the owner or operator shall submit the records specified in §63.998(a)(1)(i).

(B) For nonflare control device and halogen reduction device performance tests as required under §63.988(b), §63.990(b), §63.994(b), or §63.995(b), also submit the records specified in §63.998(a)(2)(ii), as applicable.

(C) For recovery devices also submit the records specified in §63.998(a)(3), as applicable.

(b) *Notification of Compliance Status—(1) Routing storage vessel or transfer rack emissions to a process or fuel gas system.* An owner or operator who elects to comply with §63.982 by routing emissions from a storage vessel or transfer rack to a process or to a fuel gas system, as specified in §63.984, shall submit as part of the Notification of Compliance Status the information specified in paragraphs (b)(1)(i) and (ii), or (iii) of this section, as applicable.

(i) If storage vessels emissions are routed to a process, the owner or operator shall submit the information specified in §63.984(b)(2) and (3).

(ii) As specified in §63.984(c), if storage vessels emissions are routed to a fuel gas system, the owner or operator shall submit a statement that the emission stream is connected to the fuel gas system and whether the conveyance system is subject to the requirements of §63.983.

(iii) As specified in §63.984(c), report that the transfer rack emission stream is being routed to a fuel gas system or process, when complying with a referencing subpart.

(2) *Routing storage vessel or low throughput transfer rack emissions to a nonflare control device.* An owner or operator who elects to comply with §63.982 by routing emissions from a storage vessel or low throughput transfer rack to a nonflare control device, as specified in §63.985, shall submit, with the Notification of Compliance Status required by a referencing subpart, the applicable information specified in paragraphs (b)(2)(i) through (vi) of this section. Owners and operators who elect to comply with §63.985(b)(1)(i) by submitting a design evaluation shall submit the information specified in paragraphs (b)(2)(i) through (iv) of this section. Owners and operators who elect to comply with §63.985(b)(1)(ii) by submitting performance test results from a control device for a storage vessel or low throughput transfer rack shall submit the information specified in paragraphs (b)(2)(i), (ii), (iv), and (v) of this section. Owners and operators who elect to comply with §63.985(b)(1)(ii) by submitting performance test results from a shared control device shall submit the information specified in paragraph (b)(2)(vi) of this section.

(i) A description of the parameter or parameters to be monitored to ensure that the control device is being properly operated and maintained, an explanation of the criteria used for selection of that parameter (or parameters), and the frequency with which monitoring will be performed (e.g., when the liquid level in the storage vessel is being raised). If continuous records are specified, indicate whether the provisions of §63.999(c)(6) apply.

(ii) The operating range for each monitoring parameter identified in the monitoring plan required by §63.985(c)(1). The specified operating range shall represent the conditions for which the control device is being properly operated and maintained.

(iii) The documentation specified in §63.985(b)(1)(i), if the owner or operator elects to prepare a design evaluation.

(iv) The provisions of paragraph (c)(6) of this section do not apply to any low throughput transfer rack for which the owner or operator has elected to comply with §63.985 or to any storage vessel for which the owner or operator is not required, by the applicable monitoring plan established under §63.985(c)(1), to keep continuous records. If continuous records are required, the owner or operator shall specify in the monitoring plan whether the provisions of paragraph (c)(6) of this section apply.

(v) A summary of the results of the performance test described in §63.985(b)(1)(ii). If such a performance test is conducted, submit the results of the performance test, including the information specified in §63.999(a)(2)(ii) and (iii).

(vi) Identification of the storage vessel or transfer rack and control device for which the performance test will be submitted, and identification of the emission point(s), if any, that share the control device with the storage vessel or transfer rack and for which the performance test will be conducted.

(3) *Operating range for monitored parameters.* The owner or operator shall submit as part of the Notification of Compliance Status, the operating range for each monitoring parameter identified for each control, recovery, or halogen reduction device as determined pursuant to §63.996(c)(6). The specified operating range shall represent the conditions for which the control, recovery, or halogen reduction device is being properly operated and maintained. This report shall include the information in paragraphs (b)(3)(i) through (iii) of this section, as applicable, unless the range and the operating day have been established in the operating permit.

(i) The specific range of the monitored parameter(s) for each emission point;

(ii) The rationale for the specific range for each parameter for each emission point, including any data and calculations used to develop the range and a description of why the range indicates proper operation of the control, recovery, or halogen reduction device, as specified in paragraphs (b)(3)(ii)(A), (B), or (C) of this section, as applicable.

(A) If a performance test or TRE index value determination is required by a referencing subpart for a control, recovery or halogen reduction device, the range shall be based on the parameter values measured during the TRE index value determination or performance test and may be supplemented by engineering assessments and/or manufacturer's recommendations. TRE index value determinations and performance testing are not required to be conducted over the entire range of permitted parameter values.

(B) If a performance test or TRE index value determination is not required by a referencing subpart for a control, recovery, or halogen reduction device, the range may be based solely on engineering assessments and/or manufacturer's recommendations.

(C) The range may be based on ranges or limits previously established under a referencing subpart.

(iii) A definition of the source's operating day for purposes of determining daily average values of monitored parameters. The definition shall specify the times at which an operating day begins and ends.

(4) *Halogen reduction device.* The owner or operator shall submit as part of the Notification of Compliance Status the information recorded pursuant to §63.998(a)(4).

(5) *Alternative recordkeeping.* The owner or operator shall notify the Administrator in the Notification of Compliance Status if the alternative recordkeeping requirements of §63.998(b)(5) are being implemented. If the Notification of Compliance Status has already been submitted, the notification must be in the periodic report submitted immediately preceding implementation of the alternative, as specified in paragraph (c)(6)(iv) of this section.

(c) *Periodic reports.* (1) Periodic reports shall include the reporting period dates, the total source operating time for the reporting period, and, as applicable, all information specified in this section and in the referencing subpart, including reports of periods when monitored parameters are outside their established ranges.

(2) For closed vent systems subject to the requirements of §63.983, the owner or operator shall submit as part of the periodic report the information specified in paragraphs (c)(2)(i) through (iii) of this section, as applicable.

(i) The information recorded in §63.998(d)(1)(iii)(B) through (E);

(ii) Reports of the times of all periods recorded under §63.998(d)(1)(ii)(A) when the vent stream is diverted from the control device through a bypass line; and

(iii) Reports of all times recorded under §63.998(d)(1)(ii)(B) when maintenance is performed in car-sealed valves, when the seal is broken, when the bypass line valve position is changed, or the key for a lock-and-key type configuration has been checked out.

(3) For flares subject to this subpart, report all periods when all pilot flames were absent or the flare flame was absent as recorded in §63.998(a)(1)(i)(C).

(4) For storage vessels, the owner or operator shall include in each periodic report required the information specified in paragraphs (c)(4)(i) through (iii) of this section.

(i) For the 6-month period covered by the periodic report, the information recorded in §63.998(d)(2)(ii)(A) through (C).

(ii) For the time period covered by the periodic report and the previous periodic report, the total number of hours that the control system did not meet the requirements of §63.983(a), §63.985(a), or §63.987(a) due to planned routine maintenance.

(iii) A description of the planned routine maintenance during the next 6-month periodic reporting period that is anticipated to be performed for the control system when it is not expected to meet the required control efficiency. This description shall include the type of maintenance necessary, planned frequency of maintenance, and expected lengths of maintenance periods.

(5) If a control device other than a flare is used to control emissions from storage vessels or low throughput transfer racks, the periodic report shall describe each occurrence when the monitored parameters were outside of the parameter ranges documented in the Notification of Compliance Status in accordance with paragraph (b)(3) of this section. The description shall include the information specified in paragraphs (c)(5)(i) and (ii) of this section.

(i) Identification of the control device for which the measured parameters were outside of the established ranges, and

(ii) The cause for the measured parameters to be outside of the established ranges.

(6) For process vents and transfer racks (except low throughput transfer racks), periodic reports shall include the information specified in paragraphs (c)(6)(i) through (iv) of this section.

(i) Periodic reports shall include the daily average values of monitored parameters, calculated as specified in §63.998(b)(3)(i) for any days when the daily average value is outside the bounds as defined in §63.998(c)(2)(iii) or (c)(3)(iii), or the data availability requirements defined in paragraphs (c)(6)(i)(A) through (D) of this section are not met, whether these excursions are excused or unexcused excursions. For excursions caused by lack of monitoring data, the duration of periods when monitoring data were not collected shall be specified. An excursion means any of the cases listed in paragraphs (c)(6)(i)(A) through (C) of this section. If the owner or operator elects not to retain the daily average values pursuant to §63.998(b)(5)(ii)(A), the owner or operator shall report this in the Periodic Report.



(A) When the daily average value of one or more monitored parameters is outside the permitted range.

(B) When the period of control or recovery device operation is 4 hours or greater in an operating day and monitoring data are insufficient to constitute a valid hour of data for at least 75 percent of the operating hours.

(C) When the period of control or recovery device operation is less than 4 hours in an operating day and more than one of the hours during the period of operation does not constitute a valid hour of data due to insufficient monitoring data.

(D) Monitoring data are insufficient to constitute a valid hour of data as used in paragraphs (c)(6)(i)(B) and (C) of this section, if measured values are unavailable for any of the 15-minute periods within the hour.

(ii) Report all carbon-bed regeneration cycles during which the parameters recorded under §63.998(a)(2)(ii)(C) were outside the ranges established in the Notification of Compliance Status or in the operating permit.

(iii) The provisions of paragraph (c)(6)(i) and (ii) of this section do not apply to any low throughput transfer rack for which the owner or operator has elected to comply with §63.985 or to any storage vessel for which the owner or operator is not required, by the applicable monitoring plan established under §63.985(c)(1), to keep continuous records. If continuous records are required, the owner or operator shall specify in the monitoring plan whether the provisions of paragraphs (c)(6)(i) and (c)(6)(ii) of this section apply.

(iv) If the owner or operator has chosen to use the alternative recordkeeping requirements of §63.998(b)(5), and has not notified the Administrator in the Notification of Compliance Status that the alternative recordkeeping provisions are being implemented as specified in paragraph (b)(5) of this section, the owner or operator shall notify the Administrator in the Periodic Report submitted immediately preceding implementation of the alternative. The notifications specified in §63.998(b)(5)(ii) shall be included in the next Periodic Report following the identified event.

(7) As specified in §63.997(c)(3), if an owner or operator at a facility not required to obtain a title V permit elects at a later date to replace an existing control or recovery device with a different control or recovery device, then the Administrator shall be notified by the owner or operator before implementing the change. This notification may be included in the facility's periodic reporting.

(d) *Requests for approval of monitoring alternatives—(1) Alternatives to the continuous operating parameter monitoring and recordkeeping provisions.* Requests for approval to use alternatives to continuous operating parameter monitoring and recordkeeping provisions, as provided for in §63.996(d)(1), shall be submitted as specified in a referencing subpart, and the referencing subpart will govern the review and approval of such requests. The information specified in paragraphs (d)(1)(i) and (ii) of this section shall be included.

(i) A description of the proposed alternative system; and

(ii) Information justifying the owner or operator's request for an alternative method, such as the technical or economic infeasibility, or the impracticality, of the regulated source using the required method.

(2) *Monitoring a different parameter than those listed.* Requests for approval to monitor a different parameter than those established in §63.996(c)(6) of this section or to set unique monitoring parameters,

as provided for in §63.996(d)(2), shall be submitted as specified as specified in a referencing subpart, and the referencing subpart will govern the review and approval of such requests. The information specified in paragraphs (d)(2)(i) through (iii) of this section shall be included in the request.

(i) A description of the parameter(s) to be monitored to ensure the control technology or pollution prevention measure is operated in conformance with its design and achieves the specified emission limit, percent reduction, or nominal efficiency, and an explanation of the criteria used to select the parameter(s);

(ii) A description of the methods and procedures that will be used to demonstrate that the parameter indicates proper operation of the control device, the schedule for this demonstration, and a statement that the owner or operator will establish a range for the monitored parameter(s) as part of the Notification of Compliance Status if required under a referencing subpart, unless this information has already been submitted; and

(iii) The frequency and content of monitoring, recording, and reporting, if monitoring and recording is not continuous, or if reports of daily average values when the monitored parameter value is outside the established range will not be included in periodic reports under paragraph (c) of this section. The rationale for the proposed monitoring, recording, and reporting system shall be included.

[64 FR 34866, June 29, 1999, as amended at 64 FR 63705, Nov. 22, 1999]

**Appendix H**  
40 C.F.R. Part 63, Subpart UU – *National Emission Standards for Equipment Leaks - Control  
Level 2 Standards*

## Subpart UU—National Emission Standards for Equipment Leaks— Control Level 2 Standards

SOURCE: 64 FR 34899, June 29, 1999, unless otherwise noted.

### §63.1019 Applicability.

(a) The provisions of this subpart apply to the control of air emissions from equipment leaks for which another subpart references the use of this subpart for such air emission control. These air emission standards for equipment leaks are placed here for administrative convenience and only apply to those owners and operators of facilities subject to a referencing subpart. The provisions of 40 CFR part 63, subpart A (General Provisions) do not apply to this subpart except as noted in the referencing subpart.

(b) *Equipment subject to this subpart.* The provisions of this subpart and the referencing subpart apply to equipment that contains or contacts regulated material. This subpart applies to pumps, compressors, agitators, pressure relief devices, sampling connection systems, open-ended valves or lines, valves, connectors, instrumentation systems, and closed vent systems and control devices used to meet the requirements of this subpart.

(c) *Equipment in vacuum service.* Equipment in vacuum service is excluded from the requirements of this subpart.

(d) *Equipment in service less than 300 hours per calendar year.* Equipment intended to be in regulated material service less than 300 hours per calendar year is excluded from the requirements of §§63.1025 through 63.1034 and §63.1036 if it is identified as required in §63.1022(b)(5).

(e) *Lines and equipment not containing process fluids.* Lines and equipment not containing process fluids are not subject to the provisions of this subpart. Utilities, and other non-process lines, such as heating and cooling systems that do not combine their materials with those in the processes they serve, are not considered to be part of a process unit or affected facility.

(f) *Implementation and enforcement.* This subpart can be implemented and enforced by the U.S. Environmental Protection Agency (EPA), or a delegated authority such as the applicable State, local, or tribal agency. If the EPA Administrator has delegated authority to a State, local, or tribal agency, then that agency has the authority to implement and enforce this subpart. Contact the applicable EPA Regional Office to find out if this subpart is delegated to a State, local, or tribal agency.

(1) In delegating implementation and enforcement authority of this subpart to a State, local, or tribal agency under section 40 CFR part 63, subpart E, the authorities contained in paragraphs (f)(i) through (v) of this section are retained by the EPA Administrator and are not transferred to the State, local, or tribal agency.

(i) Approval of alternatives to the nonopacity emissions standards in §§63.1022 through 62.1034, under §63.6(g), and the standards for quality improvement programs in §63.1035. Where these standards reference another subpart, the cited provisions will be delegated according to the delegation provisions of the referenced subpart.

(ii) [Reserved]

(iii) Approval of major changes to test methods under §63.7(e)(2)(ii) and (f) and as defined in §63.90.

(iv) Approval of major changes to monitoring under §63.8(f) and as defined in §63.90.

(v) Approval of major changes to recordkeeping and reporting under §63.10(f) and as defined in §63.90.

[64 FR 34899, June 29, 1999, as amended at 67 FR 46279, July 12, 2002]

### **§63.1020 Definitions.**

All terms used in this part shall have the meaning given them in the Act and in this section.

*Batch process* means a process in which the equipment is fed intermittently or discontinuously. Processing then occurs in this equipment after which the equipment is generally emptied. Examples of industries that use batch processes include pharmaceutical production and pesticide production.

*Batch product-process equipment train* means the collection of equipment (e.g., connectors, reactors, valves, pumps, etc.) configured to produce a specific product or intermediate by a batch process.

*Car-seal* means a seal that is placed on a device that is used to change the position of a valve (e.g., from opened to closed) in such a way that the position of the valve cannot be changed without breaking the seal.

*Closed-loop system* means an enclosed system that returns process fluid to the process and is not vented directly to the atmosphere.

*Closed-purge system* means a system or combination of systems and portable containers to capture purged liquids. Containers must be covered or closed when not being filled or emptied.

*Closed-vent system* means a system that is not open to the atmosphere and is composed of piping, ductwork, connections, and, if necessary, flow inducing devices that transport gas or vapor from an emission point to a control device.

*Combustion device* means an individual unit of equipment, such as a flare, incinerator, process heater, or boiler, used for the combustion of organic emissions.

*Connector* means flanged, screwed, or other joined fittings used to connect two pipelines or a pipeline and a piece of equipment. A common connector is a flange. Joined fittings welded completely around the circumference of the interface are not considered connectors for the purpose of this regulation. For the purpose of reporting and recordkeeping, connector means joined fittings that are not inaccessible, ceramic, or ceramic-lined (e.g., porcelain, glass, or glass-lined) as described in §63.1027(e)(2).

*Continuous parameter monitoring system (CPMS)* means the total equipment that may be required to meet the data acquisition and availability requirements of this part, used to sample, condition (if applicable), analyze, and provide a record of process or control system parameters.

*Control device* means any combustion device, recovery device, recapture device, or any combination of these devices used to comply with this part. Such equipment or devices include, but are

not limited to, absorbers, carbon adsorbers, condensers, incinerators, flares, boilers, and process heaters. Primary condensers on steam strippers or fuel gas systems are not considered control devices.

*Distance piece* means an open or enclosed casing through which the piston rod travels, separating the compressor cylinder from the crankcase.

*Double block and bleed system* means two block valves connected in series with a bleed valve or line that can vent the line between the two block valves.

*Equipment* means each pump, compressor, agitator, pressure relief device, sampling connection system, open-ended valve or line, valve, connector, and instrumentation system in regulated material service; and any control devices or systems used to comply with this subpart.

*First attempt at repair*, for the purposes of this subpart, means to take action for the purpose of stopping or reducing leakage of organic material to the atmosphere, followed by monitoring as specified in §§63.1023(b) and (c) of this subpart in to verify whether the leak is repaired, unless the owner or operator determines by other means that the leak is not repaired.

*Fuel gas* means gases that are combusted to derive useful work or heat.

*Fuel gas system* means the offsite and onsite piping and flow and pressure control system that gathers gaseous stream(s) generated by onsite operations, may blend them with other sources of gas, and transports the gaseous stream for use a fuel gas in combustion equipment, such as furnaces and gas turbines, either singly or in combination.

*In food and medical service* means that a piece of equipment in regulated material service contacts a process stream used to manufacture a Food and Drug Administration regulated product where leakage of a barrier fluid into the process stream would cause any of the following:

- (1) A dilution of product quality so that the product would not meet written specifications,
- (2) An exothermic reaction which is a safety hazard,
- (3) The intended reaction to be slowed down or stopped, or
- (4) An undesired side reaction to occur.

*In gas and vapor service* means that a piece of equipment in regulated material service contains a gas or vapor at operating conditions.

*In heavy liquid service* means that a piece of equipment in regulated material service is not in gas and vapor service or in light liquid service.

*In light liquid service* means that a piece of equipment in regulated material service contains a liquid that meets the following conditions:

- (1) The vapor pressure of one or more of the organic compounds is greater than 0.3 kilopascals at 20 °C,
- (2) The total concentration of the pure organic compounds constituents having a vapor pressure greater than 0.3 kilopascals at 20 °C is equal to or greater than 20 percent by weight of the total process

stream, and

(3) The fluid is a liquid at operating conditions.

(NOTE TO DEFINITION OF "IN LIGHT LIQUID SERVICE": Vapor pressures may be determined by standard reference texts or ASTM D-2879.)

*In liquid service* means that a piece of equipment in regulated material service is not in gas and vapor service.

*In organic hazardous air pollutant or in organic HAP service* means that piece of equipment either contains or contracts a fluid (liquid or gas) that is at least 5 percent by weight of total organic HAP's as determined according to the provisions of §63.180(d) of subpart H. The provisions of §63.180(d) of subpart H also specify how to determine that a piece of equipment is not in organic HAP service.

*In regulated material service* means, for the purposes of this subpart, equipment which meets the definition of "in VOC service," "in VHAP service," "in organic hazardous air pollutant service," or "in" other chemicals or groups of chemicals "service" as defined in the referencing subpart.

*In-situ sampling systems* means nonextractive samplers or in-line samplers.

*In vacuum service* means that equipment is operating at an internal pressure which is at least 5 kilopascals below ambient pressure.

*Initial startup* means for new sources, the first time the source begins production. For additions or changes not defined as a new source by this subpart, initial startup means the first time additional or changed equipment is put into operation. Initial startup does not include operation solely for testing of equipment. Initial startup does not include subsequent startup of process units following malfunction or process unit shutdowns. Except for equipment leaks, initial startup also does not include subsequent startups (of process units following changes in product for flexible operation units or following recharging of equipment in batch unit operations).

*Instrumentation system* means a group of equipment components used to condition and convey a sample of the process fluid to analyzers and instruments for the purpose of determining process operating conditions (e.g., composition, pressure, flow, etc.). Valves and connectors are the predominant type of equipment used in instrumentation systems; however, other types of equipment may also be included in these systems. Only valves nominally 1.27 centimeters (0.5 inches) and smaller, and connectors nominally 1.91 centimeters (0.75 inches) and smaller in diameter are considered instrumentation systems for the purposes of this subpart. Valves greater than nominally 1.27 centimeters (0.5 inches) and connectors greater than nominally 1.91 centimeters (0.75 inches) associated with instrumentation systems are not considered part of instrumentation systems and must be monitored individually.

*Liquids dripping* means any visible leakage from the seal including dripping, spraying, misting, clouding, and ice formation. Indications of liquids dripping include puddling or new stains that are indicative of an existing evaporated drip.

*Nonrepairable* means that it is technically infeasible to repair a piece of equipment from which a leak has been detected without a process unit or affected facility shutdown.

*Open-ended valve or line* means any valve, except relief valves, having one side of the valve seat in contact with process fluid and one side open to atmosphere, either directly or through open piping.

*Organic monitoring device* means a unit of equipment used to indicate the concentration level of organic compounds based on a detection principle such as infra-red, photoionization, or thermal conductivity.

*Polymerizing monomer* means a compound which may form polymer buildup in pump mechanical seals resulting in rapid mechanical seal failure.

*Pressure release* means the emission of materials resulting from the system pressure being greater than the set pressure of the relief device. This release can be one release or a series of releases over a short time period due to a malfunction in the process.

*Pressure relief device or valve* means a safety device used to prevent operating pressures from exceeding the maximum allowable working pressure of the process equipment. A common pressure relief device is a spring-loaded pressure relief valve. Devices that are actuated either by a pressure of less than or equal to 2.5 pounds per square inch gauge or by a vacuum are not pressure relief devices.

*Process unit* means the equipment specified in the definitions of process unit in the applicable referencing subpart. If the referencing subpart does not define process unit, then for the purposes of this part, process unit means the equipment assembled and connected by pipes or ducts to process raw materials and to manufacture an intended product.

*Process unit shutdown* means a work practice or operational procedure that stops production from a process unit, or part of a process unit during which it is technically feasible to clear process material from a process unit, or part of a process unit, consistent with safety constraints and during which repairs can be affected. The following are not considered process unit shutdowns:

(1) An unscheduled work practice or operations procedure that stops production from a process unit, or part of a process unit, for less than 24 hours.

(2) An unscheduled work practice or operations procedure that would stop production from a process unit, or part of a process unit, for a shorter period of time than would be required to clear the process unit, or part of the process unit, of materials and start up the unit, and would result in greater emissions than delay of repair of leaking components until the next scheduled process unit shutdown.

(3) The use of spare equipment and technically feasible bypassing of equipment without stopping production.

*Referencing subpart* means the subpart that refers an owner or operator to this subpart.

*Regulated material*, for purposes of this part, refers to gas from volatile organic liquids (VOL), volatile organic compounds (VOC), hazardous air pollutants (HAP), or other chemicals or groups of chemicals that are regulated by the referencing subpart.

*Regulated source* for the purposes of this part, means the stationary source, the group of stationary sources, or the portion of a stationary source that is regulated by a referencing subpart.

*Relief device or valve* means a valve used only to release an unplanned, nonroutine discharge. A relief valve discharge can result from an operator error, a malfunction such as a power failure or equipment failure, or other unexpected cause that requires immediate venting of gas from process equipment in order to avoid safety hazards or equipment damage.

*Repaired*, for the purposes of this subpart, means that equipment is adjusted, or otherwise altered, to eliminate a leak as defined in the applicable sections of this subpart and unless otherwise specified in



applicable provisions of this subpart, is monitored as specified in §§63.1023(b) and (c) to verify that emissions from the equipment are below the applicable leak definition.

*Routed to a process or route to a process* means the emissions are conveyed to any enclosed portion of a process unit where the emissions are predominantly recycled and/or consumed in the same manner as a material that fulfills the same function in the process and/or transformed by chemical reaction into materials that are not regulated materials and/or incorporated into a product; and/or recovered.

*Sampling connection system* means an assembly of equipment within a process unit or affected facility used during periods of representative operation to take samples of the process fluid. Equipment used to take nonroutine grab samples is not considered a sampling connection system.

*Screwed (threaded) connector* means a threaded pipe fitting where the threads are cut on the pipe wall and the fitting requires only two pieces to make the connection (i.e., the pipe and the fitting).

*Sensor* means a device that measures a physical quantity or the change in a physical quantity, such as temperature, pressure, flow rate, pH, or liquid level.

*Set pressure* means for the purposes of this subpart, the pressure at which a properly operating pressure relief device begins to open to relieve atypical process system operating pressure.

*Start-up* means the setting into operation of a piece of equipment or a control device that is subject to this subpart.

### **§63.1021 Alternative means of emission limitation.**

(a) *Performance standard exemption.* The provisions of paragraph (b) of this section do not apply to the performance standards of §63.1030(b) for pressure relief devices or §63.1031(f) for compressors operating under the alternative compressor standard.

(b) *Requests by owners or operators.* An owner or operator may request a determination of alternative means of emission limitation to the requirements of §§63.1025 through 63.1034 as provided in paragraph (d) of this section. If the Administrator makes a determination that a means of emission limitation is a permissible alternative, the owner or operator shall either comply with the alternative or comply with the requirements of §§63.1025 through 63.1034.

(c) *Requests by manufacturers of equipment.* (1) Manufacturers of equipment used to control equipment leaks of the regulated material may apply to the Administrator for permission for an alternative means of emission limitation that achieves a reduction in emissions of the regulated material achieved by the equipment, design, and operational requirements of this subpart.

(2) The Administrator will grant permission according to the provisions of paragraph (d) of this section.

(d) *Permission to use an alternative means of emission limitation.* Permission to use an alternative means of emission limitation shall be governed by the procedures in paragraphs (d)(1) through (d)(4) of this section.

(1) Where the standard is an equipment, design, or operational requirement, the requirements of paragraphs (d)(1)(i) through (d)(1)(iii) of this section apply.

(i) Each owner or operator applying for permission to use an alternative means of emission limitation shall be responsible for collecting and verifying emission performance test data for an alternative means of emission limitation.

(ii) The Administrator will compare test data for the means of emission limitation to test data for the equipment, design, and operational requirements.

(iii) The Administrator may condition the permission on requirements that may be necessary to ensure operation and maintenance to achieve at least the same emission reduction as the equipment, design, and operational requirements of this subpart.

(2) Where the standard is a work practice, the requirements of paragraphs (d)(2)(i) through (d)(2)(vi) of this section apply.

(i) Each owner or operator applying for permission to use an alternative means of emission limitation shall be responsible for collecting and verifying test data for the alternative.

(ii) For each kind of equipment for which permission is requested, the emission reduction achieved by the required work practices shall be demonstrated for a minimum period of 12 months.

(iii) For each kind of equipment for which permission is requested, the emission reduction achieved by the alternative means of emission limitation shall be demonstrated.

(iv) Each owner or operator applying for such permission shall commit, in writing, for each kind of equipment to work practices that provide for emission reductions equal to or greater than the emission reductions achieved by the required work practices.

(v) The Administrator will compare the demonstrated emission reduction for the alternative means of emission limitation to the demonstrated emission reduction for the required work practices and will consider the commitment in paragraph (d)(2)(iv) of this section.

(vi) The Administrator may condition the permission on requirements that may be necessary to ensure operation and maintenance to achieve the same or greater emission reduction as the required work practices of this subpart.

(3) An owner or operator may offer a unique approach to demonstrate the alternative means of emission limitation.

(4) If, in the judgement of the Administrator, an alternative means of emission limitation will be approved, the Administrator will publish a notice of the determination in the FEDERAL REGISTER using the procedures specified in the referencing subpart.

### **§63.1022 Equipment identification.**

(a) *General equipment identification.* Equipment subject to this subpart shall be identified. Identification of the equipment does not require physical tagging of the equipment. For example, the equipment may be identified on a plant site plan, in log entries, by designation of process unit or affected facility boundaries by some form of weatherproof identification, or by other appropriate methods.

(b) *Additional equipment identification.* In addition to the general identification required by paragraph (a) of this section, equipment subject to any of the provisions in §§63.1023 through 63.1034 shall be specifically identified as required in paragraphs (b)(1) through (b)(5) of this section, as applicable. This

paragraph does not apply to an owner or operator of a batch product process who elects to pressure test the batch product process equipment train pursuant to §63.1036.

(1) *Connectors.* Except for inaccessible, ceramic, or ceramic-lined connectors meeting the provision of §63.1027(e)(2) and instrumentation systems identified pursuant to paragraph (b)(4) of this section, identify the connectors subject to the requirements of this subpart. Connectors need not be individually identified if all connectors in a designated area or length of pipe subject to the provisions of this subpart are identified as a group, and the number of connectors subject is indicated. With respect to connectors, the identification shall be complete no later than the completion of the initial survey required by paragraph (a) of this section.

(2) *Routed to a process or fuel gas system or equipped with a closed vent system and control device.* Identify the equipment that the owner or operator elects to route to a process or fuel gas system or equip with a closed vent system and control device, under the provisions of §63.1026(e)(3) (pumps in light liquid service), §63.1028(e)(3) (agitators), §63.1030(d) (pressure relief devices in gas and vapor service), §63.1031(e) (compressors), or §63.1037(a) (alternative means of emission limitation for enclosed-vented process units).

(3) *Pressure relief devices.* Identify the pressure relief devices equipped with rupture disks, under the provisions of §63.1030(e).

(4) *Instrumentation systems.* Identify instrumentation systems subject to the provisions of §63.1029 of this subpart. Individual components in an instrumentation system need not be identified.

(5) *Equipment in service less than 300 hours per calendar year.* The identity, either by list, location (area or group), or other method, of equipment in regulated material service less than 300 hours per calendar year within a process unit or affected facilities subject to the provisions of this subpart shall be recorded.

(c) *Special equipment designations: Equipment that is unsafe or difficult-to-monitor—*(1) *Designation and criteria for unsafe-to-monitor.* Valves meeting the provisions of §63.1025(e)(1), pumps meeting the provisions of §63.1026(e)(6), connectors meeting the provisions of §63.1027(e)(1), and agitators meeting the provisions of §63.1028(e)(7) may be designated unsafe-to-monitor if the owner or operator determines that monitoring personnel would be exposed to an immediate danger as a consequence of complying with the monitoring requirements of this subpart. Examples of unsafe-to-monitor equipment include, but is not limited to, equipment under extreme pressure or heat.

(2) *Designation and criteria for difficult-to-monitor.* Valves meeting the provisions of §63.1025(e)(2) may be designated difficult-to-monitor if the provisions of paragraph (c)(2)(i) apply. Agitators meeting the provisions of §63.1028(e)(5) may be designated difficult-to-monitor if the provisions of paragraph (c)(2)(ii) apply.

(i) *Valves.* (A) The owner or operator of the valve determines that the valve cannot be monitored without elevating the monitoring personnel more than 2 meters (7 feet) above a support surface or it is not accessible in a safe manner when it is in regulated material service; and

(B) The process unit or affected facility within which the valve is located is an existing source, or the owner or operator designates less than 3 percent of the total number of valves in a new source as difficult-to-monitor.

(ii) *Agitators.* The owner or operator determines that the agitator cannot be monitored without elevating the monitoring personnel more than 2 meters (7 feet) above a support surface or it is not

accessible in a safe manner when it is in regulated material service.

(3) *Identification of unsafe or difficult-to-monitor equipment.* The owner or operator shall record the identity of equipment designated as unsafe-to-monitor according to the provisions of paragraph (c)(1) of this section and the planned schedule for monitoring this equipment. The owner or operator shall record the identity of equipment designated as difficult-to-monitor according to the provisions of paragraph (c)(2) of this section, the planned schedule for monitoring this equipment, and an explanation why the equipment is unsafe or difficult-to-monitor. This record must be kept at the plant and be available for review by an inspector.

(4) *Written plan requirements.* (i) The owner or operator of equipment designated as unsafe-to-monitor according to the provisions of paragraph (c)(1) of this section shall have a written plan that requires monitoring of the equipment as frequently as practical during safe-to-monitor times, but not more frequently than the periodic monitoring schedule otherwise applicable, and repair of the equipment according to the procedures in §63.1024 if a leak is detected.

(ii) The owner or operator of equipment designated as difficult-to-monitor according to the provisions of paragraph (c)(2) of this section shall have a written plan that requires monitoring of the equipment at least once per calendar year and repair of the equipment according to the procedures in §63.1024 if a leak is detected.

(d) *Special equipment designations: Equipment that is unsafe-to-repair—(1) Designation and criteria.* Connectors subject to the provisions of §63.1024(e) may be designated unsafe-to-repair if the owner or operator determines that repair personnel would be exposed to an immediate danger as a consequence of complying with the repair requirements of this subpart, and if the connector will be repaired before the end of the next process unit or affected facility shutdown as specified in §63.1024(e)(2).

(2) *Identification of equipment.* The identity of connectors designated as unsafe-to-repair and an explanation why the connector is unsafe-to-repair shall be recorded.

(e) *Special equipment designations: Compressors operating with an instrument reading of less than 500 parts per million above background.* Identify the compressors that the owner or operator elects to designate as operating with an instrument reading of less than 500 parts per million above background, under the provisions of §63.1031(f).

(f) *Special equipment designations: Equipment in heavy liquid service.* The owner or operator of equipment in heavy liquid service shall comply with the requirements of either paragraph (f)(1) or (f)(2) of this section, as provided in paragraph (f)(3) of this section.

(1) Retain information, data, and analyses used to determine that a piece of equipment is in heavy liquid service.

(2) When requested by the Administrator, demonstrate that the piece of equipment or process is in heavy liquid service.

(3) A determination or demonstration that a piece of equipment or process is in heavy liquid service shall include an analysis or demonstration that the process fluids do not meet the definition of “in light liquid service.” Examples of information that could document this include, but are not limited to, records of chemicals purchased for the process, analyses of process stream composition, engineering calculations, or process knowledge.

### **§63.1023 Instrument and sensory monitoring for leaks.**

(a) *Monitoring for leaks.* The owner or operator of a regulated source subject to this subpart shall monitor regulated equipment as specified in paragraph (a)(1) of this section for instrument monitoring and paragraph (a)(2) of this section for sensory monitoring.

(1) *Instrument monitoring for leaks.* (i) Valves in gas and vapor service and in light liquid service shall be monitored pursuant to §63.1025(b).

(ii) Pumps in light liquid service shall be monitored pursuant to §63.1026(b).

(iii) Connectors in gas and vapor service and in light liquid service shall be monitored pursuant to §63.1027(b).

(iv) Agitators in gas and vapor service and in light liquid service shall be monitored pursuant to §63.1028(c).

(v) Pressure relief devices in gas and vapor service shall be monitored pursuant to §63.1030(c).

(vi) Compressors designated to operate with an instrument reading less than 500 parts per million above background, as described in §63.1022(e), shall be monitored pursuant to §63.1031(f).

(2) *Sensory monitoring for leaks.* (i) Pumps in light liquid service shall be observed pursuant to §§63.1026(b)(4) and (e)(1)(v).

(ii) [Reserved]

(iii) Agitators in gas and vapor service and in light liquid service shall be observed pursuant to §63.1028(c)(3) or (e)(1)(iv).

(iv) [Reserved]

(b) *Instrument monitoring methods.* Instrument monitoring, as required under this subpart, shall comply with the requirements specified in paragraphs (b)(1) through (b)(6) of this section.

(1) *Monitoring method.* Monitoring shall comply with Method 21 of 40 CFR part 60, appendix A, except as otherwise provided in this section.

(2) *Detection instrument performance criteria.* (i) Except as provided for in paragraph (b)(2)(ii) of this section, the detection instrument shall meet the performance criteria of Method 21 of 40 CFR part 60, appendix A, except the instrument response factor criteria in section 3.1.2, paragraph (a) of Method 21 shall be for the representative composition of the process fluid not each individual VOC in the stream. For process streams that contain nitrogen, air, water or other inerts that are not HAP or VOC, the representative stream response factor shall be determined on an inert-free basis. The response factor may be determined at any concentration for which monitoring for leaks will be conducted.

(ii) If there is no instrument commercially available that will meet the performance criteria specified in paragraph (b)(2)(i) of this section, the instrument readings may be adjusted by multiplying by the representative response factor of the process fluid, calculated on an inert-free basis as described in paragraph (b)(2)(i) of this section.

(3) *Detection instrument calibration procedure.* The detection instrument shall be calibrated before

use on each day of its use by the procedures specified in Method 21 of 40 CFR part 60, appendix A.

(4) *Detection instrument calibration gas.* Calibration gases shall be zero air (less than 10 parts per million of hydrocarbon in air); and the gases specified in paragraph (b)(4)(i) of this section except as provided in paragraph (b)(4)(ii) of this section.

(i) Mixtures of methane in air at a concentration no more than 2,000 parts per million greater than the leak definition concentration of the equipment monitored. If the monitoring instrument's design allows for multiple calibration scales, then the lower scale shall be calibrated with a calibration gas that is no higher than 2,000 parts per million above the concentration specified as a leak, and the highest scale shall be calibrated with a calibration gas that is approximately equal to 10,000 parts per million. If only one scale on an instrument will be used during monitoring, the owner or operator need not calibrate the scales that will not be used during that day's monitoring.

(ii) A calibration gas other than methane in air may be used if the instrument does not respond to methane or if the instrument does not meet the performance criteria specified in paragraph (b)(2)(i) of this section. In such cases, the calibration gas may be a mixture of one or more of the compounds to be measured in air.

(5) *Monitoring performance.* Monitoring shall be performed when the equipment is in regulated material service or is in use with any other detectable material.

(6) *Monitoring data.* Monitoring data obtained prior to the regulated source becoming subject to the referencing subpart that do not meet the criteria specified in paragraphs (b)(1) through (b)(5) of this section may still be used to qualify initially for less frequent monitoring under the provisions in §63.1025(a)(2), (b)(3) or (b)(4) for valves or §63.1027(b)(3) for connectors provided the departures from the criteria or from the specified monitoring frequency of §63.1025(b)(3) or (b)(4) or §63.1027(b)(3) are minor and do not significantly affect the quality of the data. Examples of minor departures are monitoring at a slightly different frequency (such as every 6 weeks instead of monthly or quarterly), following the performance criteria of section 3.1.2, paragraph (a) of Method 21 of appendix A of 40 CFR part 60 instead of paragraph (b)(2) of this section, or monitoring using a different leak definition if the data would indicate the presence or absence of a leak at the concentration specified in this subpart. Failure to use a calibrated instrument is not considered a minor departure.

(c) *Instrument monitoring using background adjustments.* The owner or operator may elect to adjust or not to adjust the instrument readings for background. If an owner or operator elects not to adjust instrument readings for background, the owner or operator shall monitor the equipment according to the procedures specified in paragraphs (b)(1) through (b)(5) of this section. In such cases, all instrument readings shall be compared directly to the applicable leak definition for the monitored equipment to determine whether there is a leak or to determine compliance with §63.1030(b) (pressure relief devices) or §63.1031(f) (alternative compressor standard). If an owner or operator elects to adjust instrument readings for background, the owner or operator shall monitor the equipment according to the procedures specified in paragraphs (c)(1) through (c)(4) of this section.

(1) The requirements of paragraphs (b)(1) through (b)(5) of this section shall apply.

(2) The background level shall be determined, using the procedures in Method 21 of 40 CFR part 60, appendix A.

(3) The instrument probe shall be traversed around all potential leak interfaces as close to the interface as possible as described in Method 21 of 40 CFR part 60, appendix A.

(4) The arithmetic difference between the maximum concentration indicated by the instrument and

the background level shall be compared to the applicable leak definition for the monitored equipment to determine whether there is a leak or to determine compliance with §63.1030(b) (pressure relief devices) or §63.1031(f) (alternative compressor standard).

(d) *Sensory monitoring methods.* Sensory monitoring consists of visual, audible, olfactory, or any other detection method used to determine a potential leak to the atmosphere.

(e) *Leaking equipment identification and records.* (1) When each leak is detected pursuant to the monitoring specified in paragraph (a) of this section, a weatherproof and readily visible identification, shall be attached to the leaking equipment.

(2) When each leak is detected, the information specified in §63.1024(f) shall be recorded and kept pursuant to the referencing subpart, except for the information for connectors complying with the 8 year monitoring period allowed under §63.1027(b)(3)(iii) shall be kept 5 years beyond the date of its last use.

### **§63.1024 Leak repair.**

(a) *Leak repair schedule.* The owner or operator shall repair each leak detected as soon as practical, but not later than 15 calendar days after it is detected, except as provided in paragraphs (d) and (e) of this section. A first attempt at repair as defined in this subpart shall be made no later than 5 calendar days after the leak is detected. First attempt at repair for pumps includes, but is not limited to, tightening the packing gland nuts and/or ensuring that the seal flush is operating at design pressure and temperature. First attempt at repair for valves includes, but is not limited to, tightening the bonnet bolts, and/or replacing the bonnet bolts, and/or tightening the packing gland nuts, and/or injecting lubricant into the lubricated packing.

(b) [Reserved]

(c) *Leak identification removal—(1) Valves and connectors in gas/vapor and light liquid service.* The leak identification on a valve in gas/vapor or light liquid service may be removed after it has been monitored as specified in §63.1025(d)(2), and no leak has been detected during that monitoring. The leak identification on a connector in gas/vapor or light liquid service may be removed after it has been monitored as specified in §63.1027(b)(3)(iv) and no leak has been detected during that monitoring.

(2) *Other equipment.* The identification that has been placed, pursuant to §63.1023(e)(1), on equipment determined to have a leak, except for a valve or for a connector in gas/vapor or light liquid service that is subject to the provisions of §63.1027(b)(3)(iv), may be removed after it is repaired.

(d) *Delay of repair.* Delay of repair is allowed for any of the conditions specified in paragraphs (d)(1) through (d)(5) of this section. The owner or operator shall maintain a record of the facts that explain any delay of repairs and, where appropriate, why the repair was technically infeasible without a process unit shutdown.

(1) Delay of repair of equipment for which leaks have been detected is allowed if repair within 15 days after a leak is detected is technically infeasible without a process unit or affected facility shutdown. Repair of this equipment shall occur as soon as practical, but no later than the end of the next process unit or affected facility shutdown, except as provided in paragraph (d)(5) of this section.

(2) Delay of repair of equipment for which leaks have been detected is allowed for equipment that is isolated from the process and that does not remain in regulated material service.

(3) Delay of repair for valves, connectors, and agitators is also allowed if the provisions of

paragraphs (d)(3)(i) and (d)(3)(ii) of this section are met.

(i) The owner or operator determines that emissions of purged material resulting from immediate repair would be greater than the fugitive emissions likely to result from delay of repair, and

(ii) When repair procedures are effected, the purged material is collected and destroyed, collected and routed to a fuel gas system or process, or recovered in a control device complying with either §63.1034 or §63.1021(b) of this part.

(4) Delay of repair for pumps is also allowed if the provisions of paragraphs (d)(4)(i) and (d)(4)(ii) of this section are met.

(i) Repair requires replacing the existing seal design with a new system that the owner or operator has determined under the provisions of §63.1035(d) will provide better performance or one of the specifications of paragraphs (d)(4)(i)(A) through (d)(4)(i)(C) of this section are met.

(A) A dual mechanical seal system that meets the requirements of §63.1026(e)(1) will be installed;

(B) A pump that meets the requirements of §63.1026(e)(2) will be installed; or

(C) A system that routes emissions to a process or a fuel gas system or a closed vent system and control device that meets the requirements of §63.1026(e)(3) will be installed; and

(ii) Repair is completed as soon as practical, but not later than 6 months after the leak was detected.

(5) Delay of repair beyond a process unit or affected facility shutdown will be allowed for a valve if valve assembly replacement is necessary during the process unit or affected facility shutdown, and valve assembly supplies have been depleted, and valve assembly supplies had been sufficiently stocked before the supplies were depleted. Delay of repair beyond the second process unit or affected facility shutdown will not be allowed unless the third process unit or affected facility shutdown occurs sooner than 6 months after the first process unit or affected facility shutdown.

(e) *Unsafe-to-repair—connectors.* Any connector that is designated, as described in §63.1022(d), as an unsafe-to-repair connector is exempt from the requirements of §63.1027(d), and paragraph (a) of this section.

(f) *Leak repair records.* For each leak detected, the information specified in paragraphs (f)(1) through (f)(5) of this section shall be recorded and maintained pursuant to the referencing subpart.

(1) The date of first attempt to repair the leak.

(2) The date of successful repair of the leak.

(3) Maximum instrument reading measured by Method 21 of 40 CFR part 60, appendix A at the time the leak is successfully repaired or determined to be nonrepairable.

(4) "Repair delayed" and the reason for the delay if a leak is not repaired within 15 calendar days after discovery of the leak as specified in paragraphs (f)(4)(i) and (f)(4)(ii) of this section.

(i) The owner or operator may develop a written procedure that identifies the conditions that justify a delay of repair. The written procedures may be included as part of the startup, shutdown, and malfunction plan, as required by the referencing subpart for the source, or may be part of a separate document that is



maintained at the plant site. In such cases, reasons for delay of repair may be documented by citing the relevant sections of the written procedure.

(ii) If delay of repair was caused by depletion of stocked parts, there must be documentation that the spare parts were sufficiently stocked on-site before depletion and the reason for depletion.

(5) Dates of process unit or affected facility shutdowns that occur while the equipment is unrepaired.

### **§63.1025 Valves in gas and vapor service and in light liquid service standards.**

(a) *Compliance schedule.* (1) The owner or operator shall comply with this section no later than the compliance dates specified in the referencing subpart.

(2) The use of monitoring data generated before the regulated source became subject to the referencing subpart to qualify initially for less frequent monitoring is governed by the provisions of §63.1023(b)(6).

(b) *Leak detection.* Unless otherwise specified in §63.1021(b) or paragraph (e) of this section, or the referencing subpart, the owner or operator shall monitor all valves at the intervals specified in paragraphs (b)(3) and/or (b)(4) of this section and shall comply with all other provisions of this section.

(1) *Monitoring method.* The valves shall be monitored to detect leaks by the method specified in §63.1023(b) and, as applicable, §63.1023(c).

(2) *Instrument reading that defines a leak.* The instrument reading that defines a leak is 500 parts per million or greater.

(3) *Monitoring frequency.* The owner or operator shall monitor valves for leaks at the intervals specified in paragraphs (b)(3)(i) through (b)(3)(v) of this section and shall keep the record specified in paragraph (b)(3)(vi) of this section.

(i) If at least the greater of 2 valves or 2 percent of the valves in a process unit leak, as calculated according to paragraph (c) of this section, the owner or operator shall monitor each valve once per month.

(ii) At process units with less than the greater of 2 leaking valves or 2 percent leaking valves, the owner or operator shall monitor each valve once each quarter, except as provided in paragraphs (b)(3)(iii) through (b)(3)(v) of this section. Monitoring data generated before the regulated source became subject to the referencing subpart and meeting the criteria of either §63.1023(b)(1) through (b)(5), or §63.1023(b)(6), may be used to qualify initially for less frequent monitoring under paragraphs (b)(3)(iii) through (b)(3)(v) of this section.

(iii) At process units with less than 1 percent leaking valves, the owner or operator may elect to monitor each valve once every two quarters

(iv) At process units with less than 0.5 percent leaking valves, the owner or operator may elect to monitor each valve once every four quarters.

(v) At process units with less than 0.25 percent leaking valves, the owner or operator may elect to monitor each valve once every 2 years.

(vi) The owner or operator shall keep a record of the monitoring schedule for each process unit.

(4) *Valve subgrouping.* For a process unit or a group of process units to which this subpart applies, an owner or operator may choose to subdivide the valves in the applicable process unit or group of process units and apply the provisions of paragraph (b)(3) of this section to each subgroup. If the owner or operator elects to subdivide the valves in the applicable process unit or group of process units, then the provisions of paragraphs (b)(4)(i) through (b)(4)(viii) of this section apply.

(i) The overall performance of total valves in the applicable process unit or group of process units to be subdivided shall be less than 2 percent leaking valves, as detected according to paragraphs (b)(1) and (b)(2) of this section and as calculated according to paragraphs (c)(1)(ii) and (c)(2) of this section.

(ii) The initial assignment or subsequent reassignment of valves to subgroups shall be governed by the provisions of paragraphs (b)(4)(ii)(A) through (b)(4)(ii)(C) of this section.

(A) The owner or operator shall determine which valves are assigned to each subgroup. Valves with less than one year of monitoring data or valves not monitored within the last twelve months must be placed initially into the most frequently monitored subgroup until at least one year of monitoring data have been obtained.

(B) Any valve or group of valves can be reassigned from a less frequently monitored subgroup to a more frequently monitored subgroup provided that the valves to be reassigned were monitored during the most recent monitoring period for the less frequently monitored subgroup. The monitoring results must be included with that less frequently monitored subgroup's associated percent leaking valves calculation for that monitoring event.

(C) Any valve or group of valves can be reassigned from a more frequently monitored subgroup to a less frequently monitored subgroup provided that the valves to be reassigned have not leaked for the period of the less frequently monitored subgroup (e.g., for the last 12 months, if the valve or group of valves is to be reassigned to a subgroup being monitored annually). Nonrepairable valves may not be reassigned to a less frequently monitored subgroup.

(iii) The owner or operator shall determine every 6 months if the overall performance of total valves in the applicable process unit or group of process units is less than 2 percent leaking valves and so indicate the performance in the next Periodic Report. If the overall performance of total valves in the applicable process unit or group of process units is 2 percent leaking valves or greater, the owner or operator shall no longer subgroup and shall revert to the program required in paragraphs (b)(1) through (b)(3) of this section for that applicable process unit or group of process units. An owner or operator can again elect to comply with the valve subgrouping procedures of paragraph (b)(4) of this section if future overall performance of total valves in the process unit or group of process units is again less than 2 percent. The overall performance of total valves in the applicable process unit or group of process units shall be calculated as a weighted average of the percent leaking valves of each subgroup according to Equation number 1:

$$\%V_{LO} = \frac{\sum_{i=1}^n (\%V_{Li} \times V_i)}{\sum_{i=1}^n V_i} \quad [\text{Eq. 1}]$$

where:

$\%V_{LO}$  = Overall performance of total valves in the applicable process unit or group of process units

$\%V_{Li}$  = Percent leaking valves in subgroup i, most recent value calculated according to the procedures in paragraphs

(c)(1)(ii) and (c)(2) of this section.

$V_i$  = Number of valves in subgroup i.

n = Number of subgroups.

(iv) The owner or operator shall maintain records specified in paragraphs (b)(4)(iv)(A) through (b)(4)(iv)(D) of this section.

(A) Which valves are assigned to each subgroup,

(B) Monitoring results and calculations made for each subgroup for each monitoring period,

(C) Which valves are reassigned, the last monitoring result prior to reassignment, and when they were reassigned, and

(D) The results of the semiannual overall performance calculation required in paragraph (b)(4)(iii) of this section.

(v) The owner or operator shall notify the Administrator no later than 30 days prior to the beginning of the next monitoring period of the decision to subgroup valves. The notification shall identify the participating process units and the number of valves assigned to each subgroup, if applicable, and may be included in the next Periodic Report.

(vi) The owner or operator shall submit in the periodic reports the information specified in paragraphs (b)(4)(vi)(A) and (b)(4)(vi)(B).

(A) Total number of valves in each subgroup, and

(B) Results of the semiannual overall performance calculation required by paragraph (b)(4)(iii) of this section.

(vii) To determine the monitoring frequency for each subgroup, the calculation procedures of paragraph (c)(2) of this section shall be used.

(viii) Except for the overall performance calculations required by paragraphs (b)(4)(i) and (iii) of this section, each subgroup shall be treated as if it were a process unit for the purposes of applying the provisions of this section.

(c) *Percent leaking valves calculation—(1) Calculation basis and procedures.* (i) The owner or operator shall decide no later than the compliance date of this part or upon revision of an operating permit whether to calculate percent leaking valves on a process unit or group of process units basis. Once the owner or operator has decided, all subsequent percentage calculations shall be made on the same basis and this shall be the basis used for comparison with the subgrouping criteria specified in paragraph (b)(4)(i) of this section.

(ii) The percent leaking valves for each monitoring period for each process unit or valve subgroup, as provided in paragraph (b)(4) of this section, shall be calculated using the following equation:

$$\%V_L = (V_L/V_T) \times 100 \quad [\text{Eq. 2}]$$

where:

$\%V_L$  = Percent leaking valves.

$V_L$  = Number of valves found leaking, excluding nonrepairable valves, as provided in paragraph (c)(3) of this section, and including those valves found leaking pursuant to paragraphs (d)(2)(iii)(A) and (d)(2)(iii)(B) of this section.

$V_T$  = The sum of the total number of valves monitored.

(2) *Calculation for monitoring frequency.* When determining monitoring frequency for each process unit or valve subgroup subject to monthly, quarterly, or semiannual monitoring frequencies, the percent leaking valves shall be the arithmetic average of the percent leaking valves from the last two monitoring periods. When determining monitoring frequency for each process unit or valve subgroup subject to annual or biennial (once every 2 years) monitoring frequencies, the percent leaking valves shall be the arithmetic average of the percent leaking valves from the last three monitoring periods.

(3) *Nonrepairable valves.* (i) Nonrepairable valves shall be included in the calculation of percent leaking valves the first time the valve is identified as leaking and nonrepairable and as required to comply with paragraph (c)(3)(ii) of this section. Otherwise, a number of nonrepairable valves (identified and included in the percent leaking valves calculation in a previous period) up to a maximum of 1 percent of the total number of valves in regulated material service at a process unit or affected facility may be excluded from calculation of percent leaking valves for subsequent monitoring periods.

(ii) If the number of nonrepairable valves exceeds 1 percent of the total number of valves in regulated material service at a process unit or affected facility, the number of nonrepairable valves exceeding 1 percent of the total number of valves in regulated material service shall be included in the calculation of percent leaking valves.

(d) *Leak repair.* (1) If a leak is determined pursuant to paragraph (b), (e)(1), or (e)(2) of this section, then the leak shall be repaired using the procedures in §63.1024, as applicable.

(2) After a leak has been repaired, the valve shall be monitored at least once within the first 3 months after its repair. The monitoring required by this paragraph is in addition to the monitoring required to satisfy the definition of repaired and first attempt at repair.

(i) The monitoring shall be conducted as specified in §63.1023(b) and (c) of this section, as appropriate, to determine whether the valve has resumed leaking.

(ii) Periodic monitoring required by paragraph (b) of this section may be used to satisfy the requirements of this paragraph, if the timing of the monitoring period coincides with the time specified in this paragraph. Alternatively, other monitoring may be performed to satisfy the requirements of this paragraph, regardless of whether the timing of the monitoring period for periodic monitoring coincides with the time specified in this paragraph.

(iii) If a leak is detected by monitoring that is conducted pursuant to paragraph (d)(2) of this section, the owner or operator shall follow the provisions of paragraphs (d)(2)(iii)(A) and (d)(2)(iii)(B) of this section, to determine whether that valve must be counted as a leaking valve for purposes of paragraph (c)(1)(ii) of this section.

(A) If the owner or operator elected to use periodic monitoring required by paragraph (b) of this section to satisfy the requirements of paragraph (d)(2) of this section, then the valve shall be counted as a

leaking valve.

(B) If the owner or operator elected to use other monitoring, prior to the periodic monitoring required by paragraph (b) of this section, to satisfy the requirements of paragraph (d)(2) of this section, then the valve shall be counted as a leaking valve unless it is repaired and shown by periodic monitoring not to be leaking.

(e) *Special provisions for valves*—(1) *Unsafe-to-monitor valves.* Any valve that is designated, as described in §63.1022(c)(1), as an unsafe-to-monitor valve is exempt from the requirements of paragraphs (b) and (d)(2) of this section and the owner or operator shall monitor the valve according to the written plan specified in §63.1022(c)(4).

(2) *Difficult-to-monitor valves.* Any valve that is designated, as described in §63.1022(c)(2), as a difficult-to-monitor valve is exempt from the requirements of paragraph (b) of this section and the owner or operator shall monitor the valve according to the written plan specified in §63.1022(c)(4).

(3) *Fewer than 250 valves.* Any equipment located at a plant site with fewer than 250 valves in regulated material service is exempt from the requirements for monthly monitoring specified in paragraph (b)(3)(i) of this section. Instead, the owner or operator shall monitor each valve in regulated material service for leaks once each quarter, as provided in paragraphs (e)(1) and (e)(2) of this section.

#### **§63.1026 Pumps in light liquid service standards.**

(a) *Compliance schedule.* The owner or operator shall comply with this section no later than the compliance dates specified in the referencing subpart.

(b) *Leak detection.* Unless otherwise specified in §63.1021(b), §63.1036, §63.1037, or paragraph (e) of this section, the owner or operator shall monitor each pump to detect leaks and shall comply with all other provisions of this section.

(1) *Monitoring method and frequency.* The pumps shall be monitored monthly to detect leaks by the method specified in §63.1023(b) and, as applicable, §63.1023(c).

(2) *Instrument reading that defines a leak.* The instrument reading that defines a leak is specified in paragraphs (b)(2)(i) through (b)(2)(iii) of this section.

(i) 5,000 parts per million or greater for pumps handling polymerizing monomers;

(ii) 2,000 parts per million or greater for pumps in food/medical service; and

(iii) 1,000 parts per million or greater for all other pumps.

(3) *Leak repair exception.* For pumps to which a 1,000 parts per million leak definition applies, repair is not required unless an instrument reading of 2,000 parts per million or greater is detected.

(4) *Visual inspection.* Each pump shall be checked by visual inspection each calendar week for indications of liquids dripping from the pump seal. The owner or operator shall document that the inspection was conducted and the date of the inspection. If there are indications of liquids dripping from the pump seal at the time of the weekly inspection, the owner or operator shall follow the procedure specified in either paragraph (b)(4)(i) or (b)(4)(ii) of this section.

(i) The owner or operator shall monitor the pump as specified in §63.1023(b) and, as applicable,

§63.1023(c). If the instrument reading indicates a leak as specified in paragraph (b)(2) of this section, a leak is detected and it shall be repaired using the procedures in §63.1024, except as specified in paragraph (b)(3) of this section; or

(ii) The owner or operator shall eliminate the visual indications of liquids dripping.

(c) *Percent leaking pumps calculation.* (1) The owner or operator shall decide no later than the compliance date of this part or upon revision of an operating permit whether to calculate percent leaking pumps on a process unit basis or group of process units basis. Once the owner or operator has decided, all subsequent percentage calculations shall be made on the same basis.

(2) If, when calculated on a 6-month rolling average, at least the greater of either 10 percent of the pumps in a process unit or three pumps in a process unit leak, the owner or operator shall implement a quality improvement program for pumps that complies with the requirements of §63.1035.

(3) The number of pumps at a process unit or affected facility shall be the sum of all the pumps in regulated material service, except that pumps found leaking in a continuous process unit or affected facility within 1 month after start-up of the pump shall not count in the percent leaking pumps calculation for that one monitoring period only.

(4) Percent leaking pumps shall be determined by the following equation:

$$\%P_L = \left( \frac{P_L - P_s}{P_T - P_s} \right) \times 100 \quad [Eq. 3]$$

Where:

$\%P_L$  = Percent leaking pumps

$P_L$  = Number of pumps found leaking as determined through monthly monitoring as required in paragraph (b)(1) of this section. Do not include results from inspection of unsafe-to-monitor pumps pursuant to paragraph (e)(6) of this section.

$P_s$  = Number of pumps leaking within 1 month of start-up during the current monitoring period.

$P_T$  = Total pumps in regulated material service, including those meeting the criteria in paragraphs (e)(1), (e)(2), (e)(3), and (e)(6) of this section.

(d) *Leak repair.* If a leak is detected pursuant to paragraph (b) of this section, then the leak shall be repaired using the procedures in §63.1024, as applicable, unless otherwise specified in paragraph (b)(5) of this section for leaks identified by visual indications of liquids dripping.

(e) *Special provisions for pumps—(1) Dual mechanical seal pumps.* Each pump equipped with a dual mechanical seal system that includes a barrier fluid system is exempt from the requirements of paragraph (b) of this section, provided the requirements specified in paragraphs (e)(1)(i) through (e)(1)(viii) of this section are met.

(i) The owner or operator determines, based on design considerations and operating experience, criteria applicable to the presence and frequency of drips and to the sensor that indicates failure of the seal system, the barrier fluid system, or both. The owner or operator shall keep records at the plant of the design criteria and an explanation of the design criteria; and any changes to these criteria and the reasons for the changes. This record must be available for review by an inspector.

(ii) Each dual mechanical seal system shall meet the requirements specified in paragraph

(e)(1)(ii)(A), (e)(1)(ii)(B), or (e)(1)(ii)(C) of this section.

(A) Each dual mechanical seal system is operated with the barrier fluid at a pressure that is at all times (except periods of startup, shutdown, or malfunction) greater than the pump stuffing box pressure; or

(B) Equipped with a barrier fluid degassing reservoir that is routed to a process or fuel gas system or connected by a closed-vent system to a control device that complies with the requirements of either §63.1034 or §63.1021(b) of this part; or

(C) Equipped with a closed-loop system that purges the barrier fluid into a process stream.

(iii) The barrier fluid is not in light liquid service.

(iv) Each barrier fluid system is equipped with a sensor that will detect failure of the seal system, the barrier fluid system, or both.

(v) Each pump is checked by visual inspection each calendar week for indications of liquids dripping from the pump seal. The owner or operator shall document that the inspection was conducted and the date of the inspection. If there are indications of liquids dripping from the pump seal at the time of the weekly inspection, the owner or operator shall follow the procedure specified in paragraphs (e)(1)(v)(A) or (e)(1)(v)(B) of this section prior to the next required inspection.

(A) The owner or operator shall monitor the pump as specified in §63.1023(b) and, as applicable, §63.1023 (c), to determine if there is a leak of regulated material in the barrier fluid. If an instrument reading of 1,000 parts per million or greater is measured, a leak is detected and it shall be repaired using the procedures in §63.1024; or

(B) The owner or operator shall eliminate the visual indications of liquids dripping.

(vi) If indications of liquids dripping from the pump seal exceed the criteria established in paragraph (e)(1)(i) of this section, or if based on the criteria established in paragraph (e)(1)(i) of this section the sensor indicates failure of the seal system, the barrier fluid system, or both, a leak is detected.

(vii) Each sensor as described in paragraph (e)(1)(iv) of this section is observed daily or is equipped with an alarm unless the pump is located within the boundary of an unmanned plant site.

(viii) When a leak is detected pursuant to paragraph (e)(1)(vi) of this section, it shall be repaired as specified in §63.1024.

(2) *No external shaft.* Any pump that is designed with no externally actuated shaft penetrating the pump housing is exempt from the requirements of paragraph (b) of this section.

(3) *Routed to a process or fuel gas system or equipped with a closed vent system.* Any pump that is routed to a process or fuel gas system or equipped with a closed vent system capable of capturing and transporting leakage from the pump to a control device meeting the requirements of §63.1034 of this part or §63.1021(b) is exempt from the requirements of paragraph (b) of this section.

(4) *Unmanned plant site.* Any pump that is located within the boundary of an unmanned plant site is exempt from the weekly visual inspection requirement of paragraphs (b)(4) and (e)(1)(v) of this section, and the daily requirements of paragraph (e)(1)(vii) of this section, provided that each pump is visually

inspected as often as practical and at least monthly.

(5) *90 percent exemption.* If more than 90 percent of the pumps at a process unit or affected facility meet the criteria in either paragraph (e)(1) or (e)(2) of this section, the process unit or affected facility is exempt from the percent leaking calculation in paragraph (c) of this section.

(6) *Unsafe-to-monitor pumps.* Any pump that is designated, as described in §63.1022(c)(1), as an unsafe-to-monitor pump is exempt from the requirements of paragraph (b) of this section, the monitoring and inspection requirements of paragraphs (e)(1)(v) through (viii) of this section, and the owner or operator shall monitor and inspect the pump according to the written plan specified in §63.1022(c)(4).

[64 FR 34899, June 29, 1999, as amended at 64 FR 63706, Nov. 22, 1999]

### **§63.1027 Connectors in gas and vapor service and in light liquid service standards.**

(a) *Compliance schedule.* The owner or operator shall monitor all connectors in each process unit initially for leaks by the later of either 12 months after the compliance date as specified in a referencing subpart or 12 months after initial startup. If all connectors in each process unit have been monitored for leaks prior to the compliance date specified in the referencing subpart, no initial monitoring is required provided either no process changes have been made since the monitoring or the owner or operator can determine that the results of the monitoring, with or without adjustments, reliably demonstrate compliance despite process changes. If required to monitor because of a process change, the owner or operator is required to monitor only those connectors involved in the process change.

(b) *Leak detection.* Except as allowed in §63.1021(b), §63.1036, §63.1037, or as specified in paragraph (e) of this section, the owner or operator shall monitor all connectors in gas and vapor and light liquid service as specified in paragraphs (a) and (b)(3) of this section.

(1) *Monitoring method.* The connectors shall be monitored to detect leaks by the method specified in §63.1023(b) and, as applicable, §63.1023(c).

(2) *Instrument reading that defines a leak.* If an instrument reading greater than or equal to 500 parts per million is measured, a leak is detected.

(3) *Monitoring periods.* The owner or operator shall perform monitoring, subsequent to the initial monitoring required in paragraph (a) of this section, as specified in paragraphs (b)(3)(i) through (b)(3)(iii) of this section, and shall comply with the requirements of paragraphs (b)(3)(iv) and (b)(3)(v) of this section. The required period in which monitoring must be conducted shall be determined from paragraphs (b)(3)(i) through (b)(3)(iii) of this section using the monitoring results from the preceding monitoring period. The percent leaking connectors shall be calculated as specified in paragraph (c) of this section.

(i) If the percent leaking connectors in the process unit was greater than or equal to 0.5 percent, then monitor within 12 months (1 year).

(ii) If the percent leaking connectors in the process unit was greater than or equal to 0.25 percent but less than 0.5 percent, then monitor within 4 years. An owner or operator may comply with the requirements of this paragraph by monitoring at least 40 percent of the connectors within 2 years of the start of the monitoring period, provided all connectors have been monitored by the end of the 4 year monitoring period.

(iii) If the percent leaking connectors in the process unit was less than 0.25 percent, then monitor as provided in paragraph (b)(3)(iii)(A) of this section and either paragraph (b)(3)(iii)(B) or (b)(3)(iii)(C) of this



section, as appropriate.

(A) An owner or operator shall monitor at least 50 percent of the connectors within 4 years of the start of the monitoring period.

(B) If the percent leaking connectors calculated from the monitoring results in paragraph (b)(3)(iii)(A) of this section is greater than or equal to 0.35 percent of the monitored connectors, the owner or operator shall monitor as soon as practical, but within the next 6 months, all connectors that have not yet been monitored during the monitoring period. At the conclusion of monitoring, a new monitoring period shall be started pursuant to paragraph (b)(3) of this section, based on the percent leaking connectors of the total monitored connectors.

(C) If the percent leaking connectors calculated from the monitoring results in paragraph (b)(3)(iii)(A) of this section is less than 0.35 percent of the monitored connectors, the owner or operator shall monitor all connectors that have not yet been monitored within 8 years of the start of the monitoring period.

(iv) If, during the monitoring conducted pursuant to paragraph (b)(3)(i) through (b)(3)(iii) of this section, a connector is found to be leaking, it shall be re-monitored once within 90 days after repair to confirm that it is not leaking.

(v) The owner or operator shall keep a record of the start date and end date of each monitoring period under this section for each process unit.

(c) *Percent leaking connectors calculation.* For use in determining the monitoring frequency, as specified in paragraphs (a) and (b)(3) of this section, the percent leaking connectors as used in paragraphs (a) and (b)(3) of this section shall be calculated by using equation number 4.

$$\%C_L = C_L/C_t \times 100 \quad [\text{Eq. 4}]$$

Where:

$\%C_L$  = Percent leaking connectors as determined through periodic monitoring required in paragraphs (a) and (b)(3)(i) through (b)(3)(iii) of this section.

$C_L$  = Number of connectors measured at 500 parts per million or greater, by the method specified in §63.1023(b).

$C_t$  = Total number of monitored connectors in the process unit or affected facility.

(d) *Leak repair.* If a leak is detected pursuant to paragraphs (a) and (b) of this section, then the leak shall be repaired using the procedures in §63.1024, as applicable.

(e) *Special provisions for connectors—(1) Unsafe-to-monitor connectors.* Any connector that is designated, as described in §63.1022(c)(1), as an unsafe-to-monitor connector is exempt from the requirements of paragraphs (a) and (b) of this section and the owner or operator shall monitor according to the written plan specified in §63.1022(c)(4).

(2) *Inaccessible, ceramic, or ceramic-lined connectors.* (i) Any connector that is inaccessible or that is ceramic or ceramic-lined (e.g., porcelain, glass, or glass-lined), is exempt from the monitoring requirements of paragraphs (a) and (b) of this section, from the leak repair requirements of paragraph (d) of this section, and from the recordkeeping and reporting requirements of §§63.1038 and 63.1039. An inaccessible connector is one that meets any of the provisions specified in paragraphs (e)(2)(i)(A) through (e)(2)(i)(F) of this section, as applicable.

(A) Buried;

(B) Insulated in a manner that prevents access to the connector by a monitor probe;

(C) Obstructed by equipment or piping that prevents access to the connector by a monitor probe;

(D) Unable to be reached from a wheeled scissor-lift or hydraulic-type scaffold that would allow access to connectors up to 7.6 meters (25 feet) above the ground.

(E) Inaccessible because it would require elevating the monitoring personnel more than 2 meters (7 feet) above a permanent support surface or would require the erection of scaffold;

(F) Not able to be accessed at any time in a safe manner to perform monitoring. Unsafe access includes, but is not limited to, the use of a wheeled scissor-lift on unstable or uneven terrain, the use of a motorized man-lift basket in areas where an ignition potential exists, or access would require near proximity to hazards such as electrical lines, or would risk damage to equipment.

(ii) If any inaccessible, ceramic or ceramic-lined connector is observed by visual, audible, olfactory, or other means to be leaking, the visual, audible, olfactory, or other indications of a leak to the atmosphere shall be eliminated as soon as practical.

**§63.1028 Agitators in gas and vapor service and in light liquid service standards.**

(a) *Compliance schedule.* The owner or operator shall comply with this section no later than the compliance dates specified in the referencing subpart.

(b) [Reserved]

(c) *Leak detection—(1) Monitoring method.* Each agitator seal shall be monitored monthly to detect leaks by the methods specified in §63.1023(b) and, as applicable, §63.1023(c), except as provided in §63.1021(b), §63.1036, §63.1037, or paragraph (e) of this section.

(2) *Instrument reading that defines a leak.* If an instrument reading equivalent of 10,000 parts per million or greater is measured, a leak is detected.

(3) *Visual inspection.* (i) Each agitator seal shall be checked by visual inspection each calendar week for indications of liquids dripping from the agitator seal. The owner or operator shall document that the inspection was conducted and the date of the inspection.

(ii) If there are indications of liquids dripping from the agitator seal, the owner or operator shall follow the procedures specified in paragraphs (c)(3)(ii)(A) or (c)(3)(ii)(B) of this section prior to the next required inspection.

(A) The owner or operator shall monitor the agitator seal as specified in §63.1023(b) and, as applicable, §63.1023(c), to determine if there is a leak of regulated material. If an instrument reading of 10,000 parts per million or greater is measured, a leak is detected, and it shall be repaired according to paragraph (d) of this section; or

(B) The owner or operator shall eliminate the indications of liquids dripping from the agitator seal.

(d) *Leak repair.* If a leak is detected, then the leak shall be repaired using the procedures in

§63.1024.

(e) *Special provisions for agitators*—(1) *Dual mechanical seal*. Each agitator equipped with a dual mechanical seal system that includes a barrier fluid system is exempt from the requirements of paragraph (c) of this section, provided the requirements specified in paragraphs (e)(1)(i) through (e)(1)(vi) of this section are met.

(i) Each dual mechanical seal system shall meet the applicable requirements specified in paragraphs (e)(1)(i)(A), (e)(1)(i)(B), or (e)(1)(i)(C) of this section.

(A) Operated with the barrier fluid at a pressure that is at all times (except during periods of startup, shutdown, or malfunction) greater than the agitator stuffing box pressure; or

(B) Equipped with a barrier fluid degassing reservoir that is routed to a process or fuel gas system or connected by a closed-vent system to a control device that meets the requirements of either §63.1034 or §63.1021(b); or

(C) Equipped with a closed-loop system that purges the barrier fluid into a process stream.

(ii) The barrier fluid is not in light liquid service.

(iii) Each barrier fluid system is equipped with a sensor that will detect failure of the seal system, the barrier fluid system, or both.

(iv) Each agitator seal is checked by visual inspection each calendar week for indications of liquids dripping from the agitator seal. If there are indications of liquids dripping from the agitator seal at the time of the weekly inspection, the owner or operator shall follow the procedure specified in paragraphs (e)(1)(iv)(A) or (e)(1)(iv)(B) of this section prior to the next required inspection.

(A) The owner or operator shall monitor the agitator seal as specified in §63.1023(b) and, as applicable, §63.1023(c), to determine the presence of regulated material in the barrier fluid. If an instrument reading equivalent to or greater than 10,000 ppm is measured, a leak is detected and it shall be repaired using the procedures in §63.1024, or

(B) The owner or operator shall eliminate the visual indications of liquids dripping.

(v) Each sensor as described in paragraph (e)(1)(iii) of this section is observed daily or is equipped with an alarm unless the agitator seal is located within the boundary of an unmanned plant site.

(vi) The owner or operator of each dual mechanical seal system shall meet the requirements specified in paragraphs (e)(1)(vi)(A) and (e)(1)(vi)(B).

(A) The owner or operator shall determine, based on design considerations and operating experience, criteria that indicates failure of the seal system, the barrier fluid system, or both and applicable to the presence and frequency of drips. If indications of liquids dripping from the agitator seal exceed the criteria, or if, based on the criteria the sensor indicates failure of the seal system, the barrier fluid system, or both, a leak is detected and shall be repaired pursuant to §63.1024, as applicable.

(B) The owner or operator shall keep records of the design criteria and an explanation of the design criteria; and any changes to these criteria and the reasons for the changes.

(2) *No external shaft*. Any agitator that is designed with no externally actuated shaft penetrating the

agitator housing is exempt from paragraph (c) of this section.

(3) *Routed to a process or fuel gas system or equipped with a closed vent system.* Any agitator that is routed to a process or fuel gas system that captures and transports leakage from the agitator to a control device meeting the requirements of either §63.1034 or §63.1021(b) is exempt from the requirements of paragraph (c) of this section.

(4) *Unmanned plant site.* Any agitator that is located within the boundary of an unmanned plant site is exempt from the weekly visual inspection requirement of paragraphs (c)(3) and (e)(1)(iv) of this section, and the daily requirements of paragraph (e)(1)(v) of this section, provided that each agitator is visually inspected as often as practical and at least monthly.

(5) *Difficult-to-monitor agitator seals.* Any agitator seal that is designated, as described in §63.1022(c)(2), as a difficult-to-monitor agitator seal is exempt from the requirements of paragraph (c) of this section and the owner or operator shall monitor the agitator seal according to the written plan specified in §63.1022(c)(4).

(6) *Equipment obstructions.* Any agitator seal that is obstructed by equipment or piping that prevents access to the agitator by a monitor probe is exempt from the monitoring requirements of paragraph (c) of this section.

(7) *Unsafe-to-monitor agitator seals.* Any agitator seal that is designated, as described in §63.1022(c)(1), as an unsafe-to-monitor agitator seal is exempt from the requirements of paragraph (c) of this section and the owner or operator of the agitator seal monitors the agitator seal according to the written plan specified in §63.1022(c)(4).

**§63.1029 Pumps, valves, connectors, and agitators in heavy liquid service; pressure relief devices in liquid service; and instrumentation systems standards.**

(a) *Compliance schedule.* The owner or operator shall comply with this section no later than the compliance dates specified in the referencing subpart.

(b) *Leak detection—(1) Monitoring method.* Unless otherwise specified in §63.1021(b), §63.1036, or §63.1037, the owner or operator shall comply with paragraphs (b)(1) and (b)(2) of this section. Pumps, valves, connectors, and agitators in heavy liquid service; pressure relief devices in light liquid or heavy liquid service; and instrumentation systems shall be monitored within 5 calendar days by the method specified in §63.1023(b) and, as applicable, §63.1023(c), if evidence of a potential leak to the atmosphere is found by visual, audible, olfactory, or any other detection method, unless the potential leak is repaired as required in paragraph (c) of this section.

(2) *Instrument reading that defines a leak.* If an instrument reading of 10,000 parts per million or greater for agitators, 5,000 parts per million or greater for pumps handling polymerizing monomers, 2,000 parts per million or greater for pumps in food and medical service, or 2,000 parts per million or greater for all other pumps (including pumps in food/medical service), or 500 parts per million or greater for valves, connectors, instrumentation systems, and pressure relief devices is measured pursuant to paragraph (b)(1) of this section, a leak is detected and shall be repaired pursuant to §63.1024, as applicable.

(c) *Leak repair.* For equipment identified in paragraph (b) of this section that is not monitored by the method specified in §63.1023(b) and, as applicable, §63.1023(c), repaired shall mean that the visual, audible, olfactory, or other indications of a leak to the atmosphere have been eliminated; that no bubbles are observed at potential leak sites during a leak check using soap solution; or that the system will hold a test pressure.

**§63.1030 Pressure relief devices in gas and vapor service standards.**

(a) *Compliance schedule.* The owner or operator shall comply with this section no later than the compliance dates specified in the referencing subpart.

(b) *Compliance standard.* Except during pressure releases as provided for in paragraph (c) of this section, or as otherwise specified in §§63.1036, 63.1037, or paragraphs (d) and (e) of this section, each pressure relief device in gas and vapor service shall be operated with an instrument reading of less than 500 parts per million as measured by the method specified in §63.1023(b) and, as applicable, §63.1023(c).

(c) *Pressure relief requirements.* (1) After each pressure release, the pressure relief device shall be returned to a condition indicated by an instrument reading of less than 500 parts per million, as soon as practical, but no later than 5 calendar days after each pressure release, except as provided in §63.1024(d).

(2) The pressure relief device shall be monitored no later than five calendar days after the pressure to confirm the condition indicated by an instrument reading of less than 500 parts per million above background, as measured by the method specified in §63.1023(b) and, as applicable, §63.1023(c).

(3) The owner or operator shall record the dates and results of the monitoring required by paragraph (c)(2) of this section following a pressure release including the background level measured and the maximum instrument reading measured during the monitoring.

(d) *Pressure relief devices routed to a process or fuel gas system or equipped with a closed vent system and control device.* Any pressure relief device that is routed to a process or fuel gas system or equipped with a closed vent system capable of capturing and transporting leakage from the pressure relief device to a control device meeting the requirements of §63.1034 is exempt from the requirements of paragraphs (b) and (c) of this section.

(e) *Rupture disk exemption.* Any pressure relief device that is equipped with a rupture disk upstream of the pressure relief device is exempt from the requirements of paragraphs (b) and (c) of this section provided the owner or operator installs a replacement rupture disk upstream of the pressure relief device as soon as practical after each pressure release but no later than 5 calendar days after each pressure release, except as provided in §63.1024(d).

**§63.1031 Compressors standards.**

(a) *Compliance schedule.* The owner or operator shall comply with this section no later than the compliance dates specified in the referencing subpart.

(b) *Seal system standard.* Each compressor shall be equipped with a seal system that includes a barrier fluid system and that prevents leakage of process fluid to the atmosphere, except as provided in §§63.1021(b), 63.1036, 63.1037, and paragraphs (e) and (f) of this section. Each compressor seal system shall meet the applicable requirements specified in paragraph (b)(1), (b)(2), or (b)(3) of this section.

(1) Operated with the barrier fluid at a pressure that is greater than the compressor stuffing box pressure at all times (except during periods of startup, shutdown, or malfunction); or

(2) Equipped with a barrier fluid system degassing reservoir that is routed to a process or fuel gas

system or connected by a closed-vent system to a control device that meets the requirements of either §63.1034 or §63.1021(b); or

(3) Equipped with a closed-loop system that purges the barrier fluid directly into a process stream.

(c) *Barrier fluid system.* The barrier fluid shall not be in light liquid service. Each barrier fluid system shall be equipped with a sensor that will detect failure of the seal system, barrier fluid system, or both. Each sensor shall be observed daily or shall be equipped with an alarm unless the compressor is located within the boundary of an unmanned plant site.

(d) *Failure criterion and leak detection.* (1) The owner or operator shall determine, based on design considerations and operating experience, a criterion that indicates failure of the seal system, the barrier fluid system, or both. If the sensor indicates failure of the seal system, the barrier fluid system, or both based on the criterion, a leak is detected and shall be repaired pursuant to §63.1024, as applicable.

(2) The owner or operator shall keep records of the design criteria and an explanation of the design criteria; and any changes to these criteria and the reasons for the changes.

(e) *Routed to a process or fuel gas system or equipped with a closed vent system.* A compressor is exempt from the requirements of paragraphs (b) through (d) of this section if it is equipped with a system to capture and transport leakage from the compressor drive shaft seal to a process or a fuel gas system or to a closed vent system that captures and transports leakage from the compressor to a control device meeting the requirements of either §63.1034 or §63.1021(b).

(f) *Alternative compressor standard.* (1) Any compressor that is designated, as described in §63.1022(e), as operating with an instrument reading of less than 500 parts per million above background shall operate at all times with an instrument reading of less than 500 parts per million. A compressor so designated is exempt from the requirements of paragraphs (b) through (d) of this section if the compressor is demonstrated, initially upon designation, annually, and at other times requested by the Administrator to be operating with an instrument reading of less than 500 parts per million above background, as measured by the method specified in §63.1023(b) and, as applicable, §63.1023(c).

(2) The owner or operator shall record the dates and results of each compliance test including the background level measured and the maximum instrument reading measured during each compliance test.

### **§63.1032 Sampling connection systems standards.**

(a) *Compliance schedule.* The owner or operator shall comply with this section no later than the compliance dates specified in the referencing subpart.

(b) *Equipment requirement.* Each sampling connection system shall be equipped with a closed-purge, closed-loop, or closed vent system, except as provided in §§63.1021(b), 63.1036, 63.1037, or paragraph (d) of this section. Gases displaced during filling of the sample container are not required to be collected or captured.

(c) *Equipment design and operation.* Each closed-purge, closed-loop, or closed vent system as required in paragraph (b) of this section shall meet the applicable requirements specified in paragraphs (c)(1) through (c)(5) of this section.

(1) The system shall return the purged process fluid directly to a process line or to a fuel gas system that meets the requirements of either §63.1034 or §63.1021(b); or

(2) [Reserved]

(3) Be designed and operated to capture and transport all the purged process fluid to a control device that meets the requirements of either §63.1034 or §63.1021(b); or

(4) Collect, store, and transport the purged process fluid to a system or facility identified in paragraph (c)(4)(i), (c)(4)(ii), or (c)(4)(iii) of this section.

(i) A waste management unit as defined in 40 CFR 63.111 or subpart G, if the waste management unit is subject to and operating in compliance with the provisions of 40 CFR part 63, subpart G, applicable to group 1 wastewater streams. If the purged process fluid does not contain any regulated material listed in Table 9 of 40 CFR part 63, subpart G, the waste management unit need not be subject to, and operated in compliance with the requirements of 40 CFR part 63, subpart G, applicable to group 1 wastewater streams provided the facility has a National Pollution Discharge Elimination System (NPDES) permit or sends the wastewater to an NPDES-permitted facility.

(ii) A treatment, storage, or disposal facility subject to regulation under 40 CFR parts 262, 264, 265, or 266; or

(iii) A facility permitted, licensed, or registered by a State to manage municipal or industrial solid waste, if the process fluids are not hazardous waste as defined in 40 CFR part 261.

(5) Containers that are part of a closed purge system must be covered or closed when not being filled or emptied.

(d) *In-situ sampling systems.* In-situ sampling systems and sampling systems without purges are exempt from the requirements of paragraphs (b) and (c) of this section.

### **§63.1033 Open-ended valves or lines standards.**

(a) *Compliance schedule.* The owner or operator shall comply with this section no later than the compliance date specified in the referencing subpart.

(b) *Equipment and operational requirements.* (1) Each open-ended valve or line shall be equipped with a cap, blind flange, plug, or a second valve, except as provided in §§63.1021(b), 63.1036, 63.1037, and paragraphs (c) and (d) of this section. The cap, blind flange, plug, or second valve shall seal the open end at all times except during operations requiring process fluid flow through the open-ended valve or line, or during maintenance. The operational provisions of paragraphs (b)(2) and (b)(3) of this section also apply.

(2) Each open-ended valve or line equipped with a second valve shall be operated in a manner such that the valve on the process fluid end is closed before the second valve is closed.

(3) When a double block and bleed system is being used, the bleed valve or line may remain open during operations that require venting the line between the block valves but shall comply with paragraph (b)(1) of this section at all other times.

(c) *Emergency shutdown exemption.* Open-ended valves or lines in an emergency shutdown system that are designed to open automatically in the event of a process upset are exempt from the requirements of paragraph (b) of this section.

(d) *Polymerizing materials exemption.* Open-ended valves or lines containing materials that would

autocatalytically polymerize or, would present an explosion, serious overpressure, or other safety hazard if capped or equipped with a double block and bleed system as specified in paragraph (b) of this section are exempt from the requirements of paragraph (b) of this section.

**§63.1034 Closed vent systems and control devices; or emissions routed to a fuel gas system or process standards.**

(a) *Compliance schedule.* The owner or operator shall comply with this section no later than the compliance date specified in the referencing subpart.

(b) *Compliance standard.* (1) Owners or operators routing emissions from equipment leaks to a fuel gas system or process shall comply with the provisions of subpart SS of this part, except as provided in §63.1002(b).

(2) Owners or operators of closed vent systems and control devices used to comply with the provisions of this subpart shall comply with the provisions of subpart SS of this part and (b)(2)(i) through (b)(2)(iii) of this section, except as provided in §63.1002(b).

(i) Nonflare control devices shall be designed and operated to reduce emissions of regulated material vented to them with an efficiency of 95 percent or greater, or to an exit concentration of 20 parts per million by volume, whichever is less stringent. The 20 parts per million by volume standard is not applicable to the provisions of §63.1016.

(ii) Enclosed combustion devices shall be designed and operated to reduce emissions of regulated material vented to them with an efficiency of 95 percent or greater, or to an exit concentration of 20 parts per million by volume, on a dry basis, corrected to 3 percent oxygen, whichever is less stringent, or to provide a minimum residence time of 0.50 seconds at a minimum temperature of 760 °C (1400 °F).

(iii) Flares used to comply with the provisions of this subpart shall comply with the requirements of subpart SS of this part.

**§63.1035 Quality improvement program for pumps.**

(a) *Criteria.* If, on a 6-month rolling average, at least the greater of either 10 percent of the pumps in a process unit or affected facility (or plant site) or three pumps in a process unit or affected facility (or plant site) leak, the owner or operator shall comply with the requirements specified in paragraphs (a)(1) and (a)(2) of this section.

(1) Pumps that are in food and medical service or in polymerizing monomer service shall comply with all requirements except for those specified in paragraph (d)(8) of this section.

(2) Pumps that are not in food and medical or polymerizing monomer service shall comply with all of the requirements of this section.

(b) *Exiting the QIP.* The owner or operator shall comply with the requirements of this section until the number of leaking pumps is less than the greater of either 10 percent of the pumps or three pumps, calculated as a 6-month rolling average, in the process unit or affected facility (or plant site). Once the performance level is achieved, the owner or operator shall comply with the requirements in §63.1026.

(c) *Resumption of QIP.* If, in a subsequent monitoring period, the process unit or affected facility (or plant site) has greater than either 10 percent of the pumps leaking or three pumps leaking (calculated as a 6-month rolling average), the owner or operator shall resume the quality improvement program starting



at performance trials.

(d) *QIP requirements.* The quality improvement program shall meet the requirements specified in paragraphs (d)(1) through (d)(8) of this section.

(1) The owner or operator shall comply with the requirements in §63.1026.

(2) *Data collection.* The owner or operator shall collect the data specified in paragraphs (d)(2)(i) through (d)(2)(v) of this section and maintain records for each pump in each process unit or affected facility (or plant site) subject to the quality improvement program. The data may be collected and the records may be maintained on a process unit, affected facility, or plant site basis.

(i) Pump type (e.g., piston, horizontal or vertical centrifugal, gear, bellows); pump manufacturer; seal type and manufacturer; pump design (e.g., external shaft, flanged body); materials of construction; if applicable, barrier fluid or packing material; and year installed.

(ii) Service characteristics of the stream such as discharge pressure, temperature, flow rate, corrosivity, and annual operating hours.

(iii) The maximum instrument readings observed in each monitoring observation before repair, response factor for the stream if appropriate, instrument model number, and date of the observation.

(iv) If a leak is detected, the repair methods used and the instrument readings after repair.

(v) If the data will be analyzed as part of a larger analysis program involving data from other plants or other types of process units or affected facilities, a description of any maintenance or quality assurance programs used in the process unit or affected facility that are intended to improve emission performance.

(3) The owner or operator shall continue to collect data on the pumps as long as the process unit or affected facility (or plant site) remains in the quality improvement program.

(4) *Pump or pump seal inspection.* The owner or operator shall inspect all pumps or pump seals that exhibited frequent seal failures and were removed from the process unit or affected facility due to leaks. The inspection shall determine the probable cause of the pump seal failure or of the pump leak and shall include recommendations, as appropriate, for design changes or changes in specifications to reduce leak potential.

(5)(i) *Data analysis.* The owner or operator shall analyze the data collected to comply with the requirements of paragraph (d)(2) of this section to determine the services, operating or maintenance practices, and pump or pump seal designs or technologies that have poorer than average emission performance and those that have better than average emission performance. The analysis shall determine if specific trouble areas can be identified on the basis of service, operating conditions or maintenance practices, equipment design, or other process-specific factors.

(ii) The analysis shall also be used to determine if there are superior performing pump or pump seal technologies that are applicable to the service(s), operating conditions, or pump or pump seal designs associated with poorer than average emission performance. A superior performing pump or pump seal technology is one with a leak frequency of less than 10 percent for specific applications in the process unit, affected facility, or plant site. A candidate superior performing pump or pump seal technology is one demonstrated or reported in the available literature or through a group study as having low emission performance and as being capable of achieving less than 10 percent leaking pumps in the process unit or affected facility (or plant site).

(iii) The analysis shall include consideration of the information specified in paragraphs (d)(5)(iii)(A) through (d)(5)(iii)(C) of this section.

(A) The data obtained from the inspections of pumps and pump seals removed from the process unit or affected facility due to leaks;

(B) Information from the available literature and from the experience of other plant sites that will identify pump designs or technologies and operating conditions associated with low emission performance for specific services; and

(C) Information on limitations on the service conditions for the pump seal technology operating conditions as well as information on maintenance procedures to ensure continued low emission performance.

(iv) The data analysis may be conducted through an inter- or intra-company program (or through some combination of the two approaches) and may be for a single process unit, a plant site, a company, or a group of process units.

(v) The first analysis of the data shall be completed no later than 18 months after the start of the quality improvement program. The first analysis shall be performed using data collected for a minimum of 6 months. An analysis of the data shall be done each year the process unit or affected facility is in the quality improvement program.

(6) *Trial evaluation program.* A trial evaluation program shall be conducted at each plant site for which the data analysis does not identify use of superior performing pump seal technology or pumps that can be applied to the areas identified as having poorer than average performance, except as provided in paragraph (d)(6)(v) of this section. The trial program shall be used to evaluate the feasibility of using in the process unit or affected facility (or plant site) the pump designs or seal technologies, and operating and maintenance practices that have been identified by others as having low emission performance.

(i) The trial evaluation program shall include on-line trials of pump seal technologies or pump designs and operating and maintenance practices that have been identified in the available literature or in analysis by others as having the ability to perform with leak rates below 10 percent in similar services, as having low probability of failure, or as having no external actuating mechanism in contact with the process fluid. If any of the candidate superior performing pump seal technologies or pumps is not included in the performance trials, the reasons for rejecting specific technologies from consideration shall be documented as required in paragraph (e)(3)(ii) of this section.

(ii) The number of pump seal technologies or pumps in the trial evaluation program shall be the lesser of 1 percent or two pumps for programs involving single process units or affected facilities and the lesser of 1 percent or five pumps for programs involving a plant site or groups of process units or affected facilities. The minimum number of pumps or pump seal technologies in a trial program shall be one.

(iii) The trial evaluation program shall specify and include documentation of the information specified in paragraphs (d)(6)(iii)(A) through (d)(6)(iii)(D) of this section.

(A) The candidate superior performing pump seal designs or technologies to be evaluated, the stages for evaluating the identified candidate pump designs or pump seal technologies, including the time period necessary to test the applicability;

(B) The frequency of monitoring or inspection of the equipment;

(C) The range of operating conditions over which the component will be evaluated; and

(D) Conclusions regarding the emission performance and the appropriate operating conditions and services for the trial pump seal technologies or pumps.

(iv) The performance trials shall initially be conducted, at least, for a 6-month period beginning not later than 18 months after the start of the quality improvement program. No later than 24 months after the start of the quality improvement program, the owner or operator shall have identified pump seal technologies or pump designs that, combined with appropriate process, operating, and maintenance practices, operate with low emission performance for specific applications in the process unit or affected facility. The owner or operator shall continue to conduct performance trials as long as no superior performing design or technology has been identified, except as provided in paragraph (d)(6)(vi) of this section. The initial list of superior emission performance pump designs or pump seal technologies shall be amended in the future, as appropriate, as additional information and experience are obtained.

(v) Any plant site with fewer than 400 valves and owned by a corporation with fewer than 100 employees shall be exempt from trial evaluations of pump seals or pump designs. Plant sites exempt from the trial evaluations of pumps shall begin the pump seal or pump replacement program at the start of the fourth year of the quality improvement program.

(vi) An owner or operator who has conducted performance trials on all alternative superior emission performance technologies suitable for the required applications in the process unit or affected facility may stop conducting performance trials provided that a superior performing design or technology has been demonstrated or there are no technically feasible alternative superior technologies remaining. The owner or operator shall prepare an engineering evaluation documenting the physical, chemical, or engineering basis for the judgment that the superior emission performance technology is technically infeasible or demonstrating that it would not reduce emissions.

(7) *Quality assurance program.* Each owner or operator shall prepare and implement a pump quality assurance program that details purchasing specifications and maintenance procedures for all pumps and pump seals in the process unit or affected facility. The quality assurance program may establish any number of categories, or classes, of pumps as needed to distinguish among operating conditions and services associated with poorer than average emission performance as well as those associated with better than average emission performance. The quality assurance program shall be developed considering the findings of the data analysis required under paragraph (d)(5) of this section; and, if applicable, the findings of the trial evaluation required in paragraph (d)(6) of this section; and the operating conditions in the process unit or affected facility. The quality assurance program shall be updated each year as long as the process unit or affected facility has the greater of either 10 percent or more leaking pumps or has three leaking pumps.

(i) The quality assurance program shall meet the requirements specified in paragraphs (d)(7)(i)(A) through (d)(7)(i)(D) of this section.

(A) Establish minimum design standards for each category of pumps or pump seal technology. The design standards shall specify known critical parameters such as tolerance, manufacturer, materials of construction, previous usage, or other applicable identified critical parameters;

(B) Require that all equipment orders specify the design standard (or minimum tolerances) for the pump or the pump seal;

(C) Provide for an audit procedure for quality control of purchased equipment to ensure conformance with purchase specifications. The audit program may be conducted by the owner or

operator of the plant site or process unit or affected facility, or by a designated representative; and

(D) Detail off-line pump maintenance and repair procedures. These procedures shall include provisions to ensure that rebuilt or refurbished pumps and pump seals will meet the design specifications for the pump category and will operate so that emissions are minimized.

(ii) The quality assurance program shall be established no later than the start of the third year of the quality improvement program for plant sites with 400 or more valves or 100 or more employees; and no later than the start of the fourth year of the quality improvement program for plant sites with less than 400 valves and less than 100 employees.

(8) *Pump or pump seal replacement.* Three years after the start of the quality improvement program for plant sites with 400 or more valves or 100 or more employees and at the start of the fourth year of the quality improvement program for plant sites with less than 400 valves and less than 100 employees, the owner or operator shall replace, as described in paragraphs (d)(8)(i) and (d)(8)(ii) of this section, the pumps or pump seals that are not superior emission performance technology with pumps or pump seals that have been identified as superior emission performance technology and that comply with the quality assurance standards for the pump category. Superior emission performance technology is that category or design of pumps or pump seals with emission performance that when combined with appropriate process, operating, and maintenance practices, will result in less than 10 percent leaking pumps for specific applications in the process unit, affected facility, or plant site. Superior emission performance technology includes material or design changes to the existing pump, pump seal, seal support system, installation of multiple mechanical seals or equivalent, or pump replacement.

(i) Pumps or pump seals shall be replaced at the rate of 20 percent per year based on the total number of pumps in light liquid service. The calculated value shall be rounded to the nearest nonzero integer value. The minimum number of pumps or pump seals shall be one. Pump replacement shall continue until all pumps subject to the requirements of §63.1026 are pumps determined to be superior performance technology.

(ii) The owner or operator may delay replacement of pump seals or pumps with superior technology until the next planned process unit or affected facility shutdown, provided the number of pump seals and pumps replaced is equivalent to the 20 percent or greater annual replacement rate.

(iii) The pumps shall be maintained as specified in the quality assurance program.

(e) *QIP recordkeeping.* In addition to the records required by paragraph (d)(2) of this section, the owner or operator shall maintain records for the period of the quality improvement program for the process unit or affected facility as specified in paragraphs (e)(1) through (e)(6) of this section.

(1) When using a pump quality improvement program as specified in this section, record the information specified in paragraphs (e)(1)(i) through (e)(1)(iii) of this section.

(i) The rolling average percent leaking pumps.

(ii) Documentation of all inspections conducted under the requirements of paragraph (d)(4) of this section, and any recommendations for design or specification changes to reduce leak frequency.

(iii) The beginning and ending dates while meeting the requirements of paragraph (d) of this section.

(2) If a leak is not repaired within 15 calendar days after discovery of the leak, the reason for the delay and the expected date of successful repair.

(3) Records of all analyses required in paragraph (d) of this section. The records will include the information specified in paragraphs (e)(3)(i) through (e)(3)(iv) of this section.

(i) A list identifying areas associated with poorer than average performance and the associated service characteristics of the stream, the operating conditions and maintenance practices.

(ii) The reasons for rejecting specific candidate superior emission performing pump technology from performance trials.

(iii) The list of candidate superior emission performing valve or pump technologies, and documentation of the performance trial program items required under paragraph (d)(6)(iii) of this section.

(iv) The beginning date and duration of performance trials of each candidate superior emission performing technology.

(4) All records documenting the quality assurance program for pumps as specified in paragraph (d)(7) of this section, including records indicating that all pumps replaced or modified during the period of the quality improvement program are in compliance with the quality assurance.

(5) Records documenting compliance with the 20 percent or greater annual replacement rate for pumps as specified in paragraph (d)(8) of this section.

(6) Information and data to show the corporation has fewer than 100 employees, including employees providing professional and technical contracted services.

**§63.1036 Alternative means of emission limitation: Batch processes.**

(a) *General requirement.* As an alternative to complying with the requirements of §§63.1025 through 63.1033 and §63.1035, an owner or operator of a batch process that operates in regulated material service during the calendar year may comply with one of the standards specified in paragraphs (b) and (c) of this section, or the owner or operator may petition for approval of an alternative standard under the provisions of §63.1021(b). The alternative standards of this section provide the options of pressure testing or monitoring the equipment for leaks. The owner or operator may switch among the alternatives provided the change is documented as specified in paragraph (b)(7) of this section.

(b) *Pressure testing of the batch equipment.* The following requirements shall be met if an owner or operator elects to use pressure testing of batch product-process equipment to demonstrate compliance with this subpart.

(1) *Reconfiguration.* Each time equipment is reconfigured for production of a different product or intermediate, the batch product-process equipment train shall be pressure-tested for leaks before regulated material is first fed to the equipment and the equipment is placed in regulated material service.

(i) When the batch product-process equipment train is reconfigured to produce a different product, pressure testing is required only for the new or disturbed equipment.

(ii) Each batch product process that operates in regulated material service during a calendar year shall be pressure-tested at least once during that calendar year.

(iii) Pressure testing is not required for routine seal breaks, such as changing hoses or filters, that are not part of the reconfiguration to produce a different product or intermediate.

(2) *Testing procedures.* The batch product process equipment shall be tested either using the procedures specified in paragraph (b)(5) of this section for pressure vacuum loss or with a liquid using the procedures specified in paragraph (b)(6) of this section.

(3) *Leak detection.* (i) For pressure or vacuum tests using a gas, a leak is detected if the rate of change in pressure is greater than 6.9 kilopascals (1 pound per square inch gauge) in 1 hour or if there is visible, audible, or olfactory evidence of fluid loss.

(ii) For pressure tests using a liquid, a leak is detected if there are indications of liquids dripping or if there is other evidence of fluid loss.

(4) *Leak repair.* (i) If a leak is detected, it shall be repaired and the batch product-process equipment shall be retested before start-up of the process.

(ii) If a batch product-process fails the retest (the second of two consecutive pressure tests), it shall be repaired as soon as practical, but not later than 30 calendar days after the second pressure test except as specified in paragraph (e) of this section.

(5) *Gas pressure test procedure for pressure or vacuum loss.* The procedures specified in paragraphs (b)(5)(i) through (b)(5)(v) of this section shall be used to pressure test batch product-process equipment for pressure or vacuum loss to demonstrate compliance with the requirements of paragraph (b)(3)(i) of this section.

(i) The batch product-process equipment train shall be pressurized with a gas to a pressure less than the set pressure of any safety relief devices or valves or to a pressure slightly above the operating pressure of the equipment, or alternatively the equipment shall be placed under a vacuum.

(ii) Once the test pressure is obtained, the gas source or vacuum source shall be shut off.

(iii) The test shall continue for not less than 15 minutes unless it can be determined in a shorter period of time that the allowable rate of pressure drop or of pressure rise was exceeded. The pressure in the batch product-process equipment shall be measured after the gas or vacuum source is shut off and at the end of the test period. The rate of change in pressure in the batch product-process equipment shall be calculated using the following equation:

$$\Delta(P/t) = \left( |P_f - P_i| \right) / (t_f - t_i) \quad [Eq. 5]$$

Where:

$\Delta(P/t)$  = Change in pressure, pounds per square inch gauge per hour.

$P_f$  = Final pressure, pounds per square inch gauge.

$P_i$  = Initial pressure, pounds per square inch gauge.

$t_f - t_i$  = Elapsed time, hours.

(iv) The pressure shall be measured using a pressure measurement device (gauge, manometer, or equivalent) that has a precision of  $\pm 2.5$  millimeter mercury (0.10 inch of mercury) in the range of test pressure and is capable of measuring pressures up to the relief set pressure of the pressure relief device. If such a pressure measurement device is not reasonably available, the owner or operator shall use a pressure measurement device with a precision of at least  $\pm 10$  percent of the test pressure of the equipment and shall extend the duration of the test for the time necessary to detect a pressure loss or

rise that equals a rate of 1 pound per square inch gauge per hour (7 kilopascals per hour).

(v) An alternative procedure may be used for leak testing the equipment if the owner or operator demonstrates the alternative procedure is capable of detecting a pressure loss or rise.

(6) *Pressure test procedure using test liquid.* The procedures specified in paragraphs (b)(6)(i) through (b)(6)(iv) of this section shall be used to pressure-test batch product-process equipment using a liquid to demonstrate compliance with the requirements of paragraph (b)(3)(ii) of this section.

(i) The batch product-process equipment train, or section of the equipment train, shall be filled with the test liquid (e.g., water, alcohol) until normal operating pressure is obtained. Once the equipment is filled, the liquid source shall be shut off.

(ii) The test shall be conducted for a period of at least 60 minutes, unless it can be determined in a shorter period of time that the test is a failure.

(iii) Each seal in the equipment being tested shall be inspected for indications of liquid dripping or other indications of fluid loss. If there are any indications of liquids dripping or of fluid loss, a leak is detected.

(iv) An alternative procedure may be used for leak testing the equipment, if the owner or operator demonstrates the alternative procedure is capable of detecting losses of fluid.

(7) *Pressure testing recordkeeping.* The owner or operator of a batch product process who elects to pressure test the batch product process equipment train to demonstrate compliance with this subpart shall maintain records of the information specified in paragraphs (b)(7)(i) through (b)(7)(v) of this section.

(i) The identification of each product, or product code, produced during the calendar year. It is not necessary to identify individual items of equipment in a batch product process equipment train.

(ii) Physical tagging of the equipment to identify that it is in regulated material service and subject to the provisions of this subpart is not required. Equipment in a batch product process subject to the provisions of this subpart may be identified on a plant site plan, in log entries, or by other appropriate methods.

(iii) The dates of each pressure test required in paragraph (b) of this section, the test pressure, and the pressure drop observed during the test.

(iv) Records of any visible, audible, or olfactory evidence of fluid loss.

(v) When a batch product process equipment train does not pass two consecutive pressure tests, the information specified in paragraphs (b)(7)(v)(A) through (b)(7)(v)(E) of this section shall be recorded in a log and kept for 2 years:

(A) The date of each pressure test and the date of each leak repair attempt.

(B) Repair methods applied in each attempt to repair the leak.

(C) The reason for the delay of repair.

(D) The expected date for delivery of the replacement equipment and the actual date of delivery of

the replacement equipment; and

(E) The date of successful repair.

(c) *Equipment monitoring.* The following requirements shall be met if an owner or operator elects to monitor the equipment in a batch process to detect leaks by the method specified in §63.1023(b) and, as applicable, §63.1023(c), to demonstrate compliance with this subpart.

(1) The owner or operator shall comply with the requirements of §§63.1025 through 63.1035 as modified by paragraphs (c)(2) through (c)(4) of this section.

(2) The equipment shall be monitored for leaks by the method specified in §63.1023(b) and, as applicable, §63.1023(c), when the equipment is in regulated material service or is in use with any other detectable material.

(3) The equipment shall be monitored for leaks as specified in paragraphs (c)(3)(i) through (c)(3)(iv) of this section.

(i) Each time the equipment is reconfigured for the production of a new product, the reconfigured equipment shall be monitored for leaks within 30 days of start-up of the process. This initial monitoring of reconfigured equipment shall not be included in determining percent leaking equipment in the process unit or affected facility.

(ii) Connectors shall be monitored in accordance with the requirements in §63.1027.

(iii) Equipment other than connectors shall be monitored at the frequencies specified in table 1 to this subpart. The operating time shall be determined as the proportion of the year the batch product-process that is subject to the provisions of this subpart is operating.

(iv) The monitoring frequencies specified in paragraph (c)(3)(iii) of this section are not requirements for monitoring at specific intervals and can be adjusted to accommodate process operations. An owner or operator may monitor anytime during the specified monitoring period (e.g., month, quarter, year), provided the monitoring is conducted at a reasonable interval after completion of the last monitoring campaign. For example, if the equipment is not operating during the scheduled monitoring period, the monitoring can be done during the next period when the process is operating.

(4) If a leak is detected, it shall be repaired as soon as practical but not later than 15 calendar days after it is detected, except as provided in paragraph (e) of this section.

(d) *Added equipment recordkeeping.* (1) For batch product-process units or affected facilities that the owner or operator elects to monitor as provided under paragraph (c) of this section, the owner or operator shall prepare a list of equipment added to batch product process units or affected facilities since the last monitoring period required in paragraphs (c)(3)(ii) and (c)(3)(iii) of this section.

(2) Maintain records demonstrating the proportion of the time during the calendar year the equipment is in use in a batch process that is subject to the provisions of this subpart. Examples of suitable documentation are records of time in use for individual pieces of equipment or average time in use for the process unit or affected facility. These records are not required if the owner or operator does not adjust monitoring frequency by the time in use, as provided in paragraph (c)(3)(iii) of this section.

(3) Record and keep pursuant to the referencing subpart and this subpart, the date and results of the monitoring required in paragraph (c)(3)(i) of this section for equipment added to a batch product-process unit or affected facility since the last monitoring period required in paragraphs (c)(3)(ii) and



(c)(3)(iii) of this section. If no leaking equipment is found during this monitoring, the owner or operator shall record that the inspection was performed. Records of the actual monitoring results are not required.

(e) *Delay of repair.* Delay of repair of equipment for which leaks have been detected is allowed if the replacement equipment is not available providing the conditions specified in paragraphs (e)(1) and (e)(2) of this section are met.

(1) Equipment supplies have been depleted and supplies had been sufficiently stocked before the supplies were depleted.

(2) The repair is made no later than 10 calendar days after delivery of the replacement equipment.

(f) *Periodic report contents.* For owners or operators electing to meet the requirements of paragraph (b) of this section, the Periodic Report to be filed pursuant to §63.1039(b) shall include the information listed in paragraphs (f)(1) through (f)(4) of this section for each process unit.

(1) Batch product process equipment train identification;

(2) The number of pressure tests conducted;

(3) The number of pressure tests where the equipment train failed the pressure test; and

(4) The facts that explain any delay of repairs.

**§63.1037 Alternative means of emission limitation: Enclosed-vented process units or affected facilities.**

(a) *Use of closed vent system and control device.* Process units or affected facilities or portions of process units at affected facilities enclosed in such a manner that all emissions from equipment leaks are vented through a closed vent system to a control device or routed to a fuel gas system or process meeting the requirements of §63.1034 are exempt from the requirements of §§63.1025 through 63.1033 and 63.1035. The enclosure shall be maintained under a negative pressure at all times while the process unit or affected facility is in operation to ensure that all emissions are routed to a control device.

(b) *Recordkeeping.* Owners and operators choosing to comply with the requirements of this section shall maintain the records specified in paragraphs (b)(1) through (b)(3) of this section.

(1) Identification of the process unit(s) or affected facilities and the regulated materials they handle.

(2) A schematic of the process unit or affected facility, enclosure, and closed vent system.

(3) A description of the system used to create a negative pressure in the enclosure to ensure that all emissions are routed to the control device.

**§63.1038 Recordkeeping requirements.**

(a) *Recordkeeping system.* An owner or operator of more than one regulated source subject to the provisions of this subpart may comply with the recordkeeping requirements for these regulated sources in one recordkeeping system. The recordkeeping system shall identify each record by regulated source and the type of program being implemented (e.g., quarterly monitoring, quality improvement) for each type of equipment. The records required by this subpart are summarized in paragraphs (b) and (c) of this section.

(b) *General equipment leak records.* (1) As specified in §63.1022(a) and (b), the owner or operator shall keep general and specific equipment identification if the equipment is not physically tagged and the owner or operator is electing to identify the equipment subject to this subpart through written documentation such as a log or other designation.

(2) The owner or operator shall keep a written plan as specified in §63.1022(c)(4) for any equipment that is designated as unsafe- or difficult-to-monitor.

(3) The owner or operator shall maintain a record of the identity and an explanation as specified in §63.1022(d)(2) for any equipment that is designated as unsafe-to-repair.

(4) As specified in §63.1022(e), the owner or operator shall maintain the identity of compressors operating with an instrument reading of less than 500 parts per million.

(5) The owner or operator shall keep records associated with the determination that equipment is in heavy liquid service as specified in §63.1022(f).

(6) The owner or operator shall keep records for leaking equipment as specified in §63.1023(e)(2).

(7) The owner or operator shall keep records for leak repair as specified in §63.1024(f) and records for delay of repair as specified in §63.1024(d).

(c) *Specific equipment leak records.* (1) For valves, the owner or operator shall maintain the records specified in paragraphs (c)(1)(i) and (c)(1)(ii) of this section.

(i) The monitoring schedule for each process unit as specified in §63.1025(b)(3)(vi).

(ii) The valve subgrouping records specified in §63.1025(b)(4)(iv), if applicable.

(2) For pumps, the owner or operator shall maintain the records specified in paragraphs (c)(2)(i) through (c)(2)(iii) of this section.

(i) Documentation of pump visual inspections as specified in §63.1026(b)(4).

(ii) Documentation of dual mechanical seal pump visual inspections as specified in §63.1026(e)(1)(v).

(iii) For the criteria as to the presence and frequency of drips for dual mechanical seal pumps, records of the design criteria and explanations and any changes and the reason for the changes, as specified in §63.1026(e)(1)(i).

(3) For connectors, the owner or operator shall maintain the monitoring schedule for each process unit as specified in §63.1027(b)(3)(v).

(4) For agitators, the owner or operator shall maintain the following records:

(i) Documentation of agitator seal visual inspections as specified in §63.1028; and

(ii) For the criteria as to the presence and frequency of drips for agitators, the owner or operator shall keep records of the design criteria and explanations and any changes and the reason for the changes, as specified in §63.1028(e)(1)(vi).

(5) For pressure relief devices in gas and vapor or light liquid service, the owner or operator shall keep records of the dates and results of monitoring following a pressure release, as specified in §63.1030(c)(3).

(6) For compressors, the owner or operator shall maintain the records specified in paragraphs (c)(6)(i) and (c)(6)(ii) of this section.

(i) For criteria as to failure of the seal system and/or the barrier fluid system, record the design criteria and explanations and any changes and the reason for the changes, as specified in §63.1031(d)(2).

(ii) For compressors operating under the alternative compressor standard, record the dates and results of each compliance test as specified in §63.1031(f)(2).

(7) For a pump QIP program, the owner or operator shall maintain the records specified in paragraphs (c)(7)(i) through (c)(7)(v) of this section.

(i) Individual pump records as specified in §63.1035(d)(2).

(ii) Trial evaluation program documentation as specified in §63.1035(d)(6)(iii).

(iii) Engineering evaluation documenting the basis for judgement that superior emission performance technology is not applicable as specified in §63.1035(d)(6)(vi).

(iv) Quality assurance program documentation as specified in §63.1035(d)(7).

(v) QIP records as specified in §63.1035(e).

(8) For process units complying with the batch process unit alternative, the owner or operator shall maintain the records specified in paragraphs (c)(8)(i) and (c)(8)(ii) of this section.

(i) Pressure test records as specified in §63.1036(b)(7).

(ii) Records for equipment added to the process unit as specified in §63.1036(d).

(9) For process units complying with the enclosed-vented process unit alternative, the owner or operator shall maintain the records for enclosed-vented process units as specified in §63.1037(b).

### **§63.1039 Reporting requirements.**

(a) *Initial Compliance Status Report.* Each owner or operator shall submit an Initial Compliance Status Report according to the procedures in the referencing subpart. The notification shall include the information listed in paragraphs (a)(1) through (a)(3) of this section, as applicable.

(1) The notification shall provide the information listed in paragraphs (a)(1)(i) through (a)(1)(iv) of this section for each process unit or affected facility subject to the requirements of this subpart.

(i) Process unit or affected facility identification.

(ii) Number of each equipment type (e.g., valves, pumps) excluding equipment in vacuum service.

(iii) Method of compliance with the standard (e.g., “monthly leak detection and repair” or “equipped with dual mechanical seals”).

(iv) Planned schedule for requirements in §§63.1025 and 63.1026.

(2) The notification shall provide the information listed in paragraphs (a)(2)(i) and (a)(2)(ii) of this section for each process unit or affected facility subject to the requirements of §63.1036(b).

(i) Batch products or product codes subject to the provisions of this subpart, and

(ii) Planned schedule for pressure testing when equipment is configured for production of products subject to the provisions of this subpart.

(3) The notification shall provide the information listed in paragraphs (a)(3)(i) and (a)(3)(ii) of this section for each process unit or affected facility subject to the requirements in §63.1037.

(i) Process unit or affected facility identification.

(ii) A description of the system used to create a negative pressure in the enclosure and the control device used to comply with the requirements of §63.1034 of this part.

(b) *Periodic Reports.* The owner or operator shall report the information specified in paragraphs (b)(1) through (b)(8) of this section, as applicable, in the Periodic Report specified in the referencing subpart.

(1) For the equipment specified in paragraphs (b)(1)(i) through (b)(1)(v) of this section, report in a summary format by equipment type, the number of components for which leaks were detected and for valves, pumps and connectors show the percent leakers, and the total number of components monitored. Also include the number of leaking components that were not repaired as required by §63.1024, and for valves and connectors, identify the number of components that are determined by §63.1025(c)(3) to be nonrepairable.

(i) Valves in gas and vapor service and in light liquid service pursuant to §63.1025(b) and (c).

(ii) Pumps in light liquid service pursuant to §63.1026(b) and (c).

(iii) Connectors in gas and vapor service and in light liquid service pursuant to §63.1027(b) and (c).

(iv) Agitators in gas and vapor service and in light liquid service pursuant to §63.1028(c).

(v) Compressors pursuant to §63.1031(d).

(2) Where any delay of repair is utilized pursuant to §63.1024(d), report that delay of repair has occurred and report the number of instances of delay of repair.

(3) If applicable, report the valve subgrouping information specified in §63.1025(b)(4)(iv).

(4) For pressure relief devices in gas and vapor service pursuant to §63.1030(b) and for compressors pursuant to §63.1031(f) that are to be operated at a leak detection instrument reading of less than 500 parts per million, report the results of all monitoring to show compliance conducted within the semiannual reporting period.

(5) Report, if applicable, the initiation of a monthly monitoring program for valves pursuant to §63.1025(b)(3)(i).

(6) Report, if applicable, the initiation of a quality improvement program for pumps pursuant to §63.1035.

(7) Where the alternative means of emissions limitation for batch processes is utilized, report the information listed in §63.1036(f).

(8) Report the information listed in paragraph (a) of this section for the Initial Compliance Status Report for process units or affected facilities with later compliance dates. Report any revisions to items reported in an earlier Initial Compliance Status Report if the method of compliance has changed since the last report.

**Table 1 to Subpart UU of Part 63—Batch Processes Monitoring Frequency For Equipment Other Than Connectors**

| <b>Operating time<br/>(% of year)</b> | <b>Equivalent continuous process monitoring frequency time in use</b> |                  |                     |
|---------------------------------------|---|------------------|---------------------|
|                                       | <b>Monthly</b>  | <b>Quarterly</b> | <b>Semiannually</b> |
| 0 to <25%                             | Quarterly   | Annually         | Annually.           |
| 25 to <50%                            | Quarterly   | Semiannually     | Annually.           |
| 50 to <75%                            | Bimonthly   | Three times      | Semiannually.       |
| 75 to 100%                            | Monthly   | Quarterly        | Semiannually.       |

**Appendix I**  
40 C.F.R. Part 63, Subpart WW – *National Emission Standards for Storage Vessels (Tanks)-  
Control Level 2*

## Subpart WW—National Emission Standards for Storage Vessels (Tanks)—Control Level 2

SOURCE: 64 FR 34918, June 29, 1999, unless otherwise noted.

### §63.1060 Applicability.

The provisions of this subpart apply to the control of air emissions from storage vessels for which another subpart references the use of this subpart for such air emission control. These air emission standards for storage vessels are placed here for administrative convenience and only apply to those owners and operators of facilities subject to a referencing subpart. The provisions of subpart A (General Provisions) of this part do not apply to this subpart except as noted in the referencing subpart.

### §63.1061 Definitions.

All terms used in this subpart shall have the meaning given them in the Act and in this section.

*Capacity* means the volume of liquid that is capable of being stored in a vessel, determined by multiplying the vessel's internal cross-sectional area by the internal height of the shell.

*Deck cover* means a device which covers an opening in a floating roof deck. Some deck covers move horizontally relative to the deck (i.e., a sliding cover).

*Empty* or *emptying* means the partial or complete removal of stored liquid from a storage vessel. Storage vessels that contain liquid only as wall or bottom clingage, or in pools due to bottom irregularities, are considered completely empty.

*External floating roof* or *EFR* means a floating roof located in a storage vessel without a fixed roof.

*Fill* or *filling* means the introduction of liquid into a storage vessel, but not necessarily to capacity.

*Fixed roof* means a roof that is mounted (i.e., permanently affixed) on a storage vessel and that does not move with fluctuations in stored liquid level.

*Flexible fabric sleeve seal* means a seal made of an elastomeric fabric (or other material) which covers an opening in a floating roof deck, and which allows the penetration of a fixed roof support column. The seal is attached to the rim of the deck opening and extends to the outer surface of the column. The seal is draped (but does not contact the stored liquid) to allow the horizontal movement of the deck relative to the column.

*Floating roof* means a roof that floats on the surface of the liquid in a storage vessel. A floating roof substantially covers the stored liquid surface (but is not necessarily in contact with the entire surface), and is comprised of a deck, a rim seal, and miscellaneous deck fittings.

*Initial fill* or *initial filling* means the first introduction of liquid into a storage vessel that is either newly constructed or has not been in liquid service for a year or longer.

*Internal floating roof* or *IFR* means a floating roof located in a storage vessel with a fixed roof. For

the purposes of this subpart, an external floating roof located in a storage vessel to which a fixed roof has been added is considered to be an internal floating roof.

*Liquid-mounted seal* means a resilient or liquid-filled rim seal designed to contact the stored liquid.

*Mechanical shoe seal or metallic shoe seal* means a rim seal consisting of a band of metal (or other suitable material) as the sliding contact with the wall of the storage vessel, and a fabric seal to close the annular space between the band and the rim of the floating roof deck. The band is typically formed as a series of sheets (shoes) that are overlapped or joined together to form a ring. The lower end of the band extends into the stored liquid.

*Pole float* means a float located inside a guidepole that floats on the surface of the stored liquid. The rim of the float has a wiper or seal that extends to the inner surface of the pole.

*Pole sleeve* means a device which extends from either the cover or the rim of an opening in a floating roof deck to the outer surface of a pole that passes through the opening. The sleeve extends into the stored liquid.

*Pole wiper* means a seal that extends from either the cover or the rim of an opening in a floating roof deck to the outer surface of a pole that passes through the opening.

*Referencing subpart* means the subpart that refers an owner or operator to this subpart.

*Rim seal* means a device attached to the rim of a floating roof deck that spans the annular space between the deck and the wall of the storage vessel. When a floating roof has only one such device, it is a primary seal; when there are two seals (one mounted above the other), the lower seal is the primary seal and the upper seal is the secondary seal.

*Slotted guidepole* means a guidepole or gaugepole that has slots or holes through the wall of the pole. The slots or holes allow the stored liquid to flow into the pole at liquid levels above the lowest operating level.

*Storage vessel or Tank* means a stationary unit that is constructed primarily of nonearthen materials (such as wood, concrete, steel, fiberglass, or plastic) which provide structural support and is designed to hold an accumulation of liquids or other materials.

*Vapor-mounted seal* means a rim seal designed not to be in contact with the stored liquid. Vapor-mounted seals may include, but are not limited to, resilient seals and flexible wiper seals.

### **§63.1062 Storage vessel control requirements.**

(a) For each storage vessel to which this subpart applies, the owner or operator shall comply with one of the requirements listed in paragraphs (a)(1) through (a)(3) of this section.

(1) Operate and maintain an IFR.

(2) Operate and maintain an EFR.

(3) *Equivalent requirements.* Comply with an equivalent to the requirements in paragraph (a)(1) or (a)(2) of this section, as provided in §63.1064.



(b) [Reserved]

### **§63.1063 Floating roof requirements.**

The owner or operator who elects to use a floating roof to comply with the requirements of §63.1062 shall comply with the requirements in paragraphs (a) through (e) of this section.

(a) *Design requirements*—(1) *Rim seals.* (i) *Internal floating roof.* An IFR shall be equipped with one of the seal configurations listed in paragraphs (a)(1)(i)(A) through (a)(1)(i)(C) of this section.

(A) A liquid-mounted seal.

(B) A mechanical shoe seal.

(C) Two seals mounted one above the other. The lower seal may be vapor-mounted.

(D) If the IFR is equipped with a vapor-mounted seal as of the proposal date for a referencing subpart, paragraphs (a)(1)(i)(A) through (a)(1)(i)(C) of this section do not apply until the next time the storage vessel is completely emptied and degassed, or 10 years after promulgation of the referencing subpart, whichever occurs first.

(ii) *External floating roof.* An EFR shall be equipped with one of the seal configurations listed in paragraphs (a)(1)(ii)(A) and (a)(1)(ii)(B) of this section.

(A) A liquid-mounted seal and a secondary seal.

(B) A mechanical shoe seal and a secondary seal. The upper end of the shoe(s) shall extend a minimum of 61 centimeters (24 inches) above the stored liquid surface.

(C) If the EFR is equipped with a liquid-mounted seal or mechanical shoe seal, or a vapor-mounted seal and secondary seal, as of the proposal date for a referencing subpart, the seal options specified in paragraphs (a)(1)(ii)(A) and (a)(1)(ii)(B) of this section do not apply until the next time the storage vessel is completely emptied and degassed, or 10 years after the promulgation date of the referencing subpart, whichever occurs first.

(2) *Deck fittings.* Openings through the deck of the floating roof shall be equipped as described in paragraphs (a)(2)(i) through (a)(2)(viii) of this section.

(i) Each opening except those for automatic bleeder vents (vacuum breaker vents) and rim space vents shall have its lower edge below the surface of the stored liquid.

(ii) Each opening except those for automatic bleeder vents (vacuum breaker vents), rim space vents, leg sleeves, and deck drains shall be equipped with a deck cover. The deck cover shall be equipped with a gasket between the cover and the deck.

(iii) Each automatic bleeder vent (vacuum breaker vent) and rim space vent shall be equipped with a gasketed lid, pallet, flapper, or other closure device.

(iv) Each opening for a fixed roof support column may be equipped with a flexible fabric sleeve seal instead of a deck cover.

(v) Each opening for a sample well or deck drain (that empties into the stored liquid) may be

equipped with a slit fabric seal or similar device that covers at least 90 percent of the opening, instead of a deck cover.

(vi) Each cover on access hatches and gauge float wells shall be designed to be bolted or fastened when closed.

(vii) Each opening for an unslotted guidepole shall be equipped with a pole wiper, and each unslotted guidepole shall be equipped with a gasketed cap on the top of the guidepole.

(viii) Each opening for a slotted guidepole shall be equipped with one of the control device configurations specified in paragraphs (a)(2)(viii)(A) and (a)(2)(viii)(B) of this section.

(A) A pole wiper and a pole float. The wiper or seal of the pole float shall be at or above the height of the pole wiper.

(B) A pole wiper and a pole sleeve.

(ix) If the floating roof does not meet the requirements listed in paragraphs (a)(2)(i) through (a)(2)(viii) of this section as of the proposal date of the referencing subpart, these requirements do not apply until the next time the vessel is completely emptied and degassed, or 10 years after the promulgation date of the referencing subpart, whichever occurs first.

(b) *Operational requirements.* (1) The floating roof shall float on the stored liquid surface at all times, except when the floating roof is supported by its leg supports or other support devices (e.g., hangers from the fixed roof).

(2) When the storage vessel is storing liquid, but the liquid depth is insufficient to float the floating roof, the process of filling to the point of refloating the floating roof shall be continuous and shall be performed as soon as practical.

(3) Each cover over an opening in the floating roof, except for automatic bleeder vents (vacuum breaker vents) and rim space vents, shall be closed at all times, except when the cover must be open for access.

(4) Each automatic bleeder vent (vacuum breaker vent) and rim space vent shall be closed at all times, except when required to be open to relieve excess pressure or vacuum, in accordance with the manufacturer's design.

(5) Each unslotted guidepole cap shall be closed at all times except when gauging the liquid level or taking liquid samples.

(c) *Inspection frequency requirements—(1) Internal floating roofs.* Internal floating roofs shall be inspected as specified in paragraph (d)(1) of this section before the initial filling of the storage vessel. Subsequent inspections shall be performed as specified in paragraph (c)(1)(i) or (c)(1)(ii) of this section.

(i) Internal floating roofs shall be inspected as specified in paragraphs (c)(1)(i)(A) and (c)(1)(i)(B) of this section.

(A) At least once per year the IFR shall be inspected as specified in paragraph (d)(2) of this section.

(B) Each time the storage vessel is completely emptied and degassed, or every 10 years, whichever

occurs first, the IFR shall be inspected as specified in paragraph (d)(1) of this section.

(ii) Instead of the inspection frequency specified in paragraph (c)(1)(i) of this section, internal floating roofs with two rim seals may be inspected as specified in paragraph (d)(1) of this section each time the storage vessel is completely emptied and degassed, or every 5 years, whichever occurs first.

(2) *External floating roofs.* External floating roofs shall be inspected as specified in paragraphs (c)(2)(i) through (c)(2)(iv) of this section.

(i) Within 90 days after the initial filling of the storage vessel, the primary and secondary rim seals shall be inspected as specified in paragraph (d)(3) of this section.

(ii) The secondary seal shall be inspected at least once every year, and the primary seal shall be inspected at least every 5 years, as specified in paragraph (d)(3) of this section.

(iii) Each time the storage vessel is completely emptied and degassed, or every 10 years, whichever occurs first, the EFR shall be inspected as specified in paragraph (d)(1) of this section.

(iv) If the owner or operator determines that it is unsafe to perform the floating roof inspections specified in paragraphs (c)(2)(i) and (c)(2)(ii) of this section, the owner or operator shall comply with the requirements of paragraph (c)(2)(iv)(A) or (c)(2)(iv)(B) of this section.

(A) The inspections shall be performed no later than 30 days after the determination that the floating roof is unsafe.

(B) The storage vessel shall be removed from liquid service no later than 45 days after determining the floating roof is unsafe. If the vessel cannot be emptied within 45 days, the owner or operator may utilize up to two extensions of up to 30 additional days each. If the vessel cannot be emptied within 45 days, the owner or operator may utilize up to two extensions of up to 30 additional days each. Documentation of a decision to use an extension shall include an explanation of why it was unsafe to perform the inspection, documentation that alternative storage capacity is unavailable, and a schedule of actions that will ensure that the vessel will be emptied as soon as practical.

(d) *Inspection procedure requirements.* Floating roof inspections shall be conducted as specified in paragraphs (d)(1) through (d)(3) of this section, as applicable. If a floating roof fails an inspection, the owner or operator shall comply with the repair requirements of paragraph (e) of this section.

(1) Floating roof (IFR and EFR) inspections shall be conducted by visually inspecting the floating roof deck, deck fittings, and rim seals from within the storage vessel. The inspection may be performed entirely from the top side of the floating roof, as long as there is visual access to all deck components specified in paragraph (a) of this section. Any of the conditions described in paragraphs (d)(1)(i) through (d)(1)(v) of this section constitutes inspection failure.

(i) Stored liquid on the floating roof.

(ii) Holes or tears in the primary or secondary seal (if one is present).

(iii) Floating roof deck, deck fittings, or rim seals that are not functioning as designed (as specified in paragraph (a) of this section).

(iv) Failure to comply with the operational requirements of paragraph (b) of this section.

(v) Gaps of more than 0.32 centimeters ( $\frac{1}{8}$  inch) between any deck fitting gasket, seal, or wiper (required by paragraph (a) of this section) and any surface that it is intended to seal.

(2) Tank-top inspections of IFR's shall be conducted by visually inspecting the floating roof deck, deck fittings, and rim seal through openings in the fixed roof. Any of the conditions described in paragraphs (d)(1)(i) through (d)(1)(iv) of this section constitutes inspection failure. Identification of holes or tears in the rim seal is required only for the seal that is visible from the top of the storage vessel.

(3) Seal gap inspections for EFR's shall determine the presence and size of gaps between the rim seals and the wall of the storage vessel by the procedures specified in paragraph (d)(3)(i) of this section. Any exceedance of the gap requirements specified in paragraphs (d)(3)(ii) and (d)(3)(iii) of this section constitutes inspection failure.

(i) Rim seals shall be measured for gaps at one or more levels while the EFR is floating, as specified in paragraphs (d)(3)(i)(A) through (d)(3)(i)(F) of this section.

(A) The inspector shall hold a 0.32 centimeter ( $\frac{1}{8}$  inch) diameter probe vertically against the inside of the storage vessel wall, just above the rim seal, and attempt to slide the probe down between the seal and the vessel wall. Each location where the probe passes freely (without forcing or binding against the seal) between the seal and the vessel wall constitutes a gap.

(B) The length of each gap shall be determined by inserting the probe into the gap (vertically) and sliding the probe along the vessel wall in each direction as far as it will travel freely without binding between the seal and the vessel wall. The circumferential length along which the probe can move freely is the gap length.

(C) The maximum width of each gap shall be determined by inserting probes of various diameters between the seal and the vessel wall. The smallest probe diameter should be 0.32 centimeter, and larger probes should have diameters in increments of 0.32 centimeter. The diameter of the largest probe that can be inserted freely anywhere along the length of the gap is the maximum gap width.

(D) The average width of each gap shall be determined by averaging the minimum gap width (0.32 centimeter) and the maximum gap width.

(E) The area of a gap is the product of the gap length and average gap width.

(F) The ratio of accumulated area of rim seal gaps to storage vessel diameter shall be determined by adding the area of each gap, and dividing the sum by the nominal diameter of the storage vessel. This ratio shall be determined separately for primary and secondary rim seals.

(ii) The ratio of seal gap area to vessel diameter for the primary seal shall not exceed 212 square centimeters per meter of vessel diameter (10 square inches per foot of vessel diameter), and the maximum gap width shall not exceed 3.81 centimeters (1.5 inches).

(iii) The ratio of seal gap area to vessel diameter for the secondary seal shall not exceed 21.2 square centimeters per meter (1 square inch per foot), and the maximum gap width shall not exceed 1.27 centimeters (0.5 inches), except when the secondary seal must be pulled back or removed to inspect the primary seal.

(e) *Repair requirements.* Conditions causing inspection failures under paragraph (d) of this section shall be repaired as specified in paragraph (e)(1) or (e)(2) of this section.

(1) If the inspection is performed while the storage vessel is not storing liquid, repairs shall be

completed before the refilling of the storage vessel with liquid.

(2) If the inspection is performed while the storage vessel is storing liquid, repairs shall be completed or the vessel removed from service within 45 days. If a repair cannot be completed and the vessel cannot be emptied within 45 days, the owner or operator may use up to 2 extensions of up to 30 additional days each. Documentation of a decision to use an extension shall include a description of the failure, shall document that alternate storage capacity is unavailable, and shall specify a schedule of actions that will ensure that the control equipment will be repaired or the vessel will be completely emptied as soon as practical.

#### **§63.1064 Alternative means of emission limitation.**

(a) An alternate control device may be substituted for a control device specified in §63.1063 if the alternate device has an emission factor less than or equal to the emission factor for the device specified in §63.1063. Requests for the use of alternate devices shall be made as specified in §63.1066(b)(3). Emission factors for the devices specified in §63.1063 are published in EPA Report No. AP-42, Compilation of Air Pollutant Emission Factors.

(b) Tests to determine emission factors for an alternate device shall accurately simulate conditions under which the device will operate, such as wind, temperature, and barometric pressure. Test methods that can be used to perform the testing required in this paragraph include, but are not limited to, the methods listed in paragraphs (b)(1) through (b)(3) of this section.

(1) American Petroleum Institute (API) Manual of Petroleum Measurement Standards, Chapter 19, Section 3, Part A, Wind Tunnel Test Method for the Measurement of Deck-Fitting Loss Factors for External Floating-Roof Tanks.

(2) API Manual of Petroleum Measurement Standards, Chapter 19, Section 3, Part B, Air Concentration Test Method for the Measurement of Rim Seal Loss Factors for Floating-Roof Tanks.

(3) API Manual of Petroleum Measurement Standards, Chapter 19, Section 3, Part E, Weight Loss Test Method for the Measurement of Deck-Fitting Loss Factors for Internal Floating-Roof Tanks.

(c) An alternate combination of control devices may be substituted for any combination of rim seal and deck fitting control devices specified in §63.1063 if the alternate combination emits no more than the combination specified in §63.1063. The emissions from an alternate combination of control devices shall be determined using AP-42 or as specified in paragraph (b) of this section. The emissions from a combination of control devices specified in §63.1063 shall be determined using AP-42. Requests for the use of alternate devices shall be made as specified in §63.1066(b)(3).

#### **§63.1065 Recordkeeping requirements.**

The owner or operator shall keep the records required in paragraph (a) of this section for as long as liquid is stored. Records required in paragraphs (b), (c) and (d) of this section shall be kept for at least 5 years. Records shall be kept in such a manner that they can be readily accessed within 24 hours. Records may be kept in hard copy or computer-readable form including, but not limited to, on paper, microfilm, computer, floppy disk, magnetic tape, or microfiche.

(a) *Vessel dimensions and capacity.* A record shall be kept of the dimensions of the storage vessel, an analysis of the capacity of the storage vessel, and an identification of the liquid stored.

(b) *Inspection results.* Records of floating roof inspection results shall be kept as specified in

paragraphs (b)(1) and (b)(2) of this section.

(1) If the floating roof passes inspection, a record shall be kept that includes the information specified in paragraphs (b)(1)(i) and (b)(1)(ii) of this section. If the floating roof fails inspection, a record shall be kept that includes the information specified in paragraphs (b)(1)(i) through (b)(1)(v) of this section.

- (i) Identification of the storage vessel that was inspected.
- (ii) The date of the inspection.
- (iii) A description of all inspection failures.
- (iv) A description of all repairs and the dates they were made.
- (v) The date the storage vessel was removed from service, if applicable.

(2) A record shall be kept of EFR seal gap measurements, including the raw data obtained and any calculations performed.

(c) *Floating roof landings.* The owner or operator shall keep a record of the date when a floating roof is set on its legs or other support devices. The owner or operator shall also keep a record of the date when the roof was refloated, and the record shall indicate whether the process of refloating was continuous.

(d) An owner or operator who elects to use an extension in accordance with §63.1063(e)(2) or §63.1063(c)(2)(iv)(B) shall keep the documentation required by those paragraphs.

### **§63.1066 Reporting requirements.**

(a) *Notification of initial startup.* If the referencing subpart requires that a notification of initial startup be filed, then the content of the notification of initial startup shall include (at a minimum) the information specified in the referencing subpart and the information specified in paragraphs (a)(1) and (a)(2) of this section.

(1) The identification of each storage vessel, its capacity and the liquid stored in the storage vessel.

(2) A statement of whether the owner or operator of the source can achieve compliance by the compliance date specified in referencing subpart.

(b) *Periodic reports.* Report the information specified in paragraphs (b)(1) through (b)(4) of this section, as applicable, in the periodic report specified in the referencing subpart.

(1) *Notification of inspection.* To provide the Administrator the opportunity to have an observer present, the owner or operator shall notify the Administrator at least 30 days before an inspection required by §§63.1063(d)(1) or (d)(3). If an inspection is unplanned and the owner or operator could not have known about the inspection 30 days in advance, then the owner or operator shall notify the Administrator at least 7 days before the inspection. Notification shall be made by telephone immediately followed by written documentation demonstrating why the inspection was unplanned. Alternatively, the notification including the written documentation may be made in writing and sent so that it is received by the Administrator at least 7 days before the inspection. If a delegated State or local agency is notified, the owner or operator is not required to notify the Administrator. A delegated State or local agency may waive

the requirement for notification of inspections.

(2) *Inspection results.* The owner or operator shall submit a copy of the inspection record (required in §63.1065) when inspection failures occur.

(3) *Requests for alternate devices.* The owner or operator requesting the use of an alternate control device shall submit a written application including emissions test results and an analysis demonstrating that the alternate device has an emission factor that is less than or equal to the device specified in §63.1063.

(4) *Requests for extensions.* An owner or operator who elects to use an extension in accordance with §63.1063(e)(2) or §63.1063(c)(2)(iv)(B) shall submit the documentation required by those paragraphs.

### **§63.1067 Implementation and enforcement.**

(a) This subpart can be implemented and enforced by the U.S. Environmental Protection Agency (EPA), or a delegated authority such as the applicable State, local, or tribal agency. If the EPA Administrator has delegated authority to a State, local, or tribal agency, then that agency has the authority to implement and enforce this subpart. Contact the applicable EPA Regional Office to find out if this subpart is delegated to a State, local, or tribal agency.

(b) In delegating implementation and enforcement authority of this subpart to a State, local, or tribal agency under section 40 CFR part 63, subpart E, the authorities contained in paragraphs (b)(1) through (5) of this section are retained by the EPA Administrator and are not transferred to the State, local, or tribal agency.

(1) Approval of alternatives to the nonopacity emissions standards in §§63.1062 and 63.1063(a) and (b) for alternative means of emission limitation, under §63.6(g).

(2) [Reserved]

(3) Approval of major changes to test methods under §63.7(e)(2)(ii) and (f) and as defined in §63.90.

(4) Approval of major changes to monitoring under §63.8(f) and as defined in §63.90.

(5) Approval of major changes to recordkeeping and reporting under §63.10(f) and as defined in §63.90.

[67 FR 46279, July 12, 2002]

**Appendix J**

40 C.F.R. Part 63, Subpart OOO – *National Emission Standards for Hazardous Air Pollutants emissions: Manufacture of Amino/Phenolic Resins Production*



## Subpart 000—National Emission Standards for Hazardous Air Pollutant Emissions: Manufacture of Amino/Phenolic Resins

SOURCE: 65 FR 3290, Jan. 20, 2000, unless otherwise noted.

### §63.1400 Applicability and designation of affected sources.

(a) *Applicability.* The provisions of this subpart apply to the owner or operator of processes that produce amino/phenolic resins and that are located at a plant site that is a major source as defined in §63.2.

(b) *Affected source.* The affected source is:

- (1) The total of all amino/phenolic resin process units (APPU);
- (2) The associated heat exchange systems;
- (3) Equipment required by, or utilized as a method of compliance with, this subpart which may include control devices and recovery devices;
- (4) Equipment that does not contain organic hazardous air pollutants (HAPs) and is located within an APPU that is part of an affected source;
- (5) Vessels and equipment storing and/or handling material that contain no organic HAP and/or organic HAP as impurities only;
- (6) Equipment that is intended to operate in organic HAP service for less than 300 hours during the calendar year;
- (7) Each waste management unit; and
- (8) Maintenance wastewater.

(c) *Existing affected source.* The affected source to which the existing source provisions of this subpart apply is defined in paragraph (b) of this section.

(d) *New affected source.* The affected source to which the new source provisions of this subpart apply is:

- (1) Each affected source defined in paragraph (b) of this section that commences construction or reconstruction after December 14, 1998;
- (2) Each additional group of one or more APPU and associated heat exchange systems that has the potential to emit 10 tons per year or more of any organic HAP or 25 tons per year or more of any combination of organic HAP that commences construction after December 14, 1998; or

(3) Each group of one or more process units and associated heat exchange systems that are converted to APPUs after December 14, 1998, that has the potential to emit 10 tons per year or more of any organic HAP or 25 tons per year or more of any combination of organic HAP.

(e) *APPUs without organic HAP.* An APPU that is part of an affected source, as defined in paragraph (c) or (d) of this section, but that does not use or manufacture any organic HAP, is not subject to any other provisions of this subpart and is not required to comply with the provisions of subpart A of this part. When requested by the Administrator, the owner or operator shall demonstrate that the APPU does not use or manufacture any organic HAP. Types of information that could document this determination include, but are not limited to, records of chemicals purchased for the process, analyses of process stream composition, engineering calculations, or process knowledge.

(f) *Exemption from equipment leak provisions.* Affected sources with actual annual production of amino/phenolic resin equal to or less than 800 megagrams per year (Mg/yr) for the 12-month period preceding December 14, 1998 are exempt from the equipment leak provisions specified in §63.1410. The owner or operator utilizing this exemption shall recheck the actual annual production of amino/phenolic resins for each 12-month period following December 14, 1998. The beginning of each 12-month period shall be the anniversary of December 14, 1998. If the actual annual production of amino/phenolic resins is greater than 800 Mg/yr for any 12-month period, the owner or operator shall comply with §63.1410 for the life of the affected source or until the affected source is no longer subject to the provisions of this subpart.

(g) *Primary product determination and applicability.* For purposes of this paragraph, amino resins and phenolic resins shall be considered to be the same product and production time or production mass of amino and phenolic resins shall be combined for purposes of determining the primary product under this paragraph (g). If the owner or operator determines that a process unit is not an APPU under paragraphs (g)(1) through (4) of this section, the owner or operator shall, when requested by the Administrator, demonstrate that the process unit is not an APPU.

(1) *Applicability determinations for process units producing multiple products.* A process unit that produces more than one intended product at the same time is an APPU if amino/phenolic resin production accounts for the greatest percent of the annual design capacity on a mass basis. If a process unit has the same annual design capacity on a mass basis for two or more products, the process unit shall be an APPU if amino/phenolic resins are one of those products.

(2) *Flexible operations process unit determination based on operating time.* A flexible operations process unit is an APPU if amino/phenolic resins will be produced for the greatest operating time over the 5 years following December 14, 1998 at existing process units, or for the first year after the process unit begins production of any product for new process units.

(3) *Flexible operations process unit determination based on mass production basis.* A flexible operations process unit that will manufacture multiple products equally based on operating time is an APPU if amino/phenolic resins account for the greatest percentage of the expected production on a mass basis over the 5 years following December 14, 1998 at existing process units, or for the first year after the process unit begins production of any product for new process units.

(4) *Flexible operations process unit default determination.* If the owner or operator cannot determine whether or not amino/phenolic resins are the primary product of a flexible operations process unit in accordance with paragraphs (g)(2) and (3) of this section, the flexible operations process unit shall be designated as an APPU if amino/phenolic resins were produced for 5 percent or greater of the total operating time since December 14, 1998 for existing process units. The flexible operations process unit shall be designated as an APPU if the owner or operator anticipates that amino/phenolic resins will be manufactured in the flexible operations process unit at any time in the first year after the date the unit begins production of any product for new process units.

(5) *Annual applicability determination for non-APPUs that have produced amino/phenolic resins.* Once per year beginning December 14, 2003, the owner or operator of each flexible operations process unit that is not designated as an APPU, but that has produced amino/phenolic resins at any time in the preceding 5-year period or since the date that the unit began production of any product, whichever is shorter, shall perform an evaluation to determine whether the process unit has become an APPU. A flexible operations process unit has become an APPU if amino/phenolic resins were produced for the greatest operating time over the preceding 5-year period or since the date that the process unit began production of any product, whichever is shorter.

(6) *Applicability determination for non-APPUs that have not produced amino/phenolic resins.* The owner or operator that anticipates the production of amino/phenolic resins in a process unit that is not designated as an APPU, and in which no amino/phenolic resins have been produced in the previous 5-year period or since the date that the process unit began production of any product, whichever is shorter, shall determine if the process unit will become an APPU. The owner or operator shall use the procedures in paragraphs (g)(1) through (4) of this section to determine if the process unit is designated as an APPU, with the following exception: for existing process units, production shall be projected for the 5 years following the date that the owner or operator anticipates initiating the production of amino/phenolic resins, instead of the 5 years following December 14, 1998.

(7) *Redetermination of applicability to APPU that are flexible operations process units.* Whenever changes in production occur that could reasonably be expected to cause a flexible operations process unit to no longer be an APPU (i.e., amino/phenolic resins will no longer be the primary product according to the determination procedures in paragraphs (g)(2) through (4) of this section), the owner or operator shall reevaluate the status of the process unit as an APPU. A flexible operations process unit has ceased to be an APPU subject to this subpart if the following criteria are met:

(i) If amino/phenolic resins were not produced for the greatest operating time over the preceding 5-year period or since the date that the process unit began production of any product, whichever is shorter;

(ii) If the new primary product, which is not amino/phenolic resins, is subject to another subpart of this part; and

(iii) If the owner or operator has notified the Administrator of the pending change in status for the flexible operations process unit, as specified in §63.1417(h)(4).

(8) *APPU terminating production of all amino/phenolic resins.* If an APPU terminates the production of all amino/phenolic resins and does not anticipate the production of any amino/phenolic resins in the future, the process unit is no longer an APPU and is not subject to this subpart after notification is made to the Administrator, as specified in §63.1417(h)(4).

(h) *Storage vessel applicability determination.* The owner or operator of a storage vessel at a new affected source shall determine assignment to a process unit as follows:

(1) If a storage vessel is already subject to another subpart of part 63 on January 20, 2000, said storage vessel shall continue to be assigned to the process unit subject to the other subpart.

(2) If a storage vessel is dedicated to a single process unit, the storage vessel shall be assigned to that process unit.

(3) If a storage vessel is shared among process units, then the storage vessel shall be assigned to that process unit located on the same plant site as the storage vessel that has the greatest input into or output from the storage vessel (i.e., said process unit has the predominant use of the storage vessel).

(4) If predominant use cannot be determined for a storage vessel that is shared among process units, and if one or more of those process units is an APPU subject to this subpart, the storage vessel shall be assigned to any of the APPUs.

(5) [Reserved]

(6) If the predominant use of a storage vessel varies from year to year, then predominant use shall be determined based on the use as follows:

(i) For existing affected sources, use shall be determined based on the following:

(A) The year preceding January 20, 2000; or

(B) The expected use for the 5 years following January 20, 2000.

(ii) For new affected sources, use shall be determined based on the first 5 years after initial start-up.

(7) Where the storage vessel is located in a tank farm (including a marine tank farm), the assignment of the storage vessel shall be determined according to paragraphs (h)(7)(i) and (ii) of this section. Only those storage vessels where a portion or all of the input into or output from the storage vessel is hardpiped directly to one or more process units are covered by this paragraph.

(i) The storage vessel is assigned to a process unit if the product or raw material entering or leaving the process unit flows directly into (or from) the storage vessel in the tank farm without passing through any intervening storage vessel. An intervening storage vessel means a storage vessel connected by hardpiping both to the process unit and to the storage vessel in the tank farm.

(ii) If there are two or more process units that meet the criteria of paragraph (h)(7)(i) of this section with respect to a storage vessel, the storage vessel shall be assigned to one of those process units according to the provisions of paragraphs (h)(3) through (6) of this section.

(8) If the storage vessel begins receiving material from (or sending material to) a process unit that was not included in the initial determination, or ceases to receive material from (or send material to) a process unit, the owner or operator shall reevaluate the applicability of this subpart to the storage vessel according to the procedures in paragraphs (h)(3) through (7) of this section.

(i) *Applicability of other subparts to this subpart.* Paragraphs (i)(1) through (5) describe the applicability of other subparts to this subpart.

(1) After the compliance dates specified in this section, a storage vessel that is assigned to an affected source subject to this subpart that is also subject to and complying with the provisions of 40 CFR part 60, subpart Kb, shall continue to comply with 40 CFR part 60, subpart Kb. After the compliance dates specified in this section, a storage vessel that is assigned to an affected source subject to this subpart that is also subject to the provisions of 40 CFR part 60, subpart Kb, but the owner or operator has not been required to apply controls as part of complying with 40 CFR part 60, subpart Kb, is required to comply only with the provisions of this subpart. After the compliance dates specified in this section, said storage vessel shall no longer be subject to 40 CFR part 60, subpart Kb.

(2) Affected sources subject to this subpart that are also subject to the provisions of subpart Q of this part shall comply with both subparts.

(3) After the compliance dates specified in this section, an affected source subject to this subpart that is also subject to the provisions of 40 CFR part 60, subpart VV, or the provisions of subpart H of this

part, is required to comply only with the provisions of this subpart. After the compliance dates specified in this section, said source shall no longer be subject to 40 CFR part 60, subpart VV, or subpart H of this part, as appropriate.

(4) After the applicable compliance date specified in this subpart, if a heat exchange system subject to this subpart is also subject to a standard identified in paragraph (i)(4)(i) or (ii) of this section, compliance with the applicable provisions of the standard identified in paragraph (i)(4)(i) or (ii) of this section shall constitute compliance with the applicable provisions of this subpart with respect to that heat exchange system.

(i) Subpart F of this part.

(ii) A subpart of this part that requires compliance with §63.104 (e.g., subpart U of this part).

(5) After the compliance dates specified in this subpart, if any combustion device, recovery device or recapture device subject to this subpart is also subject to monitoring, recordkeeping, and reporting requirements in 40 CFR part 264, subparts AA, BB, or CC, or is subject to monitoring and recordkeeping requirements in 40 CFR part 265, subparts AA, BB, or CC, and the owner or operator complies with the periodic reporting requirements under 40 CFR part 264, subparts AA, BB, or CC, that would apply to the device if the facility had final-permitted status, the owner or operator may elect to comply either with the monitoring, recordkeeping and reporting requirements of this subpart, or with the monitoring, recordkeeping and reporting requirements in 40 CFR parts 264 and/or 265, as described in this paragraph, which shall constitute compliance with the monitoring, recordkeeping and reporting requirements of this subpart. If the owner or operator elects to comply with the monitoring, recordkeeping, and reporting requirements in 40 CFR parts 264 and/or 265, the owner or operator shall report all information required by §63.1417(f), Periodic Reports, as part of complying with the requirements of 40 CFR parts 264 and/or 265.

(j) *Applicability of general provisions.* Table 1 of this subpart specifies the provisions of subpart A of this part that apply and do not apply to owners and operators of affected sources subject to this subpart.

(k) *Applicability of this subpart.* (1) The emission limitations set forth in this subpart and the emission limitations referred to in this subpart shall apply at all times except during periods of non-operation of the affected source (or specific portion thereof) resulting in cessation of the emissions to which this subpart applies.

(2) The emission limitations set forth in 40 CFR part 63, subpart UU, as referred to in §63.1410, shall apply at all times except during periods of non-operation of the affected source (or specific portion thereof) in which the lines are drained and depressurized resulting in cessation of the emissions to which §63.1410 applies.

(3) The owner or operator shall not shut down items of equipment that are required or utilized for compliance with this subpart during times when emissions are being routed to such items of equipment if the shutdown would contravene requirements of this subpart applicable to such items of equipment.

(4) *General duty.* At all times, the owner or operator must operate and maintain any affected source, including associated air pollution control equipment and monitoring equipment, in a manner consistent with safety and good air pollution control practices for minimizing emissions. The general duty to minimize emissions does not require the owner or operator to make any further efforts to reduce emissions if levels required by the applicable standard have been achieved. Determination of whether a source is operating in compliance with operation and maintenance requirements will be based on information available to the Administrator, which may include, but is not limited to, monitoring results, review of operation and maintenance procedures, review of operation and maintenance records, and inspection of the source.

**§63.1401 Compliance schedule.**

(a) New affected sources that commence construction or reconstruction after December 14, 1998, shall be in compliance with this subpart (except §63.1411(c)) upon initial start-up or January 20, 2000, whichever is later. New affected sources that commenced construction or reconstruction after December 14, 1998, but on or before January 9, 2014, shall be in compliance with the pressure relief device monitoring requirements of §63.1411(c) by October 9, 2017. New affected sources that commence construction or reconstruction after January 9, 2014, shall be in compliance with the pressure relief device monitoring requirements of §63.1411(c) upon initial startup or by October 8, 2014.

(b) Existing affected sources shall be in compliance with this subpart (except §§63.1404, 63.1405, and 63.1411(c)) no later than 3 years after January 20, 2000. Existing affected sources shall be in compliance with the storage vessel requirements of §63.1404, the continuous process vent requirements of §63.1405, and the pressure relief device monitoring requirements of §63.1411(c) by October 9, 2017.

(c) If an affected source using the exemption provided in §63.1400(f) has an actual annual production of amino/phenolic resins exceeding 800 Mg/yr for any 12-month period, the owner or operator shall comply with the provisions of §63.1410 for the affected source within 3 years. The starting point for the 3-year compliance time period shall be the end of the 12-month period in which actual annual production for amino/phenolic resins exceeds 800 Mg/yr.

(d) Pursuant to section 112(i)(3)(B) of the Clean Air Act, an owner or operator may request an extension allowing the existing affected source up to 1 additional year to comply with section 112(d) standards. For purposes of this subpart, a request for an extension shall be submitted to the permitting authority as part of the operating permit application or to the Administrator as a separate submittal or as part of the Precompliance Report.

(1) Requests for extensions shall be submitted no later than 120 days prior to the compliance dates specified in paragraphs (a) and (b) of this section and shall include the data described in §63.6(i)(6)(i)(A), (B), and (D). The dates specified in §63.6(i) for submittal of requests for extensions shall not apply to this subpart.

(2) An owner or operator may submit a compliance extension request less than 120 days prior to the compliance dates specified in paragraphs (a) and (b) of this section provided that the need for the compliance extension arose after that date, and the need arose due to circumstances beyond reasonable control of the owner or operator. This request shall include, in addition to the information specified in §63.6(i)(6)(i)(A), (B), and (D), a statement of the reasons additional time is needed and the date when the owner or operator first learned of the circumstances necessitating a request for compliance extension.

(e) All terms in this subpart that define a period of time for completion of required tasks (e.g., weekly, monthly, quarterly, annual), unless specified otherwise, refer to the standard calendar periods.

(1) Notwithstanding time periods specified in this subpart for completion of required tasks, such time periods may be changed by mutual agreement between the owner or operator and the Administrator, as specified in subpart A of this part (e.g., a period could begin on the compliance date or another date, rather than on the first day of the standard calendar period). For each time period that is changed by agreement, the revised period shall remain in effect until it is changed. A new request is not necessary for each recurring period.

(2) Where the period specified for compliance is a standard calendar period, if the initial compliance date occurs after the beginning of the period, compliance shall be required according to the schedule specified in paragraph (e)(2)(i) or (ii) of this section, as appropriate:

(i) Compliance shall be required before the end of the standard calendar period within which the compliance deadline occurs, if there remain at least 3 days for tasks that must be performed weekly, at least 2 weeks for tasks that must be performed monthly, at least 1 month for tasks that must be performed each quarter, or at least 3 months for tasks that must be performed annually; or

(ii) In all other cases, compliance shall be required before the end of the first full standard calendar period after the period within which the initial compliance deadline occurs.

(3) In all instances where a provision of this subpart requires completion of a task during each of multiple successive periods, an owner or operator may perform the required task at any time during the specified period, provided that the task is conducted at a reasonable interval after completion of the task during the previous period.

[65 FR 3290, Jan. 20, 2000, as amended at 79 FR 60929, Oct. 8, 2014]

### **§63.1402 Definitions.**

(a) The following terms used in this subpart shall have the meaning given them in §§63.2, 63.101, 63.111, and 63.161 as specified after each term:

Act (§63.2)

Administrator (§63.2)

Annual average concentration (§63.111)

Annual average flow rate (§63.111)

Automated monitoring and recording system (§63.111)

Boiler (§63.111)

Bottoms receiver (§63.161)

By compound (§63.111)

By-product (§63.101)

Car-seal (§63.111)

Closed-vent system (§63.111)

Combustion device (§63.111)

Commenced (§63.2)

Compliance date (§63.2)

Connector (§63.161)

Construction (§63.2)

Continuous monitoring system (§63.2)

Distillation unit (§63.111)

Duct work (§63.161)

Emission standard (§63.2)

EPA (§63.2)

External floating roof (§63.111)

First attempt at repair (§63.111)

Flame zone (§63.111)

Floating roof (§63.111)

Flow indicator (§63.111)

Fuel gas (§63.101)

Fuel gas system (§63.101)

Hard-piping (§63.111)

Hazardous air pollutant (§63.2)

Impurity (§63.101)

In organic hazardous air pollutant service (§63.161)

Incinerator (§63.111)

Instrumentation system (§63.161)

Internal floating roof (§63.111)

Lesser quantity (§63.2)

Major source (§63.2)

Open-ended valve or line (§63.161)

Operating permit (§63.101)

Organic monitoring device (§63.111)

Owner or operator (§63.2)

Performance evaluation (§63.2)

Performance test (§63.2)

Permitting authority (§63.2)

Plant site (§63.101)

Potential to emit (§63.2)

Pressure relief device or valve (§63.161)

Primary fuel (§63.111)

Process heater (§63.111)

Process unit shutdown (§63.161)

Process wastewater (§63.111)

Reactor (§63.111)



Reconstruction (§63.2)

Routed to a process or route to a process (§63.161)

Run (§63.2)

Secondary fuel (§63.111)

Sensor (§63.161)

Specific gravity monitoring device (§63.111)

State (§63.2)

Surge control vessel (§63.161)

Temperature monitoring device (§63.111)

Test method (§63.2)

Total resource effectiveness (TRE) index value (§63.111)

Treatment process (§63.111)

Unit operation (§63.101)

Visible emission (§63.2)

(b) All other terms used in this subpart shall have the meaning given them in this section. If a term is defined in §63.2, §63.101, §63.111, or §63.161 or defined in 40 CFR part 63, subparts SS, UU, or WW and in this section, it shall have the meaning given in this section for purposes of this subpart.

*Aggregate batch vent stream* means a process vent containing emissions from at least one reactor batch process vent and at least one additional reactor or non-reactor batch process vent where the emissions are ducted, hardpiped, or otherwise connected together for a continuous flow.

*Amino resin* means a thermoset resin produced through the reaction of formaldehyde, or a formaldehyde containing solution (e.g., aqueous formaldehyde), with compound(s) that contain the amino group; these compounds include melamine, urea, and urea derivatives. Formaldehyde substitutes are exclusively aldehydes.

*Amino/phenolic resin* means one or both of the following:

- (1) Amino resin; or
- (2) Phenolic resin.

*Amino/phenolic resin. Process unit (APPU)* means a collection of equipment assembled and connected by hardpiping or ductwork used to process raw materials and to manufacture an amino/phenolic resin as its primary product. This collection of equipment includes unit operations; process vents; storage vessels, as determined in §63.1400(h); and the equipment that is subject to the equipment leak provisions as specified in §63.1410. Utilities, lines and equipment not containing process fluids, and other non-process lines, such as heating and cooling systems which do not combine their materials with those in the processes they serve, are not part of the amino/phenolic resin process unit. An amino/phenolic resin process unit consists of more than one unit operation.

*Batch cycle* means the operational step or steps, from start to finish, that occur as part of a batch unit operation.

*Batch emission episode* means a discrete emission venting episode associated with a single batch unit operation. Multiple batch emission episodes may occur from a single batch unit operation.

*Batch mode* means the discontinuous bulk movement of material through a unit operation. Mass, temperature, concentration, and other properties may vary with time. For a unit operation operated in a batch mode (i.e., batch unit operation), the addition of material and withdrawal of material do not typically occur simultaneously.

*Batch process vent* means a process vent from a batch unit operation within an affected source. Batch process vents are either reactor batch process vents or non-reactor batch process vents.

*Batch unit operation* means a unit operation operated in a batch mode.

*Block* means the time period that comprises a single batch cycle.

*Combustion device burner* means a device designed to mix and ignite fuel and air to provide a flame to heat and oxidize waste organic vapors in a combustion device.

*Continuous mode* means the continuous movement of material through a unit operation. Mass, temperature, concentration, and other properties typically approach steady-state conditions. For a unit operation operated in a continuous mode (i.e., continuous unit operation), the simultaneous addition of raw material and withdrawal of product is typical.

*Continuous process vent* means a process vent from a continuous unit operation within an affected source. Process vents that are serving as control devices are not subject to additional control requirements.

*Continuous record* means documentation, either in hard copy or computer readable form, of data values measured at least once every 15 minutes and recorded at the frequency specified in §63.1416(c) or (h).

*Continuous recorder* means a data recording device that either records an instantaneous data value at least once every 15 minutes or records 1 hour or more frequent block average values.

*Continuous unit operation* means a unit operation operated in a continuous mode.

*Control device* means any combustion device, recovery device, or recapture device. Such equipment includes, but is not limited to, absorbers, carbon adsorbers, condensers, incinerators, flares, boilers, and process heaters. For continuous process vents, recapture devices are considered control devices but recovery devices are not considered control devices. Condensers operating as process condensers are not considered control devices. For a condenser that sometimes operates as a process condenser to be considered a control device, it shall not be operating as a process condenser for a given batch emission episode, and it shall recycle of the recovered material within the process.

*Control technology* means any process modification or use of equipment that reduces organic HAP emissions. Examples include, but are not limited to, product reformulation to reduce solvent content and/or use, batch cycle time reduction to reduce the duration of emissions, reduction of nitrogen purge rate, and the lowering of process condenser coolant temperatures.

*Controlled organic HAP emissions* means the quantity of organic HAP discharged to the atmosphere from a control device.

*Emission point* means an individual continuous process vent, batch process vent, aggregate batch vent stream, storage vessel, equipment leak, or heat exchange system.

*Equipment* means , for the purposes of the provisions in §63.1410, each pump, compressor, agitator, pressure relief device, sampling connection system, open-ended valve or line, valve, connector, and instrumentation system in organic HAP service; and any control devices or systems required by §63.1410. For purposes of this subpart, surge control vessels and bottom receivers are not equipment for purposes of regulating equipment leak emissions. Surge control vessels and bottoms receivers are regulated as non-reactor batch process vents for the purposes of this subpart.

*Equipment leak* means emissions of organic HAP from a pump, compressor, agitator, pressure relief device, sampling connection system, open-ended valve or line, valve, or instrumentation system that either contains or contacts a fluid (liquid or gas) that is at least 5 percent by weight of total organic HAP.

*Existing process unit* means any process unit that is not a new process unit.

*Flexible operations process unit* means a process unit that periodically manufactures different chemical products, polymers, or resins by alternating raw materials or operating conditions. These units are also referred to as campaign plants or blocked operations.

*Heat exchange system* means any cooling tower system or once-through cooling water system (e.g., river or pond water) designed and intended to operate to not allow contact between the cooling medium and process fluid or gases (i.e., a noncontact system). A heat exchange system may include more than one heat exchanger and may include recirculating or once-through cooling systems.

*Highest-HAP recipe* for a product means the recipe of the product with the highest total mass of organic HAP charged to the reactor during the production of a single batch of product.

*Initial start-up* means the first time a new or reconstructed affected source begins production, or, for equipment added or changed, the first time the equipment is put into operation. Initial start-up does not include operation solely for testing equipment. Initial start-up does not include subsequent start-ups of an affected source or portion thereof following malfunctions or shutdowns, or following changes in product for flexible operation process units, or following recharging of equipment in batch operation. Further, for purposes of §§63.1401 and 63.1410, initial start-up does not include subsequent start-ups of affected sources or portions thereof following malfunctions or process unit shutdowns.

*Inprocess recycling* means a recycling operation in which recovered material is used by a unit operation within the same affected source. It is not necessary for recovered material to be used by the unit operation from which they were recovered.

*Maintenance wastewater* means wastewater generated by the draining of process fluid from components in the APPU into an individual drain system prior to or during maintenance activities. Maintenance wastewater can be generated during planned and unplanned shutdowns and during periods not associated with a shutdown. Examples of activities that can generate maintenance wastewaters include descaling of heat exchanger tubing bundles, cleaning of distillation column traps, draining of low legs and high point bleeds, draining of pumps into an individual drain system, and draining of portions of the APPU for repair. The generation of wastewater from the routine rinsing or washing of equipment in batch operation between batches is not maintenance wastewater for the purposes of this subpart.

*Malfunction* means any sudden, infrequent, and not reasonably preventable failure of air pollution control equipment or process equipment, or failure of a process to operate in a normal or usual manner, or opening of a safety device which causes, or has the potential to cause, the emission limitations in an applicable standard to be exceeded. Failures that are caused in part by poor maintenance or careless operation are not malfunctions.

*Maximum representative operating conditions* means, for purposes of testing or measurements required by §63.1413, those conditions which reflect the highest organic HAP emissions reasonably expected to be vented to the control device or emitted to the atmosphere. For affected sources that produce the same product(s) using multiple recipes, the production of the highest-HAP recipe is reflective of maximum representative operating conditions.

*Maximum true vapor pressure* means the equilibrium partial pressure exerted by the total organic HAP in the stored liquid at the temperature equal to the highest calendar-month average of the liquid storage temperature for liquids stored above or below the ambient temperature, or at the local maximum monthly average temperature as reported by the National Weather Service for liquids stored at the ambient temperature, as determined:

(1) In accordance with methods described in American Petroleum Institute Publication 2517, Evaporative Loss From External Floating-Roof Tanks (incorporated by reference as specified in §63.14); or

(2) As obtained from standard reference texts; or

(3) As determined by the American Society for Testing and Materials Method D2879-83 (incorporated by reference as specified in §63.14); or

(4) Any other method approved by the Administrator.

*Multicomponent system* means, as used in conjunction with batch process vents, a stream whose liquid and/or vapor contains more than one compound.

*Net heating value* means the difference between the heat value of the recovered chemical stream and the minimum heat value required to ensure a stable flame in the combustion device. This difference must have a positive value when used in the context of "recovering chemicals for fuel value" (e.g., in the definition of "recovery device" in this section).

*New process unit* means a process unit for which the construction or reconstruction commenced after December 14, 1998.

*Non-reactor batch process vent* means a batch process vent originating from a unit operation other than a reactor. Non-reactor batch process vents include, but are not limited to, batch process vents from filter presses, surge control vessels, bottoms receivers, weigh tanks, and distillation systems.

*Non-solvent-based resin* means an amino/phenolic resin manufactured without the use of a solvent as described in the definition of solvent-based resin.

*On-site* or *On site* means, with respect to records required to be maintained by this subpart or required by another subpart referenced by this subpart, records are stored at a location within a major source which encompasses the affected source. On-site includes, but is not limited to, storage at the affected source or APPU to which the records pertain, or storage in central files elsewhere at the major source.

*Operating day* means the period defined by the owner or operator in the Notification of Compliance Status required by §63.1417(e). The operating day is the period for which daily average monitoring values and batch cycle daily average monitoring values are determined.

*Organic hazardous air pollutant(s) (organic HAP)* means one or more of the chemicals listed in Table 2 of this subpart or any other chemical which is:

- (1) Knowingly produced or introduced into the manufacturing process other than as an impurity; and
- (2) Listed in Table 2 of subpart F of this part.

*Phenolic resin* means a thermoset resin that is a condensation product of formaldehyde and phenol, or a formaldehyde substitute and/or a phenol substitute. Substitutes for formaldehyde are exclusively aldehydes and include acetaldehyde or furfuraldehyde. Substitutes for phenol include other phenolic starting compounds such as cresols, xylenols, p-tert-butylphenol, p-phenylphenol, nonylphenol, and resorcinols.

*Pressure release* means the emission of materials resulting from the system pressure being greater than the set pressure of the pressure relief device. This release can be one release or a series of releases over a short time period.

*Process condenser* means a condenser functioning so as to recover material as an integral part of a unit operation(s). A process condenser shall support a vapor-to-liquid phase change for periods of equipment operation that are at or above the boiling or bubble point of substance(s) at the liquid surface. Examples of process condensers include distillation condensers, reflux condensers, and condensers used in stripping or flashing operations. In a series of condensers, all condensers up to and including the first condenser with an exit gas temperature below the boiling or bubble point of the substance(s) at the liquid surface are considered to be process condensers. All condensers in line prior to a vacuum source are considered process condensers when the vacuum source is being operated. A condenser may be a process condenser for some batch emission episodes and, when meeting certain conditions, may be a control device for other batch emission episodes.

*Process unit* means a collection of equipment assembled and connected by hardpiping or ductwork used to process raw materials and to manufacture a product.

*Process vent* means a gaseous emission stream from a unit operation where the gaseous emission stream is discharged to the atmosphere either directly or after passing through one or more control, recovery, or recapture devices. Unit operations that may have process vents are condensers, distillation units, reactors, or other unit operations within the APPU. Emission streams that are undiluted and uncontrolled containing less than 50 parts per million volume (ppmv) organic HAP, as determined through process knowledge that no organic HAP are present in the emission stream or using an engineering assessment as discussed in §63.1414(d)(6); test data using the test methods specified in §63.1414(a); or any other test method that has been validated according to the procedures in Method 301 of appendix A of this part are not considered process vents. Process vents exclude relief valve discharges, gaseous streams routed to a fuel gas system(s), and leaks from equipment regulated under §63.1410. Process vents that are serving as control devices are not subject to additional control requirements.

*Product* means a resin, produced using the same monomers and varying in additives (e.g., initiators, terminators, etc.), catalysts, or in the relative proportions of monomers, that is manufactured by a process unit. With respect to resins, more than one recipe may be used to produce the same product. Product also means a chemical that is not a resin that is manufactured by a process unit. By-products, isolated intermediates, impurities, wastes, and trace contaminants are not considered products.

*Reactor batch process vent* means a batch process vent originating from a reactor.

*Recapture device* means an individual unit of equipment capable of and used for the purpose of recovering chemicals, but not normally for use, reuse, or sale. For example, a recapture device may recover chemicals primarily for disposal. Recapture devices include, but are not limited to, absorbers, carbon adsorbers, and condensers.

*Recipe* means a specific composition from among the range of possible compositions that may occur within a product, as defined in this section. A recipe is determined by the proportions of monomers and, if present, other reactants and additives that are used to make the recipe. For example, a methylated amino resin and a non-methylated amino resin are both different recipes of the same product, amino resin.

*Recovery device* means an individual unit of equipment capable of and normally used for the purpose of recovering chemicals for use, reuse, fuel value (i.e., net heating value); or for sale for use, reuse, or fuel value (i.e., net heating value). Examples of equipment that may be recovery devices include absorbers, carbon adsorbers, condensers, oil-water separators or organic-water separators, or organic removal devices such as decanters, strippers, or thin-film evaporation units. For the purposes of the monitoring, recordkeeping, or reporting requirements of this subpart, recapture devices are considered recovery devices.

*Safety device* means a closure device such as a pressure relief valve, frangible disc, fusible plug, or any other type of device which functions exclusively to prevent physical damage or permanent deformation to a unit or its air emission control equipment by venting gases or vapors directly to the atmosphere during unsafe conditions resulting from an unplanned, accidental, or emergency event. For the purposes of this subpart, a safety device is not used for routine venting of gases or vapors from the vapor headspace underneath a cover such as during filling of the unit or to adjust the pressure in this vapor headspace in response to normal daily diurnal ambient temperature fluctuations. A safety device is designed to remain in a closed position during normal operations and open only when the internal pressure, or another relevant parameter, exceeds the device threshold setting applicable to the air emission control equipment as determined by the owner or operator based on manufacturer recommendations, applicable regulations, fire protection and prevention codes, standard engineering codes and practices, or other requirements for the safe handling of flammable, combustible, explosive, reactive, or hazardous materials.

*Seal* means, for the purpose of complying with the requirements of §63.1033(b), that instrument monitoring of the open-ended valve or line conducted according to the method specified in §63.1023(b) and, as applicable, §63.1023(c), indicates no readings of 500 parts per million or greater.

*Shutdown* means for purposes including, but not limited to, periodic maintenance, replacement of equipment, or repair, the cessation of operation of an affected source, an APPU(s) within an affected source, or equipment required or used to comply with this subpart, or the emptying or degassing of a storage vessel. For purposes of the batch process vent provisions in §§63.1406 through 63.1408, the cessation of equipment in batch operations is not a shutdown, unless the equipment undergoes maintenance, is replaced, or is repaired.

*Solvent-based resin* means an amino/phenolic resin that consumes a solvent (i.e., methanol, xylene) as a reactant in the resin producing reaction. The use of a solvent as a carrier (i.e., adding methanol to the product/water solution after the reaction is complete) does not meet this definition.

*Start-up* means the setting into operation of an affected source, an APPU(s) within an affected source, a unit operation within an affected source, or equipment required or used to comply with this subpart, or a storage vessel after emptying and degassing. For both continuous and batch unit operations, start-up includes initial start-up and operation solely for testing equipment. For both continuous and batch unit operations, start-up does not include the recharging of equipment in batch operation. For continuous unit operations, start-up includes transitional conditions due to changes in

product for flexible operation process units. For batch unit operations, start-up does not include transitional conditions due to changes in product for flexible operation process units.

*Steady-state conditions* means that all variables (temperatures, pressures, volumes, flow rates, etc.) in a process do not vary significantly with time; minor fluctuations about constant mean values may occur.

*Storage vessel* means a tank or other vessel that is used to store liquids that contain one or more organic HAP. Storage vessels do not include:

- (1) Vessels permanently attached to motor vehicles such as trucks, railcars, barges, or ships;
- (2) Pressure vessels designed to operate in excess of 204.9 kilopascals and without emissions to the atmosphere;
- (3) Vessels with capacities smaller than 38 cubic meters;
- (4) Vessels and equipment storing and/or handling material that contains no organic HAP and/or organic HAP as impurities only;
- (5) Wastewater storage tanks;
- (6) Surge control vessels or bottoms receivers; and
- (7) Vessels and equipment storing and/or handling amino/phenolic resin.

*Supplemental combustion air* means the air that is added to a vent stream after the vent stream leaves the unit operation. Air that is part of the vent stream as a result of the nature of the unit operation is not considered supplemental combustion air. Air required to operate combustion device burner(s) is not considered supplemental combustion air.

*Uncontrolled organic HAP emissions* means the organic HAP emitted from a unit operation prior to introduction of the emission stream into a control device. Uncontrolled HAP emissions are determined after any condenser that is operating as a process condenser. If an emission stream is not routed to a control device, uncontrolled organic HAP emissions are those organic HAP emissions released to the atmosphere.

*Vent stream*, as used in reference to batch process vents, aggregate batch vent streams, continuous process vents, and storage vessels, means the emissions from that emission point.

*Waste management unit* means the equipment, structure(s), and/or device(s) used to convey, store, treat, or dispose of wastewater streams or residuals. Examples of waste management units include: wastewater tanks, surface impoundments, individual drain systems, and biological wastewater treatment units. Examples of equipment that may be waste management units include containers, air flotation units, oil-water separators or organic-water separators, or organic removal devices such as decanters, strippers, or thin-film evaporation units. If such equipment is used for recovery, then it is part of an APPU and is not a waste management unit.

*Wastewater* is either a process wastewater or maintenance wastewater and means water that:

- (1) Contains either:

(i) An annual average concentration of organic HAP, as indicated on Table 2 of this subpart, of at least 5 parts per million by weight and has an annual average flow rate of 0.02 liter per minute or greater; or

(ii) An annual average concentration of organic HAP, as indicated on Table 2 of this subpart, of at least 10,000 parts per million by weight at any flow rate.

(2) Is discarded from an APPU that is part of an affected source.

(3) Does not include:

(i) Stormwater from segregated sewers;

(ii) Water from fire-fighting and deluge systems in segregated sewers;

(iii) Spills;

(iv) Water from safety showers;

(v) Water from testing of deluge systems; and

(vi) Water from testing of firefighting systems.

*Wastewater stream* means a stream that contains wastewater as defined in this section.

[65 FR 3290, Jan. 20, 2000, as amended at 71 FR 20460, Apr. 20, 2006; 79 FR 60929, Oct. 8, 2014]

### **§63.1403 Emission standards.**

(a) *Provisions of this subpart.* Except as allowed under paragraph (b) of this section, the owner or operator of an affected source shall comply with the provisions of §§63.1404 through 63.1410, as appropriate. When emissions are vented to a control device or control technology as part of complying with this subpart, emissions shall be vented through a closed vent system meeting the requirements of 40 CFR part 63, subpart SS (national emission standards for closed vent systems, control devices, recovery devices).

(b) *Combined emission streams.* When emissions of different kinds (e.g., emissions from continuous process vents, storage vessels, etc.) are combined at a new affected source, and at least one of the emission streams would be required by this subpart to apply controls in the absence of combination with other emission streams, the owner or operator shall comply with the requirements of paragraph (b)(1) or (2) of this section, as appropriate.

(1) For any combined vent stream that includes one or more aggregate batch vent streams, comply with the provisions for aggregate batch vent streams.

(2) For any combined vent stream that does not include one or more aggregate batch vent streams:

(i) Reactor batch process vents and non-reactor batch process vents shall comply with the provisions for reactor batch process vents and non-reactor batch process vents, as appropriate.

(ii) The remaining emissions (i.e., storage vessel and/or continuous process vent emissions) included in the combined vent stream shall comply the provisions for storage vessels when storage



vessel emissions are included and shall comply with the provisions for continuous process vents in the absence of storage vessel emissions (i.e., when only continuous process vents are included).

(c) *Compliance for flexible operations process units.* With the exceptions specified in paragraphs (c)(1) and (2) of this section, owners or operators of APPUs that are flexible operations process units shall comply with the provisions of this subpart at all times, regardless of the product being manufactured. Once it has been determined that an emission point requires control during manufacture of amino/phenolic resins, that emission point shall be controlled at all times regardless of the product being manufactured.

(1) When a flexible operations process unit is manufacturing a product in which no organic HAP are used or manufactured, the owner or operator is not required to comply with the provisions of this subpart or with the provisions of subpart A of this part during manufacture of that product. When requested by the Administrator, the owner or operator shall demonstrate that no organic HAP are used or manufactured.

(2) When a flexible operations process unit is manufacturing a product subject to subpart GGG of this part, the owner or operator is not required to comply with the provisions of this subpart during manufacture of that product (i.e., a pharmaceutical).

#### **§63.1404 Storage vessel provisions.**

(a) *Emission standards.* For each storage vessel located at a new or existing affected source that has a capacity of greater than or equal to 20,000 gallons, but less than 40,000 gallons, and vapor pressure of 1.9 pounds per square inch absolute (psia) or greater; has a capacity of greater than or equal to 40,000 gallons, but less than 90,000 gallons, and vapor pressure of 0.75 psia or greater; or has a capacity of 90,000 gallons or greater and vapor pressure of 0.15 psia or greater, the owner or operator shall comply with either paragraph (a)(1) or (2) of this section. As an alternative to complying with paragraph (a) of this section, an owner or operator may comply with paragraph (b) of this section.

(1) Reduce emissions of total organic HAP by 95 weight-percent. Control shall be achieved by venting emissions through a closed vent system to any combination of control devices meeting the requirements of 40 CFR part 63, subpart SS (national emission standards for closed vent systems, control devices, recovery devices). When complying with the requirements of 40 CFR part 63, subpart SS, the following apply for purposes of this subpart:

(i) Design evaluations are allowed for control devices that control emission points with total emissions less than 10 tons of organic HAP per year before control (i.e., small control devices).

(ii) When 40 CFR part 63, subpart SS refers to specific test methods for the measurement of organic HAP concentration, the test methods presented in §63.1414(a) shall be used.

(iii) The option to measure TOC instead of organic HAP, as a basis for demonstrating compliance, is not allowed.

(iv) Excused excursions are not allowed.

(v) The provisions in §63.1403(b), rather than the provisions in §63.982(f), are to be followed for combined vent streams.

(vi) When a scrubber is used as a control device, the owner or operator shall follow the guidance provided in this subpart for design evaluations or performance tests, as appropriate, and for monitoring, recordkeeping, and reporting.

(vii) When there are conflicts between the due dates for reports presented in 40 CFR part 63, subpart SS and this subpart, reports shall be submitted according to the due dates presented in this subpart.

(viii) When there are conflicts between the recordkeeping and reporting requirements presented in 40 CFR part 63, subpart SS and this subpart, the owner or operator shall either follow both sets of requirements (i.e., follow the requirements in 40 CFR part 63, subpart SS for emission points covered by 40 CFR part 63, subpart SS and follow the requirements of this subpart for emission points covered by this subpart) or shall follow the set of requirements they prefer. If an owner or operator chooses to follow just one set of requirements, the owner or operator shall identify which set of requirements are being followed and which set of requirements are being disregarded in the appropriate report.

(2) Comply with the requirements of 40 CFR part 63, subpart WW (national emission standards for storage vessels (control level 2)). When complying with the requirements of 40 CFR part 63, subpart WW, the following apply for purposes of this subpart:

(i) When there are conflicts between the due dates for reports presented in 40 CFR part 63, subpart WW and this subpart, reports shall be submitted according to the due dates presented in this subpart.

(ii) When there are conflicts between the recordkeeping and reporting requirements presented in 40 CFR part 63, subpart WW and this subpart, the owner or operator shall either follow both sets of requirements (i.e., follow the requirements in 40 CFR part 63, subpart WW for emission points covered by 40 CFR part 63, subpart WW and follow the requirements of this subpart for emission points covered by this subpart) or shall follow the set of requirements they prefer. If an owner or operator chooses to follow just one set of requirements, the owner or operator shall identify which set of requirements are being followed and which set of requirements are being disregarded in the appropriate report.

(b) *Alternative standard.* Vent all organic HAP emissions from a storage vessel meeting either of the capacity and vapor pressure criteria specified in paragraph (a) of this section to a combustion control device achieving an outlet organic HAP concentration of 20 ppmv or less or to a non-combustion control device achieving an outlet organic HAP concentration of 50 ppmv or less. Any storage vessels that are not vented to a control device meeting these conditions shall be controlled in accordance with the provisions of paragraph (a)(1) or (2) of this section.

[65 FR 3290, Jan. 20, 2000, as amended at 79 FR 60930, Oct. 8, 2014]

### **§63.1405 Continuous process vent provisions.**

(a) *Emission standards.* For each continuous process vent with a Total Resource Effectiveness (TRE) index value, as determined following the procedures specified in §63.1412(j), less than or equal to 1.2, the owner or operator shall comply with either paragraph (a)(1) or (2) of this section for continuous process vents located at a new affected source, and with either paragraph (a)(1) or (3) of this section for continuous process vents located at an existing affected source. As an alternative to complying with paragraph (a) of this section, an owner or operator may comply with paragraph (b) of this section.

(1) Vent all emissions of organic HAP to a flare.

(2) Reduce emissions of total organic HAP by 85 weight-percent or to a concentration of 20 ppmv when using a combustion control device or to a concentration of 50 ppmv when using a non-combustion control device, whichever is less stringent. Control shall be achieved by venting emissions through a closed vent system to any combination of control devices meeting the requirements of 40 CFR part 63, subpart SS (national emission standards for closed vent systems, control devices, recovery devices). When complying with the requirements of 40 CFR part 63, subpart SS, the following apply for purposes of this subpart:

(i) Design evaluations are allowed for control devices that control emission points with total emissions less than 10 tons of organic HAP per year before control (i.e., small control devices).

(ii) When 40 CFR part 63, subpart SS refers to specific test methods for the measurement of organic HAP concentration, the test methods presented in §63.1414(a) shall be used.

(iii) The option to measure TOC instead of organic HAP, as a basis for demonstrating compliance, is not allowed.

(iv) Excused excursions are not allowed.

(v) The provisions in §63.1403(b), rather than the provisions in §63.982(f), are to be followed for combined vent streams.

(vi) When a scrubber is used as a control device, the owner or operator shall follow the guidance provided in this subpart for design evaluations or performance tests, as appropriate, and for monitoring, recordkeeping, and reporting.

(vii) When there are conflicts between the due dates for reports presented in 40 CFR part 63, subpart SS and this subpart, reports shall be submitted according to the due dates presented in this subpart.

(viii) When there are conflicts between the recordkeeping and reporting requirements presented in 40 CFR part 63, subpart SS and this subpart, the owner or operator shall either follow both sets of requirements (i.e., follow the requirements in 40 CFR part 63, subpart SS for emission points covered by 40 CFR part 63, subpart SS and follow the requirements of this subpart for emission points covered by this subpart) or shall follow the set of requirements they prefer. If an owner or operator chooses to follow just one set of requirements, the owner or operator shall identify which set of requirements are being followed and which set of requirements are being disregarded in the appropriate report.

(3) Reduce emissions to less than or equal to 0.95 kg of total organic HAP per megagram (1.9 pounds of total organic HAP per ton) of resin produced, or to a concentration of 20 ppmv when using a combustion control device or to a concentration of 50 ppmv when using a non-combustion control device, whichever is less stringent.

(b) *Alternative standard.* Vent all organic HAP emissions from a continuous process vent meeting the TRE value specified in paragraph (a) of this section to a combustion control device achieving an outlet organic HAP concentration of 20 ppmv or less or to a non-combustion control device achieving an outlet organic HAP concentration of 50 ppmv or less. Any continuous process vents that are not vented to a control device meeting these conditions shall be controlled in accordance with the provisions of paragraphs (a)(1), (2), or (3) of this section, as appropriate.

[65 FR 3290, Jan. 20, 2000, as amended at 79 FR 60930, Oct. 8, 2014]

### **§63.1406 Reactor batch process vent provisions.**

(a) *Emission standards.* Owners or operators of reactor batch process vents located at new or existing affected sources shall comply with paragraph (a)(1) or (2) of this section, as appropriate. As an alternative to complying with paragraph (a) of this section, an owner or operator may comply with paragraph (b) of this section.

(1) The owner or operator of a reactor batch process vent located at a new affected source shall control organic HAP emissions by complying with either paragraph (a)(1)(i), (ii), or (iii) of this section.

(i) Vent all emissions of organic HAP to a flare.

(ii) Reduce organic HAP emissions for the batch cycle by 95 weight percent using a control device or control technology.

(iii) Reduce organic HAP emissions from the collection of all reactor batch process vents within the affected source, as a whole, to 0.0045 kilogram of organic HAP per megagram of product or less for solvent-based resin production, or to 0.0004 kilogram of organic HAP per megagram of product or less for non-solvent-based resin production.

(2) The owner or operator of a reactor batch process vent located at an existing affected source shall control organic HAP emissions by complying with either paragraph (a)(2)(i), (ii), or (iii) of this section.

(i) Vent all emissions of organic HAP to a flare.

(ii) Reduce organic HAP emissions for the batch cycle by 83 weight percent using a control device or control technology.

(iii) Reduce organic HAP emissions from the collection of all reactor batch process vents within the affected source, as a whole, to 0.0567 kilogram of organic HAP per megagram of product or less for solvent-based resin production, or to 0.0057 kilogram of organic HAP per megagram of product or less for non-solvent-based resin production.

(b) *Alternative standard.* Vent all organic HAP emissions from a reactor batch process vent to a combustion control device achieving an outlet organic HAP concentration of 20 ppmv or less or to a non-combustion control device achieving an outlet organic HAP concentration of 50 ppmv or less. Any reactor batch process vents that are not vented to a control device meeting these conditions shall be controlled in accordance with the provisions of paragraph (a)(1)(ii), or paragraph (a)(2)(ii) of this section.

(c) *Use of boiler or process heater.* If a boiler or process heater is used to comply with the requirements of paragraph (a)(1)(i) or (ii), or paragraph (a)(2)(i) or (ii) of this section, the reactor batch process vent shall be introduced into the flame zone of such a device.

#### **§63.1407 Non-reactor batch process vent provisions.**

(a) *Emission standards.* (1) Owners or operators of non-reactor batch process vents located at new or existing affected sources with 0.25 tons per year (0.23 megagrams per year) of uncontrolled organic HAP emissions or greater from the collection of non-reactor batch process vents within the affected source shall comply with the requirements in paragraph (a)(2) or (3) of this section, as appropriate. As an alternative to complying with paragraph (a)(2) or (3) of this section, an owner or operator may comply with paragraph (b) of this section. Owners or operators shall determine uncontrolled organic HAP emissions from the collection of non-reactor batch process vents within the affected source as specified in paragraph (d) of this section. If the owner or operator finds that uncontrolled organic HAP emissions from the collection of non-reactor batch process vents within the affected source are less than 0.25 tons per year (0.23 megagrams per year), non-reactor batch process vents are not subject to the control requirements of this section. Further, the owner or operator shall, when requested by the Administrator, demonstrate that organic HAP emissions for the collection of non-reactor batch process vents within the affected source are less than 0.25 tons per year (0.23 megagrams per year).

(2) The owner or operator of a non-reactor batch process vent located at a new affected source shall:

(i) Vent all emissions of organic HAP to a flare; or

(ii) For the collection of non-reactor batch process vents within the affected source, reduce organic HAP emissions for the batch cycle by 76 weight percent using a control device or control technology.

(3) The owner or operator of a non-reactor batch process vent located at an existing affected source shall:

(i) Vent all emissions of organic HAP to a flare; or

(ii) For the collection of non-reactor batch process vents within the affected source, reduce organic HAP emissions for the batch cycle by 62 weight percent using a control device or control technology.

(b) *Alternative standard.* Comply with either paragraph (b)(1) or (2) of this section.

(1) *Control device outlet concentration.* Vent all organic HAP emissions from a non-reactor batch process vent to a combustion control device achieving an outlet organic HAP concentration of 20 ppmv or less or to a non-combustion control device achieving an outlet organic HAP concentration of 50 ppmv or less. Any reactor batch process vents that are not vented to a control device meeting these conditions shall be controlled in accordance with the provisions of paragraph (a)(2) or (3) of this section.

(2) *Mass emission limit.* Include the emissions from all non-reactor batch process vents in the compliance demonstration required for reactor batch process vents complying with the mass emission limits specified in §63.1406(a)(1)(iii) and (a)(2)(iii), as appropriate. This compliance option may only be used when the owner or operator has elected to comply with the mass emission limit for reactor batch process vents.

(c) *Use of boiler or process heater.* If a boiler or process heater is used to comply with paragraph (a)(2)(ii) or (a)(3)(ii) of this section, the reactor batch process vent shall be introduced into the flame zone of such a device.

(d) *Determining uncontrolled organic HAP emissions.* Owners or operators shall determine uncontrolled organic HAP emissions from the collection of non-reactor batch process vents within the affected source based on engineering assessment as described in §63.1414(d)(6).

### **§63.1408 Aggregate batch vent stream provisions.**

(a) *Emission standards.* Owners or operators of aggregate batch vent streams at a new or existing affected source shall comply with either paragraph (a)(1) or (2) of this section, as appropriate. As an alternative to complying with paragraph (a)(1) or (2) of this section, an owner or operator may comply with paragraph (b) of this section.

(1) The owner or operator of an aggregate batch vent stream located at a new affected source shall:

(i) Vent all emissions of organic HAP to a flare; or

(ii) Reduce organic HAP emissions by 95 weight percent or to a concentration of 20 ppmv when using a combustion control device or to a concentration of 50 ppmv when using a non-combustion control device, whichever is less stringent, on a continuous basis.

(2) The owner or operator of an aggregate batch vent stream located at an existing affected source shall:

(i) Vent all emissions of organic HAP to a flare; or

(ii) Reduce organic HAP emissions by 83 weight percent or to a concentration of 20 ppmv when using a combustion control device or to a concentration of 50 ppmv when using a non-combustion control device, whichever is less stringent, on a continuous basis.

(b) *Alternative standard.* Comply with either paragraph (b)(1) or (2) of this section.

(1) *Control device outlet concentration.* Vent all organic HAP emissions from an aggregate batch vent stream to a combustion control device achieving an outlet organic HAP concentration of 20 ppmv or less or to a non-combustion control device achieving an outlet organic HAP concentration of 50 ppmv or less. Any aggregate batch vent streams that are not vented to a control device meeting these conditions shall be controlled in accordance with the provisions of paragraphs (a)(1) or (a)(2) of this section.

(2) *Mass emission limit.* Include the emissions from all aggregate batch vent streams in the compliance demonstration required for reactor batch process vents complying with the mass emission limits specified in §63.1406(a)(1)(iii) and (a)(2)(iii), as appropriate. This compliance option may only be used when the owner or operator has elected to comply with the mass emission limit for reactor batch process vents.

#### **§63.1409 Heat exchange system provisions.**

(a) Unless one or more of the conditions specified in paragraphs (a)(1) through (6) of this section are met, owners and operators of sources subject to this subpart shall monitor each heat exchange system used to cool process equipment in an affected source, according to the provisions in either paragraph (b) or (c) of this section. Whenever a leak is detected, the owner or operator shall comply with the requirements in paragraph (d) of this section.

(1) The heat exchange system is operated with the minimum pressure on the cooling water side at least 35 kilopascals greater than the maximum pressure on the process side.

(2) There is an intervening cooling fluid, containing less than 5 percent by weight of total HAP listed in column A of Table 2 of this subpart, between the process and the cooling water. This intervening fluid serves to isolate the cooling water from the process fluid, and the intervening fluid is not sent through a cooling tower or discharged. For purposes of this section, discharge does not include emptying for maintenance purposes.

(3) The once-through heat exchange system is subject to a National Pollution Discharge Elimination System (NPDES) permit with an allowable discharge limit of 1 part per million or less above influent concentration or 10 percent or less above influent concentration, whichever is greater.

(4) The once-through heat exchange system is subject to an NPDES permit that:

(i) Requires monitoring of a parameter(s) or condition(s) to detect a leak of process fluids into cooling water;

(ii) Specifies or includes the normal range of the parameter or condition;

(iii) Requires monitoring for the parameters selected as leak indicators no less frequently than monthly for the first 6 months and quarterly thereafter; and

(iv) Requires the owner or operator to report and correct leaks to the cooling water when the parameter or condition exceeds the normal range.

(5) The recirculating heat exchange system is used to cool process fluids that contain less than 5 percent by weight of total HAP listed in column A of Table 2 of this subpart.

(6) The once-through heat exchange system is used to cool process fluids that contain less than 5 percent by weight of total HAP listed in column B of Table 2 of this subpart.

(b) The owner or operator who elects to comply with the requirements of paragraph (a) of this section by monitoring the cooling water for the presence of one or more organic HAP or other representative substances whose presence in cooling water indicate a leak shall comply with the requirements specified in paragraphs (b)(1) through (6) of this section. The cooling water shall be monitored for total HAP, total volatile organic compounds, total organic carbon, one or more speciated HAP compounds, or other representative substances that would indicate the presence of a leak in the heat exchange system.

(1) The cooling water shall be monitored monthly for the first 6 months and quarterly thereafter to detect leaks.

(2)(i) For recirculating heat exchange systems (cooling tower systems), the monitoring of speciated HAP or total HAP refers to the HAP listed in column A of Table 2 of this subpart.

(ii) For once-through heat exchange systems, the monitoring of speciated HAP or total HAP refers to the HAP listed in column B of Table 2 of this subpart.

(3) The concentration of the monitored substance(s) in the cooling water shall be determined using any EPA-approved method listed in part 136 of this chapter, as long as the method is sensitive to concentrations as low as 10 parts per million and the same method is used for both entrance and exit samples. Alternative methods may be used upon approval by the Administrator.

(4) The samples shall be collected either at the entrance and exit of each heat exchange system or at locations where the cooling water enters and exits each heat exchanger or any combination of heat exchangers.

(i) For samples taken at the entrance and exit of recirculating heat exchange systems, the entrance is the point at which the cooling water leaves the cooling tower prior to being returned to the process equipment, and the exit is the point at which the cooling water is introduced to the cooling tower after being used to cool the process fluid.

(ii) For samples taken at the entrance and exit of once-through heat exchange systems, the entrance is the point at which the cooling water enters, and the exit is the point at which the cooling water exits the plant site or chemical manufacturing process units.

(iii) For samples taken at the entrance and exit of each heat exchanger or any combination of heat exchangers, the entrance is the point at which the cooling water enters the individual heat exchanger or group of heat exchangers, and the exit is the point at which the cooling water exits the heat exchanger or group of heat exchangers.

(5) A minimum of three sets of samples shall be taken at each entrance and exit as defined in paragraph (b)(4) of this section. The average entrance and exit concentrations shall then be calculated. The concentration shall be corrected for the addition of any makeup water or for any evaporative losses, as applicable.

(6) A leak is detected if the exit mean concentration is found to be greater than the entrance mean concentration using a one-sided statistical procedure at the 0.05 level of significance, and the amount by which it is greater is at least 1 part per million or 10 percent of the entrance mean, whichever is greater.

(c) The owner or operator who elects to comply with the requirement of paragraph (a) of this section by monitoring using a surrogate indicator of heat exchange system leaks shall comply with the requirements specified in paragraphs (c)(1) through (3) of this section. Surrogate indicators that could be used to develop an acceptable monitoring program are ion specific electrode monitoring, pH, conductivity or other representative indicators.

(1) The owner or operator shall prepare and implement a monitoring plan that documents the procedures that will be used to detect leaks of process fluids into cooling water. The plan shall require monitoring of one or more surrogate indicators or monitoring of one or more process parameters or other conditions that indicate a leak. Monitoring that is already being conducted for other purposes may be used to satisfy the requirements of this section. The plan shall include the information specified in paragraphs (c)(1)(i) and (ii) of this section.

(i) A description of the parameter or condition to be monitored and an explanation of how the selected parameter or condition will reliably indicate the presence of a leak.

(ii) The parameter level(s) or conditions(s) that constitute a leak. This shall be documented by data or calculations showing that the selected levels or conditions will reliably identify leaks. The monitoring must be sufficiently sensitive to determine the range of parameter levels or conditions when the system is not leaking. When the selected parameter level or condition is outside that range, a leak is indicated.

(iii) The monitoring frequency which shall be no less frequent than monthly for the first 6 months and quarterly thereafter to detect leaks.

(iv) The records that will be maintained to document compliance with the requirements of this section.

(2) If a substantial leak is identified by methods other than those described in the monitoring plan and the method(s) specified in the plan could not detect the leak, the owner or operator shall revise the plan and document the basis for the changes. The owner or operator shall complete the revisions to the plan no later than 180 days after discovery of the leak.

(3) The owner or operator shall maintain, at all times, the monitoring plan that is currently in use. The current plan shall be maintained on-site, or shall be accessible from a central location by computer or other means that provides access within 2 hours after a request. If the monitoring plan is superseded, the owner or operator shall retain the most recent superseded plan at least until 5 years from the date of its creation. The superseded plan shall be retained on-site (or accessible from a central location by computer or other means that provides access within 2 hours after a request) for at least 6 months after its creation.

(d) If a leak is detected according to the criteria of paragraph (b) or (c) of this section, the owner or operator shall comply with the requirements in paragraphs (d)(1) and (2) of this section, except as provided in paragraph (e) of this section.

(1) The leak shall be repaired as soon as practical but not later than 45 calendar days after the owner or operator receives results of monitoring tests indicating a leak. The leak shall be repaired unless the owner or operator demonstrates that the results are due to a condition other than a leak.

(2) Once the leak has been repaired, the owner or operator shall confirm that the heat exchange system has been repaired within 7 calendar days of the repair or startup, whichever is later.



(e) Delay of repair of heat exchange systems for which leaks have been detected is allowed if the equipment is isolated from the process. Delay of repair is also allowed if repair is technically infeasible without a shutdown and any one of the conditions in paragraph (e)(1) or (2) of this section are met. All time periods in paragraphs (e)(1) and (2) of this section shall be determined from the date when the owner or operator determines that delay of repair is necessary.

(1) If a shutdown is expected within the next 2 months, a special shutdown before that planned shutdown is not required.

(2) If a shutdown is not expected within the next 2 months, the owner or operator may delay repair as provided in paragraph (e)(2)(i) or (ii) of this section. Documentation of a decision to delay repair shall state the reasons repair was delayed and shall specify a schedule for completing the repair as soon as practical.

(i) If a shutdown for repair would cause greater emissions than the potential emissions from delaying repair, the owner or operator may delay repair until the next shutdown of the process equipment associated with the leaking heat exchanger. The owner or operator shall document the basis for the determination that a shutdown for repair would cause greater emissions than the emissions likely to result from delaying repair as specified in paragraphs (e)(2)(i)(A) and (B) of this section.

(A) The owner or operator shall calculate the potential emissions from the leaking heat exchanger by multiplying the concentration of total HAP listed in column A of Table 2 of this subpart in the cooling water from the leaking heat exchanger by the flowrate of the cooling water from the leaking heat exchanger by the expected duration of the delay. The owner or operator may calculate potential emissions using total organic carbon concentration instead of total HAP listed in column A of Table 2 of this subpart.

(B) The owner or operator shall determine emissions from purging and depressurizing the equipment that will result from the unscheduled shutdown for the repair.

(ii) If repair is delayed for reasons other than those specified in paragraph (e)(2)(i) of this section, the owner or operator may delay repair up to a maximum of 120 calendar days. The owner shall demonstrate that the necessary parts or personnel were not available.

#### **§63.1410 Equipment leak provisions.**

The owner or operator of each affected source shall comply with the requirements of 40 CFR part 63, subpart UU for all equipment, as defined under §63.1402, that contains or contacts 5 weight-percent HAP or greater and operates 300 hours per year or more, except §63.1030. The weight-percent HAP is determined for equipment using the organic HAP concentration measurement methods specified in §63.1414(a). When complying with the requirements of 40 CFR part 63, subpart SS, as referred to by 40 CFR part 63, subpart UU, the following apply for purposes of this subpart:

(a) Design evaluations are allowed for control devices that control emission points with total emissions less than 10 tons of organic HAP per year before control (i.e., small control devices).

(b) When 40 CFR part 63, subpart SS refers to specific test methods for the measurement of organic HAP concentration, the test methods presented in §63.1414(a) shall be used.

(c) The option to measure TOC instead of organic HAP, as a basis for demonstrating compliance, is not allowed.

(d) Excused excursions are not allowed.

(e) The provisions in §63.1403(b), rather than the provisions in §63.982(f), are to be followed for combined vent streams.

(f) When a scrubber is used as a control device, the owner or operator shall follow the guidance provided in this subpart for design evaluations or performance tests, as appropriate, and for monitoring, recordkeeping, and reporting.

(g) When there are conflicts between the due dates for reports presented in 40 CFR part 63, subpart SS and this subpart, reports shall be submitted according to the due dates presented in this subpart.

(h) When there are conflicts between the recordkeeping and reporting requirements presented in 40 CFR part 63, subpart SS and this subpart, the owner or operator shall either follow both sets of requirements (i.e., follow the requirements in 40 CFR part 63, subpart SS for emission points covered by 40 CFR part 63, subpart SS and follow the requirements of this subpart for emission points covered by this subpart) or shall follow the set of requirements they prefer. If an owner or operator chooses to follow just one set of requirements, the owner or operator shall identify which set of requirements are being followed and which set of requirements are being disregarded in the appropriate report.

[65 FR 3290, Jan. 20, 2000, as amended at 79 FR 60930, Oct. 8, 2014]

#### **§63.1411 Requirements for pressure relief devices.**

Except as specified in paragraph (d) of this section, the owner or operator must comply with the requirements specified in paragraphs (a) and (b) of this section for pressure relief devices in organic HAP gas or vapor service. Except as specified in paragraph (d) of this section, the owner or operator must also comply with the requirements specified in paragraph (c) of this section for all pressure relief devices in organic HAP service.

(a) *Operating requirements.* Except during a pressure release event, operate each pressure relief device in organic HAP gas or vapor service with an instrument reading of less than 500 ppm above background as described in Method 21 of 40 CFR part 60, Appendix A.

(b) *Pressure release requirements.* For pressure relief devices in organic HAP gas or vapor service, the owner or operator must comply with either paragraph (b)(1) or (2) of this section following a pressure release, as applicable.

(1) If the pressure relief device does not consist of or include a rupture disk, conduct instrument monitoring, as described in Method 21 of 40 CFR part 60, appendix A, no later than 5 calendar days after the pressure relief device returns to organic HAP service following a pressure release to verify that the pressure relief device is operating with an instrument reading of less than 500 ppm above background, except as provided in §63.1024(d).

(2) If the pressure relief device consists of or includes a rupture disk, install a replacement disk as soon as practicable after a pressure release, but no later than 5 calendar days after the pressure release, except as provided in §63.1024(d).

(c) *Pressure release management.* Except as specified in paragraph (d) of this section, emissions of organic HAP to the atmosphere from pressure relief devices in organic HAP service are prohibited, and the owner or operator must comply with the requirements specified in paragraphs (c)(1) and (2) of this section for all pressure relief devices in organic HAP service.

(1) The owner or operator must equip each pressure relief device in organic HAP service with a device(s) or parameter monitoring system that is capable of:

(i) Identifying the pressure release;

(ii) Recording the time and duration of each pressure release; and

(iii) Notifying operators immediately that a pressure release is occurring. The device or monitoring system may be either specific to the pressure relief device itself or may be associated with the process system or piping sufficient to indicate a pressure release to the atmosphere. Examples of these types of devices and systems include, but are not limited to, a rupture disk indicator, magnetic sensor, motion detector on the pressure relief valve stem, flow monitor, or pressure monitor.

(2) If any pressure relief device in organic HAP service releases to atmosphere as a result of a pressure release event, the owner or operator must calculate the quantity of organic HAP released during each pressure release event and report this quantity as required in §63.1417(f)(13)(iii). Calculations may be based on data from the pressure relief device monitoring alone or in combination with process parameter monitoring data and process knowledge.

(d) *Pressure relief devices routed to a control device, process, fuel gas system, or drain system.* If a pressure relief device in organic HAP service is designed and operated to route all HAP emissions from pressure releases through a closed vent system to a control device or to a process, fuel gas system, or drain system, the owner or operator is not required to comply with paragraphs (a), (b), or (c) (if applicable) of this section for that pressure relief device. The fuel gas system or closed vent system and control device (if applicable) must meet the requirements of §63.1034, as applicable (except that the term "pressure relief devices" shall apply instead of the term "equipment leaks" in §63.1034). The drain system (if applicable) must meet the requirements of §63.136.

[79 FR 60930, Oct. 8, 2014]

#### **§63.1412 Continuous process vent applicability assessment procedures and methods.**

(a) *General.* The provisions of this section provide procedures and methods for determining the applicability of the control requirements specified in §63.1405 to continuous process vents.

(b) *Sampling sites.* Sampling sites shall be located as follows:

(1) *Sampling site location.* The sampling site for determining volumetric flow rate, regulated organic HAP concentration, total organic HAP, net heating value, and TRE index value, shall be after the final recovery device (if any recovery devices are present) but prior to the inlet of any control device that is present and prior to release to the atmosphere.

(2) *Sampling site selection method.* Method 1 or 1A of 40 CFR part 60, appendix A, as appropriate, shall be used for selection of the sampling site. No traverse site selection method is needed for process vents smaller than 0.33 foot (0.10 meter) in nominal inside diameter.

(c) *Applicability assessment requirement.* The organic HAP concentrations, volumetric flow rates, heating values, organic HAP emission rates, TRE index values, and engineering assessment control applicability assessment requirements are to be determined during maximum representative operating conditions for the process, except as provided in paragraph (d) of this section, or unless the Administrator specifies or approves alternate operating conditions. Operations during periods of malfunction shall not constitute representative conditions for the purpose of an applicability test.

(d) *Exceptions.* The owner or operator is not required to conduct a test that will cause any of the following situations:

(1) Causing damage to equipment;

(2) Necessitating that the owner or operator make a product that does not meet an existing specification for sale to a customer; or

(3) Necessitating that the owner or operator make a product in excess of demand.

(e) *Organic HAP concentration.* The organic HAP concentrations, used for TRE index value calculations in paragraph (j) of this section, shall be determined using the procedures specified in either §63.1414(a) or by using the engineering assessment procedures in paragraph (k) of this section.

(f) *Volumetric flow rate.* The volumetric flow rate shall be determined using the procedures specified in §63.1414(a), or by using the engineering assessment procedures in paragraph (k) of this section.

(g) *Heating value.* The net heating value shall be determined as specified in paragraphs (g)(1) and (2) of this section, or by using the engineering assessment procedures in paragraph (k) of this section.

(1) The net heating value of the continuous process vent shall be calculated using Equation 1:

$$H_T = K_1 \left( \sum_{j=1}^n D_j H_j \right) \quad [Eq. 1]$$

Where:

$H_T$  = Net heating value of the sample, megaJoules per standard cubic meter, where the net enthalpy per mole of process vent is based on combustion at 25 °C and 760 millimeters of mercury, but the standard temperature for determining the volume corresponding to 1 mole is 20 °C, as in the definition of  $Q_s$  (process vent volumetric flow rate).

$K_1$  = Constant,  $1.740 \times 10^{-7}$  (parts per million)<sup>-1</sup> (gram-mole per standard cubic meter) (megaJoules per kilocalorie), where standard temperature for (gram-mole per standard cubic meter) is 20 °C.

$D_j$  = Organic HAP concentration on a wet basis of compound j in parts per million, as measured by procedures indicated in paragraph (e) of this section. For process vents that pass through a final stream jet and are not condensed, the moisture is assumed to be 2.3 percent by volume.

$H_j$  = Net heat of combustion of compound j, kilocalorie per gram-mole, based on combustion at 25 °C and 760 millimeters of mercury.

(2) The molar composition of the process vent ( $D_j$ ) shall be determined using the methods specified in paragraphs (g)(2)(i) through (iii) of this section:

(i) The methods specified in §63.1414(a) to measure the concentration of each organic compound.

(ii) American Society for Testing and Materials D1946-90 to measure the concentration of carbon monoxide and hydrogen.

(iii) Method 4 of 40 CFR part 60, appendix A to measure the moisture content of the stack gas.

(h) *Organic HAP emission rate.* The emission rate of organic HAP in the continuous process vent, as required by the TRE index value equation specified in paragraph (j) of this section, shall be calculated using Equation 2:

$$E = K_2 \left( \sum_{j=1}^n C_j M_j \right) Q_s \quad [Eq. 2]$$

Where:

E = Emission rate of organic HAP in the sample, kilograms per hour.

$K_2$  = Constant,  $2.494 \times 10^{-6}$  (parts per million)<sup>-1</sup> (gram-mole per standard cubic meter) (kilogram/gram) (minutes/hour), where standard temperature for (gram-mole per standard cubic meter) is 20 °C.

n = Number of components in the sample.

$C_j$  = Organic HAP concentration on a dry basis of organic compound j in parts per million as determined by the methods specified in paragraph (e) of this section.

$M_j$  = Molecular weight of organic compound j, gram/gram-mole.

$Q_s$  = Continuous process vent flow rate, dry standard cubic meter per minute, at a temperature of 20 °C.

(i) [Reserved]

(j) *TRE index value.* The owner or operator shall calculate the TRE index value of the continuous process vent using the equations and procedures in this paragraph, as applicable, and shall maintain records specified in §63.1416(f).

(1) *TRE index value equation.* The equation for calculating the TRE index value is Equation 3:

$$TRE = 1/E_{HAP} * [A + B(Q_s) + C(H_T)] \quad [Eq. 3]$$

Where:

TRE = TRE index value.

A, B, C = Coefficients presented in table 7 of this subpart.

$E_{HAP}$  = Emission rate of total organic HAP, kilograms per hour, as calculated according to paragraph (h) or (k) of this section.

$Q_s$  = Continuous process vent volumetric flow rate, standard cubic meters per minute, at a standard temperature of 20 °C, as calculated according to paragraph (f) or (k) of this section.

$H_T$  = Continuous process vent net heating value, megaJoules per standard cubic meter, as calculated according to paragraph (g) or (k) of this section.

(2) *TRE index calculation.* The owner or operator of a continuous process vent shall calculate the TRE index value by using the equation and appropriate coefficients in Table 6 of this subpart. The owner or operator shall calculate the TRE index value for each control device scenario (i.e., flare, thermal incinerator with 0 percent recovery, thermal incinerator with 70 percent recovery). The lowest TRE index value is to be compared to the applicability criteria specified in §63.1405(a).

(k) *Engineering assessment.* For purposes of TRE index value determinations, engineering assessments may be used to determine continuous process vent flow rate, net heating value, and total organic HAP emission rate for the representative operating condition expected to yield the lowest TRE index value. Engineering assessments shall meet the requirements of paragraphs (k)(1) through (4) of this section.

(1) If the TRE index value calculated using engineering assessment is greater than 4.0, the owner or operator is not required to perform the measurements specified in paragraphs (e) through (h) of this section.

(2) If the TRE index value calculated using engineering assessment is less than or equal to 4.0, the owner or operator is required either to perform the measurements specified in paragraphs (e) through (h) of this section for control applicability assessment or comply with the control requirements specified in §63.1405.

(3) Engineering assessment includes, but is not limited to, the following examples:

(i) Previous test results, provided the tests are representative of current operating practices.

(ii) Bench-scale or pilot-scale test data representative of the process under representative operating conditions.

(iii) Maximum volumetric flow rate, organic HAP emission rate, organic HAP concentration, or net heating value limit specified or implied within a permit limit applicable to the continuous process vent.

(iv) Design analysis based on accepted chemical engineering principles, measurable process parameters, or physical or chemical laws or properties. Examples of analytical methods include, but are not limited to, the following:

(A) Use of material balances based on process stoichiometry to estimate maximum organic HAP concentrations;

(B) Estimation of maximum volumetric flow rate based on physical equipment design such as pump or blower capacities;

(C) Estimation of organic HAP concentrations based on saturation conditions; and

(D) Estimation of maximum expected net heating value based on the stream concentration of each organic compound.

[65 FR 3290, Jan. 20, 2000, as amended at 79 FR 60931, Oct. 8, 2014]

### **§63.1413 Compliance demonstration procedures.**

(a) *General.* For each emission point, the owner or operator shall meet three stages of compliance, with exceptions specified in this subpart. First, the owner or operator shall conduct a performance test or design evaluation to demonstrate the performance of the control device or control technology being used. Second, the owner or operator shall meet the requirements for demonstrating initial compliance (e.g., a demonstration that the required percent reduction is achieved). Third, the owner or operator shall meet the requirements for demonstrating continuous compliance through some form of monitoring (e.g., continuous monitoring of operating parameters).

(1) *Large control devices and small control devices.* A large control device is a control device that controls emission points with total emissions of 10 tons of organic HAP per year or more before control. A small control device is a control device that controls emission points with total emissions less than 10 tons of organic HAP per year before control.

(i) *Large control devices.* Owners or operators are required to conduct a performance test for a large control device. The establishment of parameter monitoring levels shall be based on data obtained during the required performance test.

(ii) *Small control devices.* Owners or operators are required to conduct a design evaluation for a small control device. An owner or operator may choose to conduct a performance test for a small control device and such a performance test shall follow the procedures specified in this section, as appropriate. Whenever a small control device becomes a large control device, the owner or operator shall conduct a performance test following the procedures specified in this section, as appropriate. Notification that such a performance test is required, the site-specific test plan, and the results of the performance test shall be provided to the Administrator as specified in §63.1417. Except as provided in §63.1415(a)(2), the parameter monitoring levels for small control devices shall be set based on the design evaluation required by paragraph (a)(3) of this section. Further, when setting the parameter monitoring level(s) based on the design evaluation, the owner or operator shall submit the information specified in §63.1417(d)(7) for review and approval as part of the Precompliance Report.

(2) *Performance tests.* Performance tests shall be conducted under such conditions as the Administrator specifies to the owner or operator based on representative performance of the affected source for the period being tested and in accordance with the General Provisions at §63.7(a)(1), (a)(3), (d), (e)(2), (e)(4), (g), and (h), with the exceptions specified in paragraph (a)(1) of this section. Representative conditions exclude periods of startup and shutdown unless specified by the Administrator or an applicable subpart. The owner or operator may not conduct performance tests during periods of malfunction. The owner or operator must record the process information that is necessary to document operating conditions during the test and include in such record an explanation to support that such conditions represent normal operation. Upon request, the owner or operator shall make available to the Administrator such records as may be necessary to determine the conditions of performance tests. Data shall be reduced in accordance with the EPA approved methods specified in this subpart or, if other test methods are used, the data and methods shall be validated according to the protocol in Method 301 of Appendix A of this part.

(i) *Additional control devices not requiring performance tests.* An owner or operator is not required to conduct a performance test when using one of the following control devices:

(A) A boiler or process heater with a design heat input capacity of 44 megawatts or greater.

(B) A boiler or process heater into which the vent stream is introduced with the primary fuel or is used as the primary fuel.

(C) A boiler or process heater burning hazardous waste for which the owner or operator:

(1) Has been issued a final permit under 40 CFR part 270 and complies with the requirements of 40 CFR part 266, subpart H; or

(2) Has certified compliance with the interim status requirements of 40 CFR part 266, subpart H.

(D) A hazardous waste incinerator for which the owner or operator has been issued a final permit under 40 CFR part 270 and complies with the requirements of 40 CFR part 264, subpart O, or has certified compliance with the interim status requirements of 40 CFR part 265, subpart O.

(E) A control device for which a performance test was already conducted for determining compliance with another regulation promulgated by the EPA, provided the test was conducted using the same Methods specified in this section, and either no deliberate process changes have been made since the test, or the owner or operator can demonstrate that the results of the performance test, with or without adjustments, reliably demonstrate compliance despite process changes. Parameter monitoring levels

established based on such a performance test may be used for purposes of demonstrating continuous compliance with this subpart.

(ii) *Exceptions to performance test requirements in the General Provisions.* (A) Performance tests shall be conducted at maximum representative operating conditions achievable during either the 6-month period ending 2 months before the Notification of Compliance Status required by §63.1417(e) is due, or during the 6-month period surrounding the date of the performance test (i.e., the period beginning 3 months prior to the performance test and ending 3 months after the performance test). In achieving maximum representative operating conditions, an owner or operator is not required to cause damage to equipment, make a product that does not meet an existing specification for sale to a customer, or make a product in excess of demand.

(B) When §63.7(g) references the Notification of Compliance Status requirements in §63.9(h), the requirements in §63.1417(e) shall apply for purposes of this subpart.

(C) Performance tests shall be performed no later than 150 days after the compliance dates specified in this subpart (i.e., in time for the results to be included in the Notification of Compliance Status), rather than according to the time periods in §63.7(a)(2).

(3) *Design evaluations.* To demonstrate the organic HAP removal efficiency for a control device or control technology, a design evaluation shall address the composition and organic HAP concentration of the vent stream(s) entering the control device or control technology, the operating parameters of the control device or control technology, and other conditions or parameters that reflect the performance of the control device or control technology. A design evaluation also shall address other vent stream characteristics and control device operating parameters as specified in any one of paragraphs (a)(3)(i) through (vi) of this section, depending on the type of control device that is used. If the vent stream(s) is not the only inlet to the control device, the efficiency demonstration also shall consider all other vapors, gases, and liquids, other than fuels, received by the control device.

(i) For a scrubber, the design evaluation shall consider the vent stream composition, constituent concentrations, liquid-to-vapor ratio, scrubbing liquid flow rate and concentration, temperature, and the reaction kinetics of the constituents with the scrubbing liquid. The design evaluation shall establish the design exhaust vent stream organic compound concentration level and include the additional information in paragraphs (a)(3)(i)(A) and (B) of this section for trays and a packed column scrubber:

(A) Type and total number of theoretical and actual trays; and

(B) Type and total surface area of packing for entire column, and for individual packed sections if column contains more than one packed section.

(ii) For a condenser, the design evaluation shall consider the vent stream flow rate, relative humidity, and temperature and shall establish the design outlet organic HAP compound concentration level, design average temperature of the condenser exhaust vent stream, and the design average temperatures of the coolant fluid at the condenser inlet and outlet. The temperature of the gas stream exiting the condenser shall be measured and used to establish the outlet organic HAP concentration.

(iii) For a carbon adsorption system that regenerates the carbon bed directly onsite in the control device, such as a fixed-bed adsorber, the design evaluation shall consider the vent stream flow rate, relative humidity, and temperature and shall establish the design exhaust vent stream organic compound concentration level, adsorption cycle time, number and capacity of carbon beds, type and working capacity of activated carbon used for carbon beds, design total regeneration stream mass or volumetric flow over the period of each complete carbon bed regeneration cycle, design carbon bed temperature after regeneration, design carbon bed regeneration time, and design service life of carbon. For vacuum desorption, the pressure drop shall be included.



(iv) For a carbon adsorption system that does not regenerate the carbon bed directly onsite in the control device, such as a carbon canister, the design evaluation shall consider the vent stream mass or volumetric flow rate, relative humidity, and temperature and shall establish the design exhaust vent stream organic compound concentration level, capacity of carbon bed, type and working capacity of activated carbon used for carbon bed, and design carbon replacement interval based on the total carbon working capacity of the control device and source operating schedule.

(v) For an enclosed combustion device with a minimum residence time of 0.5 seconds and a minimum temperature of 760 C, the design evaluation shall document that these conditions exist.

(vi) For a combustion control device that does not satisfy the criteria in paragraph (a)(3)(v) of this section, the design evaluation shall address the following characteristics, depending on the type of control device:

(A) For a thermal vapor incinerator, the design evaluation shall consider the autoignition temperature of the organic HAP, shall consider the vent stream flow rate, and shall establish the design minimum and average temperature in the combustion zone and the combustion zone residence time.

(B) For a catalytic vapor incinerator, the design evaluation shall consider the vent stream flow rate and shall establish the design minimum and average temperatures across the catalyst bed inlet and outlet.

(C) For a boiler or process heater, the design evaluation shall consider the vent stream flow rate, shall establish the design minimum and average flame zone temperatures and combustion zone residence time, and shall describe the method and location where the vent stream is introduced into the flame zone.

(4) *Establishment of parameter monitoring levels.* The owner or operator of a control device that has one or more parameter monitoring level requirements specified under this subpart, or specified under subparts referenced by this subpart, shall establish a maximum or minimum level, as denoted on Table 4 of this subpart, for each measured parameter using the procedures specified in paragraph (a)(4)(i) or (ii) of this section. Except as otherwise provided in this subpart, the owner or operator shall operate control devices such that the daily average, batch cycle daily average, or block average of monitored parameters, established as specified in this paragraph, remains above the minimum level or below the maximum level, as appropriate.

(i) *Establishment of parameter monitoring levels based on performance tests—(A) Emission points other than batch process vents.* During initial compliance testing, the appropriate parameter shall be continuously monitored during the required 1-hour test runs. The monitoring level(s) shall then be established as the average of the maximum (or minimum) point values from the three test runs. The average of the maximum values shall be used when establishing a maximum level, and the average of the minimum values shall be used when establishing a minimum level.

(B) *Aggregate batch vent streams.* For aggregate batch vent streams the monitoring level shall be established in accordance with paragraph (a)(4)(i)(A) of this section.

(C) *Batch process vents.* The monitoring level(s) shall be established using the procedures specified in paragraphs (a)(4)(i)(C)(1) or (2) of this section. For batch process vents complying with the percent reduction standards specified in §63.1406 or §63.1407, parameter monitoring levels shall be established by the design evaluation, or during the performance test so that the specified percent reduction from §63.1406 or §63.1407, as appropriate, is met.

(1) If more than one batch emission episode or more than one portion of a batch emission episode has been selected to be controlled, a single level for the batch cycle shall be calculated as follows:

(i) During initial compliance testing, the appropriate parameter shall be monitored continuously and recorded once every 15 minutes at all times when batch emission episodes, or portions thereof, selected to be controlled are vented to the control device. A minimum of three recorded values shall be obtained for each batch emission episode, or portion thereof, regardless of the length of time emissions are occurring.

(ii) The average monitored parameter value shall be calculated for each batch emission episode, or portion thereof, in the batch cycle selected to be controlled. The average shall be based on all values measured during the required performance test.

(iii) If the level to be established is a maximum operating parameter, the level shall be defined as the minimum of the average parameter values from each batch emission episode, or portion thereof, in the batch cycle selected to be controlled (i.e., identify the batch emission episode, or portion thereof, which requires the lowest parameter value in order to assure compliance; the average parameter value that is necessary to assure compliance for that batch emission episode, or portion thereof, shall be the level for all batch emission episodes, or portions thereof, in the batch cycle that are selected to be controlled).

(iv) If the level to be established is a minimum operating parameter, the level shall be defined as the maximum of the average parameter values from each batch emission episode, or portion thereof, in the batch cycle selected to be controlled (i.e., identify the batch emission episode, or portion thereof, which requires the highest parameter value in order to assure compliance; the average parameter value that is necessary to assure compliance for that batch emission episode, or portion thereof, shall be the level for all batch emission episodes, or portions thereof, in the batch cycle that are selected to be controlled).

(v) Alternatively, an average monitored parameter value shall be calculated for the entire batch cycle based on all values recorded during each batch emission episode, or portion thereof, selected to be controlled.

(2) Instead of establishing a single level for the batch cycle, as described in paragraph (a)(4)(i)(C)(1) of this section, an owner or operator may establish separate levels for each batch emission episode, or portion thereof, selected to be controlled. Each level shall be determined as specified in paragraphs (a)(4)(i)(C)(1)(i) through (v) of this section.

(3) The batch cycle shall be defined in the Notification of Compliance Status, as specified in §63.1417(e)(2). Said definition shall include an identification of each batch emission episode. The definition of batch cycle shall also include the information required to determine parameter monitoring compliance for partial batch cycles (i.e., when part of a batch cycle is accomplished during 2 different operating days) for those parameters averaged on a batch cycle daily average basis.

(ii) *Establishment of parameter monitoring levels based on performance tests, engineering assessments, and/or manufacturer's recommendations.* Parameter monitoring levels may be established based on the parameter values measured during the performance test supplemented by engineering assessments and/or manufacturer's recommendations. Performance testing is not required to be conducted over the entire range of expected parameter values. When setting the parameter monitoring level(s) using the procedures specified in this paragraph, the owner or operator shall submit the information specified in §63.1417(d)(7) for review and approval as part of the Precompliance Report.

(b) *Initial and continuous compliance for storage vessels.* (1) Initial compliance with the percent reduction standard specified in §63.1404(a)(1) shall be demonstrated following the procedures in 40 CFR part 63, subpart SS.

(2) Initial compliance with the work practice standard specified in §63.1404(a)(2) shall be demonstrated following the procedures in 40 CFR part 63, subpart WW.

(3) Continuous compliance with the percent reduction standard specified in §63.1404(a)(1) shall be demonstrated following the procedures in 40 CFR part 63, subpart SS.

(4) Continuous compliance with the work practice standard specified in §63.1404(a)(2) shall be demonstrated following the procedures in 40 CFR part 63, subpart WW.

(5) Initial and continuous compliance with the alternative standard specified in §63.1404(b) shall be demonstrated following the procedures in paragraph (f) of this section.

(c) *Initial and continuous compliance for continuous process vents.* (1) Initial compliance with the percent reduction standard specified in §63.1405(a)(2) shall be demonstrated following the procedures in 40 CFR part 63, subpart SS.

(2) Initial compliance with §63.1405(a)(1) (venting of emissions to a flare) shall be demonstrated following the procedures specified in paragraph (g) of this section.

(3) Continuous compliance with the percent reduction standard specified in §63.1405(a)(2) shall be demonstrated following the procedures in 40 CFR part 63, subpart SS.

(4) Continuous compliance with §63.1405(a)(1) (venting of emissions to a flare) shall be demonstrated following the continuous monitoring procedures specified in §63.1415.

(5) Initial and continuous compliance with the emission limit specified in §63.1405(a)(3) shall be demonstrated following the procedures in paragraph (h) of this section.

(6) Initial and continuous compliance with the alternative standard specified in §63.1405(b) shall be demonstrated following the procedures in paragraph (f) of this section.

(d) *Initial and continuous compliance for aggregate batch vent streams.* (1) Initial compliance with the percent reduction standard specified in §63.1408(a)(1)(ii) and (2)(ii) shall be demonstrated following the procedures for continuous process vents specified in paragraph (c)(1) of this section.

(2) Initial compliance with §63.1408(a)(1)(i) and (2)(i) (venting of emissions to a flare) shall be demonstrated following the procedures specified in paragraph (g) of this section.

(3) Continuous compliance with the percent reduction standard specified in §63.1408(a)(1)(ii) and (2)(ii) shall be demonstrated following the procedures for continuous process vents specified in paragraph (c)(3) of this section.

(4) Continuous compliance with §63.1408(a)(1)(i) and (a)(2)(i) (venting of emissions to a flare) shall be demonstrated following the continuous monitoring procedures specified in §63.1415.

(5) Initial and continuous compliance with the alternative standard specified in §63.1408(b)(1) shall be demonstrated following the procedures in paragraph (f) of this section.

(6) Initial and continuous compliance with the mass emission limit specified in §63.1408(b)(2) shall be demonstrated following the procedures in paragraph (e)(2) of this section.

(e) *Initial and continuous compliance for batch process vents—(1) Compliance with percent reduction standards.* Owners or operators opting to comply with the percent reduction standards specified in §63.1406(a)(1)(ii) and (a)(2)(ii) or §63.1407(a)(2)(ii) and (a)(3)(ii) shall select portions of the batch process vent emissions (i.e., select batch emission episodes or portions of batch emission episodes) to be controlled such that the specified percent reduction is achieved for the batch cycle. Paragraphs

(e)(1)(i) and (ii) of this section specify how the performance of a control device or control technology is to be determined. Paragraph (e)(1)(iii) of this section specifies how to demonstrate that the required percent emission reduction is achieved for the batch cycle.

(i) *Design evaluation.* The design evaluation shall comply with the provisions in paragraph (a)(3) of this section. The design evaluation shall include the value(s) and basis for the parameter monitoring level(s) required by §63.1415. The design evaluation shall determine either of the following:

(A) *Each batch emission episode.* The control device efficiency for each batch emission episode that the owner or operator selects to control.

(B) *One or more representative batch emission episodes.* The control device efficiency for one or more batch emission episodes provided that the owner or operator demonstrates that the control device achieves the same or higher efficiency for all other batch emission episodes that the owner or operator selects to control.

(ii) *Performance test.* An owner or operator shall conduct performance tests following the procedures in paragraph (e)(1)(ii)(A) of this section, the procedures in paragraph (e)(1)(ii)(B) of this section, or a combination of the two procedures. Under paragraph (e)(1)(ii)(A) of this section, a performance test is conducted for each batch emission episode selected for control. Under paragraph (e)(1)(ii)(B) of this section, an owner or operator groups together several batch emission episodes and conducts a single performance test for the batch emission episode that is the most challenging, in terms of achieving emission reductions, for the control device or control technology; thereby demonstrating that the achieved emission reduction for the tested batch emission episode is the minimum control device or control technology performance expected for each batch emission episode in the group. An owner or operator may use the concept provided by paragraph (e)(1)(ii)(B) of this section for several different groups of batch emission episodes.

(A) *Testing each batch emission episode.* A performance test shall be performed for each batch emission episode, or portion thereof, that the owner or operator selects to control. Performance tests shall be conducted using the testing procedures specified in §63.1414(a) and (b) and the following procedures:

(1) Only one test (i.e., only one run) is required for each batch emission episode selected by the owner or operator for control.

(2) Except as specified in paragraph (e)(1)(ii)(A)(3) of this section, the performance test shall be conducted over the entire period of emissions selected by the owner or operator for control.

(3) An owner or operator may choose to test only those periods of the batch emission episode during which the emission rate for the entire batch emission episode can be determined or during which the organic HAP emissions are greater than the average emission rate of the batch emission episode. The owner or operator choosing either of these options shall develop an emission profile illustrating the emission rate (kilogram per unit time) over the entire batch emission episode, based on either process knowledge or test data, to demonstrate that test periods are representative. Examples of information that could constitute process knowledge include calculations based on material balances and process stoichiometry. Previous test results may be used to develop the emission profile provided the results are still relevant to the current batch process vent conditions. The emission profile shall be included in the site-specific test plan required by §63.1417(h)(2).

(4) When choosing sampling sites using the methods specified in §63.1414(a)(1), inlet sampling sites shall be located as specified in paragraphs (e)(1)(ii)(A)(4)(i) and (ii) of this section. Outlet sampling sites shall be located at the outlet of the control device prior to release to the atmosphere.

(i) The control device inlet sampling site shall be located at the exit from the batch unit operation after any condensers operating as process condensers and before any control device.

(ii) If a batch process vent is introduced with the combustion air or as a secondary fuel into a boiler or process heater with a design capacity less than 44 megawatts, selection of the location of the inlet sampling sites shall ensure the measurement of total organic HAP concentrations in all batch process vents and primary and secondary fuels introduced into the boiler or process heater.

(B) *Testing only the most challenging batch emission episode.* Under this paragraph, an owner or operator groups together several batch emission episodes and conducts a single performance test for the batch emission episode that is the most challenging, in terms of achieving emission reductions, for the control device or control technology; thereby demonstrating that the achieved emission reduction for the tested batch emission episode is the minimum control device or control technology performance expected for each batch emission episode in the group. The owner or operator shall use the control device efficiency determined from the performance test for all the other batch emission episodes in that group for purposes of paragraph (e)(2)(iii) of this section. Performance tests shall be conducted using the testing procedures specified in §63.1414(a) and (b) and the following procedures:

(1) The procedures specified in paragraphs (e)(2)(ii)(A)(2) through (4) of this section.

(2) Develop an emission profile illustrating the emission rate (kilogram/unit time) for each period of emissions to be addressed by the performance test. The emission profile shall be based on either process knowledge or test data. Examples of information that could constitute process knowledge include calculations based on material balances and process stoichiometry. Previous test results may be used to develop the emission profile provided the results are still relevant to the current batch process vent conditions. The emission profile shall be included in the site-specific test plan required by §63.1417(h)(2).

(3) Provide rationale for why the control device efficiency for all the other batch emission episodes in the group will be greater than or equal to the control device efficiency achieved during the tested period of the most challenging batch emission episode in the group, as specified in the Notification of Compliance Status Report required by §63.1417(e).

(iii) *Batch cycle percent reduction.* The percent reduction for the batch cycle for an individual reactor batch process vent and the overall percent reduction for the collection of non-reactor batch process vents within the affected source shall be determined using Equation 1 of this section and the control device efficiencies specified in paragraphs (e)(1)(iii)(A) through (C) of this section. All information used to calculate the batch cycle percent reduction for an individual reactor batch process vent, including a definition of the batch cycle identifying all batch emission episodes, shall be recorded as specified in §63.1416 (d)(1)(ii). All information used to calculate the overall percent reduction for the collection of non-reactor batch process vents within the affected source, including a list of all batch emission episodes from the collection of non-reactor batch process vents within the affected source, shall be recorded as specified in §63.1416 (d)(1)(ii). This information shall include identification of those batch emission episodes, or portions thereof, selected for control. This information shall include estimates of uncontrolled organic HAP emissions for those batch emission episodes, or portions thereof, that are not selected for control, determined as specified in paragraph (e)(2)(iii)(D) or (E) of this section.

$$PR = \frac{\sum_{i=1}^n E_{unc} + \sum_{i=1}^n E_{inlet,com} - \sum_{i=1}^n (1 - R) E_{inlet,com}}{\sum_{i=1}^n E_{unc} + \sum_{i=1}^n E_{inlet,com}} \quad (100) \quad [Eq. 1]$$

Where:

PR = Percent reduction.

$E_{unc}$  = Mass rate of total organic HAP for uncontrolled batch emission episode  $i$ , kg/hr.

$E_{inlet, con}$  = Mass rate of total organic HAP for controlled batch emission episode  $i$  at the inlet to the control device, kg/hr.

R = Control efficiency of control device as specified in paragraphs (e)(1)(iii)(A) through (e)(1)(iii)(C) of this section.  
The value of R may vary between batch emission episodes.

$n$  = Number of uncontrolled batch emission episodes, controlled batch emission episodes, and control devices. The value of  $n$  is not necessarily the same for these three items.

(A) When conducting a performance test, the control efficiency of the control device shall be determined following the procedures in §63.1414(b)(4).

(B) For combustion control devices listed in paragraphs (a)(2)(i)(A) and (B) of this section and for flares, the control efficiency in Equation 1 of this section shall be 98 percent.

(C) If a performance test is not required, the control efficiency shall be based on the design evaluation specified in paragraph (e)(1)(i) of this section.

(D) For batch process vents estimated through engineering assessment, as described in §63.1414(f)(6), to emit less than 10 tons per year of uncontrolled organic HAP emissions, the owner or operator may use in Equation 1 of this section the emissions determined using engineering assessment or may determine organic HAP emissions using any of the procedures specified in §63.1414(d).

(E) For batch process vents estimated through engineering assessment, as described in §63.1414(d)(6), to emit 10 tons per year or greater of uncontrolled organic HAP emissions, organic HAP emissions shall be estimated following the procedures specified in §63.1414(d).

(F) Owners or operators designating a condenser, sometimes operated as a process condenser, as a control device shall conduct inprocess recycling and follow the recordkeeping requirements specified in §63.1416(d)(1)(vi).

(iv) *Initial compliance with percent reduction standards.* Initial compliance with the percent reduction standards specified in §63.1406(a)(1)(ii) and (2)(ii) and §63.1407(a)(2)(ii) and (3)(ii) is achieved when the owner or operator demonstrates, following the procedures in paragraphs (e)(1)(i) through (iii) of this section, that the required percent reduction is achieved.

(v) *Continuous compliance with percent reduction standards.* Continuous compliance with the percent reduction standards specified in §63.1406(a)(1)(ii) and (2)(ii) and §63.1407(a)(2)(ii) and (3)(ii) shall be demonstrated following the continuous monitoring procedures specified in §63.1415.

(2) *Compliance with mass emission limit standards.* Each owner or operator shall determine initial and continuous compliance with the mass emission limits specified in §63.1406 (a)(1)(iii) and (a)(2)(iii), according to the following procedures, as appropriate:

(i) If production at an affected source is exclusively non-solvent-based amino/phenolic resin or is exclusively solvent-based amino/phenolic resin, or an owner or operator chooses to meet the non-solvent-based emission limit, the owner or operator shall demonstrate initial and continuous compliance as follows:

(A) *Initial compliance.* Initial compliance shall be based on the average of the first 6 monthly average emission rate data points. The 6-month average shall be compared to the mass emission limit specified in §63.1406 (a)(1)(iii) and (a)(2)(iii), as appropriate.

(B) *Continuous compliance.* For the first year of compliance, continuous compliance shall be based on a cumulative average monthly emission rate calculated each month based on the available monthly emission rate data points (e.g., 7 data points after 7 months of operation, 8 data points after 8 months of operation) beginning the first month after initial compliance is demonstrated. The first continuous compliance cumulative average monthly emission rate shall be calculated using the first 7 monthly average emission rate data points. After the first year of compliance, a 12-month rolling average monthly emission rate shall be calculated each month based on the previous 12 monthly emission rate data points. Continuous compliance shall be determined by comparing the cumulative average monthly emission rate or the 12-month rolling average monthly emission rate to the mass emission limit specified in §63.1406 (a)(1)(iii) and (a)(2)(iii), as appropriate.

(C) *Procedures to determine the monthly emission rate.* The monthly emission rate, kilograms of organic HAP per megagram of product, shall be determined at the end of each month using Equation 2 of this section:

$$ER = \frac{\sum_{i=1}^n E_i}{RP_m} \quad [\text{Eq. 2}]$$

Where:

ER = Emission rate of organic HAP from reactor batch process vents, kg of HAP/Mg product.

$E_i$  = Emission rate of organic HAP from reactor batch process vent  $i$  as determined using the procedures specified in paragraph (e)(2)(i)(C)(1) of this section, kg/month.

$RP_m$  = Amount of resin produced in one month as determined using the procedures specified in paragraph (e)(2)(i)(C)(4) of this section, Mg/month.

$n$  = Number of batch process vents.

(1) The monthly emission rate of organic HAP, in kilograms per month, from an individual batch process vent ( $E_i$ ) shall be determined using Equation 3 of this section. Once organic HAP emissions for a batch cycle ( $E_{\text{cycle}i}$ ) have been estimated, as specified in either paragraph (e)(2)(i)(C)(2) or (3) of this section, the owner or operator may use the estimated organic HAP emissions ( $E_{\text{cycle}i}$ ) to determine  $E_i$  using Equation 3 of this section until the estimated organic HAP emissions ( $E_{\text{cycle}i}$ ) are no longer representative due to a process change or other reasons known to the owner or operator. If organic HAP emissions for a batch cycle ( $E_{\text{cycle}i}$ ) are determined to no longer be representative, the owner or operator shall redetermine organic HAP emissions for the batch cycle ( $E_{\text{cycle}i}$ ) following the procedures in paragraph (e)(2)(i)(C)(2) or (3) of this section, as appropriate.

$$E_i = \sum_{i=1}^n (N_i) (E_{\text{cycle}i}) \quad [\text{Eq. 3}]$$

Where:

$E_i$  = Monthly emissions from a batch process vent, kg/month.

$N_i$  = Number of type  $i$  batch cycles performed monthly, cycles/month.

$E_{\text{cycle}i}$  = Emissions from the batch process vent associated with a single type  $i$  batch cycle, as determined using the procedures specified in either paragraph (e)(2)(i)(C)(2) or (3) of this section, kg/batch cycle.

$n$  = Number of different types of batch cycles that cause the emission of organic HAP from the batch process vent.

(2) For reactor batch process vents estimated through engineering assessment, as described in §63.1414(d)(6), to emit less than 10 tons per year of uncontrolled organic HAP emissions, the owner or operator may use the emissions determined using engineering assessment in Equation 3 of this section or may determine organic HAP emissions using any of the procedures specified in §63.1414(d). For reactor batch process vents estimated through engineering assessment, as described in §63.1414(d)(6), to emit 10 tons per year or greater of uncontrolled organic HAP emissions, uncontrolled organic HAP emissions from the batch emission episodes making up the batch cycle shall be estimated following the procedures specified in §63.1414(d).

(3) For reactor batch process vents vented to a control device or control technology, controlled organic HAP emissions shall be determined as follows:

(i) Uncontrolled organic HAP emissions shall be determined following the procedures in paragraph (e)(2)(i)(C)(2) of this section.

(ii) Control device or control technology efficiency shall be determined using the procedures in paragraph (e)(1)(i) of this section for small control devices or the procedures in paragraph (e)(1)(ii) of this section for large control devices.

(iii) Controlled organic HAP emissions shall be determined by applying the control device or control technology efficiency, determined in paragraph (e)(2)(i)(C)(3)(ii) of this section, to the uncontrolled organic HAP emissions, determined in paragraph (e)(2)(i)(C)(3)(i) of this section.

(4) The rate of resin produced,  $RP_m$  (Mg/month), shall be determined based on production records certified by the owner or operator to represent actual production for the month. A sample of the records selected by the owner or operator for this purpose shall be provided to the Administrator in the Precompliance Report as required by §63.1417(d).

(ii) If production at an affected source reflects a mix of solvent-based and non-solvent-based resin and the owner or operator does not choose to meet the non-solvent-based emission limit specified in §63.1406 (a)(1)(iii) or (a)(2)(iii), as applicable, the owner or operator shall demonstrate initial and continuous compliance as follows:

(A) *Procedures for determining a site-specific emission limit.* A site-specific emission limit shall be determined using Equation 4 of this section.

$$SSEL = \frac{(MGs * ELs) + (MGns * ELns)}{MGs + MGns} \quad [Eq. 4]$$

Where:

SSEL = Site specific emission limit, kg of organic HAP/Mg of product.

MGs = Megagrams of solvent-based resin product produced, megagrams.

MGns = Megagrams of non-solvent-based resin product produced, megagrams.

ELs = Emission limit for solvent-based resin product, kg organic HAP/Mg solvent-based resin product.



ELns = Emission limit for non-solvent-based resin product, kg organic HAP/Mg non-solvent-based resin product.

(B) *Initial compliance.* For purposes of determining initial compliance, the site-specific emission limit shall be based on production for the first 6 months beginning January 20, 2000 or the first 6 months after initial start-up, whichever is later. Using the site-specific emission limit, initial compliance shall be demonstrated using the procedures in paragraph (e)(2)(i)(A) of this section, as appropriate.

(C) *Continuous compliance.* For purposes of determining continuous compliance for the period of operation starting at the beginning of the 7th month and ending after the 12th month, the site-specific emission limit shall be determined each month based on production for the cumulative period. For purposes of determining continuous compliance after the first year of production, the site-specific emission limit shall be determined each month based on production for a 12-month rolling period. Using the site-specific emission limit, continuous compliance shall be demonstrated using the procedures in paragraph (e)(2)(i)(B) of this section, as appropriate.

(3) *Compliance by venting to a flare.* Initial compliance with the standards specified in §63.1406(a)(1)(i) and (a)(2)(i) and §63.1407(a)(2)(i) and (a)(3)(i) shall be demonstrated following the procedures specified in paragraph (g) of this section. Continuous compliance with these standards shall be demonstrated following the continuous monitoring procedures specified in §63.1415.

(4) *Compliance with alternative standard.* Initial and continuous compliance with the alternative standard specified in §§63.1406(b) and 63.1407(b)(1) shall be demonstrated following the procedures in paragraph (f) of this section.

(f) *Compliance with alternative standard.* Initial and continuous compliance with the alternative standards in §§63.1404(b), 63.1405(b), 63.1406(b), 63.1407(b)(1), and 63.1408(b)(1) are demonstrated when the daily average outlet organic HAP concentration is 20 ppmv or less when using a combustion control device or 50 ppmv or less when using a non-combustion control device. To demonstrate initial and continuous compliance, the owner or operator shall follow the test method specified in §63.1414(a)(6) and shall be in compliance with the monitoring provisions in §63.1415(e) no later than the initial compliance date and on each day thereafter.

(g) *Flare compliance demonstrations.* Notwithstanding any other provision of this subpart, if an owner or operator of an affected source uses a flare to comply with any of the requirements of this subpart, the owner or operator shall comply with paragraphs (g)(1) through (3) of this section. When using a flare to comply, the owner or operator is not required to conduct a performance test to determine percent emission reduction or outlet organic HAP concentration. If a compliance demonstration has been conducted previously for a flare, using the techniques specified in paragraphs (g)(1) through (3) of this section, that compliance demonstration may be used to satisfy the requirements of this paragraph if either no deliberate process changes have been made since the compliance demonstration, or the results of the compliance demonstration reliably demonstrate compliance despite process changes.

(1) Conduct a visible emission test using the techniques specified in §63.11(b)(4).

(2) Determine the net heating value of the gas being combusted using the techniques specified in §63.11(b)(6).

(3) Determine the exit velocity using the techniques specified in either §63.11(b)(7)(i) (and §63.11(b)(7)(iii), where applicable) or §63.11(b)(8), as appropriate.

(h) *Continuous process vent compliance at existing sources.* (1) Each owner or operator complying with the mass emission limit specified in §63.1405(a)(3) shall determine initial compliance as specified in paragraph (h)(1)(i) of this section and continuous compliance as specified in paragraph (h)(1)(ii) of this section.

(i) *Initial compliance.* Initial compliance shall be based on the average of the first 6 monthly average emission rate data points. The 6-month average shall be compared to the mass emission limit specified in §63.1405(a)(3).

(ii) *Continuous compliance.* For the first year of compliance, continuous compliance shall be based on a cumulative average monthly emission rate calculated each month based on the available monthly emission rate data points (e.g., 7 data points after 7 months of operation, 8 data points after 8 months of operation) beginning the first month after initial compliance is demonstrated. The first continuous compliance cumulative average monthly emission rate shall be calculated using the first 7 monthly average emission rate data points. After the first year of compliance, a 12-month rolling average monthly emission rate shall be calculated each month based on the previous 12 monthly emission rate data points. Continuous compliance shall be determined by comparing the cumulative average monthly emission rate or the 12-month rolling average monthly emission rate to the mass emission limit specified in §63.1405(a)(3).

(2) *Procedures to determine the monthly emission rate.* (i) The monthly emission rate, kilograms of organic HAP per megagram of product, shall be determined at the end of each month using Equation 5 of this section:

$$ER = \frac{E_i}{RP_m} \quad [\text{Eq. 5}]$$

Where:

ER = Emission rate of organic HAP from continuous process vent, kg of HAP/Mg product.

$E_i$  = Emission rate of organic HAP from continuous process vent  $i$  as determined using the procedures specified in paragraph (h)(2)(ii) of this section, kg/month.

$RP_m$  = Amount of resin produced in one month as determined using the procedures specified in paragraph (h)(2)(iii) of this section, Mg/month.

(ii) The monthly emission rate of organic HAP, in kilograms per month, from an individual continuous process vent ( $E_i$ ) shall be determined. Once organic HAP emissions have been estimated, as specified in paragraph (h)(2)(ii)(A) of this section for uncontrolled continuous process vents or paragraphs (h)(2)(ii)(A) and (B) of this section for continuous process vents vented to a control device or control technology, the owner or operator may use the estimated organic HAP emissions ( $E_i$ ) until the estimated organic HAP emissions are no longer representative due to a process change or other reason known to the owner or operator. If organic HAP emissions ( $E_i$ ) are determined to no longer be representative, the owner or operator shall redetermine organic HAP emissions for the continuous process vent following the procedures in paragraph (h)(2)(ii)(A) of this section for uncontrolled continuous process vents or paragraphs (h)(2)(ii)(A) and (B) of this section for continuous process vents vented to a control device or control technology.

(A) For continuous process vents estimated through engineering assessment, as described in §63.1414(d)(10), to emit less than 10 tons per year of uncontrolled organic HAP emissions, the owner or operator may use the emissions determined using engineering assessment in Equation 5 of this section or may determine organic HAP emissions using the procedures specified in paragraph (a)(1)(i) of this section. For continuous process vents estimated through engineering assessment, as described in §63.1414(d)(10), to emit 10 tons per year or greater of uncontrolled organic HAP emissions, uncontrolled organic HAP emissions shall be estimated following the procedures specified in paragraph (a)(1)(i) of this section.

(B) For continuous process vents vented to a control device or control technology, controlled organic HAP emissions shall be determined as follows:

(1) Uncontrolled organic HAP emissions shall be determined following the procedures in paragraph (h)(2)(ii)(A) of this section.

(2) Control device or control technology efficiency shall be determined using the procedures in paragraph (a)(1)(i) of this section for large control devices or the procedures in paragraph (a)(1)(ii) of this section for small control devices.

(3) Controlled organic HAP emissions shall be determined by applying the control device or control technology efficiency, determined in paragraph (h)(2)(ii)(B)(2) of this section, to the uncontrolled organic HAP emissions, determined in paragraph (h)(2)(ii)(B)(1) of this section.

(iii) The rate of resin produced,  $RP_M$  (Mg/month), shall be determined based on production records certified by the owner or operator to represent actual production for the month. A sample of the records selected by the owner or operator for this purpose shall be provided to the Administrator in the Precompliance Report as required by §63.1417(d).

(i) *Deviations.* Paragraphs (i)(1) through (4) of this section describe deviations from the emission limits, the operating limits, the work practice standards, and the emission standard, respectively. Paragraph (i)(5) of this section describes situations that are not deviations. Paragraph (i)(6) of this section describes periods that are excluded from compliance determinations.

(1) *Deviations from the emission limit.* The following are deviations from the emission limit:

(i) Exceedance of the condenser outlet gas temperature limit (i.e., having an average value higher than the established maximum level) monitored according to the provisions of §63.1415(b)(3);

(ii) Exceedance of the outlet concentration (i.e., having an average value higher than the established maximum level) monitored according to the provisions of §63.1415(b)(8);

(iii) Exceedance of the mass emission limit (i.e., having an average value higher than the specified limit) monitored according to the provisions of paragraph (e)(2) of this section; and

(iv) Exceedance of the organic HAP outlet concentration limit (i.e., having an average value higher than the specified limit) monitored according to the provisions of §63.1415(e).

(2) *Deviations from the operating limit.* Exceedance of the parameters monitored according to §63.1415(b)(1), (b)(2), and (b)(4) through (7) are considered deviations from the operating limit. An exceedance of the monitored parameter has occurred if:

(i) The parameter, averaged over the operating day or block, is below a minimum value established during the initial compliance demonstration; or (ii) The parameter, averaged over the operating day or block, is above the maximum value established during the initial compliance demonstration.

(3) *Deviations from the work practice standard.* If all flames at the pilot light of a flare are absent, there has been a deviation from the work practice standard.

(4) *Deviation from the emission standard.* If monitoring data are insufficient, as described in paragraphs (i)(4)(i) through (iii) of this section, there has been a deviation from the emission standard.

(i) The period of control device or control technology operation is 4 hours or greater in an operating day, and monitoring data are insufficient to constitute a valid hour of data, as defined in paragraph (i)(4)(iii) of this section, for at least 75 percent of the operating hours;

(ii) The period of control device or control technology operation is less than 4 hours in an operating day, and more than one of the hours during the period of operation does not constitute a valid hour of data due to insufficient monitoring data; and

(iii) Monitoring data are insufficient to constitute a valid hour of data, as used in paragraphs (i)(4)(i) and (ii) of this section, if measured values are unavailable for any of the 15-minute periods within the hour. For data compression systems approved under §63.1417(k)(3), monitoring data are insufficient to calculate a valid hour of data if there are less than four data measurements made during the hour.

(5) *Situations that are not deviations.* If any of the situations listed in paragraphs (i)(5)(i) or (ii) of this section occur, such situations shall not be considered to be deviations.

(i) Monitoring data cannot be collected during monitoring device calibration check or monitoring device malfunction; or

(ii) Monitoring data are not collected during periods of nonoperation of the affected source or portion thereof (resulting in cessation of the emissions to which the monitoring applies).

(6) *Periods not considered to be part of the period of control or recovery device operation.* The periods listed in paragraphs (i)(6)(i) and (ii) of this section are not considered to be part of the period of control or recovery device operation for purposes of determining averages or periods of control device or control technology operation.

(i) Monitoring system breakdowns, repairs, calibration checks, and zero (low-level) and high-level adjustments; or

(ii) Periods of nonoperation of the affected source (or portion thereof), resulting in cessation of the emissions to which the monitoring applies.

[65 FR 3290, Jan. 20, 2000, as amended at 65 FR 8768, Feb. 22, 2000; 71 FR 20460, Apr. 20, 2006; 79 FR 60931, Oct. 8, 2014]

#### **§63.1414 Test methods and emission estimation equations.**

(a) *Test methods.* When required to conduct a performance test, the owner or operator shall use the test methods specified in paragraphs (a)(1) through (6) of this section, except where another section of this subpart requires either the use of a specific test method or the use of requirements in another subpart containing specific test method requirements.

(1) Method 1 or 1A, 40 CFR part 60, appendix A, shall be used for selection of the sampling sites if the flow measuring device is a pitot tube, except that references to particulate matter in Method 1A do not apply for the purposes of this subpart. No traverse is necessary when Method 2A or 2D, 40 CFR part 60, appendix A is used to determine gas stream volumetric flow rate.

(2) Method 2, 2A, 2C, or 2D, 40 CFR part 60, appendix A, is used for velocity and volumetric flow rates.

(3) Method 3, 40 CFR part 60, appendix A, is used for gas analysis.

(4) Method 4, 40 CFR part 60, appendix A, is used for stack gas moisture.

(5) The following methods shall be used to determine the organic HAP concentration.

(i) Method 316 or Method 320, 40 CFR part 60, appendix A, shall be used to determine the concentration of formaldehyde.

(ii) Method 18, 40 CFR part 60, appendix A, shall be used to determine the concentration of all organic HAP other than formaldehyde.

(iii) Method 308, 40 CFR part 60, appendix A, may be used as an alternative to Method 18 to determine the concentration of methanol.

(6) When complying with the alternative standard, as specified in §63.1413(f), the owner or operator shall use a Fourier Transform Infrared Spectroscopy (FTIR) instrument following Method PS-15, 40 CFR part 60, appendix B.

(b) *Batch process vent performance testing procedures—(1) Average batch vent flow rate determination.* The average batch vent flow rate for a batch emission episode shall be calculated using Equation 1 of this section:

$$AFR_{episode} = \frac{\sum_{i=1}^n FR_i}{n} \quad [\text{Eq. 1}]$$

Where:

$AFR_{episode}$  = Average batch vent flow rate for the batch emission episode, scmm.

$FR_i$  = Volumetric flow rate for individual measurement  $i$ , taken every 15 minutes using the procedures in paragraph (a)(2) of this section, scmm.

$n$  = Number of flow rate measurements taken during the batch emission episode.

(2) *Average batch vent concentration determination using an integrated sample.* If an integrated sample is taken over the entire batch emission episode to determine the average batch vent concentration of total organic HAP, organic HAP emissions shall be calculated using Equation 2 of this section:

$$E_{episode} = K \left[ \sum_{j=1}^n (C_j)(M_j) \right] AFR(T_h) \quad [\text{Eq. 2}]$$

Where:

$E_{episode}$  = Emissions, kg/episode.

$K$  = Constant,  $2.494 \times 10^{-6}$  (ppmv)<sup>-1</sup> (gm-mole/scm) (kg/gm) (min/hr), where standard temperature is 20 °C.

$C_j$  = Average batch vent concentration of sample organic HAP component  $j$  of the gas stream, dry basis, ppmv.

$M_j$  = Molecular weight of sample organic HAP component  $j$  of the gas stream, gm/gm-mole.

$AFR$  = Average batch vent flow rate of gas stream, dry basis, scmm.

$T_h$  = Hours/episode.

$n$  = Number of organic HAP in stream.

(3) *Average batch vent concentration determination using grab samples.* If grab samples are taken to determine the average batch vent concentration of total organic HAP, organic HAP emissions shall be calculated as follows:

(i) For each measurement point, the emission rate shall be calculated using Equation 3 of this section:

$$E_{\text{point}} = K \left[ \sum_{j=1}^n C_j M_j \right] FR \quad [\text{Eq. 3}]$$

Where:

$E_{\text{point}}$  = Emission rate for individual measurement point, kg/hr.

$K$  = Constant,  $2.494 \times 10^{-6}$  (ppmv)<sup>-1</sup> (gm-mole/scm) (kg/gm) (min/hr), where standard temperature is 20 °C.

$C_j$  = Concentration of sample organic HAP component  $j$  of the gas stream, dry basis, ppmv.

$M_j$  = Molecular weight of sample organic HAP component  $j$  of the gas stream, gm/gm-mole.

$FR$  = Flow rate of gas stream for the measurement point, dry basis, scmm.

$n$  = Number of organic HAP in stream.

(ii) The organic HAP emissions per batch emission episode shall be calculated using Equation 4 of this section:

$$E_{\text{episode}} = (DUR) \left[ \sum_{i=1}^n \frac{E_i}{n} \right] \quad [\text{Eq. 4}]$$

Where:

$E_{\text{episode}}$  = Emissions, kg/episode.

$DUR$  = Duration of the batch emission episode, hr/episode.

$E_i$  = Emissions for measurement point  $i$ , kg/hr.

$n$  = Number of measurements.

(4) *Control device efficiency determination for a batch emission episode.* The control efficiency for the control device shall be calculated using Equation 5 of this section:

$$R = \frac{\sum_{i=1}^n E_{\text{inlet},i} - \sum_{i=1}^n E_{\text{outlet},i}}{\sum_{i=1}^n E_{\text{inlet},i}} (100) \quad [\text{Eq. 5}]$$

Where:

$R$  = Control efficiency of control device, percent.

$E_{inlet}$  = Mass rate of total organic HAP for batch emission episode  $i$  at the inlet to the control device as calculated under paragraph (b)(2) or (b)(3) of this section, kg/episode.

$E_{outlet}$  = Mass rate of total organic HAP for batch emission episode  $i$  at the outlet of the control device, as calculated under paragraph (b)(2) or (b)(3) of this section, kg/episode.

$n$  = Number of batch emission episodes in the batch cycle selected to be controlled.

(c) *Percent oxygen correction for combustion control devices.* If the control device is a combustion device, total organic HAP concentrations shall be corrected to 3 percent oxygen when supplemental combustion air is used to combust the emissions. The integrated sampling and analysis procedures of Method 3B, 40 CFR part 60, appendix A, shall be used to determine the actual oxygen concentration ( $\%O_{20}$ ). The samples shall be taken during the same time that the total organic HAP samples are taken. The concentration corrected to 3 percent oxygen ( $C_c$ ) shall be computed using Equation 6 of this section:

$$C_c = C_m \left( \frac{17.9}{20.9 - \%O_{2d}} \right) \quad [Eq. 6]$$

Where:

$C_c$  = Concentration of total organic HAP corrected to 3 percent oxygen, dry basis, ppmv.

$C_m$  = Total concentration of TOC in vented gas stream, average of samples, dry basis, ppmv.

$\%O_{2d}$  = Concentration of oxygen measured in vented gas stream, dry basis, percent by volume.

(d) *Uncontrolled organic HAP emissions.* Uncontrolled organic HAP emissions for individual reactor batch process vents or individual non-reactor batch process vents shall be determined using the procedures specified in paragraphs (d)(1) through (8) of this section. To estimate organic HAP emissions from a batch emissions episode, owners or operators may use either the emissions estimation equations in paragraphs (d)(1) through (4) of this section, or direct measurement as specified in paragraph (d)(5) of this section. Engineering assessment may be used to estimate organic HAP emissions from a batch emission episode only under the conditions described in paragraph (d)(6) of this section. In using the emissions estimation equations in paragraphs (d)(1) through (4) of this section, individual component vapor pressure and molecular weight may be obtained from standard references. Methods to determine individual HAP partial pressures in multicomponent systems are described in paragraph (d)(9) of this section. Other variables in the emissions estimation equations may be obtained through direct measurement, as defined in paragraph (d)(5) of this section; through engineering assessment, as defined in paragraph (d)(6)(ii) of this section; by process knowledge; or by any other appropriate means. Assumptions used in determining these variables shall be documented as specified in §63.1417. Once organic HAP emissions for the batch emission episode have been determined using either the emissions estimation equations, direct measurement, or engineering assessment, organic HAP emissions from a single batch cycle shall be calculated in accordance with paragraph (d)(7) of this section, and annual organic HAP emissions from the batch process vent shall be calculated in accordance with paragraph (d)(8) of this section.

(1) *Emissions from purging of empty vessels.* Organic HAP emissions from the purging of an empty vessel shall be calculated using Equation 7 of this section. Equation 7 of this section does not take into account evaporation of any residual liquid in the vessel:

$$E_{episode} = \frac{(V_{ves})(P)(MW_{wzvg})}{RT} (1 - 0.37^m) \quad [Eq. 7]$$

Where:

$E_{\text{episode}}$  = Emissions, kg/episode.

$V_{\text{ves}}$  = Volume of vessel, m<sup>3</sup>.

$P$  = Total organic HAP partial pressure, kPa.

$MW_{\text{wavg}}$  = Weighted average molecular weight of organic HAP in vapor, determined in accordance with paragraph (d)(4)(i)(D) of this section, kg/kmol.

$R$  = Ideal gas constant, 8.314 m<sup>3</sup>·kPa/kmol·K.

$T$  = Temperature of vessel vapor space, K.

$m$  = Number of volumes of purge gas used.

(2) *Emissions from purging of filled vessels.* Organic HAP emissions from the purging of a filled vessel shall be calculated using Equation 8 of this section:

$$E_{\text{episode}} = \frac{(y)(V_{dr})(P^2)(MW_{\text{wavg}})}{RT \left( P - \sum_{i=1}^n P_i x_i \right)} (T_m) \quad [\text{Eq. 8}]$$

Where:

$E_{\text{episode}}$  = Emissions, kg/episode.

$y$  = Saturated mole fraction of all organic HAP in vapor phase.

$V_{dr}$  = Volumetric gas displacement rate, m<sup>3</sup>/min.

$P$  = Pressure in vessel vapor space, kPa.

$MW_{\text{wavg}}$  = Weighted average molecular weight of organic HAP in vapor, determined in accordance with paragraph (d)(4)(i)(D) of this section, kg/kmol.

$R$  = Ideal gas constant, 8.314 m<sup>3</sup>·kPa/kmol·K.

$T$  = Temperature of vessel vapor space, K.

$P_i$  = Vapor pressure of individual organic HAP  $i$ , kPa.

$x_i$  = Mole fraction of organic HAP  $i$  in the liquid.

$n$  = Number of organic HAP in stream.

$T_m$  = Minutes/episode.

(3) *Emissions from vapor displacement.* Organic HAP emissions from vapor displacement due to transfer of material into or out of a vessel shall be calculated using Equation 9 of this section:

$$E_{\text{episode}} = \frac{(y)(V)(P)(MW_{\text{wavg}})}{RT} \quad [\text{Eq. 9}]$$

Where:

$E_{\text{episode}}$  = Emissions, kg/episode.



y = Saturated mole fraction of all organic HAP in vapor phase.

V = Volume of gas displaced from the vessel, m<sup>3</sup>.

P = Pressure in vessel vapor space, kPa.

MW<sub>wavg</sub> = Weighted average molecular weight of organic HAP in vapor, determined in accordance with paragraph (d)(4)(i)(D) of this section, kg/kmol.

R = Ideal gas constant, 8.314 m<sup>3</sup>·kPa/kmol·K.

T = Temperature of vessel vapor space, K.

(4) *Emissions from heating of vessels.* Organic HAP emissions caused by the heating of a vessel shall be calculated using the procedures in either paragraph (d)(4)(i),(ii), or (iii) of this section, as appropriate.

(i) If the final temperature to which the vessel contents is heated is lower than 50 K below the boiling point of the HAP in the vessel, then organic HAP emissions shall be calculated using the equations in paragraphs (d)(4)(i)(A) through (D) of this section.

(A) Organic HAP emissions caused by heating of a vessel shall be calculated using Equation 10 of this section. The assumptions made for this calculation are atmospheric pressure of 760 millimeters of mercury (mm Hg) and the displaced gas is always saturated with volatile organic compounds (VOC) vapor in equilibrium with the liquid mixture:

$$E_{\text{episode}} = \left[ \frac{\frac{\sum_{i=1}^n (P_i) T1}{101.325 - \sum_{i=1}^n (P_i) T1} + \frac{\sum_{i=1}^n (P_i) T2}{101.325 - \sum_{i=1}^n (P_i) T2}}{2} \right] * (\Delta\eta) \left[ \frac{(MW_{\text{wavg},T1} + MW_{\text{wavg},T2})}{2} \right] \quad [Eq. 10]$$

Where:

E<sub>episode</sub> = Emissions, kg/episode.

(P<sub>i</sub>)<sub>T1</sub>, (P<sub>i</sub>)<sub>T2</sub> = Partial pressure (kPa) of each organic HAP i in the vessel headspace at initial (T1) and final (T2) temperature.

n = Number of organic HAP in stream.

Δη = Number of kilogram-moles (kg-moles) of gas displaced, determined in accordance with paragraph (d)(4)(i)(B) of this section.

101.325 = Constant, kPa.

(MW<sub>wavg, T1</sub>), (MW<sub>wavg, T2</sub>) = Weighted average molecular weight of total organic HAP in the displaced gas stream, determined in accordance with paragraph (d)(4)(i)(D) of this section, kg/kmol.

(B) The moles of gas displaced, Δ, is calculated using Equation 11 of this section:

$$\Delta n = \frac{V_{fs}}{R} \left[ \left( \frac{Pa_1}{T_1} \right) - \left( \frac{Pa_2}{T_2} \right) \right] \quad [Eq. 11]$$

Where:

$\Delta n$  = Number of kg-moles of gas displaced.

$V_{fs}$  = Volume of free space in the vessel, m<sup>3</sup>.

R = Ideal gas constant, 8.314 m<sup>3</sup>·kPa/kmol·K.

$Pa_1$  = Initial noncondensable gas partial pressure in the vessel, kPa.

$Pa_2$  = Final noncondensable gas partial pressure in the vessel, kPa.

$T_1$  = Initial temperature of vessel, K.

$T_2$  = Final temperature of vessel, K.

(C) The initial and final pressure of the noncondensable gas in the vessel shall be calculated using Equation 12 of this section:

$$Pa = 101.325 - \sum_{i=1}^n (P_i) T \quad [Eq. 12]$$

Where:

Pa = Initial or final partial pressure of noncondensable gas in the vessel headspace, kPa.

101.325 = Constant, kPa.

$(P_i)_T$  = Partial pressure of each organic HAP i in the vessel headspace, kPa, at the initial or final temperature (T1 or T2).

n = Number of organic HAP in stream.

(D) The weighted average molecular weight of organic HAP in the displaced gas,  $MW_{wavg}$ , shall be calculated using Equation 13 of this section:

$$MW_{wavg} = \frac{\sum_{i=1}^n (\text{mass of } C)_i (\text{molecular weight of } C)_i}{\sum_{i=1}^n (\text{mass of } C)_i} \quad [Eq. 13]$$

Where:

C = Organic HAP component

n = Number of organic HAP components in stream.

(ii) If the vessel contents are heated to a temperature greater than 50 K below the boiling point, then organic HAP emissions from the heating of a vessel shall be calculated as the sum of the organic HAP emissions calculated in accordance with paragraphs (d)(4)(ii)(A) and (B) of this section.

(A) For the interval from the initial temperature to the temperature 50 K below the boiling point, organic HAP emissions shall be calculated using Equation 10 of this section, where  $T_2$  is the temperature 50 K below the boiling point.

(B) For the interval from the temperature 50 K below the boiling point to the final temperature, organic HAP emissions shall be calculated as the summation of emissions for each 5 K increment, where the emissions for each increment shall be calculated using Equation 10 of this section.

(1) If the final temperature of the heatup is at or lower than 5 K below the boiling point, the final temperature for the last increment shall be the final temperature for the heatup, even if the last increment is less than 5 K.

(2) If the final temperature of the heatup is higher than 5 K below the boiling point, the final temperature for the last increment shall be the temperature 5 K below the boiling point, even if the last increment is less than 5 K.

(3) If the vessel contents are heated to the boiling point and the vessel is not operating with a condenser, the final temperature for the final increment shall be the temperature 5 K below the boiling point, even if the last increment is less than 5 K.

(iii) If the vessel is operating with a condenser, and the vessel contents are heated to the boiling point, the process condenser, as defined in §63.1402, is considered part of the process. Organic HAP emissions shall be calculated as the sum of emissions calculated using Equation 10 of this section, which calculates organic HAP emissions due to heating the vessel contents to the temperature of the gas exiting the condenser, and emissions calculated using Equation 9 of this section, which calculates emissions due to the displacement of the remaining saturated noncondensable gas in the vessel. The final temperature in Equation 10 of this section shall be set equal to the exit gas temperature of the condenser. Equation 9 of this section shall be used as written below in Equation 14 of this section, using free space volume, and  $T$  is set equal to the condenser exit gas temperature:

$$E_{\text{episode}} = \frac{(y)(V_{fs})(P)(MW_{\text{avg}})}{RT} \quad [\text{Eq. 14}]$$

Where:

$E_{\text{episode}}$  = Emissions, kg/episode.

$y$  = Saturated mole fraction of all organic HAP in vapor phase.

$V_{fs}$  = Volume of the free space in the vessel,  $\text{m}^3$ .

$P$  = Pressure in vessel vapor space, kPa.

$MW_{\text{avg}}$  = Weighted average molecular weight of organic HAP in vapor, determined in accordance with paragraph (d)(4)(i)(D) of this section, kg/kmol.

$R$  = Ideal gas constant,  $8.314 \text{ m}^3 \cdot \text{kPa} / \text{kmol} \cdot \text{K}$ .

$T$  = Temperature of condenser exit stream, K.

(5) *Emissions determined by direct measurement.* The owner or operator may estimate annual organic HAP emissions for a batch emission episode by direct measurement. The test methods and procedures specified in paragraphs (a) and (b) of this section shall be used for direct measurement. If direct measurement is used, the owner or operator shall perform a test for the duration of a representative batch emission episode. Alternatively, the owner or operator may perform a test during only those periods

of the batch emission episode for which the emission rate for the entire episode can be determined or for which the emissions are greater than the average emission rate of the batch emission episode. The owner or operator choosing either of these options shall develop an emission profile illustrating the emission rate (kilogram per unit time) over the entire batch emission episode, based on either process knowledge or test data, to demonstrate that test periods are representative. Examples of information that could constitute process knowledge include calculations based on material balances and process stoichiometry. Previous test results may be used to develop the emission profile provided the results are still relevant to the current batch process vent conditions. The emission profile shall be included in the site-specific test plan required by §63.1417(h)(2).

(6) *Emissions determined by engineering assessment.* To use engineering assessment to estimate organic HAP emissions from a batch emission episode, owners or operators shall comply with paragraphs (d)(6)(i) through (iii) of this section.

(i) If the criteria specified in paragraphs (d)(6)(i)(A), (B), and (C) of this section are met for a specific batch emission episode, the owner or operator may use engineering assessment to estimate organic HAP emissions from that batch emission episode.

(A) Previous test data, where the measurement of organic HAP emissions was an outcome of the test, that show a greater than 20 percent discrepancy between the test value and the value estimated using the applicable equations in paragraphs (d)(1) through (4) of this section. Paragraphs (d)(6)(i)(A)(1) and (2) of this section describe test data that will be acceptable under this paragraph.

(1) Test data for the batch emission episode obtained during production of the product for which the demonstration is being made.

(2) Test data obtained for a batch emission episode from another process train where the test data were obtained during production of the product for which the demonstration is being made. Test data from another process train may be used only if the owner or operator can demonstrate that the data are representative of the batch emission episode for which the demonstration is being made, taking into account the nature, size, operating conditions, production rate, and sequence of process steps (e.g., reaction, distillation, etc.) of the equipment in the other process train.

(B) Previous test data for the batch emission episode with the highest organic HAP emissions on a mass basis where the measurement of organic HAP emissions was an outcome of the test, where data were obtained during the production of the product for which the demonstration is being made, and where the data show a greater than 20 percent discrepancy between the test value and the value estimated using the applicable equations in paragraphs (d)(1) through (4) of this section. If the criteria in this paragraph are met, then engineering assessment may be used for all batch emission episodes associated with that batch cycle for the batch unit operation.

(C) The owner or operator has requested and been granted approval to use engineering assessment to estimate organic HAP emissions from a batch emissions episode. The request to use engineering assessment to estimate organic HAP emissions from a batch emissions episode shall contain sufficient information and data to demonstrate to the Administrator that engineering assessment is an accurate means of estimating organic HAP emissions for that particular batch emissions episode. The request to use engineering assessment to estimate organic HAP emissions for a batch emissions episode shall be submitted in the Precompliance Report, as required by §63.1417(d).

(ii) Engineering assessment includes, but is not limited to, the following:

(A) Previous test results, provided the tests are representative of current operating practices;

(B) Bench-scale or pilot-scale test data obtained under conditions representative of current process operating conditions;

(C) Flow rate or organic HAP emission rate specified or implied within a permit limit applicable to the batch process vent; and

(D) Design analysis based on accepted chemical engineering principles, measurable process parameters, or physical or chemical laws or properties. Examples of analytical methods include, but are not limited to:

(1) Use of material balances;

(2) Estimation of flow rate based on physical equipment design such as pump or blower capacities;

(3) Estimation of organic HAP concentrations based on saturation conditions; and

(4) Estimation of organic HAP concentrations based on grab samples of the liquid or vapor.

(iii) Data or other information used to demonstrate that the criteria in paragraph (d)(6)(i) of this section have been met shall be reported as specified in paragraphs (d)(6)(iii)(A) and (B) of this section.

(A) Data or other information used to demonstrate that the criteria in paragraphs (d)(6)(i)(A) and (B) of this section have been met shall be reported in the Notification of Compliance Status, as required by §63.1417(e)(9).

(B) The request for approval to use engineering assessment to estimate organic HAP emissions from a batch emissions episode as allowed under paragraph (d)(6)(i)(C) of this section, and sufficient data or other information for demonstrating to the Administrator that engineering assessment is an accurate means of estimating organic HAP emissions for that particular batch emissions episode shall be submitted with the Precompliance Report, as required by §63.1417(d).

(7) *Emissions for a single batch cycle.* For each batch process vent, the organic HAP emissions associated with a single batch cycle shall be calculated using Equation 15 of this section:

$$E_{\text{cycle}} = \sum_{i=1}^n E_{\text{episode } i} \quad [\text{Eq. 15}]$$

Where:

$E_{\text{cycle}}$  = Emissions for an individual batch cycle, kg/batch cycle.

$E_{\text{episode } i}$  = Emissions from batch emission episode  $i$ , kg/episode.

$n$  = Number of batch emission episodes for the batch cycle.

(8) *Annual emissions from a batch process vent.* Annual organic HAP emissions from a batch process vent shall be calculated using Equation 16 of this section:

$$AE = \sum_{i=1}^n (N_i) (E_{\text{cycle } i}) \quad [\text{Eq. 16}]$$

Where:

AE = Annual emissions from a batch process vent, kg/yr.

$N_i$  = Number of type  $i$  batch cycles performed annually, cycles/year.

$E_{\text{cycle}i}$  = Emissions from the batch process vent associated with a single type  $i$  batch cycle, as determined in paragraph (d)(7) of this section, kg/batch cycle.

$n$  = Number of different types of batch cycles that cause the emission of organic HAP from the batch process vent.

(9) *Partial pressures in multicomponent systems.* Individual HAP partial pressures in multicomponent systems shall be determined using the appropriate method specified in paragraphs (d)(9)(i) through (iii) of this section.

(i) If the components are miscible, use Raoult's law to calculate the partial pressures;

(ii) If the solution is a dilute aqueous mixture, use Henry's law constants to calculate partial pressures;

(iii) If Raoult's law or Henry's law is not appropriate or available, the owner or operator may use any of the options in paragraph (d)(9)(iii)(A), (B), or (C) of this section.

(A) Experimentally obtained activity coefficients, Henry's law constants, or solubility data;

(B) Models, such as group-contribution models, to predict activity coefficients; or

(C) Assume the components of the system behave independently and use the summation of all vapor pressures from the HAPs as the total HAP partial pressure.

(10) For continuous process vent emissions determined by engineering assessment, the engineering assessment includes, but is not limited to, the examples provided in §63.1412(k)(3).

[65 FR 3290, Jan. 20, 2000, as amended at 79 FR 60932, Oct. 8, 2014]

### **§63.1415 Monitoring requirements.**

(a) *General requirements.* Each owner or operator of an emission point located at an affected source that uses a control device to comply with the requirements of this subpart and has one or more parameter monitoring level requirement specified under this subpart, shall install the monitoring equipment specified in paragraph (b) of this section in order to demonstrate continued compliance with the provisions of this subpart. All monitoring equipment shall be installed, calibrated, maintained, and operated according to manufacturer's specifications or other written procedures that provide adequate assurance that the equipment would reasonably be expected to monitor accurately.

(1) This monitoring equipment shall be in operation at all times when organic HAP emissions that are required to be controlled as part of complying with the emission limits specified in §§63.1404, 63.1405, 63.1406, 63.1407, and 63.1408 are vented to the control device.

(2) For control devices controlling less than 1 ton per year of uncontrolled organic HAP emissions, monitoring shall consist of a daily verification that the control device is operating properly. If the control device is used to control batch process vents alone or in combination with other emission points, the verification may be on a per batch cycle basis. This verification shall include, but not be limited to, a daily or per batch demonstration that the control device is working as designed. The procedure for this demonstration shall be submitted for review and approval as part of the Precompliance Report, as required by §63.1417(d)(10).

(3) Nothing in this section shall be construed to allow a monitoring parameter excursion caused by an activity that violates other applicable provisions of subpart A, F, or G of this part.

(b) *Monitoring equipment.* The monitoring equipment specified in paragraphs (b)(1) through (8) of this section shall be installed as specified in paragraph (a) of this section. The parameters to be monitored are specified in Table 3 of this subpart.

(1) Where a scrubber is used, the following monitoring equipment is required.

(i) A pH monitoring device equipped with a continuous recorder to monitor the pH of the scrubber effluent.

(ii) A flow measurement device equipped with a continuous recorder shall be located at the scrubber influent for liquid flow. Gas stream flow shall be determined using one of the following procedures:

(A) The owner or operator may determine gas stream flow using the design blower capacity with appropriate adjustments for pressure drop.

(B) If the scrubber is subject to regulations in 40 CFR parts 264 through 266 that required a determination of the liquid to gas (L/G) ratio prior to the applicable compliance date for this subpart, the owner or operator may determine gas stream flow by the method that had been utilized to comply with those regulations. A determination that was conducted prior to the compliance date for this subpart may be utilized to comply with this subpart if it is still representative.

(C) The owner or operator may prepare and implement a gas stream flow determination plan that documents an appropriate method which will be used to determine the gas stream flow. The plan shall require determination of gas stream flow by a method which will at least provide a value for either a representative or the highest gas stream flow anticipated in the scrubber during representative operating conditions other than malfunctions. The plan shall include a description of the methodology to be followed and an explanation of how the selected methodology will reliably determine the gas stream flow, and a description of the records that will be maintained to document the determination of gas stream flow. The owner or operator shall maintain the plan as specified in §63.1416(a).

(2) Where an absorber is used, a scrubbing liquid temperature monitoring device and a specific gravity monitoring device are required, each equipped with a continuous recorder.

(3) Where a condenser is used, a condenser exit temperature (product side) monitoring device equipped with a continuous recorder is required.

(4) Where a carbon adsorber is used, an integrating regeneration steam flow or nitrogen flow, or pressure monitoring device having an accuracy of  $\pm 10$  percent of the flow rate, level, or pressure, or better, capable of recording the total regeneration steam flow or nitrogen flow, or pressure (gauge or absolute) for each regeneration cycle; and a carbon bed temperature monitoring device, capable of recording the carbon bed temperature after each regeneration and within 15 minutes of completing any cooling cycle are required.

(5) Where an incinerator is used, a temperature monitoring device equipped with a continuous recorder is required.

(i) Where an incinerator other than a catalytic incinerator is used, the temperature monitoring device shall be installed in the firebox or in the ductwork immediately downstream of the firebox in a position before any substantial heat exchange occurs.

(ii) Where a catalytic incinerator is used, temperature monitoring devices shall be installed in the gas stream immediately before and after the catalyst bed.

(6) Where a flare is used, a device (including but not limited to a thermocouple, ultra-violet beam sensor, or infrared sensor) capable of continuously detecting the presence of a pilot flame is required.

(7) Where a boiler or process heater of less than 44 megawatts design heat input capacity is used, a temperature monitoring device in the firebox equipped with a continuous recorder is required. Any boiler or process heater in which all vent streams are introduced with the primary fuel or are used as the primary fuel is exempt from this requirement.

(8) As an alternate to paragraphs (b)(1) through (7) of this section, the owner or operator may install an organic monitoring device equipped with a continuous recorder. Said organic monitoring device shall meet the requirements of Performance Specification 8 or 9 of 40 CFR part 60, appendix B, and shall be installed, calibrated, and maintained according to §63.6.

(c) *Alternative monitoring parameters.* An owner or operator may request approval to monitor parameters other than those specified in Table 3 of this subpart. The request shall be submitted according to the procedures specified in §63.1417(j). Approval shall be requested if the owner or operator:

(1) Uses a control device or control technology other than those included in paragraph (b) of this section; or

(2) Uses one of the control devices included in paragraph (b) of this section, but seeks to monitor a parameter other than those specified in Table 3 of this subpart.

(d) *Monitoring of bypass lines.* Owners or operators using a vent system that contains bypass lines that could divert emissions away from a control device or control technology used to comply with the provisions of this subpart shall comply with either paragraph (d)(1) or (2) of this section. Equipment such as low leg drains, high point bleeds, analyzer vents, open-ended valves or lines, and pressure relief valves needed for safety purposes are not subject to this paragraph.

(1) Properly install, maintain, and operate a flow indicator that takes a reading at least once every 15 minutes. Records shall be generated as specified in §63.1416(d)(3). The flow indicator shall be installed at the entrance to any bypass line that could divert emissions away from the control device or control technology and to the atmosphere; or

(2) Secure the bypass line damper or valve in the non-diverting position with a car-seal or a lock-and-key type configuration. A visual inspection of the seal or closure mechanism shall be performed at least once every month to ensure that the damper or valve is maintained in the non-diverting position and emissions are not diverted through the bypass line. Records shall be generated as specified in §63.1416(d)(3).

(e) *Monitoring for the alternative standards.* For control devices that are used to comply with the provisions of §§63.1404(b), 63.1405(b), 63.1406(b), 63.1407(b), or 63.1408(b) the owner or operator shall conduct continuous monitoring of the outlet organic HAP concentration whenever emissions are vented to the control device. Continuous monitoring of outlet organic HAP concentration shall be accomplished using an FTIR instrument following Method PS-15 of 40 CFR part 60, appendix B. The owner or operator shall calculate a daily average outlet organic HAP concentration.



### **§63.1416 Recordkeeping requirements.**

(a) *Data retention.* Unless otherwise specified in this subpart, each owner or operator of an affected source shall keep copies of all applicable records and reports required by this subpart for at least 5 years, as specified in paragraph (a)(1) of this section, with the exception listed in paragraph (a)(2) of this section.

(1) All applicable records shall be maintained in such a manner that they can be readily accessed. The most recent 6 months of records shall be retained on site or shall be accessible from a central location by computer or other means that provides access within 2 hours after a request. The remaining 4 and one-half years of records may be retained offsite. Records may be maintained in hard copy or computer-readable form including, but not limited to, on paper, microfilm, computer, floppy disk, CD-ROM, optical disc, magnetic tape, or microfiche.

(2) If an owner or operator submits copies of reports to the appropriate EPA Regional Office, the owner or operator is not required to maintain copies of reports. If the EPA Regional Office has waived the requirement of §63.10(a)(4)(ii) for submittal of copies of reports, the owner or operator is not required to maintain copies of those reports.

(b) *Malfunction records.* Records shall be kept as specified in paragraphs (b)(1) through (3) of this section.

(1) In the event that an affected unit fails to meet an applicable standard, record the number of failures. For each failure record the date, time, and duration of each failure.

(2) For each failure to meet an applicable standard, record and retain a list of the affected sources or equipment, an estimate of the quantity of each regulated pollutant emitted over any emission limit, and a description of the method used to estimate the emissions.

(3) Record actions taken to minimize emissions in accordance with §63.1420(h)(4), and any corrective actions taken to return the affected unit to its normal or usual manner of operation.

(c) *Monitoring records.* Owners or operators required to comply with §63.1415 and, therefore, required to keep continuous records shall keep records as specified in paragraphs (c)(1) through (6) of this section.

(1) The owner or operator shall record either each measured data value or average values for 1 hour or shorter periods calculated from all measured data values during each period. If values are measured more frequently than once per minute, a single value for each minute may be used to calculate the hourly (or shorter period) average instead of all measured values. Owners or operators of batch process vents shall record each measured data value; if values are measured more frequently than once per minute, a single value for each minute may be recorded instead of all measured values.

(2) Daily average, batch cycle daily average, or block average values of each continuously monitored parameter shall be calculated for each operating day as specified in paragraphs (c)(2)(i) and (ii) of this section, except as specified in paragraphs (c)(3) and (4) of this section. The option of conducting parameter monitoring for batch process vents on a batch cycle daily average basis or a block average basis is described in paragraph (d)(2) of this section.

(i) The daily average value, batch cycle daily average, or block average shall be calculated as the average of all parameter values recorded during the operating day, or batch cycle, as appropriate, except as specified in paragraph (c)(4) of this section. For batch process vents, only parameter values recorded during those batch emission episodes, or portions thereof, in the batch cycle that the owner or operator has selected to control in order to comply shall be used to calculate the average. The calculated average

shall cover a 24-hour period if operation is continuous, or the number of hours of operation per operating day if operation is not continuous for daily average values or batch cycle daily average values. The calculated average shall cover the entire period of the batch cycle for block average values. As specified in §63.1413(a)(4)(i)(C)(3), the owner or operator shall provide the information needed to calculate batch cycle daily averages for operating days that include partial batch cycles.

(ii) The operating day shall be the period the owner or operator specifies in the operating permit or the Notification of Compliance Status for purposes of determining daily average values or batch cycle daily average values of monitored parameters. The block shall be the entire period of the batch cycle, as specified by the owner or operator in the operating permit or the Notification of Compliance Status for purposes of determining block average values of monitored parameters.

(3) If all recorded values for a monitored parameter during an operating day or block are above the minimum level or below the maximum level established in the Notification of Compliance Status or operating permit, the owner or operator may record that all values were above the minimum level or below the maximum level rather than calculating and recording a daily average, or block average, for that operating day. For these operating days or blocks, the records required in paragraph (c)(1) of this section shall also be retained for 5 years.

(4) Monitoring data recorded during periods identified in paragraphs (c)(4)(i) and (ii) of this section shall not be included in any average computed under this subpart. Records shall be kept of the times and durations of all such periods and any other periods during process or control device or recovery device or control technology operation when monitors are not operating:

(i) Monitoring system breakdowns, repairs, calibration checks, and zero (low-level) and high-level adjustments; and

(ii) Periods of non-operation of the affected source (or portion thereof) resulting in cessation of the emissions to which the monitoring applies.

(5) The owner or operator who has received approval to monitor different parameters, under §63.1417(j) as allowed under §63.1415(e), than those specified for storage vessels, continuous process vents, or batch process vents shall retain for a period of 5 years each record specified in their approved Alternative Monitoring Parameters request.

(6) The owner or operator who has received approval to use alternative continuous monitoring and recordkeeping provisions as specified in §63.1417(k) shall retain for a period of 5 years each record specified in their approved Alternative Continuous Monitoring request.

(d) *Batch process vent records*—(1) *Compliance demonstration records*. Each owner or operator of a batch process vent complying with §63.1406 or §63.1407 shall keep the following records, as applicable, readily accessible.

(i) If a batch process vent is seeking to demonstrate compliance with the alternative standard specified in §63.1406(b) or §63.1407(b), results of the initial compliance demonstration specified in §63.1413(f).

(ii) If a batch process vent is seeking to demonstrate compliance with the percent reduction requirements of §63.1406(a)(1)(ii) or §63.1407(a)(2)(ii), records documenting the batch cycle percent reduction or overall percent reduction, as appropriate, as specified in §63.1413(e)(1)(iii).

(iii) When using a flare to comply with §63.1406(a)(1)(i) or §63.1407(a)(2)(i):

(A) The flare design (i.e., steam-assisted, air-assisted or non-assisted);

(B) All visible emission readings, heat content determinations, flow rate measurements, and exit velocity determinations made during the compliance determination required by §63.1413(g); and

(C) Periods when all pilot flames were absent during the compliance determination required by §63.1413(g).

(iv) The following information when using a control device or control technology, other than a flare, to achieve compliance with the percent reduction requirement of §63.1406(a)(1)(ii) or §63.1407(a)(2)(ii):

(A) For an incinerator, non-combustion control device, or other control technology, the percent reduction of organic HAP achieved for emissions vented to the control device or control technology, as determined using the procedures specified in §63.1413(e)(1);

(B) For a boiler or process heater, a description of the location at which the vent stream is introduced into the boiler or process heater; and

(C) For a boiler or process heater with a design heat input capacity of less than 44 megawatts and where the vent stream is not introduced with the primary fuel or used as the primary fuel, the percent reduction of organic HAP achieved for emissions vented to the control device, as determined using the procedures specified in §63.1413(e)(1).

(v) If a batch process vent is seeking to demonstrate compliance with the mass emission limits specified in §63.1406(a)(1)(iii) or (a)(2)(iii) or specified in §63.1407(b)(2), the following information:

(A) Results of the initial compliance demonstration specified in §63.1413(e)(2).

(B) The organic HAP emissions from the batch process vent associated with each single type of batch cycle ( $E_{\text{cycle}}$ ) determined as specified in §63.1413(e)(2).

(C) The site-specific emission limit required by §63.1413(e)(2), as appropriate.

(vi) If an owner or operator designates a condenser sometimes operated as a process condenser as a control device, comply with either paragraph (d)(1)(vi)(A) or (B) of this section.

(A) Retain information, data, analyses to document inprocess recycling of the material recovered when the condenser is operating as a control device.

(B) When requested by the Administrator, demonstrate that material recovered by the condenser operating as a control device is reused in a manner meeting the definition of inprocess recycling.

(2) *Establishment of parameter monitoring level records.* For each parameter monitored according to §63.1415(b) and Table 3 of this subpart, or for alternate parameters and/or parameters for alternate control devices or control technologies monitored according to §63.1417(j) as allowed under §63.1415(e), maintain documentation showing the establishment of the level that indicates proper operation of the control device or control technology as required by §63.1415(c) for parameters specified in §63.1415(b) and as required by §63.1417(j) for alternate parameters. An owner or operator may choose to monitor operating parameters for batch process vents on a batch cycle daily average basis or on a block average basis. The batch cycle daily average is based on parameter monitoring accomplished during the operating day (i.e., a 24-hour basis). The block average is based on the parameter monitoring accomplished during a single batch cycle. As defined in §63.1402, the block shall be the period of time equal to a single batch cycle. Monitored parameter documentation shall include the following:

(i) Parameter monitoring data used to establish the level.

(ii) Identification that the parameter monitoring level is associated with a batch cycle daily average or a block average.

(iii) A definition of the batch cycle or block, as appropriate.

(3) *Controlled batch process vent continuous compliance records.* Continuous compliance records shall be kept as follows:

(i) Each owner or operator of a batch process vent that uses a control device or control technology to comply with the percent reduction requirements of §63.1406(a)(1)(ii) or §63.1407(a)(2)(ii) shall keep the following records, as applicable, readily accessible:

(A) Continuous records of the equipment operating parameters specified to be monitored under §63.1415(b) as applicable, and listed in Table 3 of this subpart, or specified by the Administrator in accordance with §63.1417(f) as allowed under §63.1415(e). Said records shall be kept as specified under paragraph (c) of this section, except as follows:

(1) For carbon adsorbers, the records specified in Table 3 of this subpart shall be maintained in place of continuous records.

(2) For flares, the records specified in Table 4 of this subpart shall be maintained in place of continuous records.

(B) Records of the batch cycle daily average value or block average value of each continuously monitored parameter, as specified in paragraph (c) of this section.

(ii) Each owner or operator of a batch process vent that uses a control device or control technology to comply with §63.1406 or §63.1407 shall keep the following records, as applicable, readily accessible:

(A) Hourly records of whether the flow indicator for bypass lines specified in §63.1415(d) was operating and whether a diversion was detected at any time during the hour. Also, records of the time and duration periods when the vent is diverted from the control device or control technology or the flow indicator specified in §63.1415(d) is not operating.

(B) Where a seal or closure mechanism is used to comply with §63.1415(d), hourly records of whether a diversion was detected at any time are not required. The owner or operator shall record whether the monthly visual inspection of the seals or closure mechanisms has been done and shall record the occurrence of all periods when the seal mechanism is broken, the bypass line damper or valve position has changed, or the key for a lock-and-key type configuration has been checked out, and records of any car-seal that has broken.

(C) Records specifying the times and duration of periods of monitoring system breakdowns, repairs, calibration checks, and zero (low-level) and high-level adjustments. In addition, records specifying any other periods of process or control device operation or control technology operation when monitors are not operating.

(iii) Each owner or operator of a batch process vent seeking to demonstrate compliance with the alternative standard, as specified in §63.1406(b) or §63.1407(b), shall keep the records of continuous emissions monitoring described in §63.1416(c).

(iv) Each owner or operator of a batch process vent seeking to demonstrate compliance with the mass emission limits, specified in §63.1406(a)(1)(iii) or (a)(2)(iii), shall keep the following records, as applicable, readily accessible.

(A) The cumulative average monthly emission rate or the 12-month rolling average monthly emission rate, as appropriate.

(B) If there is a deviation from the mass emission limit, as specified in §63.1413(i), the individual monthly emission rate data points making up the cumulative average monthly emission rate or the 12-month rolling average monthly emission rate, as appropriate.

(C) If it becomes necessary to redetermine ( $E_{\text{cyclei}}$ ) for a reactor batch process vent, as specified in §63.1413(e)(2), the new value(s) for ( $E_{\text{cyclei}}$ ).

(D) If an owner or operator is demonstrating compliance using the procedures in §63.1413(e)(2), the monthly value of the site-specific emission limit developed under §63.1413(e)(2).

(e) *Aggregate batch vent stream records*—(1) *Compliance demonstration records.* Each owner or operator of an aggregate batch vent stream complying with §63.1408(a)(1) or (2) shall keep the following records, as applicable, readily accessible:

(i) If an aggregate batch vent stream is in compliance with the percent reduction requirements of §63.1408(a)(1)(ii) or (a)(2)(ii), owners or operators shall comply with the recordkeeping requirements for continuous process vents specified in 40 CFR part 63, subpart SS.

(ii) If an aggregate batch vent stream is in compliance with the alternative standard specified in §63.1408(b), results of the initial compliance demonstration specified in §63.1413(f).

(iii) When using a flare to comply with §63.1408(a)(1)(i) or (a)(2)(i):

(A) The flare design (i.e., steam-assisted, air-assisted or non-assisted).

(B) All visible emission readings, heat content determinations, flow rate measurements, and exit velocity determinations made during the compliance determination required by §63.1413(g).

(C) Periods when all pilot flames were absent during the compliance determination required by §63.1413(g).

(iv) If an aggregate batch vent stream is seeking to comply with the mass emission limits specified in §63.1408(b)(2), results of the initial compliance demonstration specified in §63.1413(e)(2). In addition, for each batch process vent, the emissions associated with each single type of batch cycle ( $E_{\text{cyclei}}$ ), determined as specified in §63.1413(e)(2), shall be recorded.

(2) *Establishment of parameter monitoring level records.* For each parameter monitored according to §63.1415(b) and Table 3 of this subpart, or for alternate parameters and/or parameters for alternate control devices monitored according to §63.1417(j) as allowed under §63.1415(e), maintain documentation showing the establishment of the level that indicates proper operation of the control device as required by §63.1415(c) for parameters specified in §63.1415(b) and as required by §63.1417(j) for alternate parameters. Monitored parameter documentation shall include the parameter monitoring data used to establish the level.

(3) *Controlled aggregate batch vent streams continuous compliance records.* The following continuous compliance records shall be kept, as applicable:

(i) Each owner or operator of an aggregate batch vent stream that uses a control device to comply with the percent reduction requirement of §63.1408(a)(1)(ii) or (a)(2)(ii) shall keep the following records, as applicable, readily accessible:

(A) Continuous records of the equipment operating parameters specified to be monitored under §63.1415(b) as applicable, and listed in Table 3 of this subpart, or specified by the Administrator in accordance with §63.1417(j) as allowed under §63.1415(e). Records shall be kept as specified under paragraph (c) of this section, except as follows:

(1) For carbon adsorbers, the records specified in Table 3 of this subpart shall be maintained in place of continuous records.

(2) For flares, the records specified in Table 3 of this subpart shall be maintained in place of continuous records.

(B) Records of the daily average value of each continuously monitored parameter, as specified in paragraph (c) of this section.

(ii) Each owner or operator of an aggregate batch vent stream that uses a control device to comply with paragraph §63.1408(a)(1) or (2) of this section shall keep the following records, as applicable, readily accessible:

(A) Hourly records of whether the flow indicator for bypass lines specified in §63.1415(d) was operating and whether a diversion was detected at any time during the hour. Also, records of the times and durations of periods when the vent is diverted from the control device or the flow indicator specified in §63.1415(d) is not operating.

(B) Where a seal or closure mechanism is used to comply with §63.1415(d), hourly records of whether a diversion was detected at any time are not required. The owner or operator shall record whether the monthly visual inspection of the seals or closure mechanisms has been done, and shall record the occurrence of all periods when the seal mechanism is broken, the bypass line damper or valve position has changed, or the key for a lock-and-key type configuration has been checked out, and records of any car-seal that has broken.

(C) Records specifying the times and duration of periods of monitoring system breakdowns, repairs, calibration checks, and zero (low-level) and high-level adjustments. In addition, records specifying any other periods of process or control device operation when monitors are not operating.

(iii) Each owner or operator of an aggregate batch vent stream seeking to demonstrate compliance with the alternative standard, as specified in §63.1408(b), shall keep the records of continuous emissions monitoring described in §63.1416(c).

(iv) Each owner or operator of an aggregate batch vent stream seeking to demonstrate compliance with the mass emission limits, specified in §63.1408(b)(2), shall keep the following records, as applicable, readily accessible:

(A) The rolling average monthly emission rate or the 12-month rolling average monthly emission rate, as appropriate.

(B) If there is a deviation from the emission limit, as specified in §63.1413(i)(1), the individual monthly emission rate data points making up the rolling average monthly emission rate or the 12-month rolling average monthly emission rate, as appropriate.

(C) If it becomes necessary to redetermine ( $E_{\text{cyclei}}$ ) for a reactor batch process vent, as specified in §63.1413(e)(2), the new value(s) for ( $E_{\text{cyclei}}$ ).

(f) *Continuous process vent records—(1) TRE index value records.* Each owner or operator of a continuous process vent shall maintain records of measurements, engineering assessments, and calculations performed according to the procedures of §63.1412(j) to determine the TRE index value. Documentation of engineering assessments, described in §63.1412(k), shall include all data, assumptions, and procedures used for the engineering assessments.

(2) *Volumetric flow rate records.* Each owner or operator of a continuous process vent shall record the volumetric flow rate as measured using the sampling site and volumetric flow rate determination procedures (if applicable) specified in §63.1412(b) and (f) or determined through engineering assessment as specified in §63.1412(k).

(3) *Organic HAP concentration records.* Each owner or operator shall record the organic HAP concentration as measured using the sampling site and organic HAP concentration determination procedures specified in §63.1412(b) and (e), or determined through engineering assessment as specified in §63.1412(k).

(4) *Process change records.* Each owner or operator of a continuous process vent shall keep up-to-date, readily accessible records of any process changes that change the control applicability for a continuous process vent. Records are to include any recalculation or measurement of the flow rate, organic HAP concentration, and TRE index value.

(5) If a continuous process vent is seeking to demonstrate compliance with the mass emission limit specified in §63.1405(a)(3), keep records specified in paragraphs (f)(5)(i) and (ii) of this section.

(i) The results of the initial compliance demonstration specified in §63.1413(h)(1)(i).

(ii) The monthly organic HAP emissions from the continuous process vent determined as specified in §63.1413(h)(2).

(6) When using a flare to comply with §63.1405(a), keep the records specified in paragraphs (f)(6)(i) through (f)(6)(iii) of this section.

(i) The flare design (i.e., steam-assisted, air-assisted or non-assisted);

(ii) All visible emission readings, heat content determinations, flow rate measurements, and exit velocity determinations made during the compliance determination required by §63.1413(g); and

(iii) Periods when all pilot flames were absent during the compliance determination required by §63.1413(g).

(g) *Other records or documentation.* (1) For continuous monitoring systems used to comply with this subpart, owners or operators shall keep records documenting the completion of calibration checks and records documenting the maintenance of continuous monitoring systems that are specified in the manufacturer's instructions or that are specified in other written procedures that provide adequate assurance that the equipment would reasonably be expected to monitor accurately.

(2) The owner or operator of an affected source granted a waiver under §63.10(f) shall maintain any information demonstrating whether an affected source is meeting the requirements for a waiver of recordkeeping or reporting requirements.

(3) Owners or operators using the exemption from the equipment leak provisions provided by §63.1400(f) shall comply with either paragraph (g)(3)(i) or (ii) of this section.

(i) The owner or operator shall retain information, data, and analysis used to document the basis for using the exemption provided by §63.1400(f). Such information, data, and analysis shall be retained for the 12-month period preceding December 14, 1998 and for each 12-month period the affected source is in operation and using the exemption provided by §63.1400(f). The beginning of each 12-month period shall be the anniversary of December 14, 1998.

(ii) When requested by the Administrator, the owner or operator shall demonstrate that actual annual production is equal to or less than 800 megagrams per year of amino/phenolic resin for the 12-month period preceding December 14, 1998, and for each 12-month period the affected source has been in operation and using the exemption provided by §63.1400(f). The beginning of each 12-month period shall be the anniversary of December 14, 1998.

(4) The owner or operator of a heat exchange system located at an affected source shall retain the following records:

(i) Monitoring data required by §63.1409 indicating a leak and the date when the leak was detected, and if demonstrated not to be a leak, the basis for that determination.

(ii) Records of any leaks detected by procedures subject to §63.1409(c)(2) and the date the leak was detected.

(iii) The dates of efforts to repair leaks.

(iv) The method or procedure used to confirm repair of a leak and the date repair was confirmed.

(5) For pressure relief devices in organic HAP service, keep records of the information specified in paragraphs (g)(5)(i) through (v) of this section, as applicable.

(i) A list of identification numbers for pressure relief devices that vent to a fuel gas system, process, drain system, or closed-vent system and control device, under the provisions in §63.1411(d).

(ii) A list of identification numbers for pressure relief devices subject to the provisions in §63.1411(a).

(iii) A list of identification numbers for pressure relief devices equipped with rupture disks, under the provisions in §63.1411(b)(2).

(iv) The dates and results of the monitoring following a pressure release for each pressure relief device subject to the provisions in §63.1411(a) and (b). The results shall include:

(A) The background level measured during each compliance test.

(B) The maximum instrument reading measured at each piece of equipment during each compliance test.

(v) For pressure relief devices in organic HAP service subject to §63.1411(c), keep records of each pressure release to the atmosphere, including the following information:

(A) The source, nature, and cause of the pressure release.



(B) The date, time, and duration of the pressure release.

(C) An estimate of the quantity of total HAP emitted during the pressure release and the calculations used for determining this quantity.

(D) The actions taken to prevent this pressure release.

(E) The measures adopted to prevent future such pressure

(h) *Reduced recordkeeping program.* For any parameter with respect to any item of equipment, the owner or operator may implement the recordkeeping requirements specified in paragraph (h)(1) or (2) of this section as alternatives to the provisions specified in this subpart for storage vessels, continuous process vents, batch process vents, or aggregate batch vent streams. The owner or operator shall retain for a period of 5 years each record required by paragraph (h)(1) or (2) of this section.

(1) The owner or operator may retain only the daily average, batch cycle daily average, or block average value, and is not required to retain more frequent values, for a parameter with respect to an item of equipment, if the requirements of paragraphs (h)(1)(i) through (vi) of this section are met. An owner or operator electing to comply with the requirements of paragraph (h)(1) of this section shall notify the Administrator in the Notification of Compliance Status Report required under §63.1417(e) or, if the Notification of Compliance Status has already been submitted, in the Periodic Report immediately preceding implementation of the requirements of this paragraph as specified in §63.1417(f)(10).

(i) The monitoring system is capable of detecting unrealistic or impossible data during periods of operation (e.g., a temperature reading of  $-200$  °C on a boiler) and will alert the operator by alarm or other means. The owner or operator shall record the occurrence. All instances of the alarm or other alert in an operating day or block constitute a single occurrence.

(ii) The monitoring system generates, updated at least hourly throughout each operating day, a running average of the parameter values that have been obtained during that operating day or block, and the capability to observe this running average is readily available on-site to the Administrator during the operating day. The owner or operator shall record the occurrence of any period meeting the criteria in paragraphs (h)(1)(ii)(A) and (B) of this section. All instances in an operating day or block constitute a single occurrence:

(A) The running average is above the maximum or below the minimum established limits; and

(B) The running average is based on at least six 1-hour average values.

(iii) The monitoring system is capable of detecting unchanging data during periods of operation, except in circumstances where the presence of unchanging data is the expected operating condition based on past experience (e.g., pH in some scrubbers) and will alert the operator by alarm or other means. The owner or operator shall record the occurrence. All instances of the alarm or other alert in an operating day or block constitute a single occurrence.

(iv) The monitoring system will alert the owner or operator by an alarm or other means if the running average parameter value calculated under paragraph (h)(1)(ii) of this section reaches a set point that is appropriately related to the established limit for the parameter that is being monitored.

(v) The owner or operator shall verify the proper functioning of the monitoring system, including its ability to comply with the requirements of paragraphs (h)(1)(i) through (iv) of this section, at the times specified in paragraphs (h)(1)(v)(A) through (C). The owner or operator shall document that the required verifications occurred.

(A) Upon initial installation.

(B) Annually after initial installation.

(C) After any change to the programming or equipment constituting the monitoring system which might reasonably be expected to alter the monitoring system's ability to comply with the requirements of this section.

(vi) The owner or operator shall retain the records identified in paragraphs (h)(1)(vi)(A) through (D) of this section.

(A) Identification of each parameter for each item of equipment for which the owner or operator has elected to comply with the requirements of paragraph (h)(1) of this section.

(B) A description of the applicable monitoring system(s) and how compliance will be achieved with each requirement of paragraphs (h)(1)(i) through (v) of this section. The description shall identify the location and format (e.g., on-line storage, log entries) for each required record. If the description changes, the owner or operator shall retain, as provided in paragraph (a) of this section, except as provided in paragraph (h)(1)(vi)(D) of this section, both the current and the most recent superseded description.

(C) A description and the date of any change to the monitoring system that would reasonably be expected to impair its ability to comply with the requirements of paragraph (h) of this section.

(D) Owners and operators subject to paragraph (h)(1)(vi)(B) of this section shall retain the current description of the monitoring system as long as the description is current. The current description shall, at all times, be retained on-site or be accessible from a central location by computer or other means that provides access within 2 hours after a request. The owner or operator shall retain all superseded descriptions for at least 5 years after the date of their creation. Superseded descriptions shall be retained on-site (or accessible from a central location by computer or other means that provides access within 2 hours after a request) for at least 6 months after their creation. Thereafter, superseded descriptions may be stored off-site.

(2) If an owner or operator has elected to implement the requirements of paragraph (h)(1) of this section for a parameter with respect to an item of equipment and a period of 6 consecutive months has passed without any deviation as defined in paragraph (h)(2)(iv) of this section, the owner or operator is no longer required to record the daily average, batch cycle daily average, or block average value for any operating day when the daily average, batch cycle daily average, or block average value is less than the maximum or greater than the minimum established limit. With approval by the Administrator, monitoring data generated prior to the compliance date of this subpart shall be credited toward the period of 6 consecutive months if the parameter limit and the monitoring accomplished during the period prior to the compliance date were required and/or approved by the Administrator.

(i) If the owner or operator elects not to retain the daily average, batch cycle daily average, or block average values, the owner or operator shall notify the Administrator in the next Periodic Report as specified in §63.1417(f)(11). The notification shall identify the parameter and unit of equipment.

(ii) If, on any operating day or during any block after the owner or operator has ceased recording the daily average, batch cycle daily average, or block average values as provided in paragraph (h)(2) of this section, there is a deviation as defined in paragraph (h)(2)(iv) of this section, the owner or operator shall immediately resume retaining the daily average, batch cycle daily average, or block average value for each operating day and shall notify the Administrator in the next Periodic Report. The owner or operator shall continue to retain each daily average, batch cycle daily average, or block average value until another period of 6 consecutive months has passed without a deviation as defined in paragraph (h)(2)(iv) of this section.

(iii) The owner or operator shall retain the records specified in paragraphs (h)(1)(i) through (iv) of this section for the duration specified in paragraph (h) of this section. For any calendar week, if compliance with paragraphs (h)(1)(i) through (iv) of this section does not result in retention of a record of at least one occurrence or measured parameter value, the owner or operator shall record and retain at least one value during a period of operation.

(iv) For purposes of paragraph (h)(2) of this section, a deviation means that the daily average, batch cycle daily average, or block average value of monitoring data for a parameter is greater than the maximum, or less than the minimum established value.

[65 FR 3290, Jan. 20, 2000, as amended at 71 FR 20461, Apr. 20, 2006; 79 FR 60932, Oct. 8, 2014]

### **§63.1417 Reporting requirements.**

(a) *Reporting and notification.* In addition to the reports and notifications required by subpart A of this part as specified in Table 1 of this subpart, the owner or operator of an affected source shall prepare and submit the reports listed in paragraphs (d) through (i) of this section as applicable. All reports required by this subpart and the schedule for their submittal are listed in Table 5 of this subpart.

(b) *General.* Owners and operators are required to meet the reporting requirements of this subpart unless they can demonstrate that failure to submit information required to be included in a specified report was due to the circumstances described in paragraphs (b)(1) through (3) of this section. Examples of circumstances where this paragraph may apply include information related to newly-added equipment or emission points, changes in the process, changes in equipment required or utilized for compliance with the requirements of this subpart, or changes in methods or equipment for monitoring, recordkeeping, or reporting.

(1) The information was not known in time for inclusion in the report specified by this subpart.

(2) The owner or operator has been diligent in obtaining the information.

(3) The owner or operator submits a report according to the provisions of paragraphs (b)(3)(i) through (iii) of this section, as appropriate.

(i) If this subpart expressly provides for supplements to the report in which the information is required, the owner or operator shall submit the information as a supplement to that report. The information shall be submitted no later than 60 days after it is obtained, unless otherwise specified in this subpart.

(ii) If this subpart does not expressly provide for supplements, but the owner or operator must submit a request for revision of an operating permit pursuant to 40 CFR part 70 or part 71 due to circumstances to which the information pertains, the owner or operator shall submit the information with the request for revision to the operating permit.

(iii) In any case not addressed by paragraph (b)(3)(i) or paragraph (b)(3)(ii) of this section, the owner or operator shall submit the information with the first Periodic Report, as required by this subpart, which has a submission deadline at least 60 days after the information is obtained.

(c) *Submittals.* All reports required under this subpart shall be sent to the Administrator at the appropriate address listed in §63.13. If acceptable to both the Administrator and the owner or operator of an affected source, reports may be submitted on electronic media.

(d) *Precompliance Report.* Owners or operators of affected sources requesting an extension for compliance; requesting approval to use alternative monitoring parameters, alternative continuous monitoring and recordkeeping, or alternative controls; requesting approval to use engineering assessment to estimate organic HAP emissions from a batch emissions episode as described in §63.1414(d)(6)(i)(C); wishing to establish parameter monitoring levels according to the procedures contained in §63.1413(a)(4)(ii); establishing parameter monitoring levels based on a design evaluation as specified in §63.1413(a)(3); or following the procedures in §63.1413(e)(2); or following the procedures in §63.1413(h)(2), shall submit a Precompliance Report according to the schedule described in paragraph (d)(1) of this section. The Precompliance Report shall contain the information specified in paragraphs (d)(2) through (11) of this section, as appropriate.

(1) The Precompliance Report shall be submitted to the Administrator no later than 12 months prior to the compliance date. Unless the Administrator objects to a request submitted in the Precompliance Report within 45 days after its receipt, the request shall be deemed approved. For new affected sources, the Precompliance Report shall be submitted to the Administrator with the application for approval of construction or reconstruction required by §63.5(d), as specified on Table 1 of this subpart. Supplements to the Precompliance Report may be submitted as specified in paragraph (d)(11) of this section.

(2) A request for an extension for compliance, as specified in §63.1401(d), may be submitted in the Precompliance Report. The request for a compliance extension will include the data outlined in §63.6(i)(6)(i)(A), (B), and (D), as required in §63.1401(d)(1).

(3) The alternative monitoring parameter information required in paragraph (j) of this section shall be submitted in the Precompliance Report if, for any emission point, the owner or operator of an affected source seeks to comply through the use of a control technique other than those for which monitoring parameters are specified in this subpart or seeks to comply by monitoring a different parameter than those specified in this subpart.

(4) If the affected source seeks to comply using alternative continuous monitoring and recordkeeping as specified in paragraph (k) of this section, the owner or operator shall submit the information requested in paragraph (d)(4)(i) or (ii) of this section in the Precompliance Report:

(i) The owner or operator shall submit notification of the intent to use the provisions specified in paragraph (k) of this section; or

(ii) The owner or operator shall submit a request for approval to use alternative continuous monitoring and recordkeeping provisions as specified in paragraph (k) of this section.

(5) The owner or operator shall report the intent to use alternative controls to comply with the provisions of this subpart in the Precompliance Report. The Administrator may deem the alternative controls to be equivalent to the controls required by the standard under the procedures outlined in §63.6(g).

(6) If a request for approval to use engineering assessment to estimate organic HAP emissions from a batch emissions episode, as specified in §63.1414(d)(6)(i)(C), is being made, the information required by §63.1414(d)(6)(iii)(B) shall be submitted in the Precompliance Report.

(7) If an owner or operator elects to establish parameter monitoring levels according to the procedures contained in §63.1413(a)(4)(ii), or will be establishing parameter monitoring levels based on a design evaluation as specified in §63.1413(a)(3), the following information shall be submitted in the Precompliance Report:

(i) Identification of which procedures (i.e., §63.1413(a)(1)(i) or (ii)) are to be used; and

(ii) A description of how the parameter monitoring level is to be established. If the procedures in §63.1413(a)(4)(ii) are to be used, a description of how performance test data will be used shall be included.

(8) If an owner or operator is complying with the mass emission limit specified in §63.1405(a)(3), the sample of production records specified in §63.1413(h)(2) shall be submitted in the Precompliance Report.

(9) If an owner or operator is complying with the mass emission limit specified in §63.1406(a)(1)(iii) or (a)(2)(iii), §63.1407(b)(2), or §63.1408(b)(2), the sample of production records specified in §63.1413(e)(2) shall be submitted in the Precompliance Report.

(10) The procedure for a control device controlling less than 1 ton per year of uncontrolled organic HAP emissions shall be submitted, as specified in §63.1415(a)(2). Such a procedure shall meet the requirements specified in §63.1415(a)(2).

(11) Supplements to the Precompliance Report may be submitted as specified in paragraph (d)(11)(i) or (ii) of this section. Unless the Administrator objects to a request submitted in a supplement to the Precompliance Report within 45 days after its receipt, the request shall be deemed approved.

(i) Supplements to the Precompliance Report may be submitted to clarify or modify information previously submitted.

(ii) Supplements to the Precompliance Report may be submitted to request approval to use alternative monitoring parameters, as specified in paragraph (j) of this section; to use alternative continuous monitoring and recordkeeping, as specified in paragraph (k) of this section; to use alternative controls, as specified in paragraph (d)(5) of this section; to use engineering assessment to estimate organic HAP emissions from a batch emissions episode, as specified in paragraph (d)(6) of this section; or to establish parameter monitoring levels according to the procedures contained in §63.1413(a)(4)(ii) or (a)(3), as specified in paragraph (d)(7) of this section.

(e) *Notification of Compliance Status.* For existing and new affected sources, a Notification of Compliance Status shall be submitted within 150 days after the compliance dates specified in §63.1401. For equipment leaks, the Notification of Compliance Status shall contain the information specified in 40 CFR part 63, subpart UU. For storage vessels, continuous process vents, batch process vents, and aggregate batch vent streams, the Notification of Compliance Status shall contain the information listed in paragraphs (e)(1) through (9) of this section. For pressure relief devices subject to the requirements of §63.1411(c), the owner or operator shall also submit the information listed in paragraph (e)(10) of this section in a supplement to the Notification of Compliance Status within 150 days after the first applicable compliance date for pressure relief device monitoring.

(1) The results of any emission point applicability determinations, performance tests, design evaluations, inspections, continuous monitoring system performance evaluations, any other information used to demonstrate compliance, and any other information, as appropriate, required to be included in the Notification of Compliance Status under 40 CFR part 63, subpart WW and subpart SS, as referred to in §63.1404 for storage vessels; under 40 CFR part 63, subpart SS, as referred to in §63.1405 for continuous process vents; under §63.1416(f)(1) through (3) for continuous process vents; under §63.1416(d)(1) for batch process vents; and under §63.1416(e)(1) for aggregate batch vent streams. In addition, each owner or operator shall comply with paragraphs (e)(1)(i) and (ii) of this section.

(i) For performance tests, applicability determinations, and estimates of organic HAP emissions that are based on measurements, the Notification of Compliance Status shall include one complete test report, as described in paragraph (e)(1)(ii) of this section, for each test method used for a particular kind of emission point. For additional tests performed for the same kind of emission point using the same

method, the results and any other required information shall be submitted, but a complete test report is not required.

(ii) A complete test report shall include a brief process description, sampling site description, description of sampling and analysis procedures and any modifications to standard procedures, quality assurance procedures, record of operating conditions during the test, record of preparation of standards, record of calibrations, raw data sheets for field sampling, raw data sheets for field and laboratory analyses, documentation of calculations, and any other information required by the test method.

(2) For each monitored parameter for which a maximum or minimum level is required to be established, the Notification of Compliance Status shall contain the information specified in paragraphs (e)(2)(i) through (iv) of this section, unless this information has been established and provided in the operating permit.

(i) The required information shall include the specific maximum or minimum level of the monitored parameter(s) for each emission point.

(ii) The required information shall include the rationale for the specific maximum or minimum level for each parameter for each emission point, including any data and calculations used to develop the level and a description of why the level indicates proper operation of the control device or control technology.

(iii) The required information shall include a definition of the affected source's operating day, as specified in §63.1416(c)(2)(ii), for purposes of determining daily average values or batch cycle daily average values of monitored parameters. The required information shall include a definition of the affected source's block(s), as specified in §63.1416(c)(2)(ii), for purposes of determining block average values of monitored parameters.

(iv) For batch process vents, the required information shall include a definition of each batch cycle that requires the control of one or more batch emission episodes during the cycle, as specified in §§63.1413(e)(1)(iii) and 63.1416(c)(2)(ii).

(3) When the determination of applicability for process units, as made following the procedures in §63.1400(g), indicates that a process unit is an APPU, an identification of the APPU and a statement indicating that the APPU is an APPU that produces more than one intended product at the same time, as specified in §63.1400(g)(1), or is a flexible operations process unit as specified in §63.1400(g)(2) through (4).

(4) [Reserved]

(5) The results for each predominant use determination for storage vessels belonging to an affected source subject to this subpart that is made under §63.1400(h)(6).

(6) Notification that the owner or operator has elected to comply with §63.1416(h), Reduced Recordkeeping Program.

(7) Notification that an affected source is exempt from the equipment leak provisions of §63.1410 according to the provisions of §63.1400(f), and the affected source's actual annual production of amino/phenolic resins for the 12-month period preceding December 14, 1998.

(8) An owner or operator with a combustion device, recovery device, or recapture device affected by the situation described in §63.1400(i)(5) shall identify which rule shall be complied with for monitoring, recordkeeping, and reporting requirements, as allowed under §63.1400(i)(5).

(9) Data or other information used to demonstrate that an owner or operator may use engineering assessment to estimate emissions for a batch emission episode, as specified in §63.1413(d)(6)(iii)(A).

(10) For pressure relief devices in organic HAP service, a description of the device or monitoring system to be implemented, including the pressure relief devices and process parameters to be monitored (if applicable), and a description of the alarms or other methods by which operators will be notified of a pressure release.

(f) *Periodic Reports.* Except as specified in paragraph (f)(12) of this section, a report containing the information in paragraph (f)(2) of this section or containing the information in paragraphs (f)(3) through (11) and (13) of this section, as appropriate, shall be submitted semiannually no later than 60 days after the end of each 180 day period. In addition, for equipment leaks subject to §63.1410, the owner or operator shall submit the information specified in 40 CFR part 63, subpart UU, and for heat exchange systems subject to §63.1409, the owner or operator shall submit the information specified in §63.1409. Section 63.1415 shall govern the use of monitoring data to determine compliance for emissions points required to apply controls by the provisions of this subpart.

(1) Except as specified in paragraph (f)(12) of this section, a report containing the information in paragraph (f)(2) of this section or containing the information in paragraphs (f)(3) through (11) of this section, as appropriate, shall be submitted semiannually no later than 60 days after the end of each 180 day period. The first report shall be submitted no later than 240 days after the date the Notification of Compliance Status is due and shall cover the 6-month period beginning on the date the Notification of Compliance Status is due. Subsequent reports shall cover each preceding 6-month period.

(2) If none of the compliance exceptions specified in paragraphs (f)(3) through (11) of this section occurred during the 6-month period, the Periodic Report required by paragraph (f)(1) of this section shall be a statement that the affected source was in compliance for the preceding 6-month period and no activities specified in paragraphs (f)(3) through (11) of this section occurred during the preceding 6-month period.

(3) For an owner or operator of an affected source complying with the provisions of §§63.1404 through 63.1409 for any emission point, Periodic Reports shall include:

(i) All information specified in 40 CFR part 63, subpart WW and subpart SS for storage vessels; 40 CFR part 63, subpart SS for continuous process vents required to comply with subpart SS; §63.1416(d)(3)(ii) for batch process vents; and §63.1416(e) for aggregate batch vent stream.

(ii) The daily average values, batch cycle daily average values, or block average values of monitored parameters for deviations, as specified in §63.1413(i), of operating parameters. In addition, the periods and duration of periods when monitoring data were not collected shall be specified.

(4) Notification if one or more emission point(s) or one or more APPU is added to an affected source. The owner or operator shall submit the following information:

(i) A description of the addition to the affected source;

(ii) Notification of applicability status (i.e., does the emission point require control) of the additional emission point, if appropriate, or notification of all emission points in the added APPU.

(5) If there is a deviation from the mass emission limit specified in §63.1405(a)(3), §63.1406(a)(1)(iii) or (a)(2)(iii), §63.1407(b)(2), or §63.1408(b)(2), the following information, as appropriate, shall be included:

(i) The cumulative average monthly emission rate or the 12-month rolling average monthly emission rate, as appropriate.

(ii) The individual monthly emission rate data points making up the cumulative average monthly emission rate or the 12-month rolling average monthly emission rate, as appropriate.

(iii) If an owner or operator is demonstrating compliance using the procedures in §63.1413(e)(2)(ii), the monthly value of the site-specific emission limit.

(6) If any performance tests are reported in a Periodic Report, the following information shall be included:

(i) One complete test report shall be submitted for each test method used for a particular kind of emission point tested. A complete test report shall contain the information specified in paragraph (e)(1)(ii) of this section.

(ii) For additional tests performed for the same kind of emission point using the same method, results and any other information required shall be submitted, but a complete test report is not required.

(7) The Periodic Report shall include the results for each change made to a primary product determination for amino/phenolic resins made under §63.1400(g).

(8) The Periodic Report shall include the results for each change made to a predominant use determination for a storage vessel belonging to an affected source subject to this subpart that is made under §63.1400(h)(6).

(9) If an owner or operator invokes the delay of repair provisions for a heat exchange system, the following information shall be submitted, as appropriate. If the leak remains unrepaired, the information shall also be submitted in each subsequent periodic report until repair of the leak is reported.

(i) The presence of the leak and the date that the leak was detected.

(ii) Whether or not the leak has been repaired. If the leak is repaired, the date the leak was successfully repaired. If the leak remains unrepaired, the expected date of repair.

(iii) The reason(s) for delay of repair. If delay of repair is invoked due to the reasons described in §63.1409(e)(2), documentation of emissions estimates shall be included.

(10) Notification that the owner or operator has elected to comply with §63.1416(h), Reduced Recordkeeping Program.

(11) Notification that the owner or operator has elected to not retain the daily average, batch cycle daily average, or block average values, as appropriate, as specified in §63.1416(h)(2)(i).

(12) The owner or operator of an affected source shall submit quarterly reports for particular emission points as specified in paragraphs (f)(12)(i) through (iv) of this section.

(i) The owner or operator of an affected source shall submit quarterly reports for a period of 1 year for an emission point if the Administrator requests the owner or operator to submit quarterly reports for the emission point.



(ii) The quarterly reports shall include all information specified in paragraphs (f)(3) through (11) of this section applicable to the emission point for which quarterly reporting is required under paragraph (f)(12)(i) of this section. Information applicable to other emission points within the affected source shall be submitted in the semiannual reports required under paragraph (f)(1) of this section.

(iii) Quarterly reports shall be submitted no later than 60 days after the end of each quarter.

(iv) After quarterly reports have been submitted for an emission point for 1 year, the owner or operator may return to semiannual reporting for the emission point unless the Administrator requests the owner or operator to continue to submit quarterly reports.

(13) For pressure relief devices, Periodic Reports must include the information specified in paragraphs (f)(13)(i) through (iii) of this section.

(i) For pressure relief devices in organic HAP service subject to §63.1411, report confirmation that all monitoring to show compliance was conducted within the reporting period.

(ii) For pressure relief devices in organic HAP gas or vapor service subject to §63.1411(b), report any instrument reading of 500 ppm above background or greater, more than 5 days after the relief device returns to organic HAP gas or vapor service after a pressure release.

(iii) For pressure relief devices in organic HAP service subject to §63.1411(c), report each pressure release to the atmosphere, including the following information:

(A) The source, nature, and cause of the pressure release.

(B) The date, time, and duration of the pressure release.

(C) An estimate of the quantity of total HAP emitted during the pressure release and the method used for determining this quantity.

(D) The actions taken to prevent this pressure release.

(E) The measures adopted to prevent future such pressure releases.

(g) *Reports of Malfunctions.* If a source fails to meet an applicable standard, report such events in the Periodic Report. Report the number of failures to meet an applicable standard. For each instance, report the date, time and duration of each failure. For each failure the report must include a list of the affected sources or equipment, an estimate of the quantity of each regulated pollutant emitted over any emission limit, and a description of the method used to estimate the emissions.

(h) *Other reports.* Other reports shall be submitted as specified in paragraphs (h)(1) through (8) of this section.

(1) For storage vessels, the notifications of inspections required by 40 CFR part 63, subpart WW shall be submitted.

(2) A site-specific test plan shall be submitted no later than 90 days before the planned date for a performance test. Unless the Administrator requests changes to the site-specific test plan within 45 days after its receipt, the site-specific test plan shall be deemed approved. The test plan shall include a description of the planned test and rationale for why the planned performance test will provide adequate and representative results for demonstrating the performance of the control device. If required by

§63.1413(e)(1) or §63.1414(d)(5), the test plan shall include an emission profile and rationale for why the selected test period is representative.

(3) The owner or operator shall notify the Administrator of the intention to conduct a performance test at least 30 days before the performance test is scheduled in order to allow the Administrator the opportunity to have an observer present during the test. If after 30 days notice for an initially scheduled performance test, there is delay (due to operational problems, etc.) in conducting the scheduled performance test, the owner or operator of an affected source shall notify the Administrator as soon as possible of any delay in the original test date, either by providing at least 7 days prior notice of the rescheduled date of the performance test, or by arranging a rescheduled date with the Administrator by mutual agreement.

(4) When the conditions of §63.1400(g)(7) or the conditions of §63.1400(g)(8) are met, notification of changes to the primary product for an APPU or process unit shall be submitted. When a notification is made in response to a change in the primary product under §63.1400(g)(7), rationale for why it is anticipated that no amino/phenolic resins will be produced in the process unit in the future shall be included.

(5) Owners or operators of APPU or emission points (other than equipment leak components subject to §63.1410) that are added to the affected source under the provisions of §63.1400(d)(2) or (3) or under the provisions of §63.5(b)(6) shall submit reports as specified in paragraphs (h)(5)(i) through (ii) of this section.

(i) Reports shall include:

(A) A description of the process change or addition, as appropriate;

(B) The planned start-up date and the appropriate compliance date; and

(C) Identification of the emission points (except equipment leak components subject to §63.1410) specified in paragraphs (h)(5)(i)(C)(1) through (3) of this section, as applicable.

(1) All the emission points in an added APPU.

(2) All the emission points in an affected source that becomes a new affected source.

(3) All the added or created emission points resulting from a process change.

(ii) If the owner or operator wishes to request approval to use alternative monitoring parameters, alternative continuous monitoring or recordkeeping, alternative controls, engineering assessment to estimate organic HAP emissions from a batch emissions episode, or wishes to establish parameter monitoring levels according to the procedures contained in §63.1413(a)(1)(ii) or (ii), a Precompliance Report shall be submitted no later than 180 days prior to the appropriate compliance date.

(6) The information specified in paragraphs (h)(6)(i) and (ii) of this section shall be submitted when a small control device becomes a large control device, as specified in §63.1413(a)(1)(ii).

(i) Notification that a small control device has become a large control device and the site-specific test plan shall be submitted within 60 days of the date the small control device becomes a large control device. The site-specific test plan shall include the information specified in paragraph (h)(2) of this section. Approval of the site-specific test plan shall follow paragraph (h)(2) of this section.

(ii) Results of the performance test required by §63.1413(a)(1)(ii) shall be submitted within 150 days of the date the small control device becomes a large control device.

(7) Whenever a continuous process vent becomes subject to control requirements under §63.1405(a), as a result of a process change, the owner or operator shall submit a report within 60 days after the performance test or applicability assessment, whichever is sooner. The report may be submitted as part of the next Periodic Report required by paragraph (f) of this section.

(i) The report shall include the following information:

(A) A description of the process change;

(B) The results of the recalculation of the organic HAP concentration, volumetric flow rate, and or TRE index value required under §63.1412 and recorded under §63.1416(f).

(C) A statement that the owner or operator will comply with the requirements specified in §63.1405.

(ii) If a performance test is required as a result of a process change, the owner or operator shall specify that the performance test has become necessary due to a process change. This specification shall be made in the performance test notification to the Administrator, as specified in paragraph (h)(3) of this section.

(iii) If a process change does not result in additional applicable requirements, then the owner or operator shall include a statement documenting this in the next Periodic Report required by paragraph (f) of this section.

(8) *Electronic reporting.* Within 60 days after the date of completing each performance test (as defined in §63.2), the owner or operator must submit the results of the performance tests, including any associated fuel analyses, required by this subpart according to the methods specified in paragraphs (h)(8)(i) or (ii) of this section.

(i) For data collected using test methods supported by the EPA-provided software, the owner or operator shall submit the results of the performance test to the EPA by direct computer-to-computer electronic transfer via EPA-provided software, unless otherwise approved by the Administrator. Owners or operators, who claim that some of the information being submitted for performance tests is confidential business information (CBI), must submit a complete file using EPA-provided software that includes information claimed to be CBI on a compact disc, flash drive, or other commonly used electronic storage media to the EPA. The electronic media must be clearly marked as CBI and mailed to U.S. EPA/OAPQS/CORE CBI Office, Attention: WebFIRE Administrator, MD C404-02, 4930 Old Page Rd., Durham, NC 27703. The same file with the CBI omitted must be submitted to the EPA by direct computer-to-computer electronic transfer via EPA-provided software.

(ii) For any performance test conducted using test methods that are not compatible with the EPA-provided software, the owner or operator shall submit the results of the performance test to the Administrator at the appropriate address listed in §60.4.

(i) *Operating permit application.* An owner or operator who submits an operating permit application instead of a Precompliance Report shall submit the information specified in paragraph (d) of this section, Precompliance Report, as applicable.

(j) *Alternative monitoring parameters.* The owner or operator who has been directed by any section of this subpart or any section of another subpart referenced by this subpart that expressly referenced this paragraph (j) to set unique monitoring parameters, or who requests approval to monitor a different

parameter than those specified in §63.1415(b), shall submit the information specified in paragraphs (j)(1) through (3) of this section in the Precompliance Report, as required by paragraph (d) of this section.

(1) The required information shall include a description of the parameter(s) to be monitored to ensure the recovery device, control device, or control technology is operated in conformance with its design and achieves the specified emission limit or percent reduction and an explanation of the criteria used to select the parameter(s).

(2) The required information shall include a description of the methods and procedures that will be used to demonstrate that the parameter indicates proper operation, the schedule for this demonstration, and a statement that the owner or operator will establish a level for the monitored parameter as part of the Notification of Compliance Status report required in paragraph (e) of this section, unless this information has already been included in the operating permit application.

(3) The required information shall include a description of the proposed monitoring, recordkeeping, and reporting system to include the frequency and content of monitoring, recordkeeping, and reporting. Further, the rationale for the proposed monitoring, recordkeeping, and reporting system shall be included if either condition in paragraph (j)(3)(i) or (ii) of this section is met:

(i) If monitoring and recordkeeping is not continuous; or

(ii) If reports of daily average values will not be included in Periodic Reports when the monitored parameter value is above the maximum level or below the minimum level as established in the operating permit or the Notification of Compliance Status.

(k) *Alternative continuous monitoring.* An owner or operator choosing not to implement the monitoring provisions specified in §63.1415 for storage vessels, continuous process vents, batch process vents, or aggregate batch vent streams may instead request approval to use alternative continuous monitoring provisions according to the procedures specified in paragraphs (k)(1) through (4) of this section. Requests shall be submitted in the Precompliance Report as specified in paragraph (d)(4) of this section if not already included in the operating permit application and shall contain the information specified in paragraphs (k)(2)(i) and (ii) of this section, as applicable.

(1) The provisions in §63.8(f)(5)(i) shall govern the review and approval of requests.

(2) An owner or operator of an affected source that does not have an automated monitoring and recording system capable of measuring parameter values at least once every 15 minutes and that does not generate continuous records may request approval to use a nonautomated system with less frequent monitoring in accordance with paragraphs (k)(2)(i) and (ii) of this section.

(i) The requested system shall include manual reading and recording of the value of the relevant operating parameter no less frequently than once per hour. Daily average (or batch cycle daily average) values shall be calculated from these hourly values and recorded.

(ii) The request shall contain:

(A) A description of the planned monitoring and recordkeeping system;

(B) Documentation that the affected source does not have an automated monitoring and recording system;

(C) Justification for requesting an alternative monitoring and recordkeeping system; and

(D) Demonstration to the Administrator's satisfaction that the proposed monitoring frequency is sufficient to represent control or recovery device operating conditions, considering typical variability of the specific process and control or recovery device operating parameter being monitored.

(3) An owner or operator may request approval to use an automated data compression recording system that does not record monitored operating parameter values at a set frequency (for example, once every 15 minutes) but records all values that meet set criteria for variation from previously recorded values, in accordance with paragraphs (k)(3)(i) and (ii) of this section.

(i) The requested system shall be designed to:

(A) Measure the operating parameter value at least once every 15 minutes;

(B) Except for the monitoring of batch process vents, calculate hourly average values each hour during periods of operation;

(C) Record the date and time when monitors are turned off or on;

(D) Recognize unchanging data that may indicate the monitor is not functioning properly, alert the operator, and record the incident;

(E) Calculate daily average, batch cycle daily average, or block average values of the monitored operating parameter based on all measured data; and

(F) If the daily average is not a deviation, as defined in §63.1413(i), from the operating parameter, the data for that operating day may be converted to hourly average values, and the four or more individual records for each hour in the operating day may be discarded.

(ii) The request shall contain:

(A) A description of the monitoring system and data compression recording system, including the criteria used to determine which monitored values are recorded and retained;

(B) The method for calculating daily averages and batch cycle daily averages; and

(C) A demonstration that the system meets all criteria in paragraph (k)(3)(i) of this section.

(4) An owner or operator may request approval to use other alternative monitoring systems according to the procedures specified in §63.8(f)(4).

[65 FR 3290, Jan. 20, 2000, as amended at 79 FR 60933, Oct. 8, 2014]

### **§63.1418 [Reserved]**

### **§63.1419 Implementation and enforcement.**

(a) This subpart can be implemented and enforced by the U.S. EPA, or a delegated authority such as the applicable State, local, or Tribal agency. If the U.S. EPA Administrator has delegated authority to a State, local, or Tribal agency, then that agency, in addition to the U.S. EPA, has the authority to implement and enforce this subpart. Contact the applicable U.S. EPA Regional Office to find out if implementation and enforcement of this subpart is delegated to a State, local, or Tribal agency.

(b) In delegating implementation and enforcement authority of this subpart to a State, local, or Tribal agency under subpart E of this part, the authorities contained in paragraph (c) of this section are retained by the Administrator of U.S. EPA and cannot be transferred to the State, local, or Tribal agency.

(c) The authorities that cannot be delegated to State, local, or Tribal agencies are as specified in paragraphs (c)(1) through (4) of this section.

(1) Approval of alternatives to the requirements in §§63.1400 through 63.1401 and 63.1404 through 63.1410. Where these standards reference another subpart, the cited provisions will be delegated according to the delegation provisions of the referenced subpart. Where these standards reference another subpart and modify the requirements, the requirements shall be modified as described in this subpart. Delegation of the modified requirements will also occur according to the delegation provisions of the referenced subpart.

(2) Approval of major alternatives to test methods under §63.7(e)(2)(ii) and (f), as defined in §63.90, and as required in this subpart.

(3) Approval of major alternatives to monitoring under §63.8(f), as defined in §63.90, and as required in this subpart.

(4) Approval of major alternatives to recordkeeping and reporting under §63.10(f), as defined in §63.90, and as required in this subpart.

[68 FR 37359, June 23, 2003]

**Table 1 to Subpart OOO of Part 63—Applicability of General Provisions to Subpart OOO Affected Sources**

| <b>Reference</b>          | <b>Applies to subpart OOO</b> | <b>Explanation</b>   |
|---------------------------|-------------------------------|--|
| 63.1(a)(1)                | Yes                           | §63.1402 specifies definitions in addition to or that supersede definitions in §63.2.  |
| 63.1(a)(2)                | Yes                           |  |
| 63.1(a)(3)                | Yes                           | §63.1401(i) identifies those standards which overlap with the requirements of subpart OOO of this part and specify how compliance shall be achieved. |
| 63.1(a)(4)                | Yes                           | Subpart OOO (this table) specifies the applicability of each paragraph in subpart A of this part.  |
| 63.1(a)(5)                | No                            | [Reserved].  |
| 63.1(a)(6)                | Yes                           |  |
| 63.1(a)(7)-<br>63.1(a)(9) | No                            | [Reserved].  |
| 63.1(a)(10)               | Yes                           |  |
| 63.1(a)(11)               | Yes                           |  |

|                             |     |  |
|-----------------------------|-----|--|
| 63.1(a)(12)-<br>63.1(a)(14) | Yes |  |
| 63.1(b)(1)                  | No  |  |
| 63.1(b)(2)                  | Yes |  |
| 63.1(b)(3)                  | No  | §63.1400(e) provides documentation requirements for APPUs not considered affected sources.                               |
| 63.1(c)(1)                  | Yes | Subpart OOO (this table) specifies the applicability of each paragraph in subpart A of this part.                        |
| 63.1(c)(2)                  | No  | Area sources are not subject to this subpart.  |
| 63.1(c)(3)                  | No  | [Reserved].  |
| 63.1(c)(4)                  | No  | [Reserved].  |
| 63.1(c)(5)                  | Yes | Except that affected sources are not required to submit notifications overridden by this table.                          |
| 63.1(d)                     | No  | [Reserved].  |
| 63.1(e)                     | Yes |  |
| 63.2                        | Yes | §63.1402 specifies the definitions from subpart A of this part that apply to this subpart.                               |
| 63.3                        | Yes |  |
| 63.4(a)(1)-<br>63.4(a)(3)   | Yes |  |
| 63.4(a)(4)                  | No  | [Reserved].  |
| 63.4(a)(5)                  | Yes |  |
| 63.4(b)                     | Yes |  |
| 63.4(c)                     | Yes |  |
| 63.5(a)(1)                  | Yes | Except the terms “source” and “stationary source” should be interpreted as having the same meaning as “affected source.” |
| 63.5(a)(2)                  | Yes |  |
| 63.5(b)(1)                  | Yes | Except §63.1400(d) specifies when construction or reconstruction is subject to new source standards.                     |
| 63.5(b)(2)                  | No  | [Reserved].  |
| 63.5(b)(3)                  | Yes |  |
| 63.5(b)(4)                  | Yes | Except that the Initial Notification and §63.9(b) requirements do not apply.   |

|                 |     |   |
|-----------------|-----|---|
| 63.5(b)(5)      | Yes |   |
| 63.5(b)(6)      | Yes | Except that §63.1400(d) specifies when construction or reconstruction is subject to new source standards. |
| 63.5(c)         | No  | [Reserved].   |
| 63.5(d)(1)(i)   | Yes | Except that the references to the Initial Notification and §63.9(b)(5) do not apply.                      |
| 63.5(d)(1)(ii)  | Yes | Except that §63.5(d)(1)(ii)(H) does not apply.  |
| 63.5(d)(1)(iii) | No  | §63.1417(e) specifies Notification of Compliance Status requirements.                                     |
| 63.5(d)(2)      | No  |   |
| 63.5(d)(3)      | Yes | Except §63.5(d)(3)(ii) does not apply, and equipment leaks subject to §63.1410 are exempt.                |
| 63.5(d)(4)      | Yes |   |
| 63.5(e)         | Yes |   |
| 63.5(f)(1)      | Yes |   |
| 63.5(f)(2)      | Yes | Except that where §63.9(b)(2) is referred to, the owner or operator need not comply.                      |
| 63.6(a)         | Yes |   |
| 63.6(b)(1)      | Yes |   |
| 63.6(b)(2)      | Yes |   |
| 63.6(b)(3)      | Yes |   |
| 63.6(b)(4)      | Yes |   |
| 63.6(b)(5)      | Yes |   |
| 63.6(b)(6)      | No  | [Reserved].   |
| 63.6(b)(7)      | No  |   |
| 63.6(c)(1)      | Yes | Except that §63.1401 specifies the compliance date.   |
| 63.6(c)(2)      | No  |   |
| 63.6(c)(3)      | No  | [Reserved].   |
| 63.6(c)(4)      | No  | [Reserved].   |
| 63.6(c)(5)      | Yes |   |
| 63.6(d)         | No  | [Reserved].   |
| 63.6(e)         | Yes | Except as otherwise specified in this table.  |



|                  |     |   |
|------------------|-----|---|
| 63.6(e)(1)(i)    | No  | See §63.1400(k)(4) for general duty requirement.  |
| 63.6(e)(1)(ii)   | No  |   |
| 63.6(e)(1)(iii)  | Yes |   |
| 63.6(e)(2)       | Yes |   |
| 63.6(e)(3)       | No  |   |
| 63.6(f)(1)       | No  |   |
| 63.6(f)(2)       | Yes | Except §63.7(c), as referred to in §63.6(f)(2)(iii)(D), does not apply, and except that §63.6(f)(2)(ii) does not apply to equipment leaks subject to §63.1410.  |
| 63.6(f)(3)       | Yes |   |
| 63.6(g)          | Yes |   |
| 63.6(h)          | No  | This subpart OOO does not require opacity and visible emission standards.   |
| 63.6(i)(1)       | Yes |   |
| 63.6(i)(2)       | Yes |   |
| 63.6(i)(3)       | Yes |   |
| 63.6(i)(4)(i)(A) | Yes |   |
| 63.6(i)(4)(i)(B) | No  | Dates are specified in §§63.1401(e) and 63.1417(d)(1).  |
| 63.6(i)(4)(ii)   | No  |   |
| 63.6(i)(5)-(14)  | Yes |   |
| 63.6(i)(15)      | No  | [Reserved].   |
| 63.6(i)(16)      | Yes |   |
| 63.6(j)          | Yes |   |
| 63.7(a)(1)       | Yes |   |
| 63.7(a)(2)       | No  | §63.1417(e) specifies the submittal dates of performance test results for all emission points except equipment leaks; for equipment leaks, compliance demonstration results are reported in the Periodic Reports. |
| 63.7(a)(3)       | Yes |   |
| 63.7(b)          | No  | §63.1417 specifies notification requirements.   |
| 63.7(c)          | No  |   |
| 63.7(d)          | Yes |   |

|                           |     |  |
|---------------------------|-----|--|
| 63.7(e)(1)                | No  | See §63.1413(a)(2).  |
| 63.7(e)(2)                | Yes |  |
| 63.7(e)(3)                | No  | Subpart OOO specifies requirements.  |
| 63.7(e)(4)                | Yes |  |
| 63.7(f)                   | Yes | Except that if a site specific test plan is not required, the notification deadline in §63.7(f)(2)(i) shall be 60 days prior to the performance test, and in §63.7(f)(3), approval or disapproval of the alternative test method shall not be tied to the site specific test plan. |
| 63.7(g)                   | Yes | Except that the requirements in §63.1417(e) shall apply instead of the references to the Notification of Compliance Status report in §63.9(h). In addition, equipment leaks subject to §63.1410 are not required to conduct performance tests.                                     |
| 63.7(h)                   | Yes | Except §63.7(h)(4)(ii) may not be applicable, if the site-specific test plan in §63.7(c)(2) is not required.   |
| 63.8(a)(1)                | Yes |  |
| 63.8(a)(2)                | No  |  |
| 63.8(a)(3)                | No  | [Reserved].  |
| 63.8(a)(4)                | Yes |  |
| 63.8(b)(1)                | Yes |  |
| 63.8(b)(2)                | No  | Subpart OOO specifies locations to conduct monitoring.   |
| 63.8(b)(3)                | Yes |  |
| 63.8(c)(1)                | Yes |  |
| 63.8(c)(1)(i)             | No  |  |
| 63.8(c)(1)(ii)            | No  |  |
| 63.8(c)(1)(iii)           | No  |  |
| 63.8(c)(2)                | Yes |  |
| 63.8(c)(3)                | Yes |  |
| 63.8(c)(4)                | No  | §63.1415 specifies monitoring frequency; not applicable to equipment leaks because §63.1410 does not require continuous monitoring systems.  |
| 63.8(c)(5)-<br>63.8(c)(8) | No  |  |
| 63.8(d)                   | No  |  |

|                           |     |  |
|---------------------------|-----|--|
| 63.8(e)                   | No  |  |
| 63.8(f)(1)-<br>63.8(f)(3) | Yes |  |
| 63.8(f)(4)(i)             | No  | Timeframe for submitting request is specified in §63.1417 (j) or (k); not applicable to equipment leaks because §63.1410 (through reference to 40 CFR part 63, subpart UU) specifies acceptable alternative methods. |
| 63.8(f)(4)(ii)            | No  | Contents of request are specified in §63.1417(j) or (k).   |
| 63.8(f)(4)(iii)           | No  |  |
| 63.8(f)(5)(i)             | Yes |  |
| 63.8(f)(5)(ii)            | No  |  |
| 63.8(f)(5)(iii)           | Yes |  |
| 63.8(f)(6)                | No  | Subpart OOO does not require continuous emission monitors.   |
| 63.8(g)                   | No  | Data reduction procedures specified in §63.1416(a) and (h); not applicable to equipment leaks.   |
| 63.9(a)                   | Yes |  |
| 63.9(b)                   | No  | Subpart OOO does not require an initial notification.  |
| 63.9(c)                   | Yes |  |
| 63.9(d)                   | Yes |  |
| 63.9(e)                   | No  | §63.1417 specifies notification deadlines.   |
| 63.9(f)                   | No  | Subpart OOO does not require opacity and visible emission standards.   |
| 63.9(g)                   | No  |  |
| 63.9(h)                   | No  | §63.1417(e) specifies Notification of Compliance Status requirements.  |
| 63.9(i)                   | Yes |  |
| 63.9(j)                   | No  |  |
| 63.10(a)                  | Yes |  |
| 63.10(b)(1)               | No  | §63.1416(a) specifies record retention requirements.   |
| 63.10(b)(2)               | No  | Subpart OOO specifies recordkeeping requirements.  |
| 63.10(b)(3)               | No  | §63.1400(e) requires documentation of sources that are not affected sources.   |
| 63.10(c)                  | No  | §63.1416 specifies recordkeeping requirements.   |

|             |     |  |
|-------------|-----|--|
| 63.10(d)(1) | Yes |  |
| 63.10(d)(2) | No  | §63.1417 specifies performance test reporting requirements; not applicable to equipment leaks. |
| 63.10(d)(3) | No  | Subpart OOO does not require opacity and visible emission standards.                           |
| 63.10(d)(4) | Yes |  |
| 63.10(d)(5) | No  | See §63.1417(g) for malfunction reporting requirements.  |
| 63.10(e)    | No  | §63.1417 specifies reporting requirements.   |
| 63.10(f)    | Yes |  |
| 63.11       | Yes | Except that instead of §63.11(b), §63.1413(g) shall apply.                                     |
| 63.12       | Yes |  |
| 63.13-63.15 | Yes |  |

[65 FR 3290, Jan. 20, 2000, as amended at 71 FR 20461, Apr. 20, 2006; 79 FR 60934, Oct. 8, 2014]

**Table 2 to Subpart OOO of Part 63—Known Organic Hazardous Air Pollutants (HAP) From the Manufacture of Amino/Phenolic Resins**

| Organic HAP                      | CAS Number | Organic HAP subject to cooling tower monitoring requirements in §63.1409 (Yes/No) |          |
|----------------------------------|------------|---|----------|
|                                  |            | Column A  | Column B |
| Acrylamide                       | 79-06-1    | No  | No       |
| Aniline                          | 62-53-3    | Yes   | No       |
| Biphenyl                         | 92-52-4    | Yes   | Yes      |
| Cresol and cresylic acid (mixed) | 1319-77-3  | Yes   | No       |
| Cresol and cresylic acid (m-)    | 108-39-4   | Yes   | No       |
| Cresol and cresylic acid (o-)    | 95-48-7    | Yes   | No       |
| Cresol and cresylic acid (p-)    | 106-44-5   | Yes   | No       |
| Diethanolamine                   | 111-42-2   | No  | No       |
| Dimethylformamide                | 68-12-2    | No  | No       |
| Ethylbenzene                     | 100-41-4   | Yes   | Yes      |

|                        |           |     |     |
|------------------------|-----------|-----|-----|
| Ethylene glycol        | 107-21-1  | No  | No  |
| Formaldehyde           | 50-00-0   | Yes | No  |
| Glycol ethers          | 0         | No  | No  |
| Methanol               | 67-56-1   | Yes | Yes |
| Methyl ethyl ketone    | 78-93-3   | Yes | Yes |
| Methyl isobutyl ketone | 108-10-1  | Yes | Yes |
| Naphthalene            | 91-20-3   | Yes | Yes |
| Phenol                 | 108-95-2  | Yes | No  |
| Styrene                | 100-42-5  | Yes | Yes |
| Toluene                | 108-88-3  | No  | Yes |
| Xylenes (NOS)          | 1330-20-7 | Yes | Yes |
| Xylene (m-)            | 108-38-3  | Yes | Yes |
| Xylene (o-)            | 95-47-6   | Yes | Yes |
| Xylene (p-)            | 106-42-3  | Yes | Yes |

CAS No. = Chemical Abstract Registry Number.

**Table 3 to Subpart OOO of Part 63—Batch Process Vent Monitoring Requirements**

| <b>Control device</b>        | <b>Parameters to be monitored</b>   | <b>Frequency/recordkeeping requirements</b>  |
|------------------------------|---|--|
| Scrubber <sup>a</sup>        | pH of scrubber effluent, and  | Continuous records as specified in §63.1416(d). <sup>b</sup>   |
|                              | Scrubber liquid and gas flow rates  | Continuous records as specified in §63.1416(d). <sup>b</sup>   |
| Absorber <sup>a</sup>        | Exit temperature of the absorbing liquid, and                                   | Continuous records as specified in §63.1416(d). <sup>b</sup>   |
|                              | Exit specific gravity for the absorbing liquid                                  | Continuous records as specified in §63.1416(d). <sup>b</sup>   |
| Condenser <sup>a</sup>       | Exit (product side) temperature   | Continuous records as specified in §63.1416(d). <sup>a</sup>   |
| Carbon adsorber <sup>a</sup> | Total regeneration steam flow or nitrogen flow, or pressure (gauge or absolute) | Record the total regeneration steam flow or nitrogen flow, or pressure for each carbon bed regeneration cycle. |

|   |  |  |
|---|--|--|
|   | during carbon bed regeneration cycle(s), and   |  |
|   | Temperature of the carbon bed after regeneration and within 15 minutes of completing any cooling cycle(s)    | Record the temperature of the carbon bed after each regeneration and within 15 minutes of completing any cooling cycle(s).   |
| Thermal incinerator   | Firebox temperature <sup>c</sup>   | Continuous records as specified in §63.1416(d). <sup>b</sup>   |
| Catalytic incinerator   | Temperature upstream and downstream of the catalyst bed  | Continuous records as specified in §63.1416(d). <sup>b</sup>   |
| Boiler or process heater with a design heat input capacity less than 44 megawatts and where the batch process vents or aggregate batch vent streams are not introduced with or used as the primary fuel | Firebox temperature <sup>c</sup>   | Continuous records as specified in §63.1416(d). <sup>b</sup>   |
| Flare   | Presence of a flame at the pilot light   | Hourly records of whether the monitor was continuously operating during batch emission episodes, or portions thereof, selected for control and whether a flame was continuously present at the pilot light during said periods.        |
| All control devices   | Diversion to the atmosphere from the control device or   | Hourly records of whether the flow indicator was operating during batch emission episodes, or portions thereof, selected for control and whether a diversion was detected at any time during said periods as specified in §63.1416(d). |
|   | Monthly inspections of sealed valves   | Records that monthly inspections were performed as specified in §63.1416(d).   |
| Scrubber, absorber, condenser, and carbon adsorber (as an alternative to the requirements previously presented in this  | Concentration level or reading indicated by an organic monitoring device at the outlet of the control device | Continuous records as specified in §63.1416(d). <sup>b</sup>   |

|        |  |  |
|--------|--|--|
| table) |  |  |
|--------|--|--|

<sup>a</sup>Alternatively, these devices may comply with the organic monitoring device provisions listed at the end of this table.

<sup>b</sup>“Continuous records” is defined in §63.111.

<sup>c</sup>Monitor may be installed in the firebox or in the ductwork immediately downstream of the firebox before any substantial heat exchange is encountered.

**Table 4 to Subpart OOO of Part 63—Operating Parameter Levels**

| <b>Device</b>  | <b>Parameters to be monitored</b>   | <b>Established operating parameter(s)</b>  |
|--|---|--|
| Scrubber   | pH of scrubber effluent; and scrubber liquid and gas flow rates   | Minimum pH; and minimum liquid/gas ratio   |
| Absorber   | Exit temperature of the absorbing liquid; and exit specific gravity of the absorbing liquid   | Maximum temperature; and maximum specific gravity  |
| Condenser  | Exit temperature  | Maximum temperature  |
| Carbon absorber  | Total regeneration steam or nitrogen flow, or pressure (gauge or absolute) <sup>a</sup> during carbon bed regeneration cycle; and temperature of the carbon bed after regeneration (and within 15 minutes of completing any cooling cycle(s)) | Maximum flow or pressure; and maximum temperature  |
| Thermal incinerator  | Firebox temperature   | Minimum temperature  |
| Catalytic incinerator  | Temperature upstream and downstream of the catalyst bed   | Minimum upstream temperature; and minimum temperature difference across the catalyst bed |
| Boiler or process heater   | Firebox temperature   | Minimum temperature  |
| Other devices (or as an alternate to the requirements previously presented in this table) <sup>b</sup> | Organic HAP concentration level or reading at outlet of device  | Maximum organic HAP concentration or reading   |

<sup>a</sup>25 to 50 mm (absolute) is a common pressure level obtained by pressure swing absorbers.

<sup>b</sup>Concentration is measured instead of an operating parameter.

**Table 5 to Subpart OOO of Part 63—Reports Required by This Subpart**

| <b>Reference</b>                       | <b>Description of report</b>   | <b>Due date</b>   |
|--|--|---|
| §63.1400(j) and Subpart A of this part | Refer to Table 1 and Subpart A of this part  | Refer to Subpart A of this part.  |
| 63.1417(d)                             | Precompliance Report   | Existing affected sources—12 months prior to the compliance date. New affected sources—with application for approval of construction or reconstruction. |
| 63.1417(e)                             | Notification of Compliance Status  | Within 150 days after the compliance date.  |
| 63.1417(f)                             | Periodic Reports   | Semiannually, no later than 60 days after the end of each 6-month period. See §63.1417(f)(1) for the due date for the first report.                     |
| 63.1417(f)(12)                         | Quarterly reports upon request of the administrator                                      | No later than 60 days after the end of each quarter.  |
| 63.1417(g)                             | Start-up, shutdown, and malfunction reports  | Semiannually (same schedule as Periodic reports).   |
| 63.1417(h)(1)                          | Notification of storage vessel inspection  | As specified in 40 CFR part 63, subpart WW.   |
| 63.1417(h)(2)                          | Site-specific test plan  | 90 days prior to planned date of test.  |
| 63.1417(h)(3)                          | Notification of planned performance test   | 30 days prior to planned date of test.  |
| 63.1417(h)(4)                          | Notification of change in primary product  | As specified in §63.1400 (g)(7) or (g)(8).  |
| 63.1417(h)(5)                          | Notification of added emission points  | 180 days prior to the appropriate compliance date.  |
| 63.1417(h)(6)                          | Notification that a small control device has been redesignated as a large control device | Within 60 days of the redesignation of control device size.   |
| 63.1417(h)(7)                          | Notification of process change   | Within 60 days after performance test or applicability assessment, whichever is sooner.   |
| 63.1417(h)(8)                          | Electronic reporting   | Within 60 days after completing performance test.   |

<sup>a</sup>Note that the APPU remains subject to this subpart until the notification under §63.1400(g)(7) is made.



**Table 6 to Subpart OOO of Part 63—Coefficients for Total Resource Effectiveness<sup>a</sup>**

| <b>Control device basis</b>             | <b>Values of coefficients</b> |                       |                        |
|---|-------------------------------|-----------------------|------------------------|
|   | <b>A</b>                      | <b>B</b>              | <b>C</b>               |
| Flare                                   | $5.276 \times 10^{-1}$        | $9.98 \times 10^{-2}$ | $2.096 \times 10^{-3}$ |
| Thermal Incinerator 0 Percent Recovery  | $4.068 \times 10^{-1}$        | $1.71 \times 10^{-2}$ | $8.664 \times 10^{-3}$ |
| Thermal Incinerator 70 Percent Recovery | $6.868 \times 10^{-1}$        | $3.21 \times 10^{-3}$ | $3.546 \times 10^{-3}$ |

<sup>a</sup>Use according to procedures outlined in this section.

MJ/scm = MegaJoules per standard cubic meter.

scm/min = Standard cubic meters per minute.

**Appendix K**

40 C.F.R. Part 63, Subpart FFFF – *National Emission Standards for Hazardous Air Pollutants  
for Miscellaneous Organic NESHAPS (MON)*

## Subpart FFFF—National Emission Standards for Hazardous Air Pollutants: Miscellaneous Organic Chemical Manufacturing

### WHAT THIS SUBPART COVERS

#### §63.2430 What is the purpose of this subpart?

This subpart establishes national emission standards for hazardous air pollutants (NESHAP) for miscellaneous organic chemical manufacturing. This subpart also establishes requirements to demonstrate initial and continuous compliance with the emission limits, operating limits, and work practice standards.

#### §63.2435 Am I subject to the requirements in this subpart?

(a) You are subject to the requirements in this subpart if you own or operate miscellaneous organic chemical manufacturing process units (MCPU) that are located at, or are part of, a major source of hazardous air pollutants (HAP) emissions as defined in section 112(a) of the Clean Air Act (CAA).

(b) An MCPU includes equipment necessary to operate a miscellaneous organic chemical manufacturing process, as defined in §63.2550, that satisfies all of the conditions specified in paragraphs (b)(1) through (3) of this section. An MCPU also includes any assigned storage tanks and transfer racks; equipment in open systems that is used to convey or store water having the same concentration and flow characteristics as wastewater; and components such as pumps, compressors, agitators, pressure relief devices, sampling connection systems, open-ended valves or lines, valves, connectors, and instrumentation systems that are used to manufacture any material or family of materials described in paragraphs (b)(1)(i) through (v) of this section.

(1) The MCPU produces material or family of materials that is described in paragraph (b)(1)(i), (ii), (iii), (iv), or (v) of this section.

(i) An organic chemical(s) classified using the 1987 version of SIC code 282, 283, 284, 285, 286, 287, 289, or 386, except as provided in paragraph (c)(5) of this section.

(ii) An organic chemical(s) classified using the 1997 version of NAICS code 325, except as provided in paragraph (c)(5) of this section.

(iii) Quaternary ammonium compounds and ammonium sulfate produced with caprolactam.

(iv) Hydrazine.

(v) Organic solvents classified in any of the SIC or NAICS codes listed in paragraph (b)(1)(i) or (ii) of this section that are recovered using nondedicated solvent recovery operations.

(2) The MCPU processes, uses, or generates any of the organic HAP listed in section 112(b) of the CAA or hydrogen halide and halogen HAP, as defined in §63.2550.

(3) The MCPU is not an affected source or part of an affected source under another subpart of this part 63, except for process vents from batch operations within a chemical manufacturing process unit (CMPU), as identified in §63.100(j)(4). For this situation, the MCPU is the same as the CMPU as defined in §63.100, and you are subject only to the requirements for batch process vents in this subpart.

(c) The requirements in this subpart do not apply to the operations specified in paragraphs (c)(1) through (7) of this section.

(1) Research and development facilities, as defined in section 112(c)(7) of the CAA.

(2) The manufacture of ammonium sulfate as a by-product, if the slurry entering the by-product manufacturing process contains 50 parts per million by weight (ppmw) HAP or less or 10 ppmw benzene or less. You must retain information, data, and analysis to document the HAP concentration in the entering slurry in order to claim this exemption.

(3) The affiliated operations located at an affected source under subparts GG (National Emission Standards for Aerospace Manufacturing and Rework Facilities), KK (National Emission Standards for the Printing and Publishing Industry), JJJJ (NESHAP: Paper and Other Web Coating), future MMMM (NESHAP: Surface Coating of Miscellaneous Metal Parts and Products), and SSSS (NESHAP: Surface Coating of Metal Coil) of this part 63. Affiliated operations include, but are not limited to, mixing or dissolving of coating ingredients; coating mixing for viscosity adjustment, color tint or additive blending, or pH adjustment; cleaning of coating lines and coating line parts; handling and storage of coatings and solvent; and conveyance and treatment of wastewater.

(4) Fabricating operations (such as spinning or compressing a solid polymer into its end use); compounding operations (in which blending, melting, and resolidification of a solid polymer product occur for the purpose of incorporating additives, colorants, or stabilizers); and extrusion and drawing operations (converting an already produced solid polymer into a different shape by melting or mixing the polymer and then forcing it or pulling it through an orifice to create an extruded product). An operation is not exempt if it involves processing with HAP solvent or if an intended purpose of the operation is to remove residual HAP monomer.

(5) Production activities described using the 1997 version of NAICS codes 325131, 325181, 325188 (except the requirements do apply to hydrazine), 325314, 325991 (except the requirements do apply to reformulating plastics resins from recycled plastics products), and 325992 (except the requirements do apply to photographic chemicals).

(6) Tall oil recovery systems.

(7) Carbon monoxide production.

(d) If the predominant use of a transfer rack loading arm or storage tank (including storage tanks in series) is associated with a miscellaneous organic chemical manufacturing process, and the loading arm or storage tank is not part of an affected source under a subpart of this part 63, then you must assign the loading arm or storage tank to the MCPU for that miscellaneous organic chemical manufacturing process. If the predominant use cannot be determined, then you may assign the loading arm or storage tank to any MCPU that shares it and is subject to this subpart. If the use varies from year to year, then you must base the determination on the utilization that occurred during the year preceding November 10, 2003 or, if the loading arm or storage tank was not in operation during that year, you must base the use on the expected use for the first 5-year period after startup. You must include the determination in the notification of compliance status report specified in §63.2520(d). You must redetermine the primary use at least once every 5 years, or any time you implement emissions averaging or pollution prevention after the compliance date.

(e) For nondedicated equipment used to create at least one MCPU, you may elect to develop process unit groups (PUG), determine the primary product of each PUG, and comply with the requirements of the subpart in 40 CFR part 63 that applies to that primary product as specified in §63.2535(l).

**§63.2440 What parts of my plant does this subpart cover?**

(a) This subpart applies to each miscellaneous organic chemical manufacturing affected source.

(b) The miscellaneous organic chemical manufacturing affected source is the facilitywide collection of MCPU and heat exchange systems, wastewater, and waste management units that are associated with manufacturing materials described in §63.2435(b)(1).

(c) A new affected source is described by either paragraph (c)(1) or (2) of this section.

(1) Each affected source defined in paragraph (b) of this section for which you commenced construction or reconstruction after April 4, 2002, and you meet the applicability criteria at the time you commenced construction or reconstruction.

(2) Each dedicated MCPU that has the potential to emit 10 tons per year (tpy) of any one HAP or 25 tpy of combined HAP, and you commenced construction or reconstruction of the MCPU after April 4, 2002. For the purposes of this paragraph, an MCPU is an affected source in the definition of the term "reconstruction" in §63.2.

(d) An MCPU that is also a CMPU under §63.100 is reconstructed for the purposes of this subpart if, and only if, the CMPU meets the requirements for reconstruction in §63.100(l)(2).

**COMPLIANCE DATES**

**§63.2445 When do I have to comply with this subpart?**

(a) If you have a new affected source, you must comply with this subpart according to the requirements in paragraphs (a)(1) and (2) of this section.

(1) If you startup your new affected source before November 10, 2003, then you must comply with the requirements for new sources in this subpart no later than November 10, 2003.

(2) If you startup your new affected source after November 10, 2003, then you must comply with the requirements for new sources in this subpart upon startup of your affected source.

(b) If you have an existing source on November 10, 2003, you must comply with the requirements for existing sources in this subpart no later than May 10, 2008.

(c) You must meet the notification requirements in §63.2515 according to the dates specified in that section and in subpart A of this part 63. Some of the notifications must be submitted before you are required to comply with the emission limits, operating limits, and work practice standards in this subpart.

(d) If you have a Group 2 emission point that becomes a Group 1 emission point after the compliance date for your affected source, you must comply with the Group 1 requirements beginning on the date the switch occurs. An initial compliance demonstration as specified in this subpart must be conducted within 150 days after the switch occurs.

(e) If, after the compliance date for your affected source, hydrogen halide and halogen HAP emissions from process vents in a process increase to more than 1,000 lb/yr, or HAP metals emissions from a process at a new affected source increase to more than 150 lb/yr, you must comply with the

applicable emission limits specified in Table 3 to this subpart and the associated compliance requirements beginning on the date the emissions exceed the applicable threshold. An initial compliance demonstration as specified in this subpart must be conducted within 150 days after the switch occurs.

(f) If you have a small control device for process vent or transfer rack emissions that becomes a large control device, as defined in §63.2550(i), you must comply with monitoring and associated recordkeeping and reporting requirements for large control devices beginning on the date the switch occurs. An initial compliance demonstration as specified in this subpart must be conducted within 150 days after the switch occurs.

[68 FR 63888, Nov. 10, 2003, as amended at 71 FR 10442, Mar. 1, 2006; 71 FR 40332, July 14, 2006]

## **EMISSION LIMITS, WORK PRACTICE STANDARDS, AND COMPLIANCE REQUIREMENTS**

### **§63.2450 What are my general requirements for complying with this subpart?**

(a) You must be in compliance with the emission limits and work practice standards in tables 1 through 7 to this subpart at all times, except during periods of startup, shutdown, and malfunction (SSM), and you must meet the requirements specified in §§63.2455 through 63.2490 (or the alternative means of compliance in §63.2495, §63.2500, or §63.2505), except as specified in paragraphs (b) through (s) of this section. You must meet the notification, reporting, and recordkeeping requirements specified in §§63.2515, 63.2520, and 63.2525.

(b) *Determine halogenated vent streams.* You must determine if an emission stream is a halogenated vent stream, as defined in §63.2550, by calculating the mass emission rate of halogen atoms in accordance with §63.115(d)(2)(v). Alternatively, you may elect to designate the emission stream as halogenated.

(c) *Requirements for combined emission streams.* When organic HAP emissions from different emission types (e.g., continuous process vents, batch process vents, storage tanks, transfer operations, and waste management units) are combined, you must comply with the requirements of either paragraph (c)(1) or (2) of this section.

(1) Comply with the applicable requirements of this subpart for each kind of organic HAP emissions in the stream (e.g., the requirements of table 1 to this subpart for continuous process vents and the requirements of table 4 to this subpart for emissions from storage tanks).

(2) Determine the applicable requirements based on the hierarchy presented in paragraphs (c)(2)(i) through (vi) of this section. For a combined stream, the applicable requirements are specified in the highest-listed paragraph in the hierarchy that applies to any of the individual streams that make up the combined stream. For example, if a combined stream consists of emissions from Group 1 batch process vents and any other type of emission stream, then you must comply with the requirements in paragraph (c)(2)(i) of this section for the combined stream; compliance with the requirements in paragraph (c)(2)(i) of this section constitutes compliance for the other emission streams in the combined stream. Two exceptions are that you must comply with the requirements in table 3 to this subpart and §63.2465 for all process vents with hydrogen halide and halogen HAP emissions, and recordkeeping requirements for Group 2 applicability or compliance are still required (e.g., the requirement in §63.2525(f) to track the number of batches produced and calculate rolling annual emissions for processes with Group 2 batch process vents).

(i) The requirements of table 2 to this subpart and §63.2460 for Group 1 batch process vents, including applicable monitoring, recordkeeping, and reporting.

(ii) The requirements of table 1 to this subpart and §63.2455 for continuous process vents that are routed to a control device, as defined in §63.981, including applicable monitoring, recordkeeping, and reporting.

(iii) The requirements of table 5 to this subpart and §63.2475 for transfer operations, including applicable monitoring, recordkeeping, and reporting.

(iv) The requirements of table 7 to this subpart and §63.2485 for emissions from waste management units that are used to manage and treat Group 1 wastewater streams and residuals from Group 1 wastewater streams, including applicable monitoring, recordkeeping, and reporting.

(v) The requirements of table 4 to this subpart and §63.2470 for control of emissions from storage tanks, including applicable monitoring, recordkeeping, and reporting.

(vi) The requirements of table 1 to this subpart and §63.2455 for continuous process vents after a recovery device including applicable monitoring, recordkeeping, and reporting.

(d) [Reserved]

(e) *Requirements for control devices.* (1) Except when complying with §63.2485, if you reduce organic HAP emissions by venting emissions through a closed-vent system to any combination of control devices (except a flare) or recovery devices, you must meet the requirements of §63.982(c) and the requirements referenced therein.

(2) Except when complying with §63.2485, if you reduce organic HAP emissions by venting emissions through a closed-vent system to a flare, you must meet the requirements of §63.982(b) and the requirements referenced therein.

(3) If you use a halogen reduction device to reduce hydrogen halide and halogen HAP emissions from halogenated vent streams, you must meet the requirements of §63.994 and the requirements referenced therein. If you use a halogen reduction device before a combustion device, you must determine the halogen atom emission rate prior to the combustion device according to the procedures in §63.115(d)(2)(v).

(f) *Requirements for flare compliance assessments.* (1) As part of a flare compliance assessment required in §63.987(b), you have the option of demonstrating compliance with the requirements of §63.11(b) by complying with the requirements in either §63.11(b)(6)(i) or §63.987(b)(3)(ii).

(2) If you elect to meet the requirements in §63.11(b)(6)(i), you must keep flare compliance assessment records as specified in paragraphs (f)(2)(i) and (ii) of this section.

(i) Keep records as specified in §63.998(a)(1)(i), except that a record of the heat content determination is not required.

(ii) Keep records of the flare diameter, hydrogen content, exit velocity, and maximum permitted velocity. Include these records in the flare compliance report required in §63.999(a)(2).

(g) *Requirements for performance tests.* The requirements specified in paragraphs (g)(1) through (5) of this section apply instead of or in addition to the requirements specified in subpart SS of this part 63.

(1) Conduct gas molecular weight analysis using Method 3, 3A, or 3B in appendix A to part 60 of this chapter.

(2) Measure moisture content of the stack gas using Method 4 in appendix A to part 60 of this chapter.

(3) If the uncontrolled or inlet gas stream to the control device contains carbon disulfide, you must conduct emissions testing according to paragraph (g)(3)(i) or (ii) of this section.

(i) If you elect to comply with the percent reduction emission limits in tables 1 through 7 to this subpart, and carbon disulfide is the principal organic HAP component (*i.e.*, greater than 50 percent of the HAP in the stream by volume), then you must use Method 18, or Method 15 (40 CFR part 60, appendix A) to measure carbon disulfide at the inlet and outlet of the control device. Use the percent reduction in carbon disulfide as a surrogate for the percent reduction in total organic HAP emissions.

(ii) If you elect to comply with the outlet total organic compound (TOC) concentration emission limits in tables 1 through 7 to this subpart, and the uncontrolled or inlet gas stream to the control device contains greater than 10 percent (volume concentration) carbon disulfide, you must use Method 18 or Method 15 to separately determine the carbon disulfide concentration. Calculate the total HAP or TOC emissions by totaling the carbon disulfide emissions measured using Method 18 or 15 and the other HAP emissions measured using Method 18 or 25A.

(4) As an alternative to using Method 18, Method 25/25A, or Method 26/26A of 40 CFR part 60, appendix A, to comply with any of the emission limits specified in tables 1 through 7 to this subpart, you may use Method 320 of 40 CFR part 60, appendix A. When using Method 320, you must follow the analyte spiking procedures of section 13 of Method 320, unless you demonstrate that the complete spiking procedure has been conducted at a similar source.

(5) Section 63.997(c)(1) does not apply. For the purposes of this subpart, results of all initial compliance demonstrations must be included in the notification of compliance status report, which is due 150 days after the compliance date, as specified in §63.2520(d)(1).

(h) *Design evaluation.* To determine the percent reduction of a small control device that is used to comply with an emission limit specified in table 1, 2, 3, or 5 to this subpart, you may elect to conduct a design evaluation as specified in §63.1257(a)(1) instead of a performance test as specified in subpart SS of this part 63. You must establish the value(s) and basis for the operating limits as part of the design evaluation. For continuous process vents, the design evaluation must be conducted at maximum representative operating conditions for the process, unless the Administrator specifies or approves alternate operating conditions. For transfer racks, the design evaluation must demonstrate that the control device achieves the required control efficiency during the reasonably expected maximum transfer loading rate.

(i) *Outlet concentration correction for combustion devices.* When §63.997(e)(2)(iii)(C) requires you to correct the measured concentration at the outlet of a combustion device to 3 percent oxygen if you add supplemental combustion air, the requirements in either paragraph (i)(1) or (2) of this section apply for the purposes of this subpart.

(1) You must correct the concentration in the gas stream at the outlet of the combustion device to 3 percent oxygen if you add supplemental gases, as defined in §63.2550, to the vent stream, or;

(2) You must correct the measured concentration for supplemental gases using Equation 1 of §63.2460; you may use process knowledge and representative operating data to determine the fraction of the total flow due to supplemental gas.

(j) *Continuous emissions monitoring systems.* Each continuous emissions monitoring system (CEMS) must be installed, operated, and maintained according to the requirements in §63.8 and paragraphs (j)(1) through (5) of this section.



(1) Each CEMS must be installed, operated, and maintained according to the applicable Performance Specification of 40 CFR part 60, appendix B, and according to paragraph (j)(2) of this section, except as specified in paragraph (j)(1)(i) of this section. For any CEMS meeting Performance Specification 8, you must also comply with appendix F, procedure 1 of 40 CFR part 60.

(i) If you wish to use a CEMS other than an Fourier Transform Infrared Spectroscopy (FTIR) meeting the requirements of Performance Specification 15 to measure hydrogen halide and halogen HAP before we promulgate a Performance Specification for such CEMS, you must prepare a monitoring plan and submit it for approval in accordance with the procedures specified in §63.8.

(ii) [Reserved]

(2) You must determine the calibration gases and reporting units for TOC CEMS in accordance with paragraph (j)(2)(i), (ii), or (iii) of this section.

(i) For CEMS meeting Performance Specification 9 or 15 requirements, determine the target analyte(s) for calibration using either process knowledge of the control device inlet stream or the screening procedures of Method 18 on the control device inlet stream.

(ii) For CEMS meeting Performance Specification 8 used to monitor performance of a combustion device, calibrate the instrument on the predominant organic HAP and report the results as carbon (C<sub>1</sub>), and use Method 25A or any approved alternative as the reference method for the relative accuracy tests.

(iii) For CEMS meeting Performance Specification 8 used to monitor performance of a noncombustion device, determine the predominant organic HAP using either process knowledge or the screening procedures of Method 18 on the control device inlet stream, calibrate the monitor on the predominant organic HAP, and report the results as C<sub>1</sub>. Use Method 18, ASTM D6420-99, or any approved alternative as the reference method for the relative accuracy tests, and report the results as C<sub>1</sub>.

(3) You must conduct a performance evaluation of each CEMS according to the requirements in 40 CFR 63.8 and according to the applicable Performance Specification of 40 CFR part 60, appendix B, except that the schedule in §63.8(e)(4) does not apply, and the results of the performance evaluation must be included in the notification of compliance status report.

(4) The CEMS data must be reduced to operating day or operating block averages computed using valid data consistent with the data availability requirements specified in §63.999(c)(6)(i)(B) through (D), except monitoring data also are sufficient to constitute a valid hour of data if measured values are available for at least two of the 15-minute periods during an hour when calibration, quality assurance, or maintenance activities are being performed. An operating block is a period of time from the beginning to end of batch operations within a process. Operating block averages may be used only for batch process vent data.

(5) If you add supplemental gases, you must correct the measured concentrations in accordance with paragraph (i) of this section and §63.2460(c)(6).

(k) *Continuous parameter monitoring.* The provisions in paragraphs (k)(1) through (6) of this section apply in addition to the requirements for continuous parameter monitoring system (CPMS) in subpart SS of this part 63.

(1) You must record the results of each calibration check and all maintenance performed on the CPMS as specified in §63.998(c)(1)(ii)(A).

(2) When subpart SS of this part 63 uses the term “a range” or “operating range” of a monitored parameter, it means an “operating limit” for a monitored parameter for the purposes of this subpart.

(3) As an alternative to continuously measuring and recording pH as specified in §§63.994(c)(1)(i) and 63.998(a)(2)(ii)(D), you may elect to continuously monitor and record the caustic strength of the effluent. For halogen scrubbers used to control only batch process vents you may elect to monitor and record either the pH or the caustic strength of the scrubber effluent at least once per day.

(4) As an alternative to the inlet and outlet temperature monitoring requirements for catalytic incinerators as specified in §63.988(c)(2) and the related recordkeeping requirements specified in §63.998(a)(2)(ii)(B)(2) and (c)(2)(ii), you may elect to comply with the requirements specified in paragraphs (k)(4)(i) through (iv) of this section.

(i) Monitor and record the inlet temperature as specified in subpart SS of this part 63.

(ii) Check the activity level of the catalyst at least every 12 months and take any necessary corrective action, such as replacing the catalyst to ensure that the catalyst is performing as designed.

(iii) Maintain records of the annual checks of catalyst activity levels and the subsequent corrective actions.

(iv) Recording the downstream temperature and temperature difference across the catalyst bed as specified in §63.998(a)(2)(ii)(B)(2) and (b)(2)(ii) is not required.

(5) For absorbers that control organic compounds and use water as the scrubbing fluid, you must conduct monitoring and recordkeeping as specified in paragraphs (k)(5)(i) through (iii) of this section instead of the monitoring and recordkeeping requirements specified in §§63.990(c)(1), 63.993(c)(1), and 63.998(a)(2)(ii)(C).

(i) You must use a flow meter capable of providing a continuous record of the absorber influent liquid flow.

(ii) You must determine gas stream flow using one of the procedures specified in §63.994(c)(1)(ii)(A) through (D).

(iii) You must record the absorber liquid-to-gas ratio averaged over the time period of any performance test.

(6) For a control device with total inlet HAP emissions less than 1 tpy, you must establish an operating limit(s) for a parameter(s) that you will measure and record at least once per averaging period (i.e., daily or block) to verify that the control device is operating properly. You may elect to measure the same parameter(s) that is required for control devices that control inlet HAP emissions equal to or greater than 1 tpy. If the parameter will not be measured continuously, you must request approval of your proposed procedure in the precompliance report. You must identify the operating limit(s) and the measurement frequency, and you must provide rationale to support how these measurements demonstrate the control device is operating properly.

(l) *Startup, shutdown, and malfunction.* Sections 63.152(f)(7)(ii) through (iv) and 63.998(b)(2)(iii) and (b)(6)(i)(A), which apply to the exclusion of monitoring data collected during periods of SSM from daily averages, do not apply for the purposes of this subpart.

(m) *Reporting.* (1) When §§63.2455 through 63.2490 reference other subparts in this part 63 that use the term “periodic report,” it means “compliance report” for the purposes of this subpart. The

compliance report must include the information specified in §63.2520(e), as well as the information specified in referenced subparts.

(2) When there are conflicts between this subpart and referenced subparts for the due dates of reports required by this subpart, reports must be submitted according to the due dates presented in this subpart.

(3) Excused excursions, as defined in subparts G and SS of this part 63, are not allowed.

(n) [Reserved]

(o) You may not use a flare to control halogenated vent streams or hydrogen halide and halogen HAP emissions.

(p) Opening a safety device, as defined in §63.2550, is allowed at any time conditions require it to avoid unsafe conditions.

(q) If an emission stream contains energetics or organic peroxides that, for safety reasons, cannot meet an applicable emission limit specified in Tables 1 through 7 to this subpart, then you must submit documentation in your precompliance report explaining why an undue safety hazard would be created if the air emission controls were installed, and you must describe the procedures that you will implement to minimize HAP emissions from these vent streams.

(r) *Surge control vessels and bottoms receivers.* For each surge control vessel or bottoms receiver that meets the capacity and vapor pressure thresholds for a Group 1 storage tank, you must meet emission limits and work practice standards specified in Table 4 to this subpart.

(s) For the purposes of determining Group status for continuous process vents, batch process vents, and storage tanks in §§63.2455, 63.2460, and 63.2470, hydrazine is to be considered an organic HAP.

[68 FR 63888, Nov. 10, 2003, as amended at 70 FR 38559, July 1, 2005; 71 FR 40332, July 14, 2006]

### **§63.2455 What requirements must I meet for continuous process vents?**

(a) You must meet each emission limit in Table 1 to this subpart that applies to your continuous process vents, and you must meet each applicable requirement specified in paragraphs (b) through (c) of this section.

(b) For each continuous process vent, you must either designate the vent as a Group 1 continuous process vent or determine the total resource effectiveness (TRE) index value as specified in §63.115(d), except as specified in paragraphs (b)(1) through (3) of this section.

(1) You are not required to determine the Group status or the TRE index value for any continuous process vent that is combined with Group 1 batch process vents before a control device or recovery device because the requirements of §63.2450(c)(2)(i) apply to the combined stream.

(2) When a TRE index value of 4.0 is referred to in §63.115(d), TRE index values of 5.0 for existing affected sources and 8.0 for new and reconstructed affected sources apply for the purposes of this subpart.

(3) When §63.115(d) refers to “emission reductions specified in §63.113(a),” the reductions specified in Table 1 to this subpart apply for the purposes of this subpart.

(c) If you use a recovery device to maintain the TRE above a specified threshold, you must meet the requirements of §63.982(e) and the requirements referenced therein, except as specified in §63.2450 and paragraph (c)(1) of this section.

(1) When §63.993 uses the phrase “the TRE index value is between the level specified in a referencing subpart and 4.0,” the phrase “the TRE index value is >1.9 but ≤5.0” applies for an existing affected source, and the phrase “the TRE index value is >5.0 but ≤8.0” applies for a new and reconstructed affected source, for the purposes of this subpart.

(2) [Reserved]

### **§63.2460 What requirements must I meet for batch process vents?**

(a) You must meet each emission limit in Table 2 to this subpart that applies to you, and you must meet each applicable requirement specified in paragraphs (b) and (c) of this section.

(b) *Group status.* If a process has batch process vents, as defined in §63.2550, you must determine the group status of the batch process vents by determining and summing the uncontrolled organic HAP emissions from each of the batch process vents within the process using the procedures specified in §63.1257(d)(2)(i) and (ii), except as specified in paragraphs (b)(1) through (7) of this section.

(1) To calculate emissions caused by the heating of a vessel without a process condenser to a temperature lower than the boiling point, you must use the procedures in §63.1257(d)(2)(i)(C)(3).

(2) To calculate emissions from depressurization of a vessel without a process condenser, you must use the procedures in §63.1257(d)(2)(i)(D)(10).

(3) To calculate emissions from vacuum systems for the purposes of this subpart, the receiving vessel is part of the vacuum system, and terms used in Equation 33 to 40 CFR part 63, subpart GGG, are defined as follows:

$P_{\text{system}}$  = absolute pressure of the receiving vessel;

$P_i$  = partial pressure of the HAP determined at the exit temperature and exit pressure conditions of the condenser or at the conditions of the dedicated receiver;

$P_j$  = partial pressure of condensables (including HAP) determined at the exit temperature and exit pressure conditions of the condenser or at the conditions of the dedicated receiver;

$MW_{\text{HAP}}$  = molecular weight of the HAP determined at the exit temperature and exit pressure conditions of the condenser or at the conditions of the dedicated receiver.

(4) To calculate uncontrolled emissions when a vessel is equipped with a process condenser, you must use the procedures in §63.1257(d)(3)(i)(B), except as specified in paragraphs (b)(4)(i) through (vii) of this section.

(i) You must determine the flowrate of gas (or volume of gas), partial pressures of condensables, temperature (T), and HAP molecular weight ( $MW_{\text{HAP}}$ ) at the exit temperature and exit pressure conditions of the condenser or at the conditions of the dedicated receiver.

(ii) You must assume that all of the components contained in the condenser exit vent stream are in equilibrium with the same components in the exit condensate stream (except for noncondensables).

(iii) You must perform a material balance for each component.

(iv) For the emissions from gas evolution, the term for time,  $t$ , must be used in Equation 12 to 40 CFR part 63, subpart GGG.

(v) Emissions from empty vessel purging shall be calculated using Equation 36 to 40 CFR part 63, subpart GGG and the exit temperature and exit pressure conditions of the condenser or the conditions of the dedicated receiver.

(vi) You must conduct an engineering assessment as specified in §63.1257(d)(2)(ii) for each emission episode that is not due to vapor displacement, purging, heating, depressurization, vacuum operations, gas evolution, air drying, or empty vessel purging. The requirements of paragraphs (b)(3) through (4) of this section shall apply.

(vii) You may elect to conduct an engineering assessment if you can demonstrate to the Administrator that the methods in §63.1257(d)(3)(i)(B) are not appropriate.

(5) You may elect to designate the batch process vents within a process as Group 1 and not calculate uncontrolled emissions under either of the situations in paragraph (b)(5)(i), (ii), or (iii) of this section.

(i) If you comply with the alternative standard specified in §63.2505.

(ii) If all Group 1 batch process vents within a process are controlled; you conduct the performance test under hypothetical worst case conditions, as defined in §63.1257(b)(8)(i)(B); and the emission profile is based on capture and control system limitations as specified in §63.1257(b)(8)(ii)(C).

(iii) If you comply with an emission limit using a flare that meets the requirements specified in §63.987.

(6) You may change from Group 2 to Group 1 in accordance with either paragraph (b)(6)(i) or (ii) of this section. You must comply with the requirements of this section and submit the test report in the next Compliance report.

(i) You may switch at any time after operating as Group 2 for at least 1 year so that you can show compliance with the 10,000 pounds per year (lb/yr) threshold for Group 2 batch process vents for at least 365 days before the switch. You may elect to start keeping records of emissions from Group 2 batch process vents before the compliance date. Report a switch based on this provision in your next compliance report in accordance with §63.2520(e)(10)(i).

(ii) If the conditions in paragraph (b)(6)(i) of this section are not applicable, you must provide a 60-day advance notice in accordance with §63.2520(e)(10)(ii) before switching.

(7) As an alternative to determining the uncontrolled organic HAP emissions as specified in §63.1257(d)(2)(i) and (ii), you may elect to demonstrate that non-reactive organic HAP are the only HAP used in the process and non-reactive HAP usage in the process is less than 10,000 lb/yr. You must provide data and supporting rationale in your notification of compliance status report explaining why the non-reactive organic HAP usage will be less than 10,000 lb/yr. You must keep records of the non-reactive organic HAP usage as specified in §63.2525(e)(2) and include information in compliance reports as specified in §63.2520(e)(5)(iv).

(c) Exceptions to the requirements in subparts SS and WW of this part 63 are specified in paragraphs (c)(1) through (9) of this section.

(1) *Process condensers.* Process condensers, as defined in §63.2550(i), are not considered to be control devices for batch process vents. You must determine whether a condenser is a control device for a batch process vent or a process condenser from which the uncontrolled HAP emissions are evaluated as part of the initial compliance demonstration for each MCPU and report the results with supporting rationale in your notification of compliance status report.

(2) *Initial compliance.* (i) To demonstrate initial compliance with a percent reduction emission limit in Table 2 to this subpart FFFF, you must compare the sums of the controlled and uncontrolled emissions for the applicable Group 1 batch process vents within the process, and show that the specified reduction is met. This requirement does not apply if you comply with the emission limits of Table 2 to this subpart FFFF by using a flare that meets the requirements of §63.987.

(ii) When you conduct a performance test or design evaluation for a non-flare control device used to control emissions from batch process vents, you must establish emission profiles and conduct the test under worst-case conditions according to §63.1257(b)(8) instead of under normal operating conditions as specified in §63.7(e)(1). The requirements in §63.997(e)(1)(i) and (iii) also do not apply for performance tests conducted to determine compliance with the emission limits for batch process vents. For purposes of this subpart FFFF, references in §63.997(b)(1) to “methods specified in §63.997(e)” include the methods specified in §63.1257(b)(8).

(iii) As an alternative to conducting a performance test or design evaluation to demonstrate initial compliance with a percent reduction requirement for a condenser, you may determine controlled emissions using the procedures specified in §63.1257(d)(3)(i)(B) and paragraphs (b)(3) through (4) of this section.

(iv) When §63.1257(d)(3)(i)(B)(7) specifies that condenser-controlled emissions from an air dryer must be calculated using Equation 11 of 40 CFR part 63, subpart GGG, with “V equal to the air flow rate,” it means “V equal to the dryer outlet gas flow rate,” for the purposes of this subpart. Alternatively, you may use Equation 12 of 40 CFR part 63, subpart GGG, with V equal to the dryer inlet air flow rate. Account for time as appropriate in either equation.

(v) If a process condenser is used for any boiling operations, you must demonstrate that it is properly operated according to the procedures specified in §63.1257(d)(2)(i)(C)(4)(ii) and (d)(3)(iii)(B), and the demonstration must occur only during the boiling operation. The reference in §63.1257(d)(3)(iii)(B) to the alternative standard in §63.1254(c) means §63.2505 for the purposes of this subpart. As an alternative to measuring the exhaust gas temperature, as required by §63.1257(d)(3)(iii)(B), you may elect to measure the liquid temperature in the receiver.

(vi) You must conduct a subsequent performance test or compliance demonstration equivalent to an initial compliance demonstration within 180 days of a change in the worst-case conditions.

(3) *Establishing operating limits.* You must establish operating limits under the conditions required for your initial compliance demonstration, except you may elect to establish operating limit(s) for conditions other than those under which a performance test was conducted as specified in paragraph (c)(3)(i) of this section and, if applicable, paragraph (c)(3)(ii) of this section.

(i) The operating limits may be based on the results of the performance test and supplementary information such as engineering assessments and manufacturer's recommendations. These limits may be established for conditions as unique as individual emission episodes for a batch process. You must provide rationale in the precompliance report for the specific level for each operating limit, including any data and calculations used to develop the limit and a description of why the limit indicates proper operation of the control device. The procedures provided in this paragraph (c)(3)(i) have not been approved by the Administrator and determination of the operating limit using these procedures is subject to review and approval by the Administrator.

(ii) If you elect to establish separate monitoring levels for different emission episodes within a batch process, you must maintain records in your daily schedule or log of processes indicating each point at which you change from one operating limit to another, even if the duration of the monitoring for an operating limit is less than 15 minutes. You must maintain a daily schedule or log of processes according to §63.2525(c).

(4) *Averaging periods.* As an alternative to the requirement for daily averages in §63.998(b)(3), you may determine averages for operating blocks. An operating block is a period of time that is equal to the time from the beginning to end of batch process operations within a process.

(5) [Reserved]

(6) *Outlet concentration correction for supplemental gases.* If you use a control device other than a combustion device to comply with a TOC, organic HAP, or hydrogen halide and halogen HAP outlet concentration emission limit for batch process vents, you must correct the actual concentration for supplemental gases using Equation 1 of this section; you may use process knowledge and representative operating data to determine the fraction of the total flow due to supplemental gas.

$$C_a = C_m \left( \frac{Q_s + Q_a}{Q_a} \right) \quad (\text{Eq. 1})$$

Where:

$C_a$  = corrected outlet TOC, organic HAP, or hydrogen halide and halogen HAP concentration, dry basis, ppmv;

$C_m$  = actual TOC, organic HAP, or hydrogen halide and halogen HAP concentration measured at control device outlet, dry basis, ppmv;

$Q_a$  = total volumetric flowrate of all gas streams vented to the control device, except supplemental gases;

$Q_s$  = total volumetric flowrate of supplemental gases.

(7) If flow to a control device could be intermittent, you must install, calibrate, and operate a flow indicator at the inlet or outlet of the control device to identify periods of no flow. Periods of no flow may not be used in daily or block averages, and it may not be used in fulfilling a minimum data availability requirement.

(8) *Terminology.* When the term “storage vessel” is used in subpart WW of this part 63, the term “process tank,” as defined in §63.2550(i), applies for the purposes of this section.

(9) *Requirements for a biofilter.* If you use a biofilter to meet either the 95 percent reduction requirement or outlet concentration requirement specified in Table 2 to this subpart, you must meet the requirements specified in paragraphs (c)(9)(i) through (iv) of this section.

(i) *Operational requirements.* The biofilter must be operated at all times when emissions are vented to it.

(ii) *Performance tests.* To demonstrate initial compliance, you must conduct a performance test according to the procedures in §63.997 and paragraphs (c)(9)(ii)(A) through (D) of this section. The design evaluation option for small control devices is not applicable if you use a biofilter.

(A) Keep up-to-date, readily accessible continuous records of either the biofilter bed temperature averaged over the full period of the performance test or the outlet total organic HAP or TOC concentration

averaged over the full period of the performance test. Include these data in your notification of compliance status report as required by §63.999(b)(3)(ii).

(B) Record either the percent reduction of total organic HAP achieved by the biofilter determined as specified in §63.997(e)(2)(iv) or the concentration of TOC or total organic HAP determined as specified in §63.997(e)(2)(iii) at the outlet of the biofilter, as applicable.

(C) If you monitor the biofilter bed temperature, you may elect to use multiple thermocouples in representative locations throughout the biofilter bed and calculate the average biofilter bed temperature across these thermocouples prior to reducing the temperature data to 15 minute (or shorter) averages for purposes of establishing operating limits for the biofilter. If you use multiple thermocouples, include your rationale for their site selection in your notification of compliance status report.

(D) Submit a performance test report as specified in §63.999(a)(2)(i) and (ii). Include the records from paragraph (c)(9)(ii)(B) of this section in your performance test report.

(iii) *Monitoring requirements.* Use either a biofilter bed temperature monitoring device (or multiple devices) capable of providing a continuous record or an organic monitoring device capable of providing a continuous record. Keep records of temperature or other parameter monitoring results as specified in §63.998(b) and (c), as applicable. General requirements for monitoring are contained in §63.996. If you monitor temperature, the operating temperature range must be based on only the temperatures measured during the performance test; these data may not be supplemented by engineering assessments or manufacturer's recommendations as otherwise allowed in §63.999(b)(3)(ii)(A). If you establish the operating range (minimum and maximum temperatures) using data from previous performance tests in accordance with §63.996(c)(6), replacement of the biofilter media with the same type of media is not considered a process change under §63.997(b)(1). You may expand your biofilter bed temperature operating range by conducting a repeat performance test that demonstrates compliance with the 95 percent reduction requirement or outlet concentration limit, as applicable.

(iv) *Repeat performance tests.* You must conduct a repeat performance test using the applicable methods specified in §63.997 within 2 years following the previous performance test and within 150 days after each replacement of any portion of the biofilter bed media with a different type of media or each replacement of more than 50 percent (by volume) of the biofilter bed media with the same type of media.

[68 FR 63888, Nov. 10, 2003, as amended at 70 FR 38559, July 1, 2005; 71 FR 40333, July 14, 2006]

### **§63.2465 What requirements must I meet for process vents that emit hydrogen halide and halogen HAP or HAP metals?**

(a) You must meet each emission limit in Table 3 to this subpart that applies to you, and you must meet each applicable requirement in paragraphs (b) through (d) of this section.

(b) If any process vents within a process emit hydrogen halide and halogen HAP, you must determine and sum the uncontrolled hydrogen halide and halogen HAP emissions from each of the process vents within the process using the procedures specified in §63.1257(d)(2)(i) and/or (ii), as appropriate. When §63.1257(d)(2)(ii)(E) requires documentation to be submitted in the precompliance report, it means the notification of compliance status report for the purposes of this paragraph.

(c) If collective uncontrolled hydrogen halide and halogen HAP emissions from the process vents within a process are greater than or equal to 1,000 pounds per year (lb/yr), you must comply with §63.994 and the requirements referenced therein, except as specified in paragraphs (c)(1) through (3) of this section.



(1) When §63.994(b)(1) requires a performance test, you may elect to conduct a design evaluation in accordance with §63.1257(a)(1).

(2) When §63.994(b)(1) refers to “a combustion device followed by a halogen scrubber or other halogen reduction device,” it means any combination of control devices used to meet the emission limits specified in Table 3 to this subpart.

(3) Section 63.994(b)(2) does not apply for the purposes of this section.

(d) To demonstrate compliance with the emission limit in Table 3 to this subpart for HAP metals at a new source, you must comply with paragraphs (d)(1) through (3) of this section.

(1) Determine the mass emission rate of HAP metals based on process knowledge, engineering assessment, or test data.

(2) Conduct an initial performance test of each control device that is used to comply with the emission limit for HAP metals specified in Table 3 to this subpart. Conduct the performance test according to the procedures in §63.997. Use Method 29 of appendix A of 40 CFR part 60 to determine the HAP metals at the inlet and outlet of each control device, or use Method 5 of appendix A of 40 CFR part 60 to determine the total particulate matter (PM) at the inlet and outlet of each control device. You have demonstrated initial compliance if the overall reduction of either HAP metals or total PM from the process is greater than or equal to 97 percent by weight.

(3) Comply with the monitoring requirements specified in §63.1366(b)(1)(xi) for each fabric filter used to control HAP metals.

[68 FR 63888, Nov. 10, 2003, as amended at 71 FR 40334, July 14, 2006]

### **§63.2470 What requirements must I meet for storage tanks?**

(a) You must meet each emission limit in Table 4 to this subpart that applies to your storage tanks, and you must meet each applicable requirement specified in paragraphs (b) through (e) of this section.

(b) [Reserved]

(c) *Exceptions to subparts SS and WW of this part 63.* (1) If you conduct a performance test or design evaluation for a control device used to control emissions only from storage tanks, you must establish operating limits, conduct monitoring, and keep records using the same procedures as required in subpart SS of this part 63 for control devices used to reduce emissions from process vents instead of the procedures specified in §§63.985(c), 63.998(d)(2)(i), and 63.999(b)(2).

(2) When the term “storage vessel” is used in subparts SS and WW of this part 63, the term “storage tank,” as defined in §63.2550 applies for the purposes of this subpart.

(d) *Planned routine maintenance.* The emission limits in Table 4 to this subpart for control devices used to control emissions from storage tanks do not apply during periods of planned routine maintenance. Periods of planned routine maintenance of each control device, during which the control device does not meet the emission limit specified in Table 4 to this subpart, must not exceed 240 hours per year (hr/yr). You may submit an application to the Administrator requesting an extension of this time limit to a total of 360 hr/yr. The application must explain why the extension is needed, it must indicate that no material will be added to the storage tank between the time the 240-hr limit is exceeded and the control device is again operational, and it must be submitted at least 60 days before the 240-hr limit will be exceeded.

(e) *Vapor balancing alternative.* As an alternative to the emission limits specified in Table 4 to this subpart, you may elect to implement vapor balancing in accordance with §63.1253(f), except as specified in paragraphs (e)(1) through (3) of this section.

(1) When §63.1253(f)(6)(i) refers to a 90 percent reduction, 95 percent applies for the purposes of this subpart.

(2) To comply with §63.1253(f)(6)(i), the owner or operator of an offsite cleaning or reloading facility must comply with §§63.2445 through 63.2550 instead of complying with §63.1253(f)(7)(ii), except as specified in paragraph (e)(2)(i) or (ii) of this section.

(i) The reporting requirements in §63.2520 do not apply to the owner or operator of the offsite cleaning or reloading facility.

(ii) As an alternative to complying with the monitoring, recordkeeping, and reporting provisions in §§63.2445 through 63.2550, the owner or operator of an offsite cleaning or reloading facility may comply as specified in §63.2535(a)(2) with any other subpart of this part 63 which has monitoring, recordkeeping, and reporting provisions as specified in §63.2535(a)(2).

(3) You may elect to set a pressure relief device to a value less than the 2.5 pounds per square inch gage pressure (psig) required in §63.1253(f)(5) if you provide rationale in your notification of compliance status report explaining why the alternative value is sufficient to prevent breathing losses at all times.

(4) You may comply with the vapor balancing alternative in §63.1253(f) when your storage tank is filled from a barge. All requirements for tank trucks and railcars specified in §63.1253(f) also apply to barges, except as specified in §63.2470(e)(4)(i).

(i) When §63.1253(f)(2) refers to pressure testing certifications, the requirements in 40 CFR 61.304(f) apply for barges.

(ii) [Reserved]

[68 FR 63888, Nov. 10, 2003, as amended at 70 FR 38559, July 1, 2005; 71 FR 40335, July 14, 2006]

### **§63.2475 What requirements must I meet for transfer racks?**

(a) You must comply with each emission limit and work practice standard in table 5 to this subpart that applies to your transfer racks, and you must meet each applicable requirement in paragraphs (b) and (c) of this section.

(b) When the term “high throughput transfer rack” is used in subpart SS of this part 63, the term “Group 1 transfer rack,” as defined in §63.2550, applies for the purposes of this subpart.

[68 FR 63888, Nov. 10, 2003, as amended at 71 FR 40335, July 14, 2006]

### **§63.2480 What requirements must I meet for equipment leaks?**

(a) You must meet each requirement in table 6 to this subpart that applies to your equipment leaks, except as specified in paragraphs (b) through (d) of this section.

(b) If you comply with either subpart H or subpart UU of this part 63, you may elect to comply with the provisions in paragraphs (b)(1) through (5) of this section as an alternative to the referenced provisions in subpart H or subpart UU of this part.

(1) The requirements for pressure testing in §63.179(b) or §63.1036(b) may be applied to all processes, not just batch processes.

(2) For the purposes of this subpart, pressure testing for leaks in accordance with §63.179(b) or §63.1036(b) is not required after reconfiguration of an equipment train if flexible hose connections are the only disturbed equipment.

(3) For an existing source, you are not required to develop an initial list of identification numbers for connectors as would otherwise be required under §63.1022(b)(1) or §63.181(b)(1)(i).

(4) For connectors in gas/vapor and light liquid service at an existing source, you may elect to comply with the requirements in §63.169 or §63.1029 for connectors in heavy liquid service, including all associated recordkeeping and reporting requirements, rather than the requirements of §63.174 or §63.1027.

(5) For pumps in light liquid service in an MCPU that has no continuous process vents and is part of an existing source, you may elect to consider the leak definition that defines a leak to be 10,000 parts per million (ppm) or greater as an alternative to the values specified in §63.1026(b)(2)(i) through (iii) or §63.163(b)(2).

(c) If you comply with 40 CFR part 65, subpart F, you may elect to comply with the provisions in paragraphs (c)(1) through (9) of this section as an alternative to the referenced provisions in 40 CFR part 65, subpart F.

(1) The requirements for pressure testing in §65.117(b) may be applied to all processes, not just batch processes.

(2) For the purposes of this subpart, pressure testing for leaks in accordance with §65.117(b) is not required after reconfiguration of an equipment train if flexible hose connections are the only disturbed equipment.

(3) For an existing source, you are not required to develop an initial list of identification numbers for connectors as would otherwise be required under §65.103(b)(1).

(4) You may elect to comply with the monitoring and repair requirements specified in §65.108(e)(3) as an alternative to the requirements specified in §65.108(a) through (d) for any connectors at your affected source.

(5) For pumps in light liquid service in an MCPU that has no continuous process vents and is part of an existing source, you may elect to consider the leak definition that defines a leak to be 10,000 ppm or greater as an alternative to the values specified in §65.107(b)(2)(i) through (iii).

(6) When 40 CFR part 65, subpart F refers to the implementation date specified in §65.1(f), it means the compliance date specified in §63.2445.

(7) When §§65.105(f) and 65.117(d)(3) refer to §65.4, it means §63.2525.

(8) When §65.120(a) refers to §65.5(d), it means §63.2515.

(9) When §65.120(b) refers to §65.5(e), it means §63.2520.

(d) The provisions of this section do not apply to bench-scale processes, regardless of whether the processes are located at the same plant site as a process subject to the provisions of this subpart.

**§63.2485 What requirements must I meet for wastewater streams and liquid streams in open systems within an MCPU?**

(a) You must meet each requirement in table 7 to this subpart that applies to your wastewater streams and liquid streams in open systems within an MCPU, except as specified in paragraphs (b) through (o) of this section.

(b) *Wastewater HAP.* Where §63.105 and §§63.132 through 63.148 refer to compounds in table 9 of subpart G of this part 63, the compounds in tables 8 and 9 to this subpart apply for the purposes of this subpart.

(c) *Group 1 wastewater.* Section 63.132(c)(1) (i) and (ii) do not apply. For the purposes of this subpart, a process wastewater stream is Group 1 for compounds in tables 8 and 9 to this subpart if any of the conditions specified in paragraphs (c) (1) through (3) of this section are met.

(1) The total annual average concentration of compounds in table 8 to this subpart is greater than or equal to 10,000 ppmw at any flowrate, and the total annual load of compounds in table 8 to this subpart is greater than or equal to 200 lb/yr.

(2) The total annual average concentration of compounds in table 8 to this subpart is greater than or equal to 1,000 ppmw, and the annual average flowrate is greater than or equal to 1 l/min.

(3) The combined total annual average concentration of compounds in tables 8 and 9 to this subpart is greater than or equal to 30,000 ppmw, and the combined total annual load of compounds in tables 8 and 9 to this subpart is greater than or equal to 1 tpy.

(d) *Wastewater tank requirements.* (1) When §§63.133 and 63.147 reference floating roof requirements in §§63.119 and 63.120, the corresponding requirements in subpart WW of this part 63 may be applied for the purposes of this subpart.

(2) When §63.133(a) refers to table 10 of subpart G of this part 63, the maximum true vapor pressure in the table shall be limited to the HAP listed in tables 8 and 9 of this subpart FFFF.

(3) For the purposes of this subpart, the requirements of §63.133(a)(2) are satisfied by operating and maintaining a fixed roof if you demonstrate that the total soluble and partially soluble HAP emissions from the wastewater tank are no more than 5 percent higher than the emissions would be if the contents of the wastewater tank were not heated, treated by an exothermic reaction, or sparged.

(4) The emission limits specified in §§63.133(b)(2) and 63.139 for control devices used to control emissions from wastewater tanks do not apply during periods of planned routine maintenance of the control device(s) of no more than 240 hr/yr. You may request an extension to a total of 360 hr/yr in accordance with the procedures specified in §63.2470(d).

(e) *Individual drain systems.* The provisions of §63.136(e)(3) apply except as specified in paragraph (e)(1) of this section.

(1) A sewer line connected to drains that are in compliance with §63.136(e)(1) may be vented to the atmosphere, provided that the sewer line entrance to the first downstream junction box is water sealed and the sewer line vent pipe is designed as specified in §63.136(e)(2)(ii)(A).

(2) [Reserved]

(f) *Closed-vent system requirements.* When §63.148(k) refers to closed vent systems that are subject to the requirements of §63.172, the requirements of either §63.172 or §63.1034 apply for the purposes of this subpart.

(g) *Halogenated vent stream requirements.* For each halogenated vent stream from a Group 1 wastewater stream or residual removed from a Group 1 wastewater stream that is vented through a closed-vent system to a combustion device to reduce organic HAP emissions, you must meet the same emission limits as specified for batch process vents in item 2 of table 2 to this subpart.

(h) *Alternative test methods.* (1) As an alternative to the test methods specified in §63.144(b)(5)(i), you may use Method 8260 or 8270 as specified in §63.1257(b)(10)(iii).

(2) As an alternative to using the methods specified in §63.144(b)(5)(i), you may conduct wastewater analyses using Method 1666 or 1671 of 40 CFR part 136 and comply with the sampling protocol requirements specified in §63.144(b)(5)(ii). The validation requirements specified in §63.144(b)(5)(iii) do not apply if you use Method 1666 or 1671 of 40 CFR part 136.

(3) As an alternative to using Method 18 of 40 CFR part 60, as specified in §§63.139(c)(1)(ii) and 63.145(i)(2), you may elect to use Method 25A of 40 CFR part 60 as specified in §63.997.

(i) *Offsite management and treatment option.* (1) If you ship wastewater to an offsite treatment facility that meets the requirements of §63.138(h), you may elect to document in your notification of compliance status report that the wastewater will be treated as hazardous waste at a facility that meets the requirements of §63.138(h) as an alternative to having the offsite facility submit the certification specified in §63.132(g)(2).

(2) As an alternative to the management and treatment options specified in §63.132(g)(2), any affected wastewater stream (or residual removed from an affected wastewater stream) with a total annual average concentration of compounds in Table 8 to this subpart less than 50 ppmw may be transferred offsite in accordance with paragraphs (i)(2) (i) and (ii) of this section.

(i) The transferee (or you) must demonstrate that less than 5 percent of the HAP in Table 9 to this subpart is emitted from the waste management units up to the activated sludge unit.

(ii) The transferee must treat the wastewater stream or residual in a biological treatment unit in accordance with §§63.138 and 63.145 and the requirements referenced therein.

(j) You must determine the annual average concentration and annual average flowrate for wastewater streams for each MCPU. The procedures for flexible operation units specified in §63.144 (b) and (c) do not apply for the purposes of this subpart.

(k) The requirement to correct outlet concentrations from combustion devices to 3 percent oxygen in §§63.139(c)(1)(ii) and 63.146(i)(6) applies only if supplemental gases are combined with a vent stream from a Group 1 wastewater stream. If emissions are controlled with a vapor recovery system as specified in §63.139(c)(2), you must correct for supplemental gases as specified in §63.2460(c)(6).

(l) *Requirements for liquid streams in open systems.* (1) References in §63.149 to §63.100(b) mean §63.2435(b) for the purposes of this subpart.

(2) When §63.149(e) refers to 40 CFR 63.100(l) (1) or (2), §63.2445(a) applies for the purposes of this subpart.

(3) When §63.149 uses the term “chemical manufacturing process unit,” the term “MCPU” applies for the purposes of this subpart.

(4) When §63.149(e)(1) refers to characteristics of water that contain compounds in Table 9 to 40 CFR part 63, subpart G, the characteristics specified in paragraphs (c) (1) through (3) of this section apply for the purposes of this subpart.

(5) When §63.149(e)(2) refers to characteristics of water that contain compounds in Table 9 to 40 CFR part 63, subpart G, the characteristics specified in paragraph (c)(2) of this section apply for the purposes of this subpart.

(m) When §63.132(f) refers to “a concentration of greater than 10,000 ppmw of table 9 compounds,” the phrase “a concentration of greater than 30,000 ppmw of total partially soluble HAP (PSHAP) and soluble HAP (SHAP) or greater than 10,000 ppmw of PSHAP” shall apply for the purposes of this subpart.

(n) *Alternative requirements for wastewater that is Group 1 for soluble HAP only.* The option specified in this paragraph (n) applies to wastewater that is Group 1 for soluble HAP in accordance with paragraph (c)(3) of this section and is discharged to biological treatment. Except as provided in paragraph (n)(4) of this section, this option does not apply to wastewater that is Group 1 for partially soluble HAP in accordance with paragraph (c)(1), (c)(2), or (c)(4) of this section. For wastewater that is Group 1 for SHAP, you need not comply with §§63.133 through 63.137 for any equalization unit, neutralization unit, and/or clarifier prior to the activated sludge unit, and you need not comply with the venting requirements in §63.136(e)(2)(ii)(A) for lift stations with a volume larger than 10,000 gal, provided you comply with the requirements specified in paragraphs (n)(1) through (3) of this section and all otherwise applicable requirements specified in table 7 to this subpart. For this option, the treatment requirements in §63.138 and the performance testing requirements in §63.145 do not apply to the biological treatment unit, except as specified in paragraphs (n)(2)(i) through (iv) of this section.

(1) Wastewater must be hard-piped between the equalization unit, clarifier, and activated sludge unit. This requirement does not apply to the transfer between any of these types of units that are part of the same structure and one unit overflows into the next.

(2) Calculate the destruction efficiency of the biological treatment unit using Equation 1 of this section in accordance with the procedures described in paragraphs (n)(2)(i) through (vi) of this section. You have demonstrated initial compliance if E is greater than or equal to 90 percent.

$$E = \frac{(QMW_a - QMG_a - QMG_n - QMG_c)(F_{bio})}{QMW_a} \times 100 \quad (\text{Eq. 1})$$

Where:

E = destruction efficiency of total PSHAP and SHAP for the biological treatment unit including the equalization unit, neutralization unit, and/or clarifier, percent;

QMW<sub>a</sub> = mass flow rate of total PSHAP and SHAP compounds entering the equalization unit (or whichever of the three types of units is first), kilograms per hour (kg/hr);

QMG<sub>a</sub> = mass flow rate of total PSHAP and SHAP compounds emitted from the equalization unit, kg/hr;

QMG<sub>n</sub> = mass flow rate of total PSHAP and SHAP compounds emitted from the neutralization unit, kg/hr;

QMG<sub>c</sub> = mass flow rate of total PSHAP and SHAP compounds emitted from the clarifier, kg/hr

F<sub>bio</sub> = site-specific fraction of PSHAP and SHAP compounds biodegraded in the biological treatment unit.

(i) Include all PSHAP and SHAP compounds in both Group 1 and Group 2 wastewater streams from all MCPU, except you may exclude any compounds that meet the criteria specified in §63.145(a)(6)(ii) or (iii).

(ii) Conduct the demonstration under representative process unit and treatment unit operating conditions in accordance with §63.145(a)(3) and (4).

(iii) Determine PSHAP and SHAP concentrations and the total wastewater flow rate at the inlet to the equalization unit in accordance with §63.145(f)(1) and (2). References in §63.145(f)(1) and (2) to required mass removal and actual mass removal do not apply for the purposes of this section.

(iv) Determine  $F_{bio}$  for the activated sludge unit as specified in §63.145(h), except as specified in paragraph (n)(2)(iv)(A) or paragraph (n)(2)(iv)(B) of this section.

(A) If the biological treatment process meets both of the requirements specified in §63.145(h)(1)(i) and (ii), you may elect to replace the  $F_{bio}$  term in Equation 1 of this section with the numeral "1."

(B) You may elect to assume  $f_{bio}$  is zero for any compounds on List 2 of table 36 in subpart G.

(v) Determine  $QMG_e$ ,  $QMG_n$ , and  $QMG_c$  using EPA's WATER9 model or the most recent update to this model, and conduct testing or use other procedures to validate the modeling results.

(vi) Submit the data and results of your demonstration, including both a description of and the results of your WATER9 modeling validation procedures, in your notification of compliance status report as specified in §63.2520(d)(2)(ii).

(3) As an alternative to the venting requirements in §63.136(e)(2)(ii)(A), a lift station with a volume larger than 10,000 gal may have openings necessary for proper venting of the lift station. The size and other design characteristics of these openings may be established based on manufacturer recommendations or engineering judgment for venting under normal operating conditions. You must describe the design of such openings and your supporting calculations and other rationale in your notification of compliance status report.

(4) For any wastewater streams that are Group 1 for both PSHAP and SHAP, you may elect to meet the requirements specified in table 7 to this subpart for the PSHAP and then comply with paragraphs (n)(1) through (3) of this section for the SHAP in the wastewater system. You may determine the SHAP mass removal rate, in kg/hr, in treatment units that are used to meet the requirements for PSHAP and add this amount to both the numerator and denominator in Equation 1 of this section.

(o) *Compliance records.* For each CPMS used to monitor a nonflare control device for wastewater emissions, you must keep records as specified in §63.998(c)(1) in addition to the records required in §63.147(d).

[68 FR 63888, Nov. 10, 2003, as amended at 70 FR 38559, July 1, 2005; 71 FR 40335, July 14, 2006]

### **§63.2490 What requirements must I meet for heat exchange systems?**

(a) You must comply with each requirement in Table 10 to this subpart that applies to your heat exchange systems, except as specified in paragraphs (b) and (c) of this section.

(b) The phrase "a chemical manufacturing process unit meeting the conditions of §63.100 (b)(1) through (b)(3) of this section" in §63.104(a) means "an MCPU meeting the conditions of §63.2435" for the purposes of this subpart.

(c) The reference to §63.100(c) in §63.104(a) does not apply for the purposes of this subpart.

## **ALTERNATIVE MEANS OF COMPLIANCE**

### **§63.2495 How do I comply with the pollution prevention standard?**

(a) You may elect to comply with the pollution prevention alternative requirements specified in paragraphs (a) (1) and (2) of this section in lieu of the emission limitations and work practice standards contained in Tables 1 through 7 to this subpart for any MCPU for which initial startup occurred before April 4, 2002.

(1) You must reduce the production-indexed HAP consumption factor (HAP factor) by at least 65 percent from a 3-year average baseline beginning no earlier than the 1994 through 1996 calendar years. For any reduction in the HAP factor that you achieve by reducing HAP that are also volatile organic compounds (VOC), you must demonstrate an equivalent reduction in the production-indexed VOC consumption factor (VOC factor) on a mass basis. For any reduction in the HAP factor that you achieve by reducing a HAP that is not a VOC, you may not increase the VOC factor.

(2) Any MCPU for which you seek to comply by using the pollution prevention alternative must begin with the same starting material(s) and end with the same product(s). You may not comply by eliminating any steps of a process by transferring the step offsite (to another manufacturing location). You may also not merge a solvent recovery step conducted offsite to onsite and as part of an existing process as a method of reducing consumption.

(3) You may comply with the requirements of paragraph (a)(1) of this section for a series of processes, including situations where multiple processes are merged, if you demonstrate to the satisfaction of the Administrator that the multiple processes were merged after the baseline period into an existing process or processes.

(b) *Exclusions.* (1) You must comply with the emission limitations and work practice standards contained in tables 1 through 7 of this subpart for all HAP that are generated in the MCPU and that are not included in consumption, as defined in §63.2550. If any vent stream routed to the combustion control is a halogenated vent stream, as defined in §63.2550, then hydrogen halides that are generated as a result of combustion control must be controlled according to the requirements of §63.994 and the requirements referenced therein.

(2) You may not merge nondedicated formulation or nondedicated solvent recovery processes with any other processes.

(c) *Initial compliance procedures.* To demonstrate initial compliance with paragraph (a) of this section, you must prepare a demonstration summary in accordance with paragraph (c) (1) of this section and calculate baseline and target annual HAP and VOC factors in accordance with paragraphs (c) (2) and (3) of this section.

(1) *Demonstration plan.* You must prepare a pollution prevention demonstration plan that contains, at a minimum, the information in paragraphs (c)(1) (i) through (iii) of this section for each MCPU for which you comply with paragraph (a) of this section.

(i) Descriptions of the methodologies and forms used to measure and record consumption of HAP and VOC compounds.

(ii) Descriptions of the methodologies and forms used to measure and record production of the product(s).



(iii) Supporting documentation for the descriptions provided in accordance with paragraphs (c)(1) (i) and (ii) of this section including, but not limited to, samples of operator log sheets and daily, monthly, and/or annual inventories of materials and products. You must describe how this documentation will be used to calculate the annual factors required in paragraph (d) of this section.

(2) *Baseline factors.* You must calculate baseline HAP and VOC factors by dividing the consumption of total HAP and total VOC by the production rate, per process, for the first 3-year period in which the process was operational, beginning no earlier than the period consisting of the 1994 through 1996 calendar years.

(3) *Target annual factors.* You must calculate target annual HAP and VOC factors. The target annual HAP factor must be equal to 35 percent of the baseline HAP factor. The target annual VOC factor must be lower than the baseline VOC factor by an amount equivalent to the reduction in any HAP that is also a VOC, on a mass basis. The target annual VOC factor may be the same as the baseline VOC factor if the only HAP you reduce is not a VOC.

(d) *Continuous compliance requirements.* You must calculate annual rolling average values of the HAP and VOC factors (annual factors) in accordance with the procedures specified in paragraphs (d) (1) through (3) of this section. To show continuous compliance, the annual factors must be equal to or less than the target annual factors calculated according to paragraph (c)(3) of this section.

(1) To calculate the annual factors, you must divide the consumption of both total HAP and total VOC by the production rate, per process, for 12-month periods at the frequency specified in either paragraph (d) (2) or (3) of this section, as applicable.

(2) For continuous processes, you must calculate the annual factors every 30 days for the 12-month period preceding the 30th day (i.e., annual rolling average calculated every 30 days). A process with both batch and continuous operations is considered a continuous process for the purposes of this section.

(3) For batch processes, you must calculate the annual factors every 10 batches for the 12-month period preceding the 10th batch (i.e., annual rolling average calculated every 10 batches), except as specified in paragraphs (d)(3) (i) and (ii) of this section.

(i) If you produce more than 10 batches during a month, you must calculate the annual factors at least once during that month.

(ii) If you produce less than 10 batches in a 12-month period, you must calculate the annual factors for the number of batches in the 12-month period since the previous calculations.

(e) *Records.* You must keep records of HAP and VOC consumption, production, and the rolling annual HAP and VOC factors for each MCPU for which you are complying with paragraph (a) of this section.

(f) *Reporting.* (1) You must include the pollution prevention demonstration plan in the precompliance report required by §63.2520(c).

(2) You must identify all days when the annual factors were above the target factors in the compliance reports.

[68 FR 63888, Nov. 10, 2003, as amended at 71 FR 40336, July 14, 2006]

### **§63.2500 How do I comply with emissions averaging?**

(a) For an existing source, you may elect to comply with the percent reduction emission limitations in Tables 1, 2, 4, 5, and 7 to this subpart by complying with the emissions averaging provisions specified in §63.150, except as specified in paragraphs (b) through (f) of this section.

(b) The batch process vents in an MCPU collectively are considered one individual emission point for the purposes of emissions averaging, except that only individual batch process vents must be excluded to meet the requirements of §63.150(d)(5).

(c) References in §63.150 to §§63.112 through 63.130 mean the corresponding requirements in §§63.2450 through 63.2490, including applicable monitoring, recordkeeping, and reporting.

(d) References to “periodic reports” in §63.150 mean “compliance report” for the purposes of this subpart.

(e) For batch process vents, estimate uncontrolled emissions for a standard batch using the procedures in §63.1257(d)(2)(i) and (ii) instead of the procedures in §63.150(g)(2). Multiply the calculated emissions per batch by the number of batches per month when calculating the monthly emissions for use in calculating debits and credits.

(f) References to “storage vessels” in §63.150 mean “storage tank” as defined in §63.2550 for the purposes of this subpart.

#### **§63.2505 How do I comply with the alternative standard?**

As an alternative to complying with the emission limits and work practice standards for process vents and storage tanks in Tables 1 through 4 to this subpart and the requirements in §§63.2455 through 63.2470, you may comply with the emission limits in paragraph (a) of this section and demonstrate compliance in accordance with the requirements in paragraph (b) of this section.

(a) *Emission limits and work practice standards.* (1) You must route vent streams through a closed-vent system to a control device that reduces HAP emissions as specified in either paragraph (a)(1)(i) or (ii) of this section.

(i) If you use a combustion control device, it must reduce HAP emissions as specified in paragraphs (a)(1)(i)(A), (B), and (C) of this section.

(A) To an outlet TOC concentration of 20 parts per million by volume (ppmv) or less.

(B) To an outlet concentration of hydrogen halide and halogen HAP of 20 ppmv or less.

(C) As an alternative to paragraph (a)(1)(i)(B) of this section, if you control halogenated vent streams emitted from a combustion device followed by a scrubber, reduce the hydrogen halide and halogen HAP generated in the combustion device by greater than or equal to 95 percent by weight in the scrubber.

(ii) If you use a noncombustion control device(s), it must reduce HAP emissions to an outlet total organic HAP concentration of 50 ppmv or less, and an outlet concentration of hydrogen halide and halogen HAP of 50 ppmv or less.

(2) Any Group 1 process vents within a process that are not controlled according to this alternative standard must be controlled according to the emission limits in tables 1 through 3 to this subpart.

(b) *Compliance requirements.* To demonstrate compliance with paragraph (a) of this section, you must meet the requirements of §63.1258(b)(5) beginning no later than the initial compliance date specified in §63.2445, except as specified in paragraphs (b)(1) through (9) of this section.

(1) You must comply with the requirements in §63.983 and the requirements referenced therein for closed-vent systems.

(2) When §63.1258(b)(5)(i) refers to §§63.1253(d) and 63.1254(c), the requirements in paragraph (a) of this section apply for the purposes of this subpart FFFF.

(3) When §63.1258(b)(5)(i)(B) refers to “HCl,” it means “total hydrogen halide and halogen HAP” for the purposes of this subpart FFFF.

(4) When §63.1258(b)(5)(ii) refers to §63.1257(a)(3), it means §63.2450(j)(5) for the purposes of this subpart FFFF.

(5) You must submit the results of any determination of the target analytes of predominant HAP in the notification of compliance status report.

(6) If you elect to comply with the requirement to reduce hydrogen halide and halogen HAP by greater than or equal to 95 percent by weight in paragraph (a)(1)(i)(C) of this section, you must meet the requirements in paragraphs (b)(6)(i) and (ii) of this section.

(i) Demonstrate initial compliance with the 95 percent reduction by conducting a performance test and setting a site-specific operating limit(s) for the scrubber in accordance with §63.994 and the requirements referenced therein. You must submit the results of the initial compliance demonstration in the notification of compliance status report.

(ii) Install, operate, and maintain CPMS for the scrubber as specified in §§63.994(c) and 63.2450(k), instead of as specified in §63.1258(b)(5)(i)(C).

(7) If flow to the scrubber could be intermittent, you must install, calibrate, and operate a flow indicator as specified in §63.2460(c)(7).

(8) Use the operating day as the averaging period for CEMS data and scrubber parameter monitoring data.

(9) The requirements in paragraph (a) of this section do not apply to emissions from storage tanks during periods of planned routine maintenance of the control device that do not exceed 240 hr/yr. You may submit an application to the Administrator requesting an extension of this time limit to a total of 360 hr/yr in accordance with the procedures specified in §63.2470(d). You must comply with the recordkeeping and reporting specified in §§63.998(d)(2)(ii) and 63.999(c)(4) for periods of planned routine maintenance.

[68 FR 63888, Nov. 10, 2003, as amended at 70 FR 38559, July 1, 2005]

## **NOTIFICATION, REPORTS, AND RECORDS**

### **§63.2515 What notifications must I submit and when?**

(a) You must submit all of the notifications in §§63.6(h)(4) and (5), 63.7(b) and (c), 63.8(e), (f)(4) and (6), and 63.9(b) through (h) that apply to you by the dates specified.

(b) *Initial notification.* As specified in §63.9(b)(2), if you startup your affected source before November 10, 2003, you must submit an initial notification not later than 120 calendar days after November 10, 2003.

(2) As specified in §63.9(b)(3), if you startup your new affected source on or after November 10, 2003, you must submit an initial notification not later than 120 calendar days after you become subject to this subpart.

(c) *Notification of performance test.* If you are required to conduct a performance test, you must submit a notification of intent to conduct a performance test at least 60 calendar days before the performance test is scheduled to begin as required in §63.7(b)(1). For any performance test required as part of the initial compliance procedures for batch process vents in table 2 to this subpart, you must also submit the test plan required by §63.7(c) and the emission profile with the notification of the performance test.

### **§63.2520 What reports must I submit and when?**

(a) You must submit each report in Table 11 to this subpart that applies to you.

(b) Unless the Administrator has approved a different schedule for submission of reports under §63.10(a), you must submit each report by the date in table 11 to this subpart and according to paragraphs (b)(1) through (5) of this section.

(1) The first compliance report must cover the period beginning on the compliance date that is specified for your affected source in §63.2445 and ending on June 30 or December 31, whichever date is the first date following the end of the first 6 months after the compliance date that is specified for your affected source in §63.2445.

(2) The first compliance report must be postmarked or delivered no later than August 31 or February 28, whichever date is the first date following the end of the first reporting period specified in paragraph (b)(1) of this section.

(3) Each subsequent compliance report must cover the semiannual reporting period from January 1 through June 30 or the semiannual reporting period from July 1 through December 31.

(4) Each subsequent compliance report must be postmarked or delivered no later than August 31 or February 28, whichever date is the first date following the end of the semiannual reporting period.

(5) For each affected source that is subject to permitting regulations pursuant to 40 CFR part 70 or 40 CFR part 71, and if the permitting authority has established dates for submitting semiannual reports pursuant to 40 CFR 70.6(a)(3)(iii)(A) or 40 CFR 71.6(a)(3)(iii)(A), you may submit the first and subsequent compliance reports according to the dates the permitting authority has established instead of according to the dates in paragraphs (b)(1) through (4) of this section.

(c) *Precompliance report.* You must submit a precompliance report to request approval for any of the items in paragraphs (c)(1) through (7) of this section. We will either approve or disapprove the report within 90 days after we receive it. If we disapprove the report, you must still be in compliance with the emission limitations and work practice standards in this subpart by the compliance date. To change any of the information submitted in the report, you must notify us 60 days before the planned change is to be implemented.

(1) Requests for approval to set operating limits for parameters other than those specified in §§63.2455 through 63.2485 and referenced therein. Alternatively, you may make these requests according to §63.8(f).

(2) Descriptions of daily or per batch demonstrations to verify that control devices subject to §63.2460(c)(5) are operating as designed.

(3) A description of the test conditions, data, calculations, and other information used to establish operating limits according to §63.2460(c)(3).

(4) Data and rationale used to support an engineering assessment to calculate uncontrolled emissions in accordance with §63.1257(d)(2)(ii). This requirement does not apply to calculations of hydrogen halide and halogen HAP emissions as specified in §63.2465(b), to determinations that the total HAP concentration is less than 50 ppmv, or if you use previous test data to establish the uncontrolled emissions.

(5) The pollution prevention demonstration plan required in §63.2495(c)(1), if you are complying with the pollution prevention alternative.

(6) Documentation of the practices that you will implement to minimize HAP emissions from streams that contain energetics and organic peroxides, and rationale for why meeting the emission limit specified in tables 1 through 7 to this subpart would create an undue safety hazard.

(7) For fabric filters that are monitored with bag leak detectors, an operation and maintenance plan that describes proper operation and maintenance procedures, and a corrective action plan that describes corrective actions to be taken, and the timing of those actions, when the PM concentration exceeds the set point and activates the alarm.

(d) *Notification of compliance status report.* You must submit a notification of compliance status report according to the schedule in paragraph (d)(1) of this section, and the notification of compliance status report must contain the information specified in paragraph (d)(2) of this section.

(1) You must submit the notification of compliance status report no later than 150 days after the applicable compliance date specified in §63.2445.

(2) The notification of compliance status report must include the information in paragraphs (d)(2)(i) through (ix) of this section.

(i) The results of any applicability determinations, emission calculations, or analyses used to identify and quantify HAP usage or HAP emissions from the affected source.

(ii) The results of emissions profiles, performance tests, engineering analyses, design evaluations, flare compliance assessments, inspections and repairs, and calculations used to demonstrate initial compliance according to §§63.2455 through 63.2485. For performance tests, results must include descriptions of sampling and analysis procedures and quality assurance procedures.

(iii) Descriptions of monitoring devices, monitoring frequencies, and the operating limits established during the initial compliance demonstrations, including data and calculations to support the levels you establish.

(iv) All operating scenarios.

(v) Descriptions of worst-case operating and/or testing conditions for control devices.

(vi) Identification of parts of the affected source subject to overlapping requirements described in §63.2535 and the authority under which you will comply.

(vii) The information specified in §63.1039(a)(1) through (3) for each process subject to the work practice standards for equipment leaks in Table 6 to this subpart.

(viii) Identify storage tanks for which you are complying with the vapor balancing alternative in §63.2470(e).

(ix) Records as specified in §63.2535(l)(1) through (3) of process units used to create a PUG and calculations of the initial primary product of the PUG.

(e) *Compliance report.* The compliance report must contain the information specified in paragraphs (e)(1) through (10) of this section.

(1) Company name and address.

(2) Statement by a responsible official with that official's name, title, and signature, certifying the accuracy of the content of the report.

(3) Date of report and beginning and ending dates of the reporting period.

(4) For each SSM during which excess emissions occur, the compliance report must include records that the procedures specified in your startup, shutdown, and malfunction plan (SSMP) were followed or documentation of actions taken that are not consistent with the SSMP, and include a brief description of each malfunction.

(5) The compliance report must contain the information on deviations, as defined in §63.2550, according to paragraphs (e)(5)(i), (ii), (iii), and (iv) of this section.

(i) If there are no deviations from any emission limit, operating limit or work practice standard specified in this subpart, include a statement that there were no deviations from the emission limits, operating limits, or work practice standards during the reporting period.

(ii) For each deviation from an emission limit, operating limit, and work practice standard that occurs at an affected source where you are not using a continuous monitoring system (CMS) to comply with the emission limit or work practice standard in this subpart, you must include the information in paragraphs (e)(5)(ii)(A) through (C) of this section. This includes periods of SSM.

(A) The total operating time of the affected source during the reporting period.

(B) Information on the number, duration, and cause of deviations (including unknown cause, if applicable), as applicable, and the corrective action taken.

(C) Operating logs of processes with batch vents from batch operations for the day(s) during which the deviation occurred, except operating logs are not required for deviations of the work practice standards for equipment leaks.

(iii) For each deviation from an emission limit or operating limit occurring at an affected source where you are using a CMS to comply with an emission limit in this subpart, you must include the information in paragraphs (e)(5)(iii)(A) through (L) of this section. This includes periods of SSM.

(A) The date and time that each CMS was inoperative, except for zero (low-level) and high-level checks.

(B) The date, time, and duration that each CEMS was out-of-control, including the information in §63.8(c)(8).

(C) The date and time that each deviation started and stopped, and whether each deviation occurred during a period of startup, shutdown, or malfunction or during another period.

(D) A summary of the total duration of the deviation during the reporting period, and the total duration as a percent of the total operating time of the affected source during that reporting period.

(E) A breakdown of the total duration of the deviations during the reporting period into those that are due to startup, shutdown, control equipment problems, process problems, other known causes, and other unknown causes.

(F) A summary of the total duration of CMS downtime during the reporting period, and the total duration of CMS downtime as a percent of the total operating time of the affected source during that reporting period.

(G) An identification of each HAP that is known to be in the emission stream.

(H) A brief description of the process units.

(I) A brief description of the CMS.

(J) The date of the latest CMS certification or audit.

(K) Operating logs of processes with batch vents from batch operations for each day(s) during which the deviation occurred.

(L) The operating day or operating block average values of monitored parameters for each day(s) during which the deviation occurred.

(iv) If you documented in your notification of compliance status report that an MCPU has Group 2 batch process vents because the non-reactive HAP is the only HAP and usage is less than 10,000 lb/yr, the total uncontrolled organic HAP emissions from the batch process vents in an MCPU will be less than 1,000 lb/yr for the anticipated number of standard batches, or total uncontrolled hydrogen halide and halogen HAP emissions from all batch process vents and continuous process vents in a process are less than 1,000 lb/yr, include the records associated with each calculation required by §63.2525(e) that exceeds an applicable HAP usage or emissions threshold.

(6) If you use a CEMS, and there were no periods during which it was out-of-control as specified in §63.8(c)(7), include a statement that there were no periods during which the CEMS was out-of-control during the reporting period.

(7) Include each new operating scenario which has been operated since the time period covered by the last compliance report and has not been submitted in the notification of compliance status report or a previous compliance report. For each new operating scenario, you must provide verification that the operating conditions for any associated control or treatment device have not been exceeded and that any required calculations and engineering analyses have been performed. For the purposes of this paragraph, a revised operating scenario for an existing process is considered to be a new operating scenario.

(8) Records of process units added to a PUG as specified in §63.2525(i)(4) and records of primary product redeterminations as specified in §63.2525(i)(5).

(9) Applicable records and information for periodic reports as specified in referenced subparts F, G, H, SS, UU, WW, and GGG of this part and subpart F of 40 CFR part 65.

(10) *Notification of process change.* (i) Except as specified in paragraph (e)(10)(ii) of this section, whenever you make a process change, or change any of the information submitted in the notification of compliance status report or a previous compliance report, that is not within the scope of an existing operating scenario, you must document the change in your compliance report. A process change does not include moving within a range of conditions identified in the standard batch, and a nonstandard batch does not constitute a process change. The notification must include all of the information in paragraphs (e)(10)(i)(A) through (C) of this section.

(A) A description of the process change.

(B) Revisions to any of the information reported in the original notification of compliance status report under paragraph (d) of this section.

(C) Information required by the notification of compliance status report under paragraph (d) of this section for changes involving the addition of processes or equipment at the affected source.

(ii) You must submit a report 60 days before the scheduled implementation date of any of the changes identified in paragraph (e)(10)(ii)(A), (B), or (C) of this section.

(A) Any change to the information contained in the precompliance report.

(B) A change in the status of a control device from small to large.

(C) A change from Group 2 to Group 1 for any emission point except for batch process vents that meet the conditions specified in §63.2460(b)(6)(i).

[68 FR 63888, Nov. 10, 2003, as amended at 70 FR 38560, July 1, 2005; 71 FR 40336, July 14, 2006]

### **§63.2525 What records must I keep?**

You must keep the records specified in paragraphs (a) through (k) of this section.

(a) Each applicable record required by subpart A of this part 63 and in referenced subparts F, G, SS, UU, WW, and GGG of this part 63 and in referenced subpart F of 40 CFR part 65.

(b) Records of each operating scenario as specified in paragraphs (b)(1) through (8) of this section.

(1) A description of the process and the type of process equipment used.

(2) An identification of related process vents, including their associated emissions episodes if not complying with the alternative standard in §63.2505; wastewater point of determination (POD); storage tanks; and transfer racks.

(3) The applicable control requirements of this subpart, including the level of required control, and for vents, the level of control for each vent.



(4) The control device or treatment process used, as applicable, including a description of operating and/or testing conditions for any associated control device.

(5) The process vents, wastewater POD, transfer racks, and storage tanks (including those from other processes) that are simultaneously routed to the control device or treatment process(s).

(6) The applicable monitoring requirements of this subpart and any parametric level that assures compliance for all emissions routed to the control device or treatment process.

(7) Calculations and engineering analyses required to demonstrate compliance.

(8) For reporting purposes, a change to any of these elements not previously reported, except for paragraph (b)(5) of this section, constitutes a new operating scenario.

(c) A schedule or log of operating scenarios for processes with batch vents from batch operations updated each time a different operating scenario is put into effect.

(d) The information specified in paragraphs (d)(1) and (2) of this section for Group 1 batch process vents in compliance with a percent reduction emission limit in Table 2 to this subpart if some of the vents are controlled to less the percent reduction requirement.

(1) Records of whether each batch operated was considered a standard batch.

(2) The estimated uncontrolled and controlled emissions for each batch that is considered to be a nonstandard batch.

(e) The information specified in paragraph (e)(2), (3), or (4) of this section, as applicable, for each process with Group 2 batch process vents or uncontrolled hydrogen halide and halogen HAP emissions from the sum of all batch and continuous process vents less than 1,000 lb/yr. No records are required for situations described in paragraph (e)(1) of this section.

(1) No records are required if you documented in your notification of compliance status report that the MCPU meets any of the situations described in paragraph (e)(1)(i), (ii), or (iii) of this section.

(i) The MCPU does not process, use, or generate HAP.

(ii) You control the Group 2 batch process vents using a flare that meets the requirements of §63.987.

(iii) You control the Group 2 batch process vents using a control device for which your determination of worst case for initial compliance includes the contribution of all Group 2 batch process vents.

(2) If you documented in your notification of compliance status report that an MCPU has Group 2 batch process vents because the non-reactive organic HAP is the only HAP and usage is less than 10,000 lb/yr, as specified in §63.2460(b)(7), you must keep records of the amount of HAP material used, and calculate the daily rolling annual sum of the amount used no less frequently than monthly. If a record indicates usage exceeds 10,000 lb/yr, you must estimate emissions for the preceding 12 months based on the number of batches operated and the estimated emissions for a standard batch, and you must begin recordkeeping as specified in paragraph (e)(4) of this section. After 1 year, you may revert to recording only usage if the usage during the year is less than 10,000 lb.

(3) If you documented in your notification of compliance status report that total uncontrolled organic HAP emissions from the batch process vents in an MCPU will be less than 1,000 lb/yr for the anticipated

number of standard batches, then you must keep records of the number of batches operated and calculate a daily rolling annual sum of batches operated no less frequently than monthly. If the number of batches operated results in organic HAP emissions that exceed 1,000 lb/yr, you must estimate emissions for the preceding 12 months based on the number of batches operated and the estimated emissions for a standard batch, and you must begin recordkeeping as specified in paragraph (e)(4) of this section. After 1 year, you may revert to recording only the number of batches if the number of batches operated during the year results in less than 1,000 lb of organic HAP emissions.

(4) If you meet none of the conditions specified in paragraphs (e)(1) through (3) of this section, you must keep records of the information specified in paragraphs (e)(4)(i) through (iv) of this section.

(i) A record of the day each batch was completed and/or the operating hours per day for continuous operations with hydrogen halide and halogen emissions.

(ii) A record of whether each batch operated was considered a standard batch.

(iii) The estimated uncontrolled and controlled emissions for each batch that is considered to be a nonstandard batch.

(iv) Records of the daily 365-day rolling summations of emissions, or alternative records that correlate to the emissions (e.g., number of batches), calculated no less frequently than monthly.

(f) A record of each time a safety device is opened to avoid unsafe conditions in accordance with §63.2450(s).

(g) Records of the results of each CPMS calibration check and the maintenance performed, as specified in §63.2450(k)(1).

(h) For each CEMS, you must keep records of the date and time that each deviation started and stopped, and whether the deviation occurred during a period of startup, shutdown, or malfunction or during another period.

(i) For each PUG, you must keep records specified in paragraphs (i)(1) through (5) of this section.

(1) Descriptions of the MCPU and other process units in the initial PUG required by §63.2535(l)(1)(v).

(2) Rationale for including each MCPU and other process unit in the initial PUG (*i.e.*, identify the overlapping equipment between process units) required by §63.2535(l)(1)(v).

(3) Calculations used to determine the primary product for the initial PUG required by §63.2535(l)(2)(iv).

(4) Descriptions of process units added to the PUG after the creation date and rationale for including the additional process units in the PUG as required by §63.2535(l)(1)(v).

(5) The calculation of each primary product redetermination required by §63.2535(l)(2)(iv).

(j) In the SSMP required by §63.6(e)(3), you are not required to include Group 2 emission points, unless those emission points are used in an emissions average. For equipment leaks, the SSMP requirement is limited to control devices and is optional for other equipment.

(k) For each bag leak detector used to monitor PM HAP emissions from a fabric filter, maintain records of any bag leak detection alarm, including the date and time, with a brief explanation of the cause of the alarm and the corrective action taken.

[68 FR 63888, Nov. 10, 2003, as amended at 70 FR 38560, July 1, 2005; 71 FR 40337, July 14, 2006]

## **OTHER REQUIREMENTS AND INFORMATION**

### **§63.2535 What compliance options do I have if part of my plant is subject to both this subpart and another subpart?**

For any equipment, emission stream, or wastewater stream subject to the provisions of both this subpart and another rule, you may elect to comply only with the provisions as specified in paragraphs (a) through (l) of this section. You also must identify the subject equipment, emission stream, or wastewater stream, and the provisions with which you will comply, in your notification of compliance status report required by §63.2520(d).

(a) *Compliance with other subparts of this part 63.* (1) If you have an MCPU that includes a batch process vent that also is part of a CMPU as defined in subparts F and G of this part 63, you must comply with the emission limits; operating limits; work practice standards; and the compliance, monitoring, reporting, and recordkeeping requirements for batch process vents in this subpart, and you must continue to comply with the requirements in subparts F, G, and H of this part 63 that are applicable to the CMPU and associated equipment.

(2) After the compliance dates specified in §63.2445, at an offsite reloading or cleaning facility subject to §63.1253(f), as referenced from §63.2470(e), compliance with the monitoring, recordkeeping, and reporting provisions of any other subpart of this part 63 constitutes compliance with the monitoring, recordkeeping, and reporting provisions of §63.1253(f)(7)(ii) or §63.1253(f)(7)(iii). You must identify in your notification of compliance status report required by §63.2520(d) the subpart of this part 63 with which the owner or operator of the offsite reloading or cleaning facility complies.

(b) *Compliance with 40 CFR parts 264 and 265, subparts AA, BB, and/or CC.* (1) After the compliance dates specified in §63.2445, if a control device that you use to comply with this subpart is also subject to monitoring, recordkeeping, and reporting requirements in 40 CFR part 264, subpart AA, BB, or CC; or the monitoring and recordkeeping requirements in 40 CFR part 265, subpart AA, BB, or CC; and you comply with the periodic reporting requirements under 40 CFR part 264, subpart AA, BB, or CC that would apply to the device if your facility had final-permitted status, you may elect to comply either with the monitoring, recordkeeping, and reporting requirements of this subpart; or with the monitoring and recordkeeping requirements in 40 CFR part 264 or 265 and the reporting requirements in 40 CFR part 264, as described in this paragraph (b)(1), which constitute compliance with the monitoring, recordkeeping, and reporting requirements of this subpart. If you elect to comply with the monitoring, recordkeeping, and reporting requirements in 40 CFR parts 264 and/or 265, you must report the information described in §63.2520(e).

(2) After the compliance dates specified in §63.2445, if you have an affected source with equipment that is also subject to 40 CFR part 264, subpart BB, or to 40 CFR part 265, subpart BB, then compliance with the recordkeeping and reporting requirements of 40 CFR parts 264 and/or 265 may be used to comply with the recordkeeping and reporting requirements of this subpart, to the extent that the requirements of 40 CFR parts 264 and/or 265 duplicate the requirements of this subpart.

(c) *Compliance with 40 CFR part 60, subpart Kb and 40 CFR part 61, subpart Y.* After the compliance dates specified in §63.2445, you are in compliance with the provisions of this subpart FFFF for any storage tank that is assigned to an MCPU and that is both controlled with a floating roof and in compliance with the provisions of either 40 CFR part 60, subpart Kb, or 40 CFR part 61, subpart Y. You

are in compliance with this subpart FFFF if you have a storage tank with a fixed roof, closed-vent system, and control device in compliance with the provisions of either 40 CFR part 60, subpart Kb, or 40 CFR part 61, subpart Y, except that you must comply with the monitoring, recordkeeping, and reporting requirements in this subpart FFFF. Alternatively, if a storage tank assigned to an MCPU is subject to control under 40 CFR part 60, subpart Kb, or 40 CFR part 61, subpart Y, you may elect to comply only with the requirements for Group 1 storage tanks in this subpart FFFF.

(d) *Compliance with subpart I, GGG, or MMM of this part 63.* After the compliance dates specified in §63.2445, if you have an affected source with equipment subject to subpart I, GGG, or MMM of this part 63, you may elect to comply with the provisions of subpart H, GGG, or MMM of this part 63, respectively, for all such equipment.

(e) *Compliance with subpart GGG of this part 63 for wastewater.* After the compliance dates specified in §63.2445, if you have an affected source subject to this subpart and you have an affected source that generates wastewater streams that meet the applicability thresholds specified in §63.1256, you may elect to comply with the provisions of this subpart FFFF for all such wastewater streams.

(f) *Compliance with subpart MMM of this part 63 for wastewater.* After the compliance dates specified in §63.2445, if you have an affected source subject to this subpart, and you have an affected source that generates wastewater streams that meet the applicability thresholds specified in §63.1362(d), you may elect to comply with the provisions of this subpart FFFF for all such wastewater streams (except that the 99 percent reduction requirement for streams subject to §63.1362(d)(10) still applies).

(g) *Compliance with other regulations for wastewater.* After the compliance dates specified in §63.2445, if you have a Group 1 wastewater stream that is also subject to provisions in 40 CFR parts 260 through 272, you may elect to determine whether this subpart or 40 CFR parts 260 through 272 contain the more stringent control requirements (e.g., design, operation, and inspection requirements for waste management units; numerical treatment standards; etc.) and the more stringent testing, monitoring, recordkeeping, and reporting requirements. Compliance with provisions of 40 CFR parts 260 through 272 that are determined to be more stringent than the requirements of this subpart constitute compliance with this subpart. For example, provisions of 40 CFR parts 260 through 272 for treatment units that meet the conditions specified in §63.138(h) constitute compliance with this subpart. You must identify in the notification of compliance status report required by §63.2520(d) the information and procedures that you used to make any stringency determinations.

(h) *Compliance with 40 CFR part 60, subpart DDD, III, NNN, or RRR.* After the compliance dates specified in §63.2445, if you have an MCPU that contains equipment subject to the provisions of this subpart that are also subject to the provisions of 40 CFR part 60, subpart DDD, III, NNN, or RRR, you may elect to apply this subpart to all such equipment in the MCPU. If an MCPU subject to the provisions of this subpart has equipment to which this subpart does not apply but which is subject to a standard in 40 CFR part 60, subpart DDD, III, NNN, or RRR, you may elect to comply with the requirements for Group 1 process vents in this subpart for such equipment. If you elect any of these methods of compliance, you must consider all total organic compounds, minus methane and ethane, in such equipment for purposes of compliance with this subpart, as if they were organic HAP. Compliance with the provisions of this subpart, in the manner described in this paragraph (h), will constitute compliance with 40 CFR part 60, subpart DDD, III, NNN, or RRR, as applicable.

(i) *Compliance with 40 CFR part 61, subpart BB.* (1) After the compliance dates specified in §63.2445, a Group 1 transfer rack, as defined in §63.2550, that is also subject to the provisions of 40 CFR part 61, subpart BB, you are required to comply only with the provisions of this subpart.

(2) After the compliance dates specified in §63.2445, a Group 2 transfer rack, as defined in §63.2550, that is also subject to the provisions of 40 CFR part 61, subpart BB, is required to comply with the provisions of either paragraph (1)(2)(i) or (ii) of this section.

(i) If the transfer rack is subject to the control requirements specified in §61.302 of 40 CFR part 61, subpart BB, then you may elect to comply with either the requirements of 40 CFR part 61, subpart BB, or the requirements for Group 1 transfer racks under this subpart FFFF.

(ii) If the transfer rack is subject only to reporting and recordkeeping requirements under 40 CFR part 61, subpart BB, then you are required to comply only with the reporting and recordkeeping requirements specified in this subpart for Group 2 transfer racks, and you are exempt from the reporting and recordkeeping requirements in 40 CFR part 61, subpart BB.

(j) *Compliance with 40 CFR part 61, subpart FF.* After the compliance date specified in §63.2445, for a Group 1 or Group 2 wastewater stream that is also subject to the provisions of 40 CFR 61.342(c) through (h), and is not exempt under 40 CFR 61.342(c)(2) or (3), you may elect to comply only with the requirements for Group 1 wastewater streams in this subpart FFFF. If a Group 2 wastewater stream is exempted from 40 CFR 61.342(c)(1) under 40 CFR 61.342(c)(2) or (3), then you are required to comply only with the reporting and recordkeeping requirements specified in this subpart for Group 2 wastewater streams, and you are exempt from the requirements in 40 CFR part 61, subpart FF.

(k) *Compliance with 40 CFR part 60, subpart VV, and 40 CFR part 61, subpart V.* After the compliance date specified in §63.2445, if you have an affected source with equipment that is also subject to the requirements of 40 CFR part 60, subpart VV, or 40 CFR part 61, subpart V, you may elect to apply this subpart to all such equipment. After the compliance date specified in §63.2445, if you have an affected source with equipment to which this subpart does not apply, but which is subject to the requirements of 40 CFR part 60, subpart VV, or 40 CFR part 61, subpart V, you may elect to apply this subpart to all such equipment. If you elect either of these methods of compliance, you must consider all total organic compounds, minus methane and ethane, in such equipment for purposes of compliance with this subpart, as if they were organic HAP. Compliance with the provisions of this subpart, in the manner described in this paragraph (k), will constitute compliance with 40 CFR part 60, subpart VV and 40 CFR part 61, subpart V, as applicable.

(l) *Applicability of process units included in a process unit group.* You may elect to develop and comply with the requirements for PUG in accordance with paragraphs (l)(1) through (3) of this section.

(1) *Procedures to create process unit groups.* Develop and document changes in a PUG in accordance with the procedures specified in paragraphs (l)(1)(i) through (v) of this section.

(i) Initially, identify an MCPU that is created from nondedicated equipment that will operate on or after November 10, 2003 and identify all processing equipment that is part of this MCPU, based on descriptions in operating scenarios.

(ii) Add to the group any other nondedicated MCPU and other nondedicated process units expected to be operated in the 5 years after the date specified in paragraph (l)(1)(i) of this section, provided they satisfy the criteria specified in paragraphs (l)(1)(ii)(A) through (C) of this section. Also identify all of the processing equipment used for each process unit based on information from operating scenarios and other applicable documentation.

(A) Each process unit that is added to a group must have some processing equipment that is also part of one or more process units in the group.

(B) No process unit may be part of more than one PUG.

(C) The processing equipment used to satisfy the requirement of paragraph (l)(1)(ii)(A) of this section may not be a storage tank or control device.

(iii) The initial PUG consists of all of the processing equipment for the process units identified in paragraphs (l)(1)(i) and (ii) of this section. As an alternative to the procedures specified in paragraphs (l)(1)(i) and (ii) of this section, you may use a PUG that was developed in accordance with §63.1360(h) as your initial PUG.

(iv) Add process units developed in the future in accordance with the conditions specified in paragraphs (l)(1)(ii)(A) and (B) of this section.

(v) Maintain records that describe the process units in the initial PUG, the procedure used to create the PUG, and subsequent changes to each PUG as specified in §63.2525(i). Submit the records in reports as specified in §63.2520(d)(2)(ix) and (e)(8).

(2) *Determine primary product.* You must determine the primary product of each PUG created in paragraph (l)(1) of this section according to the procedures specified in paragraphs (l)(2)(i) through (iv) of this section.

(i) The primary product is the type of product (e.g., organic chemicals subject to §63.2435(b)(1), pharmaceutical products subject to §63.1250, or pesticide active ingredients subject to §63.1360) expected to be produced for the greatest operating time in the 5-year period specified in paragraph (l)(1)(ii) of this section.

(ii) If the PUG produces multiple types of products equally based on operating time, then the primary product is the type of product with the greatest production on a mass basis over the 5-year period specified in paragraph (l)(1)(ii) of this section.

(iii) At a minimum, you must redetermine the primary product of the PUG following the procedure specified in paragraphs (l)(2)(i) and (ii) of this section every 5 years.

(iv) You must record the calculation of the initial primary product determination as specified in §63.2525(i)(3) and report the results in the notification of compliance status report as specified in §63.2520(d)(8)(ix). You must record the calculation of each redetermination of the primary product as specified in §63.2525(i)(5) and report the calculation in a compliance report submitted no later than the report covering the period for the end of the 5th year after cessation of production of the previous primary product, as specified in §63.2520(e)(8).

(3) *Compliance requirements.* (i) If the primary product of the PUG is determined according to paragraph (l)(2) of this section to be material described in §63.2435(b)(1), then you must comply with this subpart for each MCPU in the PUG. You may also elect to comply with this subpart for all other process units in the PUG, which constitutes compliance with other part 63 rules.

(ii) If the primary product of the PUG is determined according to paragraph (l)(2) of this section to be material not described in §63.2435(b)(1), then you must comply with paragraph (l)(3)(ii)(A), (B), or (C) of this section, as applicable.

(A) If the primary product is subject to subpart GGG of this part 63, then comply with the requirements of subpart GGG for each MCPU in the PUG.

(B) If the primary product is subject to subpart MMM of this part 63, then comply with the requirements of subpart MMM for each MCPU in the PUG.

(C) If the primary product is subject to any subpart in this part 63 other than subpart GGG or subpart MMM, then comply with the requirements of this subpart for each MCPU in the PUG.

(iii) The requirements for new and reconstructed sources in the alternative subpart apply to all MCPU in the PUG if and only if the affected source under the alternative subpart meets the requirements for construction or reconstruction.

[68 FR 63888, Nov. 10, 2003, as amended at 71 FR 40337, July 14, 2006]

### **§63.2540 What parts of the General Provisions apply to me?**

Table 12 to this subpart shows which parts of the General Provisions in §§63.1 through 63.15 apply to you.

### **§63.2545 Who implements and enforces this subpart?**

(a) This subpart can be implemented and enforced by us, the U.S. Environmental Protection Agency (U.S. EPA), or a delegated authority such as your State, local, or tribal agency. If the U.S. EPA Administrator has delegated authority to your State, local, or tribal agency, then that agency also has the authority to implement and enforce this subpart. You should contact your U.S. EPA Regional Office to find out if this subpart is delegated to your State, local, or tribal agency.

(b) In delegating implementation and enforcement authority of this subpart to a State, local, or tribal agency under 40 CFR part 63, subpart E, the authorities contained in paragraphs (b)(1) through (4) of this section are retained by the Administrator of U.S. EPA and are not delegated to the State, local, or tribal agency.

(1) Approval of alternatives to the non-opacity emission limits and work practice standards in §63.2450(a) under §63.6(g).

(2) Approval of major alternatives to test methods under §63.7(e)(2)(ii) and (f) and as defined in §63.90.

(3) Approval of major alternatives to monitoring under §63.8(f) and as defined in §63.90.

(4) Approval of major alternatives to recordkeeping and reporting under §63.10(f) and as defined in §63.90.

### **§63.2550 What definitions apply to this subpart?**

(a) For an affected source complying with the requirements in subpart SS of this part 63, the terms used in this subpart and in subpart SS of this part 63 have the meaning given them in §63.981, except as specified in §§63.2450(k)(2) and (m), 63.2470(c)(2), 63.2475(b), and paragraph (i) of this section.

(b) For an affected source complying with the requirements in 40 CFR part 65, subpart F, the terms used in this subpart and in 40 CFR part 65, subpart F have the meaning given to them in §65.2.

(c) For an affected source complying with the requirements in subpart UU of this part 63, the terms used in this subpart and in subpart UU of this part 63 have the meaning given them in §63.1020.

(d) For an affected source complying with the requirements in subpart WW of this part 63, the terms used in this subpart and subpart WW of this part 63 have the meaning given them in §63.1061, except as specified in §§63.2450(m), 63.2470(c)(2), and paragraph (i) of this section.

(e) For an affected source complying with the requirements in §§63.132 through 63.149, the terms used in this subpart and §§63.132 through 63.149 have the meaning given them in §§63.101 and 63.111, except as specified in §63.2450(m) and paragraph (i) of this section.

(f) For an affected source complying with the requirements in §§63.104 and 63.105, the terms used in this subpart and in §§63.104 and 63.105 of this subpart have the meaning given them in §63.101, except as specified in §§63.2450(m), 63.2490(b), and paragraph (i) of this section.

(g) For an affected source complying with requirements in §§63.1253, 63.1257, and 63.1258, the terms used in this subpart and in §§63.1253, 63.1257, and 63.1258 have the meaning given them in §63.1251, except as specified in §63.2450(m) and paragraph (i) of this section.

(h) For an affected source complying with the requirements in 40 CFR part 65, subpart F, the terms used in this subpart and in 40 CFR part 65, subpart F, have the meaning given them in 40 CFR 65.2.

(i) All other terms used in this subpart are defined in the Clean Air Act (CAA), in 40 CFR 63.2, and in this paragraph (i). If a term is defined in §63.2, §63.101, §63.111, §63.981, §63.1020, §63.1061, §63.1251, or §65.2 and in this paragraph (i), the definition in this paragraph (i) applies for the purposes of this subpart.

*Ancillary activities* means boilers and incinerators (not used to comply with the emission limits in Tables 1 through 7 to this subpart), chillers and refrigeration systems, and other equipment and activities that are not directly involved (*i.e.*, they operate within a closed system and materials are not combined with process fluids) in the processing of raw materials or the manufacturing of a product or isolated intermediate.

*Batch operation* means a noncontinuous operation involving intermittent or discontinuous feed into equipment, and, in general, involves the emptying of the equipment after the operation ceases and prior to beginning a new operation. Addition of raw material and withdrawal of product do not occur simultaneously in a batch operation.

*Batch process vent* means a vent from a unit operation or vents from multiple unit operations within a process that are manifolded together into a common header, through which a HAP-containing gas stream is, or has the potential to be, released to the atmosphere. Examples of batch process vents include, but are not limited to, vents on condensers used for product recovery, reactors, filters, centrifuges, and process tanks. The following are not batch process vents for the purposes of this subpart:

- (1) Continuous process vents;
- (2) Bottoms receivers;
- (3) Surge control vessels;
- (4) Gaseous streams routed to a fuel gas system(s);
- (5) Vents on storage tanks, wastewater emission sources, or pieces of equipment subject to the emission limits and work practice standards in Tables 4, 6, and 7 to this subpart;
- (6) Drums, pails, and totes;
- (7) Flexible elephant trunk systems that draw ambient air (*i.e.*, the system is not ducted, piped, or otherwise connected to the unit operations) away from operators when vessels are opened; and



(8) Emission streams from emission episodes that are undiluted and uncontrolled containing less than 50 ppmv HAP are not part of any batch process vent. A vent from a unit operation, or a vent from multiple unit operations that are manifolded together, from which total uncontrolled HAP emissions are less than 200 lb/yr is not a batch process vent; emissions for all emission episodes associated with the unit operation(s) must be included in the determination of the total mass emitted. The HAP concentration or mass emission rate may be determined using any of the following: process knowledge that no HAP are present in the emission stream; an engineering assessment as discussed in §63.1257(d)(2)(ii), except that you do not need to demonstrate that the equations in §63.1257(d)(2)(i) do not apply, and the precompliance reporting requirements specified in §63.1257(d)(2)(ii)(E) do not apply for the purposes of this demonstration; equations specified in §63.1257(d)(2)(i), as applicable; test data using Method 18 of 40 CFR part 60, appendix A; or any other test method that has been validated according to the procedures in Method 301 of appendix A of this part.

*Biofilter* means an enclosed control system such as a tank or series of tanks with a fixed roof that contact emissions with a solid media (such as bark) and use microbiological activity to transform organic pollutants in a process vent stream to innocuous compounds such as carbon dioxide, water, and inorganic salts. Wastewater treatment processes such as aeration lagoons or activated sludge systems are not considered to be biofilters.

*Bottoms receiver* means a tank that collects bottoms from continuous distillation before the stream is sent for storage or for further downstream processing.

*Construction* means the onsite fabrication, erection, or installation of an affected source or MCPU. Addition of new equipment to an MCPU subject to existing source standards does not constitute construction, but it may constitute reconstruction of the affected source or MCPU if it satisfies the definition of reconstruction in §63.2.

*Consumption* means the quantity of all HAP raw materials entering a process in excess of the theoretical amount used as reactant, assuming 100 percent stoichiometric conversion. The raw materials include reactants, solvents, and any other additives. If a HAP is generated in the process as well as added as a raw material, consumption includes the quantity generated in the process.

*Continuous operation* means any operation that is not a batch operation.

*Continuous process vent* means the point of discharge to the atmosphere (or the point of entry into a control device, if any) of a gas stream if the gas stream has the characteristics specified in §63.107(b) through (h), or meets the criteria specified in §63.107(i), except:

(1) The reference in §63.107(e) to a chemical manufacturing process unit that meets the criteria of §63.100(b) means an MCPU that meets the criteria of §63.2435(b);

(2) The reference in §63.107(h)(4) to §63.113 means Table 1 to this subpart;

(3) The references in §63.107(h)(7) to §§63.119 and 63.126 mean tables 4 and 5 to this subpart;  
and

(4) For the purposes of §63.2455, all references to the characteristics of a process vent (e.g., flowrate, total HAP concentration, or TRE index value) mean the characteristics of the gas stream.

(5) The reference to “total organic HAP” in §63.107(d) means “total HAP” for the purposes of this subpart FFFF.

(6) The references to an “air oxidation reactor, distillation unit, or reactor” in §63.107 mean any continuous operation for the purposes of this subpart.

(7) A separate determination is required for the emissions from each MCPU, even if emission streams from two or more MCPU are combined prior to discharge to the atmosphere or to a control device.

*Dedicated MCPU* means an MCPU that consists of equipment that is used exclusively for one process, except that storage tanks assigned to the process according to the procedures in §63.2435(d) also may be shared by other processes.

*Deviation* means any instance in which an affected source subject to this subpart, or an owner or operator of such a source:

(1) Fails to meet any requirement or obligation established by this subpart including, but not limited to, any emission limit, operating limit, or work practice standard; or

(2) Fails to meet any term or condition that is adopted to implement an applicable requirement in this subpart and that is included in the operating permit for any affected source required to obtain such a permit; or

(3) Fails to meet any emission limit, operating limit, or work practice standard in this subpart during startup, shutdown, or malfunction, regardless of whether or not such failure is permitted by this subpart.

*Emission point* means each continuous process vent, batch process vent, storage tank, transfer rack, and wastewater stream.

*Energetics* means propellants, explosives, and pyrotechnics and include materials listed at 49 CFR 172.101 as Hazard Class I Hazardous Materials, Divisions 1.1 through 1.6.

*Equipment* means each pump, compressor, agitator, pressure relief device, sampling connection system, open-ended valve or line, valve, connector, and instrumentation system in organic HAP service; and any control devices or systems used to comply with Table 6 to this subpart.

*Excess emissions* means emissions greater than those allowed by the emission limit.

*Family of materials* means a grouping of materials with the same basic composition or the same basic end use or functionality produced using the same basic feedstocks with essentially identical HAP emission profiles (primary constituent and relative magnitude on a pound per product basis) and manufacturing equipment configuration. Examples of families of materials include multiple grades of the same product or different variations of a product (e.g., blue, black, and red resins).

*Group 1 batch process vent* means each of the batch process vents in a process for which the collective uncontrolled organic HAP emissions from all of the batch process vents are greater than or equal to 10,000 lb/yr at an existing source or greater than or equal to 3,000 lb/yr at a new source.

*Group 2 batch process vent* means each batch process vent that does not meet the definition of Group 1 batch process vent.

*Group 1 continuous process vent* means a continuous process vent for which the flow rate is greater than or equal to 0.005 standard cubic meter per minute, and the total resource effectiveness index value, calculated according to §63.2455(b), is less than or equal to 1.9 at an existing source and less than or equal to 5.0 at a new source.

*Group 2 continuous process vent* means a continuous process vent that does not meet the definition of a Group 1 continuous process vent.

*Group 1 storage tank* means a storage tank with a capacity greater than or equal to 10,000 gal storing material that has a maximum true vapor pressure of total HAP greater than or equal to 6.9 kilopascals at an existing source or greater than or equal to 0.69 kilopascals at a new source.

*Group 2 storage tank* means a storage tank that does not meet the definition of a Group 1 storage tank.

*Group 1 transfer rack* means a transfer rack that loads more than 0.65 million liters/year of liquids that contain organic HAP with a rack-weighted average partial pressure, as defined in §63.111, greater than or equal to 1.5 pound per square inch absolute.

*Group 2 transfer rack* means a transfer rack that does not meet the definition of a Group 1 transfer rack.

*Group 1 wastewater stream* means a wastewater stream consisting of process wastewater at an existing or new source that meets the criteria for Group 1 status in §63.2485(c) for compounds in Tables 8 and 9 to this subpart and/or a wastewater stream consisting of process wastewater at a new source that meets the criteria for Group 1 status in §63.132(d) for compounds in Table 8 to subpart G of this part 63.

*Group 2 wastewater stream* means any process wastewater stream that does not meet the definition of a Group 1 wastewater stream.

*Halogen atoms* mean chlorine and fluorine.

*Halogenated vent stream* means a vent stream determined to have a mass emission rate of halogen atoms contained in organic compounds of 0.45 kilograms per hour or greater determined by the procedures presented in §63.115(d)(2)(v).

*HAP metals* means the metal portion of antimony compounds, arsenic compounds, beryllium compounds, cadmium compounds, chromium compounds, cobalt compounds, lead compounds, manganese compounds, mercury compounds, nickel compounds, and selenium compounds.

*Hydrogen halide and halogen HAP* means hydrogen chloride, hydrogen fluoride, and chlorine.

*In organic HAP service* means that a piece of equipment either contains or contacts a fluid (liquid or gas) that is at least 5 percent by weight of total organic HAP as determined according to the provisions of §63.180(d). The provisions of §63.180(d) also specify how to determine that a piece of equipment is not in organic HAP service.

*Isolated intermediate* means a product of a process that is stored before subsequent processing. An isolated intermediate is usually a product of a chemical synthesis, fermentation, or biological extraction process. Storage of an isolated intermediate marks the end of a process. Storage occurs at any time the intermediate is placed in equipment used solely for storage. The storage equipment is part of the MCPU that produces the isolated intermediate and is not assigned as specified in §63.2435(d).

*Large control device* means a control device that controls total HAP emissions of greater than or equal to 10 tpy, before control.

*Maintenance wastewater* means wastewater generated by the draining of process fluid from components in the MCPU into an individual drain system in preparation for or during maintenance

activities. Maintenance wastewater can be generated during planned and unplanned shutdowns and during periods not associated with a shutdown. Examples of activities that can generate maintenance wastewater include descaling of heat exchanger tubing bundles, cleaning of distillation column traps, draining of pumps into an individual drain system, and draining of portions of the MCPU for repair. Wastewater from routine cleaning operations occurring as part of batch operations is not considered maintenance wastewater.

*Maximum true vapor pressure* has the meaning given in §63.111, except that it applies to all HAP rather than only organic HAP.

*Miscellaneous organic chemical manufacturing process* means all equipment which collectively function to produce a product or isolated intermediate that are materials described in §63.2435(b). For the purposes of this subpart, process includes any, all or a combination of reaction, recovery, separation, purification, or other activity, operation, manufacture, or treatment which are used to produce a product or isolated intermediate. A process is also defined by the following:

- (1) Routine cleaning operations conducted as part of batch operations are considered part of the process;
  - (2) Each nondedicated solvent recovery operation is considered a single process;
  - (3) Each nondedicated formulation operation is considered a single process that is used to formulate numerous materials and/or products;
  - (4) Quality assurance/quality control laboratories are not considered part of any process; and
  - (5) Ancillary activities are not considered a process or part of any process.
- (6) The end of a process that produces a solid material is either up to and including the dryer or extruder, or for a polymer production process without a dryer or extruder, it is up to and including the extruder, die plate, or solid-state reactor, except in two cases. If the dryer, extruder, die plate, or solid-state reactor is followed by an operation that is designed and operated to remove HAP solvent or residual HAP monomer from the solid, then the solvent removal operation is the last step in the process. If the dried solid is diluted or mixed with a HAP-based solvent, then the solvent removal operation is the last step in the process.

*Nondedicated solvent recovery operation* means a distillation unit or other purification equipment that receives used solvent from more than one MCPU.

*Nonstandard batch* means a batch process that is operated outside of the range of operating conditions that are documented in an existing operating scenario but is still a reasonably anticipated event. For example, a nonstandard batch occurs when additional processing or processing at different operating conditions must be conducted to produce a product that is normally produced under the conditions described by the standard batch. A nonstandard batch may be necessary as a result of a malfunction, but it is not itself a malfunction.

*On-site or on site* means, with respect to records required to be maintained by this subpart or required by another subpart referenced by this subpart, that records are stored at a location within a major source which encompasses the affected source. On-site includes, but is not limited to, storage at the affected source or MCPU to which the records pertain, or storage in central files elsewhere at the major source.

*Operating scenario* means, for the purposes of reporting and recordkeeping, any specific operation of an MCPU as described by records specified in §63.2525(b).

*Organic group* means structures that contain primarily carbon, hydrogen, and oxygen atoms.

*Organic peroxides* means organic compounds containing the bivalent -o-o-structure which may be considered to be a structural derivative of hydrogen peroxide where one or both of the hydrogen atoms has been replaced by an organic radical.

*Point of determination* means each point where process wastewater exits the MCPU or control device.

NOTE TO DEFINITION FOR POINT OF DETERMINATION: The regulation allows determination of the characteristics of a wastewater stream: At the point of determination; or downstream of the point of determination if corrections are made for changes in flow rate and annual average concentration of soluble HAP and partially soluble HAP compounds as determined according to procedures in §63.144 of subpart G in this part 63. Such changes include losses by air emissions; reduction of annual average concentration or changes in flow rate by mixing with other water or wastewater streams; and reduction in flow rate or annual average concentration by treating or otherwise handling the wastewater stream to remove or destroy HAP.

*Predominant HAP* means as used in calibrating an analyzer, the single organic HAP that constitutes the largest percentage of the total organic HAP in the analyzed gas stream, by volume.

*Process condenser* means a condenser whose primary purpose is to recover material as an integral part of an MCPU. All condensers recovering condensate from an MCPU at or above the boiling point or all condensers in line prior to a vacuum source are considered process condensers. Typically, a primary condenser or condensers in series are considered to be integral to the MCPU if they are capable of and normally used for the purpose of recovering chemicals for fuel value (i.e., net positive heating value), use, reuse or for sale for fuel value, use, or reuse. This definition does not apply to a condenser that is used to remove materials that would hinder performance of a downstream recovery device as follows:

- (1) To remove water vapor that would cause icing in a downstream condenser, or
- (2) To remove water vapor that would negatively affect the adsorption capacity of carbon in a downstream carbon adsorber, or
- (3) To remove high molecular weight organic compounds or other organic compounds that would be difficult to remove during regeneration of a downstream carbon adsorber.

*Process tank* means a tank or vessel that is used within a process to collect material discharged from a feedstock storage tank or equipment within the process before the material is transferred to other equipment within the process or a product storage tank. A process tank has emissions that are related to the characteristics of the batch cycle, and it does not accumulate product over multiple batches. Surge control vessels and bottoms receivers are not process tanks.

*Production-indexed HAP consumption factor (HAP factor)* means the result of dividing the annual consumption of total HAP by the annual production rate, per process.

*Production-indexed VOC consumption factor (VOC factor)* means the result of dividing the annual consumption of total VOC by the annual production rate, per process.

*Quaternary ammonium compounds* means a type of organic nitrogen compound in which the molecular structure includes a central nitrogen atom joined to four organic groups as well as an acid radical of some sort.

*Recovery device* means an individual unit of equipment used for the purpose of recovering chemicals from process vent streams and from wastewater streams for fuel value (i.e., net positive heating value), use, reuse, or for sale for fuel value, use, or reuse. For the purposes of meeting requirements in table 2 to this subpart, the recovery device must not be a process condenser and must recover chemicals to be reused in a process on site. Examples of equipment that may be recovery devices include absorbers, carbon adsorbers, condensers, oil-water separators or organic-water separators, or organic removal devices such as decanters, strippers, or thin-film evaporation units. To be a recovery device for a wastewater stream, a decanter and any other equipment based on the operating principle of gravity separation must receive only multi-phase liquid streams.

*Responsible official* means responsible official as defined in 40 CFR 70.2.

*Safety device* means a closure device such as a pressure relief valve, frangible disc, fusible plug, or any other type of device which functions exclusively to prevent physical damage or permanent deformation to a unit or its air emission control equipment by venting gases or vapors directly to the atmosphere during unsafe conditions resulting from an unplanned, accidental, or emergency event. For the purposes of this subpart, a safety device is not used for routine venting of gases or vapors from the vapor headspace underneath a cover such as during filling of the unit or to adjust the pressure in response to normal daily diurnal ambient temperature fluctuations. A safety device is designed to remain in a closed position during normal operations and open only when the internal pressure, or another relevant parameter, exceeds the device threshold setting applicable to the air emission control equipment as determined by the owner or operator based on manufacturer recommendations, applicable regulations, fire protection and prevention codes and practices, or other requirements for the safe handling of flammable, combustible, explosive, reactive, or hazardous materials.

*Shutdown* means the cessation of operation of a continuous operation for any purpose. Shutdown also means the cessation of a batch operation, or any related individual piece of equipment required or used to comply with this subpart, if the steps taken to cease operation differ from those described in a standard batch or nonstandard batch. Shutdown also applies to emptying and degassing storage vessels. Shutdown does not apply to cessation of batch operations at the end of a campaign or between batches within a campaign when the steps taken are routine operations.

*Small control device* means a control device that controls total HAP emissions of less than 10 tpy, before control.

*Standard batch* means a batch process operated within a range of operating conditions that are documented in an operating scenario. Emissions from a standard batch are based on the operating conditions that result in highest emissions. The standard batch defines the uncontrolled and controlled emissions for each emission episode defined under the operating scenario.

*Startup* means the setting in operation of a continuous operation for any purpose; the first time a new or reconstructed batch operation begins production; for new equipment added, including equipment required or used to comply with this subpart, the first time the equipment is put into operation; or for the introduction of a new product/process, the first time the product or process is run in equipment. For batch operations, startup applies to the first time the equipment is put into operation at the start of a campaign to produce a product that has been produced in the past if the steps taken to begin production differ from those specified in a standard batch or nonstandard batch. Startup does not apply when the equipment is put into operation as part of a batch within a campaign when the steps taken are routine operations.

*Storage tank* means a tank or other vessel that is used to store liquids that contain organic HAP and/or hydrogen halide and halogen HAP and that has been assigned to an MCPU according to the procedures in §63.2435(d). The following are not considered storage tanks for the purposes of this subpart:

- (1) Vessels permanently attached to motor vehicles such as trucks, railcars, barges, or ships;
- (2) Pressure vessels designed to operate in excess of 204.9 kilopascals and without emissions to the atmosphere;
- (3) Vessels storing organic liquids that contain HAP only as impurities;
- (4) Wastewater storage tanks;
- (5) Bottoms receivers;
- (6) Surge control vessels; and
- (7) Process tanks.

*Supplemental gases* means the air that is added to a vent stream after the vent stream leaves the unit operation. Air that is part of the vent stream as a result of the nature of the unit operation is not considered supplemental gases. Air required to operate combustion device burner(s) is not considered supplemental gases.

*Surge control vessel* means feed drums, recycle drums, and intermediate vessels as part of any continuous operation. Surge control vessels are used within an MCPU when in-process storage, mixing, or management of flowrates or volumes is needed to introduce material into continuous operations.

*Total organic compounds or (TOC)* means the total gaseous organic compounds (minus methane and ethane) in a vent stream.

*Transfer rack* means the collection of loading arms and loading hoses, at a single loading rack, that are assigned to an MCPU according to the procedures specified in §63.2435(d) and are used to fill tank trucks and/or rail cars with organic liquids that contain one or more of the organic HAP listed in section 112(b) of the CAA of this subpart. Transfer rack includes the associated pumps, meters, shutoff valves, relief valves, and other piping and valves.

*Unit operation* means those processing steps that occur within distinct equipment that are used, among other things, to prepare reactants, facilitate reactions, separate and purify products, and recycle materials. Equipment used for these purposes includes, but is not limited to, reactors, distillation columns, extraction columns, absorbers, decanters, dryers, condensers, and filtration equipment.

*Waste management unit* means the equipment, structure(s), and/or device(s) used to convey, store, treat, or dispose of wastewater streams or residuals. Examples of waste management units include wastewater tanks, air flotation units, surface impoundments, containers, oil-water or organic-water separators, individual drain systems, biological wastewater treatment units, waste incinerators, and organic removal devices such as steam and air stripper units, and thin film evaporation units. If such equipment is being operated as a recovery device, then it is part of a miscellaneous organic chemical manufacturing process and is not a waste management unit.

*Wastewater* means water that is discarded from an MCPU or control device through a POD and that contains either: an annual average concentration of compounds in tables 8 and 9 to this subpart of at least 5 ppmw and has an annual average flowrate of 0.02 liters per minute or greater; or an annual average concentration of compounds in tables 8 and 9 to this subpart of at least 10,000 ppmw at any flowrate. Wastewater means process wastewater or maintenance wastewater. The following are not considered wastewater for the purposes of this subpart:

- (1) Stormwater from segregated sewers;
- (2) Water from fire-fighting and deluge systems, including testing of such systems;
- (3) Spills;
- (4) Water from safety showers;
- (5) Samples of a size not greater than reasonably necessary for the method of analysis that is used;
- (6) Equipment leaks;
- (7) Wastewater drips from procedures such as disconnecting hoses after cleaning lines; and
- (8) Noncontact cooling water.

*Wastewater stream* means a stream that contains only wastewater as defined in this paragraph (i).

*Work practice standard* means any design, equipment, work practice, or operational standard, or combination thereof, that is promulgated pursuant to section 112(h) of the CAA.

[68 FR 63888, Nov. 10, 2003, as amended at 70 FR 38560, July 1, 2005; 71 FR 40338, July 14, 2006]

**Table 1 to Subpart FFFF of Part 63—Emission Limits and Work Practice Standards for Continuous Process Vents**

As required in §63.2455, you must meet each emission limit and work practice standard in the following table that applies to your continuous process vents:

| <b>For each . . .</b>                                 | <b>For which . . .</b>  | <b>Then you must . . .</b>  |
|---|---|---|
| 1. Group 1 continuous process vent                    | a. Not applicable   | i. Reduce emissions of total organic HAP by $\geq 98$ percent by weight or to an outlet process concentration $\leq 20$ ppmv as organic HAP or TOC by venting emissions through a closed-vent system to any combination of control devices (except a flare); or |
|   |   | ii. Reduce emissions of total organic HAP by venting emissions through a closed vent system to a flare; or  |
|   |   | iii. Use a recovery device to maintain the TRE above 1.9 for an existing source or above 5.0 for a new source.  |
| 2. Halogenated Group 1 continuous process vent stream | a. You use a combustion control device to control organic HAP emissions | i. Use a halogen reduction device after the combustion device to reduce emissions of hydrogen halide and halogen HAP by $\geq 99$ percent by weight, or to $\leq 0.45$ kg/hr, or to $\leq 20$ ppmv; or<br>ii. Use a halogen reduction device before the         |



|  |   |  |
|--|---|--|
|  |   | combustion device to reduce the halogen atom mass emission rate to $\leq 0.45$ kg/hr or to a concentration $\leq 20$ ppmv. |
| 3. Group 2 continuous process vent at an existing source | You use a recovery device to maintain the TRE level $>1.9$ but $\leq 5.0$ | Comply with the requirements in §63.993 and the requirements referenced therein.   |
| 4. Group 2 continuous process vent at a new source       | You use a recovery device to maintain the TRE level $>5.0$ but $\leq 8.0$ | Comply with the requirements in §63.993 and the requirements referenced therein.   |

**Table 2 to Subpart FFFF of Part 63—Emission Limits and Work Practice Standards for Batch Process Vents**

As required in §63.2460, you must meet each emission limit and work practice standard in the following table that applies to your batch process vents:

| <b>For each . . .</b>                       | <b>Then you must . . .</b>   | <b>And you must . . .</b>  |
|---|--|--|
| 1. Process with Group 1 batch process vents | a. Reduce collective uncontrolled organic HAP emissions from the sum of all batch process vents within the process by $\geq 98$ percent by weight by venting emissions from a sufficient number of the vents through one or more closed-vent systems to any combination of control devices (except a flare); or  | Not applicable.  |
|   | b. Reduce collective uncontrolled organic HAP emissions from the sum of all batch process vents within the process by $\geq 95$ percent by weight by venting emissions from a sufficient number of the vents through one or more closed-vent systems to any combination of recovery devices or a biofilter, except you may elect to comply with the requirements of subpart WW of this part for any process tank; or | Not applicable.  |
|   | c. Reduce uncontrolled organic HAP emissions from one or more batch process vents within the process by venting through a closed-vent system to a flare or by venting through one or more closed-vent systems to any combination of control devices  | For all other batch process vents within the process, reduce collective organic HAP emissions as specified in item 1.a and/or item 1.b of this |

|  |  |  |
|--|--|--|
|  | (excluding a flare) that reduce organic HAP to an outlet concentration $\leq 20$ ppmv as TOC or total organic HAP. | table.   |
| 2. Halogenated Group 1 batch process vent for which you use a combustion device to control organic HAP emissions | a. Use a halogen reduction device after the combustion control device; or  | i. Reduce overall emissions of hydrogen halide and halogen HAP by $\geq 99$ percent; or<br>ii. Reduce overall emissions of hydrogen halide and halogen HAP to $\leq 0.45$ kg/hr; or<br>iii. Reduce overall emissions of hydrogen halide and halogen HAP to a concentration $\leq 20$ ppmv. |
|  | b. Use a halogen reduction device before the combustion control device   | Reduce the halogen atom mass emission rate to $\leq 0.45$ kg/hr or to a concentration $\leq 20$ ppmv.  |

[68 FR 63888, Nov. 10, 2003, as amended at 71 FR 40339, July 14, 2006]

**Table 3 to Subpart FFFF of Part 63—Emission Limits for Hydrogen Halide and Halogen HAP Emissions or HAP Metals Emissions From Process Vents**

As required in §63.2465, you must meet each emission limit in the following table that applies to your process vents that contain hydrogen halide and halogen HAP emissions or PM HAP emissions:

| <b>For each . . .</b>  | <b>You must . . .</b>  |
|--|--|
| 1. Process with uncontrolled hydrogen halide and halogen HAP emissions from process vents $\geq 1,000$ lb/yr | a. Reduce collective hydrogen halide and halogen HAP emissions by $\geq 99$ percent by weight or to an outlet concentration $\leq 20$ ppmv by venting through one or more closed-vent systems to any combination of control devices, or  |
|  | b. Reduce the halogen atom mass emission rate from the sum of all batch process vents and each individual continuous process vent to $\leq 0.45$ kg/hr by venting through one or more closed-vent systems to a halogen reduction device. |
| 2. Process at a new source with uncontrolled emissions from process vents $\geq 150$ lb/yr of HAP metals     | Reduce overall emissions of HAP metals by $\geq 97$ percent by weight.   |

[68 FR 63888, Nov. 10, 2003, as amended at 71 FR 40340, July 14, 2006]

**Table 4 to Subpart FFFF of Part 63—Emission Limits for Storage Tanks**

As required in §63.2470, you must meet each emission limit in the following table that applies to your storage tanks:

| For each . . .   | For which . . .   | Then you must . . .  |
|--|---|--|
| 1. Group 1 storage tank                                | a. The maximum true vapor pressure of total HAP at the storage temperature is $\geq 76.6$ kilopascals | i. Reduce total HAP emissions by $\geq 95$ percent by weight or to $\leq 20$ ppmv of TOC or organic HAP and $\leq 20$ ppmv of hydrogen halide and halogen HAP by venting emissions through a closed vent system to any combination of control devices (excluding a flare); or  |
|  |   | ii. Reduce total organic HAP emissions by venting emissions through a closed vent system to a flare; or  |
|  |   | iii. Reduce total HAP emissions by venting emissions to a fuel gas system or process in accordance with §63.982(d) and the requirements referenced therein.  |
|  | b. The maximum true vapor pressure of total HAP at the storage temperature is $< 76.6$ kilopascals    | i. Comply with the requirements of subpart WW of this part, except as specified in §63.2470; or  |
|  |   | ii. Reduce total HAP emissions by $\geq 95$ percent by weight or to $\leq 20$ ppmv of TOC or organic HAP and $\leq 20$ ppmv of hydrogen halide and halogen HAP by venting emissions through a closed vent system to any combination of control devices (excluding a flare); or |
|  |   | iii. Reduce total organic HAP emissions by venting emissions through a closed vent system to a flare; or   |
|  |   | iv. Reduce total HAP emissions by venting emissions to a fuel gas system or process in accordance with §63.982(d) and the requirements referenced therein.   |
| 2. Halogenated vent stream from a Group 1 storage tank | You use a combustion control device to control organic HAP emissions                                  | Meet one of the emission limit options specified in Item 2.a.i or ii. in Table 1 to this subpart.  |

**Table 5 to Subpart FFFF of Part 63—Emission Limits and Work Practice Standards for Transfer Racks**

As required in §63.2475, you must meet each emission limit and work practice standard in the following table that applies to your transfer racks:

| For each . . .  | You must . . .   |
|---|--|
| 1. Group 1 transfer rack  | a. Reduce emissions of total organic HAP by $\geq 98$ percent by weight or to an outlet concentration $\leq 20$ ppmv as organic HAP or TOC by venting emissions through a closed-vent system to any combination of control devices (except a flare); or  |
|   | b. Reduce emissions of total organic HAP by venting emissions through a closed-vent system to a flare; or  |
|   | c. Reduce emissions of total organic HAP by venting emissions to a fuel gas system or process in accordance with §63.982(d) and the requirements referenced therein; or  |
|   | d. Use a vapor balancing system designed and operated to collect organic HAP vapors displaced from tank trucks and railcars during loading and route the collected HAP vapors to the storage tank from which the liquid being loaded originated or to another storage tank connected by a common header.   |
| 2. Halogenated Group 1 transfer rack vent stream for which you use a combustion device to control organic HAP emissions | a. Use a halogen reduction device after the combustion device to reduce emissions of hydrogen halide and halogen HAP by $\geq 99$ percent by weight, to $\leq 0.45$ kg/hr, or to $\leq 20$ ppmv; or<br>b. Use a halogen reduction device before the combustion device to reduce the halogen atom mass emission rate to $\leq 0.45$ kg/hr or to a concentration $\leq 20$ ppmv. |

[68 FR 63888, Nov. 10, 2003, as amended at 71 FR 40341, July 14, 2006]

**Table 6 to Subpart FFFF of Part 63—Requirements for Equipment Leaks**

As required in §63.2480, you must meet each requirement in the following table that applies to your equipment leaks:

| For all . . .                               | And that is part of . . .   | You must . . . |
|---|---|----------------|
| 1. Equipment that is in organic HAP service | a. Comply with the requirements of subpart UU of this part 63 and the requirements referenced therein, except as specified in §63.2480(b) and (d); or |                |
|   | b. Comply with the requirements of subpart H of this part 63 and the requirements referenced therein, except as                                       |                |

|   |   |   |
|---|---|---|
|   | specified in §63.2480(b) and (d); or  |   |
|   | c. Comply with the requirements of 40 CFR part 65, subpart F and the requirements referenced therein, except as specified in §63.2480(c) and (d). |   |
| 2. Equipment that is in organic HAP service at a new source | a. Any MCPU   | i. Comply with the requirements of subpart UU of this part 63 and the requirements referenced therein; or<br>ii. Comply with the requirements of 40 CFR part 65, subpart F. |

[68 FR 63888, Nov. 10, 2003, as amended at 71 FR 40341, July 14, 2006]

**Table 7 to Subpart FFFF of Part 63—Requirements for Wastewater Streams and Liquid Streams in Open Systems Within an MCPU**

As required in §63.2485, you must meet each requirement in the following table that applies to your wastewater streams and liquid streams in open systems within an MCPU:

| <b>For each . . .</b>                              | <b>You must . . .</b>   |
|--|---|
| 1. Process wastewater stream                       | Comply with the requirements in §§63.132 through 63.148 and the requirements referenced therein, except as specified in §63.2485. |
| 2. Maintenance wastewater stream                   | Comply with the requirements in §63.105 and the requirements referenced therein, except as specified in §63.2485.                 |
| 3. Liquid streams in an open system within an MCPU | Comply with the requirements in §63.149 and the requirements referenced therein, except as specified in §63.2485.                 |

**Table 8 to Subpart FFFF of Part 63—Partially Soluble Hazardous Air Pollutants**

As specified in §63.2485, the partially soluble HAP in wastewater that are subject to management and treatment requirements in this subpart FFFF are listed in the following table:

| <b>Chemical name . . .</b>                    | <b>CAS No.</b> |
|---|----------------|
| 1. 1,1,1-Trichloroethane (methyl chloroform)  | 71556          |
| 2. 1,1,2,2-Tetrachloroethane                  | 79345          |
| 3. 1,1,2-Trichloroethane                      | 79005          |
| 4. 1,1-Dichloroethylene (vinylidene chloride) | 75354          |
| 5. 1,2-Dibromoethane                          | 106934         |

|   |        |
|---|--------|
| 6. 1,2-Dichloroethane (ethylene dichloride) | 107062 |
| 7. 1,2-Dichloropropane                      | 78875  |
| 8. 1,3-Dichloropropene                      | 542756 |
| 9. 2,4,5-Trichlorophenol                    | 95954  |
| 10. 1,4-Dichlorobenzene                     | 106467 |
| 11. 2-Nitropropane                          | 79469  |
| 12. 4-Methyl-2-pentanone (MIBK)             | 108101 |
| 13. Acetaldehyde                            | 75070  |
| 14. Acrolein                                | 107028 |
| 15. Acrylonitrile                           | 107131 |
| 16. Allyl chloride                          | 107051 |
| 17. Benzene                                 | 71432  |
| 18. Benzyl chloride                         | 100447 |
| 19. Biphenyl                                | 92524  |
| 20. Bromoform (tribromomethane)             | 75252  |
| 21. Bromomethane                            | 74839  |
| 22. Butadiene                               | 106990 |
| 23. Carbon disulfide                        | 75150  |
| 24. Chlorobenzene                           | 108907 |
| 25. Chloroethane (ethyl chloride)           | 75003  |
| 26. Chloroform                              | 67663  |
| 27. Chloromethane                           | 74873  |
| 28. Chloroprene                             | 126998 |
| 29. Cumene                                  | 98828  |
| 30. Dichloroethyl ether                     | 111444 |
| 31. Dinitrophenol                           | 51285  |
| 32. Epichlorohydrin                         | 106898 |
| 33. Ethyl acrylate                          | 140885 |
| 34. Ethylbenzene                            | 100414 |
| 35. Ethylene oxide                          | 75218  |

|   |         |
|---|---------|
| 36. Ethylidene dichloride                     | 75343   |
| 37. Hexachlorobenzene                         | 118741  |
| 38. Hexachlorobutadiene                       | 87683   |
| 39. Hexachloroethane                          | 67721   |
| 40. Methyl methacrylate                       | 80626   |
| 41. Methyl-t-butyl ether                      | 1634044 |
| 42. Methylene chloride                        | 75092   |
| 43. N-hexane                                  | 110543  |
| 44. N,N-dimethylaniline                       | 121697  |
| 45. Naphthalene                               | 91203   |
| 46. Phosgene                                  | 75445   |
| 47. Propionaldehyde                           | 123386  |
| 48. Propylene oxide                           | 75569   |
| 49. Styrene                                   | 100425  |
| 50. Tetrachloroethylene (perchloroethylene)   | 127184  |
| 51. Tetrachloromethane (carbon tetrachloride) | 56235   |
| 52. Toluene                                   | 108883  |
| 53. Trichlorobenzene (1,2,4-)                 | 120821  |
| 54. Trichloroethylene                         | 79016   |
| 55. Trimethylpentane                          | 540841  |
| 56. Vinyl acetate                             | 108054  |
| 57. Vinyl chloride                            | 75014   |
| 58. Xylene (m)                                | 108383  |
| 59. Xylene (o)                                | 95476   |
| 60. Xylene (p)                                | 106423  |

[68 FR 63888, Nov. 10, 2003, as amended at 70 FR 38560, July 1, 2005; 71 FR 40341, July 14, 2006]

**Table 9 to Subpart FFFF of Part 63—Soluble Hazardous Air Pollutants**

As specified in §63.2485, the soluble HAP in wastewater that are subject to management and treatment requirements of this subpart FFFF are listed in the following table:

| Chemical name . . .                          | CAS No. |
|--|---------|
| 1. Acetonitrile                              | 75058   |
| 2. Acetophenone                              | 98862   |
| 3. Diethyl sulfate                           | 64675   |
| 4. Dimethyl hydrazine (1,1)                  | 57147   |
| 5. Dimethyl sulfate                          | 77781   |
| 6. Dinitrotoluene (2,4)                      | 121142  |
| 7. Dioxane (1,4)                             | 123911  |
| 8. Ethylene glycol dimethyl ether            | 110714  |
| 9. Ethylene glycol monobutyl ether acetate   | 112072  |
| 10. Ethylene glycol monomethyl ether acetate | 110496  |
| 11. Isophorone                               | 78591   |
| 12. Methanol                                 | 67561   |
| 13. Nitrobenzene                             | 98953   |
| 14. Toluidine (o-)                           | 95534   |
| 15. Triethylamine                            | 121448  |

[68 FR 63888, Nov. 10, 2003, as amended at 70 FR 38561, July 1, 2005]

**Table 10 to Subpart FFFF of Part 63—Work Practice Standards for Heat Exchange Systems**

As required in §63.2490, you must meet each requirement in the following table that applies to your heat exchange systems:

| For each . . .                              | You must . . .  |
|---|---|
| Heat exchange system, as defined in §63.101 | Comply with the requirements of §63.104 and the requirements referenced therein, except as specified in §63.2490. |

**Table 11 to Subpart FFFF of Part 63—Requirements for Reports**

As required in §63.2520(a) and (b), you must submit each report that applies to you on the schedule shown in the following table:

| You must submit a(n)    | The report must contain . . . | You must submit the report . . .  |
|-------------------------|-------------------------------|---|
| 1. Precompliance report | The information specified in  | At least 6 months prior to the compliance date; or for new sources, with the application for approval |



|   |  |   |
|---|--|---|
|   | §63.2520(c)                              | of construction or reconstruction.                                      |
| 2. Notification of compliance status report | The information specified in §63.2520(d) | No later than 150 days after the compliance date specified in §63.2445. |
| 3. Compliance report                        | The information specified in §63.2520(e) | Semiannually according to the requirements in §63.2520(b).              |

**Table 12 to Subpart FFFF of Part 63—Applicability of General Provisions to Subpart FFFF**

As specified in §63.2540, the parts of the General Provisions that apply to you are shown in the following table:

| <b>Citation</b>                       | <b>Subject</b>  | <b>Explanation</b>   |
|---------------------------------------|---|--|
| §63.1                                 | Applicability   | Yes.   |
| §63.2                                 | Definitions   | Yes.   |
| §63.3                                 | Units and Abbreviations   | Yes.   |
| §63.4                                 | Prohibited Activities   | Yes.   |
| §63.5                                 | Construction/Reconstruction   | Yes.   |
| §63.6(a)                              | Applicability   | Yes.   |
| §63.6(b)(1)-(4)                       | Compliance Dates for New and Reconstructed sources                        | Yes.   |
| §63.6(b)(5)                           | Notification  | Yes.   |
| §63.6(b)(6)                           | [Reserved]  |  |
| §63.6(b)(7)                           | Compliance Dates for New and Reconstructed Area Sources That Become Major | Yes.   |
| §63.6(c)(1)-(2)                       | Compliance Dates for Existing Sources                                     | Yes.   |
| §63.6(c)(3)-(4)                       | [Reserved]  |  |
| §63.6(c)(5)                           | Compliance Dates for Existing Area Sources That Become Major              | Yes  |
| §63.6(d)                              | [Reserved]  |  |
| §63.6(e)(1)-(2)                       | Operation & Maintenance   | Yes.   |
| §63.6(e)(3)(i), (ii), and (v) through | Startup, Shutdown, Malfunction Plan (SSMP)                                | Yes, except information regarding Group 2 emission points and equipment leaks is |

|                           |   |  |
|---------------------------|---|--|
| (viii)                    |   | not required in the SSMP, as specified in §63.2525(j).   |
| §63.6(e)(3)(iii) and (iv) | Recordkeeping and Reporting During SSM      | No, §63.998(d)(3) and 63.998(c)(1)(ii)(D) through (G) specify the recordkeeping requirement for SSM events, and §63.2520(e)(4) specifies reporting requirements. |
| §63.6(e)(3)(ix)           | SSMP incorporation into title V permit      | Yes.   |
| §63.6(f)(1)               | Compliance Except During SSM                | Yes.   |
| §63.6(f)(2)-(3)           | Methods for Determining Compliance          | Yes.   |
| §63.6(g)(1)-(3)           | Alternative Standard                        | Yes.   |
| §63.6(h)                  | Opacity/Visible Emission (VE) Standards     | Only for flares for which Method 22 observations are required as part of a flare compliance assessment.  |
| §63.6(i)(1)-(14)          | Compliance Extension                        | Yes.   |
| §63.6(j)                  | Presidential Compliance Exemption           | Yes.   |
| §63.7(a)(1)-(2)           | Performance Test Dates                      | Yes, except substitute 150 days for 180 days.  |
| §63.7(a)(3)               | Section 114 Authority                       | Yes, and this paragraph also applies to flare compliance assessments as specified under §63.997(b)(2).   |
| §63.7(b)(1)               | Notification of Performance Test            | Yes.   |
| §63.7(b)(2)               | Notification of Rescheduling                | Yes.   |
| §63.7(c)                  | Quality Assurance/Test Plan                 | Yes, except the test plan must be submitted with the notification of the performance test if the control device controls batch process vents.                    |
| §63.7(d)                  | Testing Facilities                          | Yes.   |
| §63.7(e)(1)               | Conditions for Conducting Performance Tests | Yes, except that performance tests for batch process vents must be conducted under worst-case conditions as specified in §63.2460.                               |
| §63.7(e)(2)               | Conditions for Conducting Performance Tests | Yes.   |

|                  |  |   |
|------------------|--|---|
| §63.7(e)(3)      | Test Run Duration                                      | Yes.  |
| §63.7(f)         | Alternative Test Method                                | Yes.  |
| §63.7(g)         | Performance Test Data Analysis                         | Yes.  |
| §63.7(h)         | Waiver of Tests  | Yes.  |
| §63.8(a)(1)      | Applicability of Monitoring Requirements               | Yes.  |
| §63.8(a)(2)      | Performance Specifications                             | Yes.  |
| §63.8(a)(3)      | [Reserved]   |   |
| §63.8(a)(4)      | Monitoring with Flares                                 | Yes.  |
| §63.8(b)(1)      | Monitoring   | Yes.  |
| §63.8(b)(2)-(3)  | Multiple Effluents and Multiple Monitoring Systems     | Yes.  |
| §63.8(c)(1)      | Monitoring System Operation and Maintenance            | Yes.  |
| §63.8(c)(1)(i)   | Routine and Predictable SSM                            | Yes.  |
| §63.8(c)(1)(ii)  | SSM not in SSMP  | Yes.  |
| §63.8(c)(1)(iii) | Compliance with Operation and Maintenance Requirements | Yes.  |
| §63.8(c)(2)-(3)  | Monitoring System Installation                         | Yes.  |
| §63.8(c)(4)      | CMS Requirements                                       | Only for CEMS. Requirements for CPMS are specified in referenced subparts G and SS of part 63. Requirements for COMS do not apply because subpart FFFF does not require continuous opacity monitoring systems (COMS). |
| §63.8(c)(4)(i)   | COMS Measurement and Recording Frequency               | No; subpart FFFF does not require COMS.   |
| §63.8(c)(4)(ii)  | CEMS Measurement and Recording Frequency               | Yes.  |
| §63.8(c)(5)      | COMS Minimum Procedures                                | No. Subpart FFFF does not contain opacity or VE limits.   |
| §63.8(c)(6)      | CMS Requirements                                       | Only for CEMS; requirements for CPMS are specified in referenced subparts G and SS of this part 63. Requirements for COMS do not apply because subpart FFFF does not require COMS.                                    |

|                 |  |  |
|-----------------|--|--|
| §63.8(c)(7)-(8) | CMS Requirements   | Only for CEMS. Requirements for CPMS are specified in referenced subparts G and SS of part 63. Requirements for COMS do not apply because subpart FFFF does not require COMS.  |
| §63.8(d)        | CMS Quality Control  | Only for CEMS.   |
| §63.8(e)        | CMS Performance Evaluation                                     | Only for CEMS. Section 63.8(e)(5)(ii) does not apply because subpart FFFF does not require COMS.   |
| §63.8(f)(1)-(5) | Alternative Monitoring Method                                  | Yes, except you may also request approval using the precompliance report.  |
| §63.8(f)(6)     | Alternative to Relative Accuracy Test                          | Only applicable when using CEMS to demonstrate compliance, including the alternative standard in §63.2505.   |
| §63.8(g)(1)-(4) | Data Reduction   | Only when using CEMS, including for the alternative standard in §63.2505, except that the requirements for COMS do not apply because subpart FFFF has no opacity or VE limits, and §63.8(g)(2) does not apply because data reduction requirements for CEMS are specified in §63.2450(j). |
| §63.8(g)(5)     | Data Reduction   | No. Requirements for CEMS are specified in §63.2450(j). Requirements for CPMS are specified in referenced subparts G and SS of this part 63.   |
| §63.9(a)        | Notification Requirements                                      | Yes.   |
| §63.9(b)(1)-(5) | Initial Notifications  | Yes.   |
| §63.9(c)        | Request for Compliance Extension                               | Yes.   |
| §63.9(d)        | Notification of Special Compliance Requirements for New Source | Yes.   |
| §63.9(e)        | Notification of Performance Test                               | Yes.   |
| §63.9(f)        | Notification of VE/Opacity Test                                | No. Subpart FFFF does not contain opacity or VE limits.  |
| §63.9(g)        | Additional Notifications When Using CMS                        | Only for CEMS. Section 63.9(g)(2) does not apply because subpart FFFF does not require COMS.   |

|                                 |   |   |
|---------------------------------|---|---|
| 63.9(h)(1)-(6)                  | Notification of Compliance Status                                 | Yes, except subpart FFFF has no opacity or VE limits, and 63.9(h)(2)(i)(A) through (G) and (ii) do not apply because 63.2520(d) specifies the required contents and due date of the notification of compliance status report. |
| §63.9(i)                        | Adjustment of Submittal Deadlines                                 | Yes.  |
| §63.9(j)                        | Change in Previous Information                                    | No, §63.2520(e) specifies reporting requirements for process changes.   |
| §63.10(a)                       | Recordkeeping/Reporting   | Yes.  |
| §63.10(b)(1)                    | Recordkeeping/Reporting   | Yes.  |
| §63.10(b)(2)(i)-(ii), (iv), (v) | Records related to SSM  | No, §§63.998(d)(3) and 63.998(c)(1)(ii)(D) through (G) specify recordkeeping requirements for periods of SSM.   |
| §63.10(b)(2)(iii)               | Records related to maintenance of air pollution control equipment | Yes.  |
| §63.10(b)(2)(vi), (x), and (xi) | CMS Records   | Only for CEMS; requirements for CPMS are specified in referenced subparts G and SS of this part 63.   |
| §63.10(b)(2)(vii)-(ix)          | Records   | Yes.  |
| §63.10(b)(2)(xii)               | Records   | Yes.  |
| §63.10(b)(2)(xiii)              | Records   | Only for CEMS.  |
| §63.10(b)(2)(xiv)               | Records   | Yes.  |
| §63.10(b)(3)                    | Records   | Yes.  |
| §63.10(c)(1)-(6),(9)-(15)       | Records   | Only for CEMS. Recordkeeping requirements for CPMS are specified in referenced subparts G and SS of this part 63.   |
| §63.10(c)(7)-(8)                | Records   | No. Recordkeeping requirements are specified in §63.2525.   |
| §63.10(d)(1)                    | General Reporting Requirements                                    | Yes.  |
| §63.10(d)(2)                    | Report of Performance Test Results                                | Yes.  |
| §63.10(d)(3)                    | Reporting Opacity or VE   | No. Subpart FFFF does not contain   |

|                         |   |  |
|-------------------------|---|--|
|                         | Observations  | opacity or VE limits.  |
| §63.10(d)(4)            | Progress Reports  | Yes.   |
| §63.10(d)(5)(i)         | Periodic Startup, Shutdown, and Malfunction Reports                                       | No, §63.2520(e)(4) and (5) specify the SSM reporting requirements. |
| §63.10(d)(5)(ii)        | Immediate SSM Reports   | No.  |
| §63.10(e)(1)            | Additional CEMS Reports   | Yes.   |
| §63.10(e)(2)(i)         | Additional CMS Reports  | Only for CEMS.   |
| §63.10(e)(2)(ii)        | Additional COMS Reports   | No. Subpart FFFF does not require COMS.                            |
| §63.10(e)(3)            | Reports   | No. Reporting requirements are specified in §63.2520.              |
| §63.10(e)(3)(i)-(iii)   | Reports   | No. Reporting requirements are specified in §63.2520.              |
| §63.10(e)(3)(iv)-(v)    | Excess Emissions Reports  | No. Reporting requirements are specified in §63.2520.              |
| §63.10(e)(3)(iv)-(v)    | Excess Emissions Reports  | No. Reporting requirements are specified in §63.2520.              |
| §63.10(e)(3)(vi)-(viii) | Excess Emissions Report and Summary Report  | No. Reporting requirements are specified in §63.2520.              |
| §63.10(e)(4)            | Reporting COMS data   | No. Subpart FFFF does not contain opacity or VE limits.            |
| §63.10(f)               | Waiver for Recordkeeping/Reporting  | Yes.   |
| §63.11                  | Control device requirements for flares and work practice requirements for equipment leaks | Yes.   |
| §63.12                  | Delegation  | Yes.   |
| §63.13                  | Addresses   | Yes.   |
| §63.14                  | Incorporation by Reference  | Yes.   |
| §63.15                  | Availability of Information   | Yes.   |

[68 FR 63888, Nov. 10, 2003, as amended at 70 FR 38561, July 1, 2005; 71 FR 20463, Apr. 20, 2006; 71 FR 40341, July 14, 2006; 73 FR 72816, Dec. 22, 2008]

**Appendix L**

40 C.F.R. Part 61, Subpart FF – *National Emission Standards for Benzene Waste Operations*

## Subpart FF—National Emission Standard for Benzene Waste Operations

SOURCE: 55 FR 8346, Mar. 7, 1990, unless otherwise noted.

### §61.340 Applicability.

(a) The provisions of this subpart apply to owners and operators of chemical manufacturing plants, coke by-product recovery plants, and petroleum refineries.

(b) The provisions of this subpart apply to owners and operators of hazardous waste treatment, storage, and disposal facilities that treat, store, or dispose of hazardous waste generated by any facility listed in paragraph (a) of this section. The waste streams at hazardous waste treatment, storage, and disposal facilities subject to the provisions of this subpart are the benzene-containing hazardous waste from any facility listed in paragraph (a) of this section. A hazardous waste treatment, storage, and disposal facility is a facility that must obtain a hazardous waste management permit under subtitle C of the Solid Waste Disposal Act.

(c) At each facility identified in paragraph (a) or (b) of this section, the following waste is exempt from the requirements of this subpart:

- (1) Waste in the form of gases or vapors that is emitted from process fluids:
- (2) Waste that is contained in a segregated stormwater sewer system.

(d) At each facility identified in paragraph (a) or (b) of this section, any gaseous stream from a waste management unit, treatment process, or wastewater treatment system routed to a fuel gas system, as defined in §61.341, is exempt from this subpart. No testing, monitoring, recordkeeping, or reporting is required under this subpart for any gaseous stream from a waste management unit, treatment process, or wastewater treatment unit routed to a fuel gas system.

[55 FR 8346, Mar. 7, 1990, as amended at 55 FR 37231, Sept. 10, 1990; 58 FR 3095, Jan. 7, 1993; 67 FR 68531, Nov. 12, 2002]

### §61.341 Definitions.

*Benzene concentration* means the fraction by weight of benzene in a waste as determined in accordance with the procedures specified in §61.355 of this subpart.

*Car-seal* means a seal that is placed on a device that is used to change the position of a valve (e.g., from opened to closed) in such a way that the position of the valve cannot be changed without breaking the seal.

*Chemical manufacturing plant* means any facility engaged in the production of chemicals by chemical, thermal, physical, or biological processes for use as a product, co-product, by-product, or intermediate including but not limited to industrial organic chemicals, organic pesticide products, pharmaceutical preparations, paint and allied products, fertilizers, and agricultural chemicals. Examples of chemical manufacturing plants include facilities at which process units are operated to produce one or more of the following chemicals: benzenesulfonic acid, benzene, chlorobenzene, cumene, cyclohexane, ethylene, ethylbenzene, hydroquinone, linear alkylbenzene, nitrobenzene, resorcinol, sulfolane, or styrene.



*Closed-vent system* means a system that is not open to the atmosphere and is composed of piping, ductwork, connections, and, if necessary, flow inducing devices that transport gas or vapor from an emission source to a control device.

*Coke by-product recovery plant* means any facility designed and operated for the separation and recovery of coal tar derivatives (by-products) evolved from coal during the coking process of a coke oven battery.

*Container* means any portable waste management unit in which a material is stored, transported, treated, or otherwise handled. Examples of containers are drums, barrels, tank trucks, barges, dumpsters, tank cars, dump trucks, and ships.

*Control device* means an enclosed combustion device, vapor recovery system, or flare.

*Cover* means a device or system which is placed on or over a waste placed in a waste management unit so that the entire waste surface area is enclosed and sealed to minimize air emissions. A cover may have openings necessary for operation, inspection, and maintenance of the waste management unit such as access hatches, sampling ports, and gauge wells provided that each opening is closed and sealed when not in use. Example of covers include a fixed roof installed on a tank, a lid installed on a container, and an air-supported enclosure installed over a waste management unit.

*External floating roof* means a pontoon-type or double-deck type cover with certain rim sealing mechanisms that rests on the liquid surface in a waste management unit with no fixed roof.

*Facility* means all process units and product tanks that generate waste within a stationary source, and all waste management units that are used for waste treatment, storage, or disposal within a stationary source.

*Fixed roof* means a cover that is mounted on a waste management unit in a stationary manner and that does not move with fluctuations in liquid level.

*Floating roof* means a cover with certain rim sealing mechanisms consisting of a double deck, pontoon single deck, internal floating cover or covered floating roof, which rests upon and is supported by the liquid being contained, and is equipped with a closure seal or seals to close the space between the roof edge and unit wall.

*Flow indicator* means a device which indicates whether gas flow is present in a line or vent system.

*Fuel gas system* means the offsite and onsite piping and control system that gathers gaseous streams generated by facility operations, may blend them with sources of gas, if available, and transports the blended gaseous fuel at suitable pressures for use as fuel in heaters, furnaces, boilers, incinerators, gas turbines, and other combustion devices located within or outside the facility. The fuel is piped directly to each individual combustion device, and the system typically operates at pressures over atmospheric.

*Individual drain system* means the system used to convey waste from a process unit, product storage tank, or waste management unit to a waste management unit. The term includes all process drains and common junction boxes, together with their associated sewer lines and other junction boxes, down to the receiving waste management unit.

*Internal floating roof* means a cover that rests or floats on the liquid surface inside a waste management unit that has a fixed roof.

*Liquid-mounted seal* means a foam or liquid-filled primary seal mounted in contact with the liquid between the waste management unit wall and the floating roof continuously around the circumference.

*Loading* means the introduction of waste into a waste management unit but not necessarily to complete capacity (also referred to as filling).

*Maximum organic vapor pressure* means the equilibrium partial pressure exerted by the waste at the temperature equal to the highest calendar-month average of the waste storage temperature for waste stored above or below the ambient temperature or at the local maximum monthly average temperature as reported by the National Weather Service for waste stored at the ambient temperature, as determined:

- (1) In accordance with §60.17(c); or
- (2) As obtained from standard reference texts; or
- (3) In accordance with §60.17(a)(37); or
- (4) Any other method approved by the Administrator.

*No detectable emissions* means less than 500 parts per million by volume (ppmv) above background levels, as measured by a detection instrument reading in accordance with the procedures specified in §61.355(h) of this subpart.

*Oil-water separator* means a waste management unit, generally a tank or surface impoundment, used to separate oil from water. An oil-water separator consists of not only the separation unit but also the forebay and other separator basins, skimmers, weirs, grit chambers, sludge hoppers, and bar screens that are located directly after the individual drain system and prior to additional treatment units such as an air flotation unit, clarifier, or biological treatment unit. Examples of an oil-water separator include an API separator, parallel-plate interceptor, and corrugated-plate interceptor with the associated ancillary equipment.

*Petroleum refinery* means any facility engaged in producing gasoline, kerosene, distillate fuel oils, residual fuel oils, lubricants, or other products through the distillation of petroleum, or through the redistillation, cracking, or reforming of unfinished petroleum derivatives.

*Petroleum* means the crude oil removed from the earth and the oils derived from tar sands, shale, and coal.

*Point of waste generation* means the location where the waste stream exits the process unit component or storage tank prior to handling or treatment in an operation that is not an integral part of the production process, or in the case of waste management units that generate new wastes after treatment, the location where the waste stream exits the waste management unit component.

*Process unit* means equipment assembled and connected by pipes or ducts to produce intermediate or final products. A process unit can be operated independently if supplied with sufficient fuel or raw materials and sufficient product storage facilities.

*Process unit turnaround* means the shutting down of the operations of a process unit, the purging of the contents of the process unit, the maintenance or repair work, followed by restarting of the process.

*Process unit turnaround waste* means a waste that is generated as a result of a process unit turnaround.

*Process wastewater* means water which comes in contact with benzene during manufacturing or processing operations conducted within a process unit. Process wastewater is not organic wastes, process fluids, product tank drawdown, cooling tower blowdown, steam trap condensate, or landfill leachate.

*Process wastewater stream* means a waste stream that contains only process wastewater.

*Product tank* means a stationary unit that is designed to contain an accumulation of materials that are fed to or produced by a process unit, and is constructed primarily of non-earthen materials (e.g., wood, concrete, steel, plastic) which provide structural support.

*Product tank drawdown* means any material or mixture of materials discharged from a product tank for the purpose of removing water or other contaminants from the product tank.

*Safety device* means a closure device such as a pressure relief valve, frangible disc, fusible plug, or any other type of device which functions exclusively to prevent physical damage or permanent deformation to a unit or its air emission control equipment by venting gases or vapors directly to the atmosphere during unsafe conditions resulting from an unplanned, accidental, or emergency event. For the purpose of this subpart, a safety device is not used for routine venting of gases or vapors from the vapor headspace underneath a cover such as during filling of the unit or to adjust the pressure in this vapor headspace in response to normal daily diurnal ambient temperature fluctuations. A safety device is designed to remain in a closed position during normal operations and open only when the internal pressure, or another relevant parameter, exceeds the device threshold setting applicable to the air emission control equipment as determined by the owner or operator based on manufacturer recommendations, applicable regulations, fire protection and prevention codes, standard engineering codes and practices, or other requirements for the safe handling of flammable, ignitable, explosive, reactive, or hazardous materials.

*Segregated stormwater sewer system* means a drain and collection system designed and operated for the sole purpose of collecting rainfall runoff at a facility, and which is segregated from all other individual drain systems.

*Sewer line* means a lateral, trunk line, branch line, or other enclosed conduit used to convey waste to a downstream waste management unit.

*Slop oil* means the floating oil and solids that accumulate on the surface of an oil-water separator.

*Sour water stream* means a stream that:

- (1) Contains ammonia or sulfur compounds (usually hydrogen sulfide) at concentrations of 10 ppm by weight or more;
- (2) Is generated from separation of water from a feed stock, intermediate, or product that contained ammonia or sulfur compounds; and
- (3) Requires treatment to remove the ammonia or sulfur compounds.

*Sour water stripper* means a unit that:

- (1) Is designed and operated to remove ammonia or sulfur compounds (usually hydrogen sulfide) from sour water streams;

(2) Has the sour water streams transferred to the stripper through hard piping or other enclosed system; and

(3) Is operated in such a manner that the offgases are sent to a sulfur recovery unit, processing unit, incinerator, flare, or other combustion device.

*Surface impoundment* means a waste management unit which is a natural topographic depression, man-made excavation, or diked area formed primarily of earthen materials (although it may be lined with man-made materials), which is designed to hold an accumulation of liquid wastes or waste containing free liquids, and which is not an injection well. Examples of surface impoundments are holding, storage, settling, and aeration pits, ponds, and lagoons.

*Tank* means a stationary waste management unit that is designed to contain an accumulation of waste and is constructed primarily of nonearthen materials (e.g., wood, concrete, steel, plastic) which provide structural support.

*Treatment process* means a stream stripping unit, thin-film evaporation unit, waste incinerator, or any other process used to comply with §61.348 of this subpart.

*Vapor-mounted seal* means a foam-filled primary seal mounted continuously around the perimeter of a waste management unit so there is an annular vapor space underneath the seal. The annular vapor space is bounded by the bottom of the primary seal, the unit wall, the liquid surface, and the floating roof.

*Waste* means any material resulting from industrial, commercial, mining or agricultural operations, or from community activities that is discarded or is being accumulated, stored, or physically, chemically, thermally, or biologically treated prior to being discarded, recycled, or discharged.

*Waste management unit* means a piece of equipment, structure, or transport mechanism used in handling, storage, treatment, or disposal of waste. Examples of a waste management unit include a tank, surface impoundment, container, oil-water separator, individual drain system, steam stripping unit, thin-film evaporation unit, waste incinerator, and landfill.

*Waste stream* means the waste generated by a particular process unit, product tank, or waste management unit. The characteristics of the waste stream (e.g., flow rate, benzene concentration, water content) are determined at the point of waste generation. Examples of a waste stream include process wastewater, product tank drawdown, sludge and slop oil removed from waste management units, and landfill leachate.

*Wastewater treatment system* means any component, piece of equipment, or installation that receives, manages, or treats process wastewater, product tank drawdown, or landfill leachate prior to direct or indirect discharge in accordance with the National Pollutant Discharge Elimination System permit regulations under 40 CFR part 122. These systems typically include individual drain systems, oil-water separators, air flotation units, equalization tanks, and biological treatment units.

*Water seal controls* means a seal pot, p-leg trap, or other type of trap filled with water (e.g., flooded sewers that maintain water levels adequate to prevent air flow through the system) that creates a water barrier between the sewer line and the atmosphere. The water level of the seal must be maintained in the vertical leg of a drain in order to be considered a water seal.

[55 FR 8346, Mar. 7, 1990; 55 FR 12444, Apr. 3, 1990, as amended at 58 FR 3095, Jan. 7, 1993; 67 FR 68531, Nov. 12, 2002]

**§61.342 Standards: General.**

(a) An owner or operator of a facility at which the total annual benzene quantity from facility waste is less than 10 megagrams per year (Mg/yr) (11 ton/yr) shall be exempt from the requirements of paragraphs (b) and (c) of this section. The total annual benzene quantity from facility waste is the sum of the annual benzene quantity for each waste stream at the facility that has a flow-weighted annual average water content greater than 10 percent or that is mixed with water, or other wastes, at any time and the mixture has an annual average water content greater than 10 percent. The benzene quantity in a waste stream is to be counted only once without multiple counting if other waste streams are mixed with or generated from the original waste stream. Other specific requirements for calculating the total annual benzene waste quantity are as follows:

(1) Wastes that are exempted from control under §§61.342(c)(2) and 61.342(c)(3) are included in the calculation of the total annual benzene quantity if they have an annual average water content greater than 10 percent, or if they are mixed with water or other wastes at any time and the mixture has an annual average water content greater than 10 percent.

(2) The benzene in a material subject to this subpart that is sold is included in the calculation of the total annual benzene quantity if the material has an annual average water content greater than 10 percent.

(3) Benzene in wastes generated by remediation activities conducted at the facility, such as the excavation of contaminated soil, pumping and treatment of groundwater, and the recovery of product from soil or groundwater, are not included in the calculation of total annual benzene quantity for that facility. If the facility's total annual benzene quantity is 10 Mg/yr (11 ton/yr) or more, wastes generated by remediation activities are subject to the requirements of paragraphs (c) through (h) of this section. If the facility is managing remediation waste generated offsite, the benzene in this waste shall be included in the calculation of total annual benzene quantity in facility waste, if the waste streams have an annual average water content greater than 10 percent, or if they are mixed with water or other wastes at any time and the mixture has an annual average water content greater than 10 percent.

(4) The total annual benzene quantity is determined based upon the quantity of benzene in the waste before any waste treatment occurs to remove the benzene except as specified in §61.355(c)(1)(i) (A) through (C).

(b) Each owner or operator of a facility at which the total annual benzene quantity from facility waste is equal to or greater than 10 Mg/yr (11 ton/yr) as determined in paragraph (a) of this section shall be in compliance with the requirements of paragraphs (c) through (h) of this section no later than 90 days following the effective date, unless a waiver of compliance has been obtained under §61.11, or by the initial startup for a new source with an initial startup after the effective date.

(1) The owner or operator of an existing source unable to comply with the rule within the required time may request a waiver of compliance under §61.10.

(2) As part of the waiver application, the owner or operator shall submit to the Administrator a plan under §61.10(b)(3) that is an enforceable commitment to obtain environmental benefits to mitigate the benzene emissions that result from extending the compliance date. The plan shall include the following information:

(i) A description of the method of compliance, including the control approach, schedule for installing controls, and quantity of the benzene emissions that result from extending the compliance date;

(ii) If the control approach involves a compliance strategy designed to obtain integrated compliance with multiple regulatory requirements, a description of the other regulations involved and their effective dates; and

(iii) A description of the actions to be taken at the facility to obtain mitigating environmental benefits, including how the benefits will be obtained, the schedule for these actions, and an estimate of the quantifiable benefits that directly result from these actions.

(c) Each owner or operator of a facility at which the total annual benzene quantity from facility waste is equal to or greater than 10 Mg/yr (11 ton/yr) as determined in paragraph (a) of this section shall manage and treat the facility waste as follows:

(1) For each waste stream that contains benzene, including (but not limited to) organic waste streams that contain less than 10 percent water and aqueous waste streams, even if the wastes are not discharged to an individual drain system, the owner or operator shall:

(i) Remove or destroy the benzene contained in the waste using a treatment process or wastewater treatment system that complies with the standards specified in §61.348 of this subpart.

(ii) Comply with the standards specified in §§61.343 through 61.347 of this subpart for each waste management unit that receives or manages the waste stream prior to and during treatment of the waste stream in accordance with paragraph (c)(1)(i) of this section.

(iii) Each waste management unit used to manage or treat waste streams that will be recycled to a process shall comply with the standards specified in §§61.343 through 61.347. Once the waste stream is recycled to a process, including to a tank used for the storage of production process feed, product, or product intermediates, unless this tank is used primarily for the storage of wastes, the material is no longer subject to paragraph (c) of this section.

(2) A waste stream is exempt from paragraph (c)(1) of this section provided that the owner or operator demonstrates initially and, thereafter, at least once per year that the flow-weighted annual average benzene concentration for the waste stream is less than 10 ppmw as determined by the procedures specified in §61.355(c)(2) or §61.355(c)(3).

(3) A waste stream is exempt from paragraph (c)(1) of this section provided that the owner or operator demonstrates initially and, thereafter, at least once per year that the conditions specified in either paragraph (c)(3)(i) or (c)(3)(ii) of this section are met.

(i) The waste stream is process wastewater that has a flow rate less than 0.02 liters per minute (0.005 gallons per minute) or an annual wastewater quantity of less than 10 Mg/yr (11 ton/yr); or

(ii) All of the following conditions are met:

(A) The owner or operator does not choose to exempt process wastewater under paragraph (c)(3)(i) of this section,

(B) The total annual benzene quantity in all waste streams chosen for exemption in paragraph (c)(3)(ii) of this section does not exceed 2.0 Mg/yr (2.2 ton/yr) as determined in the procedures in §61.355(j), and

(C) The total annual benzene quantity in a waste stream chosen for exemption, including process unit turnaround waste, is determined for the year in which the waste is generated.

(d) As an alternative to the requirements specified in paragraphs (c) and (e) of this section, an owner or operator of a facility at which the total annual benzene quantity from facility waste is equal to or greater than 10 Mg/yr (11 ton/yr) as determined in paragraph (a) of this section may elect to manage and treat the facility waste as follows:

(1) The owner or operator shall manage and treat facility waste other than process wastewater in accordance with the requirements of paragraph (c)(1) of this section.

(2) The owner or operator shall manage and treat process wastewater in accordance with the following requirements:

(i) Process wastewater shall be treated to achieve a total annual benzene quantity from facility process wastewater less than 1 Mg/yr (1.1 ton/yr). Total annual benzene from facility process wastewater shall be determined by adding together the annual benzene quantity at the point of waste generation for each untreated process wastewater stream plus the annual benzene quantity exiting the treatment process for each process wastewater stream treated in accordance with the requirements of paragraph (c)(1)(i) of this section.

(ii) Each treated process wastewater stream identified in paragraph (d)(2)(i) of this section shall be managed and treated in accordance with paragraph (c)(1) of this section.

(iii) Each untreated process wastewater stream identified in paragraph (d)(2)(i) of this section is exempt from the requirements of paragraph (c)(1) of this section.

(e) As an alternative to the requirements specified in paragraphs (c) and (d) of this section, an owner or operator of a facility at which the total annual benzene quantity from facility waste is equal to or greater than 10 Mg/yr (11 ton/yr) as determined in paragraph (a) of this section may elect to manage and treat the facility waste as follows:

(1) The owner or operator shall manage and treat facility waste with a flow-weighted annual average water content of less than 10 percent in accordance with the requirements of paragraph (c)(1) of this section; and

(2) The owner or operator shall manage and treat facility waste (including remediation and process unit turnaround waste) with a flow-weighted annual average water content of 10 percent or greater, on a volume basis as total water, and each waste stream that is mixed with water or wastes at any time such that the resulting mixture has an annual water content greater than 10 percent, in accordance with the following:

(i) The benzene quantity for the wastes described in paragraph (e)(2) of this section must be equal to or less than 6.0 Mg/yr (6.6 ton/yr), as determined in §61.355(k). Wastes as described in paragraph (e)(2) of this section that are transferred offsite shall be included in the determination of benzene quantity as provided in §61.355(k). The provisions of paragraph (f) of this section shall not apply to any owner or operator who elects to comply with the provisions of paragraph (e) of this section.

(ii) The determination of benzene quantity for each waste stream defined in paragraph (e)(2) of this section shall be made in accordance with §61.355(k).

(f) Rather than treating the waste onsite, an owner or operator may elect to comply with paragraph (c)(1)(i) of this section by transferring the waste offsite to another facility where the waste is treated in accordance with the requirements of paragraph (c)(1)(i) of this section. The owner or operator transferring the waste shall:

(1) Comply with the standards specified in §§61.343 through 61.347 of this subpart for each waste management unit that receives or manages the waste prior to shipment of the waste offsite.

(2) Include with each offsite waste shipment a notice stating that the waste contains benzene which is required to be managed and treated in accordance with the provisions of this subpart.

(g) Compliance with this subpart will be determined by review of facility records and results from tests and inspections using methods and procedures specified in §61.355 of this subpart.

(h) Permission to use an alternative means of compliance to meet the requirements of §§61.342 through 61.352 of this subpart may be granted by the Administrator as provided in §61.353 of this subpart.

### **§61.343 Standards: Tanks.**

(a) Except as provided in paragraph (b) of this section and in §61.351, the owner or operator must meet the standards in paragraph (a)(1) or (2) of this section for each tank in which the waste stream is placed in accordance with §61.342 (c)(1)(ii). The standards in this section apply to the treatment and storage of the waste stream in a tank, including dewatering.

(1) The owner or operator shall install, operate, and maintain a fixed-roof and closed-vent system that routes all organic vapors vented from the tank to a control device.

(i) The fixed-roof shall meet the following requirements:

(A) The cover and all openings (e.g., access hatches, sampling ports, and gauge wells) shall be designed to operate with no detectable emissions as indicated by an instrument reading of less than 500 ppmv above background, as determined initially and thereafter at least once per year by the methods specified in §61.355(h) of this subpart.

(B) Each opening shall be maintained in a closed, sealed position (e.g., covered by a lid that is gasketed and latched) at all times that waste is in the tank except when it is necessary to use the opening for waste sampling or removal, or for equipment inspection, maintenance, or repair.

(C) If the cover and closed-vent system operate such that the tank is maintained at a pressure less than atmospheric pressure, then paragraph (a)(1)(i)(B) of this section does not apply to any opening that meets all of the following conditions:

(1) The purpose of the opening is to provide dilution air to reduce the explosion hazard;

(2) The opening is designed to operate with no detectable emissions as indicated by an instrument reading of less than 500 ppmv above background, as determined initially and thereafter at least once per year by the methods specified in §61.355(h); and

(3) The pressure is monitored continuously to ensure that the pressure in the tank remains below atmospheric pressure.

(ii) The closed-vent system and control device shall be designed and operated in accordance with the requirements of §61.349 of this subpart.

(2) The owner or operator must install, operate, and maintain an enclosure and closed-vent system that routes all organic vapors vented from the tank, located inside the enclosure, to a control device in accordance with the requirements specified in paragraph (e) of this section.

(b) For a tank that meets all the conditions specified in paragraph (b)(1) of this section, the owner or operator may elect to comply with paragraph (b)(2) of this section as an alternative to the requirements specified in paragraph (a)(1) of this section.



(1) The waste managed in the tank complying with paragraph (b)(2) of this section shall meet all of the following conditions:

(i) Each waste stream managed in the tank must have a flow-weighted annual average water content less than or equal to 10 percent water, on a volume basis as total water.

(ii) The waste managed in the tank either:

(A) Has a maximum organic vapor pressure less than 5.2 kilopascals (kPa) (0.75 pounds per square inch (psi));

(B) Has a maximum organic vapor pressure less than 27.6 kPa (4.0 psi) and is managed in a tank having design capacity less than 151 m<sup>3</sup> (40,000 gal); or

(C) Has a maximum organic vapor pressure less than 76.6 kPa (11.1 psi) and is managed in a tank having a design capacity less than 75 m<sup>3</sup> (20,000 gal).

(2) The owner or operator shall install, operate, and maintain a fixed roof as specified in paragraph (a)(1)(i).

(3) For each tank complying with paragraph (b) of this section, one or more devices which vent directly to the atmosphere may be used on the tank provided each device remains in a closed, sealed position during normal operations except when the device needs to open to prevent physical damage or permanent deformation of the tank or cover resulting from filling or emptying the tank, diurnal temperature changes, atmospheric pressure changes or malfunction of the unit in accordance with good engineering and safety practices for handling flammable, explosive, or other hazardous materials.

(c) Each fixed-roof, seal, access door, and all other openings shall be checked by visual inspection initially and quarterly thereafter to ensure that no cracks or gaps occur and that access doors and other openings are closed and gasketed properly.

(d) Except as provided in §61.350 of this subpart, when a broken seal or gasket or other problem is identified, or when detectable emissions are measured, first efforts at repair shall be made as soon as practicable, but not later than 45 calendar days after identification.

(e) Each owner or operator who controls air pollutant emissions by using an enclosure vented through a closed-vent system to a control device must meet the requirements specified in paragraphs (e)(1) through (4) of this section.

(1) The tank must be located inside a total enclosure. The enclosure must be designed and operated in accordance with the criteria for a permanent total enclosure as specified in "Procedure T—Criteria for and Verification of a Permanent or Temporary Total Enclosure" in 40 CFR 52.741, appendix B. The enclosure may have permanent or temporary openings to allow worker access; passage of material into or out of the enclosure by conveyor, vehicles, or other mechanical means; entry of permanent mechanical or electrical equipment; or direct airflow into the enclosure. The owner or operator must perform the verification procedure for the enclosure as specified in section 5.0 of Procedure T initially when the enclosure is first installed and, thereafter, annually. A facility that has conducted an initial compliance demonstration and that performs annual compliance demonstrations in accordance with the requirements for Tank Level 2 control requirements 40 CFR 264.1084(i) or 40 CFR 265(i) is not required to make repeat demonstrations of initial and continuous compliance for the purposes of this subpart.

(2) The enclosure must be vented through a closed-vent system to a control device that is designed and operated in accordance with the standards for control devices specified in §61.349.

(3) Safety devices, as defined in this subpart, may be installed and operated as necessary on any enclosure, closed-vent system, or control device used to comply with the requirements of paragraphs (e)(1) and (2) of this section.

(4) The closed-vent system must be designed and operated in accordance with the requirements of §61.349.

[55 FR 8346, Mar. 7, 1990, as amended at 55 FR 18331, May 2, 1990; 58 FR 3096, Jan. 7, 1993; 67 FR 68532, Nov. 12, 2002; 68 FR 6082, Feb. 6, 2003; 68 FR 67935, Dec. 4, 2003]

#### **§61.344 Standards: Surface impoundments.**

(a) The owner or operator shall meet the following standards for each surface impoundment in which waste is placed in accordance with §61.342(c)(1)(ii) of this subpart:

(1) The owner or operator shall install, operate, and maintain on each surface impoundment a cover (e.g., air-supported structure or rigid cover) and closed-vent system that routes all organic vapors vented from the surface impoundment to a control device.

(i) The cover shall meet the following requirements:

(A) The cover and all openings (e.g., access hatches, sampling ports, and gauge wells) shall be designed to operate with no detectable emissions as indicated by an instrument reading of less than 500 ppmv above background, initially and thereafter at least once per year by the methods specified in §61.355(h) of this subpart.

(B) Each opening shall be maintained in a closed, sealed position (e.g., covered by a lid that is gasketed and latched) at all times that waste is in the surface impoundment except when it is necessary to use the opening for waste sampling or removal, or for equipment inspection, maintenance, or repair.

(C) If the cover and closed-vent system operate such that the enclosure of the surface impoundment is maintained at a pressure less than atmospheric pressure, then paragraph (a)(1)(i)(B) of this section does not apply to any opening that meets all of the following conditions:

(1) The purpose of the opening is to provide dilution air to reduce the explosion hazard;

(2) The opening is designed to operate with no detectable emissions as indicated by an instrument reading of less than 500 ppmv above background, as determined initially and thereafter at least once per year by the methods specified in §61.355(h) of this subpart; and

(3) The pressure is monitored continuously to ensure that the pressure in the enclosure of the surface impoundment remains below atmospheric pressure.

(D) The cover shall be used at all times that waste is placed in the surface impoundment except during removal of treatment residuals in accordance with 40 CFR 268.4 or closure of the surface impoundment in accordance with 40 CFR 264.228. (Note: the treatment residuals generated by these activities may be subject to the requirements of this part.)

(ii) The closed-vent system and control device shall be designed and operated in accordance with §61.349 of this subpart.

(b) Each cover seal, access hatch, and all other openings shall be checked by visual inspection initially and quarterly thereafter to ensure that no cracks or gaps occur and that access hatches and other openings are closed and gasketed properly.

(c) Except as provided in §61.350 of this subpart, when a broken seal or gasket or other problem is identified, or when detectable emissions are measured, first efforts at repair shall be made as soon as practicable, but not later than 15 calendar days after identification.

[55 FR 8346, Mar. 7, 1990, as amended at 58 FR 3097, Jan. 7, 1993]

#### **§61.345 Standards: Containers.**

(a) The owner or operator shall meet the following standards for each container in which waste is placed in accordance with §61.342(c)(1)(ii) of this subpart:

(1) The owner or operator shall install, operate, and maintain a cover on each container used to handle, transfer, or store waste in accordance with the following requirements:

(i) The cover and all openings (e.g., bungs, hatches, and sampling ports) shall be designed to operate with no detectable emissions as indicated by an instrument reading of less than 500 ppmv above background, initially and thereafter at least once per year by the methods specified in §61.355(h) of this subpart.

(ii) Except as provided in paragraph (a)(4) of this section, each opening shall be maintained in a closed, sealed position (e.g., covered by a lid that is gasketed and latched) at all times that waste is in the container except when it is necessary to use the opening for waste loading, removal, inspection, or sampling.

(2) When a waste is transferred into a container by pumping, the owner or operator shall perform the transfer using a submerged fill pipe. The submerged fill pipe outlet shall extend to within two pipe diameters of the bottom of the container while the container is being loaded. During loading of the waste, the cover shall remain in place and all openings shall be maintained in a closed, sealed position except for those openings required for the submerged fill pipe, those openings required for venting of the container to prevent physical damage or permanent deformation of the container or cover, and any openings complying with paragraph (a)(4) of this section.

(3) Treatment of a waste in a container, including aeration, thermal or other treatment, must be performed by the owner or operator in a manner such that while the waste is being treated the container meets the standards specified in paragraphs (a)(3)(i) through (iii) of this section, except for covers and closed-vent systems that meet the requirements in paragraph (a)(4) of this section.

(i) The owner or operator must either:

(A) Vent the container inside a total enclosure which is exhausted through a closed-vent system to a control device in accordance with the requirements of paragraphs (a)(3)(ii)(A) and (B) of this section; or

(B) Vent the covered or closed container directly through a closed-vent system to a control device in accordance with the requirements of paragraphs (a)(3)(ii)(B) and (C) of this section.

(ii) The owner or operator must meet the following requirements, as applicable to the type of air emission control equipment selected by the owner or operator:

(A) The total enclosure must be designed and operated in accordance with the criteria for a permanent total enclosure as specified in section 5 of the "Procedure T—Criteria for and Verification of a Permanent or Temporary Total Enclosure" in 40 CFR 52.741, appendix B. The enclosure may have permanent or temporary openings to allow worker access; passage of containers through the enclosure by conveyor or other mechanical means; entry of permanent mechanical or electrical equipment; or direct airflow into the enclosure. The owner or operator must perform the verification procedure for the enclosure as specified in section 5.0 of "Procedure T—Criteria for and Verification of a Permanent or Temporary Total Enclosure" initially when the enclosure is first installed and, thereafter, annually. A facility that has conducted an initial compliance demonstration and that performs annual compliance demonstrations in accordance with the Container Level 3 control requirements in 40 CFR 264.1086(e)(2)(i) or 40 CFR 265.1086(e)(2)(i) is not required to make repeat demonstrations of initial and continuous compliance for the purposes of this subpart.

(B) The closed-vent system and control device must be designed and operated in accordance with the requirements of §61.349.

(C) For a container cover, the cover and all openings (e.g., doors, hatches) must be designed to operate with no detectable emissions as indicated by an instrument reading of less than 500 ppmv above background, initially and thereafter at least once per year by the methods specified in §61.355(h).

(iii) Safety devices, as defined in this subpart, may be installed and operated as necessary on any container, enclosure, closed-vent system, or control device used to comply with the requirements of paragraph (a)(3)(i) of this section.

(4) If the cover and closed-vent system operate such that the container is maintained at a pressure less than atmospheric pressure, the owner or operator may operate the system with an opening that is not sealed and kept closed at all times if the following conditions are met:

(i) The purpose of the opening is to provide dilution air to reduce the explosion hazard;

(ii) The opening is designed to operate with no detectable emissions as indicated by an instrument reading of less than 500 ppmv above background, as determined initially and thereafter at least once per year by methods specified in §61.355(h); and

(iii) The pressure is monitored continuously to ensure that the pressure in the container remains below atmospheric pressure.

(b) Each cover and all openings shall be visually inspected initially and quarterly thereafter to ensure that they are closed and gasketed properly.

(c) Except as provided in §61.350 of this subpart, when a broken seal or gasket or other problem is identified, first efforts at repair shall be made as soon as practicable, but not later than 15 calendar days after identification.

[55 FR 8346, Mar. 7, 1990, as amended at 58 FR 3097, Jan. 7, 1993; 67 FR 68532, Nov. 12, 2002; 68 FR 67936, Dec. 4, 2003]

#### **§61.346 Standards: Individual drain systems.**

(a) Except as provided in paragraph (b) of this section, the owner or operator shall meet the following standards for each individual drain system in which waste is placed in accordance with §61.342(c)(1)(ii) of this subpart:

(1) The owner or operator shall install, operate, and maintain on each drain system opening a cover and closed-vent system that routes all organic vapors vented from the drain system to a control device.

(i) The cover shall meet the following requirements:

(A) The cover and all openings (e.g., access hatches, sampling ports) shall be designed to operate with no detectable emissions as indicated by an instrument reading of less than 500 ppmv above background, initially and thereafter at least once per year by the methods specified in §61.355(h) of this subpart.

(B) Each opening shall be maintained in a closed, sealed position (e.g., covered by a lid that is gasketed and latched) at all times that waste is in the drain system except when it is necessary to use the opening for waste sampling or removal, or for equipment inspection, maintenance, or repair.

(C) If the cover and closed-vent system operate such that the individual drain system is maintained at a pressure less than atmospheric pressure, then paragraph (a)(1)(i)(B) of this section does not apply to any opening that meets all of the following conditions:

(1) The purpose of the opening is to provide dilution air to reduce the explosion hazard;

(2) The opening is designed to operate with no detectable emissions as indicated by an instrument reading of less than 500 ppmv above background, as determined initially and thereafter at least once per year by the methods specified in §61.355(h); and

(3) The pressure is monitored continuously to ensure that the pressure in the individual drain system remains below atmospheric pressure.

(ii) The closed-vent system and control device shall be designed and operated in accordance with §61.349 of this subpart.

(2) Each cover seal, access hatch, and all other openings shall be checked by visual inspection initially and quarterly thereafter to ensure that no cracks or gaps occur and that access hatches and other openings are closed and gasketed properly.

(3) Except as provided in §61.350 of this subpart, when a broken seal or gasket or other problem is identified, or when detectable emissions are measured, first efforts at repair shall be made as soon as practicable, but not later than 15 calendar days after identification.

(b) As an alternative to complying with paragraph (a) of this section, an owner or operator may elect to comply with the following requirements:

(1) Each drain shall be equipped with water seal controls or a tightly sealed cap or plug.

(2) Each junction box shall be equipped with a cover and may have a vent pipe. The vent pipe shall be at least 90 cm (3 ft) in length and shall not exceed 10.2 cm (4 in) in diameter.

(i) Junction box covers shall have a tight seal around the edge and shall be kept in place at all times, except during inspection and maintenance.

(ii) One of the following methods shall be used to control emissions from the junction box vent pipe to the atmosphere:

(A) Equip the junction box with a system to prevent the flow of organic vapors from the junction box vent pipe to the atmosphere during normal operation. An example of such a system includes use of water seal controls on the junction box. A flow indicator shall be installed, operated, and maintained on each junction box vent pipe to ensure that organic vapors are not vented from the junction box to the atmosphere during normal operation.

(B) Connect the junction box vent pipe to a closed-vent system and control device in accordance with §61.349 of this subpart.

(3) Each sewer line shall not be open to the atmosphere and shall be covered or enclosed in a manner so as to have no visual gaps or cracks in joints, seals, or other emission interfaces.

(4) Equipment installed in accordance with paragraphs (b)(1), (b)(2), or (b)(3) of this section shall be inspected as follows:

(i) Each drain using water seal controls shall be checked by visual or physical inspection initially and thereafter quarterly for indications of low water levels or other conditions that would reduce the effectiveness of water seal controls.

(ii) Each drain using a tightly sealed cap or plug shall be visually inspected initially and thereafter quarterly to ensure caps or plugs are in place and properly installed.

(iii) Each junction box shall be visually inspected initially and thereafter quarterly to ensure that the cover is in place and to ensure that the cover has a tight seal around the edge.

(iv) The unburied portion of each sewer line shall be visually inspected initially and thereafter quarterly for indication of cracks, gaps, or other problems that could result in benzene emissions.

(5) Except as provided in §61.350 of this subpart, when a broken seal, gap, crack or other problem is identified, first efforts at repair shall be made as soon as practicable, but not later than 15 calendar days after identification.

[55 FR 8346, Mar. 7, 1990, as amended at 55 FR 37231, Sept. 10, 1990; 58 FR 3097, Jan. 7, 1993]

#### **§61.347 Standards: Oil-water separators.**

(a) Except as provided in §61.352 of this subpart, the owner or operator shall meet the following standards for each oil-water separator in which waste is placed in accordance with §61.342(c)(1)(ii) of this subpart:

(1) The owner or operator shall install, operate, and maintain a fixed-roof and closed-vent system that routes all organic vapors vented from the oil-water separator to a control device.

(i) The fixed-roof shall meet the following requirements:

(A) The cover and all openings (e.g., access hatches, sampling ports, and gauge wells) shall be designed to operate with no detectable emissions as indicated by an instrument reading of less than 500 ppmv above background, as determined initially and thereafter at least once per year by the methods specified in §61.355(h) of this subpart.

(B) Each opening shall be maintained in a closed, sealed position (e.g., covered by a lid that is gasketed and latched) at all times that waste is in the oil-water separator except when it is necessary to use the opening for waste sampling or removal, or for equipment inspection, maintenance, or repair.

(C) If the cover and closed-vent system operate such that the oil-water separator is maintained at a pressure less than atmospheric pressure, then paragraph (a)(1)(i)(B) of this section does not apply to any opening that meets all of the following conditions:

(1) The purpose of the opening is to provide dilution air to reduce the explosion hazard;

(2) The opening is designed to operate with no detectable emissions as indicated by an instrument reading of less than 500 ppmv above background, as determined initially and thereafter at least once per year by the methods specified in §61.355(h); and

(3) The pressure is monitored continuously to ensure that the pressure in the oil-water separator remains below atmospheric pressure.

(ii) The closed-vent system and control device shall be designed and operated in accordance with the requirements of §61.349 of this subpart.

(b) Each cover seal, access hatch, and all other openings shall be checked by visual inspection initially and quarterly thereafter to ensure that no cracks or gaps occur between the cover and oil-water separator wall and that access hatches and other openings are closed and gasketed properly.

(c) Except as provided in §61.350 of this subpart, when a broken seal or gasket or other problem is identified, or when detectable emissions are measured, first efforts at repair shall be made as soon as practicable, but not later than 15 calendar days after identification.

[55 FR 8346, Mar. 7, 1990, as amended at 58 FR 3098, Jan. 7, 1993]

#### **§61.348 Standards: Treatment processes.**

(a) Except as provided in paragraph (a)(5) of this section, the owner or operator shall treat the waste stream in accordance with the following requirements:

(1) The owner or operator shall design, install, operate, and maintain a treatment process that either:

(i) Removes benzene from the waste stream to a level less than 10 parts per million by weight (ppmw) on a flow-weighted annual average basis,

(ii) Removes benzene from the waste stream by 99 percent or more on a mass basis, or

(iii) Destroys benzene in the waste stream by incinerating the waste in a combustion unit that achieves a destruction efficiency of 99 percent or greater for benzene.

(2) Each treatment process complying with paragraphs (a)(1)(i) or (a)(1)(ii) of this section shall be designed and operated in accordance with the appropriate waste management unit standards specified in §§61.343 through 61.347 of this subpart. For example, if a treatment process is a tank, then the owner or operator shall comply with §61.343 of this subpart.

(3) For the purpose of complying with the requirements specified in paragraph (a)(1)(i) of this section, the intentional or unintentional reduction in the benzene concentration of a waste stream by dilution of the waste stream with other wastes or materials is not allowed.

(4) An owner or operator may aggregate or mix together individual waste streams to create a combined waste stream for the purpose of facilitating treatment of waste to comply with the requirements of paragraph (a)(1) of this section except as provided in paragraph (a)(5) of this section.

(5) If an owner or operator aggregates or mixes any combination of process wastewater, product tank drawdown, or landfill leachate subject to §61.342(c)(1) of this subpart together with other waste streams to create a combined waste stream for the purpose of facilitating management or treatment of waste in a wastewater treatment system, then the wastewater treatment system shall be operated in accordance with paragraph (b) of this section. These provisions apply to above-ground wastewater treatment systems as well as those that are at or below ground level.

(b) Except for facilities complying with §61.342(e), the owner or operator that aggregates or mixes individual waste streams as defined in paragraph (a)(5) of this section for management and treatment in a wastewater treatment system shall comply with the following requirements:

(1) The owner or operator shall design and operate each waste management unit that comprises the wastewater treatment system in accordance with the appropriate standards specified in §§61.343 through 61.347 of this subpart.

(2) The provisions of paragraph (b)(1) of this section do not apply to any waste management unit that the owner or operator demonstrates to meet the following conditions initially and, thereafter, at least once per year:

(i) The benzene content of each waste stream entering the waste management unit is less than 10 ppmw on a flow-weighted annual average basis as determined by the procedures specified in §61.355(c) of this subpart; and

(ii) The total annual benzene quantity contained in all waste streams managed or treated in exempt waste management units comprising the facility wastewater treatment systems is less than 1 Mg/yr (1.1 ton/yr). For this determination, total annual benzene quantity shall be calculated as follows:

(A) The total annual benzene quantity shall be calculated as the sum of the individual benzene quantities determined at each location where a waste stream first enters an exempt waste management unit. The benzene quantity discharged from an exempt waste management unit shall not be included in this calculation.

(B) The annual benzene quantity in a waste stream managed or treated in an enhanced biodegradation unit shall not be included in the calculation of the total annual benzene quantity, if the enhanced biodegradation unit is the first exempt unit in which the waste is managed or treated. A unit shall be considered enhanced biodegradation if it is a suspended-growth process that generates biomass, uses recycled biomass, and periodically removes biomass from the process. An enhanced biodegradation unit typically operates at a food-to-microorganism ratio in the range of 0.05 to 1.0 kg of biological oxygen demand per kg of biomass per day, a mixed liquor suspended solids ratio in the range of 1 to 8 grams per liter (0.008 to 0.7 pounds per liter), and a residence time in the range of 3 to 36 hours.

(c) The owner and operator shall demonstrate that each treatment process or wastewater treatment system unit, except as provided in paragraph (d) of this section, achieves the appropriate conditions specified in paragraphs (a) or (b) of this section in accordance with the following requirements:

(1) Engineering calculations in accordance with requirements specified in §61.356(e) of this subpart;  
or



(2) Performance tests conducted using the test methods and procedures that meet the requirements specified in §61.355 of this subpart.

(d) A treatment process or waste stream is in compliance with the requirements of this subpart and exempt from the requirements of paragraph (c) of this section provided that the owner or operator documents that the treatment process or waste stream is in compliance with other regulatory requirements as follows:

(1) The treatment process is a hazardous waste incinerator for which the owner or operator has been issued a final permit under 40 CFR part 270 and complies with the requirements of 40 CFR part 264, subpart O;

(2) The treatment process is an industrial furnace or boiler burning hazardous waste for energy recovery for which the owner or operator has been issued a final permit under 40 CFR part 270 and complies with the requirements of 40 CFR part 266, subpart D;

(3) The waste stream is treated by a means or to a level that meets benzene-specific treatment standards in accordance with the Land Disposal Restrictions under 40 CFR part 268, and the treatment process is designed and operated with a closed-vent system and control device meeting the requirements of §61.349 of this subpart;

(4) The waste stream is treated by a means or to a level that meets benzene-specific effluent limitations or performance standards in accordance with the Effluent Guidelines and Standards under 40 CFR parts 401-464, and the treatment process is designed and operated with a closed-vent system and control device meeting the requirements of §61.349 of this subpart; or

(5) The waste stream is discharged to an underground injection well for which the owner or operator has been issued a final permit under 40 CFR part 270 and complies with the requirements of 40 CFR part 122.

(e) Except as specified in paragraph (e)(3) of this section, if the treatment process or wastewater treatment system unit has any openings (e.g., access doors, hatches, etc.), all such openings shall be sealed (e.g., gasketed, latched, etc.) and kept closed at all times when waste is being treated, except during inspection and maintenance.

(1) Each seal, access door, and all other openings shall be checked by visual inspections initially and quarterly thereafter to ensure that no cracks or gaps occur and that openings are closed and gasketed properly.

(2) Except as provided in §61.350 of this subpart, when a broken seal or gasket or other problem is identified, first efforts at repair shall be made as soon as practicable, but not later than 15 calendar days after identification.

(3) If the cover and closed-vent system operate such that the treatment process and wastewater treatment system unit are maintained at a pressure less than atmospheric pressure, the owner or operator may operate the system with an opening that is not sealed and kept closed at all times if the following conditions are met:

(i) The purpose of the opening is to provide dilution air to reduce the explosion hazard;

(ii) The opening is designed to operate with no detectable emissions as indicated by an instrument reading of less than 500 ppmv above background, as determined initially and thereafter at least once per year by the methods specified in §61.355(h); and

(iii) The pressure is monitored continuously to ensure that the pressure in the treatment process and wastewater treatment system unit remain below atmospheric pressure.

(f) Except for treatment processes complying with paragraph (d) of this section, the Administrator may request at any time an owner or operator demonstrate that a treatment process or wastewater treatment system unit meets the applicable requirements specified in paragraphs (a) or (b) of this section by conducting a performance test using the test methods and procedures as required in §61.355 of this subpart.

(g) The owner or operator of a treatment process or wastewater treatment system unit that is used to comply with the provisions of this section shall monitor the unit in accordance with the applicable requirements in §61.354 of this subpart.

[55 FR 8346, Mar. 7, 1990, as amended at 55 FR 37231, Sept. 10, 1990; 58 FR 3098, Jan. 7, 1993; 65 FR 62160, Oct. 17, 2000]

### **§61.349 Standards: Closed-vent systems and control devices.**

(a) For each closed-vent system and control device used to comply with standards in accordance with §§61.343 through 61.348 of this subpart, the owner or operator shall properly design, install, operate, and maintain the closed-vent system and control device in accordance with the following requirements:

(1) The closed-vent system shall:

(i) Be designed to operate with no detectable emissions as indicated by an instrument reading of less than 500 ppmv above background, as determined initially and thereafter at least once per year by the methods specified in §61.355(h) of this subpart.

(ii) Vent systems that contain any bypass line that could divert the vent stream away from a control device used to comply with the provisions of this subpart shall install, maintain, and operate according to the manufacturer's specifications a flow indicator that provides a record of vent stream flow away from the control device at least once every 15 minutes, except as provided in paragraph (a)(1)(ii)(B) of this section.

(A) The flow indicator shall be installed at the entrance to any bypass line that could divert the vent stream away from the control device to the atmosphere.

(B) Where the bypass line valve is secured in the closed position with a car-seal or a lock-and-key type configuration, a flow indicator is not required.

(iii) All gauging and sampling devices shall be gas-tight except when gauging or sampling is taking place.

(iv) For each closed-vent system complying with paragraph (a) of this section, one or more devices which vent directly to the atmosphere may be used on the closed-vent system provided each device remains in a closed, sealed position during normal operations except when the device needs to open to prevent physical damage or permanent deformation of the closed-vent system resulting from malfunction of the unit in accordance with good engineering and safety practices for handling flammable, explosive, or other hazardous materials.

(2) The control device shall be designed and operated in accordance with the following conditions:

(i) An enclosed combustion device (e.g., a vapor incinerator, boiler, or process heater) shall meet one of the following conditions:

(A) Reduce the organic emissions vented to it by 95 weight percent or greater;

(B) Achieve a total organic compound concentration of 20 ppmv (as the sum of the concentrations for individual compounds using Method 18) on a dry basis corrected to 3 percent oxygen; or

(C) Provide a minimum residence time of 0.5 seconds at a minimum temperature of 760 °C (1,400 °F). If a boiler or process heater issued as the control device, then the vent stream shall be introduced into the flame zone of the boiler or process heater.

(ii) A vapor recovery system (e.g., a carbon adsorption system or a condenser) shall recover or control the organic emissions vented to it with an efficiency of 95 weight percent or greater, or shall recover or control the benzene emissions vented to it with an efficiency of 98 weight percent or greater.

(iii) A flare shall comply with the requirements of 40 CFR 60.18.

(iv) A control device other than those described in paragraphs (a)(2) (i) through (iii) of this section may be used provided that the following conditions are met:

(A) The device shall recover or control the organic emissions vented to it with an efficiency of 95 weight percent or greater, or shall recover or control the benzene emissions vented to it with an efficiency of 98 weight percent or greater.

(B) The owner or operator shall develop test data and design information that documents the control device will achieve an emission control efficiency of either 95 percent or greater for organic compounds or 98 percent or greater for benzene.

(C) The owner or operator shall identify:

(1) The critical operating parameters that affect the emission control performance of the device;

(2) The range of values of these operating parameters that ensure the emission control efficiency specified in paragraph (a)(2)(iv)(A) of this section is maintained during operation of the device; and

(3) How these operating parameters will be monitored to ensure the proper operation and maintenance of the device.

(D) The owner or operator shall submit the information and data specified in paragraphs (a)(2)(iv) (B) and (C) of this section to the Administrator prior to operation of the alternative control device.

(E) The Administrator will determine, based on the information submitted under paragraph (a)(2)(iv)(D) of this section, if the control device subject to paragraph (a)(2)(iv) of this section meets the requirements of §61.349. The control device subject to paragraph (a)(2)(iv) of this section may be operated prior to receiving approval from the Administrator. However, if the Administrator determines that the control device does not meet the requirements of §61.349, the facility may be subject to enforcement action beginning from the time the control device began operation.

(b) Each closed-vent system and control device used to comply with this subpart shall be operated at all times when waste is placed in the waste management unit vented to the control device except when maintenance or repair of the waste management unit cannot be completed without a shutdown of the control device.

(c) An owner and operator shall demonstrate that each control device, except for a flare, achieves the appropriate conditions specified in paragraph (a)(2) of this section by using one of the following methods:

(1) Engineering calculations in accordance with requirements specified in §61.356(f) of this subpart;  
or

(2) Performance tests conducted using the test methods and procedures that meet the requirements specified in §61.355 of this subpart.

(d) An owner or operator shall demonstrate compliance of each flare in accordance with paragraph (a)(2)(iii) of this section.

(e) The Administrator may request at any time an owner or operator demonstrate that a control device meets the applicable conditions specified in paragraph (a)(2) of this section by conducting a performance test using the test methods and procedures as required in §61.355, and for control devices subject to paragraph (a)(2)(iv) of this section, the Administrator may specify alternative test methods and procedures, as appropriate.

(f) Each closed-vent system and control device shall be visually inspected initially and quarterly thereafter. The visual inspection shall include inspection of ductwork and piping and connections to covers and control devices for evidence of visible defects such as holes in ductwork or piping and loose connections.

(g) Except as provided in §61.350 of this subpart, if visible defects are observed during an inspection, or if other problems are identified, or if detectable emissions are measured, a first effort to repair the closed-vent system and control device shall be made as soon as practicable but no later than 5 calendar days after detection. Repair shall be completed no later than 15 calendar days after the emissions are detected or the visible defect is observed.

(h) The owner or operator of a control device that is used to comply with the provisions of this section shall monitor the control device in accordance with §61.354(c) of this subpart.

[55 FR 8346, Mar. 7, 1990; 55 FR 12444, Apr. 3, 1990, as amended at 55 FR 37231, Sept. 10, 1990; 58 FR 3098, Jan. 7, 1993; 65 FR 62160, Oct. 17, 2000]

#### **§61.350 Standards: Delay of repair.**

(a) Delay of repair of facilities or units that are subject to the provisions of this subpart will be allowed if the repair is technically impossible without a complete or partial facility or unit shutdown.

(b) Repair of such equipment shall occur before the end of the next facility or unit shutdown.

#### **§61.351 Alternative standards for tanks.**

(a) As an alternative to the standards for tanks specified in §61.343 of this subpart, an owner or operator may elect to comply with one of the following:

(1) A fixed roof and internal floating roof meeting the requirements in 40 CFR 60.112b(a)(1);

(2) An external floating roof meeting the requirements of 40 CFR 60.112b (a)(2); or

(3) An alternative means of emission limitation as described in 40 CFR 60.114b.

(b) If an owner or operator elects to comply with the provisions of this section, then the owner or operator is exempt from the provisions of §61.343 of this subpart applicable to the same facilities.

[55 FR 8346, Mar. 7, 1990, as amended at 55 FR 37231, Sept. 10, 1990]

**§61.352 Alternative standards for oil-water separators.**

(a) As an alternative to the standards for oil-water separators specified in §61.347 of this subpart, an owner or operator may elect to comply with one of the following:

- (1) A floating roof meeting the requirements in 40 CFR 60.693-2(a); or
- (2) An alternative means of emission limitation as described in 40 CFR 60.694.

(b) For portions of the oil-water separator where it is infeasible to construct and operate a floating roof, such as over the weir mechanism, a fixed roof vented to a vapor control device that meets the requirements in §§61.347 and 61.349 of this subpart shall be installed and operated.

(c) Except as provided in paragraph (b) of this section, if an owner or operator elects to comply with the provisions of this section, then the owner or operator is exempt from the provisions in §61.347 of this subpart applicable to the same facilities.

**§61.353 Alternative means of emission limitation.**

(a) If, in the Administrator's judgment, an alternative means of emission limitation will achieve a reduction in benzene emissions at least equivalent to the reduction in benzene emissions from the source achieved by the applicable design, equipment, work practice, or operational requirements in §§61.342 through 61.349, the Administrator will publish in the FEDERAL REGISTER a notice permitting the use of the alternative means for purposes of compliance with that requirement. The notice may condition the permission on requirements related to the operation and maintenance of the alternative means.

(b) Any notice under paragraph (a) of this section shall be published only after public notice and an opportunity for a hearing.

(c) Any person seeking permission under this section shall collect, verify, and submit to the Administrator information showing that the alternative means achieves equivalent emission reductions.

[55 FR 8346, Mar. 7, 1990, as amended at 58 FR 3099, Jan. 7, 1993]

**§61.354 Monitoring of operations.**

(a) Except for a treatment process or waste stream complying with §61.348(d), the owner or operator shall monitor each treatment process or wastewater treatment system unit to ensure the unit is properly operated and maintained by one of the following monitoring procedures:

(1) Measure the benzene concentration of the waste stream exiting the treatment process complying with §61.348(a)(1)(i) at least once per month by collecting and analyzing one or more samples using the procedures specified in §61.355(c)(3).

(2) Install, calibrate, operate, and maintain according to manufacturer's specifications equipment to continuously monitor and record a process parameter (or parameters) for the treatment process or wastewater treatment system unit that indicates proper system operation. The owner or operator shall

inspect at least once each operating day the data recorded by the monitoring equipment (e.g., temperature monitor or flow indicator) to ensure that the unit is operating properly.

(b) If an owner or operator complies with the requirements of §61.348(b), then the owner or operator shall monitor each wastewater treatment system to ensure the unit is properly operated and maintained by the appropriate monitoring procedure as follows:

(1) For the first exempt waste management unit in each waste treatment train, other than an enhanced biodegradation unit, measure the flow rate, using the procedures of §61.355(b), and the benzene concentration of each waste stream entering the unit at least once per month by collecting and analyzing one or more samples using the procedures specified in §61.355(c)(3).

(2) For each enhanced biodegradation unit that is the first exempt waste management unit in a treatment train, measure the benzene concentration of each waste stream entering the unit at least once per month by collecting and analyzing one or more samples using the procedures specified in §61.355(c)(3).

(c) An owner or operator subject to the requirements in §61.349 of this subpart shall install, calibrate, maintain, and operate according to the manufacturer's specifications a device to continuously monitor the control device operation as specified in the following paragraphs, unless alternative monitoring procedures or requirements are approved for that facility by the Administrator. The owner or operator shall inspect at least once each operating day the data recorded by the monitoring equipment (e.g., temperature monitor or flow indicator) to ensure that the control device is operating properly.

(1) For a thermal vapor incinerator, a temperature monitoring device equipped with a continuous recorder. The device shall have an accuracy of  $\pm 1$  percent of the temperature being monitored in  $^{\circ}\text{C}$  or  $\pm 0.5$   $^{\circ}\text{C}$ , whichever is greater. The temperature sensor shall be installed at a representative location in the combustion chamber.

(2) For a catalytic vapor incinerator, a temperature monitoring device equipped with a continuous recorder. The device shall be capable of monitoring temperature at two locations, and have an accuracy of  $\pm 1$  percent of the temperature being monitored in  $^{\circ}\text{C}$  or  $\pm 0.5$   $^{\circ}\text{C}$ , whichever is greater. One temperature sensor shall be installed in the vent stream at the nearest feasible point to the catalyst bed inlet and a second temperature sensor shall be installed in the vent stream at the nearest feasible point to the catalyst bed outlet.

(3) For a flare, a monitoring device in accordance with 40 CFR 60.18(f)(2) equipped with a continuous recorder.

(4) For a boiler or process heater having a design heat input capacity less than 44 MW ( $150 \times 10^6$  BTU/hr), a temperature monitoring device equipped with a continuous recorder. The device shall have an accuracy of  $\pm 1$  percent of the temperature being monitored in  $^{\circ}\text{C}$  or  $\pm 0.5$   $^{\circ}\text{C}$ , whichever is greater. The temperature sensor shall be installed at a representative location in the combustion chamber.

(5) For a boiler or process heater having a design heat input capacity greater than or equal to 44 MW ( $150 \times 10^6$  BTU/hr), a monitoring device equipped with a continuous recorder to measure a parameter(s) that indicates good combustion operating practices are being used.

(6) For a condenser, either:

(i) A monitoring device equipped with a continuous recorder to measure either the concentration level of the organic compounds or the concentration level of benzene in the exhaust vent stream from the condenser; or

(ii) A temperature monitoring device equipped with a continuous recorder. The device shall be capable of monitoring temperature at two locations, and have an accuracy of  $\pm 1$  percent of the temperature being monitored in  $^{\circ}\text{C}$  or  $\pm 0.5$   $^{\circ}\text{C}$ , whichever is greater. One temperature sensor shall be installed at a location in the exhaust stream from the condenser, and a second temperature sensor shall be installed at a location in the coolant fluid exiting the condenser.

(7) For a carbon adsorption system that regenerates the carbon bed directly in the control device such as a fixed-bed carbon adsorber, either:

(i) A monitoring device equipped with a continuous recorder to measure either the concentration level of the organic compounds or the benzene concentration level in the exhaust vent stream from the carbon bed; or

(ii) A monitoring device equipped with a continuous recorder to measure a parameter that indicates the carbon bed is regenerated on a regular, predetermined time cycle.

(8) For a vapor recovery system other than a condenser or carbon adsorption system, a monitoring device equipped with a continuous recorder to measure either the concentration level of the organic compounds or the benzene concentration level in the exhaust vent stream from the control device.

(9) For a control device subject to the requirements of §61.349(a)(2)(iv), devices to monitor the parameters as specified in §61.349(a)(2)(iv)(C).

(d) For a carbon adsorption system that does not regenerate the carbon bed directly on site in the control device (e.g., a carbon canister), either the concentration level of the organic compounds or the concentration level of benzene in the exhaust vent stream from the carbon adsorption system shall be monitored on a regular schedule, and the existing carbon shall be replaced with fresh carbon immediately when carbon breakthrough is indicated. The device shall be monitored on a daily basis or at intervals no greater than 20 percent of the design carbon replacement interval, whichever is greater. As an alternative to conducting this monitoring, an owner or operator may replace the carbon in the carbon adsorption system with fresh carbon at a regular predetermined time interval that is less than the carbon replacement interval that is determined by the maximum design flow rate and either the organic concentration or the benzene concentration in the gas stream vented to the carbon adsorption system.

(e) An alternative operation or process parameter may be monitored if it can be demonstrated that another parameter will ensure that the control device is operated in conformance with these standards and the control device's design specifications.

(f) Owners or operators using a closed-vent system that contains any bypass line that could divert a vent stream from a control device used to comply with the provisions of this subpart shall do the following:

(1) Visually inspect the bypass line valve at least once every month, checking the position of the valve and the condition of the car-seal or closure mechanism required under §61.349(a)(1)(ii) to ensure that the valve is maintained in the closed position and the vent stream is not diverted through the bypass line.

(2) Visually inspect the readings from each flow monitoring device required by §61.349(a)(1)(ii) at least once each operating day to check that vapors are being routed to the control device as required.

(g) Each owner or operator who uses a system for emission control that is maintained at a pressure less than atmospheric pressure with openings to provide dilution air shall install, calibrate, maintain, and operate according to the manufacturer's specifications a device equipped with a continuous recorder to monitor the pressure in the unit to ensure that it is less than atmospheric pressure.

**§61.355 Test methods, procedures, and compliance provisions.**

(a) An owner or operator shall determine the total annual benzene quantity from facility waste by the following procedure:

(1) For each waste stream subject to this subpart having a flow-weighted annual average water content greater than 10 percent water, on a volume basis as total water, or is mixed with water or other wastes at any time and the resulting mixture has an annual average water content greater than 10 percent as specified in §61.342(a), the owner or operator shall:

(i) Determine the annual waste quantity for each waste stream using the procedures specified in paragraph (b) of this section.

(ii) Determine the flow-weighted annual average benzene concentration for each waste stream using the procedures specified in paragraph (c) of this section.

(iii) Calculate the annual benzene quantity for each waste stream by multiplying the annual waste quantity of the waste stream times the flow-weighted annual average benzene concentration.

(2) Total annual benzene quantity from facility waste is calculated by adding together the annual benzene quantity for each waste stream generated during the year and the annual benzene quantity for each process unit turnaround waste annualized according to paragraph (b)(4) of this section.

(3) If the total annual benzene quantity from facility waste is equal to or greater than 10 Mg/yr (11 ton/yr), then the owner or operator shall comply with the requirements of §61.342 (c), (d), or (e).

(4) If the total annual benzene quantity from facility waste is less than 10 Mg/yr (11 ton/yr) but is equal to or greater than 1 Mg/yr (1.1 ton/yr), then the owner or operator shall:

(i) Comply with the recordkeeping requirements of §61.356 and reporting requirements of §61.357 of this subpart; and

(ii) Repeat the determination of total annual benzene quantity from facility waste at least once per year and whenever there is a change in the process generating the waste that could cause the total annual benzene quantity from facility waste to increase to 10 Mg/yr (11 ton/yr) or more.

(5) If the total annual benzene quantity from facility waste is less than 1 Mg/yr (1.1 ton/yr), then the owner or operator shall:

(i) Comply with the recordkeeping requirements of §61.356 and reporting requirements of §61.357 of this subpart; and

(ii) Repeat the determination of total annual benzene quantity from facility waste whenever there is a change in the process generating the waste that could cause the total annual benzene quantity from facility waste to increase to 1 Mg/yr (1.1 ton/yr) or more.

(6) The benzene quantity in a waste stream that is generated less than one time per year, except as provided for process unit turnaround waste in paragraph (b)(4) of this section, shall be included in the determination of total annual benzene quantity from facility waste for the year in which the waste is generated unless the waste stream is otherwise excluded from the determination of total annual benzene quantity from facility waste in accordance with paragraphs (a) through (c) of this section. The benzene



quantity in this waste stream shall not be annualized or averaged over the time interval between the activities that resulted in generation of the waste, for purposes of determining the total annual benzene quantity from facility waste.

(b) For purposes of the calculation required by paragraph (a) of this section, an owner or operator shall determine the annual waste quantity at the point of waste generation, unless otherwise provided in paragraphs (b) (1), (2), (3), and (4) of this section, by one of the methods given in paragraphs (b) (5) through (7) of this section.

(1) The determination of annual waste quantity for sour water streams that are processed in sour water strippers shall be made at the point that the water exits the sour water stripper.

(2) The determination of annual waste quantity for wastes at coke by-product plants subject to and complying with the control requirements of §61.132, 61.133, 61.134, or 61.139 of subpart L of this part shall be made at the location that the waste stream exits the process unit component or waste management unit controlled by that subpart or at the exit of the ammonia still, provided that the following conditions are met:

(i) The transfer of wastes between units complying with the control requirements of subpart L of this part, process units, and the ammonia still is made through hard piping or other enclosed system.

(ii) The ammonia still meets the definition of a sour water stripper in §61.341.

(3) The determination of annual waste quantity for wastes that are received at hazardous waste treatment, storage, or disposal facilities from offsite shall be made at the point where the waste enters the hazardous waste treatment, storage, or disposal facility.

(4) The determination of annual waste quantity for each process unit turnaround waste generated only at 2 year or greater intervals, may be made by dividing the total quantity of waste generated during the most recent process unit turnaround by the time period (in the nearest tenth of a year) between the turnaround resulting in generation of the waste and the most recent preceding process turnaround for the unit. The resulting annual waste quantity shall be included in the calculation of the annual benzene quantity as provided in paragraph (a)(1)(iii) of this section for the year in which the turnaround occurs and for each subsequent year until the unit undergoes the next process turnaround. For estimates of total annual benzene quantity as specified in the 90-day report, required under §61.357(a)(1), the owner or operator shall estimate the waste quantity generated during the most recent turnaround, and the time period between turnarounds in accordance with good engineering practices. If the owner or operator chooses not to annualize process unit turnaround waste, as specified in this paragraph, then the process unit turnaround waste quantity shall be included in the calculation of the annual benzene quantity for the year in which the turnaround occurs.

(5) Select the highest annual quantity of waste managed from historical records representing the most recent 5 years of operation or, if the facility has been in service for less than 5 years but at least 1 year, from historical records representing the total operating life of the facility;

(6) Use the maximum design capacity of the waste management unit; or

(7) Use measurements that are representative of maximum waste generation rates.

(c) For the purposes of the calculation required by §§61.355(a) of this subpart, an owner or operator shall determine the flow-weighted annual average benzene concentration in a manner that meets the requirements given in paragraph (c)(1) of this section using either of the methods given in paragraphs (c)(2) and (c)(3) of this section.

(1) The determination of flow-weighted annual average benzene concentration shall meet all of the following criteria:

(i) The determination shall be made at the point of waste generation except for the specific cases given in paragraphs (c)(1)(i)(A) through (D) of this section.

(A) The determination for sour water streams that are processed in sour water strippers shall be made at the point that the water exits the sour water stripper.

(B) The determination for wastes at coke by-product plants subject to and complying with the control requirements of §61.132, 61.133, 61.134, or 61.139 of subpart L of this part shall be made at the location that the waste stream exits the process unit component or waste management unit controlled by that subpart or at the exit of the ammonia still, provided that the following conditions are met:

(1) The transfer of wastes between units complying with the control requirements of subpart L of this part, process units, and the ammonia still is made through hard piping or other enclosed system.

(2) The ammonia still meets the definition of a sour water stripper in §61.341.

(C) The determination for wastes that are received from offsite shall be made at the point where the waste enters the hazardous waste treatment, storage, or disposal facility.

(D) The determination of flow-weighted annual average benzene concentration for process unit turnaround waste shall be made using either of the methods given in paragraph (c)(2) or (c)(3) of this section. The resulting flow-weighted annual average benzene concentration shall be included in the calculation of annual benzene quantity as provided in paragraph (a)(1)(iii) of this section for the year in which the turnaround occurs and for each subsequent year until the unit undergoes the next process unit turnaround.

(ii) Volatilization of the benzene by exposure to air shall not be used in the determination to reduce the benzene concentration.

(iii) Mixing or diluting the waste stream with other wastes or other materials shall not be used in the determination—to reduce the benzene concentration.

(iv) The determination shall be made prior to any treatment of the waste that removes benzene, except as specified in paragraphs (c)(1)(i)(A) through (D) of this section.

(v) For wastes with multiple phases, the determination shall provide the weighted-average benzene concentration based on the benzene concentration in each phase of the waste and the relative proportion of the phases.

(2) *Knowledge of the waste.* The owner or operator shall provide sufficient information to document the flow-weighted annual average benzene concentration of each waste stream. Examples of information that could constitute knowledge include material balances, records of chemicals purchases, or previous test results provided the results are still relevant to the current waste stream conditions. If test data are used, then the owner or operator shall provide documentation describing the testing protocol and the means by which sampling variability and analytical variability were accounted for in the determination of the flow-weighted annual average benzene concentration for the waste stream. When an owner or operator and the Administrator do not agree on determinations of the flow-weighted annual average benzene concentration based on knowledge of the waste, the procedures under paragraph (c)(3) of this section shall be used to resolve the disagreement.

(3) Measurements of the benzene concentration in the waste stream in accordance with the following procedures:

(i) Collect a minimum of three representative samples from each waste stream. Where feasible, samples shall be taken from an enclosed pipe prior to the waste being exposed to the atmosphere.

(ii) For waste in enclosed pipes, the following procedures shall be used:

(A) Samples shall be collected prior to the waste being exposed to the atmosphere in order to minimize the loss of benzene prior to sampling.

(B) A static mixer shall be installed in the process line or in a by-pass line unless the owner or operator demonstrates that installation of a static mixer in the line is not necessary to accurately determine the benzene concentration of the waste stream.

(C) The sampling tap shall be located within two pipe diameters of the static mixer outlet.

(D) Prior to the initiation of sampling, sample lines and cooling coil shall be purged with at least four volumes of waste.

(E) After purging, the sample flow shall be directed to a sample container and the tip of the sampling tube shall be kept below the surface of the waste during sampling to minimize contact with the atmosphere.

(F) Samples shall be collected at a flow rate such that the cooling coil is able to maintain a waste temperature less than 10 °C (50 °F).

(G) After filling, the sample container shall be capped immediately (within 5 seconds) to leave a minimum headspace in the container.

(H) The sample containers shall immediately be cooled and maintained at a temperature below 10 °C (50 °F) for transfer to the laboratory.

(iii) When sampling from an enclosed pipe is not feasible, a minimum of three representative samples shall be collected in a manner to minimize exposure of the sample to the atmosphere and loss of benzene prior to sampling.

(iv) Each waste sample shall be analyzed using one of the following test methods for determining the benzene concentration in a waste stream:

(A) Method 8020, Aromatic Volatile Organics, in "Test Methods for Evaluating Solid Waste, Physical/Chemical Methods," EPA Publication No. SW-846 (incorporation by reference as specified in §61.18 of this part);

(B) Method 8021, Volatile Organic Compounds in Water by Purge and Trap Capillary Column Gas Chromatography with Photoionization and Electrolytic Conductivity Detectors in Series in "Test Methods for Evaluating Solid Waste, Physical/Chemical Methods," EPA Publication No. SW-846 (incorporation by reference as specified in §61.18 of this part);

(C) Method 8240, Gas Chromatography/Mass Spectrometry for Volatile Organics in "Test Methods for Evaluating Solid Waste, Physical/Chemical Methods," EPA Publication No. SW-846 (incorporation by reference as specified in §61.18 of this part);

(D) Method 8260, Gas Chromatography/Mass Spectrometry for Volatile Organics: Capillary Column Technique in "Test Methods for Evaluating Solid Waste, Physical/Chemical Methods," EPA Publication No. SW-846 (incorporation by reference as specified in §61.18 of this part);

(E) Method 602, Purgeable Aromatics, as described in 40 CFR part 136, appendix A, Test Procedures for Analysis of Organic Pollutants, for wastewaters for which this is an approved EPA methods; or

(F) Method 624, Purgeables, as described in 40 CFR part 136, appendix A, Test Procedures for Analysis of Organic Pollutants, for wastewaters for which this is an approved EPA method.

(v) The flow-weighted annual average benzene concentration shall be calculated by averaging the results of the sample analyses as follows:

$$\bar{C} = \frac{1}{Q_t} \times \sum_{i=1}^n (Q_i)(C_i)$$

Where:

$\bar{C}$  = Flow-weighted annual average benzene concentration for waste stream, ppmw.

$Q_t$  = Total annual waste quantity for waste stream, kg/yr (lb/yr).

$n$  = Number of waste samples (at least 3).

$Q_i$  = Annual waste quantity for waste stream represented by  $C_i$ , kg/yr (lb/yr).

$C_i$  = Measured concentration of benzene in waste sample  $i$ , ppmw.

(d) An owner or operator using performance tests to demonstrate compliance of a treatment process with §61.348 (a)(1)(i) shall measure the flow-weighted annual average benzene concentration of the waste stream exiting the treatment process by collecting and analyzing a minimum of three representative samples of the waste stream using the procedures in paragraph (c)(3) of this section. The test shall be conducted under conditions that exist when the treatment process is operating at the highest inlet waste stream flow rate and benzene content expected to occur. Operations during periods of startup, shutdown, and malfunction shall not constitute representative conditions for the purpose of a test. The owner or operator shall record all process information as is necessary to document the operating conditions during the test.

(e) An owner or operator using performance tests to demonstrate compliance of a treatment process with §61.348(a)(1)(ii) of this subpart shall determine the percent reduction of benzene in the waste stream on a mass basis by the following procedure:

(1) The test shall be conducted under conditions that exist when the treatment process is operating at the highest inlet waste stream flow rate and benzene content expected to occur. Operations during periods of startup, shutdown, and malfunction shall not constitute representative conditions for the purpose of a test. The owner or operator shall record all process information as is necessary to document the operating conditions during the test.

(2) All testing equipment shall be prepared and installed as specified in the appropriate test methods.

(3) The mass flow rate of benzene entering the treatment process ( $E_b$ ) shall be determined by computing the product of the flow rate of the waste stream entering the treatment process, as determined by the inlet flow meter, and the benzene concentration of the waste stream, as determined using the

sampling and analytical procedures specified in paragraph (c)(2) or (c)(3) of this section. Three grab samples of the waste shall be taken at equally spaced time intervals over a 1-hour period. Each 1-hour period constitutes a run, and the performance test shall consist of a minimum of 3 runs conducted over a 3-hour period. The mass flow rate of benzene entering the treatment process is calculated as follows:

$$E_b = \frac{K}{n \times 10^6} \left[ \sum_{i=1}^n V_i C_i \right]$$

Where:

$E_b$  = Mass flow rate of benzene entering the treatment process, kg/hr (lb/hr).

$K$  = Density of the waste stream, kg/m<sup>3</sup> (lb/ft<sup>3</sup>).

$V_i$  = Average volume flow rate of waste entering the treatment process during each run  $i$ , m<sup>3</sup>/hr (ft<sup>3</sup>/hr).

$C_i$  = Average concentration of benzene in the waste stream entering the treatment process during each run  $i$ , ppmw.

$n$  = Number of runs.

$10^6$  = Conversion factor for ppmw.

(4) The mass flow rate of benzene exiting the treatment process ( $E_a$ ) shall be determined by computing the product of the flow rate of the waste stream exiting the treatment process, as determined by the outlet flow meter or the inlet flow meter, and the benzene concentration of the waste stream, as determined using the sampling and analytical procedures specified in paragraph (c)(2) or (c)(3) of this section. Three grab samples of the waste shall be taken at equally spaced time intervals over a 1-hour period. Each 1-hour period constitutes a run, and the performance test shall consist of a minimum of 3 runs conducted over the same 3-hour period at which the mass flow rate of benzene entering the treatment process is determined. The mass flow rate of benzene exiting the treatment process is calculated as follows:

$$E_a = \frac{K}{n \times 10^6} \left[ \sum_{i=1}^n V_i C_i \right]$$

Where:

$E_a$  = Mass flow rate of benzene exiting the treatment process, kg/hr (lb/hr).

$K$  = Density of the waste stream, kg/m<sup>3</sup> (lb/ft<sup>3</sup>).

$V_i$  = Average volume flow rate of waste exiting the treatment process during each run  $i$ , m<sup>3</sup>/hr (ft<sup>3</sup>/hr).

$C_i$  = Average concentration of benzene in the waste stream exiting the treatment process during each run  $i$ , ppmw.

$n$  = Number of runs.

$10^6$  = Conversion factor for ppmw.

(f) An owner or operator using performance tests to demonstrate compliance of a treatment process with §61.348(a)(1)(iii) of this subpart shall determine the benzene destruction efficiency for the combustion unit by the following procedure:

(1) The test shall be conducted under conditions that exist when the combustion unit is operating at the highest inlet waste stream flow rate and benzene content expected to occur. Operations during periods of startup, shutdown, and malfunction shall not constitute representative conditions for the

purpose of a test. The owner or operator shall record all process information necessary to document the operating conditions during the test.

(2) All testing equipment shall be prepared and installed as specified in the appropriate test methods.

(3) The mass flow rate of benzene entering the combustion unit shall be determined by computing the product of the flow rate of the waste stream entering the combustion unit, as determined by the inlet flow meter, and the benzene concentration of the waste stream, as determined using the sampling procedures in paragraph (c)(2) or (c)(3) of this section. Three grab samples of the waste shall be taken at equally spaced time intervals over a 1-hour period. Each 1-hour period constitutes a run, and the performance test shall consist of a minimum of 3 runs conducted over a 3-hour period. The mass flow rate of benzene into the combustion unit is calculated as follows:

$$E_b = \frac{K}{n \times 10^6} \left[ \sum_{i=1}^n V_i C_i \right]$$

Where:

$E_b$  = Mass flow rate of benzene entering the combustion unit, kg/hr (lb/hr).

$K$  = Density of the waste stream, kg/m<sup>3</sup> (lb/ft<sup>3</sup>).

$V_i$  = Average volume flow rate of waste entering the combustion unit during each run  $i$ , m<sup>3</sup>/hr (ft<sup>3</sup>/hr).

$C_i$  = Average concentration of benzene in the waste stream entering the combustion unit during each run  $i$ , ppmw.

$n$  = Number of runs.

$10^6$  = Conversion factor for ppmw.

(4) The mass flow rate of benzene exiting the combustion unit exhaust stack shall be determined as follows:

(i) The time period for the test shall not be less than 3 hours during which at least 3 stack gas samples are collected and be the same time period at which the mass flow rate of benzene entering the treatment process is determined. Each sample shall be collected over a 1-hour period (e.g., in a tedlar bag) to represent a time-integrated composite sample and each 1-hour period shall correspond to the periods when the waste feed is sampled.

(ii) A run shall consist of a 1-hour period during the test. For each run:

(A) The reading from each measurement shall be recorded;

(B) The volume exhausted shall be determined using Method 2, 2A, 2C, or 2D from appendix A of 40 CFR part 60, as appropriate.

(C) The average benzene concentration in the exhaust downstream of the combustion unit shall be determined using Method 18 from appendix A of 40 CFR part 60.

(iii) The mass of benzene emitted during each run shall be calculated as follows:

$$M_i = D_b VC(10^{-6})$$

Where:

$M_i$  = Mass of benzene emitted during run  $i$ , kg (lb).

$V$  = Volume of air-vapor mixture exhausted at standard conditions,  $m^3$  ( $ft^3$ ).

$C$  = Concentration of benzene measured in the exhaust, ppmv.

$D_b$  = Density of benzene,  $3.24 \text{ kg}/m^3$  ( $0.202 \text{ lb}/ft^3$ ).

$10^6$  = Conversion factor for ppmv.

(iv) The benzene mass emission rate in the exhaust shall be calculated as follows:

$$E_a = \left( \sum_{i=1}^n M_i \right) / T$$

Where:

$E_a$  = Mass flow rate of benzene emitted from the combustion unit, kg/hr (lb/hr).

$M_i$  = Mass of benzene emitted from the combustion unit during run  $i$ , kg (lb).

$T$  = Total time of all runs, hr.

$n$  = Number of runs.

(5) The benzene destruction efficiency for the combustion unit shall be calculated as follows:

$$R = \frac{E_b - E_a}{E_b} \times 100$$

Where:

$R$  = Benzene destruction efficiency for the combustion unit, percent.

$E_b$  = Mass flow rate of benzene entering the combustion unit, kg/hr (lb/hr).

$E_a$  = Mass flow rate of benzene emitted from the combustion unit, kg/hr (lb/hr).

(g) An owner or operator using performance tests to demonstrate compliance of a wastewater treatment system unit with §61.348(b) shall measure the flow-weighted annual average benzene concentration of the wastewater stream where the waste stream enters an exempt waste management unit by collecting and analyzing a minimum of three representative samples of the waste stream using the procedures in paragraph (c)(3) of this section. The test shall be conducted under conditions that exist when the wastewater treatment system is operating at the highest inlet wastewater stream flow rate and benzene content expected to occur. Operations during periods of startup, shutdown, and malfunction shall not constitute representative conditions for the purpose of a test. The owner or operator shall record all process information as is necessary to document the operating conditions during the test.

(h) An owner or operator shall test equipment for compliance with no detectable emissions as required in §§61.343 through 61.347, and §61.349 of this subpart in accordance with the following requirements:

(1) Monitoring shall comply with Method 21 from appendix A of 40 CFR part 60.

(2) The detection instrument shall meet the performance criteria of Method 21.

(3) The instrument shall be calibrated before use on each day of its use by the procedures specified in Method 21.

(4) Calibration gases shall be:

(i) Zero air (less than 10 ppm of hydrocarbon in air); and

(ii) A mixture of methane or n-hexane and air at a concentration of approximately, but less than, 10,000 ppm methane or n-hexane.

(5) The background level shall be determined as set forth in Method 21.

(6) The instrument probe shall be traversed around all potential leak interfaces as close as possible to the interface as described in Method 21.

(7) The arithmetic difference between the maximum concentration indicated by the instrument and the background level is compared to 500 ppm for determining compliance.

(i) An owner or operator using a performance test to demonstrate compliance of a control device with either the organic reduction efficiency requirement or the benzene reduction efficiency requirement specified under §61.349(a)(2) shall use the following procedures:

(1) The test shall be conducted under conditions that exist when the waste management unit vented to the control device is operating at the highest load or capacity level expected to occur. Operations during periods of startup, shutdown, and malfunction shall not constitute representative conditions for the purpose of a test. The owner or operator shall record all process information necessary to document the operating conditions during the test.

(2) Sampling sites shall be selected using Method 1 or 1A from appendix A of 40 CFR part 60, as appropriate.

(3) The mass flow rate of either the organics or benzene entering and exiting the control device shall be determined as follows:

(i) The time period for the test shall not be less than 3 hours during which at least 3 stack gas samples are collected. Samples of the vent stream entering and exiting the control device shall be collected during the same time period. Each sample shall be collected over a 1-hour period (e.g., in a tedlar bag) to represent a time-integrated composite sample.

(ii) A run shall consist of a 1-hour period during the test. For each run:

(A) The reading from each measurement shall be recorded;

(B) The volume exhausted shall be determined using Method 2, 2A, 2C, or 2D from appendix A of 40 CFR part 60, as appropriate;

(C) The organic concentration or the benzene concentration, as appropriate, in the vent stream entering and exiting the control shall be determined using Method 18 from appendix A of 40 CFR part 60.



(iii) The mass of organics or benzene entering and exiting the control device during each run shall be calculated as follows:

$$M_{aj} = \frac{K_1 V_{aj}}{10^6} \left( \sum_{i=1}^n C_{ai} MW_i \right)$$

$$M_{bj} = \frac{K_1 V_{bj}}{10^6} \left( \sum_{i=1}^n C_{bi} MW_i \right)$$

$M_{aj}$  = Mass of organics or benzene in the vent stream entering the control device during run j, kg (lb).

$M_{bj}$  = Mass of organics or benzene in the vent stream exiting the control device during run j, kg (lb).

$V_{aj}$  = Volume of vent stream entering the control device during run j, at standard conditions, m<sup>3</sup> (ft<sup>3</sup>).

$V_{bj}$  = Volume of vent stream exiting the control device during run j, at standard conditions, m<sup>3</sup> (ft<sup>3</sup>).

$C_{ai}$  = Organic concentration of compound i or the benzene concentration measured in the vent stream entering the control device as determined by Method 18, ppm by volume on a dry basis.

$C_{bi}$  = Organic concentration of compound i or the benzene concentration measured in the vent stream exiting the control device as determined by Method 18, ppm by volume on a dry basis.

$MW_i$  = Molecular weight of organic compound i in the vent stream, or the molecular weight of benzene, kg/kg-mol (lb/lb-mole).

n = Number of organic compounds in the vent stream; if benzene reduction efficiency is being demonstrated, then n = 1.

$K_1$  = Conversion factor for molar volume at standard conditions (293 K and 760 mm Hg (527 R and 14.7 psia))  
= 0.0416 kg-mol/m<sup>3</sup> (0.00118 lb-mol/ft<sup>3</sup>)

10<sup>-6</sup> = Conversion factor for ppmv.

(iv) The mass flow rate of organics or benzene entering and exiting the control device shall be calculated as follows:

$$E_a = \left( \sum_{j=1}^n M_{aj} \right) / T$$

$$E_b = \left( \sum_{j=1}^n M_{bj} \right) / T$$

Where:

$E_a$  = Mass flow rate of organics or benzene entering the control device, kg/hr (lb/hr).

$E_b$  = Mass flow rate of organics or benzene exiting the control device, kg/hr (lb/hr).

$M_{aj}$  = Mass of organics or benzene in the vent stream entering the control device during run j, kg (lb).

$M_{bj}$  = Mass of organics or benzene in the vent stream exiting the control device during run j, kg (lb).

T = Total time of all runs, hr.

n = Number of runs.

(4) The organic reduction efficiency or the benzene reduction efficiency for the control device shall be calculated as follows:

$$R = \frac{E_a - E_b}{E_a} \times 100$$

Where:

R = Total organic reduction of efficiency or benzene reduction efficiency for the control device, percent.

E<sub>b</sub> = Mass flow rate of organics or benzene entering the control device, kg/hr (lb/hr).

E<sub>a</sub> = Mass flow rate of organic or benzene emitted from the control device, kg/hr (lb/hr).

(j) An owner or operator shall determine the benzene quantity for the purposes of the calculation required by §61.342 (c)(3)(ii)(B) according to the provisions of paragraph (a) of this section, except that the procedures in paragraph (a) of this section shall also apply to wastes with a water content of 10 percent or less.

(k) An owner or operator shall determine the benzene quantity for the purposes of the calculation required by §61.342(e)(2) by the following procedure:

(1) For each waste stream that is not controlled for air emissions in accordance with §61.343, 61.344, 61.345, 61.346, 61.347, or 61.348(a), as applicable to the waste management unit that manages the waste, the benzene quantity shall be determined as specified in paragraph (a) of this section, except that paragraph (b)(4) of this section shall not apply, i.e., the waste quantity for process unit turnaround waste is not annualized but shall be included in the determination of benzene quantity for the year in which the waste is generated for the purposes of the calculation required by §61.342(e)(2).

(2) For each waste stream that is controlled for air emissions in accordance with §61.343, 61.344, 61.345, 61.346, 61.347, or 61.348(a), as applicable to the waste management unit that manages the waste, the determination of annual waste quantity and flow-weighted annual average benzene concentration shall be made at the first applicable location as described in paragraphs (k)(2)(i), (k)(2)(ii), and (k)(2)(iii) of this section and prior to any reduction of benzene concentration through volatilization of the benzene, using the methods given in (k)(2)(iv) and (k)(2)(v) of this section.

(i) Where the waste stream enters the first waste management unit not complying with §§61.343, 61.344, 61.345, 61.346, 61.347, and 61.348(a) that are applicable to the waste management unit,

(ii) For each waste stream that is managed (i) or treated only in compliance with §§61.343 through 61.348(a) up to the point of final direct discharge from the facility, the determination of benzene quantity shall be prior to any reduction of benzene concentration through volatilization of the benzene, or

(iii) For wastes managed in units controlled for air emissions in accordance with §§61.343, 61.344, 61.345, 61.346, 61.347, and 61.348(a), and then transferred offsite, facilities shall use the first applicable offsite location as described in paragraphs (k)(2)(i) and (k)(2)(ii) of this section if they have documentation from the offsite facility of the benzene quantity at this location. Facilities without this documentation for offsite wastes shall use the benzene quantity determined at the point where the transferred waste leaves the facility.

(iv) Annual waste quantity shall be determined using the procedures in paragraphs (b)(5), (6), or (7) of this section, and

(v) The flow-weighted annual average benzene concentration shall be determined using the procedures in paragraphs (c)(2) or (3) of this section.

(3) The benzene quantity in a waste stream that is generated less than one time per year, including process unit turnaround waste, shall be included in the determination of benzene quantity as determined in paragraph (k)(6) of this section for the year in which the waste is generated. The benzene quantity in this waste stream shall not be annualized or averaged over the time interval between the activities that resulted in generation of the waste for purposes of determining benzene quantity as determined in paragraph (k)(6) of this section.

(4) The benzene in waste entering an enhanced biodegradation unit, as defined in §61.348(b)(2)(ii)(B), shall not be included in the determination of benzene quantity, determined in paragraph (k)(6) of this section, if the following conditions are met:

(i) The benzene concentration for each waste stream entering the enhanced biodegradation unit is less than 10 ppmw on a flow-weighted annual average basis, and

(ii) All prior waste management units managing the waste comply with §§61.343, 61.344, 61.345, 61.346, 61.347 and 61.348(a).

(5) The benzene quantity for each waste stream in paragraph (k)(2) of this section shall be determined by multiplying the annual waste quantity of each waste stream times its flow-weighted annual average benzene concentration.

(6) The total benzene quantity for the purposes of the calculation required by §61.342(e)(2) shall be determined by adding together the benzene quantities determined in paragraphs (k)(1) and (k)(5) of this section for each applicable waste stream.

(7) If the benzene quantity determined in paragraph (6) of this section exceeds 6.0 Mg/yr (6.6 ton/yr) only because of multiple counting of the benzene quantity for a waste stream, the owner or operator may use the following procedures for the purposes of the calculation required by §61.342(e)(2):

(i) Determine which waste management units are involved in the multiple counting of benzene;

(ii) Determine the quantity of benzene that is emitted, recovered, or removed from the affected units identified in paragraph (k)(7)(i) of this section, or destroyed in the units if applicable, using either direct measurements or the best available estimation techniques developed or approved by the Administrator.

(iii) Adjust the benzene quantity to eliminate the multiple counting of benzene based on the results from paragraph (k)(7)(ii) of this section and determine the total benzene quantity for the purposes of the calculation required by §61.342(e)(2).

(iv) Submit in the annual report required under §61.357(a) a description of the methods used and the resulting calculations for the alternative procedure under paragraph (k)(7) of this section, the benzene quantity determination from paragraph (k)(6) of this section, and the adjusted benzene quantity determination from paragraph (k)(7)(iii) of this section.

[55 FR 8346, Mar. 7, 1990; 55 FR 12444, Apr. 3, 1990, as amended at 55 FR 37231, Sept. 10, 1990; 58 FR 3099, Jan. 7, 1993; 65 FR 62160, Oct. 17, 2000]

#### **§61.356 Recordkeeping requirements.**

(a) Each owner or operator of a facility subject to the provisions of this subpart shall comply with the recordkeeping requirements of this section. Each record shall be maintained in a readily accessible location at the facility site for a period not less than two years from the date the information is recorded unless otherwise specified.

(b) Each owner or operator shall maintain records that identify each waste stream at the facility subject to this subpart, and indicate whether or not the waste stream is controlled for benzene emissions in accordance with this subpart. In addition the owner or operator shall maintain the following records:

(1) For each waste stream not controlled for benzene emissions in accordance with this subpart, the records shall include all test results, measurements, calculations, and other documentation used to determine the following information for the waste stream: waste stream identification, water content, whether or not the waste stream is a process wastewater stream, annual waste quantity, range of benzene concentrations, annual average flow-weighted benzene concentration, and annual benzene quantity.

(2) For each waste stream exempt from §61.342(c)(1) in accordance with §61.342(c)(3), the records shall include:

(i) All measurements, calculations, and other documentation used to determine that the continuous flow of process wastewater is less than 0.02 liters (0.005 gallons) per minute or the annual waste quantity of process wastewater is less than 10 Mg/yr (11 ton/yr) in accordance with §61.342(c)(3)(i), or

(ii) All measurements, calculations, and other documentation used to determine that the sum of the total annual benzene quantity in all exempt waste streams does not exceed 2.0 Mg/yr (2.2 ton/yr) in accordance with §61.342(c)(3)(ii).

(3) For each facility where process wastewater streams are controlled for benzene emissions in accordance with §61.342(d) of this subpart, the records shall include for each treated process wastewater stream all measurements, calculations, and other documentation used to determine the annual benzene quantity in the process wastewater stream exiting the treatment process.

(4) For each facility where waste streams are controlled for benzene emissions in accordance with §61.342(e), the records shall include for each waste stream all measurements, including the locations of the measurements, calculations, and other documentation used to determine that the total benzene quantity does not exceed 6.0 Mg/yr (6.6 ton/yr).

(5) For each facility where the annual waste quantity for process unit turnaround waste is determined in accordance with §61.355(b)(5), the records shall include all test results, measurements, calculations, and other documentation used to determine the following information: identification of each process unit at the facility that undergoes turnarounds, the date of the most recent turnaround for each process unit, identification of each process unit turnaround waste, the water content of each process unit turnaround waste, the annual waste quantity determined in accordance with §61.355(b)(5), the range of benzene concentrations in the waste, the annual average flow-weighted benzene concentration of the waste, and the annual benzene quantity calculated in accordance with §61.355(a)(1)(iii) of this section.

(6) For each facility where wastewater streams are controlled for benzene emissions in accordance with §61.348(b)(2), the records shall include all measurements, calculations, and other documentation used to determine the annual benzene content of the waste streams and the total annual benzene quantity contained in all waste streams managed or treated in exempt waste management units.

(c) An owner or operator transferring waste off-site to another facility for treatment in accordance with §61.342(f) shall maintain documentation for each offsite waste shipment that includes the following

information: Date waste is shipped offsite, quantity of waste shipped offsite, name and address of the facility receiving the waste, and a copy of the notice sent with the waste shipment.

(d) An owner or operator using control equipment in accordance with §§61.343 through 61.347 shall maintain engineering design documentation for all control equipment that is installed on the waste management unit. The documentation shall be retained for the life of the control equipment. If a control device is used, then the owner or operator shall maintain the control device records required by paragraph (f) of this section.

(e) An owner or operator using a treatment process or wastewater treatment system unit in accordance with §61.348 of this subpart shall maintain the following records. The documentation shall be retained for the life of the unit.

(1) A statement signed and dated by the owner or operator certifying that the unit is designed to operate at the documented performance level when the waste stream entering the unit is at the highest waste stream flow rate and benzene content expected to occur.

(2) If engineering calculations are used to determine treatment process or wastewater treatment system unit performance, then the owner or operator shall maintain the complete design analysis for the unit. The design analysis shall include for example the following information: Design specifications, drawings, schematics, piping and instrumentation diagrams, and other documentation necessary to demonstrate the unit performance.

(3) If performance tests are used to determine treatment process or wastewater treatment system unit performance, then the owner or operator shall maintain all test information necessary to demonstrate the unit performance.

(i) A description of the unit including the following information: type of treatment process; manufacturer name and model number; and for each waste stream entering and exiting the unit, the waste stream type (e.g., process wastewater, sludge, slurry, etc.), and the design flow rate and benzene content.

(ii) Documentation describing the test protocol and the means by which sampling variability and analytical variability were accounted for in the determination of the unit performance. The description of the test protocol shall include the following information: sampling locations, sampling method, sampling frequency, and analytical procedures used for sample analysis.

(iii) Records of unit operating conditions during each test run including all key process parameters.

(iv) All test results.

(4) If a control device is used, then the owner or operator shall maintain the control device records required by paragraph (f) of this section.

(f) An owner or operator using a closed-vent system and control device in accordance with §61.349 of this subpart shall maintain the following records. The documentation shall be retained for the life of the control device.

(1) A statement signed and dated by the owner or operator certifying that the closed-vent system and control device is designed to operate at the documented performance level when the waste management unit vented to the control device is or would be operating at the highest load or capacity expected to occur.

(2) If engineering calculations are used to determine control device performance in accordance with §61.349(c), then a design analysis for the control device that includes for example:

(i) Specifications, drawings, schematics, and piping and instrumentation diagrams prepared by the owner or operator, or the control device manufacturer or vendor that describe the control device design based on acceptable engineering texts. The design analysis shall address the following vent stream characteristics and control device operating parameters:

(A) For a thermal vapor incinerator, the design analysis shall consider the vent stream composition, constituent concentrations, and flow rate. The design analysis shall also establish the design minimum and average temperature in the combustion zone and the combustion zone residence time.

(B) For a catalytic vapor incinerator, the design analysis shall consider the vent stream composition, constituent concentrations, and flow rate. The design analysis shall also establish the design minimum and average temperatures across the catalyst bed inlet and outlet.

(C) For a boiler or process heater, the design analysis shall consider the vent stream composition, constituent concentrations, and flow rate. The design analysis shall also establish the design minimum and average flame zone temperatures, combustion zone residence time, and description of method and location where the vent stream is introduced into the flame zone.

(D) For a flare, the design analysis shall consider the vent stream composition, constituent concentrations, and flow rate. The design analysis shall also consider the requirements specified in 40 CFR 60.18.

(E) For a condenser, the design analysis shall consider the vent stream composition, constituent concentration, flow rate, relative humidity, and temperature. The design analysis shall also establish the design outlet organic compound concentration level or the design outlet benzene concentration level, design average temperature of the condenser exhaust vent stream, and the design average temperatures of the coolant fluid at the condenser inlet and outlet.

(F) For a carbon adsorption system that regenerates the carbon bed directly on-site in the control device such as a fixed-bed adsorber, the design analysis shall consider the vent stream composition, constituent concentration, flow rate, relative humidity, and temperature. The design analysis shall also establish the design exhaust vent stream organic compound concentration level or the design exhaust vent stream benzene concentration level, number and capacity of carbon beds, type and working capacity of activated carbon used for carbon beds, design total steam flow over the period of each complete carbon bed regeneration cycle, duration of the carbon bed steaming and cooling/drying cycles, design carbon bed temperature after regeneration, design carbon bed regeneration time, and design service life of carbon.

(G) For a carbon adsorption system that does not regenerate the carbon bed directly on-site in the control device, such as a carbon canister, the design analysis shall consider the vent stream composition, constituent concentration, flow rate, relative humidity, and temperature. The design analysis shall also establish the design exhaust vent stream organic compound concentration level or the design exhaust vent stream benzene concentration level, capacity of carbon bed, type and working capacity of activated carbon used for carbon bed, and design carbon replacement interval based on the total carbon working capacity of the control device and source operating schedule.

(H) For a control device subject to the requirements of §61.349(a)(2)(iv), the design analysis shall consider the vent stream composition, constituent concentration, and flow rate. The design analysis shall also include all of the information submitted under §61.349 (a)(2)(iv).

(ii) [Reserved]

(3) If performance tests are used to determine control device performance in accordance with §61.349(c) of this subpart:

(i) A description of how it is determined that the test is conducted when the waste management unit or treatment process is operating at the highest load or capacity level. This description shall include the estimated or design flow rate and organic content of each vent stream and definition of the acceptable operating ranges of key process and control parameters during the test program.

(ii) A description of the control device including the type of control device, control device manufacturer's name and model number, control device dimensions, capacity, and construction materials.

(iii) A detailed description of sampling and monitoring procedures, including sampling and monitoring locations in the system, the equipment to be used, sampling and monitoring frequency, and planned analytical procedures for sample analysis.

(iv) All test results.

(g) An owner or operator shall maintain a record for each visual inspection required by §§61.343 through 61.347 of this subpart that identifies a problem (such as a broken seal, gap or other problem) which could result in benzene emissions. The record shall include the date of the inspection, waste management unit and control equipment location where the problem is identified, a description of the problem, a description of the corrective action taken, and the date the corrective action was completed.

(h) An owner or operator shall maintain a record for each test of no detectable emissions required by §§61.343 through 61.347 and §61.349 of this subpart. The record shall include the following information: date the test is performed, background level measured during test, and maximum concentration indicated by the instrument reading measured for each potential leak interface. If detectable emissions are measured at a leak interface, then the record shall also include the waste management unit, control equipment, and leak interface location where detectable emissions were measured, a description of the problem, a description of the corrective action taken, and the date the corrective action was completed.

(i) For each treatment process and wastewater treatment system unit operated to comply with §61.348, the owner or operator shall maintain documentation that includes the following information regarding the unit operation:

(1) Dates of startup and shutdown of the unit.

(2) If measurements of waste stream benzene concentration are performed in accordance with §61.354(a)(1) of this subpart, the owner or operator shall maintain records that include date each test is performed and all test results.

(3) If a process parameter is continuously monitored in accordance with §61.354(a)(2) of this subpart, the owner or operator shall maintain records that include a description of the operating parameter (or parameters) to be monitored to ensure that the unit will be operated in conformance with these standards and the unit's design specifications, and an explanation of the criteria used for selection of that parameter (or parameters). This documentation shall be kept for the life of the unit.

(4) If measurements of waste stream benzene concentration are performed in accordance with §61.354(b), the owner or operator shall maintain records that include the date each test is performed and all test results.

(5) Periods when the unit is not operated as designed.

(j) For each control device, the owner or operator shall maintain documentation that includes the following information regarding the control device operation:

(1) Dates of startup and shutdown of the closed-vent system and control device.

(2) A description of the operating parameter (or parameters) to be monitored to ensure that the control device will be operated in conformance with these standards and the control device's design specifications and an explanation of the criteria used for selection of that parameter (or parameters). This documentation shall be kept for the life of the control device.

(3) Periods when the closed-vent system and control device are not operated as designed including all periods and the duration when:

(i) Any valve car-seal or closure mechanism required under §61.349(a)(1)(ii) is broken or the bypass line valve position has changed.

(ii) The flow monitoring devices required under §61.349(a)(1)(ii) indicate that vapors are not routed to the control device as required.

(4) If a thermal vapor incinerator is used, then the owner or operator shall maintain continuous records of the temperature of the gas stream in the combustion zone of the incinerator and records of all 3-hour periods of operation during which the average temperature of the gas stream in the combustion zone is more than 28 °C (50 °F) below the design combustion zone temperature.

(5) If a catalytic vapor incinerator is used, then the owner or operator shall maintain continuous records of the temperature of the gas stream both upstream and downstream of the catalyst bed of the incinerator, records of all 3-hour periods of operation during which the average temperature measured before the catalyst bed is more than 28 °C (50 °F) below the design gas stream temperature, and records of all 3-hour periods of operation during which the average temperature difference across the catalyst bed is less than 80 percent of the design temperature difference.

(6) If a boiler or process heater is used, then the owner or operator shall maintain records of each occurrence when there is a change in the location at which the vent stream is introduced into the flame zone as required by §61.349(a)(2)(i)(C). For a boiler or process heater having a design heat input capacity less than 44 MW (150 × 10<sup>6</sup> BTU/hr), the owner or operator shall maintain continuous records of the temperature of the gas stream in the combustion zone of the boiler or process heater and records of all 3-hour periods of operation during which the average temperature of the gas stream in the combustion zone is more than 28 °C (50 °F) below the design combustion zone temperature. For a boiler or process heater having a design heat input capacity greater than or equal to 44 MW (150 × 10<sup>6</sup> BTU/hr), the owner or operator shall maintain continuous records of the parameter(s) monitored in accordance with the requirements of §61.354(c)(5).

(7) If a flare is used, then the owner or operator shall maintain continuous records of the flare pilot flame monitoring and records of all periods during which the pilot flame is absent.

(8) If a condenser is used, then the owner or operator shall maintain records from the monitoring device of the parameters selected to be monitored in accordance with §61.354(c)(6). If concentration of organics or concentration of benzene in the control device outlet gas stream is monitored, then the owner or operator shall record all 3-hour periods of operation during which the concentration of organics or the concentration of benzene in the exhaust stream is more than 20 percent greater than the design value. If the temperature of the condenser exhaust stream and coolant fluid is monitored, then the owner or operator shall record all 3-hour periods of operation during which the temperature of the condenser exhaust vent stream is more than 6 °C (11 °F) above the design average exhaust vent stream



temperature, or the temperature of the coolant fluid exiting the condenser is more than 6 °C (11 °F) above the design average coolant fluid temperature at the condenser outlet.

(9) If a carbon adsorber is used, then the owner or operator shall maintain records from the monitoring device of the concentration of organics or the concentration of benzene in the control device outlet gas stream. If the concentration of organics or the concentration of benzene in the control device outlet gas stream is monitored, then the owner or operator shall record all 3-hour periods of operation during which the concentration of organics or the concentration of benzene in the exhaust stream is more than 20 percent greater than the design value. If the carbon bed regeneration interval is monitored, then the owner or operator shall record each occurrence when the vent stream continues to flow through the control device beyond the predetermined carbon bed regeneration time.

(10) If a carbon adsorber that is not regenerated directly on site in the control device is used, then the owner or operator shall maintain records of dates and times when the control device is monitored, when breakthrough is measured, and shall record the date and time then the existing carbon in the control device is replaced with fresh carbon.

(11) If an alternative operational or process parameter is monitored for a control device, as allowed in §61.354(e) of this subpart, then the owner or operator shall maintain records of the continuously monitored parameter, including periods when the device is not operated as designed.

(12) If a control device subject to the requirements of §61.349(a)(2)(iv) is used, then the owner or operator shall maintain records of the parameters that are monitored and each occurrence when the parameters monitored are outside the range of values specified in §61.349(a)(2)(iv)(C), or other records as specified by the Administrator.

(k) An owner or operator who elects to install and operate the control equipment in §61.351 of this subpart shall comply with the recordkeeping requirements in 40 CFR 60.115b.

(l) An owner or operator who elects to install and operate the control equipment in §61.352 of this subpart shall maintain records of the following:

(1) The date, location, and corrective action for each visual inspection required by 40 CFR 60.693-2(a)(5), during which a broken seal, gap, or other problem is identified that could result in benzene emissions.

(2) Results of the seal gap measurements required by 40 CFR 60.693-2(a).

(m) If a system is used for emission control that is maintained at a pressure less than atmospheric pressure with openings to provide dilution air, then the owner or operator shall maintain records of the monitoring device and records of all periods during which the pressure in the unit is operated at a pressure that is equal to or greater than atmospheric pressure.

(n) Each owner or operator using a total enclosure to comply with control requirements for tanks in §61.343 or the control requirements for containers in §61.345 must keep the records required in paragraphs (n)(1) and (2) of this section. Owners or operators may use records as required in 40 CFR 264.1089(b)(2)(iv) or 40 CFR 265.1090(b)(2)(iv) for a tank or as required in 40 CFR 264.1089(d)(1) or 40 CFR 265.1090(d)(1) for a container to meet the recordkeeping requirement in paragraph (n)(1) of this section. The owner or operator must make the records of each verification of a total enclosure available for inspection upon request.

(1) Records of the most recent set of calculations and measurements performed to verify that the enclosure meets the criteria of a permanent total enclosure as specified in "Procedure T—Criteria for and Verification of a Permanent or Temporary Total Enclosure" in 40 CFR 52.741, appendix B;

(2) Records required for a closed-vent system and control device according to the requirements in paragraphs (d) (f), and (j) of this section.

[55 FR 8346, Mar. 7, 1990; 55 FR 12444, Apr. 3, 1990; 55 FR 18331, May 2, 1990, as amended at 58 FR 3103, Jan. 7, 1993; 65 FR 62161, Oct. 17, 2000; 67 FR 68533, Nov. 12, 2002]

### **§61.357 Reporting requirements.**

(a) Each owner or operator of a chemical plant, petroleum refinery, coke by-product recovery plant, and any facility managing wastes from these industries shall submit to the Administrator within 90 days after January 7, 1993, or by the initial startup for a new source with an initial startup after the effective date, a report that summarizes the regulatory status of each waste stream subject to §61.342 and is determined by the procedures specified in §61.355(c) to contain benzene. Each owner or operator subject to this subpart who has no benzene onsite in wastes, products, by-products, or intermediates shall submit an initial report that is a statement to this effect. For all other owners or operators subject to this subpart, the report shall include the following information:

(1) Total annual benzene quantity from facility waste determined in accordance with §61.355(a) of this subpart.

(2) A table identifying each waste stream and whether or not the waste stream will be controlled for benzene emissions in accordance with the requirements of this subpart.

(3) For each waste stream identified as not being controlled for benzene emissions in accordance with the requirements of this subpart the following information shall be added to the table:

(i) Whether or not the water content of the waste stream is greater than 10 percent;

(ii) Whether or not the waste stream is a process wastewater stream, product tank drawdown, or landfill leachate;

(iii) Annual waste quantity for the waste stream;

(iv) Range of benzene concentrations for the waste stream;

(v) Annual average flow-weighted benzene concentration for the waste stream; and

(vi) Annual benzene quantity for the waste stream.

(4) The information required in paragraphs (a) (1), (2), and (3) of this section should represent the waste stream characteristics based on current configuration and operating conditions. An owner or operator only needs to list in the report those waste streams that contact materials containing benzene. The report does not need to include a description of the controls to be installed to comply with the standard or other information required in §61.10(a).

(b) If the total annual benzene quantity from facility waste is less than 1 Mg/yr (1.1 ton/yr), then the owner or operator shall submit to the Administrator a report that updates the information listed in paragraphs (a)(1) through (a)(3) of this section whenever there is a change in the process generating the

waste stream that could cause the total annual benzene quantity from facility waste to increase to 1 Mg/yr (1.1 ton/yr) or more.

(c) If the total annual benzene quantity from facility waste is less than 10 Mg/yr (11 ton/yr) but is equal to or greater than 1 Mg/yr (1.1 ton/yr), then the owner or operator shall submit to the Administrator a report that updates the information listed in paragraphs (a)(1) through (a)(3) of this section. The report shall be submitted annually and whenever there is a change in the process generating the waste stream that could cause the total annual benzene quantity from facility waste to increase to 10 Mg/yr (11 ton/yr) or more. If the information in the annual report required by paragraphs (a)(1) through (a)(3) of this section is not changed in the following year, the owner or operator may submit a statement to that effect.

(d) If the total annual benzene quantity from facility waste is equal to or greater than 10 Mg/yr (11 ton/yr), then the owner or operator shall submit to the Administrator the following reports:

(1) Within 90 days after January 7, 1993, unless a waiver of compliance under §61.11 of this part is granted, or by the date of initial startup for a new source with an initial startup after the effective date, a certification that the equipment necessary to comply with these standards has been installed and that the required initial inspections or tests have been carried out in accordance with this subpart. If a waiver of compliance is granted under §61.11, the certification of equipment necessary to comply with these standards shall be submitted by the date the waiver of compliance expires.

(2) Beginning on the date that the equipment necessary to comply with these standards has been certified in accordance with paragraph (d)(1) of this section, the owner or operator shall submit annually to the Administrator a report that updates the information listed in paragraphs (a)(1) through (a)(3) of this section. If the information in the annual report required by paragraphs (a)(1) through (a)(3) of this section is not changed in the following year, the owner or operator may submit a statement to that effect.

(3) If an owner or operator elects to comply with the requirements of §61.342(c)(3)(ii), then the report required by paragraph (d)(2) of this section shall include a table identifying each waste stream chosen for exemption and the total annual benzene quantity in these exempted streams.

(4) If an owner or operator elects to comply with the alternative requirements of §61.342(d) of this subpart, then he shall include in the report required by paragraph (d)(2) of this section a table presenting the following information for each process wastewater stream:

(i) Whether or not the process wastewater stream is being controlled for benzene emissions in accordance with the requirements of this subpart;

(ii) For each process wastewater stream identified as not being controlled for benzene emissions in accordance with the requirements of this subpart, the table shall report the following information for the process wastewater stream as determined at the point of waste generation: annual waste quantity, range of benzene concentrations, annual average flow-weighted benzene concentration, and annual benzene quantity;

(iii) For each process wastewater stream identified as being controlled for benzene emissions in accordance with the requirements of this subpart, the table shall report the following information for the process wastewater stream as determined at the exit to the treatment process: Annual waste quantity, range of benzene concentrations, annual average flow-weighted benzene concentration, and annual benzene quantity.

(5) If an owner or operator elects to comply with the alternative requirements of §61.342(e), then the report required by paragraph (d)(2) of this section shall include a table presenting the following information for each waste stream:

(i) For each waste stream identified as not being controlled for benzene emissions in accordance with the requirements of this subpart; the table shall report the following information for the waste stream as determined at the point of waste generation: annual waste quantity, range of benzene concentrations, annual average flow-weighted benzene concentration, and annual benzene quantity;

(ii) For each waste stream identified as being controlled for benzene emissions in accordance with the requirements of this subpart; the table shall report the following information for the waste stream as determined at the applicable location described in §61.355(k)(2): Annual waste quantity, range of benzene concentrations, annual average flow-weighted benzene concentration, and annual benzene quantity.

(6) Beginning 3 months after the date that the equipment necessary to comply with these standards has been certified in accordance with paragraph (d)(1) of this section, the owner or operator shall submit quarterly to the Administrator a certification that all of the required inspections have been carried out in accordance with the requirements of this subpart.

(7) Beginning 3 months after the date that the equipment necessary to comply with these standards has been certified in accordance with paragraph (d)(1) of this section, the owner or operator shall submit a report quarterly to the Administrator that includes:

(i) If a treatment process or wastewater treatment system unit is monitored in accordance with §61.354(a)(1) of this subpart, then each period of operation during which the concentration of benzene in the monitored waste stream exiting the unit is equal to or greater than 10 ppmw.

(ii) If a treatment process or wastewater treatment system unit is monitored in accordance with §61.354(a)(2) of this subpart, then each 3-hour period of operation during which the average value of the monitored parameter is outside the range of acceptable values or during which the unit is not operating as designed.

(iii) If a treatment process or wastewater treatment system unit is monitored in accordance with §61.354(b), then each period of operation during which the flow-weighted annual average concentration of benzene in the monitored waste stream entering the unit is equal to or greater than 10 ppmw and/or the total annual benzene quantity is equal to or greater than 1.0 mg/yr.

(iv) For a control device monitored in accordance with §61.354(c) of this subpart, each period of operation monitored during which any of the following conditions occur, as applicable to the control device:

(A) Each 3-hour period of operation during which the average temperature of the gas stream in the combustion zone of a thermal vapor incinerator, as measured by the temperature monitoring device, is more than 28 °C (50 °F) below the design combustion zone temperature.

(B) Each 3-hour period of operation during which the average temperature of the gas stream immediately before the catalyst bed of a catalytic vapor incinerator, as measured by the temperature monitoring device, is more than 28 °C (50 °F) below the design gas stream temperature, and any 3-hour period during which the average temperature difference across the catalyst bed (i.e., the difference between the temperatures of the gas stream immediately before and after the catalyst bed), as measured by the temperature monitoring device, is less than 80 percent of the design temperature difference.

(C) Each 3-hour period of operation during which the average temperature of the gas stream in the combustion zone of a boiler or process heater having a design heat input capacity less than 44 MW (150 × 10<sup>6</sup> BTU/hr), as measured by the temperature monitoring device, is more than 28 °C (50 °F) below the design combustion zone temperature.

(D) Each 3-hour period of operation during which the average concentration of organics or the average concentration of benzene in the exhaust gases from a carbon adsorber, condenser, or other vapor recovery system is more than 20 percent greater than the design concentration level of organics or benzene in the exhaust gas.

(E) Each 3-hour period of operation during which the temperature of the condenser exhaust vent stream is more than 6 °C (11 °F) above the design average exhaust vent stream temperature, or the temperature of the coolant fluid exiting the condenser is more than 6 °C (11 °F) above the design average coolant fluid temperature at the condenser outlet.

(F) Each period in which the pilot flame of a flare is absent.

(G) Each occurrence when there is a change in the location at which the vent stream is introduced into the flame zone of a boiler or process heater as required by §61.349(a)(2)(i)(C) of this subpart.

(H) Each occurrence when the carbon in a carbon adsorber system that is regenerated directly on site in the control device is not regenerated at the predetermined carbon bed regeneration time.

(I) Each occurrence when the carbon in a carbon adsorber system that is not regenerated directly on site in the control device is not replaced at the predetermined interval specified in §61.354(c) of this subpart.

(J) Each 3-hour period of operation during which the parameters monitored are outside the range of values specified in §61.349(a)(2)(iv)(C), or any other periods specified by the Administrator for a control device subject to the requirements of §61.349(a)(2)(iv).

(v) For a cover and closed-vent system monitored in accordance with §61.354(g), the owner or operator shall submit a report quarterly to the Administrator that identifies any period in which the pressure in the waste management unit is equal to or greater than atmospheric pressure.

(8) Beginning one year after the date that the equipment necessary to comply with these standards has been certified in accordance with paragraph (d)(1) of this section, the owner or operator shall submit annually to the Administrator a report that summarizes all inspections required by §§61.342 through 61.354 during which detectable emissions are measured or a problem (such as a broken seal, gap or other problem) that could result in benzene emissions is identified, including information about the repairs or corrective action taken.

(e) An owner or operator electing to comply with the provisions of §§61.351 or 61.352 of this subpart shall notify the Administrator of the alternative standard selected in the report required under §61.07 or §61.10 of this part.

(f) An owner or operator who elects to install and operate the control equipment in §61.351 of this subpart shall comply with the reporting requirements in 40 CFR 60.115b.

(g) An owner or operator who elects to install and operate the control equipment in §61.352 of this subpart shall submit initial and quarterly reports that identify all seal gap measurements, as required in 40 CFR 60.693-2(a), that are outside the prescribed limits.

[55 FR 8346, Mar. 7, 1990; 55 FR 12444, Apr. 3, 1990, as amended at 55 FR 37231, Sept. 10, 1990; 58 FR 3105, Jan. 7, 1993; 65 FR 62161, Oct. 17, 2000]

**§61.358 Delegation of authority.**

(a) In delegating implementation and enforcement authority to a State under section 112(d) of the Clean Air Act, the authorities contained in paragraph (b) of this section shall be retained by the Administrator and not transferred to a State.

(b) Alternative means of emission limitation under §61.353 of this subpart will not be delegated to States.

**§61.359 [Reserved]**

**Appendix A to Part 61**

APPENDIX A  
National Emission Standards for Hazardous Air Pollutants  
Compliance Status Information

**I. SOURCE REPORT**

INSTRUCTIONS: Owners or operators of sources of hazardous pollutants subject to the National Emission Standards for Hazardous Air Pollutants are required to submit the information contained in Section I to the appropriate U.S. Environmental Protection Agency Regional Office prior to 90 days after the effective date of any standards or amendments which require the submission of such information.

A list of regional offices is provided in §61.04.

**A. SOURCE INFORMATION**

1. Identification/Location - Indicate the name and address of each source.

|          |                                       |              |        |               |       |       |             |
|----------|---------------------------------------|--------------|--------|---------------|-------|-------|-------------|
|          | 1 2                                   | 3 4          | 5 8    | 9 13          | 0 0 0 | 0 0   | 1           |
|          | Region                                | State        | County | Source Number | 14 16 | 17 18 | 19          |
|          | 20 22                                 | 23 26        | 27     | Source Name   | 46    |       |             |
|          | AQCR #                                | City Code    |        |               |       |       |             |
|          | 47 Street Address (Location of Plant) |              |        |               |       |       | 86 80       |
| Dup 1-18 |                                       |              |        |               |       |       |             |
|          | 19                                    | 20 City Name |        |               | 34    | 35    | 39          |
|          | 40 State Regis. Number                |              |        |               |       |       | 54 55 58    |
|          |                                       |              |        |               |       |       | NEOS X REF. |
|          | 59                                    | 62           | 64     | 65            | 77 79 | 80    |             |
|          | SIC                                   | FF           | A/P    | Staff         |       |       |             |
| Dup 1-18 | 5                                     | 25           | 30     | 31            | 49    | 80    |             |
|          | 19                                    | CS           | STP    | EC            |       |       |             |

2. Contact - Indicate the name and telephone number of the owner or operator or other responsible official whom EPA may contact concerning this report.

Dup 1-18 4 1  
19 20 21 Name 43

44 46  
Area Code 47 Number 54 80

3. Source Description - Briefly state the nature of the source (e.g., "Chlor-alkali Plant" or "Machine Shop").

Dup 1-18 4 2  
19 20 21 Description 50

51 Continued 79 80

4. Alternative Mailing Address - Indicate an alternative mailing address if correspondence is to be directed to a location different than that specified above.

Dup 1-18 4 3  
19 20 21 Number Street or Box Number 45 80

Dup 1-18 4 4  
19 20 21 City 35 State 37 38 41 Zip 44 80

5. Compliance Status - The emissions from this source can cannot meet the emission limitations contained in the National Emission Standards on or prior to 90 days after the effective date of any standards or amendments which require the submission of such information.

Signature of Owner, Operator or Other Responsible Official

NOTE: If the emissions from the source will exceed those limits set by the National Emission Standards for Hazardous Air Pollutants, the source will be in violation and subject to Federal enforcement actions unless granted a waiver of compliance by the Administrator of the U.S. Environmental Protection Agency. The information needed for such waivers is listed in Section II of this form.

- B. PROCESS INFORMATION. Part B should be completed separately for each point of emission for each hazardous pollutant. [Sources subject to 61.22(1) may omit number 4, below.]

Dup 1-13 14 16 17 18 19 20 27 28 29 30 31  
NEQS X Ref LS SIP

1. Pollutant Emitted - Indicate the type of hazardous pollutant emitted by the process. Indicate "AS" for asbestos, "BE" for beryllium, or "HG" for mercury.

32 33  
Pollutant 34 Regulation 48 49  
EC

2. Process Description - Provide a brief description of each process (e.g., "hydrogen end box" in a mercury chlor-alkali plant, "grinding machine" in a beryllium machine shop). Use additional sheets if necessary.

50 Process Description 74 80

|                          |       |
|--------------------------|-------|
| Dup 1-18 6 1<br>19 20 21 | 50    |
| 51                       | 79 80 |
| Dup 1-18 6 2<br>19 20 21 | 50    |
| 51                       | 79 80 |

3. Amount of Pollutant - Indicate the average weight of the hazardous material named in Item 1 which enters the process in pounds per month (based on the previous twelve months of operation).

Dup 1-18 6 3  
19 20 21 lbs./mo. 29 36 80

4. Control Devices

a. Indicate the type of pollution control devices, if any, used to reduce the emissions from the process (e.g., venturi scrubber, baghouse, wet cyclone) and the estimated percent of the pollutant which the device removes from the process gas stream.

Dup 1-18 6 4  
19 20 21 PRIMARY CONTROL DEVICE: 43

45 Primary Device Name 64 66 70  
Percent Removal Efficiency 72 79

80

Dup 1-18 6 5 SECONDARY CONTROL DEVICES: 45  
 19 20 21

47 Secondary Device Name 64 66 70 % EFFIC. 72 79 80  
 Percent Removal Efficiency

- b. Asbestos Emission Control Devices Only
- If a baghouse is specified in Item 4a, give the following information:
    - The air flow permeability in cubic feet per minute per square foot of fabric area.  
 Air flow permeability = \_\_\_\_\_ cfm/ft<sup>2</sup>
    - The pressure drop in inches water gauge across the filter at which the baghouse is operated.  
 Operating pressure drop = \_\_\_\_\_ inches w.g.
    - If the baghouse material contains synthetic fill yarn, check whether this material is / / spun / / or not spun.
    - If the baghouse utilizes a felted fabric, give the minimum thickness in inches and the density in ounces per square yard.  
 Thickness = \_\_\_\_\_ inches Density = \_\_\_\_\_ oz/yd<sup>2</sup>
  - If a wet collection device is specified in Item 4a, give the designed unit contacting energy in inches water gauge.
    - Unit contacting energy = \_\_\_\_\_ inches w.g.

c. DISPOSAL OF ASBESTOS-CONTAINING WASTES. Part C should be completed separately for each asbestos-containing waste generation operation arising from sources subject to §61.22(a), (c), (e), and (h).

Dup 1-13 14 16 17 18 19 20 SCC 27 28 29 30 31  
 0 0 5 NEDS X Ref CS SIP  
 A B  
 32 33 34 Regulation 48 49  
 Pollutant EC

- Waste Generation - Provide a brief description of each process that generates asbestos-containing waste (e.g. disposal of control device wastes).

50 Process Description 79 80

- Asbestos Concentration - Indicate the average percentage asbestos content of these materials.

Dup 1-18 6 1 ASBESTOS CONCENTRATION: 43 45 48  
 19 20 21

%  
 50 80

- Amount of Wastes - Indicate the average weight of asbestos-containing wastes disposed of, measured in kg/day.

Dup 1-18 6 2 kg/day 34 80  
 19 20 21 27 29

- Control Methods - Indicate the emission control methods used in all stages of waste disposal, from collection, processing, and packaging to transporting and deposition.

Dup 1-18 6 3 Primary Control Method 43  
 19 20 21

45 79 80

Dup 1-18 6 4 50  
 19 20 21

51 79 80

- Waste Disposal - Indicate the type of disposal site (sanitary landfill, open, covered) or incineration site (municipal, private) where the waste is disposed of and who operates the site (company, private, municipal). State the name and location of the site (closest city or town, county, state).

Dup 1-18 6 5 TYPE OF SITE: 33 35 50  
 19 20 21

51 79 80



Dup 1-18 6 6 OPERATOR: 21 29 31 50  
 19 20  
 51 79 80  
 Dup 1-18 6 7 LOCATION: 21 29  
 31 70  
 71 79 80

D. WASTE DISPOSAL SITES. Part D should be completed separately for each asbestos waste disposal site subject to section 61.22(1).

Dup 1-13 0 0 5 14 16 17 18 19 20 SCC 27 28 29 30 31  
 NEDS X Ref CS SIP  
 A B 32 33 Regulation 48 49  
 Pollutant EC  
 50 WASTE DISPOSAL SITE 68 80  
 1. Description - Provide a brief description of the site, including its size and configuration, and the distance to the closest city or town, closest residence, and closest primary road.  
 Dup 1-18 6 1 SITE DESCRIPTION 21 37 39 50  
 51 79 80  
 Dup 1-18 6 2 DISTANCE: 21 29 30 TOWN: 34 36 40 42 43 K M  
 RESIDENCE: 45 54 56 60 62 63 K M ROAD: 65 69 71 75  
 K M 77 78 80

2. Inactivation - After the site is inactivated, indicate the method or methods used to comply with the standard and send a list of the actions that will be undertaken to maintain the inactivated site.

Dup 1-18 6 8 COMPLIANCE METHOD/INACTIVE SITE: 21 52  
 54 79 80

II. WAIVER REQUESTS

A. *Waiver of Compliance.* Owners or operators of sources unable to operate in compliance with the National Emission Standards for Hazardous Air Pollutants prior to 90 days after the effective date of any standards or amendments which require the submission of such information may request a waiver of compliance from the Administrator of the U.S. Environmental Protection Agency for the time period necessary to install appropriate control devices or make modifications to achieve compliance. The Administrator may grant a waiver of compliance with the standard for a period not exceeding two years from the effective date of the hazardous pollutant standards, if he finds that such period is necessary for the installation of controls and that steps will be taken during the period of the waiver to assure that the health of persons will be protected from imminent endangerment.

The report information provided in Section I must accompany this application. Applications should be sent to the appropriate EPA regional office.

1. *Processes Involved*—Indicate the process or processes emitting hazardous pollutants to which emission controls are to be applied.

2. *Controls*

a. Describe the proposed type of control device to be added or modification to be made to the process to reduce the emission of hazardous pollutants to an acceptable level. (Use additional sheets if necessary.)

b. Describe the measures that will be taken during the waiver period to assure that the health of persons will be protected from imminent endangerment. (Use additional sheets if necessary.)

3. *Increments of Progress*—Specify the dates by which the following increments of progress will be met.

Date by which contracts for emission control systems or process modifications will be awarded; or date by which orders will be issued for the purchase of the component parts to accomplish emission control or process modification.

Dup 1-16      0 1 7  
17 19 53 54 55 \_\_\_\_\_ 60 61 MO/DY/YR 66 80

Date of initiation of on-site construction or installation of emission control equipment or process change.

Dup 1-16      0 2 7  
17 19 53 54 55 \_\_\_\_\_ 60 61 MO/DY/YR 66 80

Date by which on-site construction or installation of emission control equipment or process modification is to be completed.

Dup 1-16      0 3 7  
17 19 53 54 55 \_\_\_\_\_ 60 61 MO/DY/YR 66 80

Date by which final compliance is to be achieved.

Dup 1-16      0 4 7  
17 19 53 54 55 \_\_\_\_\_ 60 61 MO/DY/YR 66 80

B. *Waiver of Emission Tests*. A waiver of emission testing may be granted to owners or operators of sources subject to emission testing if, in the judgment of the Administrator of the Environmental Protection Agency the emissions from the source comply with the appropriate standard or if the owners or operators of the source have requested a waiver of compliance or have been granted a waiver of compliance.

This application should accompany the report information provided in Section I.

1. *Reason*—State the reasons for requesting a waiver of emission testing. If the reason stated is that the emissions from the source are within the prescribed limits, documentation of this condition must be attached.

Date  
Signature of the owner or operator

(Sec. 114, of the Clean Air Act as amended (42 U.S.C. 7414))

[40 FR 48303, Oct. 14, 1975, as amended at 43 FR 8800, Mar. 3, 1978; 50 FR 46295, Sept. 9, 1985]

## Appendix B to Part 61—Test Methods

Method 101—Determination of particulate and gaseous mercury emissions from chlor-alkali plants (air streams)

Method 101A—Determination of particulate and gaseous mercury emissions from sewage sludge incinerators

Method 102—Determination of particulate and gaseous mercury emissions from chlor-alkali plants (hydrogen streams)

Method 103—Beryllium screening method

Method 104—Determination of beryllium emissions from stationary sources

Method 105—Determination of mercury in wastewater treatment plant sewage sludges

Method 106—Determination of vinyl chloride emissions from stationary sources

Method 107—Determination of vinyl chloride content of in-process wastewater samples, and vinyl chloride content of polyvinyl chloride resin slurry, wet cake, and latex samples

Method 107A—Determination of vinyl chloride content of solvents, resin-solvent solution, polyvinyl chloride resin, resin slurry, wet resin, and latex samples

Method 108—Determination of particulate and gaseous arsenic emissions

Method 108A—Determination of arsenic content in ore samples from nonferrous smelters

Method 108B—Determination of arsenic content in ore samples from nonferrous smelters

Method 108C—Determination of arsenic content in ore samples from nonferrous smelters (molybdenum blue photometric procedure)

Method 111—Determination of Polonium—210 emissions from stationary sources

**METHOD 101—DETERMINATION OF PARTICULATE AND GASEOUS MERCURY EMISSIONS FROM CHLOR-ALKALI PLANTS (AIR STREAMS)**

NOTE: This method does not include all of the specifications (e.g., equipment and supplies) and procedures (e.g., sampling and analytical) essential to its performance. Some material is incorporated by reference from methods in appendix A to 40 CFR part 60. Therefore, to obtain reliable results, persons using this method should have a thorough knowledge of at least the following additional test methods: Method 1, Method 2, Method 3, and Method 5.

*1.0 Scope and Application*

1.1 Analytes.

| Analyte      | CAS No.   | Sensitivity                                    |
|--------------|-----------|--|
| Mercury (Hg) | 7439-97-6 | Dependent upon recorder and spectrophotometer. |

1.2 Applicability. This method is applicable for the determination of Hg emissions, including both particulate and gaseous Hg, from chlor-alkali plants and other sources (as specified in the regulations) where the carrier-gas stream in the duct or stack is principally air.

1.3 Data Quality Objectives. Adherence to the requirements of this method will enhance the quality of the data obtained from air pollutant sampling methods.

*2.0 Summary of Method*

Particulate and gaseous Hg emissions are withdrawn isokinetically from the source and collected in acidic iodine monochloride (ICI) solution. The Hg collected (in the mercuric form) is reduced to elemental

Hg, which is then aerated from the solution into an optical cell and measured by atomic absorption spectrophotometry.

### 3.0 Definitions [Reserved]

### 4.0 Interferences

4.1 Sample Collection. Sulfur dioxide (SO<sub>2</sub>) reduces ICI and causes premature depletion of the ICI solution.

4.2 Sample Analysis.

4.2.1 ICI concentrations greater than 10<sup>-4</sup> molar inhibit the reduction of the Hg (II) ion in the aeration cell.

4.2.2 Condensation of water vapor on the optical cell windows causes a positive interference.

### 5.0 Safety

5.1 Disclaimer. This method may involve hazardous materials, operations, and equipment. This test method does not purport to address all of the safety problems associated with its use. It is the responsibility of the user of this test method to establish appropriate safety and health practices and determine the applicability of regulatory limitations prior to performing this test method.

5.2 Corrosive Reagents. The following reagents are hazardous. Personal protective equipment and safe procedures are useful in preventing chemical splashes. If contact occurs, immediately flush with copious amounts of water for at least 15 minutes. Remove clothing under shower and decontaminate. Treat residual chemical burn as thermal burn.

5.2.1 Hydrochloric Acid (HCl). Highly toxic and corrosive. Causes severe damage to tissues. Vapors are highly irritating to eyes, skin, nose, and lungs, causing severe damage. May cause bronchitis, pneumonia, or edema of lungs. Exposure to concentrations of 0.13 to 0.2 percent can be lethal to humans in a few minutes. Provide ventilation to limit exposure. Reacts with metals, producing hydrogen gas.

5.2.2 Nitric Acid (HNO<sub>3</sub>). Highly corrosive to eyes, skin, nose, and lungs. Vapors cause bronchitis, pneumonia, or edema of lungs. Reaction to inhalation may be delayed as long as 30 hours and still be fatal. Provide ventilation to limit exposure. Strong oxidizer. Hazardous reaction may occur with organic materials such as solvents.

5.2.3 Sulfuric Acid (H<sub>2</sub>SO<sub>4</sub>). Rapidly destructive to body tissue. Will cause third degree burns. Eye damage may result in blindness. Inhalation may be fatal from spasm of the larynx, usually within 30 minutes. 3 mg/m<sup>3</sup> will cause lung damage. 1 mg/m<sup>3</sup> for 8 hours will cause lung damage or, in higher concentrations, death. Provide ventilation to limit inhalation. Reacts violently with metals and organics.

### 6.0 Equipment and Supplies.

6.1 Sample Collection. A schematic of the sampling train used in performing this method is shown in Figure 101-1; it is similar to the Method 5 sampling train. The following items are required for sample collection:

6.1.1 Probe Nozzle, Pitot Tube, Differential Pressure Gauge, Metering System, Barometer, and Gas Density Determination Equipment. Same as Method 5, Sections 6.1.1.1, 6.1.1.3, 6.1.1.4, 6.1.1.9, 6.1.2, and 6.1.3, respectively.

6.1.2 Probe Liner. Borosilicate or quartz glass tubing. A heating system capable of maintaining a gas temperature of  $120 \pm 14$  °C ( $248 \pm 25$  °F) at the probe exit during sampling may be used to prevent water condensation.

NOTE: Do not use metal probe liners.

6.1.3 Impingers. Four Greenburg-Smith impingers connected in series with leak-free ground glass fittings or any similar leak-free noncontaminating fittings. For the first, third, and fourth impingers, impingers that are modified by replacing the tip with a 13-mm ID (0.5-in.) glass tube extending to 13 mm (0.5 in.) from the bottom of the flask may be used.

6.1.4 Acid Trap. Mine Safety Appliances air line filter, Catalog number 81857, with acid absorbing cartridge and suitable connections, or equivalent.

6.2 Sample Recovery. The following items are needed for sample recovery:

6.2.1 Glass Sample Bottles. Leakless, with Teflon-lined caps, 1000- and 100-ml.

6.2.2 Graduated Cylinder. 250-ml.

6.2.3 Funnel and Rubber Policeman. To aid in transfer of silica gel to container; not necessary if silica gel is weighed in the field.

6.2.4 Funnel. Glass, to aid in sample recovery.

6.3 Sample Preparation and Analysis. The following items are needed for sample preparation and analysis:

6.3.1 Atomic Absorption Spectrophotometer. Perkin-Elmer 303, or equivalent, containing a hollow-cathode mercury lamp and the optical cell described in Section 6.3.2.

6.3.2 Optical Cell. Cylindrical shape with quartz end windows and having the dimensions shown in Figure 101-2. Wind the cell with approximately 2 meters (6 ft) of 24-gauge Nichrome wire, or equivalent, and wrap with fiberglass insulation tape, or equivalent; do not let the wires touch each other.

6.3.3 Aeration Cell. Constructed according to the specifications in Figure 101-3. Do not use a glass frit as a substitute for the blown glass bubbler tip shown in Figure 101-3.

6.3.4 Recorder. Matched to output of the spectrophotometer described in Section 6.3.1.

6.3.5 Variable Transformer. To vary the voltage on the optical cell from 0 to 40 volts.

6.3.6 Hood. For venting optical cell exhaust.

6.3.7 Flow Metering Valve.

6.3.8 Rate Meter. Rotameter, or equivalent, capable of measuring to within 2 percent a gas flow of 1.5 liters/min (0.053 cfm).

6.3.9 Aeration Gas Cylinder. Nitrogen or dry, Hg-free air, equipped with a single-stage regulator.

6.3.10 Tubing. For making connections. Use glass tubing (ungreased ball and socket connections are recommended) for all tubing connections between the solution cell and the optical cell; do not use Tygon tubing, other types of flexible tubing, or metal tubing as substitutes. Teflon, steel, or copper tubing may be used between the nitrogen tank and flow metering valve (Section 6.3.7), and Tygon, gum, or rubber tubing between the flow metering valve and the aeration cell.

6.3.11 Flow Rate Calibration Equipment. Bubble flow meter or wet-test meter for measuring a gas flow rate of  $1.5 \pm 0.1$  liters/min ( $0.053 \pm 0.0035$  cfm).

6.3.12 Volumetric Flasks. Class A with penny head standard taper stoppers; 100-, 250-, 500-, and 1000-ml.

6.3.13 Volumetric Pipets. Class A; 1-, 2-, 3-, 4-, and 5-ml.

6.3.14 Graduated Cylinder. 50-ml.

6.3.15 Magnetic Stirrer. General-purpose laboratory type.

6.3.16 Magnetic Stirring Bar. Teflon-coated.

6.3.17 Balance. Capable of weighing to  $\pm 0.5$  g.

6.3.18 Alternative Analytical Apparatus. Alternative systems are allowable as long as they meet the following criteria:

6.3.18.1 A linear calibration curve is generated and two consecutive samples of the same aliquot size and concentration agree within 3 percent of their average.

6.3.18.2 A minimum of 95 percent of the spike is recovered when an aliquot of a source sample is spiked with a known concentration of Hg (II) compound.

6.3.18.3 The reducing agent should be added after the aeration cell is closed.

6.3.18.4 The aeration bottle bubbler should not contain a frit.

6.3.18.5 Any Tygon tubing used should be as short as possible and conditioned prior to use until blanks and standards yield linear and reproducible results.

6.3.18.6 If manual stirring is done before aeration, it should be done with the aeration cell closed.

6.3.18.7 A drying tube should not be used unless it is conditioned as the Tygon tubing above.

## 7.0 Reagents and Standards

Unless otherwise indicated, all reagents must conform to the specifications established by the Committee on Analytical Reagents of the American Chemical Society; where such specifications are not available, use the best available grade.

7.1 Sample Collection. The following reagents are required for sample collection:

7.1.1 Water. Deionized distilled, to conform to ASTM D 1193-77 or 91 (incorporated by reference—see §61.18), Type 1. If high concentrations of organic matter are not expected to be present, the analyst may eliminate the  $\text{KMnO}_4$  test for oxidizable organic matter. Use this water in all dilutions and solution preparations.

7.1.2 Nitric Acid, 50 Percent (v/v). Mix equal volumes of concentrated  $\text{HNO}_3$  and water, being careful to add the acid to the water slowly.

7.1.3 Silica Gel. Indicating type, 6- to 16-mesh. If previously used, dry at  $175\text{ }^\circ\text{C}$  ( $350\text{ }^\circ\text{F}$ ) for 2 hours. The tester may use new silica gel as received.

7.1.4 Potassium Iodide (KI) Solution, 25 Percent. Dissolve 250 g of KI in water, and dilute to 1 liter.

7.1.5 Iodine Monochloride Stock Solution, 1.0 M. To 800 ml of 25 percent KI solution, add 800 ml of concentrated HCl. Cool to room temperature. With vigorous stirring, slowly add 135 g of potassium iodate ( $\text{KIO}_3$ ), and stir until all free iodine has dissolved. A clear orange-red solution occurs when all the  $\text{KIO}_3$  has been added. Cool to room temperature, and dilute to 1800 ml with water. Keep the solution in amber glass bottles to prevent degradation.

7.1.6 Absorbing Solution, 0.1 M ICl. Dilute 100 ml of the 1.0 M ICl stock solution to 1 liter with water. Keep the solution in amber glass bottles and in darkness to prevent degradation. This reagent is stable for at least two months.

7.2 Sample Preparation and Analysis. The following reagents and standards are required for sample preparation and analysis:

#### 7.2.1 Reagents.

7.2.1.1 Tin (II) Solution. Prepare fresh daily, and keep sealed when not being used. Completely dissolve 20 g of tin (II) chloride (or 25 g of tin (II) sulfate) crystals (Baker Analyzed reagent grade or any other brand that will give a clear solution) in 25 ml of concentrated HCl. Dilute to 250 ml with water. Do not substitute  $\text{HNO}_3$ ,  $\text{H}_2\text{SO}_4$ , or other strong acids for the HCl.

7.2.1.2 Sulfuric Acid, 5 Percent (v/v). Dilute 25 ml of concentrated  $\text{H}_2\text{SO}_4$  to 500 ml with water.

#### 7.2.2 Standards

7.2.2.1 Hg Stock Solution, 1 mg Hg/ml. Prepare and store all Hg standard solutions in borosilicate glass containers. Completely dissolve 0.1354 g of Hg (II) chloride in 75 ml of water in a 100-ml glass volumetric flask. Add 10 ml of concentrated  $\text{HNO}_3$ , and adjust the volume to exactly 100 ml with water. Mix thoroughly. This solution is stable for at least one month.

7.2.2.2 Intermediate Hg Standard Solution,  $10\text{ }\mu\text{g}$  Hg/ml. Prepare fresh weekly. Pipet 5.0 ml of the Hg stock solution (Section 7.2.2.1) into a 500-ml glass volumetric flask, and add 20 ml of the 5 percent  $\text{H}_2\text{SO}_4$  solution. Dilute to exactly 500 ml with water. Thoroughly mix the solution.

7.2.2.3 Working Hg Standard Solution, 200 ng Hg/ml. Prepare fresh daily. Pipet 5.0 ml of the intermediate Hg standard solution (Section 7.2.2.2) into a 250-ml volumetric glass flask. Add 10 ml of the 5 percent  $\text{H}_2\text{SO}_4$  and 2 ml of the 0.1 M ICl absorbing solution taken as a blank (Section 8.7.4.3), and dilute to 250 ml with water. Mix thoroughly.

### 8.0 Sample Collection, Preservation, Transport, and Storage

Because of the complexity of this method, testers should be trained and experienced with the test procedures to ensure reliable results. Since the amount of Hg that is collected generally is small, the method must be carefully applied to prevent contamination or loss of sample.

8.1 Pretest Preparation. Follow the general procedure outlined in Method 5, Section 8.1, except omit Sections 8.1.2 and 8.1.3.

8.2 Preliminary Determinations. Follow the general procedure outlined in Method 5, Section 8.2, with the exception of the following:

8.2.1 Select a nozzle size based on the range of velocity heads to assure that it is not necessary to change the nozzle size in order to maintain isokinetic sampling rates below 28 liters/min (1.0 cfm).

8.2.2 Perform test runs such that samples are obtained over a period or periods that accurately determine the maximum emissions that occur in a 24-hour period. In the case of cyclic operations, run sufficient tests for the accurate determination of the emissions that occur over the duration of the cycle. A minimum sample time of 2 hours is recommended. In some instances, high Hg or high SO<sub>2</sub> concentrations make it impossible to sample for the desired minimum time. This is indicated by reddening (liberation of free iodine) in the first impinger. In these cases, the sample run may be divided into two or more subruns to ensure that the absorbing solution is not depleted.

8.3 Preparation of Sampling Train.

8.3.1 Clean all glassware (probe, impingers, and connectors) by rinsing with 50 percent HNO<sub>3</sub>, tap water, 0.1 M ICI, tap water, and finally deionized distilled water. Place 100 ml of 0.1 M ICI in each of the first three impingers. Take care to prevent the absorbing solution from contacting any greased surfaces. Place approximately 200 g of preweighed silica gel in the fourth impinger. More silica gel may be used, but care should be taken to ensure that it is not entrained and carried out from the impinger during sampling. Place the silica gel container in a clean place for later use in the sample recovery. Alternatively, determine and record the weight of the silica gel plus impinger to the nearest 0.5 g.

8.3.2 Install the selected nozzle using a Viton A O-ring when stack temperatures are less than 260 °C (500 °F). Use a fiberglass string gasket if temperatures are higher. See APTD-0576 (Reference 3 in Method 5) for details. Other connecting systems using either 316 stainless steel or Teflon ferrules may be used. Mark the probe with heat-resistant tape or by some other method to denote the proper distance into the stack or duct for each sampling point.

8.3.3 Assemble the train as shown in Figure 101-1, using (if necessary) a very light coat of silicone grease on all ground glass joints. Grease only the outer portion (see APTD-0576) to avoid the possibility of contamination by the silicone grease.

NOTE: An empty impinger may be inserted between the third impinger and the silica gel to remove excess moisture from the sample stream.

8.3.4 After the sampling train has been assembled, turn on and set the probe heating system, if applicable, at the desired operating temperature. Allow time for the temperatures to stabilize. Place crushed ice around the impingers.

8.4 Leak-Check Procedures. Follow the leak-check procedures outlined in Method 5, Section 8.4.

8.5 Sampling Train Operation. Follow the general procedure outlined in Method 5, Section 8.5. For each run, record the data required on a data sheet such as the one shown in Figure 101-4.



8.6 Calculation of Percent Isokinetic. Same as Method 5, Section 8.6.

8.7 Sample Recovery. Begin proper cleanup procedure as soon as the probe is removed from the stack at the end of the sampling period.

8.7.1 Allow the probe to cool. When it can be safely handled, wipe off any external particulate matter near the tip of the probe nozzle, and place a cap over it. Do not cap off the probe tip tightly while the sampling train is cooling. Capping would create a vacuum and draw liquid out from the impingers.

8.7.2 Before moving the sampling train to the cleanup site, remove the probe from the train, wipe off the silicone grease, and cap the open outlet of the probe. Be careful not to lose any condensate that might be present. Wipe off the silicone grease from the impinger. Use either ground-glass stoppers, plastic caps, or serum caps to close these openings.

8.7.3 Transfer the probe and impinger assembly to a cleanup area that is clean, protected from the wind, and free of Hg contamination. The ambient air in laboratories located in the immediate vicinity of Hg-using facilities is not normally free of Hg contamination.

8.7.4 Inspect the train before and during disassembly, and note any abnormal conditions. Treat the samples as follows.

8.7.4.1 Container No. 1 (Impingers and Probe).

8.7.4.1.1 Using a graduated cylinder, measure the liquid in the first three impingers to within 1 ml. Record the volume of liquid present (*e.g.*, see Figure 5-6 of Method 5). This information is needed to calculate the moisture content of the effluent gas. (Use only glass storage bottles and graduated cylinders that have been precleaned as in Section 8.3.1) Place the contents of the first three impingers into a 1000-ml glass sample bottle.

8.7.4.1.2 Taking care that dust on the outside of the probe or other exterior surfaces does not get into the sample, quantitatively recover the Hg (and any condensate) from the probe nozzle, probe fitting, and probe liner as follows: Rinse these components with two 50-ml portions of 0.1 M ICI. Next, rinse the probe nozzle, fitting and liner, and each piece of connecting glassware between the probe liner and the back half of the third impinger with a maximum of 400 ml of water. Add all washings to the 1000-ml glass sample bottle containing the liquid from the first three impingers.

8.7.4.1.3 After all washings have been collected in the sample container, tighten the lid on the container to prevent leakage during shipment to the laboratory. Mark the height of the liquid to determine later whether leakage occurred during transport. Label the container to identify clearly its contents.

8.7.4.2 Container No. 2 (Silica Gel). Same as Method 5, Section 8.7.6.3.

8.7.4.3 Container No. 3 (Absorbing Solution Blank). Place 50 ml of the 0.1 M ICI absorbing solution in a 100-ml sample bottle. Seal the container. Use this blank to prepare the working Hg standard solution (Section 7.2.2.3).

## 9.0 Quality Control

9.1 Miscellaneous Quality Control Measures.

| Section | Quality control measure | Effect |
|---------|-------------------------|--------|
|---------|-------------------------|--------|

|            |  |  |
|------------|--|--|
| 8.4 10.2   | Sampling equipment leak-checks and calibration | Ensure accuracy and precision of sampling measurements.      |
| 10.5, 10.6 | Spectrophotometer calibration                  | Ensure linearity of spectrophotometer response to standards. |
| 11.3.3     | Check for matrix effects                       | Eliminate matrix effects.                                    |

9.2 Volume Metering System Checks. Same as Method 5, Section 9.2.

### 10.0 Calibration and Standardizations

NOTE: Maintain a laboratory log of all calibrations.

10.1 Before use, clean all glassware, both new and used, as follows: brush with soap and tap water, liberally rinse with tap water, soak for 1 hour in 50 percent HNO<sub>3</sub>, and then rinse with deionized distilled water.

10.2 Sampling Equipment. Calibrate the sampling equipment according to the procedures outlined in the following sections of Method 5: Section 10.1 (Probe Nozzle), Section 10.2 (Pitot Tube Assembly), Section 10.3 (Metering System), Section 10.5 (Temperature Sensors), Section 10.6 (Barometer).

10.3 Aeration System Flow Rate Meter. Assemble the aeration system as shown in Figure 101-5. Set the outlet pressure on the aeration gas cylinder regulator to a minimum pressure of 500 mm Hg (10 psi), and use the flow metering valve and a bubble flowmeter or wet-test meter to obtain a flow rate of 1.5 ±0.1 liters/min (0.053 ±0.0035 cfm) through the aeration cell. After the calibration of the aeration system flow rate meter is complete, remove the bubble flowmeter from the system.

10.4 Optical Cell Heating System. Using a 50-ml graduated cylinder, add 50 ml of water to the bottle section of the aeration cell, and attach the bottle section to the bubbler section of the cell. Attach the aeration cell to the optical cell and while aerating at 1.5 ±0.1 liters/min (0.053 ±0.0035 cfm), determine the minimum variable transformer setting necessary to prevent condensation of moisture in the optical cell and in the connecting tubing. (This setting should not exceed 20 volts.)

10.5 Spectrophotometer and Recorder.

10.5.1 The Hg response may be measured by either peak height or peak area.

NOTE: The temperature of the solution affects the rate at which elemental Hg is released from a solution and, consequently, it affects the shape of the absorption curve (area) and the point of maximum absorbance (peak height). Therefore, to obtain reproducible results, bring all solutions to room temperature before use.

10.5.2 Set the spectrophotometer wavelength at 253.7 nm, and make certain the optical cell is at the minimum temperature that will prevent water condensation. Then set the recorder scale as follows: Using a 50-ml graduated cylinder, add 50 ml of water to the aeration cell bottle. Add three drops of Antifoam B to the bottle, and then pipet 5.0 ml of the working Hg standard solution into the aeration cell.

NOTE: Always add the Hg-containing solution to the aeration cell after the 50 ml of water.

10.5.3 Place a Teflon-coated stirring bar in the bottle. Before attaching the bottle section to the bubbler section of the aeration cell, make certain that (1) the aeration cell exit arm stopcock (Figure 101-3) is closed (so that Hg will not prematurely enter the optical cell when the reducing agent is being added) and (2) there is no flow through the bubbler. If conditions (1) and (2) are met, attach the bottle section to

the bubbler section of the aeration cell. Pipet 5 ml of tin (II) reducing solution into the aeration cell through the side arm, and immediately stopper the side arm. Stir the solution for 15 seconds, turn on the recorder, open the aeration cell exit arm stopcock, and immediately initiate aeration with continued stirring. Determine the maximum absorbance of the standard, and set this value to read 90 percent of the recorder full scale.

## 10.6 Calibration Curve.

10.6.1 After setting the recorder scale, repeat the procedure in Section 10.5 using 0.0-, 1.0-, 2.0-, 3.0-, 4.0-, and 5.0-ml aliquots of the working standard solution (final amount of Hg in the aeration cell is 0, 200, 400, 600, 800, and 1000 ng, respectively). Repeat this procedure on each aliquot size until two consecutive peaks agree within 3 percent of their average value.

NOTE: To prevent Hg carryover from one sample to another, do not close the aeration cell from the optical cell until the recorder pen has returned to the baseline.)

10.6.2 It should not be necessary to disconnect the aeration gas inlet line from the aeration cell when changing samples. After separating the bottle and bubbler sections of the aeration cell, place the bubbler section into a 600-ml beaker containing approximately 400 ml of water. Rinse the bottle section of the aeration cell with a stream of water to remove all traces of the tin (II) reducing agent. Also, to prevent the loss of Hg before aeration, remove all traces of the reducing agent between samples by washing with water. It will be necessary, however, to wash the aeration cell parts with concentrated HCl if any of the following conditions occur: (1) A white film appears on any inside surface of the aeration cell, (2) the calibration curve changes suddenly, or (3) the replicate samples do not yield reproducible results.

10.6.3 Subtract the average peak height (or peak area) of the blank (0.0-ml aliquot)—which must be less than 2 percent of recorder full scale—from the averaged peak heights of the 1.0-, 2.0-, 3.0-, 4.0-, and 5.0-ml aliquot standards. If the blank absorbance is greater than 2 percent of full-scale, the probable cause is Hg contamination of a reagent or carry-over of Hg from a previous sample. Prepare the calibration curve by plotting the corrected peak height of each standard solution versus the corresponding final total Hg weight in the aeration cell (in ng), and draw the best fit straight line. This line should either pass through the origin or pass through a point no further from the origin than  $\pm 2$  percent of the recorder full scale. If the line does not pass through or very near to the origin, check for nonlinearity of the curve and for incorrectly prepared standards.

## 11.0 Analytical Procedure

11.1 Sample Loss Check. Check the liquid level in each container to see whether liquid was lost during transport. If a noticeable amount of leakage occurred, either void the sample or use methods subject to the approval of the Administrator to account for the losses.

11.2 Sample Preparation. Treat each sample as follows:

11.2.1 Container No. 1 (Impingers and Probe). Carefully transfer the contents of Container No. 1 into a 1000-ml volumetric flask, and adjust the volume to exactly 1000 ml with water.

11.2.2 Dilutions. Pipet a 2-ml aliquot from the diluted sample from Section 11.2.1 into a 250-ml volumetric flask. Add 10 ml of 5 percent  $\text{H}_2\text{SO}_4$ , and adjust the volume to exactly 250 ml with water. This solution is stable for at least 72 hours.

NOTE: The dilution factor will be 250/2 for this solution.

11.3 Analysis. Calibrate the analytical equipment and develop a calibration curve as outlined in Sections 10.3 through 10.6.

11.3.1 Mercury Samples. Repeat the procedure used to establish the calibration curve with an appropriately sized aliquot (1 to 5 ml) of the diluted sample (from Section 11.2.2) until two consecutive peak heights agree within 3 percent of their average value. The peak maximum of an aliquot (except the 5-ml aliquot) must be greater than 10 percent of the recorder full scale. If the peak maximum of a 1.0-ml aliquot is off scale on the recorder, further dilute the original source sample to bring the Hg concentration into the calibration range of the spectrophotometer.

11.3.2 Run a blank and standard at least after every five samples to check the spectrophotometer calibration. The peak height of the blank must pass through a point no further from the origin than  $\pm 2$  percent of the recorder full scale. The difference between the measured concentration of the standard (the product of the corrected peak height and the reciprocal of the least squares slope) and the actual concentration of the standard must be less than 7 percent, or recalibration of the analyzer is required.

11.3.3 Check for Matrix Effects (optional). Use the Method of Standard Additions as follows to check at least one sample from each source for matrix effects on the Hg results. The Method of Standard Additions procedures described on pages 9-4 and 9-5 of the section entitled "General Information" of the Perkin Elmer Corporation Atomic Absorption Spectrophotometry Manual, Number 303-0152 (Reference 16 in Section 16.0) are recommended. If the results of the Method of Standard Additions procedure used on the single source sample do not agree to within  $\pm 5$  percent of the value obtained by the routine atomic absorption analysis, then reanalyze all samples from the source using the Method of Standard Additions procedure.

11.4 Container No. 2 (Silica Gel). Weigh the spent silica gel (or silica gel plus impinger) to the nearest 0.5 g using a balance. (This step may be conducted in the field.)

## 12.0 Data Analysis and Calculations

Carry out calculations, retaining at least one extra decimal significant figure beyond that of the acquired data. Round off figures only after the final calculation. Other forms of the equations may be used as long as they give equivalent results.

12.1 Average Dry Gas Meter Temperature and Average Orifice Pressure Drop, Dry Gas Volume, Volume of Water Vapor Condensed, Moisture Content, and Isokinetic Variation. Same as Method 5, Sections 12.2 through 12.5 and 12.11, respectively.

12.2 Stack Gas Velocity. Using the data from this test and Equation 2-9 of Method 2, calculate the average stack gas velocity  $v_s$ .

12.3 Total Mercury.

12.3.1 For each source sample, correct the average maximum absorbance of the two consecutive samples whose peak heights agree within 3 percent of their average for the contribution of the solution blank (see Section 10.6.3). Use the calibration curve and these corrected averages to determine the final total weight of Hg in ng in the aeration cell for each source sample.

12.3.2 Correct for any dilutions made to bring the sample into the working range of the spectrophotometer. Then calculate the Hg in the original solution,  $m_{Hg}$ , as follows:

$$m_{Hg} = [C_{Hg(AC)}(DF)(V_f)(10^{-3})]/S \quad \text{Eq. 101-1}$$

Where:

$C_{Hg(AC)}$  = Total ng of Hg in aliquot analyzed (reagent blank subtracted).

DF = Dilution factor for the Hg-containing solution (before adding to the aeration cell; e.g., DF = 250/2 if the source samples were diluted as described in Section 11.2.2).

$V_f$  = Solution volume of original sample, 1000 ml for samples diluted as described in Section 11.2.1.

$10^{-3}$  = Conversion factor,  $\mu\text{g}/\text{ng}$ .

S = Aliquot volume added to aeration cell, ml.

12.4 Mercury Emission Rate. Calculate the daily Hg emission rate, R, using Equation 101-2. For continuous operations, the operating time is equal to 86,400 seconds per day. For cyclic operations, use only the time per day each stack is in operation. The total Hg emission rate from a source will be the summation of results from all stacks.

$$R = \frac{K_{m_{\text{Hg}}} V_s A_s (86,400 \times 10^{-6})}{[V_{m(\text{std})} + V_{w(\text{std})}] (T_s / P_s)} \quad \text{Eq. 101-2}$$

Where:

$K_1 = 0.3858 \text{ }^\circ\text{K}/\text{mm Hg}$  for metric units.

$K_1 = 17.64 \text{ }^\circ\text{R}/\text{in. Hg}$  for English units.

$K_3 = 10^{-6} \text{ g}/\mu\text{g}$  for metric units.

=  $2.2046 \text{ " } \times 10^{-9} \text{ lb}/\mu\text{g}$  for English units.

$P_s$  = Absolute stack gas pressure, mm Hg (in. Hg).

t = Daily operating time, sec/day.

$T_s$  = Absolute average stack gas temperature,  $^\circ\text{K}$  ( $^\circ\text{R}$ ).

$V_{m(\text{std})}$  = Dry gas sample volume at standard conditions, scm (scf).

$V_{w(\text{std})}$  = Volume of water vapor at standard conditions, scm (scf).

12.5 Determination of Compliance. Each performance test consists of three repetitions of the applicable test method. For the purpose of determining compliance with an applicable national emission standard, use the average of the results of all repetitions.

### 13.0 Method Performance

The following estimates are based on collaborative tests, wherein 13 laboratories performed duplicate analyses on two Hg-containing samples from a chlor-alkali plant and on one laboratory-prepared sample of known Hg concentration. The sample concentrations ranged from 2 to 65  $\mu\text{g Hg}/\text{ml}$ .

13.1 Precision. The estimated intra-laboratory and inter-laboratory standard deviations are 1.6 and 1.8  $\mu\text{g Hg}/\text{ml}$ , respectively.

13.2 Accuracy. The participating laboratories that analyzed a 64.3  $\mu\text{g Hg}/\text{ml}$  (in 0.1 M ICI) standard obtained a mean of 63.7  $\mu\text{g Hg}/\text{ml}$ .

13.3 Analytical Range. After initial dilution, the range of this method is 0.5 to 120  $\mu\text{g Hg}/\text{ml}$ . The upper limit can be extended by further dilution of the sample.

14.0 *Pollution Prevention. [Reserved]*

15.0 *Waste Management. [Reserved]*

16.0 *Alternative Procedures*

16.1 Alternative Analyzer. Samples may also be analyzed by cold vapor atomic fluorescence spectrometry.

17.0 *References*

Same as Method 5, Section 17.0, References 1-3, 5, and 6, with the addition of the following:

1. Determining Dust Concentration in a Gas Stream. ASME Performance Test Code No. 27. New York, NY. 1957.

2. DeVorkin, Howard, *et al.* Air Pollution Source Testing Manual. Air Pollution Control District. Los Angeles, CA. November 1963.

3. Hatch, W.R., and W.I. Ott. Determination of Sub-Microgram Quantities of Mercury by Atomic Absorption Spectrophotometry. *Anal. Chem.* 40:2085-87. 1968.

4. Mark, L.S. *Mechanical Engineers' Handbook*. McGraw-Hill Book Co., Inc. New York, NY. 1951.

5. Western Precipitation Division of Joy Manufacturing Co. Methods for Determination of Velocity, Volume, Dust and Mist Content of Gases. Bulletin WP-50. Los Angeles, CA. 1968.

6. Perry, J.H. *Chemical Engineers' Handbook*. McGraw-Hill Book Co., Inc. New York, NY. 1960.

7. Shigehara, R.T., W.F. Todd, and W.S. Smith. Significance of Errors in Stack Sampling Measurements. *Stack Sampling News.* 1(3):6-18. September 1973.

8. Smith, W.S., R.T. Shigehara, and W.F. Todd. A Method of Interpreting Stack Sampling Data. *Stack Sampling News.* 1(2):8-17. August 1973.

9. Standard Method for Sampling Stacks for Particulate Matter. In: 1971 Annual Book of ASTM Standards, Part 23. ASTM Designation D 2928-71. Philadelphia, PA 1971.

10. Vennard, J.K. *Elementary Fluid Mechanics*. John Wiley and Sons, Inc. New York. 1947.

11. Mitchell, W.J. and M.R. Midgett. Improved Procedure for Determining Mercury Emissions from Mercury Cell Chlor-Alkali Plants. *J. APCA.* 26:674-677. July 1976.

12. Shigehara, R.T. Adjustments in the EPA Nomograph for Different Pitot Tube Coefficients and Dry Molecular Weights. *Stack Sampling News.* 2:4-11. October 1974.

13. Vollaro, R.F. Recommended Procedure for Sample Traverses in Ducts Smaller than 12 Inches in Diameter. U.S. Environmental Protection Agency, Emission Measurement Branch. Research Triangle Park, NC. November 1976.

14. Klein, R. and C. Hach. Standard Additions: Uses and Limitation in Spectrophotometric Measurements. *Amer. Lab.* 9:21. 1977.

15. Perkin Elmer Corporation. Analytical Methods for Atomic Absorption Spectrophotometry. Norwalk, Connecticut. September 1976.

18.0 Tables, Diagrams, Flowcharts, and Validation Data

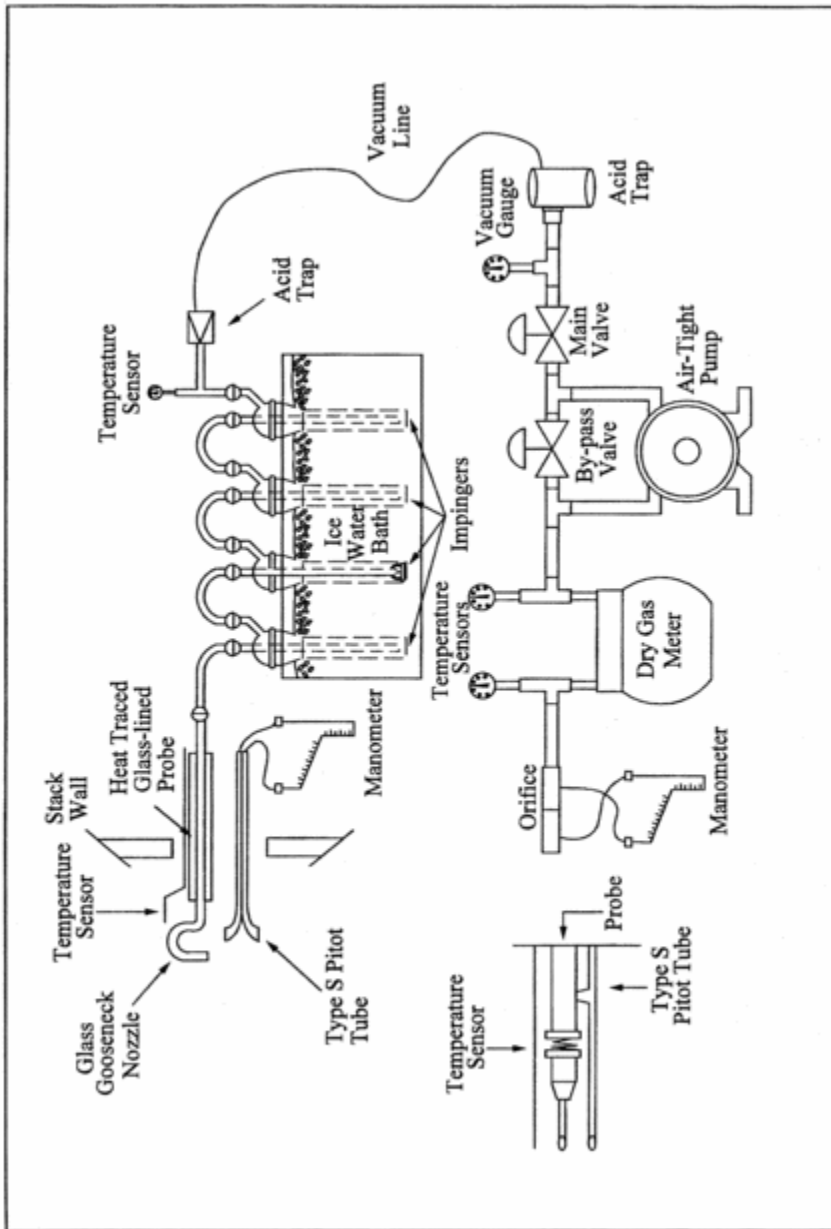

Figure 101-1. Mercury Sampling Train.

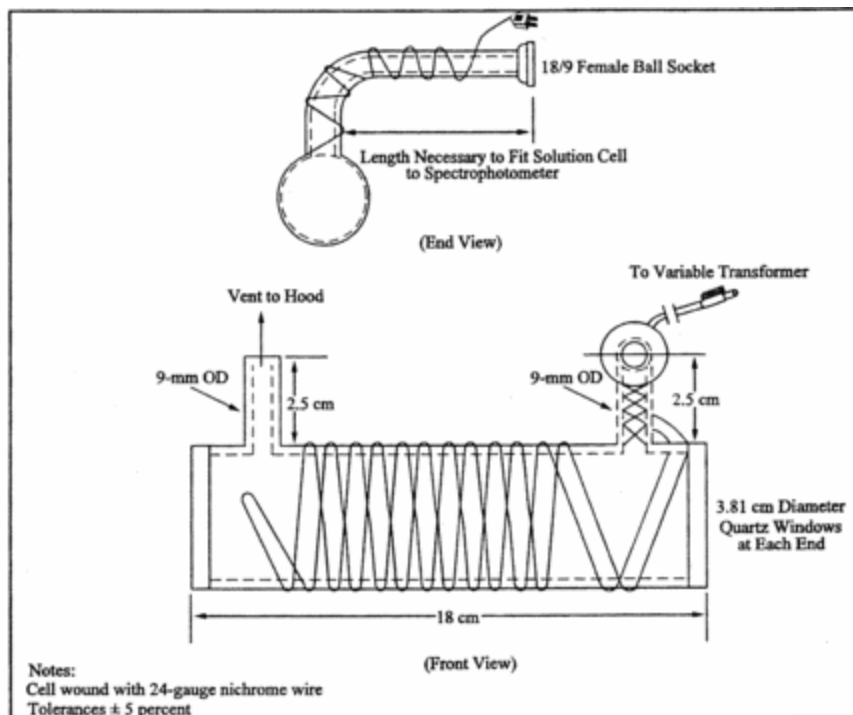

Figure 101-2. Optical Cell.



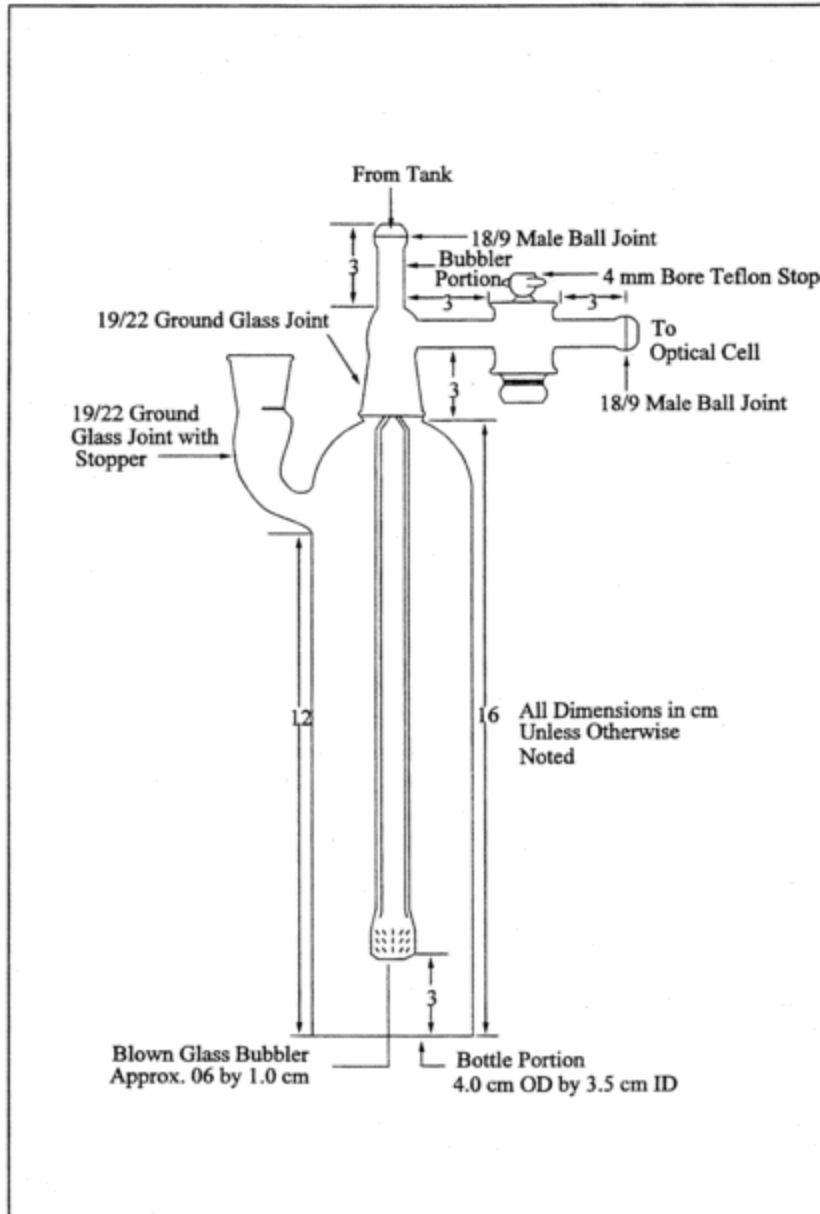

Figure 101-3. Aeration Cell.



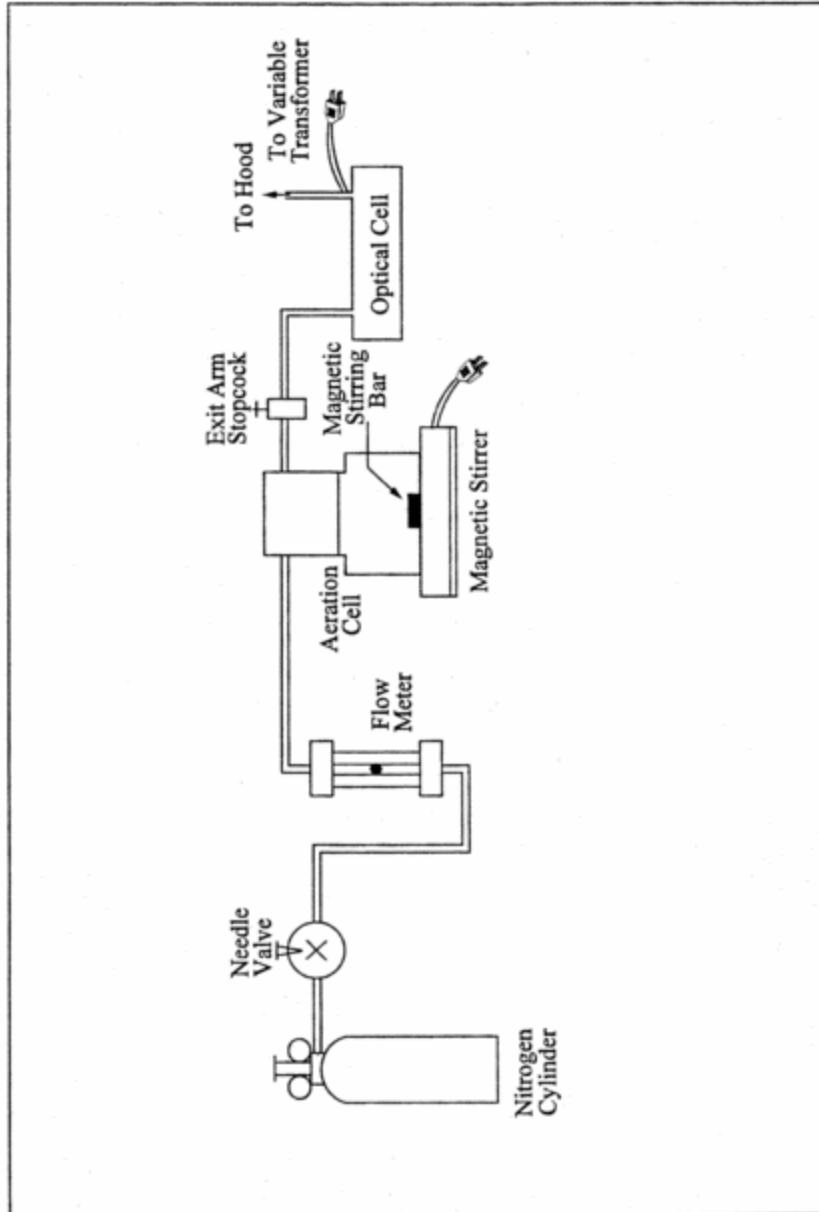

Figure 101-5. Schematic of Aeration System.

METHOD 101A—DETERMINATION OF PARTICULATE AND GASEOUS MERCURY EMISSIONS FROM SEWAGE SLUDGE INCINERATORS

NOTE: This method does not include all of the specifications (e.g., equipment and supplies) and procedures (e.g., sampling and analytical) essential to its performance. Some material is incorporated by reference from methods in appendix A to 40 CFR part 60 and in this part. Therefore, to obtain reliable results, persons using this method should also have a thorough knowledge of at least the following additional test methods: Methods 1, Method 2, Method 3, and Method 5 of part 60 (appendix A), and Method 101 part 61 (appendix B).

1.0 Scope and Application

1.1 Analytes.

| Analyte      | CAS No.   | Sensitivity                                    |
|--------------|-----------|--|
| Mercury (Hg) | 7439-97-6 | Dependent upon spectrophotometer and recorder. |

1.2 Applicability. This method is applicable for the determination of Hg emissions from sewage sludge incinerators and other sources as specified in an applicable subpart of the regulations.

1.3 Data Quality Objectives. Adherence to the requirements of this method will enhance the quality of the data obtained from air pollutant sampling methods.

## 2.0 Summary of Method

2.1 Particulate and gaseous Hg emissions are withdrawn isokinetically from the source and are collected in acidic potassium permanganate (KMnO<sub>4</sub>) solution. The Hg collected (in the mercuric form) is reduced to elemental Hg, which is then aerated from the solution into an optical cell and measured by atomic absorption spectrophotometry.

## 3.0 Definitions. [Reserved]

## 4.0 Interferences

4.1 Sample Collection. Excessive oxidizable organic matter in the stack gas prematurely depletes the KMnO<sub>4</sub> solution and thereby prevents further collection of Hg.

4.2 Analysis. Condensation of water vapor on the optical cell windows causes a positive interference.

## 5.0 Safety

5.1 Disclaimer. This method may involve hazardous materials, operations, and equipment. This test method may not address all of the safety problems associated with its use. It is the responsibility of the user of this test method to establish appropriate safety and health practices and determine the applicability of regulatory limitations prior to performing this test method.

5.2 Corrosive Reagents. The following reagents are hazardous. Personal protective equipment and safe procedures are useful in preventing chemical splashes. If contact occurs, immediately flush with copious amounts of water for at least 15 minutes. Remove clothing under shower and decontaminate. Treat residual chemical burns as thermal burns.

5.2.1 Hydrochloric Acid (HCl). Highly toxic. Vapors are highly irritating to eyes, skin, nose, and lungs, causing severe damage. May cause bronchitis, pneumonia, or edema of lungs. Exposure to concentrations of 0.13 to 0.2 percent can be lethal to humans in a few minutes. Provide ventilation to limit exposure. Reacts with metals, producing hydrogen gas.

5.2.2 Nitric Acid (HNO<sub>3</sub>). Highly corrosive to eyes, skin, nose, and lungs. Vapors cause bronchitis, pneumonia, or edema of lungs. Reaction to inhalation may be delayed as long as 30 hours and still be fatal. Provide ventilation to limit exposure. Strong oxidizer. Hazardous reaction may occur with organic materials such as solvents.

5.2.3 Sulfuric acid (H<sub>2</sub>SO<sub>4</sub>). Rapidly destructive to body tissue. Will cause third degree burns. Eye damage may result in blindness. Inhalation may be fatal from spasm of the larynx, usually within 30 minutes. May cause lung tissue damage with edema. 3 mg/m<sup>3</sup> will cause lung damage in uninitiated. 1

mg/m<sup>3</sup> for 8 hours will cause lung damage or, in higher concentrations, death. Provide ventilation to limit inhalation. Reacts violently with metals and organics.

5.3 Chlorine Evolution. Hydrochloric acid reacts with KMnO<sub>4</sub> to liberate chlorine gas. Although this is a minimal concern when small quantities of HCl (5-10 ml) are used in the impinger rinse, a potential safety hazard may still exist. At sources that emit higher concentrations of oxidizable materials (e.g., power plants), more HCl may be required to remove the larger amounts of brown deposit formed in the impingers. In such cases, the potential safety hazards due to sample container pressurization are greater, because of the larger volume of HCl rinse added to the recovered sample. These hazards are eliminated by storing and analyzing the HCl impinger wash separately from the permanganate impinger sample.

## 6.0 Equipment and Supplies

6.1 Sample Collection and Sample Recovery. Same as Method 101, Sections 6.1 and 6.2, respectively, with the following exceptions:

6.1.1 Probe Liner. Same as in Method 101, Section 6.1.2, except that if a filter is used ahead of the impingers, the probe heating system must be used to minimize the condensation of gaseous Hg.

6.1.2 Filter Holder (Optional). Borosilicate glass with a rigid stainless-steel wire-screen filter support (do not use glass frit supports) and a silicone rubber or Teflon gasket, designed to provide a positive seal against leakage from outside or around the filter. The filter holder must be equipped with a filter heating system capable of maintaining a temperature around the filter holder of 120 ±14 °C (248 ±25 °F) during sampling to minimize both water and gaseous Hg condensation. A filter may also be used in cases where the stream contains large quantities of particulate matter.

6.2 Sample Analysis. Same as Method 101, Section 6.3, with the following additions and exceptions:

6.2.1 Volumetric Pipets. Class A; 1-, 2-, 3-, 4-, 5-, 10-, and 20-ml.

6.2.2 Graduated Cylinder. 25-ml.

6.2.3 Steam Bath.

6.2.4 Atomic Absorption Spectrophotometer or Equivalent. Any atomic absorption unit with an open sample presentation area in which to mount the optical cell is suitable. Instrument settings recommended by the particular manufacturer should be followed. Instruments designed specifically for the measurement of mercury using the cold-vapor technique are commercially available and may be substituted for the atomic absorption spectrophotometer.

6.2.5 Optical Cell. Alternatively, a heat lamp mounted above the cell or a moisture trap installed upstream of the cell may be used.

6.2.6 Aeration Cell. Alternatively, aeration cells available with commercial cold vapor instrumentation may be used.

6.2.7 Aeration Gas Cylinder. Nitrogen, argon, or dry, Hg-free air, equipped with a single-stage regulator. Alternatively, aeration may be provided by a peristaltic metering pump. If a commercial cold vapor instrument is used, follow the manufacturer's recommendations.

## 7.0 Reagents and Standards

Unless otherwise indicated, it is intended that all reagents conform to the specifications established by the Committee on Analytical Reagents of the American Chemical Society, where such specifications are available; otherwise, use the best available grade.

7.1 Sample Collection and Recovery. The following reagents are required for sample collection and recovery:

7.1.1 Water. Deionized distilled, to conform to ASTM D 1193-77 or 91 Type 1. If high concentrations of organic matter are not expected to be present, the analyst may eliminate the  $\text{KMnO}_4$  test for oxidizable organic matter. Use this water in all dilutions and solution preparations.

7.1.2 Nitric Acid, 50 Percent (V/V). Mix equal volumes of concentrated  $\text{HNO}_3$  and water, being careful to add the acid to the water slowly.

7.1.3 Silica Gel. Indicating type, 6 to 16 mesh. If previously used, dry at  $175\text{ }^\circ\text{C}$  ( $350\text{ }^\circ\text{F}$ ) for 2 hours. New silica gel may be used as received.

7.1.4 Filter (Optional). Glass fiber filter, without organic binder, exhibiting at least 99.95 percent efficiency on  $0.3\text{-}\mu\text{m}$  dioctyl phthalate smoke particles. The filter in cases where the gas stream contains large quantities of particulate matter, but blank filters should be analyzed for Hg content.

7.1.5 Sulfuric Acid, 10 Percent (V/V). Carefully add and mix 100 ml of concentrated  $\text{H}_2\text{SO}_4$  to 900 ml of water.

7.1.6 Absorbing Solution, 4 Percent  $\text{KMnO}_4$  (W/V). Prepare fresh daily. Dissolve 40 g of  $\text{KMnO}_4$  in sufficient 10 percent  $\text{H}_2\text{SO}_4$  to make 1 liter. Prepare and store in glass bottles to prevent degradation.

7.1.7 Hydrochloric Acid, 8 N. Carefully add and mix 67 ml of concentrated HCl to 33 ml of water.

7.2 Sample Analysis. The following reagents and standards are required for sample analysis:

7.2.1 Water. Same as in Section 7.1.1.

7.2.2 Tin (II) Solution. Prepare fresh daily, and keep sealed when not being used. Completely dissolve 20 g of tin (II) chloride (or 25 g of tin (II) sulfate) crystals (Baker Analyzed reagent grade or any other brand that will give a clear solution) in 25 ml of concentrated HCl. Dilute to 250 ml with water. Do not substitute  $\text{HNO}_3$ ,  $\text{H}_2\text{SO}_4$ , or other strong acids for the HCl.

7.2.3 Sodium Chloride-Hydroxylamine Solution. Dissolve 12 g of sodium chloride and 12 g of hydroxylamine sulfate (or 12 g of hydroxylamine hydrochloride) in water and dilute to 100 ml.

7.2.4 Hydrochloric Acid, 8 N. Same as Section 7.1.7.

7.2.5 Nitric Acid, 15 Percent (V/V). Carefully add 15 ml  $\text{HNO}_3$  to 85 ml of water.

7.2.6 Antifoam B Silicon Emulsion. J.T. Baker Company (or equivalent).

7.2.7 Mercury Stock Solution, 1 mg Hg/ml. Prepare and store all Hg standard solutions in borosilicate glass containers. Completely dissolve 0.1354 g of Hg (II) chloride in 75 ml of water. Add 10 ml of concentrated  $\text{HNO}_3$ , and adjust the volume to exactly 100 ml with water. Mix thoroughly. This solution is stable for at least one month.

7.2.8 Intermediate Hg Standard Solution, 10 µg/ml. Prepare fresh weekly. Pipet 5.0 ml of the Hg stock solution (Section 7.2.7) into a 500 ml volumetric flask, and add 20 ml of 15 percent HNO<sub>3</sub> solution. Adjust the volume to exactly 500 ml with water. Thoroughly mix the solution.

7.2.9 Working Hg Standard Solution, 200 ng Hg/ml. Prepare fresh daily. Pipet 5.0 ml from the "Intermediate Hg Standard Solution" (Section 7.2.8) into a 250-ml volumetric flask. Add 5 ml of 4 percent KMnO<sub>4</sub> absorbing solution and 5 ml of 15 percent HNO<sub>3</sub>. Adjust the volume to exactly 250 ml with water. Mix thoroughly.

7.2.10 Potassium Permanganate, 5 Percent (W/V). Dissolve 5 g of KMnO<sub>4</sub> in water and dilute to 100 ml.

7.2.11 Filter. Whatman No. 40, or equivalent.

### *8.0 Sample Collection, Preservation, Transport, and Storage*

Same as Method 101, Section 8.0, with the exception of the following:

8.1 Preliminary Determinations. Same as Method 101, Section 8.2, except that the liberation of free iodine in the first impinger due to high Hg or sulfur dioxide concentrations is not applicable. In this method, high oxidizable organic content may make it impossible to sample for the desired minimum time. This problem is indicated by the complete bleaching of the purple color of the KMnO<sub>4</sub> solution. In cases where an excess of water condensation is encountered, collect two runs to make one sample, or add an extra impinger in front of the first impinger (also containing acidified KMnO<sub>4</sub> solution).

8.2 Preparation of Sampling Train. Same as Method 101, Section 8.3, with the exception of the following:

8.2.1 In this method, clean all the glass components by rinsing with 50 percent HNO<sub>3</sub>, tap water, 8 N HCl, tap water, and finally with deionized distilled water. Then place 50 ml of absorbing solution in the first impinger and 100 ml in each of the second and third impingers.

8.2.2 If a filter is used, use a pair of tweezers to place the filter in the filter holder. Be sure to center the filter, and place the gasket in the proper position to prevent the sample gas stream from bypassing the filter. Check the filter for tears after assembly is completed. Be sure also to set the filter heating system at the desired operating temperature after the sampling train has been assembled.

8.3 Sampling Train Operation. In addition to the procedure outlined in Method 101, Section 8.5, maintain a temperature around the filter (if applicable) of 120 ±14 °C (248 ±25 °F).

8.4 Sample Recovery. Same as Method 101, Section 8.7, with the exception of the following:

8.4.1 Transfer the probe, impinger assembly, and (if applicable) filter assembly to the cleanup area.

8.4.2 Treat the sample as follows:

8.4.2.1 Container No. 1 (Impinger, Probe, and Filter Holder) and, if applicable, Container No. 1A (HCl rinse).

8.4.2.1.1 Using a graduated cylinder, measure the liquid in the first three impingers to within 1 ml. Record the volume of liquid present (e.g., see Figure 5-6 of Method 5). This information is needed to calculate the moisture content of the effluent gas. (Use only graduated cylinder and glass storage bottles

that have been precleaned as in Section 8.2.1.) Place the contents of the first three impingers (four if an extra impinger was added as described in Section 8.1) into a 1000-ml glass sample bottle labeled Container No. 1.

NOTE: If a filter is used, remove the filter from its holder as outlined under Section 8.4.3.

8.4.2.1.2 Taking care that dust on the outside of the probe or other exterior surfaces does not get into the sample, quantitatively recover the Hg (and any condensate) from the probe nozzle, probe fitting, probe liner, front half of the filter holder (if applicable), and impingers as follows: Rinse these components with a total of 400 ml (350 ml if an extra impinger was added as described in Section 8.1) of fresh absorbing solution, carefully assuring removal of all loose particulate matter from the impingers; add all washings to the 1000 ml glass sample bottle. To remove any residual brown deposits on the glassware following the permanganate rinse, rinse with approximately 100 ml of water, carefully assuring removal of all loose particulate matter from the impingers. Add this rinse to Container No. 1.

8.4.2.1.3 If no visible deposits remain after this water rinse, do not rinse with 8 N HCl. If deposits do remain on the glassware after the water rinse, wash impinger walls and stems with 25 ml of 8 N HCl, and place the wash in a separate container labeled Container No. 1A as follows: Place 200 ml of water in a sample container labeled Container No. 1A. Wash the impinger walls and stem with the HCl by turning the impinger on its side and rotating it so that the HCl contacts all inside surfaces. Pour the HCl wash carefully with stirring into Container No. 1A.

8.4.2.1.4 After all washings have been collected in the appropriate sample container(s), tighten the lid(s) on the container(s) to prevent leakage during shipment to the laboratory. Mark the height of the fluid level to allow subsequent determination of whether leakage has occurred during transport. Label each container to identify its contents clearly.

8.4.3 Container No. 2 (Silica Gel). Same as Method 5, Section 8.7.6.3.

8.4.4 Container No. 3 (Filter). If a filter was used, carefully remove it from the filter holder, place it in a 100-ml glass sample bottle, and add 20 to 40 ml of absorbing solution. If it is necessary to fold the filter, be sure that the particulate cake is inside the fold. Carefully transfer to the 100-ml sample bottle any particulate matter and filter fibers that adhere to the filter holder gasket by using a dry Nylon bristle brush and a sharp-edged blade. Seal the container. Label the container to identify its contents clearly. Mark the height of the fluid level to allow subsequent determination of whether leakage has occurred during transport.

8.4.5 Container No. 4 (Filter Blank). If a filter was used, treat an unused filter from the same filter lot as that used for sampling according to the procedures outlined in Section 8.4.4.

8.4.6 Container No. 5 (Absorbing Solution Blank). Place 650 ml of 4 percent  $\text{KMnO}_4$  absorbing solution in a 1000-ml sample bottle. Seal the container.

8.4.7 Container No. 6 (HCl Rinse Blank). Place 200 ml of water in a 1000-ml sample bottle, and add 25 ml of 8 N HCl carefully with stirring. Seal the container. Only one blank sample per 3 runs is required.

## 9.0 Quality Control

### 9.1 Miscellaneous Quality Control Measures.

| Section | Quality control measure | Effect |
|---------|-------------------------|--------|
|---------|-------------------------|--------|



|              |  |  |
|--------------|--|--|
| 8.0,<br>10.0 | Sampling equipment leak-checks and calibration | Ensure accuracy and precision of sampling measurements.      |
| 10.2         | Spectrophotometer calibration                  | Ensure linearity of spectrophotometer response to standards. |
| 11.3.3       | Check for matrix effects                       | Eliminate matrix effects.                                    |

9.2 Volume Metering System Checks. Same as Method 5, Section 9.2.

### 10.0 Calibration and Standardization

Same as Method 101, Section 10.0, with the following exceptions:

10.1 Optical Cell Heating System Calibration. Same as in Method 101, Section 10.4, except use a 25 ml graduated cylinder to add 25 ml of water to the bottle section of the aeration cell.

10.2 Spectrophotometer and Recorder Calibration.

10.2.1 The Hg response may be measured by either peak height or peak area.

NOTE: The temperature of the solution affects the rate at which elemental Hg is released from a solution and, consequently, it affects the shape of the absorption curve (area) and the point of maximum absorbance (peak height). To obtain reproducible results, all solutions must be brought to room temperature before use.

10.2.2 Set the spectrophotometer wave length at 253.7 nm, and make certain the optical cell is at the minimum temperature that will prevent water condensation. Then set the recorder scale as follows: Using a 25-ml graduated cylinder, add 25 ml of water to the aeration cell bottle. Add three drops of Antifoam B to the bottle, and then pipet 5.0 ml of the working Hg standard solution into the aeration cell.

NOTE: Always add the Hg-containing solution to the aeration cell after the 25 ml of water.

10.2.3 Place a Teflon-coated stirring bar in the bottle. Add 5 ml of absorbing solution to the aeration bottle, and mix well. Before attaching the bottle section to the bubbler section of the aeration cell, make certain that (1) the aeration cell exit arm stopcock (Figure 101-3 of Method 101) is closed (so that Hg will not prematurely enter the optical cell when the reducing agent is being added) and (2) there is no flow through the bubbler. If conditions (1) and (2) are met, attach the bottle section to the bubbler section of the aeration cell. Add sodium chloride-hydroxylamine in 1 ml increments until the solution is colorless. Now add 5 ml of tin (II) solution to the aeration bottle through the side arm, and immediately stopper the side arm. Stir the solution for 15 seconds, turn on the recorder, open the aeration cell exit arm stopcock, and immediately initiate aeration with continued stirring. Determine the maximum absorbance of the standard, and set this value to read 90 percent of the recorder full scale.

### 11.0 Analytical Procedure

11.1 Sample Loss Check. Check the liquid level in each container to see if liquid was lost during transport. If a noticeable amount of leakage occurred, either void the sample or use methods subject to the approval of the Administrator to account for the losses.

11.2 Sample Preparation. Treat sample containers as follows:

11.2.1 Containers No. 3 and No. 4 (Filter and Filter Blank).

11.2.1.1 If a filter is used, place the contents, including the filter, of Containers No. 3 and No. 4 in separate 250-ml beakers, and heat the beakers on a steam bath until most of the liquid has evaporated. Do not heat to dryness. Add 20 ml of concentrated HNO<sub>3</sub> to the beakers, cover them with a watch glass, and heat on a hot plate at 70 °C (160 °F) for 2 hours. Remove from the hot plate.

11.2.1.2 Filter the solution from digestion of the Container No. 3 contents through Whatman No. 40 filter paper, and save the filtrate for addition to the Container No. 1 filtrate as described in Section 11.2.2. Discard the filter paper.

11.2.1.3 Filter the solution from digestion of the Container No. 4 contents through Whatman No. 40 filter paper, and save the filtrate for addition to Container No. 5 filtrate as described in Section 11.2.3 below. Discard the filter paper.

11.2.2 Container No. 1 (Impingers, Probe, and Filter Holder) and, if applicable, No. 1A (HCl rinse).

11.2.2.1 Filter the contents of Container No. 1 through Whatman No. 40 filter paper into a 1 liter volumetric flask to remove the brown manganese dioxide (MnO<sub>2</sub>) precipitate. Save the filter for digestion of the brown MnO<sub>2</sub> precipitate. Add the sample filtrate from Container No. 3 to the 1-liter volumetric flask, and dilute to volume with water. If the combined filtrates are greater than 1000 ml, determine the volume to the nearest ml and make the appropriate corrections for blank subtractions. Mix thoroughly. Mark the filtrate as analysis Sample No. A.1 and analyze for Hg within 48 hr of the filtration step. Place the saved filter, which was used to remove the brown MnO<sub>2</sub> precipitate, into an appropriate sized container. In a laboratory hood, add 25 ml of 8 N HCl to the filter and allow to digest for a minimum of 24 hours at room temperature.

11.2.2.2 Filter the contents of Container 1A through Whatman No. 40 filter paper into a 500-ml volumetric flask. Then filter the digestate of the brown MnO<sub>2</sub> precipitate from Container No. 1 through Whatman No. 40 filter paper into the same 500-ml volumetric flask, and dilute to volume with water. Mark this combined 500 ml dilute solution as analysis Sample No. A.2. Discard the filters.

11.2.3 Container No. 5 (Absorbing Solution Blank) and No. 6 (HCl Rinse Blank).

11.2.3.1 Treat Container No. 5 as Container No. 1 (as described in Section 11.2.2), except substitute the filter blank filtrate from Container No. 4 for the sample filtrate from Container No. 3, and mark as Sample A.1 Blank.

11.2.3.2 Treat Container No. 6 as Container No. 1A, (as described in Section 11.2.2, except substitute the filtrate from the digested blank MnO<sub>2</sub> precipitate for the filtrate from the digested sample MnO<sub>2</sub> precipitate, and mark as Sample No. A.2 Blank.

NOTE: When analyzing samples A.1 Blank and HCl A.2 Blank, always begin with 10 ml aliquots. This applies specifically to blank samples.

11.3 Analysis. Calibrate the analytical equipment and develop a calibration curve as outlined in Section 10.0.

11.3.1 Mercury Samples. Then repeat the procedure used to establish the calibration curve with appropriately sized aliquots (1 to 10 ml) of the samples (from Sections 11.2.2 and 11.2.3) until two consecutive peak heights agree within 3 percent of their average value. If the 10 ml sample is below the detectable limit, use a larger aliquot (up to 20 ml), but decrease the volume of water added to the aeration cell accordingly to prevent the solution volume from exceeding the capacity of the aeration bottle. If the peak maximum of a 1.0 ml aliquot is off scale, further dilute the original sample to bring the Hg concentration into the calibration range of the spectrophotometer. If the Hg content of the absorbing solution and filter blank is below the working range of the analytical method, use zero for the blank.

11.3.2 Run a blank and standard at least after every five samples to check the spectrophotometer calibration; recalibrate as necessary.

11.3.3 Check for Matrix Effects (optional). Same as Method 101, Section 11.3.3.

## 12.0 Data Analysis and Calculations

NOTE: Carry out calculations, retaining at least one extra decimal significant figure beyond that of the acquired data. Round off figures only after the final calculation. Other forms of the equations may be used as long as they give equivalent results.

### 12.1 Nomenclature.

$C_{(\text{filtr})\text{Hg}}$  = Total ng of Hg in aliquot of  $\text{KMnO}_4$  filtrate and  $\text{HNO}_3$  digestion of filter analyzed (aliquot of analysis Sample No. A.1).

$C_{(\text{filtr blk})\text{Hg}}$  = Total ng of Hg in aliquot of  $\text{KMnO}_4$  blank and  $\text{HNO}_3$  digestion of blank filter analyzed (aliquot of analysis Sample No. A.1 blank).

$C_{(\text{HCl blk})\text{Hg}}$  = Total ng of Hg analyzed in aliquot of the 500-ml analysis Sample No. HCl A.2 blank.

$C_{(\text{HCl})\text{Hg}}$  = Total ng of Hg analyzed in the aliquot from the 500-ml analysis Sample No. HCl A.2.

DF = Dilution factor for the HCl-digested Hg-containing solution, Analysis Sample No. "HCl A.2."

DF<sub>blk</sub> = Dilution factor for the HCl-digested Hg containing solution, Analysis Sample No. "HCl A.2 blank."  
(Refer to sample No. "HCl A.2" dilution factor above.)

$m_{(\text{filtr})\text{Hg}}$  = Total blank corrected  $\mu\text{g}$  of Hg in  $\text{KMnO}_4$  filtrate and  $\text{HNO}_3$  digestion of filter sample.

$m_{(\text{HCl})\text{Hg}}$  = Total blank corrected  $\mu\text{g}$  of Hg in HCl rinse and HCl digestate of filter sample.

$m_{\text{Hg}}$  = Total blank corrected Hg content in each sample,  $\mu\text{g}$ .

S = Aliquot volume of sample added to aeration cell, ml.

S<sub>blk</sub> = Aliquot volume of blank added to aeration cell, ml.

V<sub>f(blk)</sub> = Solution volume of blank sample, 1000 ml for samples diluted as described in Section 11.2.2.

V<sub>f(filtr)</sub> = Solution volume of original sample, normally 1000 ml for samples diluted as described in Section 11.2.2.

V<sub>f(HCl)</sub> = Solution volume of original sample, 500 ml for samples diluted as described in Section 11.2.1.

$10^{-3}$  = Conversion factor,  $\mu\text{g}/\text{ng}$ .

12.2 Average Dry Gas Meter Temperature and Average Orifice Pressure Drop, Dry Gas Volume, Volume of Water Vapor Condensed, Moisture Content, Isokinetic Variation, and Stack Gas Velocity and Volumetric Flow Rate. Same as Method 5, Sections 12.2 through 12.5, 12.11, and 12.12, respectively.

### 12.3 Total Mercury.

12.3.1 For each source sample, correct the average maximum absorbance of the two consecutive samples whose peak heights agree within 3 percent of their average for the contribution of the blank. Use the calibration curve and these corrected averages to determine the final total weight of Hg in ng in the aeration cell for each source sample.

12.3.2 Correct for any dilutions made to bring the sample into the working range of the spectrophotometer.

$$m_{(\text{HCl})\text{Hg}} = \frac{[C_{(\text{HCl})\text{Hg}}\text{DF}]}{S} - \frac{[C_{(\text{HCl})\text{Hg}}\text{DF}_{\text{blk}}]}{S_{\text{blk}}} V_{f(\text{HCl})} (10^{-3}) \quad \text{Eq. 101A-1}$$

NOTE: This dilution factor applies only to the intermediate dilution steps, since the original sample volume  $[(V_i)_{\text{HCl}}]$  of "HCl A.2" has been factored out in the equation along with the sample aliquot (S). In Eq. 101A-1, the sample aliquot, S, is introduced directly into the aeration cell for analysis according to the procedure outlined in Section 11.3.1. A dilution factor is required only if it is necessary to bring the sample into the analytical instrument's calibration range.

NOTE: The maximum allowable blank subtraction for the HCl is the lesser of the two following values: (1) the actual blank measured value (analysis Sample No. HCl A.2 blank), or (2) 5% of the Hg content in the combined HCl rinse and digested sample (analysis Sample No. HCl A.2).

$$m_{(\text{nr})\text{Hg}} = \frac{[C_{(\text{nr})\text{Hg}}\text{DF} V_{f(\text{nr})}]}{S} - \frac{[C_{(\text{nr})\text{Hg}}\text{DF}_{\text{blk}} V_{f(\text{blk})}]}{S_{\text{blk}}} \quad \text{Eq. 101A-2}$$

NOTE: The maximum allowable blank subtraction for the HCl is the lesser of the two following values: (1) the actual blank measured value (analysis Sample No. "A.1 blank"), or (2) 5% of the Hg content in the filtrate (analysis Sample No. "A.1").

$$m_{\text{Hg}} = m_{(\text{HCl})\text{Hg}} + m_{(\text{nr})\text{Hg}} \quad \text{Eq. 101A-3}$$

12.3 Mercury Emission Rate. Same as Method 101, Section 12.3.

12.4 Determination of Compliance. Same as Method 101, Section 12.4.

### 13.0 Method Performance

13.1 Precision. Based on eight paired-train tests, the intra-laboratory standard deviation was estimated to be 4.8  $\mu\text{g/ml}$  in the concentration range of 50 to 130  $\mu\text{g/m}^3$ .

13.2 Bias. [Reserved]

13.3 Range. After initial dilution, the range of this method is 20 to 800 ng Hg/ml. The upper limit can be extended by further dilution of the sample.

14.0 Pollution Prevention [Reserved]

15.0 Waste Management [Reserved]

### 16.0 Alternative Procedures

16.1 Alternative Analyzers.

16.1.1 Inductively coupled plasma-atomic emission spectrometry (ICP-AES) may be used as an alternative to atomic absorption analysis provided the following conditions are met:

16.1.1.1 Sample collection, sample preparation, and analytical preparation procedures are as defined in the method except as necessary for the ICP-AES application.

16.1.1.2 The quality control procedures are conducted as prescribed.

16.1.1.3 The limit of quantitation for the ICP-AES must be demonstrated and the sample concentrations reported should be no less than two times the limit of quantitation. The limit of quantitation is defined as ten times the standard deviation of the blank value. The standard deviation of the blank value is determined from the analysis of seven blanks. It has been reported that for mercury and those elements that form hydrides, a continuous-flow generator coupled to an ICP-AES offers detection limits comparable to cold vapor atomic absorption.

16.1.2 Samples may also be analyzed by cold vapor atomic fluorescence spectrometry.

### 17.0 References

Same as Section 16.0 of Method 101, with the addition of the following:

1. Mitchell, W.J., *et al.* Test Methods to Determine the Mercury Emissions from Sludge Incineration Plants. U.S. Environmental Protection Agency. Research Triangle Park, NC. Publication No. EPA-600/4-79-058. September 1979.

2. Wilshire, Frank W., *et al.* Reliability Study of the U.S. EPA's Method 101A—Determination of Particulate and Gaseous Mercury Emissions. U.S. Environmental Protection Agency. Research Triangle Park, NC. Report No. 600/D-31/219 AREAL 367, NTIS Acc No. PB91-233361.

3. Memorandum from William J. Mitchell to Roger T. Shigehara discussing the potential safety hazard in Section 7.2 of Method 101A. February 28, 1990.

### 18.0 Tables, Diagrams, Flowcharts, And Validation Data [Reserved]

#### METHOD 102—DETERMINATION OF PARTICULATE AND GASEOUS MERCURY EMISSIONS FROM CHLOR-ALKALI PLANTS (HYDROGEN STREAMS)

NOTE: This method does not include all of the specifications (*e.g.*, equipment and supplies) and procedures (*e.g.*, sampling and analytical) essential to its performance. Some material is incorporated by reference from other methods in this part and in appendix A to 40 CFR part 60. Therefore, to obtain reliable results, persons using this method should have a thorough knowledge of at least the following additional test methods: Method 1, Method 2, Method 3, Method 5, and Method 101.

### 1.0 Scope and Application

1.1 Analytes.

| Analyte      | CAS No.   | Sensitivity                                    |
|--------------|-----------|--|
| Mercury (Hg) | 7439-97-6 | Dependent upon recorder and spectrophotometer. |

1.2 Applicability. This method is applicable for the determination of Hg emissions, including both particulate and gaseous Hg, from chlor-alkali plants and other sources (as specified in the regulations) where the carrier-gas stream in the duct or stack is principally hydrogen.

1.3 Data Quality Objectives. Adherence to the requirements of this method will enhance the quality of the data obtained from air pollutant sampling methods.

### 2.0 Summary of Method

2.1 Particulate and gaseous Hg emissions are withdrawn isokinetically from the source and collected in acidic iodine monochloride (ICI) solution. The Hg collected (in the mercuric form) is reduced to elemental Hg, which is then aerated from the solution into an optical cell and measured by atomic absorption spectrophotometry.

### 3.0 *Definitions [Reserved]*

### 4.0 *Interferences*

Same as Method 101, Section 4.2.

### 5.0 *Safety*

5.1 Disclaimer. This method may involve hazardous materials, operations, and equipment. This test method may not address all of the safety problems associated with its use. It is the responsibility of the user of this test method to establish appropriate safety and health practices and determine the applicability of regulatory limitations prior to performing this test method.

5.2 Corrosive Reagents. Same as Method 101, Section 5.2.

5.3 Explosive Mixtures. The sampler must conduct the source test under conditions of utmost safety because hydrogen and air mixtures are explosive. Since the sampling train essentially is leakless, attention to safe operation can be concentrated at the inlet and outlet. If a leak does occur, however, remove the meter box cover to avoid a possible explosive mixture. The following specific precautions are recommended:

5.3.1 Operate only the vacuum pump during the test. The other electrical equipment, e.g., heaters, fans, and timers, normally are not essential to the success of a hydrogen stream test.

5.3.2 Seal the sample port to minimize leakage of hydrogen from the stack.

5.3.3 Vent sampled hydrogen at least 3 m (10 ft) away from the train. This can be accomplished by attaching a 13-mm (0.50-in.) ID Tygon tube to the exhaust from the orifice meter.

NOTE: A smaller ID tubing may cause the orifice meter calibration to be erroneous. Take care to ensure that the exhaust line is not bent or pinched.

### 6.0 *Equipment and Supplies*

Same as Method 101, Section 6.0, with the exception of the following:

6.1 Probe Heating System. Do not use, unless otherwise specified.

6.2 Glass Fiber Filter. Do not use, unless otherwise specified.

### 7.0 *Reagents and Standards*

Same as Method 101, Section 7.0.

### 8.0 *Sample Collection, Preservation, Transport, and Storage*

Same as Method 101, Section 8.0, with the exception of the following:

## 8.1 Setting of Isokinetic Rates.

8.1.1 If a nomograph is used, take special care in the calculation of the molecular weight of the stack gas and in the setting of the nomograph to maintain isokinetic conditions during sampling (Sections 8.1.1.1 through 8.1.1.3 below).

8.1.1.1 Calibrate the meter box orifice. Use the techniques described in APTD-0576 (see Reference 9 in Section 17.0 of Method 5 of appendix A to part 60). Calibration of the orifice meter at flow conditions that simulate the conditions at the source is suggested. Calibration should either be done with hydrogen or with some other gas having a similar Reynolds Number so that there is similarity between the Reynolds Numbers during calibration and during sampling. Alternative mercury-free thermometers may be used if the thermometers are, at a minimum, equivalent in terms of performance or suitably effective for the specific temperature measurement application.

8.1.1.2 The nomograph described in APTD-0576 cannot be used to calculate the C factor because the nomograph is designed for use when the stack gas dry molecular weight is  $29 \pm 4$ . Instead, the following calculation should be made to determine the proper C factor:

$$C = 0.00154 \Delta H_{\text{H}_2\text{O}} \text{ @ } C_p \sqrt{T_m} (P_s/P_m) \frac{(1 - B_{ws})^2}{(1 - B_{ws}) + 18B_{ws}} \quad \text{Eq. 102-1}$$

Where:

$B_{ws}$  = Fraction by volume of water vapor in the stack gas.

$C_p$  = Pitot tube calibration coefficient, dimensionless.

$M_d$  = Dry molecular weight of stack gas, lb/lb-mole.

$P_s$  = Absolute pressure of stack gas, in. Hg.

$P_m$  = Absolute pressure of gas at the meter, in. Hg.

$T_m$  = Absolute temperature of gas at the orifice, °R.

$\Delta H_{\text{H}_2\text{O}}$  = Meter box calibration factor obtained in Section 8.1.1.1, in. H<sub>2</sub>O.

0.00154 = (in. H<sub>2</sub>O/°R).

NOTE: This calculation is left in English units, and is not converted to metric units because nomographs are based on English units.

8.1.1.3 Set the calculated C factor on the operating nomograph, and select the proper nozzle diameter and K factor as specified in APTD-0576. If the C factor obtained in Section 8.1.1.2 exceeds the values specified on the existing operating nomograph, expand the C scale logarithmically so that the values can be properly located.

8.1.2 If a calculator is used to set isokinetic rates, it is suggested that the isokinetic equation presented in Reference 13 in Section 17.0 of Method 101 be consulted.

8.2 Sampling in Small (<12-in. Diameter) Stacks. When the stack diameter (or equivalent diameter) is less than 12 inches, conventional pitot tube-probe assemblies should not be used. For sampling guidelines, see Reference 14 in Section 17.0 of Method 101.

## 9.0 Quality Control

Same as Method 101, Section 9.0.

*10.0 Calibration and Standardizations*

Same as Method 101, Section 10.0.

*11.0 Analytical Procedure*

Same as Method 101, Section 11.0.

*12.0 Data Analysis and Calculations*

Same as Method 101, Section 12.0.

*13.0 Method Performance*

Same as Method 101, Section 13.0.

13.1 Analytical Range. After initial dilution, the range of this method is 0.5 to 120 µg Hg/ml. The upper limit can be extended by further dilution of the sample.

*14.0 Pollution Prevention. [Reserved]*

*15.0 Waste Management. [Reserved]*

*16.0 References*

Same as Method 101, Section 16.0.

*17.0 Tables, Diagrams, Flowcharts, and Validation Data. [Reserved]*

METHOD 103—BERYLLIUM SCREENING METHOD

*1.0 Scope and Application*

1.1 Analytes.

| <b>Analyte</b> | <b>CAS No.</b> | <b>Sensitivity</b>                        |
|----------------|----------------|---|
| Beryllium (Be) | 7440-41-7      | Dependent upon analytical procedure used. |

1.2 Applicability. This procedure details guidelines and requirements for methods acceptable for use in determining Be emissions in ducts or stacks at stationary sources.

1.3 Data Quality Objectives. Adherence to the requirements of this method will enhance the quality of the data obtained from air pollutant sampling methods.

*2.0 Summary of Method*

2.1 Particulate Be emissions are withdrawn isokinetically from three points in a duct or stack and are collected on a filter. The collected sample is analyzed for Be using an appropriate technique.



### 3.0 Definitions. [Reserved]

### 4.0 Interferences. [Reserved]

### 5.0 Safety

5.1 Disclaimer. This method may involve hazardous materials, operations, and equipment. This test method may not address all of the safety problems associated with its use. It is the responsibility of the user of this test method to establish appropriate safety and health practices and determine the applicability of regulatory limitations prior to performing this test method.

5.2 Hydrochloric Acid (HCl). Highly corrosive and toxic. Vapors are highly irritating to eyes, skin, nose, and lungs, causing severe damage. May cause bronchitis, pneumonia, or edema of lungs. Exposure to concentrations of 0.13 to 0.2 percent can be lethal to humans in a few minutes. Provide ventilation to limit exposure. Reacts with metals, producing hydrogen gas. Personal protective equipment and safe procedures are useful in preventing chemical splashes. If contact occurs, immediately flush with copious amounts of water at least 15 minutes. Remove clothing under shower and decontaminate. Treat residual chemical burn as thermal burn.

### 6.0 Equipment and Supplies

6.1 Sample Collection. A schematic of the required sampling train configuration is shown in Figure 103-1 in Section 17.0. The essential components of the train are as follows:

6.1.1 Nozzle. Stainless steel, or equivalent, with sharp, tapered leading edge.

6.1.2 Probe. Sheathed borosilicate or quartz glass tubing.

6.1.3 Filter. Millipore AA, or equivalent, with appropriate filter holder that provides a positive seal against leakage from outside or around the filter. It is suggested that a Whatman 41, or equivalent, be placed immediately against the back side of the Millipore filter as a guard against breakage of the Millipore. Include the backup filter in the analysis. To be equivalent, other filters shall exhibit at least 99.95 percent efficiency (0.05 percent penetration) on 0.3 micron dioctyl phthalate smoke particles, and be amenable to the Be analysis procedure. The filter efficiency tests shall be conducted in accordance with ASTM D 2986-71, 78, 95a (incorporated by reference—see §61.18). Test data from the supplier's quality control program are sufficient for this purpose.

6.1.4 Meter-Pump System. Any system that will maintain isokinetic sampling rate, determine sample volume, and is capable of a sampling rate of greater than 14 lpm (0.5 cfm).

6.2 Measurement of Stack Conditions. The following equipment is used to measure stack conditions:

6.2.1 Pitot Tube. Type S, or equivalent, with a constant coefficient ( $\pm 5$  percent) over the working range.

6.2.2 Inclined Manometer, or Equivalent. To measure velocity head to  $\pm 10$  percent of the minimum value.

6.2.3 Temperature Measuring Device. To measure stack temperature to  $\pm 1.5$  percent of the minimum absolute stack temperature.

6.2.4 Pressure Measuring Device. To measure stack pressure to  $\pm 2.5$  mm Hg (0.1 in. Hg).

6.2.5 Barometer. To measure atmospheric pressure to  $\pm 2.5$  mm Hg (0.1 in. Hg).

6.2.6 Wet and Dry Bulb Thermometers, Drying Tubes, Condensers, or Equivalent. To determine stack gas moisture content to  $\pm 1$  percent.

6.3 Sample Recovery.

6.3.1 Probe Cleaning Equipment. Probe brush or cleaning rod at least as long as probe, or equivalent. Clean cotton balls, or equivalent, should be used with the rod.

6.3.2 Leakless Glass Sample Bottles. To contain sample.

6.4 Analysis. All equipment necessary to perform an atomic absorption, spectrographic, fluorometric, chromatographic, or equivalent analysis.

## 7.0 Reagents and Standards

7.1 Sample Recovery.

7.1.1 Water. Deionized distilled, to conform to ASTM D 1193-77, 91 (incorporated by reference—see §61.18), Type 3.

7.1.2 Acetone. Reagent grade.

7.1.3 Wash Acid, 50 Percent (V/V) Hydrochloric Acid (HCl). Mix equal volumes of concentrated HCl and water, being careful to add the acid slowly to the water.

7.2 Analysis. Reagents and standards as necessary for the selected analytical procedure.

## 8.0 Sample Collection, Preservation, Transport, and Storage

Guidelines for source testing are detailed in the following sections. These guidelines are generally applicable; however, most sample sites differ to some degree and temporary alterations such as stack extensions or expansions often are required to insure the best possible sample site. Further, since Be is hazardous, care should be taken to minimize exposure. Finally, since the total quantity of Be to be collected is quite small, the test must be carefully conducted to prevent contamination or loss of sample.

8.1 Selection of a Sampling Site and Number of Sample Runs. Select a suitable sample site that is as close as practicable to the point of atmospheric emission. If possible, stacks smaller than one foot in diameter should not be sampled.

8.1.1 Ideal Sampling Site. The ideal sampling site is at least eight stack or duct diameters downstream and two diameters upstream from any flow disturbance such as a bend, expansion or contraction. For rectangular cross sections, use Equation 103-1 in Section 12.2 to determine an equivalent diameter,  $D_e$ .

8.1.2 Alternate Sampling Site. Some sampling situations may render the above sampling site criteria impractical. In such cases, select an alternate site no less than two diameters downstream and one-half diameter upstream from any point of flow disturbance. Additional sample runs are recommended at any sample site not meeting the criteria of Section 8.1.1.

8.1.3 Number of Sample Runs Per Test. Three sample runs constitute a test. Conduct each run at one of three different points. Select three points that proportionately divide the diameter, or are located at 25, 50, and 75 percent of the diameter from the inside wall. For horizontal ducts, sample on a vertical line through the centroid. For rectangular ducts, sample on a line through the centroid and parallel to a side. If additional sample runs are performed per Section 8.1.2, proportionately divide the duct to accommodate the total number of runs.

8.2 Measurement of Stack Conditions. Using the equipment described in Section 6.2, measure the stack gas pressure, moisture, and temperature to determine the molecular weight of the stack gas. Sound engineering estimates may be made in lieu of direct measurements. Describe the basis for such estimates in the test report.

### 8.3 Preparation of Sampling Train.

8.3.1 Assemble the sampling train as shown in Figure 103-1. It is recommended that all glassware be precleaned by soaking in wash acid for two hours.

8.3.2 Leak check the sampling train at the sampling site. The leakage rate should not be in excess of 1 percent of the desired sample rate.

### 8.4 Sampling Train Operation.

8.4.1 For each run, measure the velocity at the selected sampling point. Determine the isokinetic sampling rate. Record the velocity head and the required sampling rate. Place the nozzle at the sampling point with the tip pointing directly into the gas stream. Immediately start the pump and adjust the flow to isokinetic conditions. At the conclusion of the test, record the sampling rate. Again measure the velocity head at the sampling point. The required isokinetic rate at the end of the period should not have deviated more than 20 percent from that originally calculated. Describe the reason for any deviation beyond 20 percent in the test report.

8.4.2 Sample at a minimum rate of 14 liters/min (0.5 cfm). Obtain samples over such a period or periods of time as are necessary to determine the maximum emissions which would occur in a 24-hour period. In the case of cyclic operations, perform sufficient sample runs so as to allow determination or calculation of the emissions that occur over the duration of the cycle. A minimum sampling time of two hours per run is recommended.

### 8.5 Sample Recovery.

8.5.1 It is recommended that all glassware be precleaned as in Section 8.3. Sample recovery should also be performed in an area free of possible Be contamination. When the sampling train is moved, exercise care to prevent breakage and contamination. Set aside a portion of the acetone used in the sample recovery as a blank for analysis. The total amount of acetone used should be measured for accurate blank correction. Blanks can be eliminated if prior analysis shows negligible amounts.

8.5.2 Remove the filter (and backup filter, if used) and any loose particulate matter from filter holder, and place in a container.

8.5.3 Clean the probe with acetone and a brush or long rod and cotton balls. Wash into the container with the filter. Wash out the filter holder with acetone, and add to the same container.

## 9.0 Quality Control. [Reserved]

## 10.0 Calibration and Standardization

10.1 Sampling Train. As a procedural check, compare the sampling rate regulation with a dry gas meter, spirometer, rotameter (calibrated for prevailing atmospheric conditions), or equivalent, attached to the nozzle inlet of the complete sampling train.

10.2 Analysis. Perform the analysis standardization as suggested by the manufacturer of the instrument, or the procedures for the analytical method in use.

### 11.0 Analytical Procedure

Make the necessary preparation of samples and analyze for Be. Any currently acceptable method (e.g., atomic absorption, spectrographic, fluorometric, chromatographic) may be used.

### 12.0 Data Analysis and Calculations

12.1 Nomenclature.

$A_s$  (avg) = Stack area,  $m^2$  ( $ft^2$ ).

L = Length.

R = Be emission rate, g/day.

$V_s$  (avg) = Average stack gas velocity, m/sec ( $ft/sec$ ).

$V_{total}$  = Total volume of gas sampled,  $m^3$  ( $ft^3$ ).

W = Width.

$W_t$  = Total weight of Be collected, mg.

$10^{-6}$  = Conversion factor, g/ $\mu g$ .

86,400 = Conversion factor, sec/day.

12.2 Calculate the equivalent diameter,  $D_e$ , for a rectangular cross section as follows:

$$D_e = \frac{2 \cdot L \cdot W}{L + W} \quad \text{Eq. 103-1}$$

12.3 Calculate the Be emission rate, R, in g/day for each stack using Equation 103-2. For cyclic operations, use only the time per day each stack is in operation. The total Be emission rate from a source is the summation of results from all stacks.

$$R = \frac{W_t V_s (\text{avg}) A_s (86,400) (10^{-6})}{V_{total}} \quad \text{Eq. 103-2}$$

12.4 Test Report. Prepare a test report that includes as a minimum: A detailed description of the sampling train used, results of the procedural check described in Section 10.1 with all data and calculations made, all pertinent data taken during the test, the basis for any estimates made, isokinetic sampling calculations, and emission results. Include a description of the test site, with a block diagram and brief description of the process, location of the sample points in the stack cross section, and stack dimensions and distances from any point of disturbance.

### 13.0 Method Performance. [Reserved]

14.0 Pollution Prevention. [Reserved]

15.0 Waste Management. [Reserved]

16.0 References. [Reserved]

17.0 Tables, Diagrams, Flow Charts, and Validation Data

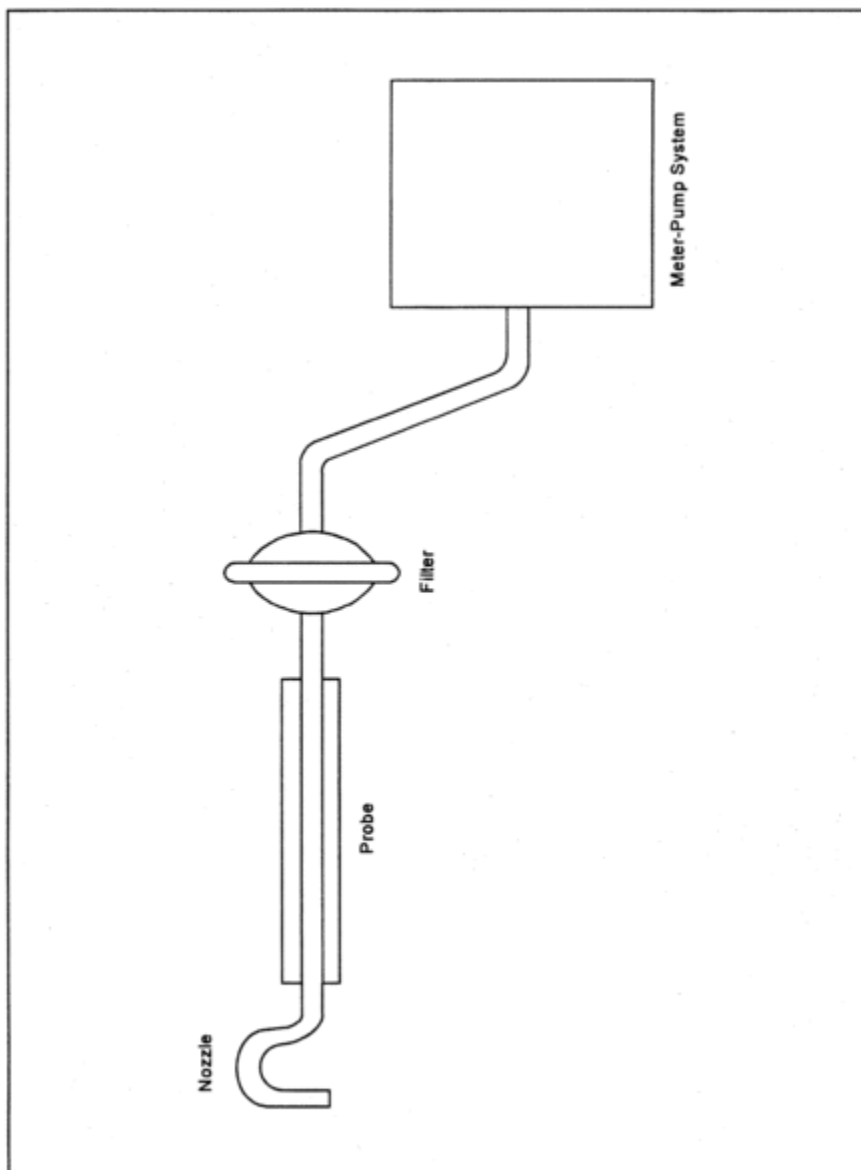

Figure 103-1. Beryllium Screening Method Sampling Train Schematic.

#### METHOD 104—DETERMINATION OF BERYLLIUM EMISSIONS FROM STATIONARY SOURCES

NOTE: This method does not include all of the specifications (e.g., equipment and supplies) and procedures (e.g., sampling and analytical) essential to its performance. Some material is incorporated by reference from methods in appendix A to 40 CFR part 60. Therefore, to obtain reliable results, persons using this method should have a thorough knowledge of at least the following additional test methods: Method 1, Method 2, Method 3, and Method 5 in appendix A, part 60.

## 1.0 Scope and Application

### 1.1 Analytes.

| Analyte        | CAS No.   | Sensitivity                                    |
|----------------|-----------|--|
| Beryllium (Be) | 7440-41-7 | Dependent upon recorder and spectrophotometer. |

1.2 Applicability. This method is applicable for the determination of Be emissions in ducts or stacks at stationary sources. Unless otherwise specified, this method is not intended to apply to gas streams other than those emitted directly to the atmosphere without further processing.

1.3 Data Quality Objectives. Adherences to the requirements of this method will enhance the quality of the data obtained from air pollutant sampling methods.

## 2.0 Summary of Method

2.1 Particulate and gaseous Be emissions are withdrawn isokinetically from the source and are collected on a glass fiber filter and in water. The collected sample is digested in an acid solution and is analyzed by atomic absorption spectrophotometry.

## 3.0 Definitions [Reserved]

## 4.0 Interferences

4.1 Matrix Effects. Analysis for Be by flame atomic absorption spectrophotometry is sensitive to the chemical composition and to the physical properties (e.g., viscosity, pH) of the sample. Aluminum and silicon, in particular, are known to interfere when present in appreciable quantities. The analytical procedure includes (optionally) the use of the Method of Standard Additions to check for these matrix effects, and sample analysis using the Method of Standard Additions if significant matrix effects are found to be present (see Reference 2 in Section 17.0).

## 5.0 Safety

5.1 Disclaimer. This method may involve hazardous materials, operations, and equipment. This test method may not address all of the safety problems associated with its use. It is the responsibility of the user of this test method to establish appropriate safety and health practices and determine the applicability of regulatory limitations prior to performing this test method.

5.2 Corrosive reagents. The following reagents are hazardous. Personal protective equipment and safe procedures are useful in preventing chemical splashes. If contact occurs, immediately flush with copious amounts of water at least 15 minutes. Remove clothing under shower and decontaminate. Treat residual chemical burn as thermal burn.

5.2.1 Hydrochloric Acid (HCl). Highly toxic. Vapors are highly irritating to eyes, skin, nose, and lungs, causing severe damage. May cause bronchitis, pneumonia, or edema of lungs. Exposure to concentrations of 0.13 to 0.2 percent can be lethal to humans in a few minutes. Provide ventilation to limit exposure. Reacts with metals, producing hydrogen gas.

5.2.2 Hydrogen Peroxide (H<sub>2</sub>O<sub>2</sub>). Irritating to eyes, skin, nose, and lungs.

5.2.3 Nitric Acid ( $\text{HNO}_3$ ). Highly corrosive to eyes, skin, nose, and lungs. Vapors cause bronchitis, pneumonia, or edema of lungs. Reaction to inhalation may be delayed as long as 30 hours and still be fatal. Provide ventilation to limit exposure. Strong oxidizer. Hazardous reaction may occur with organic materials such as solvents.

5.2.4 Sodium Hydroxide ( $\text{NaOH}$ ). Causes severe damage to eyes and skin. Inhalation causes irritation to nose, throat, and lungs. Reacts exothermically with limited amounts of water.

5.3 Beryllium is hazardous, and precautions should be taken to minimize exposure.

## 6.0 Equipment and Supplies

6.1 Sample Collection. Same as Method 5, Section 6.1, with the exception of the following:

6.1.1 Sampling Train. Same as Method 5, Section 6.1.1, with the exception of the following:

6.1.2 Probe Liner. Borosilicate or quartz glass tubing. A heating system capable of maintaining a gas temperature of  $120 \pm 14$  °C ( $248 \pm 25$  °F) at the probe exit during sampling to prevent water condensation may be used.

NOTE: Do not use metal probe liners.

6.1.3 Filter Holder. Borosilicate glass, with a glass frit filter support and a silicone rubber gasket. Other materials of construction (e.g., stainless steel, Teflon, Viton) may be used, subject to the approval of the Administrator. The holder design shall provide a positive seal against leakage from the outside or around the filter. The holder shall be attached immediately at the outlet of the probe. A heating system capable of maintaining the filter at a minimum temperature in the range of the stack temperature may be used to prevent condensation from occurring.

6.1.4 Impingers. Four Greenburg-Smith impingers connected in series with leak-free ground glass fittings or any similar leak-free noncontaminating fittings. For the first, third, and fourth impingers, use impingers that are modified by replacing the tip with a 13 mm-ID (0.5 in.) glass tube extending to 13 mm (0.5 in.) from the bottom of the flask may be used.

6.2 Sample Recovery. The following items are needed for sample recovery:

6.2.1 Probe Cleaning Rod. At least as long as probe.

6.2.2 Glass Sample Bottles. Leakless, with Teflon-lined caps, 1000 ml.

6.2.3 Petri Dishes. For filter samples, glass or polyethylene, unless otherwise specified by the Administrator.

6.2.4 Graduated Cylinder. 250 ml.

6.2.5 Funnel and Rubber Policeman. To aid in transfer of silica gel to container; not necessary if silica gel is weighed in the field.

6.2.6 Funnel. Glass, to aid in sample recovery.

6.2.7 Plastic Jar. Approximately 300 ml.

6.3 Analysis. The following items are needed for sample analysis:

6.3.1 Atomic Absorption Spectrophotometer. Perkin-Elmer 303, or equivalent, with nitrous oxide/acetylene burner.

6.3.2 Hot Plate.

6.3.3 Perchloric Acid Fume Hood.

## 7.0 Reagents and Standards

NOTE: Unless otherwise indicated, it is intended that all reagents conform to the specifications established by the Committee on Analytical Reagents of the American Chemical Society, where such specifications are available; otherwise, use the best available grade.

7.1 Sample Collection. Same as Method 5, Section 7.1, including deionized distilled water conforming to ASTM D 1193-77 or 91 (incorporated by reference—see §61.18), Type 3. The Millipore AA filter is recommended.

7.2 Sample Recovery. Same as Method 5 in appendix A, part 60, Section 7.2, with the addition of the following:

7.2.1 Wash Acid, 50 Percent (V/V) Hydrochloric Acid (HCl). Mix equal volumes of concentrated HCl and water, being careful to add the acid slowly to the water.

7.3 Sample Preparation and Analysis. The following reagents and standards and standards are needed for sample preparation and analysis:

7.3.1 Water. Same as in Section 7.1.

7.3.2. Perchloric Acid ( $\text{HClO}_4$ ). Concentrated (70 percent V/V).

7.3.3 Nitric Acid ( $\text{HNO}_3$ ). Concentrated.

7.3.4 Beryllium Powder. Minimum purity 98 percent.

7.3.5 Sulfuric Acid ( $\text{H}_2\text{SO}_4$ ) Solution, 12 N. Dilute 33 ml of concentrated  $\text{H}_2\text{SO}_4$  to 1 liter with water.

7.3.6 Hydrochloric Acid Solution, 25 Percent HCl (V/V).

7.3.7 Stock Beryllium Standard Solution, 10  $\mu\text{g}$  Be/ml. Dissolve 10.0 mg of Be in 80 ml of 12 N  $\text{H}_2\text{SO}_4$  in a 1000-ml volumetric flask. Dilute to volume with water. This solution is stable for at least one month. Equivalent strength Be stock solutions may be prepared from Be salts such as  $\text{BeCl}_2$  and  $\text{Be}(\text{NO}_3)_2$  (98 percent minimum purity).

7.3.8 Working Beryllium Standard Solution, 1  $\mu\text{g}$  Be/ml. Dilute a 10 ml aliquot of the stock beryllium standard solution to 100 ml with 25 percent HCl solution to give a concentration of 1 mg/ml. Prepare this dilute stock solution fresh daily.

## 8.0 Sample Collection, Preservation, Transport, and Storage



The amount of Be that is collected is generally small, therefore, it is necessary to exercise particular care to prevent contamination or loss of sample.

8.1 Pretest Preparation. Same as Method 5, Section 8.1, except omit Section 8.1.3.

8.2 Preliminary Determinations. Same as Method 5, Section 8.2, with the exception of the following:

8.2.1 Select a nozzle size based on the range of velocity heads to assure that it is not necessary to change the nozzle size in order to maintain isokinetic sampling rates below 28 liters/min (1.0 cfm).

8.2.2 Obtain samples over a period or periods of time that accurately determine the maximum emissions that occur in a 24-hour period. In the case of cyclic operations, perform sufficient sample runs for the accurate determination of the emissions that occur over the duration of the cycle. A minimum sample time of 2 hours per run is recommended.

8.3 Preparation of Sampling Train. Same as Method 5, Section 8.3, with the exception of the following:

8.3.1 Prior to assembly, clean all glassware (probe, impingers, and connectors) by first soaking in wash acid for 2 hours, followed by rinsing with water.

8.3.2 Save a portion of the water for a blank analysis.

8.3.3 Procedures relating to the use of metal probe liners are not applicable.

8.3.4 Probe and filter heating systems are needed only if water condensation is a problem. If this is the case, adjust the heaters to provide a temperature at or above the stack temperature. However, membrane filters such as the Millipore AA are limited to about 107 °C (225 °F). If the stack gas is in excess of about 93 °C (200 °F), consideration should be given to an alternate procedure such as moving the filter holder downstream of the first impinger to insure that the filter does not exceed its temperature limit. After the sampling train has been assembled, turn on and set the probe heating system, if applicable, at the desired operating temperature. Allow time for the temperatures to stabilize. Place crushed ice around the impingers.

NOTE: An empty impinger may be inserted between the third impinger and the silica gel to remove excess moisture from the sample stream.

8.4 Leak Check Procedures, Sampling Train Operation, and Calculation of Percent Isokinetic. Same as Method 5, Sections 8.4, 8.5, and 8.6, respectively.

8.5 Sample Recovery. Same as Method 5, Section 8.7, except treat the sample as follows: Transfer the probe and impinger assembly to a cleanup area that is clean, protected from the wind, and free of Be contamination. Inspect the train before and during this assembly, and note any abnormal conditions. Treat the sample as follows: Disconnect the probe from the impinger train.

8.5.1 Container No. 1. Same as Method 5, Section 8.7.6.1.

8.5.2 Container No. 2. Place the contents (measured to 1 ml) of the first three impingers into a glass sample bottle. Use the procedures outlined in Section 8.7.6.2 of Method 5, where applicable, to rinse the probe nozzle, probe fitting, probe liner, filter holder, and all glassware between the filter holder and the back half of the third impinger with water. Repeat this procedure with acetone. Place both water and acetone rinse solutions in the sample bottle with the contents of the impingers.

8.5.3 Container No. 3. Same as Method 5, Section 8.7.6.3.

8.6 Blanks.

8.6.1 Water Blank. Save a portion of the water as a blank. Take 200 ml directly from the wash bottle being used and place it in a plastic sample container labeled "H<sub>2</sub>O blank."

8.6.2 Filter. Save two filters from each lot of filters used in sampling. Place these filters in a container labeled "filter blank."

8.7 Post-test Glassware Rinsing. If an additional test is desired, the glassware can be carefully double rinsed with water and reassembled. However, if the glassware is out of use more than 2 days, repeat the initial acid wash procedure.

## 9.0 QUALITY CONTROL

| Section   | Quality control measure                        | Effect   |
|-----------|--|--|
| 8.4, 10.1 | Sampling equipment leak checks and calibration | Ensure accuracy and precision of sampling measurements.      |
| 10.2      | Spectrophotometer calibration                  | Ensure linearity of spectrophotometer response to standards. |
| 11.5      | Check for matrix effects                       | Eliminate matrix effects.                                    |

### 10.0 Calibration and Standardization

NOTE: Maintain a laboratory log of all calibrations.

10.1 Sampling Equipment. Same as Method 5, Section 10.0.

10.2 Preparation of Standard Solutions. Pipet 1, 3, 5, 8, and 10 ml of the 1.0 µg Be/ml working standard solution into separate 100 ml volumetric flasks, and dilute to the mark with water. The total amounts of Be in these standards are 1, 3, 5, 8, and 10 µg, respectively.

10.3 Spectrophotometer and Recorder. The Be response may be measured by either peak height or peak area. Analyze an aliquot of the 10-µg standard at 234.8 nm using a nitrous oxide/acetylene flame. Determine the maximum absorbance of the standard, and set this value to read 90 percent of the recorder full scale.

10.4 Calibration Curve.

10.4.1 After setting the recorder scale, analyze an appropriately sized aliquot of each standard and the BLANK (see Section 11) until two consecutive peaks agree within 3 percent of their average value.

10.4.3 Subtract the average peak height (or peak area) of the blank—which must be less than 2 percent of recorder full scale—from the averaged peak heights of the standards. If the blank absorbance is greater than 2 percent of full-scale, the probable cause is Be contamination of a reagent or carry-over of Be from a previous sample. Prepare the calibration curve by plotting the corrected peak height of each standard solution versus the corresponding total Be weight in the standard (in µg).

10.5 Spectrophotometer Calibration Quality Control. Calculate the least squares slope of the calibration curve. The line must pass through the origin or through a point no further from the origin than  $\pm 2$  percent of the recorder full scale. Multiply the corrected peak height by the reciprocal of the least squares slope to determine the distance each calibration point lies from the theoretical calibration line. The difference between the calculated concentration values and the actual concentrations (i.e., 1, 3, 5, 8, and 10  $\mu\text{g Be}$ ) must be less than 7 percent for all standards.

### 11.0 Analytical Procedure

11.1 Sample Loss Check. Prior to analysis, check the liquid level in Container No. 2. Note on the analytical data sheet whether leakage occurred during transport. If a noticeable amount of leakage occurred, either void the sample or take steps, subject to the approval of the Administrator, to adjust the final results.

11.2 Glassware Cleaning. Before use, clean all glassware according to the procedure of Section 8.3.1.

11.3 Sample Preparation. The digestion of Be samples is accomplished in part in concentrated  $\text{HClO}_4$ .

NOTE: The sample must be heated to light brown fumes after the initial  $\text{HNO}_3$  addition; otherwise, dangerous perchlorates may result from the subsequent  $\text{HClO}_4$  digestion.  $\text{HClO}_4$  should be used only under a hood.

11.3.1 Container No. 1. Transfer the filter and any loose particulate matter from Container No. 1 to a 150-ml beaker. Add 35 ml concentrated  $\text{HNO}_3$ . To oxidize all organic matter, heat on a hotplate until light brown fumes are evident. Cool to room temperature, and add 5 ml 12 N  $\text{H}_2\text{SO}_4$  and 5 ml concentrated  $\text{HClO}_4$ .

11.3.2 Container No. 2. Place a portion of the water and acetone sample into a 150 ml beaker, and put on a hotplate. Add portions of the remainder as evaporation proceeds and evaporate to dryness. Cool the residue, and add 35 ml concentrated  $\text{HNO}_3$ . To oxidize all organic matter, heat on a hotplate until light brown fumes are evident. Cool to room temperature, and add 5 ml 12 N  $\text{H}_2\text{SO}_4$  and 5 ml concentrated  $\text{HClO}_4$ . Then proceed with step 11.3.4.

11.3.3 Final Sample Preparation. Add the sample from Section 11.3.2 to the 150-ml beaker from Section 11.3.1. Replace on a hotplate, and evaporate to dryness in a  $\text{HClO}_4$  hood. Cool the residue to room temperature, add 10.0 ml of 25 percent V/V  $\text{HCl}$ , and mix to dissolve the residue.

11.3.4 Filter and Water Blanks. Cut each filter into strips, and treat each filter individually as directed in Section 11.3.1. Treat the 200-ml water blank as directed in Section 11.3.2. Combine and treat these blanks as directed in Section 11.3.3.

11.4 Spectrophotometer Preparation. Turn on the power; set the wavelength, slit width, and lamp current; and adjust the background corrector as instructed by the manufacturer's manual for the particular atomic absorption spectrophotometer. Adjust the burner and flame characteristics as necessary.

11.5 Analysis. Calibrate the analytical equipment and develop a calibration curve as outlined in Sections 10.4 and 10.5.

11.5.1 Beryllium Samples. Repeat the procedure used to establish the calibration curve with an appropriately sized aliquot of each sample (from Section 11.3.3) until two consecutive peak heights agree within 3 percent of their average value. The peak height of each sample must be greater than 10 percent

of the recorder full scale. If the peak height of the sample is off scale on the recorder, further dilute the original source sample to bring the Be concentration into the calibration range of the spectrophotometer.

11.5.2 Run a blank and standard at least after every five samples to check the spectrophotometer calibration. The peak height of the blank must pass through a point no further from the origin than  $\pm 2$  percent of the recorder full scale. The difference between the measured concentration of the standard (the product of the corrected peak height and the reciprocal of the least squares slope) and the actual concentration of the standard must be less than 7 percent, or recalibration of the analyzer is required.

11.5.3 Check for Matrix Effects (optional). Use the Method of Standard Additions (see Reference 2 in Section 17.0) to check at least one sample from each source for matrix effects on the Be results. If the results of the Method of Standard Additions procedure used on the single source sample do not agree to within 5 percent of the value obtained by the routine atomic absorption analysis, then reanalyze all samples from the source using the Method of Standard Additions procedure.

11.6 Container No. 2 (Silica Gel). Weigh the spent silica gel (or silica gel plus impinger) to the nearest 0.5 g using a balance. (This step may be conducted in the field.)

## 12.0 Data Analysis and Calculations

Carry out calculations, retaining at least one extra decimal significant figure beyond that of the acquired data. Round off figures only after the final calculation. Other forms of the equations may be used as long as they give equivalent results.

### 12.1 Nomenclature.

$K_1 = 0.3858$  °K/mm Hg for metric units.

$= 17.64$  °R/in. Hg for English units.

$K_3 = 10^{-6}$  g/ $\mu$ g for metric units.

$= 2.2046 \times 10^{-9}$  lb/ $\mu$ g for English units.

$m_{\text{Be}}$  = Total weight of beryllium in the source sample.

$P_s$  = Absolute stack gas pressure, mm Hg (in. Hg).

$t$  = Daily operating time, sec/day.

$T_s$  = Absolute average stack gas temperature, °K (°R).

$V_{\text{m(std)}}$  = Dry gas sample volume at standard conditions, scm (scf).

$V_{\text{w(std)}}$  = Volume of water vapor at standard conditions, scm (scf).

12.2 Average Dry Gas Meter Temperature and Average Orifice Pressure Drop, Dry Gas Volume, Volume of Water Vapor Condensed, Moisture Content, Isokinetic Variation, and Stack Gas Velocity and Volumetric Flow Rate. Same as Method 5, Sections 12.2 through 12.5, 12.11, and 12.12, respectively.

12.3 Total Beryllium. For each source sample, correct the average maximum absorbance of the two consecutive samples whose peak heights agree within 3 percent of their average for the contribution of the solution blank (see Sections 11.3.4 and 11.5.2). Correcting for any dilutions if necessary, use the calibration curve and these corrected averages to determine the total weight of Be in each source sample.

12.4 Beryllium Emission Rate. Calculate the daily Hg emission rate, R, using Equation 104-1. For continuous operations, the operating time is equal to 86,400 seconds per day. For cyclic operations, use only the time per day each stack is in operation. The total Hg emission rate from a source will be the summation of results from all stacks.

$$R = \frac{K_1 K_2 t m_{Be} P_s v_s A_s}{T_s (V_{m(stk)} + V_{w(stk)})} \quad \text{Eq. 104-1}$$

12.5 Determination of Compliance. Each performance test consists of three sample runs. For the purpose of determining compliance with an applicable national emission standard, use the average of the results of all sample runs.

13.0 *Method Performance. [Reserved]*

14.0 *Pollution Prevention. [Reserved]*

15.0 *Waste Management. [Reserved]*

16.0 *Alternative Procedures*

16.1 Inductively Coupled Plasma-Atomic Emission Spectrometry (ICP-AES) Analysis. ICP-AES may be used as an alternative to atomic absorption analysis provided the following conditions are met:

16.1.1 Sample collection, sample preparation, and analytical preparation procedures are as defined in the method except as necessary for the ICP-AES application.

16.1.2 Quality Assurance/Quality Control procedures, including audit material analysis, are conducted as prescribed in the method. The QA acceptance conditions must be met.

16.1.3 The limit of quantitation for the ICP-AES must be demonstrated and the sample concentrations reported should be no less than two times the limit of quantitation. The limit of quantitation is defined as ten times the standard deviation of the blank value. The standard deviation of the blank value is determined from the analysis of seven blanks. It has been reported that for mercury and those elements that form hydrides, a continuous-flow generator coupled to an ICP-AES offers detection limits comparable to cold vapor atomic absorption.

16.2 Inductively Coupled Plasma-Mass Spectrometry (ICP-MS) Analysis. ICP-MS may be used as an alternative to atomic absorption analysis.

16.3 Cold Vapor Atomic Fluorescence Spectrometry (CVAFS) Analysis. CVAFS may be used as an alternative to atomic absorption analysis.

17.0 *References*

Same as References 1, 2, and 4-11 of Section 16.0 of Method 101 with the addition of the following:

1. Amos, M.D., and J.B. Willis. Use of High-Temperature Pre-Mixed Flames in Atomic Absorption Spectroscopy. *Spectrochim. Acta.* 22:1325. 1966.

2. Fleet, B., K.V. Liberty, and T. S. West. A Study of Some Matrix Effects in the Determination of Beryllium by Atomic Absorption Spectroscopy in the Nitrous Oxide-Acetylene Flame. *Talanta* 17:203. 1970.

## 18.0 Tables, Diagrams, Flowcharts, And Validation Data [Reserved]

### METHOD 105—DETERMINATION OF MERCURY IN WASTEWATER TREATMENT PLANT SEWAGE SLUDGES

NOTE: This method does not include all of the specifications (e.g., equipment and supplies) and procedures (e.g., sampling and analytical) essential to its performance. Some material is incorporated by reference from other methods in this part. Therefore, to obtain reliable results, persons using this method should also have a thorough knowledge of at least the following additional test methods: Method 101 and Method 101A.

#### 1.0 Scope and Application

##### 1.1 Analytes.

| Analyte      | CAS No.   | Sensitivity                                    |
|--------------|-----------|--|
| Mercury (Hg) | 7439-97-6 | Dependent upon spectrophotometer and recorder. |

1.2 Applicability. This method is applicable for the determination of total organic and inorganic Hg content in sewage sludges.

1.3 Data Quality Objectives. Adherence to the requirements of this method will enhance the quality of the data obtained from air pollutant sampling methods.

#### 2.0 Summary of Method

2.1 Time-composite sludge samples are withdrawn from the conveyor belt subsequent to dewatering and before incineration or drying. A weighed portion of the sludge is digested in aqua regia and is oxidized by potassium permanganate (KMnO<sub>4</sub>). Mercury in the digested sample is then measured by the conventional spectrophotometric cold-vapor technique.

#### 3.0 Definitions [Reserved]

#### 4.0 Interferences [Reserved]

#### 5.0 Safety

5.1 Disclaimer. This method may involve hazardous materials, operations, and equipment. This test method may not address all of the safety problems associated with its use. It is the responsibility of the user of this test method to establish appropriate safety and health practices and determine the applicability of regulatory limitations prior to performing this test method.

5.2 Corrosive Reagents. The following reagents are hazardous. Personal protective equipment and safe procedures are useful in preventing chemical splashes. If contact occurs, immediately flush with copious amounts of water at least 15 minutes. Remove clothing under shower and decontaminate. Treat residual chemical burn as thermal burn.

5.2.1 Hydrochloric Acid (HCl). Highly toxic. Vapors are highly irritating to eyes, skin, nose, and lungs, causing severe damage. May cause bronchitis, pneumonia, or edema of lungs. Exposure to concentrations of 0.13 to 0.2 percent can be lethal to humans in a few minutes. Provide ventilation to limit exposure. Reacts with metals, producing hydrogen gas.

5.2.2 Nitric Acid (HNO<sub>3</sub>). Highly corrosive to eyes, skin, nose, and lungs. Vapors cause bronchitis, pneumonia, or edema of lungs. Reaction to inhalation may be delayed as long as 30 hours and still be

fatal. Provide ventilation to limit exposure. Strong oxidizer. Hazardous reaction may occur with organic materials such as solvents.

## 6.0 *Equipment and Supplies*

6.1 Sample Collection and Mixing. The following items are required for collection and mixing of the sludge samples:

- 6.1.1 Container. Plastic, 50-liter.
- 6.1.2 Scoop. To remove 950-ml (1 quart.) sludge sample.
- 6.1.3 Mixer. Mortar mixer, wheelbarrow-type, 57-liter (or equivalent) with electricity-driven motor.
- 6.1.4 Blender. Waring-type, 2-liter.
- 6.1.5 Scoop. To remove 100-ml and 20-ml samples of blended sludge.
- 6.1.6 Erlenmeyer Flasks. Four, 125-ml.
- 6.1.7 Beakers. Glass beakers in the following sizes: 50 ml (1), 200 ml (1), 400 ml (2).

6.2 Sample Preparation and Analysis. Same as Method 101, Section 6.3, with the addition of the following:

- 6.2.1 Hot Plate.
- 6.2.2 Desiccator.
- 6.2.3 Filter Paper. S and S No. 588 (or equivalent).
- 6.2.4 Beakers. Glass beakers, 200 ml and 400 ml (2 each).

## 7.0 *Reagents and Standards*

NOTE: Unless otherwise indicated, it is intended that all reagents conform to the specifications established by the Committee on Analytical Reagents of the American Chemical Society, where such specifications are available; otherwise, use the best available grade.

7.1 Sample Analysis. Same as Method 101A, Section 7.2, with the following additions and exceptions:

- 7.1.1 Hydrochloric Acid. The concentrated HCl specified in Method 101A, Section 7.2.4, is not required.
- 7.1.2 Aqua Regia. Prepare immediately before use. Carefully add one volume of concentrated  $\text{HNO}_3$  to three volumes of concentrated HCl.

## 8.0 *Sample Collection, Preservation, Storage, and Transport*

8.1 Sludge Sampling. Withdraw equal volume increments of sludge [for a total of at least 15 liters (16 quarts)] at intervals of 30 min over an 8-hr period, and combine in a rigid plastic container.

8.2 Sludge Mixing. Transfer the entire 15-liter sample to a mortar mixer. Mix the sample for a minimum of 30 min at 30 rpm. Take six 100-ml portions of sludge, and combine in a 2-liter blender. Blend sludge for 5 min; add water as necessary to give a fluid consistency. Immediately after stopping the blender, withdraw four 20-ml portions of blended sludge, and place them in separate, tared 125-ml Erlenmeyer flasks. Reweigh each flask to determine the exact amount of sludge added.

8.3 Sample Holding Time. Samples shall be analyzed within the time specified in the applicable subpart of the regulations.

### 9.0 Quality Control

| Section | Quality control measure       | Effect   |
|---------|-------------------------------|--|
| 10.0    | Spectrophotometer calibration | Ensure linearity of spectrophotometer response to standards. |
| 11.0    | Check for matrix effects      | Eliminate matrix effects.                                    |

### 10.0 Calibration and Standardization

Same as Method 101A, Section 10.2.

### 11.0 Analytical Procedures

11.1 Solids Content of Blended Sludge. Dry one of the 20-ml blended samples from Section 8.2 in an oven at 105 °C (221 °F) to constant weight. Cool in a desiccator, weigh and record the dry weight of the sample.

11.2 Aqua Regia Digestion of Blended Samples.

11.2.1 To each of the three remaining 20-ml samples from Section 8.2 add 25 ml of aqua regia, and digest the on a hot plate at low heat (do not boil) for 30 min, or until samples are a pale yellow-brown color and are void of the dark brown color characteristic of organic matter. Remove from hotplate and allow to cool.

11.2.2 Filter each digested sample separately through an S and S No. 588 filter or equivalent, and rinse the filter contents with 50 ml of water. Transfer the filtrate and filter washing to a 100-ml volumetric flask, and carefully dilute to volume with water.

11.3 Solids Content of the Sludge Before Blending. Remove two 100-ml portions of mixed sludge from the mortar mixer and place in separate, tared 400-ml beakers. Reweigh each beaker to determine the exact amount of sludge added. Dry in oven at 105 °C (221 °F) and cool in a desiccator to constant weight.

11.4 Analysis for Mercury. Analyze the three aqua regia-digested samples using the procedures outlined in Method 101A, Section 11.0.

### 12.0 Data Analysis and Calculations

12.1 Nomenclature.

$C_m$  = Concentration of Hg in the digested sample, µg/g.



$F_{sb}$  = Weight fraction of solids in the blended sludge.

$F_{sm}$  = Weight fraction of solids in the collected sludge after mixing.

$M$  = Hg content of the sewage sludge (on a dry basis),  $\mu\text{g/g}$ .

$m$  = Mass of Hg in the aliquot of digested sample analyzed,  $\mu\text{g}$ .

$n$  = number of digested samples (specified in Section 11.2 as three).

$V_a$  = Volume of digested sample analyzed, ml.

$V_s$  = Volume of digested sample, ml.

$W_b$  = Weight of empty sample beaker, g.

$W_{bs}$  = Weight of sample beaker and sample, g.

$W_{bd}$  = Weight of sample beaker and sample after drying, g.

$W_f$  = Weight of empty sample flask, g.

$W_{fd}$  = Weight of sample flask and sample after drying, g.

$W_{fs}$  = Weight of sample flask and sample, g.

## 12.2 Mercury Content of Digested Sample (Wet Basis).

12.2.1 For each sample analyzed for Hg content, calculate the arithmetic mean maximum absorbance of the two consecutive samples whose peak heights agree  $\pm 3$  percent of their average. Correct this average value for the contribution of the blank. Use the calibration curve and these corrected averages to determine the final Hg concentration in the solution cell for each sludge sample.

12.2.2 Calculate the average Hg concentration of the digested samples by correcting for any dilutions made to bring the sample into the working range of the spectrophotometer and for the weight of the sludge portion digested, using Equation 105-1.

$$\bar{C}_m = \sum_{i=1}^n \left[ \frac{mV_s}{V_d(W_{fs} - W_f)} \right] \quad \text{Eq. 105-1}$$

12.3 Solids Content of Blended Sludge. Determine the solids content of the blended sludge using Equation 105-2.

$$F_{sb} = 1 - \frac{W_{bs} - W_{bd}}{W_{fs} - W_f} \quad \text{Eq. 105-2}$$

12.4 Solids Content of Bulk Sample (before blending but, after mixing in mortar mixer). Determine the solids content of each 100 ml aliquot (Section 11.3), and average the results.

$$F_{sm} = 1 - \frac{W_{bs} - W_{bd}}{W_{bs} - W_b} \quad \text{Eq. 105-3}$$

12.5 Mercury Content of Bulk Sample (Dry Basis). Average the results from the three samples from each 8-hr composite sample, and calculate the Hg concentration of the composite sample on a dry basis.

$$M = \frac{\bar{C}_m}{F_{sb}} \quad \text{Eq. 105-4}$$

### 13.0 Method Performance

13.1 Range. The range of this method is 0.2 to 5 micrograms per gram; it may be extended by increasing or decreasing sample size.

14.0 Pollution Prevention. [Reserved]

15.0 Waste Management. [Reserved]

### 16.0 References

1. Bishop, J.N. Mercury in Sediments. Ontario Water Resources Commission. Toronto, Ontario, Canada. 1971.
2. Salma, M. Private Communication. EPA California/Nevada Basin Office. Alameda, California.
3. Hatch, W.R. and W.L. Ott. Determination of Sub-Microgram Quantities of Mercury by Atomic Absorption Spectrophotometry. Analytical Chemistry. 40:2085. 1968.
4. Bradenberger, H., and H. Bader. The Determination of Nanogram Levels of Mercury in Solution by a Flameless Atomic Absorption Technique. Atomic Absorption Newsletter. 6:101. 1967.
5. Analytical Quality Control Laboratory (AQCL). Mercury in Sediment (Cold Vapor Technique) (Provisional Method). U.S. Environmental Protection Agency. Cincinnati, Ohio. April 1972.
6. Kopp, J.F., M.C. Longbottom, and L.B. Lobring. "Cold Vapor" Method for Determining Mercury. Journal AWWA. 64(1):20-25. 1972.
7. Manual of Methods for Chemical Analysis of Water and Wastes. U.S. Environmental Protection Agency. Cincinnati, Ohio. Publication No. EPA-624/2-74-003. December 1974. pp. 118-138.
8. Mitchell, W.J., M.R. Midgett, J. Suggs, R.J. Velton, and D. Albrink. Sampling and Homogenizing Sewage for Analysis. Environmental Monitoring and Support Laboratory, Office of Research and Development, U.S. Environmental Protection Agency. Research Triangle Park, N.C. March 1979. p. 7.

17.0 Tables, Diagrams, Flowcharts, and Validation Data. [Reserved]

## METHOD 106—DETERMINATION OF VINYL CHLORIDE EMISSIONS FROM STATIONARY SOURCES

### 1.0 Scope and Application

#### 1.1 Analytes.

| Analyte                                | CAS No. | Sensitivity                          |
|--|---------|--------------------------------------|
| Vinyl Chloride (CH <sub>2</sub> :CHCl) | 75-01-4 | Dependent upon analytical equipment. |

1.2 Applicability. This method is applicable for the determination of vinyl chloride emissions from ethylene dichloride, vinyl chloride, and polyvinyl chloride manufacturing processes. This method does not measure vinyl chloride contained in particulate matter.

1.3 Data Quality Objectives. Adherence to the requirements of this method will enhance the quality of the data obtained from air pollutant sampling methods.

## 2.0 Summary of Method

2.1 An integrated bag sample of stack gas containing vinyl chloride is subjected to GC analysis using a flame ionization detector (FID).

## 3.0 Definitions. [Reserved]

## 4.0 Interferences

4.1 Resolution interferences of vinyl chloride may be encountered on some sources. Therefore, the chromatograph operator should select the column and operating parameters best suited to the particular analysis requirements. The selection made is subject to approval of the Administrator. Approval is automatic, provided that confirming data are produced through an adequate supplemental analytical technique, and that the data are available for review by the Administrator. An example of this would be analysis with a different column or GC/mass spectroscopy.

## 5.0 Safety

5.1 Disclaimer. This method may involve hazardous materials, operations, and equipment. This test method may not address all of the safety problems associated with its use. It is the responsibility of the user of this test method to establish appropriate safety and health practices and determine the applicability of regulatory limitations prior to performing this test method.

5.2 Toxic Analyte. Care must be exercised to prevent exposure of sampling personnel to vinyl chloride, which is a carcinogen.

## 6.0 Equipment and Supplies

6.1 Sample Collection (see Figure 106-1). The sampling train consists of the following components:

6.1.1 Probe. Stainless steel, borosilicate glass, Teflon tubing (as stack temperature permits), or equivalent, equipped with a glass wool plug to remove particulate matter.

6.1.2 Sample Lines. Teflon, 6.4-mm outside diameter, of sufficient length to connect probe to bag. Use a new unused piece for each series of bag samples that constitutes an emission test, and discard upon completion of the test.

6.1.3 Quick Connects. Stainless steel, male (2) and female (2), with ball checks (one pair without), located as shown in Figure 106-1.

6.1.4 Tedlar Bags. 50- to 100-liter capacity, to contain sample. Aluminized Mylar bags may be used if the samples are analyzed within 24 hours of collection.

6.1.5 Bag Containers. Rigid leak-proof containers for sample bags, with covering to protect contents from sunlight.

6.1.6 Needle Valve. To adjust sample flow rates.

6.1.7 Pump. Leak-free, with minimum of 2-liter/min capacity.

6.1.8 Charcoal Tube. To prevent admission of vinyl chloride and other organics to the atmosphere in the vicinity of samplers.

6.1.9 Flowmeter. For observing sampling flow rate; capable of measuring a flow range from 0.10 to 1.00 liter/min.

6.1.10 Connecting Tubing. Teflon, 6.4-mm outside diameter, to assemble sampling train (Figure 106-1).

6.1.11 Tubing Fittings and Connectors. Teflon or stainless steel, to assemble sampling training.

6.2 Sample Recovery. Teflon tubing, 6.4-mm outside diameter, to connect bag to GC sample loop. Use a new unused piece for each series of bag samples that constitutes an emission test, and discard upon conclusion of analysis of those bags.

6.3 Analysis. The following equipment is required:

6.3.1 Gas Chromatograph. With FID potentiometric strip chart recorder and 1.0 to 5.0-ml heated sampling loop in automatic sample valve. The chromatographic system shall be capable of producing a response to 0.1-ppmv vinyl chloride that is at least as great as the average noise level. (Response is measured from the average value of the base line to the maximum of the wave form, while standard operating conditions are in use.)

6.3.2 Chromatographic Columns. Columns as listed below. Other columns may be used provided that the precision and accuracy of the analysis of vinyl chloride standards are not impaired and that information is available for review confirming that there is adequate resolution of vinyl chloride peak. (Adequate resolution is defined as an area overlap of not more than 10 percent of the vinyl chloride peak by an interferent peak. Calculation of area overlap is explained in Procedure 1 of appendix C to this part: "Determination of Adequate Chromatographic Peak Resolution.")

6.3.2.1 Column A. Stainless steel, 2.0 m by 3.2 mm, containing 80/100-mesh Chromasorb 102.

6.3.2.2 Column B. Stainless steel, 2.0 m by 3.2 mm, containing 20 percent GE SF-96 on 60/100-mesh Chromasorb P AW; or stainless steel, 1.0 m by 3.2 mm containing 80/100-mesh Porapak T. Column B is required as a secondary column if acetaldehyde is present. If used, column B is placed after column A. The combined columns should be operated at 120 °C (250 °F).

6.3.3 Rate Meters (2). Rotameter , or equivalent, 100-ml/min capacity, with flow control valves.

6.3.4 Gas Regulators. For required gas cylinders.

6.3.5 Temperature Sensor. Accurate to  $\pm 1$  °C ( $\pm 2$  °F), to measure temperature of heated sample loop at time of sample injection.

6.3.6 Barometer. Accurate to  $\pm 5$  mm Hg, to measure atmospheric pressure around GC during sample analysis.

6.3.7 Pump. Leak-free, with minimum of 100-ml/min capacity.

6.3.8 Recorder. Strip chart type, optionally equipped with either disc or electronic integrator.

6.3.9 Planimeter. Optional, in place of disc or electronic integrator on recorder, to measure chromatograph peak areas.

#### 6.4 Calibration and Standardization.

6.4.1 Tubing. Teflon, 6.4-mm outside diameter, separate pieces marked for each calibration concentration.

NOTE: The following items are required only if the optional standard gas preparation procedures (Section 10.1) are followed.

6.4.2 Tedlar Bags. Sixteen-inch-square size, with valve; separate bag marked for each calibration concentration.

6.4.3 Syringes. 0.5-ml and 50- $\mu$ l, gas tight, individually calibrated to dispense gaseous vinyl chloride.

6.4.4 Dry Gas Meter with Temperature and Pressure Gauges. Singer Model DTM-115 with 802 index, or equivalent, to meter nitrogen in preparation of standard gas mixtures, calibrated at the flow rate used to prepare standards.

### 7.0 Reagents and Standards

7.1 Analysis. The following reagents are required for analysis.

7.1.1 Helium or Nitrogen. Purity 99.9995 percent or greater, for chromatographic carrier gas.

7.1.2 Hydrogen. Purity 99.9995 percent or greater.

7.1.3 Oxygen or Air. Either oxygen (purity 99.99 percent or greater) or air (less than 0.1 ppmv total hydrocarbon content), as required by detector.

7.2 Calibration. Use one of the following options: either Sections 7.2.1 and 7.2.2, or Section 7.2.3.

7.2.1 Vinyl Chloride. Pure vinyl chloride gas certified by the manufacturer to contain a minimum of 99.9 percent vinyl chloride. If the gas manufacturer maintains a bulk cylinder supply of 99.9 + percent vinyl chloride, the certification analysis may have been performed on this supply, rather than on each gas cylinder prepared from this bulk supply. The date of gas cylinder preparation and the certified analysis must have been affixed to the cylinder before shipment from the gas manufacturer to the buyer.

7.2.2 Nitrogen. Same as described in Section 7.1.1.

7.2.3 Cylinder Standards. Gas mixture standards (50-, 10-, and 5 ppmv vinyl chloride) in nitrogen cylinders may be used to directly prepare a chromatograph calibration curve as described in Section 10.3 if the following conditions are met: (a) The manufacturer certifies the gas composition with an accuracy of  $\pm 3$  percent or better. (b) The manufacturer recommends a maximum shelf life over which the gas concentration does not change by greater than  $\pm 5$  percent from the certified value. (c) The manufacturer affixes the date of gas cylinder preparation, certified vinyl chloride concentration, and recommended maximum shelf to the cylinder before shipment to the buyer.

7.2.3.1 Cylinder Standards Certification. The manufacturer shall certify the concentration of vinyl chloride in nitrogen in each cylinder by (a) directly analyzing each cylinder and (b) calibrating his analytical procedure on the day of cylinder analysis. To calibrate his analytical procedure, the

manufacturer shall use as a minimum, a three point calibration curve. It is recommended that the manufacturer maintain (1) a high concentration calibration standard (between 50 and 100 ppmv) to prepare his calibration curve by an appropriate dilution technique and (2) a low-concentration calibration standard (between 5 and 10 ppmv) to verify the dilution technique used. If the difference between the apparent concentration read from the calibration curve and the true concentration assigned to the low-concentration calibration standard exceeds 5 percent of the true concentration, the manufacturer shall determine the source of error and correct it, then repeat the three-point calibration.

7.2.3.2 Verification of Manufacturer's Calibration Standards. Before using a standard, the manufacturer shall verify each calibration standard (a) by comparing it to gas mixtures prepared (with 99 mole percent vinyl chloride) in accordance with the procedure described in Section 7.2.1 or (b) calibrating it against vinyl chloride cylinder Standard Reference Materials (SRM's) prepared by the National Institute of Standards and Technology, if such SRM's are available. The agreement between the initially determined concentration value and the verification concentration value must be  $\pm 5$  percent. The manufacturer must reverify all calibration standards on a time interval consistent with the shelf life of the cylinder standards sold.

### 8.0 Sample Collection, Preservation, Storage, and Transport

NOTE: Performance of this method should not be attempted by persons unfamiliar with the operation of a gas chromatograph (GC) nor by those who are unfamiliar with source sampling, because knowledge beyond the scope of this presentation is required.

8.1 Bag Leak-Check. The following leak-check procedure is recommended, but not required, prior to sample collection. The post-test leak-check procedure is mandatory. Connect a water manometer and pressurize the bag to 5 to 10 cm H<sub>2</sub>O (2 to 4 in. H<sub>2</sub>O). Allow to stand for 10 min. Any displacement in the water manometer indicates a leak. Also, check the rigid container for leaks in this manner.

NOTE: An alternative leak-check method is to pressurize the bag to 5 to 10 cm H<sub>2</sub>O and allow it to stand overnight. A deflated bag indicates a leak. For each sample bag in its rigid container, place a rotameter in line between the bag and the pump inlet. Evacuate the bag. Failure of the rotameter to register zero flow when the bag appears to be empty indicates a leak.

8.2 Sample Collection. Assemble the sample train as shown in Figure 106-1. Join the quick connects as illustrated, and determine that all connection between the bag and the probe are tight. Place the end of the probe at the centroid of the stack and start the pump with the needle valve adjusted to yield a flow that will fill over 50 percent of bag volume in the specific sample period. After allowing sufficient time to purge the line several times, change the vacuum line from the container to the bag and evacuate the bag until the rotameter indicates no flow. Then reposition the sample and vacuum lines and begin the actual sampling, keeping the rate proportional to the stack velocity. At all times, direct the gas exiting the rotameter away from sampling personnel. At the end of the sample period, shut off the pump, disconnect the sample line from the bag, and disconnect the vacuum line from the bag container. Protect the bag container from sunlight.

8.3 Sample Storage. Keep the sample bags out of direct sunlight. When at all possible, analysis is to be performed within 24 hours, but in no case in excess of 72 hours of sample collection. Aluminized Mylar bag samples must be analyzed within 24 hours.

8.4 Post-test Bag Leak-Check. Subsequent to recovery and analysis of the sample, leak-check the sample bag according to the procedure outlined in Section 8.1.

### 9.0 QUALITY CONTROL

| Section | Quality control measure | Effect |
|---------|-------------------------|--------|
|---------|-------------------------|--------|

|      |                           |   |
|------|---------------------------|---|
| 10.3 | Chromatograph calibration | Ensure precision and accuracy of chromatograph. |
|------|---------------------------|---|

### 10.0 Calibration and Standardization

NOTE: Maintain a laboratory log of all calibrations.

10.1 Preparation of Vinyl Chloride Standard Gas Mixtures. (Optional Procedure-delete if cylinder standards are used.) Evacuate a 16-inch square Tedlar bag that has passed a leak-check (described in Section 8.1) and meter in 5.0 liters of nitrogen. While the bag is filling, use the 0.5-ml syringe to inject 250  $\mu$ l of 99.9 + percent vinyl chloride gas through the wall of the bag. Upon withdrawing the syringe, immediately cover the resulting hole with a piece of adhesive tape. The bag now contains a vinyl chloride concentration of 50 ppmv. In a like manner use the 50  $\mu$ l syringe to prepare gas mixtures having 10- and 5-ppmv vinyl chloride concentrations. Place each bag on a smooth surface and alternately depress opposite sides of the bag 50 times to further mix the gases. These gas mixture standards may be used for 10 days from the date of preparation, after which time new gas mixtures must be prepared. (Caution: Contamination may be a problem when a bag is reused if the new gas mixture standard is a lower concentration than the previous gas mixture standard.)

10.2 Determination of Vinyl Chloride Retention Time. (This section can be performed simultaneously with Section 10.3.) Establish chromatograph conditions identical with those in Section 11.3. Determine proper attenuator position. Flush the sampling loop with helium or nitrogen and activate the sample valve. Record the injection time, sample loop temperature, column temperature, carrier gas flow rate, chart speed, and attenuator setting. Record peaks and detector responses that occur in the absence of vinyl chloride. Maintain conditions with the equipment plumbing arranged identically to Section 11.2, and flush the sample loop for 30 seconds at the rate of 100 ml/min with one of the vinyl chloride calibration mixtures. Then activate the sample valve. Record the injection time. Select the peak that corresponds to vinyl chloride. Measure the distance on the chart from the injection time to the time at which the peak maximum occurs. This quantity divided by the chart speed is defined as the retention time. Since other organics may be present in the sample, positive identification of the vinyl chloride peak must be made.

10.3 Preparation of Chromatograph Calibration Curve. Make a GC measurement of each gas mixture standard (described in Section 7.2.3 or 10.1) using conditions identical to those listed in Sections 11.2 and 11.3. Flush the sampling loop for 30 seconds at the rate of 100 ml/min with one of the standard mixtures, and activate the sample valve. Record the concentration of vinyl chloride injected ( $C_c$ ), attenuator setting, chart speed, peak area, sample loop temperature, column temperature, carrier gas flow rate, and retention time. Record the barometric pressure. Calculate  $A_c$ , the peak area multiplied by the attenuator setting. Repeat until two consecutive injection areas are within 5 percent, then plot the average of those two values versus  $C_c$ . When the other standard gas mixtures have been similarly analyzed and plotted, draw a straight line through the points derived by the least squares method. Perform calibration daily, or before and after the analysis of each emission test set of bag samples, whichever is more frequent. For each group of sample analyses, use the average of the two calibration curves which bracket that group to determine the respective sample concentrations. If the two calibration curves differ by more than 5 percent from their mean value, then report the final results by both calibration curves.

### 11.0 Analytical Procedure

11.2 Sample Recovery. With a new piece of Teflon tubing identified for that bag, connect a bag inlet valve to the gas chromatograph sample valve. Switch the valve to receive gas from the bag through the sample loop. Arrange the equipment so the sample gas passes from the sample valve to 100-ml/min rotameter with flow control valve followed by a charcoal tube and a 1-in.  $H_2O$  pressure gauge. Maintain the sample flow either by a vacuum pump or container pressurization if the collection bag remains in the

rigid container. After sample loop purging is ceased, allow the pressure gauge to return to zero before activating the gas sampling valve.

### 11.3 Analysis.

11.3.1 Set the column temperature to 100 °C (210 °F) and the detector temperature to 150 °C (300 °F). When optimum hydrogen and oxygen (or air) flow rates have been determined, verify and maintain these flow rates during all chromatography operations. Using helium or nitrogen as the carrier gas, establish a flow rate in the range consistent with the manufacturer's requirements for satisfactory detector operation. A flow rate of approximately 40 ml/min should produce adequate separations. Observe the base line periodically and determine that the noise level has stabilized and that base line drift has ceased. Purge the sample loop for 30 seconds at the rate of 100 ml/min, shut off flow, allow the sample loop pressure to reach atmospheric pressure as indicated by the H<sub>2</sub>O manometer, then activate the sample valve. Record the injection time (the position of the pen on the chart at the time of sample injection), sample number, sample loop temperature, column temperature, carrier gas flow rate, chart speed, and attenuator setting. Record the barometric pressure. From the chart, note the peak having the retention time corresponding to vinyl chloride as determined in Section 10.2. Measure the vinyl chloride peak area,  $A_m$ , by use of a disc integrator, electronic integrator, or a planimeter. Measure and record the peak heights,  $H_m$ . Record  $A_m$  and retention time. Repeat the injection at least two times or until two consecutive values for the total area of the vinyl chloride peak agree within 5 percent of their average. Use the average value for these two total areas to compute the bag concentration.

11.3.2 Compare the ratio of  $H_m$  to  $A_m$  for the vinyl chloride sample with the same ratio for the standard peak that is closest in height. If these ratios differ by more than 10 percent, the vinyl chloride peak may not be pure (possibly acetaldehyde is present) and the secondary column should be employed (see Section 6.3.2.2).

11.4 Determination of Bag Water Vapor Content. Measure the ambient temperature and barometric pressure near the bag. From a water saturation vapor pressure table, determine and record the water vapor content of the bag,  $B_{wb}$ , as a decimal figure. (Assume the relative humidity to be 100 percent unless a lesser value is known.)

## 12.0 Calculations and Data Analysis

### 12.1 Nomenclature.

$A_m$  = Measured peak area.

$A_f$  = Attenuation factor.

$B_{wb}$  = Water vapor content of the bag sample, as analyzed, volume fraction.

$C_b$  = Concentration of vinyl chloride in the bag, ppmv.

$C_c$  = Concentration of vinyl chloride in the standard sample, ppmv.

$P_i$  = Laboratory pressure at time of analysis, mm Hg.

$P_r$  = Reference pressure, the laboratory pressure recorded during calibration, mm Hg.

$T_i$  = Absolute sample loop temperature at the time of analysis, °K (°R).

$T_r$  = Reference temperature, the sample loop temperature recorded during calibration, °K (°R).

### 12.2 Sample Peak Area. Determine the sample peak area, $A_c$ , as follows:



$$A_c = A_m A_f \quad \text{Eq. 106-1}$$

12.3 Vinyl Chloride Concentration. From the calibration curves prepared in Section 10.3, determine the average concentration value of vinyl chloride,  $C_c$ , that corresponds to  $A_c$ , the sample peak area. Calculate the concentration of vinyl chloride in the bag,  $C_b$ , as follows:

$$C_b = \frac{C_c P_r T_i}{P_i T_r (1 - B_{vb})} \quad \text{Eq. 106-2}$$

### 13.0 Method Performance

13.1 Analytical Range. This method is designed for the 0.1 to 50 parts per million by volume (ppmv) range. However, common gas chromatograph (GC) instruments are capable of detecting 0.02 ppmv vinyl chloride. With proper calibration, the upper limit may be extended as needed.

### 14.0 Pollution Prevention, [Reserved]

### 15.0 Waste Management, [Reserved]

### 16.0 References

1. Brown D.W., E.W. Loy, and M.H. Stephenson. Vinyl Chloride Monitoring Near the B. F. Goodrich Chemical Company in Louisville, KY. Region IV, U.S. Environmental Protection Agency, Surveillance and Analysis Division, Athens, GA. June 24, 1974.

2. G.D. Clayton and Associates. Evaluation of a Collection and Analytical Procedure for Vinyl Chloride in Air. U.S. Environmental Protection Agency, Research Triangle Park, N.C. EPA Contract No. 68-02-1408, Task Order No. 2, EPA Report No. 75-VCL-1. December 13, 1974.

3. Midwest Research Institute. Standardization of Stationary Source Emission Method for Vinyl Chloride. U.S. Environmental Protection Agency, Research Triangle Park, N.C. Publication No. EPA-600/4-77-026. May 1977.

4. Scheil, G. and M.C. Sharp. Collaborative Testing of EPA Method 106 (Vinyl Chloride) that Will Provide for a Standardized Stationary Source Emission Measurement Method. U.S. Environmental Protection Agency, Research Triangle Park, N.C. Publication No. EPA 600/4-78-058. October 1978.

### 17.0 Tables, Diagrams Flowcharts, and Validation Data.

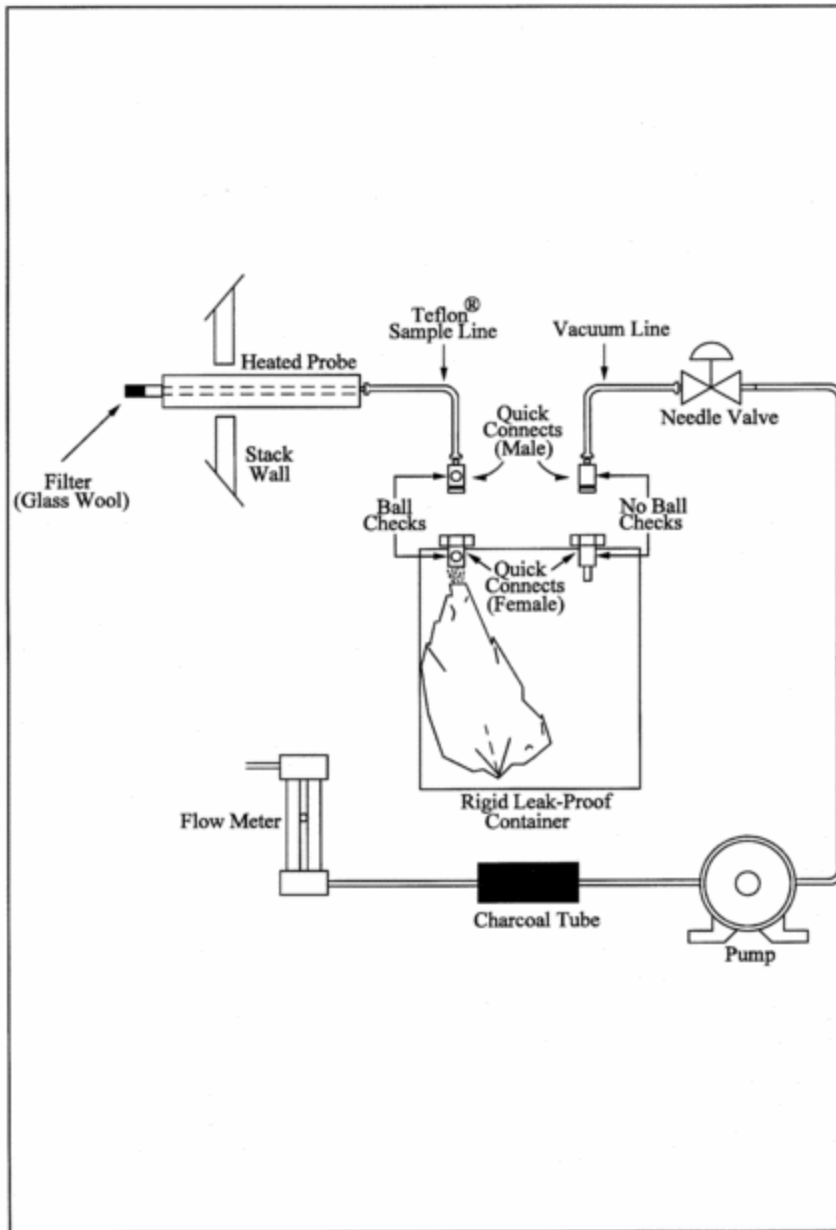

Figure 106-1. Integrated-bag sampling train.

METHOD 107—DETERMINATION OF VINYL CHLORIDE CONTENT OF IN-PROCESS WASTEWATER SAMPLES, AND VINYL CHLORIDE CONTENT OF POLYVINYL CHLORIDE RESIN SLURRY, WET CAKE, AND LATEX SAMPLES

NOTE: Performance of this method should not be attempted by persons unfamiliar with the operation of a gas chromatograph (GC) nor by those who are unfamiliar with source sampling, because knowledge beyond the scope of this presentation is required. This method does not include all of the specifications (e.g., equipment and supplies) and procedures (e.g., sampling and analytical) essential to its performance. Some material is incorporated by reference from other methods in this part. Therefore, to obtain reliable results, persons using this method should have a thorough knowledge of at least the following additional test methods: Method 106.

1.0 Scope and Application

1.1 Analytes.

| Analyte                                | CAS No. | Sensitivity                          |
|--|---------|--------------------------------------|
| Vinyl Chloride (CH <sub>2</sub> :CHCl) | 75-01-4 | Dependent upon analytical equipment. |

1.2 Applicability. This method is applicable for the determination of the vinyl chloride monomer (VCM) content of in-process wastewater samples, and the residual vinyl chloride monomer (RCVM) content of polyvinyl chloride (PVC) resins, wet, cake, slurry, and latex samples. It cannot be used for polymer in fused forms, such as sheet or cubes. This method is not acceptable where methods from section 304(h) of the Clean Water Act, 33 U.S.C. 1251 *et seq.* (the Federal Water Pollution Control Amendments of 1972 as amended by the Clean Water Act of 1977) are required.

1.3 Data Quality Objectives. Adherence to the requirements of this method will enhance the quality of the data obtained from air pollutant sampling methods.

## 2.0 Summary of Method

2.1 The basis for this method relates to the vapor equilibrium that is established at a constant known temperature in a closed system between RVCM, PVC resin, water, and air. The RVCM in a PVC resin will equilibrate rapidly in a closed vessel, provided that the temperature of the PVC resin is maintained above the glass transition temperature of that specific resin.

2.2 A sample of PVC or in-process wastewater is collected in a vial or bottle and is conditioned. The headspace in the vial or bottle is then analyzed for vinyl chloride using gas chromatography with a flame ionization detector.

## 3.0 Definitions [Reserved]

## 4.0 Interferences

4.1 The chromatograph columns and the corresponding operating parameters herein described normally provide an adequate resolution of vinyl chloride; however, resolution interferences may be encountered on some sources. Therefore, the chromatograph operator shall select the column and operating parameters best suited to his particular analysis requirements, subject to the approval of the Administrator. Approval is automatic provided that confirming data are produced through an adequate supplemental analytical technique, such as analysis with a different column or GC/mass spectroscopy, and that these data are made available for review by the Administrator.

## 5.0 Safety

5.1 Disclaimer. This method may involve hazardous materials, operations, and equipment. This test method may not address all of the safety problems associated with its use. It is the responsibility of the user of this test method to establish appropriate safety and health practices and determine the applicability of regulatory limitations prior to performing this test method.

5.2 Toxic Analyte. Care must be exercised to prevent exposure of sampling personnel to vinyl chloride, which is a carcinogen. Do not release vinyl chloride to the laboratory atmosphere during preparation of standards. Venting or purging with VCM/air mixtures must be held to a minimum. When they are required, the vapor must be routed to outside air. Vinyl chloride, even at low ppm levels, must never be vented inside the laboratory. After vials have been analyzed, the gas must be vented prior to removal of the vial from the instrument turntable. Vials must be vented through a hypodermic needle connected to an activated charcoal tube to prevent release of vinyl chloride into the laboratory atmosphere. The charcoal must be replaced prior to vinyl chloride breakthrough.

## 6.0 *Equipment and Supplies*

6.1 Sample Collection. The following equipment is required:

6.1.1 Glass bottles. 60-ml (2-oz) capacity, with wax-lined screw-on tops, for PVC samples.

6.1.2 Glass Vials. Headspace vials, with Teflon-faced butyl rubber sealing discs, for water samples.

6.1.3 Adhesive Tape. To prevent loosening of bottle tops.

6.2 Sample Recovery. The following equipment is required:

6.2.1 Glass Vials. Headspace vials, with butyl rubber septa and aluminum caps. Silicone rubber is not acceptable.

6.2.2 Analytical Balance. Capable of determining sample weight within an accuracy of  $\pm 1$  percent.

6.2.3 Vial Sealer. To seal headspace vials.

6.2.4 Syringe. 100-ml capacity.

6.3 Analysis. The following equipment is required:

6.3.1 Headspace Sampler and Chromatograph. Capable of sampling and analyzing a constant amount of headspace gas from a sealed vial, while maintaining that vial at a temperature of  $90\text{ }^{\circ}\text{C} \pm 0.5\text{ }^{\circ}\text{C}$  ( $194\text{ }^{\circ}\text{F} \pm 0.9\text{ }^{\circ}\text{F}$ ). The chromatograph shall be equipped with a flame ionization detector (FID). Perkin-Elmer Corporation Models F-40, F-42, F-45, HS-6, and HS-100, and Hewlett-Packard Corporation Model 19395A have been found satisfactory. Chromatograph backflush capability may be required.

6.3.2 Chromatographic Columns. Stainless steel 1 m by 3.2 mm and 2 m by 3.2 mm, both containing 50/80-mesh Porapak Q. Other columns may be used provided that the precision and accuracy of the analysis of vinyl chloride standards are not impaired and information confirming that there is adequate resolution of the vinyl chloride peak are available for review. (Adequate resolution is defined as an area overlap of not more than 10 percent of the vinyl chloride peak by an interferant peak. Calculation of area overlap is explained in Procedure 1 of appendix C to this part: "Determination of Adequate Chromatographic Peak Resolution.") Two 1.83 m columns, each containing 1 percent Carbowax 1500 on Carbowax B, have been found satisfactory for samples containing acetaldehyde.

6.3.3 Temperature Sensor. Range 0 to  $100\text{ }^{\circ}\text{C}$  ( $32$  to  $212\text{ }^{\circ}\text{F}$ ) accurate to  $0.1\text{ }^{\circ}\text{C}$ .

6.3.4 Integrator-Recorder. To record chromatograms.

6.3.5 Barometer. Accurate to 1 mm Hg.

6.3.6 Regulators. For required gas cylinders.

6.3.7 Headspace Vial Pre-Pressurizer. Nitrogen pressurized hypodermic needle inside protective shield.

## 7.0 *Reagents and Standards*

7.1 Analysis. Same as Method 106, Section 7.1, with the addition of the following:

7.1.1 Water. Interference-free.

7.2 Calibration. The following items are required for calibration:

7.2.1 Cylinder Standards (4). Gas mixture standards (50-, 500-, 2000- and 4000-ppm vinyl chloride in nitrogen cylinders). Cylinder standards may be used directly to prepare a chromatograph calibration curve as described in Section 10.3, if the following conditions are met: (a) The manufacturer certifies the gas composition with an accuracy of  $\pm 3$  percent or better (see Section 7.2.1.1). (b) The manufacturer recommends a maximum shelf life over which the gas concentration does not change by greater than  $\pm 5$  percent from the certified value. (c) The manufacturer affixes the date of gas cylinder preparation, certified vinyl chloride concentration, and recommended maximum shelf life to the cylinder before shipment to the buyer.

7.2.1.1 Cylinder Standards Certification. The manufacturer shall certify the concentration of vinyl chloride in nitrogen in each cylinder by (a) directly analyzing each cylinder and (b) calibrating the analytical procedure on the day of cylinder analysis. To calibrate the analytical procedure, the manufacturer shall use, as a minimum, a 3-point calibration curve. It is recommended that the manufacturer maintain (1) a high-concentration calibration standard (between 4000 and 8000 ppm) to prepare the calibration curve by an appropriate dilution technique and (2) a low-concentration calibration standard (between 50 and 500 ppm) to verify the dilution technique used. If the difference between the apparent concentration read from the calibration curve and the true concentration assigned to the low-concentration calibration standard exceeds 5 percent of the true concentration, the manufacturer shall determine the source of error and correct it, then repeat the 3-point calibration.

7.2.1.2 Verification of Manufacturer's Calibration Standards. Before using, the manufacturer shall verify each calibration standard by (a) comparing it to gas mixtures prepared (with 99 mole percent vinyl chloride) in accordance with the procedure described in Section 10.1 of Method 106 or by (b) calibrating it against vinyl chloride cylinder Standard Reference Materials (SRMs) prepared by the National Institute of Standards and Technology, if such SRMs are available. The agreement between the initially determined concentration value and the verification concentration value must be within 5 percent. The manufacturer must reverify all calibration standards on a time interval consistent with the shelf life of the cylinder standards sold.

## *8.0 Sample Collection, Preservation, Storage, and Transport*

8.1 Sample Collection.

8.1.1 PVC Sampling. Allow the resin or slurry to flow from a tap on the tank or silo until the tap line has been well purged. Extend and fill a 60-ml sample bottle under the tap, and immediately tighten a cap on the bottle. Wrap adhesive tape around the cap and bottle to prevent the cap from loosening. Place an identifying label on each bottle, and record the date, time, and sample location both on the bottles and in a log book.

8.1.2 Water Sampling. At the sampling location fill the vials bubble-free to overflowing so that a convex meniscus forms at the top. The excess water is displaced as the sealing disc is carefully placed, with the Teflon side down, on the opening of the vial. Place the aluminum seal over the disc and the neck of the vial, and crimp into place. Affix an identifying label on the bottle, and record the date, time, and sample location both on the vials and in a log book.

8.2 Sample Storage. All samples must be analyzed within 24 hours of collection, and must be refrigerated during this period.

## 9.0 Quality Control

| Section | Quality control measure   | Effect  |
|---------|---------------------------|---|
| 10.3    | Chromatograph calibration | Ensure precision and accuracy of chromatograph. |

### 10.0 Calibration and Standardization

NOTE: Maintain a laboratory log of all calibrations.

10.1 Preparation of Standards. Calibration standards are prepared as follows: Place 100  $\mu$ l or about two equal drops of distilled water in the sample vial, then fill the vial with the VCM/nitrogen standard, rapidly seat the septum, and seal with the aluminum cap. Use a  $\frac{1}{8}$ -in. stainless steel line from the cylinder to the vial. Do not use rubber or Tygon tubing. The sample line from the cylinder must be purged (into a properly vented hood) for several minutes prior to filling the vials. After purging, reduce the flow rate to between 500 and 1000 cc/min. Place end of tubing into vial (near bottom). Position a septum on top of the vial, pressing it against the  $\frac{1}{8}$ -in. filling tube to minimize the size of the vent opening. This is necessary to minimize mixing air with the standard in the vial. Each vial is to be purged with standard for 90 seconds, during which time the filling tube is gradually slid to the top of the vial. After the 90 seconds, the tube is removed with the septum, simultaneously sealing the vial. Practice will be necessary to develop good technique. Rubber gloves should be worn during the above operations. The sealed vial must then be pressurized for 60 seconds using the vial prepressurizer. Test the vial for leakage by placing a drop of water on the septum at the needle hole. Prepressurization of standards is not required unless samples have been prepressurized.

10.2 Analyzer Calibration. Calibration is to be performed each 8-hour period the chromatograph is used. Alternatively, calibration with duplicate 50-, 500-, 2,000-, and 4,000-ppm standards (hereafter described as a four-point calibration) may be performed on a monthly basis, provided that a calibration confirmation test consisting of duplicate analyses of an appropriate standard is performed once per plant shift, or once per chromatograph carousel operation (if the chromatograph operation is less frequent than once per shift). The criterion for acceptance of each calibration confirmation test is that both analyses of 500-ppm standards [2,000-ppm standards if dispersion resin (excluding latex resin) samples are being analyzed] must be within 5 percent of the most recent four-point calibration curve. If this criterion is not met, then a complete four-point calibration must be performed before sample analyses can proceed.

10.3 Preparation of Chromatograph Calibration Curve. Prepare two vials each of 50-, 500-, 2,000-, and 4,000-ppm standards. Run the calibration samples in exactly the same manner as regular samples. Plot  $A_s$ , the integrator area counts for each standard sample, versus  $C_c$ , the concentration of vinyl chloride in each standard sample. Draw a straight line through the points derived by the least squares method.

### 11.0 Analytical Procedure

11.1 Preparation of Equipment. Install the chromatographic column and condition overnight at 160 °C (320 °F). In the first operation, Porapak columns must be purged for 1 hour at 230 °C (450 °F).

Do not connect the exit end of the column to the detector while conditioning. Hydrogen and air to the detector must be turned off while the column is disconnected.

11.2 Flow Rate Adjustments. Adjust flow rates as follows:

11.2.1. Nitrogen Carrier Gas. Set regulator on cylinder to read 50 psig. Set regulator on chromatograph to produce a flow rate of 30.0 cc/min. Accurately measure the flow rate at the exit end of the column using the soap film flowmeter and a stopwatch, with the oven and column at the analysis temperature. After the instrument program advances to the "B" (backflush) mode, adjust the nitrogen

pressure regulator to exactly balance the nitrogen flow rate at the detector as was obtained in the "A" mode.

#### 11.2.2. Vial Prepressurizer Nitrogen.

11.2.2.1 After the nitrogen carrier is set, solve the following equation and adjust the pressure on the vial prepressurizer accordingly.

$$P = \frac{T_1}{T_2} \left[ P_1 - \frac{P_{w1} - P_{w2}}{7.50} \right] - 10 \text{ kPa} \quad \text{Eq. 107-1}$$

Where:

$T_1$  = Ambient temperature, °K (°R).

$T_2$  = Conditioning bath temperature, °K (°R).

$P_1$  = Gas chromatograph absolute dosing pressure (analysis mode), k Pa.

$P_{w1}$  = Water vapor pressure 525.8 mm Hg @ 90 °C.

$P_{w2}$  = Water vapor pressure 19.8 mm Hg @ 22 °C.

7.50 = mm Hg per k Pa.

10 kPa = Factor to adjust the prepressurized pressure to slightly less than the dosing pressure.

11.2.2.2 Because of gauge errors, the apparatus may over-pressurize the vial. If the vial pressure is at or higher than the dosing pressure, an audible double injection will occur. If the vial pressure is too low, errors will occur on resin samples because of inadequate time for head-space gas equilibrium. This condition can be avoided by running several standard gas samples at various pressures around the calculated pressure, and then selecting the highest pressure that does not produce a double injection. All samples and standards must be pressurized for 60 seconds using the vial prepressurizer. The vial is then placed into the 90 °C conditioning bath and tested for leakage by placing a drop of water on the septum at the needle hole. A clean, burr-free needle is mandatory.

11.2.3. Burner Air Supply. Set regulator on cylinder to read 50 psig. Set regulator on chromatograph to supply air to burner at a rate between 250 and 300 cc/min. Check with bubble flowmeter.

11.2.4. Hydrogen Supply. Set regulator on cylinder to read 30 psig. Set regulator on chromatograph to supply approximately 35 ±5 cc/min. Optimize hydrogen flow to yield the most sensitive detector response without extinguishing the flame. Check flow with bubble meter and record this flow.

11.3 Temperature Adjustments. Set temperatures as follows:

11.3.1. Oven (chromatograph column), 140 °C (280 °F).

11.3.2. Dosing Line, 150 °C (300 °F).

11.3.3. Injection Block, 170 °C (340 °F).

11.3.4. Sample Chamber, Water Temperature, 90 °C ±1.0 °C (194 °F ±1.8 °F).

11.4 Ignition of Flame Ionization Detector. Ignite the detector according to the manufacturer's instructions.

11.5 Amplifier Balance. Balance the amplifier according to the manufacturer's instructions.

11.6 Programming the Chromatograph. Program the chromatograph as follows:

11.6.1. I—Dosing or Injection Time. The normal setting is 2 seconds.

11.6.2. A—Analysis Time. The normal setting is approximately 70 percent of the VCM retention time. When this timer terminates, the programmer initiates backflushing of the first column.

11.6.3. B—Backflushing Time. The normal setting is double the analysis time.

11.6.4. W—Stabilization Time. The normal setting is 0.5 min to 1.0 min.

11.6.5. X—Number of Analyses Per Sample. The normal setting is one.

11.7. Sample Treatment. All samples must be recovered and analyzed within 24 hours after collection.

11.7.1 Resin Samples. The weight of the resin used must be between 0.1 and 4.5 grams. An exact weight must be obtained (within  $\pm 1$  percent) for each sample. In the case of suspension resins, a volumetric cup can be prepared for holding the required amount of sample. When the cup is used, open the sample bottle, and add the cup volume of resin to the tared sample vial (tared, including septum and aluminum cap). Obtain the exact sample weight, add 100 ml or about two equal drops of water, and immediately seal the vial. Report this value on the data sheet; it is required for calculation of RVCM. In the case of dispersion resins, the cup cannot be used. Weigh the sample in an aluminum dish, transfer the sample to the tared vial, and accurately weigh it in the vial. After prepressurization of the samples, condition them for a minimum of 1 hour in the 90 °C (190 °F) bath. Do not exceed 5 hours. Prepressurization is not required if the sample weight, as analyzed, does not exceed 0.2 gram. It is also not required if solution of the prepressurization equation yields an absolute prepressurization value that is within 30 percent of the atmospheric pressure.

NOTE: Some aluminum vial caps have a center section that must be removed prior to placing into sample tray. If the cap is not removed, the injection needle will be damaged.

11.7.2 Suspension Resin Slurry and Wet Cake Samples. Decant the water from a wet cake sample, and turn the sample bottle upside down onto a paper towel. Wait for the water to drain, place approximately 0.2 to 4.0 grams of the wet cake sample in a tared vial (tared, including septum and aluminum cap) and seal immediately. Then determine the sample weight (1 percent). All samples weighing over 0.2 gram, must be prepressurized prior to conditioning for 1 hour at 90 °C (190 °F), except as noted in Section 11.7.1. A sample of wet cake is used to determine total solids (TS). This is required for calculating the RVCM.

11.7.3 Dispersion Resin Slurry and Geon Latex Samples. The materials should not be filtered. Sample must be thoroughly mixed. Using a tared vial (tared, including septum and aluminum cap) add approximately eight drops (0.25 to 0.35 g) of slurry or latex using a medicine dropper. This should be done immediately after mixing. Seal the vial as soon as possible. Determine sample weight (1 percent). Condition the vial for 1 hour at 90 °C (190 °F) in the analyzer bath. Determine the TS on the slurry sample (Section 11.10).



11.7.4 In-process Wastewater Samples. Using a tared vial (tared, including septum and aluminum cap) quickly add approximately 1 cc of water using a medicine dropper. Seal the vial as soon as possible. Determine sample weight (1 percent). Condition the vial for 1 hour at 90 °C (190 °F) in the analyzer bath.

## 11.8 Preparation of Sample Turntable.

11.8.1 Before placing any sample into turntable, be certain that the center section of the aluminum cap has been removed. The numbered sample vials should be placed in the corresponding numbered positions in the turntable. Insert samples in the following order:

11.8.1.1 Positions 1 and 2. Old 2000-ppm standards for conditioning. These are necessary only after the analyzer has not been used for 24 hours or longer.

11.8.1.2 Position 3. 50-ppm standard, freshly prepared.

11.8.1.3 Position 4. 500-ppm standard, freshly prepared.

11.8.1.4 Position 5. 2000-ppm standard, freshly prepared.

11.8.1.5 Position 6. 4000-ppm standard, freshly prepared.

11.8.1.6 Position 7. Sample No. 7 (This is the first sample of the day, but is given as 7 to be consistent with the turntable and the integrator printout.)

11.8.2 After all samples have been positioned, insert the second set of 50-, 500-, 2000-, and 4000-ppm standards. Samples, including standards, must be conditioned in the bath of 90 °C (190 °F) for a minimum of one hour and a maximum of five hours.

11.9 Start Chromatograph Program. When all samples, including standards, have been conditioned at 90 °C (190 °F) for at least one hour, start the analysis program according to the manufacturer's instructions. These instructions must be carefully followed when starting and stopping a program to prevent damage to the dosing assembly.

11.10 Determination of Total Solids. For wet cake, slurry, resin solution, and PVC latex samples, determine TS for each sample by accurately weighing approximately 3 to 4 grams of sample in an aluminum pan before and after placing in a draft oven (105 to 110 °C (221 to 230 °F)). Samples must be dried to constant weight. After first weighing, return the pan to the oven for a short period of time, and then reweigh to verify complete dryness. The TS are then calculated as the final sample weight divided by initial sample weight.

## 12.0 Calculations and Data Analysis

### 12.1 Nomenclature.

$A_s$  = Chromatogram area counts of vinyl chloride for the sample, area counts.

$A_s$  = Chromatogram area counts of vinyl chloride for the sample.

$C_c$  = Concentration of vinyl chloride in the standard sample, ppm.

$K_p$  = Henry's Law Constant for VCM in PVC 90 °C,  $6.52 \times 10^{-6}$  g/g/mm Hg.

$K_w$  = Henry's Law Constant for VCM in water 90 °C,  $7 \times 10^{-7}$  g/g/mm Hg.

$M_v$  = Molecular weight of VCM, 62.5 g/mole.

$m$  = Sample weight, g.

$P_a$  = Ambient atmospheric pressure, mm Hg.

$R$  = Gas constant, (62360 <sup>3</sup> ml) (mm Hg)/(mole)(°K).

$R_f$  = Response factor in area counts per ppm VCM.

$R_s$  = Response factor, area counts/ppm.

$T_1$  = Ambient laboratory temperature, °K.

TS = Total solids expressed as a decimal fraction.

$T_2$  = Equilibrium temperature, °K.

$V_g$  = Volume of vapor phase, ml.

$$= V_v - \frac{m(TS)}{1.36} - \frac{m(1-TS)}{0.9653}$$

$V_v$  = Vial volume, <sup>3</sup> ml.

1.36 = Density of PVC at 90 °C, g/<sup>3</sup> ml.

0.9653 = Density of water at 90 °C, g/<sup>3</sup> ml.

12.2 Response Factor. If the calibration curve described in Section 10.3 passes through zero, an average response factor,  $R_f$ , may be used to facilitate computation of vinyl chloride sample concentrations.

12.2.1 To compute  $R_f$ , first compute a response factor,  $R_s$ , for each sample as follows:

$$R_s = \frac{A_s}{C_s} \quad \text{Eq. 107-2}$$

12.2.2 Sum the individual response factors, and calculate  $R_f$ . If the calibration curve does not pass through zero, use the calibration curve to determine each sample concentration.

12.3 Residual Vinyl Chloride Monomer Concentration, ( $C_{rv}$ ) or Vinyl Chloride Monomer Concentration. Calculate  $C_{rv}$  in ppm or mg/kg as follows:

$$C_{rv} = \frac{A_s P_a}{R_f T_1} \left[ \frac{M_v V_g}{R m} + K_p (TS) T_2 K_w (1-TS) T_2 \right] \quad \text{Eq. 107-3}$$

NOTE: Results calculated using these equations represent concentration based on the total sample. To obtain results based on dry PVC content, divide by TS.

### 13.0 Method Performance

13.1 Range and Sensitivity. The lower limit of detection of vinyl chloride will vary according to the sampling and chromatographic system. The system should be capable of producing a measurement for a 50-ppm vinyl chloride standard that is at least 10 times the standard deviation of the system background noise level.

13.2 An interlaboratory comparison between seven laboratories of three resin samples, each split into three parts, yielded a standard deviation of 2.63 percent for a sample with a mean of 2.09 ppm, 4.16 percent for a sample with a mean of 1.66 ppm, and 5.29 percent for a sample with a mean of 62.66 ppm.

#### 14.0 *Pollution Prevention [Reserved]*

#### 15.0 *Waste Management [Reserved]*

#### 16.0 *References*

1. B.F. Goodrich, Residual Vinyl Chloride Monomer Content of Polyvinyl Chloride Resins, Latex, Wet Cake, Slurry and Water Samples. B.F. Goodrich Chemical Group Standard Test Procedure No. 1005-E. B.F. Goodrich Technical Center, Avon Lake, Ohio. October 8, 1979.

2. Berens, A.R. The Diffusion of Vinyl Chloride in Polyvinyl Chloride. ACS-Division of Polymer Chemistry, Polymer Preprints 15 (2):197. 1974.

3. Berens, A.R. The Diffusion of Vinyl Chloride in Polyvinyl Chloride. ACS-Division of Polymer Chemistry, Polymer Preprints 15 (2):203. 1974.

4. Berens, A.R., *et. al.* Analysis for Vinyl Chloride in PVC Powders by Head-Space Gas Chromatography. Journal of Applied Polymer Science. 19:3169-3172. 1975.

5. Mansfield, R.A. The Evaluation of Henry's Law Constant (Kp) and Water Enhancement in the Perkin-Elmer Multifract F-40 Gas Chromatograph. B.F. Goodrich. Avon Lake, Ohio. February 10, 1978.

#### 17.0 *Tables, Diagrams, Flowcharts, and Validation Data [Reserved]*

#### METHOD 107A—DETERMINATION OF VINYL CHLORIDE CONTENT OF SOLVENTS, RESIN-SOLVENT SOLUTION, POLYVINYL CHLORIDE RESIN, RESIN SLURRY, WET RESIN, AND LATEX SAMPLES

##### *Introduction*

Performance of this method should not be attempted by persons unfamiliar with the operation of a gas chromatograph (GC) or by those who are unfamiliar with source sampling because knowledge beyond the scope of this presentation is required. Care must be exercised to prevent exposure of sampling personnel to vinyl chloride, a carcinogen.

##### *1. Applicability and Principle*

1.1 *Applicability.* This is an alternative method and applies to the measurement of the vinyl chloride content of solvents, resin solvent solutions, polyvinyl chloride (PVC) resin, wet cake slurries, latex, and fabricated resin samples. This method is not acceptable where methods from Section 304(h) of the Clean Water Act, 33 U.S.C. 1251 *et seq.*, (the Federal Water Pollution Control Act Amendments of 1972 as amended by the Clean Water Act of 1977) are required.

1.2 *Principle.* The basis for this method lies in the direct injection of a liquid sample into a chromatograph and the subsequent evaporation of all volatile material into the carrier gas stream of the chromatograph, thus permitting analysis of all volatile material including vinyl chloride.

##### *2. Range and Sensitivity*

The lower limit of detection of vinyl chloride in dry PVC resin is 0.2 ppm. For resin solutions, latexes, and wet resin, this limit rises inversely as the nonvolatile (resin) content decreases.

With proper calibration, the upper limit may be extended as needed.

### 3. *Interferences*

The chromatograph columns and the corresponding operating parameters herein described normally provide an adequate resolution of vinyl chloride. In cases where resolution interferences are encountered, the chromatograph operator shall select the column and operating parameters best suited to his particular analysis problem, subject to the approval of the Administrator. Approval is automatic, provided that the tester produces confirming data through an adequate supplemental analytical technique, such as analysis with a different column or GC/mass spectroscopy, and has the data available for review by the Administrator.

### 4. *Precision and Reproducibility*

A standard sample of latex containing 181.8 ppm vinyl chloride analyzed 10 times by the alternative method showed a standard deviation of 7.5 percent and a mean error of 0.21 percent.

A sample of vinyl chloride copolymer resin solution was analyzed 10 times by the alternative method and showed a standard deviation of 6.6 percent at a level of 35 ppm.

### 5. *Safety*

Do not release vinyl chloride to the laboratory atmosphere during preparation of standards. Venting or purging with vinyl chloride monomer (VCM) air mixtures must be held to minimum. When purging is required, the vapor must be routed to outside air. Vinyl chloride, even at low-ppm levels, must never be vented inside the laboratory.

### 6. *Apparatus*

6.1 Sampling. The following equipment is required:

6.1.1 Glass Bottles. 16-oz wide mouth wide polyethylene-lined, screw-on tops.

6.1.2 Adhesive Tape. To prevent loosening of bottle tops.

6.2 Sample Recovery. The following equipment is required:

6.2.1 Glass Vials. 20-ml capacity with polycone screw caps.

6.2.2 Analytical Balance. Capable of weighing to  $\pm 0.01$  gram.

6.2.3 Syringe. 50-microliter size, with removable needle.

6.2.4 Fritted Glass Sparger. Fine porosity.

6.2.5 Aluminum Weighing Dishes.

6.2.6 Sample Roller or Shaker. To help dissolve sample.

6.3 Analysis. The following equipment is required:

6.3.1 Gas Chromatograph. Hewlett Packard Model 5720A or equivalent.

6.3.2 Chromatograph Column. Stainless steel, 6.1 m by 3.2 mm, packed with 20 percent Tergitol E-35 on Chromosorb W AW 60/80 mesh. The analyst may use other columns provided that the precision and accuracy of the analysis of vinyl chloride standards are not impaired and that he has available for review information confirming that there is adequate resolution of the vinyl chloride peak. (Adequate resolution is defined as an area overlap of not more than 10 percent of the vinyl chloride peak by an interfering peak. Calculation of area overlap is explained in Appendix C, Procedure 1: "Determination of Adequate Chromatographic Peak Resolution.")

6.3.3 Valco Instrument Six-Port Rotary Valve. For column back flush.

6.3.4 Septa. For chromatograph injection port.

6.3.5 Injection Port Liners. For chromatograph used.

6.3.6 Regulators. For required gas cylinders.

6.3.7 Soap Film Flowmeter. Hewlett Packard No. 0101-0113 or equivalent.

6.4 Calibration. The following equipment is required:

6.4.1 Analytical Balance. Capable of weighing to  $\pm 0.0001$  g.

6.4.2 Erlenmeyer Flask With Glass Stopper. 125 ml.

6.4.3 Pipets. 0.1, 0.5, 1, 5, 10, and 50 ml.

6.4.4 Volumetric Flasks. 10 and 100 ml.

## 7. Reagents

Use only reagents that are of chromatograph grade.

7.1 Analysis. The following items are required:

7.1.1 Hydrogen Gas. Zero grade.

7.1.2 Nitrogen Gas. Zero grade.

7.1.3 Air. Zero grade.

7.1.4 Tetrahydrofuran (THF). Reagent grade.

Analyze the THF by injecting 10 microliters into the prepared gas chromatograph. Compare the THF chromatogram with that shown in Figure 107A-1. If the chromatogram is comparable to A, the THF should be sparged with pure nitrogen for approximately 2 hours using the fritted glass sparger to attempt to remove the interfering peak. Reanalyze the sparged THF to determine whether the THF is acceptable for use. If the scan is comparable to B, the THF should be acceptable for use in the analysis.

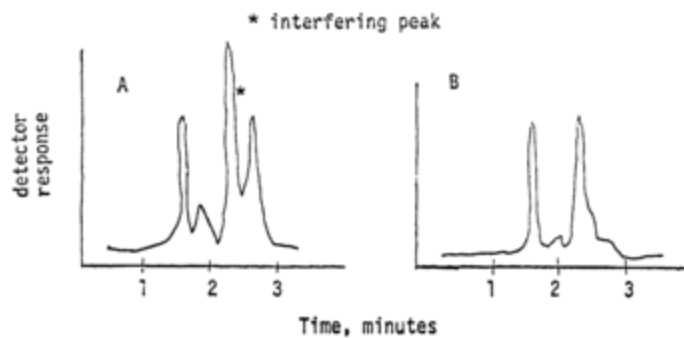

Figure 107A-1

7.1.5 N, N-Dimethylacetamide (DMAC). Spectrographic grade. For use in place of THF.

7.2 Calibration. The following item is required:

7.2.1 Vinyl Chloride 99.9 Percent. Ideal Gas Products lecture bottle, or equivalent. For preparation of standard solutions.

## 8. Procedure

8.1 Sampling. Allow the liquid or dried resin to flow from a tap on the tank, silo, or pipeline until the tap has been purged. Fill a wide-mouth pint bottle, and immediately tightly cap the bottle. Place an identifying label on each bottle and record the date, time, sample location, and material.

8.2 Sample Treatment. Sample must be run within 24 hours.

8.2.1 Resin Samples. Weigh  $9.00 \pm 0.01$  g of THF or DMAC in a tared 20-ml vial. Add  $1.00 \pm 0.01$  g of resin to the tared vial containing the THF or DMAC. Close the vial tightly with the screw cap, and shake or otherwise agitate the vial until complete solution of the resin is obtained. Shaking may require several minutes to several hours, depending on the nature of the resin.

8.2.2 Suspension Resin Slurry and Wet Resin Sample. Slurry must be filtered using a small Buchner funnel with vacuum to yield a wet resin sample. The filtering process must be continued only as long as a steady stream of water is exiting from the funnel. Excessive filtration time could result in some loss of VCM. The wet resin sample is weighed into a tared 20-ml vial with THF or DMAC as described earlier for resin samples (8.2.1) and treated the same as the resin sample. A sample of the wet resin is used to determine total solids as required for calculating the residual VCM (Section 8.3.4).

8.2.3 Latex and Resin Solvent Solutions. Samples must be thoroughly mixed. Weigh  $1.00 \pm 0.01$  g of the latex or resin-solvent solution into a 20-ml vial containing  $9.00 \pm 0.01$  g of THF or DMAC as for the resin samples (8.2.1). Cap and shake until complete solution is obtained. Determine the total solids of the latex or resin solution sample (Section 8.3.4).

8.2.4 Solvents and Non-viscous Liquid Samples. No preparation of these samples is required. The neat samples are injected directly into the GC.

8.3 Analysis.

8.3.1 Preparation of GC. Install the chromatographic column, and condition overnight at  $70^\circ\text{C}$ . Do not connect the exit end of the column to the detector while conditioning.

8.3.1.1 Flow Rate Adjustments. Adjust the flow rate as follows:

a. Nitrogen Carrier Gas. Set regulator on cylinder to read 60 psig. Set column flow controller on the chromatograph using the soap film flowmeter to yield a flow rate of 40 cc/min.

b. Burner Air Supply. Set regulator on the cylinder at 40 psig. Set regulator on the chromatograph to supply air to the burner to yield a flow rate of 250 to 300 cc/min using the flowmeter.

c. Hydrogen. Set regulator on cylinder to read 60 psig. Set regulator on the chromatograph to supply 30 to 40 cc/min using the flowmeter. Optimize hydrogen flow to yield the most sensitive detector response without extinguishing the flame. Check flow with flowmeter and record this flow.

d. Nitrogen Back Flush Gas. Set regulator on the chromatograph using the soap film flowmeter to yield a flow rate of 40 cc/min.

8.3.1.2 Temperature Adjustments. Set temperature as follows:

a. Oven (chromatographic column) at 70 °C.

b. Injection Port at 100 °C.

c. Detector at 300 °C.

8.3.1.3 Ignition of Flame Ionization Detector. Ignite the detector according to the manufacturer's instructions. Allow system to stabilize approximately 1 hour.

8.3.1.4 Recorder. Set pen at zero and start chart drive.

8.3.1.5 Attenuation. Set attenuation to yield desired peak height depending on sample VCM content.

8.3.2 Chromatographic Analyses.

a. Sample Injection. Remove needle from 50-microliter syringe. Open sample vial and draw 50-microliters of THF or DMAC sample recovery solution into the syringe. Recap sample vial. Attach needle to the syringe and while holding the syringe vertically (needle uppermost), eject 40 microliters into an absorbent tissue. Wipe needle with tissue. Now inject 10 microliters into chromatograph system. Repeat the injection until two consecutive values for the height of the vinyl chloride peak do not vary more than 5 percent. Use the average value for these two peak heights to compute the sample concentration.

b. Back Flush. After 4 minutes has elapsed after sample injection, actuate the back flush valve to purge the first 4 feet of the chromatographic column of solvent and other high boilers.

c. Sample Data. Record on the chromatograph strip chart the data from the sample label.

d. Elution Time. Vinyl chloride elutes at 2.8 minutes. Acetaldehyde elutes at 3.7 minutes. Analysis is considered complete when chart pen becomes stable. After 5 minutes, reset back flush valve and inject next sample.

8.3.3 Chromatograph Servicing.

a. Septum. Replace after five sample injections.

b. Sample Port Liner. Replace the sample port liner with a clean spare after five sample injections.

c. Chromatograph Shutdown. If the chromatograph has been shut down overnight, rerun one or more samples from the preceding day to test stability and precision prior to starting on the current day's work.

8.3.4 Determination of Total Solids (TS). For wet resin, resin solution, and PVC latex samples, determine the TS for each sample by accurately weighing approximately 3 to 5 grams of sample into a tared aluminum pan. The initial procedure is as follows:

a. Where water is the major volatile component: Tare the weighing dish, and add 3 to 5 grams of sample to the dish. Weigh to the nearest milligram.

b. Where volatile solvent is the major volatile component: Transfer a portion of the sample to a 20-ml screw cap vial and cap immediately. Weigh the vial to the nearest milligram. Uncap the vial and transfer a 3- to 5-gram portion of the sample to a tared aluminum weighing dish. Recap the vial and reweigh to the nearest milligram. The vial weight loss is the sample weight.

To continue, place the weighing pan in a 130 °C oven for 1 hour. Remove the dish and allow to cool to room temperature in a desiccator. Weigh the pan to the nearest 0.1 mg. Total solids is the weight of material in the aluminum pan after heating divided by the net weight of sample added to the pan originally times 100.

## 9. Calibration of the Chromatograph

9.1 Preparation of Standards. Prepare a 1 percent by weight (approximate) solution of vinyl chloride in THF or DMAC by bubbling vinyl chloride gas from a cylinder into a tared 125-ml glass-stoppered flask containing THF or DMAC. The weight of vinyl chloride to be added should be calculated prior to this operation, i.e., 1 percent of the weight of THF or DMAC contained in the tared flask. This must be carried out in a laboratory hood. Adjust the vinyl chloride flow from the cylinder so that the vinyl chloride dissolves essentially completely in the THF or DMAC and is not blown to the atmosphere. Take particular care not to volatilize any of the solution. Stopper the flask and swirl the solution to effect complete mixing. Weigh the stoppered flask to nearest 0.1 mg to determine the exact amount of vinyl chloride added.

Pipet 10 ml of the approximately 1 percent solution into a 100-ml glass-stoppered volumetric flask, and add THF or DMAC to fill to the mark. Cap the flask and invert 10 to 20 times. This solution contains approximately 1,000 ppm by weight of vinyl chloride (note the exact concentration).

Pipet 50-, 10-, 5-, 1-, 0.5-, and 0.1-ml aliquots of the approximately 1,000 ppm solution into 10 ml glass stoppered volumetric flasks. Dilute to the mark with THF or DMAC, cap the flasks and invert each 10 to 20 times. These solutions contain approximately 500, 100, 50, 10, 5, and 1 ppm vinyl chloride. Note the exact concentration of each one. These standards are to be kept under refrigeration in stoppered bottles, and must be renewed every 3 months.

### 9.2 Preparation of Chromatograph Calibration Curve.

Obtain the GC for each of the six final solutions prepared in Section 9.1 by using the procedure in Section 8.3.2. Prepare a chart plotting peak height obtained from the chromatogram of each solution versus the known concentration. Draw a straight line through the points derived by the least squares method.

## 10. Calculations



10.1 Response Factor. From the calibration curve described in Section 9.2, select the value of  $C_c$  that corresponds to  $H_c$  for each sample. Compute the response factor,  $R_f$ , for each sample as follows:

$$R_f = \frac{C_c}{H_c} \quad \text{Eq. 107A-1}$$

where:

$R_f$  = Chromatograph response factor, ppm/mm.

$C_c$  = Concentration of vinyl chloride in the standard sample, ppm.

$H_c$  = Peak height of the standard sample, mm.

10.2 Residual vinyl chloride monomer concentration ( $C_{rv}$ ) or vinyl chloride monomer concentration in resin:

$$C_{rv} = 10H_s R_f \quad \text{Eq.107A-2}$$

Where:

$C_{rv}$  = Concentration of residual vinyl chloride monomer, ppm.

$H_s$  = Peak height of sample, mm.

$R_f$  = Chromatograph response factor.

10.3 Samples containing volatile material, i.e., resin solutions, wet resin, and latexes:

$$C_{rv} = \frac{H_s R_f (1,000)}{TS} \quad \text{Eq. 107A-3}$$

where:

TS = Total solids in the sample, weight fraction.

10.4 Samples of solvents and in process wastewater:

$$C_{rv} = \frac{H_s R_f}{0.888} \quad \text{Eq. 107A-4}$$

Where:

0.888 = Specific gravity of THF.

## 11. Bibliography

1. Communication from R. N. Wheeler, Jr.; Union Carbide Corporation. Part 61 National Emissions Standards for Hazardous Air Pollutants appendix B, Method 107—Alternate Method, September 19, 1977.

## METHOD 108—DETERMINATION OF PARTICULATE AND GASEOUS ARSENIC EMISSIONS

NOTE: This method does not include all of the specifications (e.g., equipment and supplies) and procedures (e.g., sampling and analytical) essential to its performance. Some material is incorporated by reference from other

methods in appendix A to 40 CFR part 60. Therefore, to obtain reliable results, persons using this method should have a thorough knowledge of at least the following additional test methods: Method 1, Method 2, Method 3, Method 5, and Method 12.

### 1.0 Scope and Application.

#### 1.1 Analytes.

| Analyte                           | CAS No.   | Sensitivity                   |
|-----------------------------------|-----------|-------------------------------|
| Arsenic compounds as arsenic (As) | 7440-38-2 | Lower limit 10 µg/ml or less. |

1.2 Applicability. This method is applicable for the determination of inorganic As emissions from stationary sources as specified in an applicable subpart of the regulations.

1.3 Data Quality Objectives. Adherence to the requirements of this method will enhance the quality of the data obtained from air pollutant sampling methods.

### 2.0 Summary of Method

Particulate and gaseous As emissions are withdrawn isokinetically from the source and are collected on a glass mat filter and in water. The collected arsenic is then analyzed by means of atomic absorption spectrophotometry (AAS).

### 3.0 Definitions. [Reserved]

### 4.0 Interferences

Analysis for As by flame AAS is sensitive to the chemical composition and to the physical properties (e.g., viscosity, pH) of the sample. The analytical procedure includes a check for matrix effects (Section 11.5).

### 5.0 Safety

5.1 This method may involve hazardous materials, operations, and equipment. This test method may not address all of the safety problems associated with its use. It is the responsibility of the user to establish appropriate safety and health practices and determine the applicability of regulatory limitations prior to performing this test method.

5.2 Corrosive reagents. The following reagents are hazardous. Personal protective equipment and safe procedures that prevent chemical splashes are recommended. If contact occurs, immediately flush with copious amounts of water for at least 15 minutes. Remove clothing under shower and decontaminate. Treat residual chemical burns as thermal burns.

5.2.1 Hydrochloric Acid (HCl). Highly corrosive liquid with toxic vapors. Vapors are highly irritating to eyes, skin, nose, and lungs, causing severe damage. May cause bronchitis, pneumonia, or edema of lungs. Exposure to concentrations of 0.13 to 0.2 percent can be lethal to humans in a few minutes. Provide ventilation to limit exposure. Reacts with metals, producing hydrogen gas.

5.2.2 Hydrogen Peroxide (H<sub>2</sub>O<sub>2</sub>). Very harmful to eyes. 30% H<sub>2</sub>O<sub>2</sub> can burn skin, nose, and lungs.

5.2.3 Nitric Acid (HNO<sub>3</sub>). Highly corrosive to eyes, skin, nose, and lungs. Vapors are highly toxic and can cause bronchitis, pneumonia, or edema of lungs. Reaction to inhalation may be delayed as long as 30 hours and still be fatal. Provide ventilation to limit exposure. Strong oxidizer. Hazardous reaction may occur with organic materials such as solvents.

5.2.4 Sodium Hydroxide (NaOH). Causes severe damage to eyes and skin. Inhalation causes irritation to nose, throat, and lungs. Reacts exothermically with small amounts of water.

## 6.0 Equipment and Supplies

6.1 Sample Collection. A schematic of the sampling train used in performing this method is shown in Figure 108-1; it is similar to the Method 5 sampling train of 40 CFR part 60, appendix A. The following items are required for sample collection:

6.1.1 Probe Nozzle, Probe Liner, Pitot Tube, Differential Pressure Gauge, Filter Holder, Filter Heating System, Temperature Sensor, Metering System, Barometer, and Gas Density Determination Equipment. Same as Method 5, Sections 6.1.1.1 to 6.1.1.7, 6.1.1.9, 6.1.2, and 6.1.3, respectively.

6.1.2 Impingers. Four impingers connected in series with leak-free ground-glass fittings or any similar leak-free noncontaminating fittings. For the first, third, and fourth impingers, use the Greenburg-Smith design, modified by replacing the tip with a 1.3-cm ID (0.5-in.) glass tube extending to about 1.3 cm (0.5 in.) from the bottom of the flask. For the second impinger, use the Greenburg-Smith design with the standard tip. Modifications (*e.g.*, flexible connections between the impingers, materials other than glass, or flexible vacuum lines to connect the filter holder to the condenser) are subject to the approval of the Administrator.

6.1.3 Temperature Sensor. Place a temperature sensor, capable of measuring temperature to within 1 °C (2 °F), at the outlet of the fourth impinger for monitoring purposes.

6.2 Sample Recovery. The following items are required for sample recovery:

6.2.1 Probe-Liner and Probe-Nozzle Brushes, Petri Dishes, Graduated Cylinder and/or Balance, Plastic Storage Containers, and Funnel and Rubber Policeman. Same as Method 5, Sections 6.2.1 and 6.2.4 to 6.2.8, respectively.

6.2.2 Wash Bottles. Polyethylene (2).

6.2.3 Sample Storage Containers. Chemically resistant, polyethylene or polypropylene for glassware washes, 500- or 1000-ml.

6.3 Analysis. The following items are required for analysis:

6.3.1 Spectrophotometer. Equipped with an electrodeless discharge lamp and a background corrector to measure absorbance at 193.7 nanometers (nm). For measuring samples having less than 10 µg As/ml, use a vapor generator accessory or a graphite furnace.

6.3.2 Recorder. To match the output of the spectrophotometer.

6.3.3 Beakers. 150 ml.

6.3.4 Volumetric Flasks. Glass 50-, 100-, 200-, 500-, and 1000-ml; and polypropylene, 50-ml.

- 6.3.5 Balance. To measure within 0.5 g.
- 6.3.6 Volumetric Pipets. 1-, 2-, 3-, 5-, 8-, and 10-ml.
- 6.3.7 Oven.
- 6.3.8 Hot Plate.

## 7.0 Reagents and Standards

Unless otherwise indicated, it is intended that all reagents conform to the specifications established by the Committee on Analytical Reagents of the American Chemical Society, where such specifications are available; otherwise, use the best available grade.

7.1 The following reagents are required for sample collection:

7.1.1 Filters. Same as Method 5, Section 7.1.1, except that the filters need not be unreactive to  $\text{SO}_2$ .

7.1.2 Silica Gel, Crushed Ice, and Stopcock Grease. Same as Method 5, Sections 7.1.2, 7.1.4, and 7.1.5, respectively.

7.1.3 Water. Deionized distilled to meet ASTM D 1193-77 or 91 (incorporated by reference-see §61.18), Type 3. When high concentrations of organic matter are not expected to be present, the  $\text{KMnO}_4$  test for oxidizable organic matter may be omitted.

7.2 Sample Recovery.

7.2.1 0.1 N NaOH. Dissolve 4.00 g of NaOH in about 500 ml of water in a 1-liter volumetric flask. Then, dilute to exactly 1.0 liter with water.

7.3 Analysis. The following reagents and standards are required for analysis:

7.3.1 Water. Same as Section 7.1.3.

7.3.2 Sodium Hydroxide, 0.1 N. Same as in Section 7.2.1.

7.3.3 Sodium Borohydride ( $\text{NaBH}_4$ ), 5 Percent Weight by Volume (W/V). Dissolve 50.0 g of  $\text{NaBH}_4$  in about 500 ml of 0.1 N NaOH in a 1-liter volumetric flask. Then, dilute to exactly 1.0 liter with 0.1 N NaOH.

7.3.4 Hydrochloric Acid, Concentrated.

7.3.5 Potassium Iodide (KI), 30 Percent (W/V). Dissolve 300 g of KI in 500 ml of water in a 1 liter volumetric flask. Then, dilute to exactly 1.0 liter with water.

7.3.6 Nitric Acid, Concentrated.

7.3.7 Nitric Acid, 0.8 N. Dilute 52 ml of concentrated  $\text{HNO}_3$  to exactly 1.0 liter with water.

7.3.8 Nitric Acid, 50 Percent by Volume (V/V). Add 50 ml concentrated  $\text{HNO}_3$  to 50 ml water.

7.3.9 Stock Arsenic Standard, 1 mg As/ml. Dissolve 1.3203 g of primary standard grade  $\text{As}_2\text{O}_3$  in 20 ml of 0.1 N NaOH in a 150 ml beaker. Slowly add 30 ml of concentrated  $\text{HNO}_3$ . Heat the resulting solution and evaporate just to dryness. Transfer the residue quantitatively to a 1-liter volumetric flask, and dilute to 1.0 liter with water.

7.3.10 Arsenic Working Solution, 1.0  $\mu\text{g}$  As/ml. Pipet exactly 1.0 ml of stock arsenic standard into an acid-cleaned, appropriately labeled 1-liter volumetric flask containing about 500 ml of water and 5 ml of concentrated  $\text{HNO}_3$ . Dilute to exactly 1.0 liter with water.

7.3.11 Air. Suitable quality for AAS analysis.

7.3.12 Acetylene. Suitable quality for AAS analysis.

7.3.13 Nickel Nitrate, 5 Percent Ni (W/V). Dissolve 24.780 g of nickel nitrate hexahydrate  $[\text{Ni}(\text{NO}_3)_2 \cdot 6\text{H}_2\text{O}]$  in water in a 100-ml volumetric flask, and dilute to 100 ml with water.

7.3.14 Nickel Nitrate, 1 Percent Ni (W/V). Pipet 20 ml of 5 percent nickel nitrate solution into a 100-ml volumetric flask, and dilute to exactly 100 ml with water.

7.3.15 Hydrogen Peroxide, 3 Percent by Volume. Pipet 50 ml of 30 percent  $\text{H}_2\text{O}_2$  into a 500-ml volumetric flask, and dilute to exactly 500 ml with water.

## 8.0 Sample Collection, Preservation, Transport, and Storage

8.1 Pretest Preparation. Follow the general procedure given in Method 5, Section 8.1, except the filter need not be weighed, and the 200 ml of 0.1N NaOH and Container 4 should be tared to within 0.5 g.

8.2 Preliminary Determinations. Follow the general procedure given in Method 5, Section 8.2, except select the nozzle size to maintain isokinetic sampling rates below 28 liters/min (1.0 cfm).

8.3 Preparation of Sampling Train. Follow the general procedure given in Method 5, Section 8.3.

8.4 Leak-Check Procedures. Same as Method 5, Section 8.4.

8.5 Sampling Train Operation. Follow the general procedure given in Method 5, Section 8.5, except maintain isokinetic sampling flow rates below 28 liters/min (1.0 cfm). For each run, record the data required on a data sheet similar to the one shown in Figure 108-2.

8.6 Calculation of Percent Isokinetic. Same as Method 5, Section 8.6.

8.7 Sample Recovery. Same as Method 5, Section 8.7, except that 0.1 N NaOH is used as the cleanup solvent instead of acetone and that the impinger water is treated as follows:

8.7.1 Container Number 4 (Impinger Water). Clean each of the first three impingers and connecting glassware in the following manner:

8.7.1.1 Wipe the impinger ball joints free of silicone grease, and cap the joints.

8.7.1.2 Rotate and agitate each of the first two impingers, using the impinger contents as a rinse solution.

8.7.1.3 Transfer the liquid from the first three impingers to Container Number 4. Remove the outlet ball-joint cap, and drain the contents through this opening. Do not separate the impinger parts (inner and outer tubes) while transferring their contents to the container.

8.7.1.4 Weigh the contents of Container No. 4 to within 0.5 g. Record in the log the weight of liquid along with a notation of any color or film observed in the impinger catch. The weight of liquid is needed along with the silica gel data to calculate the stack gas moisture content.

NOTE: Measure and record the total amount of 0.1 N NaOH used for rinsing under Sections 8.7.1.5 and 8.7.1.6.

8.7.1.5 Pour approximately 30 ml of 0.1 NaOH into each of the first two impingers, and agitate the impingers. Drain the 0.1 N NaOH through the outlet arm of each impinger into Container Number 4. Repeat this operation a second time; inspect the impingers for any abnormal conditions.

8.7.1.6 Wipe the ball joints of the glassware connecting the impingers and the back half of the filter holder free of silicone grease, and rinse each piece of glassware twice with 0.1 N NaOH; transfer this rinse into Container Number 4. (DO NOT RINSE or brush the glass-fritted filter support.) Mark the height of the fluid level to determine whether leakage occurs during transport. Label the container to identify clearly its contents.

## 8.8 Blanks.

8.8.1 Sodium Hydroxide. Save a portion of the 0.1 N NaOH used for cleanup as a blank. Take 200 ml of this solution directly from the wash bottle being used and place it in a plastic sample container labeled "NaOH blank."

8.8.2 Water. Save a sample of the water, and place it in a container labeled "H<sub>2</sub>O blank."

8.8.3 Filter. Save two filters from each lot of filters used in sampling. Place these filters in a container labeled "filter blank."

## 9.0 Quality Control

### 9.1 MISCELLANEOUS QUALITY CONTROL MEASURES.

| Section      | Quality control measure                        | Effect  |
|--------------|--|---|
| 8.4,<br>10.1 | Sampling equipment leak-checks and calibration | Ensures accuracy and precision of sampling measurements.      |
| 10.4         | Spectrophotometer calibration                  | Ensures linearity of spectrophotometer response to standards. |
| 11.5         | Check for matrix effects                       | Eliminates matrix effects.                                    |

9.2 Volume Metering System Checks. Same as Method 5, Section 9.2.

## 10.0 Calibration and Standardization

NOTE: Maintain a laboratory log of all calibrations.

10.1 Sampling Equipment. Same as Method 5, Section 10.0.

## 10.2 Preparation of Standard Solutions.

10.2.1 For the high level procedure, pipet 1, 3, 5, 8, and 10 ml of the 1.0 mg As/ml stock solution into separate 100 ml volumetric flasks, each containing 5 ml of concentrated HNO<sub>3</sub>. Dilute to the mark with water.

10.2.2 For the low level vapor generator procedure, pipet 1, 2, 3, and 5 ml of 1.0 µg As/ml standard solution into separate reaction tubes. Dilute to the mark with water.

10.2.3 For the low level graphite furnace procedure, pipet 1, 5, 10 and 15 ml of 1.0 µg As/ml standard solution into separate flasks along with 2 ml of the 5 percent nickel nitrate solution and 10 ml of the 3 percent H<sub>2</sub>O<sub>2</sub> solution. Dilute to the mark with water.

10.3 Calibration Curve. Analyze a 0.8 N HNO<sub>3</sub> blank and each standard solution according to the procedures outlined in section 11.4.1. Repeat this procedure on each standard solution until two consecutive peaks agree within 3 percent of their average value. Subtract the average peak height (or peak area) of the blank—which must be less than 2 percent of recorder full scale—from the averaged peak height of each standard solution. If the blank absorbance is greater than 2 percent of full-scale, the probable cause is As contamination of a reagent or carry-over of As from a previous sample. Prepare the calibration curve by plotting the corrected peak height of each standard solution versus the corresponding final total As weight in the solution.

10.4 Spectrophotometer Calibration Quality Control. Calculate the least squares slope of the calibration curve. The line must pass through the origin or through a point no further from the origin than ±2 percent of the recorder full scale. Multiply the corrected peak height by the reciprocal of the least squares slope to determine the distance each calibration point lies from the theoretical calibration line. The difference between the calculated concentration values and the actual concentrations (e.g., 1, 3, 5, 8, and 10 mg As for the high-level procedure) must be less than 7 percent for all standards.

NOTE: For instruments equipped with direct concentration readout devices, preparation of a standard curve will not be necessary. In all cases, follow calibration and operational procedures in the manufacturers' instruction manual.

## 11.0 Analytical Procedure

11.1 Sample Loss Check. Prior to analysis, check the liquid level in Containers Number 2 and Number 4. Note on the analytical data sheet whether leakage occurred during transport. If a noticeable amount of leakage occurred, either void the sample or take steps, subject to the approval of the Administrator, to adjust the final results.

### 11.2 Sample Preparation.

11.2.1 Container Number 1 (Filter). Place the filter and loose particulate matter in a 150 ml beaker. Also, add the filtered solid material from Container Number 2 (see Section 11.2.2). Add 50 ml of 0.1 N NaOH. Then stir and warm on a hot plate at low heat (do not boil) for about 15 minutes. Add 10 ml of concentrated HNO<sub>3</sub>, bring to a boil, then simmer for about 15 minutes. Filter the solution through a glass fiber filter. Wash with hot water, and catch the filtrate in a clean 150 ml beaker. Boil the filtrate, and evaporate to dryness. Cool, add 5 ml of 50 percent HNO<sub>3</sub>, and then warm and stir. Allow to cool. Transfer to a 50-ml volumetric flask, dilute to volume with water, and mix well.

### 11.2.2 Container Number 2 (Probe Wash).

11.2.2.1 Filter (using a glass fiber filter) the contents of Container Number 2 into a 200 ml volumetric flask. Combine the filtered (solid) material with the contents of Container Number 1 (Filter).

11.2.2.2 Dilute the filtrate to exactly 200 ml with water. Then pipet 50 ml into a 150 ml beaker. Add 10 ml of concentrated  $\text{HNO}_3$ , bring to a boil, and evaporate to dryness. Allow to cool, add 5 ml of 50 percent  $\text{HNO}_3$ , and then warm and stir. Allow the solution to cool, transfer to a 50-ml volumetric flask, dilute to volume with water, and mix well.

11.2.3 Container Number 4 (Impinger Solution). Transfer the contents of Container Number 4 to a 500 ml volumetric flask, and dilute to exactly 500-ml with water. Pipet 50 ml of the solution into a 150-ml beaker. Add 10 ml of concentrated  $\text{HNO}_3$ , bring to a boil, and evaporate to dryness. Allow to cool, add 5 ml of 50 percent  $\text{HNO}_3$ , and then warm and stir. Allow the solution to cool, transfer to a 50-ml volumetric flask, dilute to volume with water, and mix well.

11.2.4 Filter Blank. Cut each filter into strips, and treat each filter individually as directed in Section 11.2.1, beginning with the sentence, "Add 50 ml of 0.1 N NaOH."

11.2.5 Sodium Hydroxide and Water Blanks. Treat separately 50 ml of 0.1 N NaOH and 50 ml water, as directed under Section 11.2.3, beginning with the sentence, "Pipet 50 ml of the solution into a 150-ml beaker."

11.3 Spectrophotometer Preparation. Turn on the power; set the wavelength, slit width, and lamp current. Adjust the background corrector as instructed by the manufacturer's manual for the particular atomic absorption spectrophotometer. Adjust the burner and flame characteristics as necessary.

11.4 Analysis. Calibrate the analytical equipment and develop a calibration curve as outlined in Sections 10.2 through 10.4.

11.4.1 Arsenic Samples. Analyze an appropriately sized aliquot of each diluted sample (from Sections 11.2.1 through 11.2.3) until two consecutive peak heights agree within 3 percent of their average value. If applicable, follow the procedures outlined in Section 11.4.1.1. If the sample concentration falls outside the range of the calibration curve, make an appropriate dilution with 0.8 N  $\text{HNO}_3$  so that the final concentration falls within the range of the curve. Using the calibration curve, determine the arsenic concentration in each sample fraction.

NOTE: Because instruments vary between manufacturers, no detailed operating instructions will be given here. Instead, the instrument manufacturer's detailed operating instructions should be followed.

11.4.1.1 Arsenic Determination at Low Concentration. The lower limit of flame AAS is 10  $\mu\text{g As/ml}$ . If the arsenic concentration of any sample is at a lower level, use the graphite furnace or vapor generator which is available as an accessory component. Flame, graphite furnace, or vapor generators may be used for samples whose concentrations are between 10 and 30  $\mu\text{g/ml}$ . Follow the manufacturer's instructions in the use of such equipment.

11.4.1.1.1 Vapor Generator Procedure. Place a sample containing between 0 and 5  $\mu\text{g}$  of arsenic in the reaction tube, and dilute to 15 ml with water. Since there is some trial and error involved in this procedure, it may be necessary to screen the samples by conventional atomic absorption until an approximate concentration is determined. After determining the approximate concentration, adjust the volume of the sample accordingly. Pipet 15 ml of concentrated HCl into each tube. Add 1 ml of 30 percent KI solution. Place the reaction tube into a 50 °C (120 °F) water bath for 5 minutes. Cool to room temperature. Connect the reaction tube to the vapor generator assembly. When the instrument response has returned to baseline, inject 5.0 ml of 5 percent  $\text{NaBH}_4$ , and integrate the resulting spectrophotometer signal over a 30-second time period.

11.4.1.1.2 Graphite Furnace Procedure. Dilute the digested sample so that a 5 ml aliquot contains less than 1.5  $\mu\text{g}$  of arsenic. Pipet 5 ml of this digested solution into a 10-ml volumetric flask. Add 1 ml of



the 1 percent nickel nitrate solution, 0.5 ml of 50 percent HNO<sub>3</sub>, and 1 ml of the 3 percent hydrogen peroxide and dilute to 10 ml with water. The sample is now ready for analysis.

11.4.1.2 Run a blank (0.8 N HNO<sub>3</sub>) and standard at least after every five samples to check the spectrophotometer calibration. The peak height of the blank must pass through a point no further from the origin than  $\pm 2$  percent of the recorder full scale. The difference between the measured concentration of the standard (the product of the corrected average peak height and the reciprocal of the least squares slope) and the actual concentration of the standard must be less than 7 percent, or recalibration of the analyzer is required.

11.4.1.3 Determine the arsenic concentration in the filter blank (i.e., the average of the two blank values from each lot).

11.4.2 Container Number 3 (Silica Gel). This step may be conducted in the field. Weigh the spent silica gel (or silica gel plus impinger) to the nearest 0.5 g; record this weight.

11.5 Check for matrix effects on the arsenic results. Same as Method 12, Section 11.5.

## 12.0 Data Analysis and Calculations

### 12.1 NOMENCLATURE

$B_{ws}$  = Water in the gas stream, proportion by volume.

$C_a$  = Concentration of arsenic as read from the standard curve,  $\mu\text{g/ml}$ .

$C_s$  = Arsenic concentration in stack gas, dry basis, converted to standard conditions,  $\text{g/dsm}^3$  ( $\text{gr/dscf}$ ).

$E_a$  = Arsenic mass emission rate,  $\text{g/hr}$  ( $\text{lb/hr}$ ).

$F_d$  = Dilution factor (equals 1 if the sample has not been diluted).

$I$  = Percent of isokinetic sampling.

$m_{bi}$  = Total mass of all four impingers and contents before sampling,  $\text{g}$ .

$m_{fi}$  = Total mass of all four impingers and contents after sampling,  $\text{g}$ .

$m_n$  = Total mass of arsenic collected in a specific part of the sampling train,  $\mu\text{g}$ .

$m_t$  = Total mass of arsenic collected in the sampling train,  $\mu\text{g}$ .

$T_m$  = Absolute average dry gas meter temperature (see Figure 108-2),  $^{\circ}\text{K}$  ( $^{\circ}\text{R}$ ).

$V_m$  = Volume of gas sample as measured by the dry gas meter, dry basis,  $\text{m}^3$  ( $\text{ft}^3$ ).

$V_{m(\text{std})}$  = Volume of gas sample as measured by the dry gas meter, corrected to standard conditions,  $\text{m}^3$  ( $\text{ft}^3$ ).

$V_n$  = Volume of solution in which the arsenic is contained,  $\text{ml}$ .

$V_{w(\text{std})}$  = Volume of water vapor collected in the sampling train, corrected to standard conditions,  $\text{m}^3$  ( $\text{ft}^3$ ).

$\Delta H$  = Average pressure differential across the orifice meter (see Figure 108-2),  $\text{mm H}_2\text{O}$  ( $\text{in. H}_2\text{O}$ ).

12.2 Average Dry Gas Meter Temperatures ( $T_m$ ) and Average Orifice Pressure Drop ( $\Delta H$ ). See data sheet (Figure 108-2).

12.3 Dry Gas Volume. Using data from this test, calculate  $V_{m(\text{std})}$  according to the procedures outlined in Method 5, Section 12.3.

12.4 Volume of Water Vapor.

$$V_{w(\text{std})} = K_2(m_{\text{H}_2\text{O}} - m_{\text{H}_2\text{O}}) \quad \text{Eq. 108-1}$$

Where:

$K_2 = 0.001334 \text{ m}^3/\text{g}$  for metric units.

$= 0.047012 \text{ ft}^3/\text{g}$  for English units.

12.5 Moisture Content.

$$B_{\text{WS}} = \frac{V_{w(\text{std})}}{V_{m(\text{std})} + V_{w(\text{std})}} \quad \text{Eq. 108-2}$$

12.6 Amount of Arsenic Collected.

12.6.1 Calculate the amount of arsenic collected in each part of the sampling train, as follows:

$$m_n = C_s F_d V_n \quad \text{Eq. 108-3}$$

12.6.2 Calculate the total amount of arsenic collected in the sampling train as follows:

$$m_t = m_{(\text{filters})} + m_{(\text{probe})} + m_{(\text{impingers})} - m_{(\text{filter blank})} - m_{(\text{NaOH blank})} - m_{(\text{water blank})} \quad \text{Eq. 108-4}$$

12.7 Calculate the arsenic concentration in the stack gas (dry basis, adjusted to standard conditions) as follows:

$$C_s = K_3(m_t / V_{m(\text{std})}) \quad \text{Eq. 108-5}$$

Where:

$K_3 = 10^{-6} \text{ g}/\mu\text{g}$  for metric units

$= 1.54 \times 10^{-5} \text{ gr}/\mu\text{g}$  for English units

12.8 Stack Gas Velocity and Volumetric Flow Rate. Calculate the average stack gas velocity and volumetric flow rate using data obtained in this method and the equations in Sections 12.2 and 12.3 of Method 2.

12.9 Pollutant Mass Rate. Calculate the arsenic mass emission rate as follows:

$$E_s = C_s Q_{\text{std}} \quad \text{Eq. 108-6}$$

12.10 Isokinetic Variation. Same as Method 5, Section 12.11.

### 13.0 Method Performance

13.1 Sensitivity. The lower limit of flame AAS 10 µg As/ml. The analytical procedure includes provisions for the use of a graphite furnace or vapor generator for samples with a lower arsenic concentration.

*14.0 Pollution Prevention. [Reserved]*

*15.0 Waste Management. [Reserved]*

*16.0 Alternative Procedures*

16.1 Inductively coupled plasma-atomic emission spectrometry (ICP-AES) Analysis. ICP-AES may be used as an alternative to atomic absorption analysis provided the following conditions are met:

16.1.1 Sample collection, sample preparation, and analytical preparation procedures are as defined in the method except as necessary for the ICP-AES application.

16.1.2 Quality Assurance/Quality Control procedures, including audit material analysis, are conducted as prescribed in the method. The QA acceptance conditions must be met.

16.1.3 The limit of quantitation for the ICP-AES must be demonstrated and the sample concentrations reported should be no less than two times the limit of quantitation. The limit of quantitation is defined as ten times the standard deviation of the blank value. The standard deviation of the blank value is determined from the analysis of seven blanks. It has been reported that for mercury and those elements that form hydrides, a continuous-flow generator coupled to an ICP-AES offers detection limits comparable to cold vapor atomic absorption.

16.2 Inductively Coupled Plasma-Mass Spectrometry (ICP-MS) Analysis. ICP-MS may be used as an alternative to atomic absorption analysis.

16.3 Cold Vapor Atomic Fluorescence Spectrometry (CVAFS) Analysis. CVAFS may be used as an alternative to atomic absorption analysis.

*17.0 References.*

Same as References 1 through 9 of Method 5, Section 17.0, with the addition of the following:

1. Perkin Elmer Corporation. Analytical Methods for Atomic Absorption Spectrophotometry. 303-0152. Norwalk, Connecticut. September 1976. pp. 5-6.

2. Standard Specification for Reagent Water. In: Annual Book of American Society for Testing and Materials Standards. Part 31: Water, Atmospheric Analysis. American Society for Testing and Materials. Philadelphia, PA. 1974. pp. 40-42.

3. Stack Sampling Safety Manual (Draft). U.S. Environmental Protection Agency, Office of Air Quality Planning and Standard, Research Triangle Park, NC. September 1978.

*18.0 Tables, Diagrams, Flowcharts, and Validation Data*

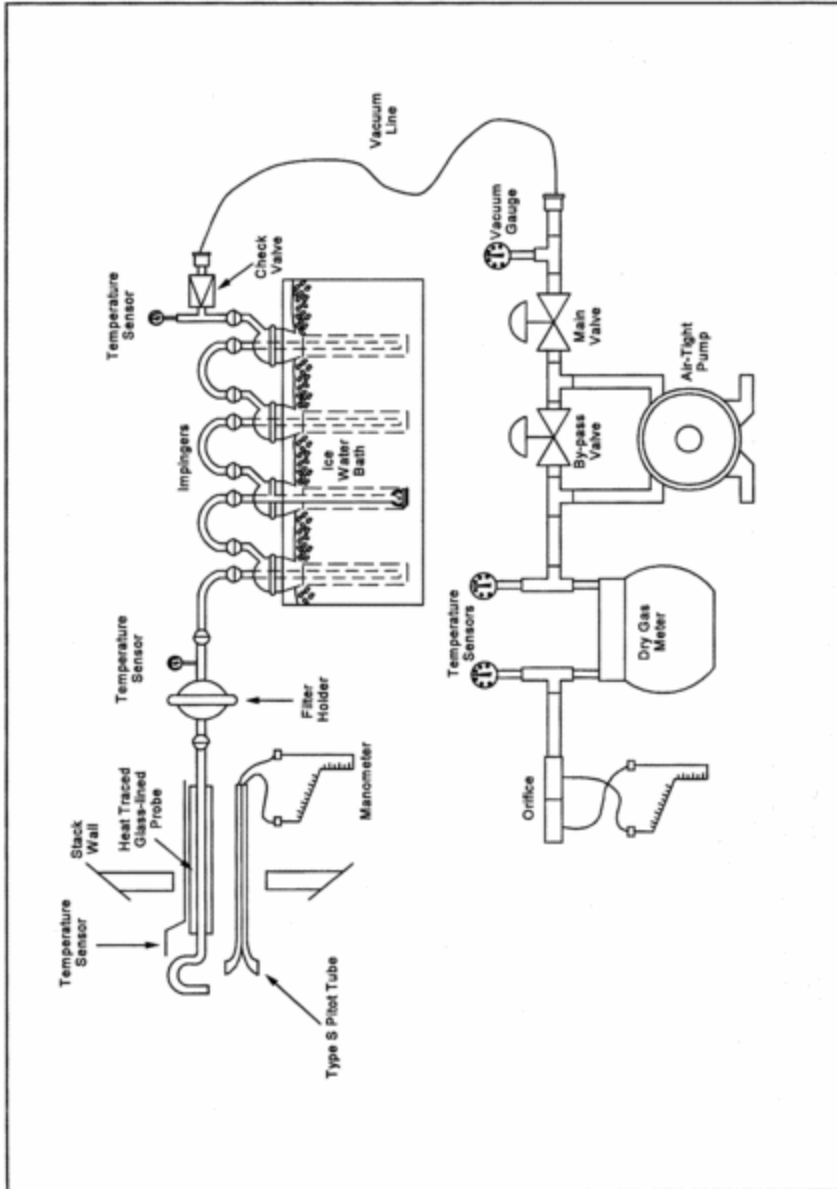

Figure 108-1. Arsenic Sampling Train



|                                   |           |                               |
|-----------------------------------|-----------|-------------------------------|
| Arsenic compounds as arsenic (As) | 7440-38-2 | Lower limit 10 µg/ml or less. |
|-----------------------------------|-----------|-------------------------------|

1.2 Applicability. This method applies to the determination of inorganic As content of process ore and reverberatory matte samples from nonferrous smelters and other sources as specified in an applicable subpart of the regulations.

1.3 Data Quality Objectives. Adherence to the requirements of this method will enhance the quality of the data obtained from air pollutant sampling methods.

## 2.0 Summary of Method

Arsenic bound in ore samples is liberated by acid digestion and analyzed by flame atomic absorption spectrophotometry (AAS).

## 3.0 Definitions [Reserved]

## 4.0 Interferences

Analysis for As by flame AAS is sensitive to the chemical composition and to the physical properties (e.g., viscosity, pH) of the sample. The analytical procedure includes a check for matrix effects (section 11.5).

## 5.0 Safety

5.1 Disclaimer. This method may involve hazardous materials, operations, and equipment. This test method may not address all of the safety problems associated with its use. It is the responsibility of the user to establish appropriate safety and health practices and determine the applicability of regulatory limitations prior to performing this test method.

5.2 Corrosive Reagents. The following reagents are hazardous. Personal protective equipment and safe procedures that prevent chemical splashes are recommended. If contact occurs, immediately flush with copious amounts of water for at least 15 minutes. Remove clothing under shower and decontaminate. Treat residual chemical burns as thermal burns.

5.2.1 Hydrochloric Acid (HCl). Highly corrosive liquid with toxic vapors. Vapors are highly irritating to eyes, skin, nose, and lungs, causing severe damage. May cause bronchitis, pneumonia, or edema of lungs. Exposure to concentrations of 0.13 to 0.2 percent can be lethal to humans in a few minutes. Provide ventilation to limit exposure. Reacts with metals, producing hydrogen gas.

5.2.2 Hydrofluoric Acid (HF). Highly corrosive to eyes, skin, nose, throat, and lungs. Reaction to exposure may be delayed by 24 hours or more. Provide ventilation to limit exposure.

5.2.3 Hydrogen Peroxide (H<sub>2</sub>O<sub>2</sub>). Very harmful to eyes. 30% H<sub>2</sub>O<sub>2</sub> can burn skin, nose, and lungs.

5.2.4 Nitric Acid (HNO<sub>3</sub>). Highly corrosive to eyes, skin, nose, and lungs. Vapors are highly toxic and can cause bronchitis, pneumonia, or edema of lungs. Reaction to inhalation may be delayed as long as 30 hours and still be fatal. Provide ventilation to limit exposure. Strong oxidizer. Hazardous reaction may occur with organic materials such as solvents.

5.2.5 Sodium Hydroxide (NaOH). Causes severe damage to eyes and skin. Inhalation causes irritation to nose, throat, and lungs. Reacts exothermically with limited amounts of water.

## 6.0 *Equipment and Supplies*

6.1 Sample Collection and Preparation. The following items are required for sample collection and preparation:

- 6.1.1 Parr Acid Digestion Bomb. Stainless steel with vapor-tight Teflon cup and cover.
- 6.1.2 Volumetric Pipets. 2- and 5-ml sizes.
- 6.1.3 Volumetric Flask. 50-ml polypropylene with screw caps, (one needed per standard).
- 6.1.4 Funnel. Polyethylene or polypropylene.
- 6.1.5 Oven. Capable of maintaining a temperature of approximately 105 °C (221 °F).
- 6.1.6 Analytical Balance. To measure to within 0.1 mg.

6.2 Analysis. The following items are required for analysis:

6.2.1 Spectrophotometer and Recorder. Equipped with an electrodeless discharge lamp and a background corrector to measure absorbance at 193.7 nm. For measuring samples having less than 10 µg As/ml, use a graphite furnace or vapor generator accessory. The recorder shall match the output of the spectrophotometer.

6.2.2 Volumetric Flasks. Class A, 50-ml (one needed per sample and blank), 500-ml, and 1-liter.

6.2.3 Volumetric Pipets. Class A, 1-, 5-, 10-, and 25-ml sizes.

## 7.0 *Reagents and Standards.*

Unless otherwise indicated, it is intended that all reagents conform to the specifications established by the Committee on Analytical Reagents of the American Chemical Society, where such specifications are available; otherwise, use the best available grade.

7.1 Sample Collection and Preparation. The following reagents are required for sample collection and preparation:

7.1.1 Water. Deionized distilled to meet ASTM D 1193-77 or 91 Type 3 (incorporated by reference—See §61.18). When high concentrations of organic matter are not expected to be present, the  $\text{KMnO}_4$  test for oxidizable organic matter may be omitted. Use in all dilutions requiring water.

7.1.2 Nitric Acid Concentrated.

7.1.3 Nitric Acid, 0.5 N. In a 1-liter volumetric flask containing water, add 32 ml of concentrated  $\text{HNO}_3$  and dilute to volume with water.

7.1.4 Hydrofluoric Acid, Concentrated.

7.1.5 Potassium Chloride (KCl) Solution, 10 percent weight by volume (W/V). Dissolve 10 g KCl in water, add 3 ml concentrated  $\text{HNO}_3$ , and dilute to 100 ml.

7.1.6 Filter. Teflon filters, 3-micron porosity, 47-mm size. (Available from Millipore Co., type FS, Catalog Number FSLW04700.)

7.1.7 Sodium Borohydride ( $\text{NaBH}_4$ ), 5 Percent (W/V). Dissolve 50.0 g of  $\text{NaBH}_4$  in about 500 ml of 0.1 N NaOH in a 1-liter volumetric flask. Then, dilute to exactly 1.0 liter with 0.1 N NaOH.

7.1.8 Nickel Nitrate, 5 Percent Ni (W/V). Dissolve 24.780 g of nickel nitrate hexahydrate [ $\text{Ni}(\text{NO}_3)_2 \cdot 6\text{H}_2\text{O}$ ] in water in a 100-ml volumetric flask, and dilute to 100 ml with water.

7.1.9 Nickel Nitrate, 1 Percent Ni (W/V). Pipet 20 ml of 5 percent nickel nitrate solution into a 100-ml volumetric flask, and dilute to 100 ml with water.

7.2 Analysis. The following reagents and standards are required for analysis:

7.2.2 Sodium Hydroxide, 0.1 N. Dissolve 2.00 g of NaOH in water in a 500-ml volumetric flask. Dilute to volume with water.

7.2.3 Nitric Acid, 0.5 N. Same as in Section 7.1.3.

7.2.4 Potassium Chloride Solution, 10 percent. Same as in Section 7.1.5.

7.2.5 Hydrochloric Acid, Concentrated.

7.2.6 Potassium Iodide (KI), 30 Percent (W/V). Dissolve 300 g of KI in about 500 ml of water in a 1-liter volumetric flask. Then, dilute to exactly 1.0 liter with water.

7.2.7 Hydrogen Peroxide, 3 Percent by Volume. Pipet 50 ml of 30 percent  $\text{H}_2\text{O}_2$  into a 500-ml volumetric flask, and dilute to exactly 500 ml with water.

7.2.8 Stock Arsenic Standard, 1 mg As/ml. Dissolve 1.3203 g of primary grade  $\text{As}_2\text{O}_3$  in 20 ml of 0.1 N NaOH. Slowly add 30 ml of concentrated  $\text{HNO}_3$ , and heat in an oven at 105 °C (221 °F) for 2 hours. Allow to cool, and dilute to 1 liter with deionized distilled water.

7.2.9 Nitrous Oxide. Suitable quality for AAS analysis.

7.2.10 Acetylene. Suitable quality for AAS analysis.

7.2.11 Quality Assurance Audit Samples. When making compliance determinations, and upon availability, audit samples may be obtained from the appropriate EPA regional Office or from the responsible enforcement authority.

NOTE: The responsible enforcement authority should be notified at least 30 days prior to the test date to allow sufficient time for sample delivery.

## 8.0 *Sample Collection, Preservation, Transport, and Storage*

8.1 Sample Collection. A sample that is representative of the ore lot to be tested must be taken prior to analysis. (A portion of the samples routinely collected for metals analysis may be used provided the sample is representative of the ore being tested.)

8.2 Sample Preparation. The sample must be ground into a finely pulverized state.



## 9.0 QUALITY CONTROL

| Section | Quality control measure       | Effect   |
|---------|-------------------------------|--|
| 10.2    | Spectrophotometer calibration | Ensure linearity of spectrophotometer response to standards. |
| 11.5    | Check for matrix effects      | Eliminate matrix effects.                                    |

### 10.0 Calibration and Standardizations

NOTE: Maintain a laboratory log of all calibrations.

10.1 Preparation of Standard Solutions. Pipet 1, 5, 10, and 25 ml of the stock As solution into separate 100-ml volumetric flasks. Add 10 ml KCl solution and dilute to the mark with 0.5 N HNO<sub>3</sub>. This will give standard concentrations of 10, 50, 100, and 250 µg As/ml. For low-level arsenic samples that require the use of a graphite furnace or vapor generator, follow the procedures in Section 11.3:1. Dilute 10 ml of KCl solution to 100 ml with 0.5 N HNO<sub>3</sub> and use as a reagent blank.

10.2 Calibration Curve. Analyze the reagent blank and each standard solution according to the procedures outlined in Section 11.3. Repeat this procedure on each standard solution until two consecutive peaks agree within 3 percent of their average value. Subtract the average peak height (or peak area) of the blank—which must be less than 2 percent of recorder full scale—from the averaged peak heights of each standard solution. If the blank absorbance is greater than 2 percent of full-scale, the probable cause is Hg contamination of a reagent or carry-over of As from a previous sample. Prepare the calibration curve by plotting the corrected peak height of each standard solution versus the corresponding final total As weight in the solution.

10.3 Spectrophotometer Calibration Quality Control. Calculate the least squares slope of the calibration curve. The line must pass through the origin or through a point no further from the origin than ±2 percent of the recorder full scale. Multiply the corrected peak height by the reciprocal of the least squares slope to determine the distance each calibration point lies from the theoretical calibration line. The difference between the calculated concentration values and the actual concentrations must be less than 7 percent for all standards.

NOTE: For instruments equipped with direct concentration readout devices, preparation of a standard curve will not be necessary. In all cases, follow calibration and operational procedures in the manufacturer's instruction manual.

### 11.0 Analytical Procedure

11.1 Sample Preparation. Weigh 50 to 500 mg of finely pulverized sample to the nearest 0.1 mg. Transfer the sample into the Teflon cup of the digestion bomb, and add 2 ml each of concentrated HNO<sub>3</sub> and HF. Seal the bomb immediately to prevent the loss of any volatile arsenic compounds that may form. Heat in an oven at 105 °C (221 °F) for 2 hours. Remove the bomb from the oven and allow to cool. Using a Teflon filter, quantitatively filter the digested sample into a 50-ml polypropylene volumetric flask. Rinse the bomb three times with small portions of 0.5 N HNO<sub>3</sub>, and filter the rinses into the flask. Add 5 ml of KCl solution to the flask, and dilute to 50 ml with 0.5 N HNO<sub>3</sub>.

11.2 Spectrophotometer Preparation.

11.2.1 Turn on the power; set the wavelength, slit width, and lamp current. Adjust the background corrector as instructed by the manufacturer's manual for the particular atomic absorption spectrophotometer. Adjust the burner and flame characteristics as necessary.

11.2.2 Develop a spectrophotometer calibration curve as outlined in Sections 10.2 and 10.3.

11.3 Arsenic Determination. Analyze an appropriately sized aliquot of each diluted sample (from Section 11.1) until two consecutive peak heights agree within 3 percent of their average value. If applicable, follow the procedures outlined in Section 11.3.1. If the sample concentration falls outside the range of the calibration curve, make an appropriate dilution with 0.5 N HNO<sub>3</sub> so that the final concentration falls within the range of the curve. Using the calibration curve, determine the As concentration in each sample.

NOTE: Because instruments vary between manufacturers, no detailed operating instructions will be given here. Instead, the instrument manufacturer's detailed operating instructions should be followed.

11.3.1 Arsenic Determination at Low Concentration. The lower limit of flame AAS is 10 µg As/ml. If the arsenic concentration of any sample is at a lower level, use the vapor generator or graphite furnace which is available as an accessory component. Flame, graphite furnace, or vapor generators may be used for samples whose concentrations are between 10 and 30 µg/ml. Follow the manufacturer's instructions in the use of such equipment.

11.3.1.1 Vapor Generator Procedure. Place a sample containing between 0 and 5 µg of arsenic in the reaction tube, and dilute to 15 ml with water. Since there is some trial and error involved in this procedure, it may be necessary to screen the samples by conventional AAS until an approximate concentration is determined. After determining the approximate concentration, adjust the volume of the sample accordingly. Pipet 15 ml of concentrated HCl into each tube. Add 1 ml of 30 percent KI solution. Place the reaction tube into a 50 °C (120 °F) water bath for 5 minutes. Cool to room temperature. Connect the reaction tube to the vapor generator assembly. When the instrument response has returned to baseline, inject 5.0 ml of 5 percent NaBH<sub>4</sub> and integrate the resulting spectrophotometer signal over a 30-second time period.

11.3.1.2 Graphite Furnace Procedure. Pipet 5 ml of the digested solution into a 10-ml volumetric flask. Add 1 ml of the 1 percent nickel nitrate solution, 0.5 ml of 50 percent HNO<sub>3</sub>, and 1 ml of the 3 percent H<sub>2</sub>O<sub>2</sub>, and dilute to 10 ml with water. The sample is now ready to inject in the furnace for analysis.

11.4 Run a blank and standard at least after every five samples to check the spectrophotometer calibration. The peak height of the blank must pass through a point no further from the origin than ±2 percent of the recorder full scale. The difference between the measured concentration of the standard (the product of the corrected average peak height and the reciprocal of the least squares slope) and the actual concentration of the standard must be less than 7 percent, or recalibration of the analyzer is required.

11.5 Mandatory Check for Matrix Effects on the Arsenic Results. Same as Method 12, Section 11.5.

## 12.0 Data Analysis and Calculations

12.1 Calculate the percent arsenic in the ore sample as follows:

$$\% \text{ As} = \frac{5C_a F_d}{W} \quad \text{Eq. 108A-1}$$

Where:

C<sub>a</sub> = Concentration of As as read from the standard curve, µg/ml.

F<sub>d</sub> = Dilution factor (equals to 1 if the sample has not been diluted).

W = Weight of ore sample analyzed, mg.

5 = (50 ml sample " 100)/(10<sup>3</sup> µg/mg).

### 13.0 Method Performance

13.1 Sensitivity. The lower limit of flame AAS is 10 µg As/ml. The analytical procedure includes provisions for the use of a graphite furnace or vapor generator for samples with a lower arsenic concentration.

### 14.0 Pollution Prevention. [Reserved]

### 15.0 Waste Management. [Reserved]

### 16.0 Alternative Procedures

16.1 Alternative Analyzer. Inductively coupled plasma-atomic emission spectrometry (ICP-AES) may be used as an alternative to atomic absorption analysis provided the following conditions are met:

16.1.1 Sample collection, sample preparation, and analytical preparation procedures are as defined in the method except as necessary for the ICP-AES application.

16.1.2 Quality Assurance/Quality Control procedures, including audit material analysis, are conducted as prescribed in the method. The QA acceptance conditions must be met.

16.1.3 The limit of quantitation for the ICP-AES must be demonstrated and the sample concentrations reported should be no less than two times the limit of quantitation. The limit of quantitation is defined as ten times the standard deviation of the blank value. The standard deviation of the blank value is determined from the analysis of seven blanks. It has been reported that for mercury and those elements that form hydrides, a continuous-flow generator coupled to an ICP-AES offers detection limits comparable to cold vapor atomic absorption.

### 17.0 References

Same as References 1 through 9 of Section 17.0 of Method 5, with the addition of the following:

1. Perkin Elmer Corporation. Analytical Methods of Atomic Absorption Spectrophotometry. 303-0152. Norwalk, Connecticut. September 1976. pp 5-6.

2. Ringwald, D. Arsenic Determination on Process Materials from ASARCO's Copper Smelter in Tacoma, Washington. Unpublished Report. Prepared for Emission Measurement Branch, Emission Standards and Engineering Division, U.S. Environmental Protection Agency, Research Triangle Park, North Carolina. August 1980. 35 pp.

3. Stack Sampling Safety Manual (Draft). U.S. Environmental Protection Agency, Office of Air Quality Planning and Standard, Research Triangle Park, NC. September 1978.

### 18.0 Tables, Diagrams, Flowcharts, and Validation Data. [Reserved]

## METHOD 108B—DETERMINATION OF ARSENIC CONTENT IN ORE SAMPLES FROM NONFERROUS SMELTERS

NOTE: This method does not include all of the specifications (e.g., equipment and supplies) and procedures (e.g., sampling and analytical) essential to its performance. Some material is incorporated by reference from other methods in this appendix and in appendix A to 40 CFR part 60. Therefore, to obtain reliable results, persons using

this method should have a thorough knowledge of at least the following additional test methods: Method 12 and Method 108A.

### 1.0 Scope and Application

#### 1.1 Analytes.

| Analyte                           | CAS No.   | Sensitivity           |
|-----------------------------------|-----------|-----------------------|
| Arsenic compounds as arsenic (As) | 7440-38-2 | Lower limit 10 µg/ml. |

1.2 Applicability. This method applies to the determination of inorganic As content of process ore and reverberatory matte samples from nonferrous smelters and other sources as specified in an applicable subpart of the regulations. Samples resulting in an analytical concentration greater than 10 µg As/ml may be analyzed by this method. For lower level arsenic samples, Method 108C should be used.

1.3 Data Quality Objectives. Adherence to the requirements of this method will enhance the quality of the data obtained from air pollutant sampling methods.

### 2.0 Summary of Method

Arsenic bound in ore samples is liberated by acid digestion and analyzed by flame atomic absorption spectrophotometry (AAS).

### 3.0 Definitions [Reserved]

### 4.0 Interferences

Analysis for As by flame AAS is sensitive to the chemical composition and to the physical properties (e.g., viscosity, pH) of the sample. The analytical procedure includes a check for matrix effects (Section 11.4).

### 5.0 Safety

5.1 Disclaimer. This method may involve hazardous materials, operations, and equipment. This test method may not address all of the safety problems associated with its use. It is the responsibility of the user to establish appropriate safety and health practices and determine the applicability of regulatory limitations prior to performing this test method.

5.2 Corrosive Reagents. The following reagents are hazardous. Personal protective equipment and safe procedures that prevent chemical splashes are recommended. If contact occurs, immediately flush with copious amounts of water for at least 15 minutes. Remove clothing under shower and decontaminate. Treat residual chemical burns as thermal burns.

5.2.1 Hydrochloric acid (HCl). Highly corrosive liquid with toxic vapors. Vapors are highly irritating to eyes, skin, nose, and lungs, causing severe damage. May cause bronchitis, pneumonia, or edema of lungs. Exposure to concentrations of 0.13 to 0.2 percent can be lethal to humans in a few minutes. Provide ventilation to limit exposure. Reacts with metals, producing hydrogen gas.

5.2.2 Hydrofluoric Acid (HF). Highly corrosive to eyes, skin, nose, throat, and lungs. Reaction to exposure may be delayed by 24 hours or more. Provide ventilation to limit exposure.

5.2.3 Nitric Acid ( $\text{HNO}_3$ ). Highly corrosive to eyes, skin, nose, and lungs. Vapors are highly toxic and can cause bronchitis, pneumonia, or edema of lungs. Reaction to inhalation may be delayed as long as 30 hours and still be fatal. Provide ventilation to limit exposure. Strong oxidizer. Hazardous reaction may occur with organic materials such as solvents.

5.2.4 Perchloric Acid ( $\text{HClO}_4$ ). Corrosive to eyes, skin, nose, and throat. Provide ventilation to limit exposure. Very strong oxidizer. Keep separate from water and oxidizable materials to prevent vigorous evolution of heat, spontaneous combustion, or explosion. Heat solutions containing  $\text{HClO}_4$  only in hoods specifically designed for  $\text{HClO}_4$ .

## 6.0 *Equipment and Supplies*

6.1 Sample Preparation. The following items are required for sample preparation:

6.1.1 Teflon Beakers. 150-ml.

6.1.2 Graduated Pipets. 5-ml disposable.

6.1.3 Graduated Cylinder. 50-ml.

6.1.4 Volumetric Flask. 100-ml.

6.1.5 Analytical Balance. To measure within 0.1 mg.

6.1.6 Hot Plate.

6.1.7 Perchloric Acid Fume Hood.

6.2 Analysis. The following items are required for analysis:

6.2.1 Spectrophotometer. Equipped with an electrodeless discharge lamp and a background corrector to measure absorbance at 193.7 nm.

6.2.2 Beaker and Watch Glass. 400-ml.

6.2.3 Volumetric Flask. 1-liter.

6.2.4 Volumetric Pipets. 1-, 5-, 10-, and 25-ml.

## 7.0 *Reagents and Standards*

Unless otherwise indicated, it is intended that all reagents conform to the specifications established by the Committee on Analytical Reagents of the American Chemical Society, where such specifications are available; otherwise, use the best available grade.

7.1 Sample Preparation. The following reagents are required for sample preparation:

7.1.1 Water. Deionized distilled to meet ASTM D 1193-77 or 91 Type 3 (incorporated by reference—see §61.18).

7.1.2 Nitric Acid, Concentrated.

7.1.3 Hydrofluoric Acid, Concentrated.

7.1.4 Perchloric Acid, 70 Percent.

7.1.5 Hydrochloric Acid, Concentrated.

7.2 Analysis. The following reagents and standards are required for analysis:

7.2.1 Water. Same as in Section 7.1.1.

7.2.2 Stock Arsenic Standard, 1.0 mg As/ml. Dissolve 1.3203 g of primary grade  $As_2O_3$  [dried at 105 °C (221 °F)] in a 400-ml beaker with 10 ml of  $HNO_3$  and 5 ml of HCl. Cover with a watch glass, and heat gently until dissolution is complete. Add 10 ml of  $HNO_3$  and 25 ml of  $HClO_4$ , evaporate to strong fumes of  $HClO_4$ , and reduce to about 20 ml volume. Cool, add 100 ml of water and 100 ml of HCl, and transfer quantitatively to a 1-liter volumetric flask. Dilute to volume with water and mix.

7.2.3 Acetylene. Suitable quality for AAS analysis.

7.2.4 Air. Suitable quality for AAS analysis.

### 8.0 Sample Collection, Preservation, Transport, and Storage

Same as in Method 108A, Sections 8.1 and 8.2.

### 9.0 QUALITY CONTROL

| Section | Quality control measure       | Effect   |
|---------|-------------------------------|--|
| 10.2    | Spectrophotometer calibration | Ensure linearity of spectrophotometer response to standards. |
| 11.4    | Check for matrix effects      | Eliminate matrix effects.                                    |

### 10.0 Calibration and Standardization

NOTE: Maintain a laboratory log of all calibrations.

10.1 Preparation of Standard Solutions. Pipet 1, 5, 10, and 25 ml of the stock As solution into separate 100-ml volumetric flasks. Add 2 ml of  $HClO_4$ , 10 ml of HCl, and dilute to the mark with water. This will provide standard concentrations of 10, 50, 100, and 250  $\mu g$  As/ml.

10.2 Calibration Curve and Spectrophotometer Calibration Quality Control. Same as Method 108A, Sections 10.2 and 10.3

### 11.0 Analytical Procedure

11.1 Sample Preparation. Weigh 100 to 1000 mg of finely pulverized sample to the nearest 0.1 mg. Transfer the sample to a 150-ml Teflon beaker. Dissolve the sample by adding 15 ml of  $HNO_3$ , 10 ml of HCl, 10 ml of HF, and 10 ml of  $HClO_4$  in the exact order as described, and let stand for 10 minutes. In a  $HClO_4$  fume hood, heat on a hot plate until 2-3 ml of  $HClO_4$  remain, then cool. Add 20 ml of water and 10 ml of HCl. Cover and warm until the soluble salts are in solution. Cool, and transfer quantitatively to a 100-ml volumetric flask. Dilute to the mark with water.

11.2 Spectrophotometer Preparation. Same as in Method 108A, Section 11.2.

11.3 Arsenic Determination. If the sample concentration falls outside the range of the calibration curve, make an appropriate dilution with 2 percent HClO<sub>4</sub>/10 percent HCl (prepared by diluting 2 ml concentrated HClO<sub>4</sub> and 10 ml concentrated HCl to 100 ml with water) so that the final concentration falls within the range of the curve. Using the calibration curve, determine the As concentration in each sample.

NOTE: Because instruments vary between manufacturers, no detailed operating instructions will be given here. Instead, the instrument manufacturer's detailed operating instructions should be followed.

Run a blank and standard at least after every five samples to check the spectrophotometer calibration. The peak height of the blank must pass through a point no further from the origin than ±2 percent of the recorder full scale. The difference between the measured concentration of the standard (the product of the corrected average peak height and the reciprocal of the least squares slope) and the actual concentration of the standard must be less than 7 percent, or recalibration of the analyzer is required.

11.4 Mandatory Check for Matrix Effects on the Arsenic Results. Same as Method 12, Section 11.5.

#### 12.0 Data Analysis and Calculations

Same as in Method 108A, Section 12.0.

#### 13.0 Method Performance

13.1 Sensitivity. The lower limit of flame AAS is 10 µg As/ml.

#### 14.0 Pollution Prevention [Reserved]

#### 15.0 Waste Management [Reserved]

#### 16.0 References

Same as in Method 108A, Section 16.0.

#### 17.0 Tables, Diagrams, Flowcharts, and Validation Data [Reserved]

### METHOD 108C—DETERMINATION OF ARSENIC CONTENT IN ORE SAMPLES FROM NONFERROUS SMELTERS (MOLYBDENUM BLUE PHOTOMETRIC PROCEDURE)

NOTE: This method does not include all of the specifications (e.g., equipment and supplies) and procedures (e.g., sampling and analytical) essential to its performance. Some material is incorporated by reference from other methods in this part. Therefore, to obtain reliable results, persons using this method should have a thorough knowledge of at least Method 108A.

#### 1.0 Scope and Application

1.1 Analytes.

| Analyte                           | CAS No.   | Sensitivity                              |
|-----------------------------------|-----------|--|
| Arsenic compounds as arsenic (As) | 7440-38-2 | Lower limit 0.0002 percent As by weight. |

1.2 Applicability. This method applies to the determination of inorganic As content of process ore and reverberatory matte samples from nonferrous smelters and other sources as specified in an applicable subpart of the regulations.

1.3 Data Quality Objectives. Adherence to the requirements of this method will enhance the quality of the data obtained from air pollutant sampling methods.

## 2.0 Summary of Method

Arsenic bound in ore samples is liberated by acid digestion and analyzed by the molybdenum blue photometric procedure.

## 3.0 Definitions. [Reserved]

## 4.0 Interferences. [Reserved]

## 5.0 Safety

5.1 Disclaimer. This method may involve hazardous materials, operations, and equipment. This test method may not address all of the safety problems associated with its use. It is the responsibility of the user to establish appropriate safety and health practices and determine the applicability of regulatory limitations prior to performing this test method.

5.2 Corrosive Reagents. The following reagents are hazardous. Personal protective equipment and safe procedures that prevent chemical splashes are recommended. If contact occurs, immediately flush with copious amounts of water for at least 15 minutes. Remove clothing under shower and decontaminate. Treat residual chemical burns as thermal burns.

5.2.1 Hydrochloric Acid (HCl). Highly corrosive liquid with toxic vapors. Vapors are highly irritating to eyes, skin, nose, and lungs, causing severe damage. May cause bronchitis, pneumonia, or edema of lungs. Exposure to concentrations of 0.13 to 0.2 percent can be lethal to humans in a few minutes. Provide ventilation to limit exposure. Reacts with metals, producing hydrogen gas.

5.2.2 Hydrofluoric Acid (HF). Highly corrosive to eyes, skin, nose, throat, and lungs. Reaction to exposure may be delayed by 24 hours or more. Provide ventilation to limit exposure.

5.2.3 Nitric Acid (HNO<sub>3</sub>). Highly corrosive to eyes, skin, nose, and lungs. Vapors are highly toxic and can cause bronchitis, pneumonia, or edema of lungs. Reaction to inhalation may be delayed as long as 30 hours and still be fatal. Provide ventilation to limit exposure. Strong oxidizer. Hazardous reaction may occur with organic materials such as solvents.

5.2.4 Perchloric Acid (HClO<sub>4</sub>). Corrosive to eyes, skin, nose, and throat. Provide ventilation to limit exposure. Very strong oxidizer. Keep separate from water and oxidizable materials to prevent vigorous evolution of heat, spontaneous combustion, or explosion. Heat solutions containing HClO<sub>4</sub> only in hoods specifically designed for HClO<sub>4</sub>.

5.2.5 Sulfuric acid (H<sub>2</sub>SO<sub>4</sub>). Rapidly destructive to body tissue. Will cause third degree burns. Eye damage may result in blindness. Inhalation may be fatal from spasm of the larynx, usually within 30 minutes. May cause lung tissue damage with edema. 3 mg/m<sup>3</sup> will cause lung damage in uninitiated. 1 mg/m<sup>3</sup> for 8 hours will cause lung damage or, in higher concentrations, death. Provide ventilation to limit inhalation. Reacts violently with metals and organics.

## 6.0 Equipment and Supplies



6.1 Sample Preparation. The following items are required for sample preparation:

6.1.1 Analytical Balance. To measure to within 0.1 mg.

6.1.2 Erlenmeyer Flask. 300-ml.

6.1.3 Hot Plate.

6.1.4 Distillation Apparatus. No. 6, in ASTM E 50-82, 86, or 90 (Reapproved 1995)(incorporated by reference—see §61.18); detailed in Figure 108C-1.

6.1.5 Graduated Cylinder. 50-ml.

6.1.6 Perchloric Acid Fume Hood.

6.2 Analysis. The following items are required for analysis:

6.2.1 Spectrophotometer. Capable of measuring at 660 nm.

6.2.2 Volumetric Flasks. 50- and 100-ml.

### *7.0 Reagents and Standards*

Unless otherwise indicated, it is intended that all reagents conform to the specifications established by the Committee on Analytical Reagents of the American Chemical Society, where such specifications are available; otherwise, use the best available grade.

7.1 Sample Preparation. The following reagents are required for sample preparation:

7.1.1 Water. Deionized distilled to meet ASTM D 1193-77 or 91 Type 3 (incorporated by reference—see §61.18). When high concentrations of organic matter are not expected to be present, the  $\text{KMnO}_4$  test for oxidizable organic matter may be omitted. Use in all dilutions requiring water.

7.1.2 Nitric Acid, Concentrated.

7.1.3 Hydrofluoric Acid, Concentrated.

7.1.4 Sulfuric Acid, Concentrated.

7.1.5 Perchloric Acid, 70 Percent.

7.1.6 Hydrochloric Acid, Concentrated.

7.1.7 Dilute Hydrochloric Acid. Add one part concentrated HCl to nine parts water.

7.1.8 Hydrazine Sulfate  $(\text{NH}_2)_2 \cdot \text{H}_2\text{SO}_4$ .

7.1.9 Potassium Bromide (KBr).

7.1.10 Bromine Water, Saturated.

7.2 Analysis. The following reagents and standards are required for analysis:

7.2.1 Water. Same as in Section 7.1.1.

7.2.2 Methyl Orange Solution, 1 g/liter.

7.2.3 Ammonium Molybdate Solution, 5 g/liter. Dissolve 0.5 g  $(\text{NH}_4)\text{Mo}_7\text{O}_{24}\cdot 4\text{H}_2\text{O}$  in water in a 100-ml volumetric flask, and dilute to the mark. This solution must be freshly prepared.

7.2.4 Standard Arsenic Solution, 10  $\mu\text{g}$  As/ml. Dissolve 0.13203 g of  $\text{As}_2\text{O}_3$  in 100 ml HCl in a 1-liter volumetric flask. Add 200 ml of water, cool, dilute to the mark with water, and mix. Transfer 100 ml of this solution to a 1-liter volumetric flask, add 40 ml HCl, cool, dilute to the mark, and mix.

7.2.5 Hydrazine Sulfate Solution, 1 g/liter. Dissolve 0.1 g of  $[(\text{NH}_2)_2\cdot\text{H}_2\text{SO}_4]$  in water, and dilute to 100 ml in a volumetric flask. This solution must be freshly prepared.

7.2.6 Potassium Bromate ( $\text{KBrO}_3$ ) Solution, 0.03 Percent Weight by Volume (W/V). Dissolve 0.3 g  $\text{KBrO}_3$  in water, and dilute to 1 liter with water.

7.2.7 Ammonium Hydroxide ( $\text{NH}_4\text{OH}$ ), Concentrated.

7.2.8 Boiling Granules.

7.2.9 Hydrochloric Acid, 50 percent by volume. Dilute equal parts concentrated HCl with water.

### 8.0 Sample Collection, Preservation, Transport, and Storage

Same as in Method 108A, Sections 8.1 and 8.2.

### 9.0 QUALITY CONTROL

| Section | Quality control measure       | Effect  |
|---------|-------------------------------|---|
| 10.2    | Calibration curve preparation | Ensure linearity of spectrophotometric response to standards. |

### 10.0 Calibration and Standardizations

NOTE: Maintain a laboratory log of all calibrations.

10.1 Preparation of Standard Solutions. Transfer 1.0, 2.0, 4.0, 8.0, 12.0, 16.0, and 20.0 ml of standard arsenic solution (10  $\mu\text{g}/\text{ml}$ ) to each of seven 50-ml volumetric flasks. Dilute to 20 ml with dilute HCl. Add one drop of methyl orange solution and neutralize to the yellow color with dropwise addition of  $\text{NH}_4\text{OH}$ . Just bring back to the red color by dropwise addition of dilute HCl, and add 10 ml in excess. Proceed with the color development as described in Section 11.2.

10.2 Calibration Curve. Plot the spectrophotometric readings of the calibration solutions against  $\mu\text{g}$  As per 50 ml of solution. Use this curve to determine the As concentration of each sample.

10.3 Spectrophotometer Calibration Quality Control. Calculate the least squares slope of the calibration curve. The line must pass through the origin or through a point no further from the origin than  $\pm 2$  percent of the recorder full scale. Multiply the corrected peak height by the reciprocal of the least squares slope to determine the distance each calibration point lies from the theoretical calibration line.

The difference between the calculated concentration values and the actual concentrations must be less than 7 percent for all standards.

## 11.0 Analytical Procedure

### 11.1 Sample Preparation.

11.1.1 Weigh 1.0 g of finely pulverized sample to the nearest 0.1 mg. Transfer the sample to a 300 ml Erlenmeyer flask and add 15 ml of  $\text{HNO}_3$ , 4 ml  $\text{HCl}$ , 2 ml  $\text{HF}$ , 3 ml  $\text{HClO}_4$ , and 15 ml  $\text{H}_2\text{SO}_4$ , in the order listed. In a  $\text{HClO}_4$  fume hood, heat on a hot plate to decompose the sample. Then heat while swirling over an open flame until dense white fumes evolve. Cool, add 15 ml of water, swirl to hydrate the  $\text{H}_2\text{SO}_4$  completely, and add several boiling granules. Cool to room temperature.

11.1.2 Add 1 g of  $\text{KBr}$ , 1 g hydrazine sulfate, and 50 ml  $\text{HCl}$ . Immediately attach the distillation head with thermometer and dip the side arm into a 50-ml graduated cylinder containing 25 ml of water and 2 ml of bromine water. Keep the graduated cylinder immersed in a beaker of cold water during distillation. Distill until the temperature of the vapor in the flask reaches  $107^\circ\text{C}$  ( $225^\circ\text{F}$ ). When distillation is complete, remove the flask from the hot plate, and simultaneously wash down the side arm with water as it is removed from the cylinder.

11.1.3 If the expected arsenic content is in the range of 0.0020 to 0.10 percent, dilute the distillate to the 50-ml mark of the cylinder with water, stopper, and mix. Transfer a 5.0-ml aliquot to a 50-ml volumetric flask. Add 10 ml of water and a boiling granule. Place the flask on a hot plate, and heat gently until the bromine is expelled and the color of methyl orange indicator persists upon the addition of 1 to 2 drops. Cool the flask to room temperature. Neutralize just to the yellow color of the indicator with dropwise additions of  $\text{NH}_4\text{OH}$ . Bring back to the red color by dropwise addition of dilute  $\text{HCl}$ , and add 10 ml excess. Proceed with the molybdenum blue color development as described in Section 11.2.

11.1.4 If the expected arsenic content is in the range of 0.0002 to 0.0010 percent  $\text{As}$ , transfer either the entire initial distillate or the measured remaining distillate from Section 11.1.2 to a 250-ml beaker. Wash the cylinder with two successive portions of concentrated  $\text{HNO}_3$ , adding each portion to the distillate in the beaker. Add 4 ml of concentrated  $\text{HClO}_4$ , a boiling granule, and cover with a flat watch glass placed slightly to one side. Boil gently on a hot plate until the volume is reduced to approximately 10 ml. Add 3 ml of  $\text{HNO}_3$ , and continue the evaporation until  $\text{HClO}_4$  is refluxing on the beaker cover. Cool briefly, rinse the underside of the watch glass and the inside of the beaker with about 3-5 ml of water, cover, and continue the evaporation to expel all but 2 ml of the  $\text{HClO}_4$ .

NOTE: If the solution appears cloudy due to a small amount of antimony distilling over, add 4 ml of 50 percent  $\text{HCl}$  and 5 ml of water, cover, and warm gently until clear. If cloudiness persists, add 5 ml of  $\text{HNO}_3$  and 2 ml  $\text{H}_2\text{SO}_4$ . Continue the evaporation of volatile acids to solubilize the antimony until dense white fumes of  $\text{H}_2\text{SO}_4$  appear. Retain at least 1 ml of the  $\text{H}_2\text{SO}_4$ .

11.1.5 To the 2 ml of  $\text{HClO}_4$  solution or 1 ml of  $\text{H}_2\text{SO}_4$  solution, add 15 ml of water, boil gently for 2 minutes, and then cool. Proceed with the molybdenum blue color development by neutralizing the solution directly in the beaker just to the yellow indicator color by dropwise addition of  $\text{NH}_4\text{OH}$ . Obtain the red color by dropwise addition of dilute  $\text{HCl}$ . Transfer the solution to a 50-ml volumetric flask. Rinse the beaker successively with 10 ml of dilute  $\text{HCl}$ , followed by several small portions of water. At this point the volume of solution in the flask should be no more than 40 ml. Continue with the color development as described in Section 11.2.

### 11.2 Analysis.

11.2.1 Add 1 ml of  $\text{KBrO}_3$  solution to the flask and heat on a low-temperature hot plate to about  $50^\circ\text{C}$  ( $122^\circ\text{F}$ ) to oxidize the arsenic and methyl orange. Add 5.0 ml of ammonium molybdate solution to the

warm solution and mix. Add 2.0 ml of hydrazine sulfate solution, dilute until the solution comes within the neck of the flask, and mix. Place the flask in a 400 ml beaker, 80 percent full of boiling water, for 10 minutes. Enough heat must be supplied to prevent the water bath from cooling much below the boiling point upon inserting the volumetric flask. Remove the flask, cool to room temperature, dilute to the mark, and mix.

11.2.2 Transfer a suitable portion of the reference solution to an absorption cell, and adjust the spectrophotometer to the initial setting using a light band centered at 660 nm. While maintaining this spectrophotometer adjustment, take the readings of the calibration solutions followed by the samples.

## 12.0 Data Analysis and Calculations

Same as in Method 108A, Section 12.0.

13.0 Method Performance. [Reserved]

14.0 Pollution Prevention. [Reserved]

15.0 Waste Management. [Reserved]

## 16.0 References

1. Ringwald, D. Arsenic Determination on Process Materials from ASARCO's Copper Smelter in Tacoma, Washington. Unpublished Report. Prepared for the Emission Measurement Branch, Technical Support Division, U.S. Environmental Protection Agency, Research Triangle Park, North Carolina. August 1980. 35 pp.

## 17.0 TABLES, DIAGRAMS, FLOWCHARTS, AND VALIDATION DATA

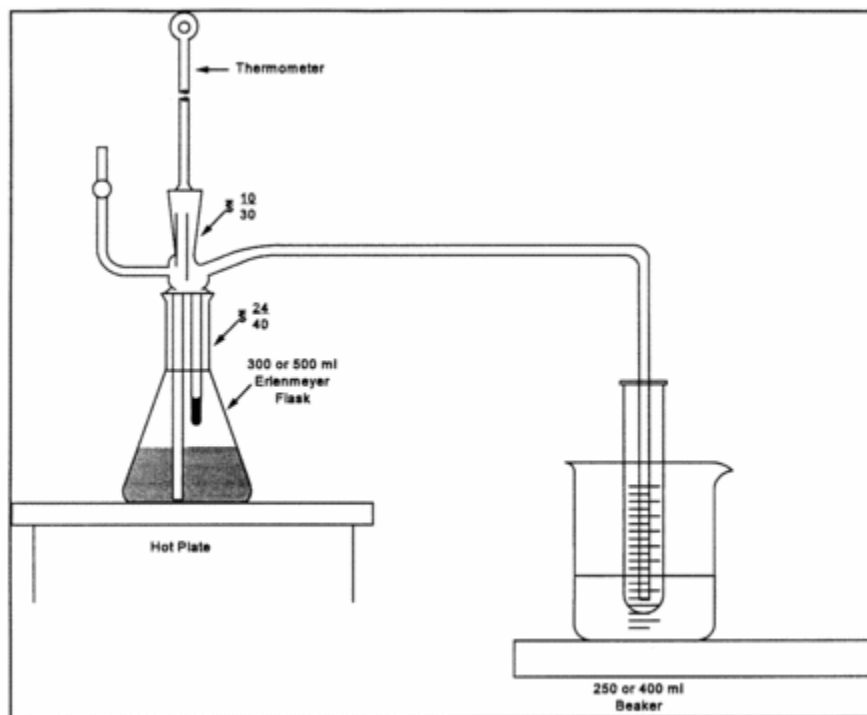

Figure 108C-1. Distillation Apparatus.

NOTE: This method does not include all of the specifications (e.g., equipment and supplies) and procedures (e.g., sampling and analytical) essential to its performance. Some material is incorporated by reference from methods in appendix A to 40 CFR part 60. Therefore, to obtain reliable results, persons using this method should have a thorough knowledge of at least the following additional test methods: Method 1, Method 2, Method 3, and Method 5.

## 1.0 Scope and Application

### 1.1 Analytes.

| Analyte  | CAS No.   | Sensitivity    |
|----------|-----------|----------------|
| Polonium | 7440-08-6 | Not specified. |

1.2 Applicability. This method is applicable for the determination of the polonium-210 content of particulate matter samples collected from stationary source exhaust stacks, and for the use of these data to calculate polonium-210 emissions from individual sources and from all affected sources at a facility.

1.3 Data Quality Objectives. Adherence to the requirements of this method will enhance the quality of the data obtained from air pollutant sampling methods.

## 2.0 Summary of Method

A particulate matter sample, collected according to Method 5, is analyzed for polonium-210 content: the polonium-210 in the sample is put in solution, deposited on a metal disc, and the radioactive disintegration rate measured. Polonium in acid solution spontaneously deposits on surfaces of metals that are more electropositive than polonium. This principle is routinely used in the radiochemical analysis of polonium-210. Data reduction procedures are provided, allowing the calculation of polonium-210 emissions from individual sources and from all affected sources at a facility, using data obtained from Methods 2 and 5 and from the analytical procedures herein.

## 3.0 Definitions [Reserved]

## 4.0 Interferences [Reserved]

## 5.0 Safety

5.1 Disclaimer. This method may involve hazardous materials, operations, and equipment. This test method may not address all of the safety problems associated with its use. It is the responsibility of the user of this test method to establish appropriate safety and health practices and determine the applicability of regulatory limitations prior to performing this test method.

5.2 Corrosive Reagents. The following reagents are hazardous. Personal protective equipment and safe procedures are useful in preventing chemical splashes. If contact occurs, immediately flush with copious amounts of water at least 15 minutes. Remove clothing under shower and decontaminate. Treat residual chemical burns as thermal burns.

5.2.1 Hydrochloric Acid (HCl). Highly corrosive liquid with toxic vapors. Vapors are highly irritating to eyes, skin, nose, and lungs, causing severe damage. May cause bronchitis, pneumonia, or edema of lungs. Exposure to concentrations of 0.13 to 0.2 percent can be lethal to humans in a few minutes. Provide ventilation to limit exposure. Reacts with metals, producing hydrogen gas.

5.2.2 Hydrofluoric Acid (HF). Highly corrosive to eyes, skin, nose, throat, and lungs. Reaction to exposure may be delayed by 24 hours or more. Provide ventilation to limit exposure.

5.2.3 Nitric Acid ( $\text{HNO}_3$ ). Highly corrosive to eyes, skin, nose, and lungs. Vapors cause bronchitis, pneumonia, or edema of lungs. Reaction to inhalation may be delayed as long as 30 hours and still be fatal. Provide ventilation to limit exposure. Strong oxidizer. Hazardous reaction may occur with organic materials such as solvents.

5.2.4 Perchloric Acid ( $\text{HClO}_4$ ). Corrosive to eyes, skin, nose, and throat. Provide ventilation to limit exposure. Keep separate from water and oxidizable materials to prevent vigorous evolution of heat, spontaneous combustion, or explosion. Heat solutions containing  $\text{HClO}_4$  only in hoods specifically designed for  $\text{HClO}_4$ .

## 6.0 *Equipment and Supplies*

6.1 Alpha Spectrometry System. Consisting of a multichannel analyzer, biasing electronics, silicon surface barrier detector, vacuum pump and chamber.

6.2 Constant Temperature Bath at 85 °C (185 °F).

6.3 Polished Silver Discs. 3.8 cm diameter, 0.4 mm thick with a small hole near the edge.

6.4 Glass Beakers. 400 ml, 150 ml.

6.5 Hot Plate, Electric.

6.6 Fume Hood.

6.7 Teflon Beakers, 150 ml.

6.8 Magnetic Stirrer.

6.9 Stirring Bar.

6.10 Hooks. Plastic or glass, to suspend plating discs.

6.11 Internal Proportional Counter. For measuring alpha particles.

6.12 Nucleopore Filter Membranes. 25 mm diameter, 0.2 micrometer pore size or equivalent.

6.13 Planchets. Stainless steel, 32 mm diameter with 1.5 mm lip.

6.14 Transparent Plastic Tape. 2.5 cm wide with adhesive on both sides.

6.15 Epoxy Spray Enamel.

6.16 Suction Filter Apparatus. For 25 mm diameter filter.

6.17 Wash Bottles, 250 ml capacity.

6.18 Graduated Cylinder, plastic, 25 ml capacity.

6.19 Volumetric Flasks, 100 ml, 250 ml.

## 7.0 Reagents and Standards

Unless otherwise indicated, it is intended that all reagents conform to the specifications established by the Committee on Analytical Reagents of the American Chemical Society, where such specifications are available; otherwise, use the best available grade.

7.1 Ascorbic Acid.

7.2 Ammonium Hydroxide (NH<sub>4</sub>OH), 15 M.

7.3 Water. Deionized distilled, to conform to ASTM D 1193-77 or 91 (incorporated by reference—see §61.18), Type 3. Use in all dilutions requiring water.

7.4 Ethanol (C<sub>2</sub>H<sub>5</sub>OH), 95 percent.

7.5 Hydrochloric Acid, 12 M.

7.6 Hydrochloric Acid, 1 M. Dilute 83 ml of the 12 M HCl to 1 liter with distilled water.

7.7 Hydrofluoric Acid, 29 M.

7.8 Hydrofluoric Acid, 3 M. Dilute 52 ml of the 29 M HF to 500 ml with distilled water. Use a plastic graduated cylinder and storage bottle.

7.9 Lanthanum Carrier, 0.1 mg La<sup>+3</sup>/ml. Dissolve 0.078 gram lanthanum nitrate, La(NO<sub>3</sub>)<sub>3</sub>·6H<sub>2</sub>O in 250 ml of 1 M HCl.

7.10 Nitric Acid, 16 M.

7.11 Perchloric Acid, 12 M.

7.12 Polonium-209 Solution.

7.13 Silver Cleaner. Any mild abrasive commercial silver cleaner.

7.14 Degreaser.

7.15 Standard Solution. Standardized solution of an alpha-emitting actinide element, such as plutonium-239 or americium-241.

## 8.0 Sample Collection, Preservation, Transport, and Storage. [Reserved]

## 9.0 Quality Control

9.1 General Requirement.

9.1.1 All analysts using this method are required to demonstrate their ability to use the method and to define their respective accuracy and precision criteria.

## 9.2 MISCELLANEOUS QUALITY CONTROL MEASURES

| Section       | Quality control measure   | Effect                                   |
|---------------|---|--|
| 10.1          | Standardization of alpha spectrometry system                    | Ensure precision of sample analyses.     |
| 10.3          | Standardization of internal proportional counter                | Ensure precise sizing of sample aliquot. |
| 11.1,<br>11.2 | Determination of procedure background and instrument background | Minimize background effects.             |

### 10.0 Calibration and Standardization

#### 10.1 Standardization of Alpha Spectrometry System.

10.1.1 Add a quantity of the actinide standard solution to a 100 ml volumetric flask so that the final concentration when diluted to a volume of 100 ml will be approximately 1 pCi/ml.

10.1.2 Add 10 ml of 16 M HNO<sub>3</sub> and dilute to 100 ml with water.

10.1.3 Add 20 ml of 1 M HCl to each of six 150 ml beakers. Add 1.0 ml of lanthanum carrier, 0.1 mg lanthanum per ml, to the acid solution in each beaker.

10.1.4 Add 1.0 ml of the 1 pCi/ml working solution (from Section 10.1.1) to each beaker. Add 5.0 ml of 3 M HF to each beaker.

10.1.5 Cover beakers and allow solutions to stand for a minimum of 30 minutes. Filter the contents of each beaker through a separate filter membrane using the suction filter apparatus. After each filtration, wash the filter membrane with 10 ml of distilled water and 5 ml of ethanol, and allow the filter membrane to air dry on the filter apparatus.

10.1.6 Carefully remove the filter membrane and mount it, filtration side up, with double-side tape on the inner surface of a planchet. Place planchet in an alpha spectrometry system and count each planchet for 1000 minutes.

10.1.7 Calculate the counting efficiency of the detector for each aliquot of the 1 pCi/ml actinide working solution using Eq. 111-1 in Section 12.2.

10.1.8 Determine the average counting efficiency of the detector,  $E_c$ , by calculating the average of the six determinations.

#### 10.2 Preparation of Standardized Solution of Polonium-209.

10.2.1 Add a quantity of the Po-209 solution to a 100 ml volumetric flask so that the final concentration when diluted to a 100 ml volume will be approximately 1 pCi/ml.

10.2.2 Follow the procedures outlined in Sections 10.1.2 through 10.1.6, except substitute 1.0 ml of polonium-209 tracer solution (Section 10.2.1) and 3.0 ml of 15 M ammonium hydroxide for the 1 pCi/ml actinide working solution and the 3 M HF, respectively.

10.2.3 Calculate the activity of each aliquot of the polonium-209 tracer solution using Eq. 111-2 in Section 12.3.



10.2.4 Determine the average activity of the polonium-209 tracer solution,  $F$ , by averaging the results of the six determinations.

### 10.3 Standardization of Internal Proportional Counter

10.3.1 Add a quantity of the actinide standard solution to a 100 ml volumetric flask so that the final concentration when diluted to a 100 ml volume will be approximately 100 pCi/ml.

10.3.2 Follow the procedures outlined in Sections 10.1.2 through 10.1.6, except substitute the 100 pCi/ml actinide working solution for the 1 pCi/ml solution, place the planchet in an internal proportional counter (instead of an alpha spectrometry system), and count for 100 minutes (instead of 1000 minutes).

10.3.3 Calculate the counting efficiency of the internal proportional counter for each aliquot of the 100 pCi/ml actinide working solution using Eq. 111-3 in 12.4.

10.3.4 Determine the average counting efficiency of the internal proportional counter,  $E_i$ , by averaging the results of the six determinations.

## 11.0 ANALYTICAL PROCEDURE

NOTE: Perform duplicate analyses of all samples, including background counts and Method 5 samples. Duplicate measurements are considered acceptable when the difference between them is less than two standard deviations as described in EPA 600/4-77-001 or subsequent revisions.

11.1 Determination of Procedure Background. Background counts used in all equations are determined by performing the specific analysis required using the analytical reagents only. All procedure background counts and sample counts for the internal proportional counter should utilize a counting time of 100 minutes; for the alpha spectrometry system, 1000 minutes. These background counts should be performed no less frequently than once per 10 sample analyses.

11.2 Determination of Instrument Background. Instrument backgrounds of the internal proportional counter and the alpha spectrometry system should be determined on a weekly basis. Instrument background should not exceed procedure background. If this occurs, it may be due to a malfunction or contamination, and should be corrected before use.

11.4 Sample Preparation. Treat the Method 5 samples [*i.e.*, the glass fiber filter (Container No. 1) and the acetone rinse (Container No. 2)] as follows:

11.4.1 Container No. 1. Transfer the filter and any loose particulate matter from the sample container to a 150-ml Teflon beaker.

11.4.2 Container No. 2. Note the level of liquid in the container, and confirm on the analysis sheet whether leakage occurred during transport. If a noticeable amount of leakage has occurred, either void the sample or use methods, subject to the approval of the Administrator, to correct the final results. Transfer the contents to a 400-ml glass beaker. Add polonium-209 tracer solution to the glass beaker in an amount approximately equal to the amount of polonium-210 expected in the total particulate sample. Record the activity of the tracer solution added. Add 16 M nitric acid to the beaker to digest and loosen the residue.

11.4.3 Transfer the contents of the glass beaker to the Teflon beaker containing the glass fiber filter. Rinse the glass beaker with 16 M  $\text{HNO}_3$ . If necessary, reduce the volume in the beaker by evaporation until all of the nitric acid  $\text{HNO}_3$  from the glass beaker has been transferred to the Teflon beaker.

11.4.4 Add 30 ml of 29 M HF to the Teflon beaker and evaporate to near dryness on a hot plate in a properly operating hood.

NOTE: Do not allow the residue to go to dryness and overheat; this will result in loss of polonium.

11.4.5 Repeat step 11.4.4 until the filter is dissolved.

11.4.6 Add 100 ml of 16 M HNO<sub>3</sub> to the residue in the Teflon beaker and evaporate to near dryness.

NOTE: Do not allow the residue to go to dryness.

11.4.7 Add 50 ml of 16 M HNO<sub>3</sub> and 10 ml of 12 M perchloric acid to the Teflon beaker and heat until dense fumes of perchloric acid are evolved.

11.4.8 Repeat steps 11.4.4 to 11.4.7 as necessary until sample is completely dissolved.

11.4.9 Add 10 ml of 12 M HCl to the Teflon beaker and evaporate to dryness. Repeat additions and evaporations several times.

11.4.10 Transfer the sample to a 250-ml volumetric flask and dilute to volume with 3 M HCl.

11.5 Sample Screening. To avoid contamination of the alpha spectrometry system, check each sample as follows:

11.5.1 Add 20 ml of 1 M HCl, 1 ml of the lanthanum carrier solution (0.1 mg La/ml), a 1 ml aliquot of the sample solution from Section 11.4.10, and 3 ml of 15 M ammonium hydroxide to a 250-ml beaker in the order listed. Allow this solution to stand for a minimum of 30 minutes.

11.5.2 Filter the solution through a filter membrane using the suction filter apparatus. Wash the filter membrane with 10 ml of water and 5 ml of ethanol, and allow the filter membrane to air dry on the filter apparatus.

11.5.3 Carefully remove the filter membrane and mount it, filtration side up, with double-side tape on the inner surface of a planchet. Place the planchet in an internal proportional counter, and count for 100 minutes.

11.5.4 Calculate the activity of the sample using Eq. 111-4 in Section 12.5.

11.5.5 Determine the aliquot volume of the sample solution from Section 11.4.10 to be analyzed for polonium-210, such that the aliquot contains an activity between 1 and 4 picocuries. Use Eq. 111-5 in Section 12.6.

11.6 Preparation of Silver Disc for Spontaneous Electrodeposition.

11.6.1 Clean both sides of the polished silver disc with silver cleaner and with degreaser.

11.6.2 Place disc on absorbent paper and spray one side with epoxy spray enamel. This should be carried out in a well-ventilated area, with the disc lying flat to keep paint on one side only. Allow paint to dry for 24 hours before using disc for deposition.

11.7 Sample Analysis.

11.7.1 Add the aliquot of sample solution from Section 11.4.10 to be analyzed for polonium-210, the volume of which was determined in Section 11.5.5, to a suitable 200-ml container to be placed in a constant temperature bath.

NOTE: Aliquot volume may require a larger container.

11.7.2 If necessary, bring the volume to 100 ml with 1 M HCl. If the aliquot volume exceeds 100 ml, use total aliquot.

11.7.3 Add 200 mg of ascorbic acid and heat solution to 85 °C (185 °F) in a constant temperature bath.

11.7.4 Suspend a silver disc in the heated solution using a glass or plastic rod with a hook inserted through the hole in the disc. The disc should be totally immersed in the solution, and the solution must be stirred constantly, at all times during the plating operation. Maintain the disc in solution for 3 hours.

11.7.5 Remove the silver disc, rinse with deionized distilled water, and allow to air dry at room temperature.

11.7.6 Place the disc, with deposition side (unpainted side) up, on a planchet and secure with double-side plastic tape. Place the planchet with disc in alpha spectrometry system and count for 1000 minutes.

## 12.0 Data Analysis and Calculations.

### 12.1 Nomenclature.

$A$  = Picocuries of polonium-210 in the Method 5 sample (from Section 12.8).

$A_A$  = Picocuries of actinide added.

$A_L$  = Volume of sample aliquot used, in ml (specified in Section 11.5.1 as 1 ml).

$A_S$  = Aliquot to be analyzed, in ml.

$B_B$  = Procedure background counts measured in polonium-209 spectral region.

$B_T$  = Polonium-209 tracer counts in sample.

$C_T$  = Total counts in polonium-210 spectral region.

$D$  = Decay correction for time "t" (in days) from sample collection to sample counting, given by:  $D = e^{-0.005t}$

$E_c$  = Average counting efficiency of detector (from Section 10.1.8), as counts per disintegration.

$E_{ci}$  = Counting efficiency of the detector for aliquot i of the actinide working solution, counts per disintegration.

$E_i$  = Average counting efficiency of the internal proportional counter, as determined in Section 10.3.4, counts per disintegration.

$E_{ii}$  = Counting efficiency of the internal proportional counter for aliquot i of the 100 pCi/ml actinide working solution, counts per disintegration.

$E_\gamma$  = The fraction of polonium-209 recovered on the planchet (from Section 12.7).

F = Average activity of polonium-209 in sample (from Section 10.2.4), in pCi.

F<sub>i</sub> = activity of aliquot i of the polonium-209 tracer solution, in pCi.

L = Dilution factor (unitless). This is the volume of sample solution prepared (specified as 250 ml in Section 11.1.10) divided by the volume of the aliquot of sample solution analyzed for polonium-210 (from Section 11.7.1).

M<sub>i</sub> = Phosphorous rock processing rate of the source being tested, during run i, Mg/hr.

M<sub>k</sub> = Phosphate rock processed annually by source k, in Mg/yr.

n = Number of calciners at the elemental phosphorus plant.

P = Total activity of sample solution from Section 11.4.10, in pCi (see Eq. 111-4).

Q<sub>sd</sub> = Volumetric flow rate of effluent stream, as determined by Method 2, in dscm/hr.

S = Annual polonium-210 emissions from the entire facility, in curies/yr.

V<sub>m(std)</sub> = Volume of air sample, as determined by Method 5, in dscm.

X<sub>k</sub> = Emission rate from source k, from Section 12.10, in curies/Mg.

10<sup>-12</sup> = Curies per picocurie.

2.22 = Disintegrations per minute per picocurie.

250 = Volume of solution from Section 11.4.10, in ml.

12.2 Counting Efficiency. Calculate the counting efficiency of the detector for each aliquot of the 1 pCi/ml actinide working solution using Eq. 111-1.

$$E_{CI} = \frac{C_S - C_B}{2.22 A_A T} \quad \text{Eq. 111-1}$$

Where:

C<sub>B</sub> = Background counts in same peak area as C<sub>S</sub>.

C<sub>S</sub> = Gross counts in actinide peak.

T = Counting time in minutes, specified in Section 10.1.6 as 1000 minutes.

12.3 Polonium-209 Tracer Solution Activity. Calculate the activity of each aliquot of the polonium-209 tracer solution using Eq. 111-2.

$$F_i = \frac{C_S - C_B}{2.22 E_{CI} T} \quad \text{Eq. 111-2}$$

Where:

C<sub>B</sub> = Background counts in the 4.88 MeV region of spectrum the in the counting time T.

C<sub>S</sub> = Gross counts of polonium-209 in the 4.88 MeV region of the spectrum in the counting time T.

T = Counting time, specified in Section 10.1.6 as 1000 minutes.

12.4 Control Efficiency of Internal Proportional Counter. Calculate the counting efficiency of the internal proportional counter for each aliquot of the 100 pCi/ml actinide working solution using Eq. 111-3.

$$E_{II} = \frac{C_s - C_B}{2.22 A_A T} \quad \text{Eq. 111-3}$$

[View or download PDF](#)

Where:

$C_B$  = Gross counts of procedure background.

$C_s$  = Gross counts of standard.

T = Counting time in minutes, specified in Section 10.3.2 as 100 minutes.

12.5 Calculate the activity of the sample using Eq. 111-4.

$$P = \frac{250 (C_s - C_B)}{2.22 \bar{E}_I A_L T} \quad \text{Eq. 111-4}$$

Where:

$C_B$  = Total counts of procedure background. (See Section 11.1).

$C_s$  = Total counts of screening sample.

T = Counting time for sample and background (which must be equal), in minutes (specified in Section 11.5.3 as 100 minutes).

12.6 Aliquot Volume. Determine the aliquot volume of the sample solution from Section 11.4.10 to be analyzed for polonium-210, such that the aliquot contains an activity between 1 and 4 picocuries using Eq. 111-5.

$$A_s = \frac{250 (\text{desired picocuries in aliquot})}{P} \quad \text{Eq. 111-5}$$

12.7 Polonium-209 Recovery. Calculate the fraction of polonium-209 recovered on the planchet,  $E_Y$ , using Eq. 111-6.

$$E_Y = \frac{B_T - B_B}{2.22 \bar{F} \bar{E}_C T} \quad \text{Eq. 111-6}$$

Where:

T = Counting time, specified in Section 11.1 as 1000 minutes.

12.8 Polonium-210 Activity. Calculate the activity of polonium-210 in the Method 5 sample (including glass fiber filter and acetone rinse) using Eq. 111-7.

$$A = \frac{(C_T - C_B) L}{2.22 E_Y \bar{E}_C T D} \quad \text{Eq. 111-7}$$

Where:

$C_B$  = Procedure background counts in polonium-210 spectral region.

T = Counting time, specified in Section 11.1 as 1000 minutes for all alpha spectrometry sample and background counts.

## 12.9 Emission Rate from Each Stack.

12.9.1 For each test run,  $i$ , on a stack, calculate the measured polonium-210 emission rate,  $R_{Si}$ , using Eq. 111-8.

$$R_{Si} = \frac{(10^{-12})AQ_{sd}}{V_{m(sdt)}M_i} \quad \text{Eq. 111-8}$$

12.9.2 Determine the average polonium-210 emission rate from the stack,  $R_s$ , by taking the sum of the measured emission rates for all runs, and dividing by the number of runs performed.

12.9.3 Repeat steps 12.9.1 and 12.9.2 for each stack of each calciner.

12.10 Emission Rate from Each Source. Determine the total polonium-210 emission rate,  $X_k$ , from each source,  $k$ , by taking the sum of the average emission rates from all stacks to which the source exhausts.

12.11 Annual Polonium-210 Emission Rate from Entire Facility. Determine the annual elemental phosphorus plant emissions of polonium-210,  $S$ , using Eq. 111-9.

$$S = \frac{\sum_{k=1}^n (X_k M_k)}{n} \quad \text{Eq. 111-9}$$

13.0 *Method Performance. [Reserved]*

14.0 *Pollution Prevention. [Reserved]*

15.0 *Waste Management. [Reserved]*

## 16.0 References

1. Blanchard, R.L. "Rapid Determination of Lead-210 and Polonium-210 in Environmental Samples by Deposition on Nickel." *Anal. Chem.*, 38:189, pp. 189-192. February 1966.

17.0 *Tables, Diagrams, Flowcharts, and Validation Data [Reserved]*

## METHOD 114—TEST METHODS FOR MEASURING RADIONUCLIDE EMISSIONS FROM STATIONARY SOURCES

### 1. Purpose and Background

This method provides the requirements for: (1) Stack monitoring and sample collection methods appropriate for radionuclides; (2) radiochemical methods which are used in determining the amounts of radionuclides collected by the stack sampling and; (3) quality assurance methods which are conducted in conjunction with these measurements. These methods are appropriate for emissions for stationary sources. A list of references is provided.

Many different types of facilities release radionuclides into air. These radionuclides differ in the chemical and physical forms, half-lives and type of radiation emitted. The appropriate combination of

sample extraction, collection and analysis for an individual radionuclide is dependent upon many interrelated factors including the mixture of other radionuclides present. Because of this wide range of conditions, no single method for monitoring or sample collection and analysis of a radionuclide is applicable to all types of facilities. Therefore, a series of methods based on “principles of measurement” are described for monitoring and sample collection and analysis which are applicable to the measurement of radionuclides found in effluent streams at stationary sources. This approach provides the user with the flexibility to choose the most appropriate combination of monitoring and sample collection and analysis methods which are applicable to the effluent stream to be measured.

## 2. Stack Monitoring and Sample Collection Methods

Monitoring and sample collection methods are described based on “principles of monitoring and sample collection” which are applicable to the measurement of radionuclides from effluent streams at stationary sources. Radionuclides of most elements will be in the particulate form in these effluent streams and can be readily collected using a suitable filter media. Radionuclides of hydrogen, oxygen, carbon, nitrogen, the noble gases and in some circumstances iodine will be in the gaseous form. Radionuclides of these elements will require either the use of an in-line or off-line monitor to directly measure the radionuclides, or suitable sorbers, condensers or bubblers to collect the radionuclides.

2.1 Radionuclides as Particulates. The extracted effluent stream is passed through a filter media to remove the particulates. The filter must have a high efficiency for removal of sub-micron particles. The guidance in ANSI/HPS N13.1-1999 (section 6.6.2 Filter media) shall be followed in using filter media to collect particulates (incorporated by reference—see §61.18 of this part).

### 2.2 Radionuclides as Gases.

2.2.1 The Radionuclide Tritium (H-3). Tritium in the form of water vapor is collected from the extracted effluent sample by sorption, condensation or dissolution techniques. Appropriate collectors may include silica gel, molecular sieves, and ethylene glycol or water bubblers.

Tritium in the gaseous form may be measured directly in the sample stream using Method B-1, collected as a gas sample or may be oxidized using a metal catalyst to tritiated water and collected as described above.

2.2.2 Radionuclides of Iodine. Iodine is collected from an extracted sample by sorption or dissolution techniques. Appropriate collectors may include charcoal, impregnated charcoal, metal zeolite and caustic solutions.

2.2.3 Radionuclides of Argon, Krypton and Xenon. Radionuclides of these elements are either measured directly by an in-line or off-line monitor, or are collected from the extracted sample by low temperature sorption techniques. Appropriate sorbers may include charcoal or metal zeolite.

2.2.4 Radionuclides of Oxygen, Carbon, Nitrogen and Radon. Radionuclides of these elements are measured directly using an in-line or off-line monitor. Radionuclides of carbon in the form of carbon dioxide may be collected by dissolution in caustic solutions.

### 2.3 Definition of Terms

*In-line monitor* means a continuous measurement system in which the detector is placed directly in or adjacent to the effluent stream. This may involve either gross radioactivity measurements or specific radionuclide measurements. Gross measurements shall be made in conformance with the conditions specified in Methods A-4, B-2 and G-4.

*Off-line monitor* means a measurement system in which the detector is used to continuously measure an extracted sample of the effluent stream. This may involve either gross radioactivity measurements or specific radionuclide measurements. Gross measurements shall be made in conformance with the conditions specified in Methods A-4, B-2 and G-4.

*Sample collection* means a procedure in which the radionuclides are removed from an extracted sample of the effluent using a collection media. These collection media include filters, absorbers, bubblers and condensers. The collected sample is analyzed using the methods described in Section 3.

### 3. Radionuclide Analysis Methods

A series of methods based on “principles of measurement” are described which are applicable to the analysis of radionuclides collected from airborne effluent streams at stationary sources. These methods are applicable only under the conditions stated and within the limitations described. Some methods specify that only a single radionuclide be present in the sample or the chemically separated sample. This condition should be interpreted to mean that no other radionuclides are present in quantities which would interfere with the measurement.

Also identified (Table 1) are methods for a selected list of radionuclides. The listed radionuclides are those which are most commonly used and which have the greatest potential for causing dose to members of the public. Use of methods based on principles of measurement other than those described in this section must be approved in advance of use by the Administrator. For radionuclides not listed in Table 1, any of the described methods may be used provided the user can demonstrate that the applicability conditions of the method have been met.

The type of method applicable to the analysis of a radionuclide is dependent upon the type of radiation emitted, i.e., alpha, beta or gamma. Therefore, the methods described below are grouped according to principles of measurements for the analysis of alpha, beta and gamma emitting radionuclides.

#### 3.1 Methods for Alpha Emitting Radionuclides

##### 3.1.1 Method A-1, Radiochemistry-Alpha Spectrometry.

*Principle:* The element of interest is separated from other elements, and from the sample matrix using radiochemical techniques. The procedure may involve precipitation, ion exchange, or solvent extraction. Carriers (elements chemically similar to the element of interest) may be used. The element is deposited on a planchet in a very thin film by electrodeposition or by coprecipitation on a very small amount of carrier, such as lanthanum fluoride. The deposited element is then counted with an alpha spectrometer. The activity of the nuclide of interest is measured by the number of alpha counts in the appropriate energy region. A correction for chemical yield and counting efficiency is made using a standardized radioactive nuclide (tracer) of the same element. If a radioactive tracer is not available for the element of interest, a predetermined chemical yield factor may be used.

*Applicability:* This method is applicable for determining the activity of any alpha-emitting radionuclide, regardless of what other radionuclides are present in the sample provided the chemical separation step produces a very thin sample and removes all other radionuclides which could interfere in the spectral region of interest. APHA-605(2), ASTM-D-3972(13).

##### 3.1.2 Method A-2, Radiochemistry-Alpha Counting.

*Principle:* The element of interest is separated from other elements, and from the sample matrix using radiochemistry. The procedure may involve precipitation, ion exchange, or solvent extraction.



Carriers (elements chemically similar to the element of interest) may be used. The element is deposited on a planchet in a thin film and counted with an alpha counter. A correction for chemical yield (if necessary) is made. The alpha count rate measures the total activity of all emitting radionuclides of the separated element.

*Applicability:* This method is applicable for the measurement of any alpha-emitting radionuclide, provided no other alpha emitting radionuclide is present in the separated sample. It may also be applicable for determining compliance, when other radionuclides of the separated element are present, provided that the calculated emission rate is assigned to the radionuclide which could be present in the sample that has the highest dose conversion factor. IDO-12096(18).

### 3.1.3 Method A-3, Direct Alpha Spectrometry.

*Principle:* The sample, collected on a suitable filter, is counted directly on an alpha spectrometer. The sample must be thin enough and collected on the surface of the filter so that any absorption of alpha particle energy in the sample or the filter, which would degrade the spectrum, is minimal.

*Applicability:* This method is applicable to simple mixtures of alpha emitting radionuclides and only when the amount of particulates collected on the filter paper are relatively small and the alpha spectra is adequately resolved. Resolutions should be 50 keV (FWHM) or better, ASTM-D-3084(16).

### 3.1.4 Method A-4, Direct Alpha Counting (Gross alpha determination).

*Principle:* The sample, collected on a suitable filter, is counted with an alpha counter. The sample must be thin enough so that self-absorption is not significant and the filter must be of such a nature that the particles are retained on the surface.

*Applicability:* Gross alpha determinations may be used to measure emissions of specific radionuclides only (1) when it is known that the sample contains only a single radionuclide, or the identity and isotopic ratio of the radionuclides in the sample are well-known, and (2) measurements using either Method A-1, A-2 or A-5 have shown that this method provides a reasonably accurate measurement of the emission rate. Gross alpha measurements are applicable to unidentified mixtures of radionuclides only for the purposes and under the conditions described in section 3.7. APHA-601(3), ASTM-D-1943(10).

### 3.1.5 Method A-5, Chemical Determination of Uranium.

*Principle:* Uranium may be measured chemically by either colorimetry or fluorometry. In both procedures, the sample is dissolved, the uranium is oxidized to the hexavalent form and extracted into a suitable solvent. Impurities are removed from the solvent layer. For colorimetry, dibenzoylmethane is added, and the uranium is measured by the absorbance in a colorimeter. For fluorometry, a portion of the solution is fused with a sodium fluoride-lithium fluoride flux and the uranium is determined by the ultraviolet activated fluorescence of the fused disk in a fluorometer.

*Applicability:* This method is applicable to the measurements of emission rates of uranium when the isotopic ratio of the uranium radionuclides is well known. ASTM-E-318(15), ASTM-D-2907(14).

### 3.1.6 Method A-6, Radon-222—Continuous Gas Monitor.

*Principle:* Radon-222 is measured directly in a continuously extracted sample stream by passing the air stream through a calibrated scintillation cell. Prior to the scintillation cell, the air stream is treated to remove particulates and excess moisture. The alpha particles from radon-222 and its decay products strike a zinc sulfide coating on the inside of the scintillation cell producing light pulses. The light pulses

are detected by a photomultiplier tube which generates electrical pulses. These pulses are processed by the system electronics and the read out is in pCi/l of radon-222.

*Applicability:* This method is applicable to the measurement of radon-222 in effluent streams which do not contain significant quantities of radon-222. Users of this method should calibrate the monitor in a radon calibration chamber at least twice per year. The background of the monitor should also be checked periodically by operating the instrument in a low radon environment. EPA 520/1-89-009(24).

### 3.1.7 Method A-7, Radon-222-Alpha Track Detectors

*Principle:* Radon-222 is measured directly in the effluent stream using alpha track detectors (ATD). The alpha particles emitted by radon-222 and its decay products strike a small plastic strip and produce submicron damage tracks. The plastic strip is placed in a caustic solution that accentuates the damage tracks which are counted using a microscope or automatic counting system. The number of tracks per unit area is correlated to the radon concentration in air using a conversion factor derived from data generated in a radon calibration facility.

*Applicability:* Prior approval from EPA is required for use of this method. This method is only applicable to effluent streams which do not contain significant quantities of radon-222, unless special detectors are used to discriminate against radon-222. This method may be used only when ATDs have been demonstrated to produce data comparable to data obtained with Method A-6. Such data should be submitted to EPA when requesting approval for the use of this method. EPA 520/1-89-009(24).

## 3.2 Methods for Gaseous Beta Emitting Radionuclides.

### 3.2.1 Method B-1, Direct Counting in Flow-Through Ionization Chambers.

*Principle:* An ionization chamber containing a specific volume of gas which flows at a given flow rate through the chamber is used. The sample (effluent stream sample) acts as the counting gas for the chamber. The activity of the radionuclide is determined from the current measured in the ionization chamber.

*Applicability:* This method is applicable for measuring the activity of a gaseous beta-emitting radionuclide in an effluent stream that is suitable as a counting gas, when no other beta-emitting nuclides are present. DOE/EP-0096(17), NCRP-58(23).

### 3.2.2 Method B-2, Direct Counting With In-line or Off-line Beta Detectors.

*Principle:* The beta detector is placed directly in the effluent stream (in-line) or an extracted sample of the effluent stream is passed through a chamber containing a beta detector (off-line). The activities of the radionuclides present in the effluent stream are determined from the beta count rate, and a knowledge of the radionuclides present and the relationship of the gross beta count rate and the specific radionuclide concentration.

*Applicability:* This method is applicable only to radionuclides with maximum beta particle energies greater than 0.2 MeV. This method may be used to measure emissions of specific radionuclides only when it is known that the sample contains only a single radionuclide or the identity and isotopic ratio of the radionuclides in the effluent stream are well known. Specific radionuclide analysis of periodic grab samples may be used to identify the types and quantities of radionuclides present and to establish the relationship between specific radionuclide analyses and gross beta count rates.

This method is applicable to unidentified mixtures of gaseous radionuclides only for the purposes and under the conditions described in section 3.7.

### 3.3 Methods for Non-Gaseous Beta Emitting Radionuclides.

#### 3.3.1 Method B-3, Radiochemistry-Beta Counting.

*Principle:* The element of interest is separated from other elements, and from the sample matrix by radiochemistry. This may involve precipitation, distillation, ion exchange, or solvent extraction. Carriers (elements chemically similar to the element of interest) may be used. The element is deposited on a planchet, and counted with a beta counter. Corrections for chemical yield, and decay (if necessary) are made. The beta count rate determines the total activity of all radionuclides of the separated element. This method may also involve the radiochemical separation and counting of a daughter element, after a suitable period of ingrowth, in which case it is specific for the parent nuclide.

*Applicability:* This method is applicable for measuring the activity of any beta-emitting radionuclide, with a maximum energy greater than 0.2 MeV, provided no other radionuclide is present in the separated sample. APHA-608(5).

#### 3.3.2 Method B-4, Direct Beta Counting (Gross beta determination).

*Principle:* The sample, collected on a suitable filter, is counted with a beta counter. The sample must be thin enough so that self-absorption corrections can be made.

*Applicability:* Gross beta measurements are applicable only to radionuclides with maximum beta particle energies greater than 0.2 MeV. Gross beta measurements may be used to measure emissions of specific radionuclides only (1) when it is known that the sample contains only a single radionuclide, and (2) measurements made using Method B-3 show reasonable agreement with the gross beta measurement. Gross beta measurements are applicable to mixtures of radionuclides only for the purposes and under the conditions described in section 3.7. APHA-602(4), ASTM-D-1890(11).

#### 3.3.3 Method B-5, Liquid Scintillation Spectrometry.

*Principle:* An aliquot of a collected sample or the result of some other chemical separation or processing technique is added to a liquid scintillation "cocktail" which is viewed by photomultiplier tubes in a liquid scintillation spectrometer. The spectrometer is adjusted to establish a channel or "window" for the pulse energy appropriate to the nuclide of interest. The activity of the nuclide of interest is measured by the counting rate in the appropriate energy channel. Corrections are made for chemical yield where separations are made.

*Applicability:* This method is applicable to any beta-emitting nuclide when no other radionuclide is present in the sample or the separated sample provided that it can be incorporated in the scintillation cocktail. This method is also applicable for samples which contain more than one radionuclide but only when the energies of the beta particles are sufficiently separated so that they can be resolved by the spectrometer. This method is most applicable to the measurement of low-energy beta emitters such as tritium and carbon-14. APHA-609(6), EML-LV-539-17(19).

### 3.4 Gamma Emitting Radionuclides

#### 3.4.1 Method G-1, High Resolution Gamma Spectrometry.

*Principle:* The sample is counted with a high resolution gamma detector, usually either a Ge(Li) or a high purity Ge detector, connected to a multichannel analyzer or computer. The gamma emitting radionuclides in the sample are measured from the gamma count rates in the energy regions characteristic of the individual radionuclide. Corrections are made for counts contributed by other

radionuclides to the spectral regions of the radionuclides of interest. Radiochemical separations may be made prior to counting but are usually not necessary.

*Applicability:* This method is applicable to the measurement of any gamma emitting radionuclide with gamma energies greater than 20 keV. It can be applied to complex mixtures of radionuclides. The samples counted may be in the form of particulate filters, absorbers, liquids or gases. The method may also be applied to the analysis of gaseous gamma emitting radionuclides directly in an effluent stream by passing the stream through a chamber or cell containing the detector. ASTM-3649(9), IDO-12096(18).

#### 3.4.2 Method G-2, Low Resolution Gamma Spectrometry.

*Principle:* The sample is counted with a low resolution gamma detector, a thallium activated sodium iodide crystal. The detector is coupled to a photomultiplier tube and connected to a multichannel analyzer. The gamma emitting radionuclides in the sample are measured from the gamma count rates in the energy regions characteristic of the individual radionuclides. Corrections are made for counts contributed by other radionuclides to the spectral regions of the radionuclides of interest. Radiochemical separation may be used prior to counting to obtain less complex gamma spectra if needed.

*Applicability:* This method is applicable to the measurement of gamma emitting radionuclides with energies greater than 100 keV. It can be applied only to relatively simple mixtures of gamma emitting radionuclides. The samples counted may be in the form of particulate filters, absorbers, liquids or gas. The method can be applied to the analysis of gaseous radionuclides directly in an effluent stream by passing the gas stream through a chamber or cell containing the detector. ASTM-D-2459(12), EMSL-LV-0539-17(19).

#### 3.4.3 Method G-3, Single Channel Gamma Spectrometry.

*Principle:* The sample is counted with a thallium activated sodium iodide crystal. The detector is coupled to a photomultiplier tube connected to a single channel analyzer. The activity of a gamma emitting radionuclide is determined from the gamma counts in the energy range for which the counter is set.

*Applicability:* This method is applicable to the measurement of a single gamma emitting radionuclide. It is not applicable to mixtures of radionuclides. The samples counted may be in the form of particulate filters, absorbers, liquids or gas. The method can be applied to the analysis of gaseous radionuclides directly in an effluent stream by passing the gas stream through a chamber or cell containing the detector.

#### 3.4.4 Method G-4, Gross Gamma Counting.

*Principle:* The sample is counted with a gamma detector usually a thallium activated sodium iodine crystal. The detector is coupled to a photomultiplier tube and gamma rays above a specific threshold energy level are counted.

*Applicability:* Gross gamma measurements may be used to measure emissions of specific radionuclides only when it is known that the sample contains a single radionuclide or the identity and isotopic ratio of the radionuclides in the effluent stream are well known. When gross gamma measurements are used to determine emissions of specific radionuclides periodic measurements using Methods G-1 or G-2 should be made to demonstrate that the gross gamma measurements provide reliable emission data. This method may be applied to analysis of gaseous radionuclides directly in an effluent stream by placing the detector directly in or adjacent to the effluent stream or passing an extracted sample of the effluent stream through a chamber or cell containing the detector.

3.5 Counting Methods. All of the above methods with the exception of Method A-5 involve counting the radiation emitted by the radionuclide. Counting methods applicable to the measurement of alpha, beta and gamma radiations are listed below. The equipment needed and the counting principles involved are described in detail in ASTM-3648(8).

#### 3.5.1 Alpha Counting:

- *Gas Flow Proportional Counters.* The alpha particles cause ionization in the counting gas and the resulting electrical pulses are counted. These counters may be windowless or have very thin windows.
- *Scintillation Counters.* The alpha particles transfer energy to a scintillator resulting in a production of light photons which strike a photomultiplier tube converting the light photons to electrical pulses which are counted. The counters may involve the use of solid scintillation materials such as zinc sulfide or liquid scintillation solutions.
- *Solid-State Counters.* Semiconductor materials, such as silicon surface-barrier p-n junctions, act as solid ionization chambers. The alpha particles interact with the detector producing electron hole pairs. The charged pair is collected by an applied electrical field and the resulting electrical pulses are counted.
- *Alpha Spectrometers.* Semiconductor detectors used in conjunction with multichannel analyzers for energy discrimination.

#### 3.5.2 Beta Counting:

- *Ionization Chambers.* These chambers contain the beta-emitting nuclide in gaseous form. The ionization current produced is measured.
- *Geiger-Muller (GM) Counters-or Gas Flow Proportional Counters.* The beta particles cause ionization in the counting gas and the resulting electrical pulses are counted. Proportional gas flow counters which are heavily shielded by lead or other metal, and provided with an anti-coincidence shield to reject cosmic rays, are called low background beta counters.
- *Scintillation Counters.* The beta particles transfer energy to a scintillator resulting in a production of light photons, which strike a photomultiplier tube converting the light photon to electrical pulses which are counted. This may involve the use of anthracene crystals, plastic scintillator, or liquid scintillation solutions with organic phosphors.
- *Liquid Scintillation Spectrometers.* Liquid scintillation counters which use two photomultiplier tubes in coincidence to reduce background counts. This counter may also electronically discriminate among pulses of a given range of energy.

#### 3.5.3 Gamma Counting:

- *Low-Resolution Gamma Spectrometers.* The gamma rays interact with thallium activated sodium iodide or cesium iodide crystal resulting in the release of light photons which strike a photomultiplier tube converting the light pulses to electrical pulses proportional to the energy of the gamma ray. Multi-channel analyzers are used to separate and store the pulses according to the energy absorbed in the crystal.

- *High-Resolution gamma Spectrometers.* Gamma rays interact with a lithium-drifted (Ge(Li)) or high-purity germanium (HPGe) semiconductor detectors resulting in a production of electron-hole pairs. The charged pair is collected by an applied electrical field. A very stable low noise preamplifier amplifies the pulses of electrical charge resulting from the gamma photon interactions. Multichannel analyzers or computers are used to separate and store the pulses according to the energy absorbed in the crystal.

- *Single Channel Analyzers.* Thallium activated sodium iodide crystals used with a single window analyzer. Pulses from the photomultiplier tubes are separated in a single predetermined energy range.

3.5.4 Calibration of Counters. Counters are calibrated for specific radionuclide measurements using a standard of the radionuclide under either identical or very similar conditions as the sample to be counted. For gamma spectrometers a series of standards covering the energy range of interest may be used to construct a calibration curve relating gamma energy to counting efficiency.

In those cases where a standard is not available for a radionuclide, counters may be calibrated using a standard with energy characteristics as similar as possible to the radionuclide to be measured. For gross alpha and beta measurements of the unidentified mixtures of radionuclides, alpha counters are calibrated with a natural uranium standard and beta counters with a cesium-137 standard. The standard must contain the same weight and distribution of solids as the samples, and be mounted in an identical manner. If the samples contain variable amounts of solids, calibration curves relating weight of solids present to counting efficiency are prepared. Standards other than those prescribed may be used provided it can be shown that such standards are more applicable to the radionuclide mixture measured.

3.6 Radiochemical Methods for Selected Radionuclides. Methods for a selected list of radionuclides are listed in Table 1. The radionuclides listed are those which are most commonly used and which have the greatest potential for causing doses to members of the public. For radionuclides not listed in Table 1, methods based on any of the applicable “principles of measurement” described in section 3.1 through 3.4 may be used.

3.7 Applicability of Gross Alpha and Beta Measurements to Unidentified Mixtures of Radionuclides. Gross alpha and beta measurements may be used as a screening measurement as a part of an emission measurement program to identify the need to do specific radionuclide analyses or to confirm or verify that unexpected radionuclides are not being released in significant quantities.

Gross alpha (Method A-4) or gross beta (Methods B-2 or B-4) measurements may also be used for the purpose of comparing the measured concentrations in the effluent stream with the limiting “Concentration Levels for Environmental Compliance” in table 2 of appendix E. For unidentified mixtures, the measured concentration value shall be compared with the lowest environmental concentration limit for any radionuclide which is not known to be absent from the effluent stream.

**TABLE 1—LIST OF APPROVED METHODS FOR SPECIFIC RADIONUCLIDES**

| <b>Radionuclide</b> | <b>Approved methods of analysis</b> |
|---------------------|-------------------------------------|
| Am-241              | A-1, A-2, A-3, A-4                  |
| Ar-41               | B-1, B-2, G-1, G-2, G-3, G-4        |
| Ba-140              | G-1, G-2, G-3, G-4                  |
| Br-82               | G-1, G-2, G-3, G-4                  |
| C-11                | B-1, B-2, G-1, G-2, G-3, G-4        |

|                        |                                   |
|------------------------|-----------------------------------|
| C-14                   | B-5                               |
| Ca-45                  | B-3, B-4, B-5                     |
| Ce-144                 | G-1, G-2, G-3, G-4                |
| Cm-244                 | A-1, A-2, A-3, A-4                |
| Co-60                  | G-1, G-2, G-3, G-4                |
| Cr-51                  | G-1, G-2, G-3, G-4                |
| Cs-134                 | G-1, G-2, G-3, G-4                |
| Cs-137                 | G-1, G-2, G-3, G-4                |
| Fe-55                  | B-5, G-1                          |
| Fe-59                  | G-1, G-2, G-3, G-4                |
| Ga-67                  | G-1, G-2, G-3, G-4                |
| H-3 (H <sub>2</sub> O) | B-5                               |
| H-3 (gas)              | B-1                               |
| I-123                  | G-1, G-2, G-3, G-4                |
| I-125                  | G-1                               |
| I-131                  | G-1, G-2, G-3, G-4                |
| In-113m                | G-1, G-2, G-3, G-4                |
| Ir-192                 | G-1, G-2, G-3, G-4                |
| Kr-85                  | B-1, B-2, B-5, G-1, G-2, G-3, G-4 |
| Kr-87                  | B-1, B-2, G-1, G-2, G-3, G-4      |
| Kr-88                  | B-1, B-2, G-1, G-2, G-3, G-4      |
| Mn-54                  | G-1, G-2, G-3, G-4                |
| Mo-99                  | G-1, G-2, G-3, G-4                |
| N-13                   | B-1, B-2, G-1, G-2, G-3, G-4      |
| O-15                   | B-1, B-2, G-1, G-2, G-3, G-4      |
| P-32                   | B-3, B-4, B-5                     |
| Pm-147                 | B-3, B-4, B-5                     |
| Po-210                 | A-1, A-2, A-3, A-4                |
| Pu-238                 | A-1, A-2, A-3, A-4                |
| Pu-239                 | A-1, A-2, A-3, A-4                |

|                       |                    |
|-----------------------|--------------------|
| Pu-240                | A-1, A-2, A-3, A-4 |
| Ra-226                | A-1, A-2, G-1, G-2 |
| S-35                  | B-5                |
| Se-75                 | G-1, G-2, G-3, G-4 |
| Sr-90                 | B-3, B-4, B-5      |
| Tc-99                 | B-3, B-4, B-5      |
| Te-201                | G-1, G-2, G-3, G-4 |
| Uranium (total alpha) | A-1, A-2, A-3, A-4 |
| Uranium (Isotopic)    | A-1, A-3           |
| Uranium (Natural)     | A-5                |
| Xe-133                | G-1                |
| Yb-169                | G-1, G-2, G-3, G-4 |
| Zn-65                 | G-1, G-2, G-3, G-4 |

#### 4. Quality Assurance Methods

Each facility required to measure their radionuclide emissions shall conduct a quality assurance program in conjunction with the radionuclide emission measurements. This program shall assure that the emission measurements are representative, and are of known precision and accuracy and shall include administrative controls to assure prompt response when emission measurements indicate unexpectedly large emissions. The program shall consist of a system of policies, organizational responsibilities, written procedures, data quality specifications, audits, corrective actions and reports. This quality assurance program shall include the following program elements:

4.1 The organizational structure, functional responsibilities, levels of authority and lines of communications for all activities related to the emissions measurement program shall be identified and documented.

4.2 Administrative controls shall be prescribed to ensure prompt response in the event that emission levels increase due to unplanned operations.

4.3 The sample collection and analysis procedures used in measuring the emissions shall be described including where applicable:

4.3.1 Identification of sampling sites and number of sampling points, including the rationale for site selections.

4.3.2 A description of sampling probes and representativeness of the samples.

4.3.3 A description of any continuous monitoring system used to measure emissions, including the sensitivity of the system, calibration procedures and frequency of calibration.



4.3.4 A description of the sample collection systems for each radionuclide measured, including frequency of collection, calibration procedures and frequency of calibration.

4.3.5 A description of the laboratory analysis procedures used for each radionuclide measured, including frequency of analysis, calibration procedures and frequency of calibration.

4.3.6 A description of the sample flow rate measurement systems or procedures, including calibration procedures and frequency of calibration.

4.3.7 A description of the effluent flow rate measurement procedures, including frequency of measurements, calibration procedures and frequency of calibration.

4.4 The objectives of the quality assurance program shall be documented and shall state the required precision, accuracy and completeness of the emission measurement data including a description of the procedures used to assess these parameters. Accuracy is the degree of agreement of a measurement with a true or known value. Precision is a measure of the agreement among individual measurements of the same parameters under similar conditions. Completeness is a measure of the amount of valid data obtained compared to the amount expected under normal conditions.

4.5 A quality control program shall be established to evaluate and track the quality of the emissions measurement data against preset criteria. The program should include where applicable a system of replicates, spiked samples, split samples, blanks and control charts. The number and frequency of such quality control checks shall be identified.

4.6 A sample tracking system shall be established to provide for positive identification of samples and data through all phases of the sample collection, analysis and reporting system. Sample handling and preservation procedures shall be established to maintain the integrity of samples during collection, storage and analysis.

4.7 Regular maintenance, calibration and field checks shall be performed for each sampling system in use by satisfying the requirements found in Table 2: Maintenance, Calibration and Field Check Requirements.

**TABLE 2—MAINTENANCE, CALIBRATION AND FIELD CHECK REQUIREMENTS**

| <b>Sampling system components</b>   | <b>Frequency of activity</b>                                    |
|---|---|
| Cleaning of thermal anemometer elements   | As required by application.                                     |
| Inspect pitot tubes for contaminant deposits  | At least annually.  |
| Inspect pitot tube systems for leaks  | At least annually.  |
| Inspect sharp-edged nozzles for damage  | At least annually or after maintenance that could cause damage. |
| Check nozzles for alignment, presence of deposits, or other potentially degrading factors | Annually.   |
| Check transport lines of HEPA-filtered applications to determine if cleaning is           | Annually.   |

|  |  |
|--|--|
| required   |  |
| Clean transport lines  | Visible deposits for HEPA-filtered applications. Mean mass of deposited material exceeds 1g/m <sup>2</sup> for other applications. |
| Inspect or test the sample transport system for leaks                            | At least annually.   |
| Check mass flow meters of sampling systems with a secondary or transfer standard | At least quarterly.  |
| Inspect rotameters of sampling systems for presence of foreign matter            | At the start of each sampling period.  |
| Check response of stack flow rate systems  | At least quarterly.  |
| Calibration of flow meters of sampling systems                                   | At least annually.   |
| Calibration of effluent flow measurement devices                                 | At least annually.   |
| Calibration of timing devices  | At least annually.   |

4.8 Periodic internal and external audits shall be performed to monitor compliance with the quality assurance program. These audits shall be performed in accordance with written procedures and conducted by personnel who do not have responsibility for performing any of the operations being audited.

4.9 A corrective action program shall be established including criteria for when corrective action is needed, what corrective actions will be taken and who is responsible for taking the corrective action.

4.10 Periodic reports to responsible management shall be prepared on the performance of the emissions measurements program. These reports should include assessment of the quality of the data, results of audits and description of corrective actions.

4.11 The quality assurance program should be documented in a quality assurance project plan that should address each of the above requirements.

## 5. References

(1) American National Standards Institute "Guide to Sampling Airborne Radioactive Materials in Nuclear Facilities", ANSI-N13.1-1969, American National Standards Institute, New York, New York (1969).

(2) American Public Health Association, "Methods of Air Sampling", 2nd Edition, Method 605, "Tentative Method of Analysis for Plutonium Content of Atmospheric Particulate Matter". American Public Health Association, New York, NY (1977).

(3) Ibid, Method 601, "Tentative Method of Analysis for Gross Alpha Radioactivity Content of the Atmosphere".

(4) Ibid, Method 602, "Tentative Method of the Analysis for Gross Beta Radioactivity Content of the Atmosphere".

(5) Ibid, Method 608, "Tentative Method of Analysis for Strontium-90 Content of Atmospheric Particulate Matter".

(6) Ibid, Method 609, "Tentative Method of Analysis for Tritium Content of the Atmosphere".

(7) Ibid, Method 603, "Tentative Method of Analysis for Iodine-131 Content of the Atmosphere".

(8) American Society for Testing and Materials, 1986 Annual Book ASTM Standards, Designation D-3648-78, "Standard Practices for the Measurement of Radioactivity". American Society for Testing and Materials, Philadelphia, PA (1986).

(9) Ibid, Designation D-3649-85, "Standard Practice for High Resolution Gamma Spectrometry".

(10) Ibid, Designation D-1943-81, "Standard Test Method for Alpha Particle Radioactivity of Water".

(11) Ibid, Designation D-1890-81, "Standard Test Method for Beta Particle Radioactivity of Water".

(12) Ibid, Designation D-2459-72, "Standard Test Method for Gamma Spectrometry of Water".

(13) Ibid, Designation D-3972-82, "Standard Test Method for Isotopic Uranium in Water by Radiochemistry".

(14) Ibid, Designation D-2907-83, "Standard Test Methods for Microquantities of Uranium in Water by Fluorometry".

(15) Ibid, Designation E-318, "Standard Test Method for Uranium in Aqueous Solutions by Colorimetry".

(16) Ibid, Designation D-3084-75, "Standard Practice for Alpha Spectrometry of Water".

(17) Corley, J.P. and C.D. Corbit, "A Guide for Effluent Radiological Measurements at DOE Installations", DOE/EP-0096, Pacific Northwest Laboratories, Richland, Washington (1983).

(18) Department of Energy, "RESL Analytical Chemistry Branch Procedures Manual", IDO-12096, U.S. Department of Energy, Idaho Falls, Idaho (1982).

(19) Environmental Protection Agency, "Radiochemical Analytical Procedures for Analysis of Environmental Samples", EMSL-LV-0539-17, U.S. Environmental Protection Agency, Environmental Monitoring and Support Laboratory, Las Vegas, Nevada (1979).

(20) Environmental Protection Agency, "Radiochemistry Procedures Manual", EPA 520/5-84-006, Eastern Environmental Radiation Facility, Montgomery, Alabama (1984).

(21) National Council on Radiation Protection and Measurements, NCRP Report No. 50, "Environmental Radiation Measurements", National Council on Radiation Protection and Measurement, Bethesda, Maryland (1976).

(22) Ibid, Report No. 47, "Tritium Measurement Techniques". (1976).

(23) Ibid, Report No. 58 "A Handbook of Radioactivity Measurement Procedures" (1985).

(24) Environmental Protection Agency, "Indoor Radon and Radon Decay Product Measurement Protocols", EPA 520/1-89-009, U.S. Environmental Protection Agency, Washington, DC (1989).

#### METHOD 115—MONITORING FOR RADON-222 EMISSIONS

This appendix describes the monitoring methods which must be used in determining the radon-222 emissions from underground uranium mines, uranium mill tailings piles, phosphogypsum stacks, and other piles of waste material emitting radon.

### 1. Radon-222 Emissions from Underground Uranium Mine Vents

1.1 Sampling Frequency and Calculation of Emissions. Radon-222 emissions from underground uranium mine vents shall be determined using one of the following methods:

1.1.1 Continuous Measurement. These measurements shall be made and the emissions calculated as follows:

(a) The radon-222 concentration shall be continuously measured at each mine vent whenever the mine ventilation system is operational.

(b) Each mine vent exhaust flow rate shall be measured at least 4 times per year.

(c) A weekly radon-222 emission rate for the mine shall be calculated and recorded weekly as follows:

$$A_w = C_1 Q_1 T_1 + C_2 Q_2 T_2 + \dots + C_i Q_i T_i$$

Where:

$A_w$  = Total radon-222 emitted from the mine during week (Ci)

$C_i$  = Average radon-222 concentration in mine vent  $i$  (Ci/m<sup>3</sup>)

$Q_i$  = Volumetric flow rate from mine vent  $i$  (m<sup>3</sup>/hr)

$T_i$  = Hours of mine ventilation system operation during week for mine vent  $i$  (hr)

(d) The annual radon-222 emission rate is the sum of the weekly emission rates during a calendar year.

1.1.2 Periodic Measurement. This method is applicable only to mines that continuously operate their ventilation system except for extended shutdowns. Mines which start up and shut down their ventilation system frequently must use the continuous measurement method describe in Section 1.1.1 above. Emission rates determined using periodic measurements shall be measured and calculated as follows:

(a) The radon-222 shall be continuously measured at each mine vent for at least one week every three months.

(b) Each mine vent exhaust flow rate shall be measured at least once during each of the radon-222 measurement periods.

(c) A weekly radon-222 emission rate shall be calculated for each weekly period according to the method described in Section 1.1.1. In this calculation  $T = 168$  hr.

(d) The annual radon-222 emission rate from the mine should be calculated as follows:

$$A_y = \frac{52 - W_s}{n} (A_{w1} + A_{w2} + \dots + A_{wi})$$

Where:

$A_y$  = Annual radon-222 emission rate from the mine(Ci)

$A_{wi}$  = Weekly radon-222 emission rate during the measurement period  $i$  (Ci)

$n$  = Number of weekly measurement periods per year

$W_s$  = Number of weeks during the year that the mine ventilation system is shut down in excess of 7 consecutive days, i.e. the sum of the number of weeks each shut down exceeds 7 days

## 1.2 Test Methods and Procedures

Each underground mine required to test its emissions, unless an equivalent or alternative method has been approved by the Administrator, shall use the following test methods:

1.2.1 Test Method 1 of appendix A to part 60 shall be used to determine velocity traverses. The sampling point in the duct shall be either the centroid of the cross section or the point of average velocity.

1.2.2 Test Method 2 of appendix A to part 60 shall be used to determine velocity and volumetric flow rates.

1.2.3 Test Methods A-6 or A-7 of appendix B, Method 114 to part 61 shall be used for the analysis of radon-222. Use of Method A-7 requires prior approval of EPA based on conditions described in appendix B.

1.2.4 A quality assurance program shall be conducted in conformance with the programs described for Continuous Radon Monitors and Alpha Track Detectors in EPA 520/1-89-009. (2)

## 2. Radon-222 Emissions from Uranium Mill Tailings Piles

### 2.1 Measurement and Calculation of Radon Flux from Uranium Mill Tailings Piles.

2.1.1 Frequency of Flux Measurement. A single set of radon flux measurements may be made, or if the owner or operator chooses, more frequent measurements may be made over a one year period. These measurements may involve quarterly, monthly or weekly intervals. All radon measurements shall be made as described in paragraphs 2.1.2 through 2.1.6 except that for measurements made over a one year period, the requirement of paragraph 2.1.4(c) shall not apply. The mean radon flux from the pile shall be the arithmetic mean of the mean radon flux for each measurement period. The weather conditions, moisture content of the tailings and area of the pile covered by water existing at the time of the measurement shall be chosen so as to provide measurements representative of the long term radon flux from the pile and shall be subject to EPA review and approval.

2.1.2 Distribution of Flux Measurements. The distribution and number of radon flux measurements required on a pile will depend on clearly defined areas of the pile (called regions) that can have

significantly different radon fluxes due to surface conditions. The mean radon flux shall be determined for each individual region of the pile. Regions that shall be considered for operating mill tailings piles are:

- (a) Water covered areas,
- (b) Water saturated areas (beaches),
- (c) Dry top surface areas, and
- (d) Sides, except where earthen material is used in dam construction.

For mill tailings after disposal the pile shall be considered to consist of only one region.

2.1.3 Number of Flux Measurements. Radon flux measurements shall be made within each region on the pile, except for those areas covered with water. Measurements shall be made at regularly spaced locations across the surface of the region, realizing that surface roughness will prohibit measurements in some areas of a region. The minimum number of flux measurements considered necessary to determine a representative mean radon flux value for each type of region on an operating pile is:

- (a) Water covered area—no measurements required as radon flux is assumed to be zero,
- (b) Water saturated beaches—100 radon flux measurements,
- (c) Loose and dry top surface—100 radon flux measurements,
- (d) Sides—100 radon flux measurements, except where earthen material is used in dam construction.

For a mill tailings pile after disposal which consists of only one region a minimum of 100 measurements are required.

2.1.4 Restrictions to Radon Flux Measurements. The following restrictions are placed on making radon flux measurements:

- (a) Measurements shall not be initiated within 24 hours of a rainfall.
- (b) If a rainfall occurs during the 24 hour measurements period, the measurement is invalid if the seal around the lip of the collector has washed away or if the collector is surrounded by water.
- (c) Measurements shall not be performed if the ambient temperature is below 35 °F or if the ground is frozen.

2.1.5 Areas of Pile Regions. The approximate area of each region of the pile shall be determined in units of square meters.

2.1.6 Radon Flux Measurement. Measuring radon flux involves the adsorption of radon on activated charcoal in a large-area collector. The radon collector is placed on the surface of the pile area to be measured and allowed to collect radon for a time period of 24 hours. The radon collected on the charcoal is measured by gamma-ray spectroscopy. The detailed measurement procedure provided in appendix A of EPA 520/5-85-0029(1) shall be used to measure the radon flux on uranium mill tailings, except the surface of the tailings shall not be penetrated by the lip of the radon collector as directed in the procedure, rather the collector shall be carefully positioned on a flat surface with soil or tailings used to seal the edge.

2.1.7 Calculations. The mean radon flux for each region of the pile and for the total pile shall be calculated and reported as follows:

(a) The individual radon flux calculations shall be made as provided in appendix A EPA 86 (1). The mean radon flux for each region of the pile shall be calculated by summing all individual flux measurements for the region and dividing by the total number of flux measurements for the region.

(b) The mean radon flux for the total uranium mill tailings pile shall be calculated as follows.

$$J_s = \frac{J_1 A_1 + \dots + J_2 A_2 + \dots + J_i A_i}{A_t}$$

Where:

$J_s$  = Mean flux for the total pile (pCi/m<sup>2</sup>-s)

$J_i$  = Mean flux measured in region i (pCi/m<sup>2</sup>-s)

$A_i$  = Area of region i (m<sup>2</sup>)

$A_t$  = Total area of the pile (m<sup>2</sup>)

2.1.8 Reporting. The results of individual flux measurements, the approximate locations on the pile, and the mean radon flux for each region and the mean radon flux for the total stack shall be included in the emission test report. Any condition or unusual event that occurred during the measurements that could significantly affect the results should be reported.

### 3.0 Radon-222 Emissions from Phosphogypsum Stacks.

3.1 Measurement and Calculation of the Mean Radon Flux. Radon flux measurements shall be made on phosphogypsum stacks as described below:

3.1.1 Frequency of Measurements. A single set of radon flux measurements may be made after the phosphogypsum stack becomes inactive, or if the owner or operator chooses, more frequent measurements may be made over a one year period. These measurements may involve quarterly, monthly or weekly intervals. All radon measurements shall be made as described in paragraphs 3.1.2 through 3.1.6 except that for measurements made over a one year period, the requirement of paragraph 3.1.4(c) shall not apply. For measurements made over a one year period, the radon flux shall be the arithmetic mean of the mean radon flux for each measurement period.

3.1.2 Distribution and Number of Flux Measurements. The distribution and number of radon flux measurements required on a stack will depend on clearly defined areas of the stack (called regions) that can have significantly different radon fluxes due to surface conditions. The mean radon flux shall be determined for each individual region of the stack. Regions that shall be considered are:

- (a) Water covered areas,
- (b) Water saturated areas (beaches),
- (c) Loose and dry top surface areas,
- (d) Hard-packed roadways, and
- (e) Sides.

3.1.3 Number of Flux Measurements. Radon flux measurements shall be made within each region on the phosphogypsum stack, except for those areas covered with water. Measurements shall be made at regularly spaced locations across the surface of the region, realizing that surface roughness will prohibit measurements in some areas of a region. The minimum number of flux measurements considered necessary to determine a representative mean radon flux value for each type of region is:

- (a) Water covered area—no measurements required as radon flux is assumed to be zero,
- (b) Water saturated beaches—50 radon flux measurements,
- (c) Loose and dry top surface—100 radon flux measurements,
- (d) Hard-packed roadways—50 radon flux measurements, and
- (e) Sides—100 radon flux measurements.

A minimum of 300 measurements are required. A stack that has no water cover can be considered to consist of two regions, top and sides, and will require a minimum of only 200 measurements.

3.1.4 Restrictions to Radon Flux Measurements. The following restrictions are placed on making radon flux measurements:

- (a) Measurements shall not be initiated within 24 hours of a rainfall.
- (b) If a rainfall occurs during the 24 hour measurement period, the measurement is invalid if the seal around the lip of the collector has washed away or if the collector is surrounded by water.
- (c) Measurements shall not be performed if the ambient temperature is below 35 °F or if the ground is frozen.

3.1.5 Areas of Stack Regions. The approximate area of each region of the stack shall be determined in units of square meters.

3.1.6 Radon Flux Measurements. Measuring radon flux involves the adsorption of radon on activated charcoal in a large-area collector. The radon collector is placed on the surface of the stack area to be measured and allowed to collect radon for a time period of 24 hours. The radon collected on the charcoal is measured by gamma-ray spectroscopy. The detailed measurement procedure provided in appendix A of EPA 520/5-85-0029(1) shall be used to measure the radon flux on phosphogypsum stacks, except the surface of the phosphogypsum shall not be penetrated by the lip of the radon collector as directed in the procedure, rather the collector shall be carefully positioned on a flat surface with soil or phosphogypsum used to seal the edge.

3.1.7 Calculations. The mean radon flux for each region of the phosphogypsum stack and for the total stack shall be calculated and reported as follows:

- (a) The individual radon flux calculations shall be made as provided in appendix A EPA 86 (1). The mean radon flux for each region of the stack shall be calculated by summing all individual flux measurements for the region and dividing by the total number of flux measurements for the region.
- (b) The mean radon flux for the total phosphogypsum stack shall be calculated as follows.

$$J_s = \frac{J_1 A_1 + J_2 A_2 + \dots + J_n A_n}{A_t}$$

Where:



$J_s$  = Mean flux for the total stack (pCi/m<sup>2</sup>-s)

$J_i$  = Mean flux measured in region i (pCi/m<sup>2</sup>-s)

$A_i$  = Area of region i (m<sup>2</sup>)

$A_t$  = Total area of the stack

3.1.8 Reporting. The results of individual flux measurements, the approximate locations on the stack, and the mean radon flux for each region and the mean radon flux for the total stack shall be included in the emission test report. Any condition or unusual event that occurred during the measurements that could significantly affect the results should be reported.

#### 4.0 Quality Assurance Procedures for Measuring Rn-222 Flux

##### A. SAMPLING PROCEDURES

Records of field activities and laboratory measurements shall be maintained. The following information shall be recorded for each charcoal canister measurement:

- (a) Site
- (b) Name of pile
- (c) Sample location
- (d) Sample ID number
- (e) Date and time on
- (f) Date and time off
- (g) Observations of meteorological conditions and comments

Records shall include all applicable information associated with determining the sample measurement, calculations, observations, and comments.

##### B. SAMPLE CUSTODY

Custodial control of all charcoal samples exposed in the field shall be maintained in accordance with EPA chain-of-custody field procedures. A control record shall document all custody changes that occur between the field and laboratory personnel.

##### C. CALIBRATION PROCEDURES AND FREQUENCY

The radioactivity of two standard charcoal sources, each containing a carefully determined quantity of radium-226 uniformly distributed through 180g of activated charcoal, shall be measured. An efficiency factor is computed by dividing the average measured radioactivity of the two standard charcoal sources, minus the background, in cpm by the known radioactivity of the charcoal sources in dpm. The same two standard charcoal sources shall be counted at the beginning and at the end of each day's counting as a check of the radioactivity counting equipment. A background count using unexposed charcoal should also be made at the beginning and at the end of each counting day to check for inadvertent contamination of the detector or other changes affecting the background. The unexposed charcoal comprising the blank is changed with each new batch of charcoal used.

#### D. INTERNAL QUALITY CONTROL CHECKS AND FREQUENCY

The charcoal from every tenth exposed canister shall be recounted. Five percent of the samples analyzed shall be either blanks (charcoal having no radioactivity added) or samples spiked with known quantities of radium-226.

#### E. DATA PRECISION, ACCURACY, AND COMPLETENESS

The precision, accuracy, and completeness of measurements and analyses shall be within the following limits for samples measuring greater than 1.0 pCi/m<sup>2</sup>-s.

- (a) Precision: 10%
- (b) Accuracy:  $\pm 10\%$
- (c) Completeness: at least 85% of the measurements must yield useable results.

#### 5.0 REFERENCES

(1) Hartley, J.N. and Freeman, H.D., "Radon Flux Measurements on Gardinier and Royster phosphogypsum Piles Near Tampa and Mulberry, Florida," U.S. Environmental Protection Agency Report, EPA 520/5-85-029, January 1986.

(2) Environmental Protection Agency, "Indoor Radon and Radon Decay Product Measurement Protocols", EPA 520/1-89-009, U.S. Environmental Protection Agency, Washington, DC. (1989).

[38 FR 8826, Apr. 6, 1973]

EDITORIAL NOTES: 1. For FEDERAL REGISTER citations affecting appendix B, see the List of CFR Sections Affected, which appears in the Finding Aids section of the printed volume and at [www.fdsys.gov](http://www.fdsys.gov).

2. At 65 FR 62161, Oct. 17, 2000, appendix B to part 61 was amended by revising Methods 101, 101A, 102, 103, 104, 105, 106, 107, 107A, 108, 108A, 108B, 108C, and 111. However, because the amendment contains no revised text for Method 107A, this part of the revision could not be incorporated.

#### **Appendix C to Part 61—Quality Assurance Procedures**

##### *Procedure 1—Determination of Adequate Chromatographic Peak Resolution*

In this method of dealing with resolution, the extent to which one chromatographic peak overlaps another is determined.

For convenience, consider the range of the elution curve of each compound as running from  $-2\sigma$  to  $+2\sigma$ . This range is used in other resolution criteria, and it contains 95.45 percent of the area of a normal curve. If two peaks are separated by a known distance,  $b$ , one can determine the fraction of the area of one curve that lies within the range of the other. The extent to which the elution curve of a contaminant compound overlaps the curve of a compound that is under analysis is found by integrating the contaminant curve over the limits  $b-2\sigma_s$  to  $b+2\sigma_s$ , where  $\sigma_s$  is the standard deviation of the sample curve.

This calculation can be simplified in several ways. Overlap can be determined for curves of unit area; then actual areas can be introduced. Desired integration can be resolved into two integrals of the normal distribution function for which there are convenient calculation programs and tables. An example

would be Program 15 in Texas Instruments Program Manual ST1, 1975, Texas Instruments, Inc., Dallas, Texas 75222.

$$\frac{1}{\sqrt{2\pi}\sigma_c} \int_{b-2\sigma_s}^{b+2\sigma_s} e^{-\frac{t^2}{2\sigma_c^2}} dt = \frac{1}{\sqrt{2\pi}} \int_{\frac{b-2\sigma_s}{\sigma_c}}^{\frac{b+2\sigma_s}{\sigma_c}} e^{-\frac{x^2}{2}} dx - \frac{1}{\sqrt{2\pi}} \int_{\frac{b+2\sigma_s}{\sigma_c}}^{\infty} e^{-\frac{x^2}{2}} dx$$

The following calculation steps are required:\*

1.  $2\sigma_s = t_s / \sqrt{2 \ln 2}$

2.  $\sigma_c = t_c / \sqrt{2 \ln 2}$

3.  $x_1 = (b-2\sigma_s)/\sigma_c$

4.  $x_2 = (b+2\sigma_s)/\sigma_c$

5.  $Q(x_1) = \frac{1}{\sqrt{2\pi}} \int_{x_1}^{\infty} e^{-\frac{x^2}{2}} dx$

6.  $Q(x_2) = \frac{1}{\sqrt{2\pi}} \int_{x_2}^{\infty} e^{-\frac{x^2}{2}} dx$

7.  $I_o = Q(x_1) - Q(x_2)$

8.  $A_o = I_o A_s / A_c$

9. Percentage overlap =  $A_o \times 100$ .

where:

$A_s$  = Area of the sample peak of interest determined by electronic integration or by the formula  $A_s = h_s t_s$ .

$A_c$  = Area of the contaminant peak, determined in the same manner as  $A_s$ .

$b$  = Distance on the chromatographic chart that separates the maxima of the two peaks.

$h_s$  = Peak height of the sample compound of interest, measured from the average value of the baseline to the maximum of the curve.

$t_s$  = Width of sample peak of interest at 1/2 peak height.

$t_c$  = Width of the contaminant peak at 1/2 of peak height.

$\sigma_s$  = Standard deviation of the sample compound of interest elution curve.

$\sigma_c$  = Standard deviation of the contaminant elution curve.

$Q(x_1)$  = Integral of the normal distribution function from  $x_1$  to infinity.

$Q(x_2)$  = Integral of the normal distribution function from  $x_2$  to infinity.

$I_o$  = Overlap integral.

$A_o$  = Area overlap fraction.

\*In most instances,  $Q(x_2)$  is very small and may be neglected.

In judging the suitability of alternate GC columns or the effects of altering chromatographic conditions, one can employ the area overlap as the resolution parameter with a specific maximum permissible value.

The use of Gaussian functions to describe chromatographic elution curves is widespread. However, some elution curves are highly asymmetric. In cases where the sample peak is followed by a contaminant that has a leading edge that rises sharply but the curve then tails off, it may be possible to define an effective width for  $t_c$  as "twice the distance from the leading edge to a perpendicular line through the maxim of the contaminant curve, measured along a perpendicular bisection of that line."

### Procedure 2—Procedure for Field Auditing GC Analysis

Responsibilities of audit supervisor and analyst at the source sampling site include the following:

A. The audit supervisor verifies that audit cylinders are stored in a safe location both before and after the audit to prevent vandalism.

B. At the beginning and conclusion of the audit, the analyst records each cylinder number and pressure. An audit cylinder is never analyzed when the pressure drops below 200 psi.

C. During the audit, the analyst performs a minimum of two consecutive analyses of each audit cylinder gas. The audit must be conducted to coincide with the analysis of source test samples, normally immediately after GC calibration and prior to sample analyses.

D. At the end of audit analyses, the audit supervisor requests the calculated concentrations from the analyst and compares the results with the actual audit concentrations. If each measured concentration agrees with the respective actual concentration within  $\pm 10$  percent, he directs the analyst to begin analyzing source samples. Audit supervisor judgment and/or supervisory policy determine action when agreement is not within  $\pm 10$  percent. When a consistent bias in excess of 10 percent is found, it may be possible to proceed with the sample analysis, with a corrective factor to be applied to the results at a later time. However, every attempt should be made to locate the cause of the discrepancy, as it may be misleading. The audit supervisor records each cylinder number, cylinder pressure (at the end of the audit), and all calculated concentrations. The individual being audited must not under any circumstance be told actual audit concentrations until calculated concentrations have been submitted to the audit supervisor.

#### FIELD AUDIT REPORT

*Part A*— To be filled out by organization supplying audit cylinders.

1. Organization supplying audit sample(s) and shipping address

2. Audit supervisor, organization, and phone number

3. Shipping instructions: Name, Address, Attention

4. Guaranteed arrival date for cylinders

5. Planned shipping date for cylinders

6. Details on audit cylinders from last analysis

|                              | <b>Low conc.</b> | <b>High conc.</b> |
|------------------------------|------------------|-------------------|
| a. Date of last analysis     |                  |                   |
| b. Cylinder number           |                  |                   |
| c. Cylinder pressure, psi    |                  |                   |
| d. Audit gas(es)/balance gas |                  |                   |
| e. Audit gas(es), ppm        |                  |                   |

|                          |  |  |
|--------------------------|--|--|
| f. Cylinder construction |  |  |
|--------------------------|--|--|

Part B—To be filled out by audit supervisor.

1. Process sampled
2. Audit location
3. Name of individual audit
4. Audit date

5. Audit results:

|   | Low conc.<br>cylinder | High conc.<br>cylinder |
|---|-----------------------|------------------------|
| a. Cylinder number  |                       |                        |
| b. Cylinder pressure before audit, psi                                |                       |                        |
| c. Cylinder pressure after audit, psi                                 |                       |                        |
| d. Measured concentration, ppm Injection #1* Injection #2*<br>Average |                       |                        |
| e. Actual audit concentration, ppm (Part A, 6e)                       |                       |                        |
| f. Audit accuracy: <sup>1</sup>                                       |                       |                        |
| Low Conc. Cylinder  |                       |                        |
| High Conc. Cylinder   |                       |                        |
| Percent <sup>1</sup> accuracy=  |                       |                        |
| Measured Conc. – Actual Conc.   |                       |                        |
| _____ × 100   |                       |                        |
| Actual Conc.  |                       |                        |
| g. Problems detected (if any)   |                       |                        |

<sup>1</sup>Results of two consecutive injections that meet the sample analysis criteria of the test method.

[47 FR 39178, Sept. 7, 1982]

## Appendix D to Part 61—Methods for Estimating Radionuclide Emissions

### 1. Purpose and Background

Facility owners or operators may estimate radionuclide emissions to the atmosphere for dose calculations instead of measuring emissions. Particulate emissions from mill tailings piles should be

estimated using the procedures listed in reference re #2. All other emissions may be estimated by using the "Procedures" listed below, or using the method described in reference #1.

## 2. Procedure

To estimate emissions to the atmosphere:

(a) Determine the amount (in curies) used at facilities for the period under consideration. Radioactive materials in sealed packages that remain unopened, and have not leaked during the assessment period should not be included in the calculation.

(b) Multiply the amount used by the following factors which depend on the physical state of the radionuclide. They are:

- (i) 1 for gases;
- (ii)  $10^{-3}$  for liquids or particulate solids; and
- (iii)  $10^{-6}$  for solids.

If any nuclide is heated to a temperature of 100 degrees Celsius or more, boils at a temperature of 100 degrees Celsius or less, or is intentionally dispersed into the environment, it must be considered to be a gas.

(c) If a control device is installed between the place of use and the point of release, multiply emissions from (b) by an adjustment factor. These are presented in Table 1.

**TABLE 1—ADJUSTMENT TO EMISSION FACTORS FOR EFFLUENT CONTROLS**

| <b>Controls</b>                                 | <b>Types of radionuclides controlled</b> | <b>Adjustment factor to emissions</b> | <b>Comments and conditions</b>  |
|---|--|---------------------------------------|---|
| HEPA filters                                    | Particulates                             | 0.01                                  | Not applicable to gaseous radionuclides; periodic testing is prudent to ensure high removal efficiency. |
| Fabric filter                                   | Particulates                             | 0.1                                   | Monitoring would be prudent to guard against tears in filter.   |
| Sintered metal                                  | Particulates                             | 1                                     | Insufficient data to make recommendation.   |
| Activated carbon filters                        | Iodine gas                               | 0.1                                   | Efficiency is time dependent; monitoring is necessary to ensure effectiveness.                          |
| Douglas bags: Held one week or longer for decay | Xenon                                    | 0.5/wk                                | Based on xenon half-life of 5.3 days;   |

|   |                       |           |   |
|---|-----------------------|-----------|---|
| Douglas bags:<br>Released within one week | Xenon                 | 1         | Provides no reduction of exposure to general public.  |
| Venturi scrubbers                         | Particulates<br>Gases | 0.05<br>1 | Although venturis may remove gases, variability in gaseous removal efficiency dictates adjustment factor for particulates only. |
| Packed bed scrubbers                      | Gases                 | 0.1       | Not applicable to particulates.   |
| Electrostatic precipitators               | Particulates          | 0.05      | Not applicable for gaseous radionuclides  |
| Xenon traps                               | Xenon                 | 0.1       | Efficiency is time dependent; monitoring is necessary to ensure effectiveness.  |
| Fume hoods                                | All                   | 1         | Provides no reduction to general public exposures.  |
| Vent stacks                               | All                   | 1         | Generally provides no reduction of exposure to general public.  |

#### *References*

(1) Environmental Protection Agency, "A Guide for Determining Compliance with the Clean Air Act Standards for Radionuclides Emissions from NRC-Licensed and Non-DOE Federal Facilities", EPA 520/1-89-002, January 1989.

(2) Nuclear Regulatory Commission, "Methods for Estimating Radioactive and Toxic Airborne Source Terms for Uranium Milling Operations", U.S. Nuclear Regulatory Commission Regulatory Guide 3.59, March 1987.

[54 FR 51711, Dec. 15, 1989]

### **Appendix E to Part 61—Compliance Procedures Methods for Determining Compliance With Subpart I**

#### *1. Purpose and Background*

This Appendix provides simplified procedures to reduce the burden on Nuclear Regulatory Commission (NRC) licensees, and non-Department of Energy Federal facilities in determining compliance with 40 CFR part 61, subpart I. The procedures consist of a series of increasingly more stringent steps, depending on the facility's potential to exceed the standard.

First, a facility can be found in compliance if the quantity of radioactive material possessed during the year is less than that listed in a table of annual possession quantities. A facility will also be in compliance if the average annual radionuclide emission concentration is less than that listed in a table of air concentration levels. If the facility is not in compliance by these tables, it can establish compliance by estimating a dose using screening procedure developed by the National Council on Radiation Protection and Measurements with a radiological source term derived using EPA approved emission factors. These

procedures are described in a “Guide for Determining Compliance with the Clean Air Act Standards for Radionuclide Emissions From NRC-Licensed and Non-DOE Federal Facilities.”

A user-friendly computer program called COMPLY has been developed to reduce the burden on the regulated community. The Agency has also prepared a “User's Guide for the COMPLY Code” to assist the regulated community in using the code, and in handling more complex situations such as multiple release points. The basis for these compliance procedures are provided in “Background Information Document: Procedures Approved for Demonstrating Compliance with 40 CFR Part 61, Subpart I”. The compliance model is the highest level in the COMPLY computer code and provides for the most realistic assessment of dose by allowing the use of site-specific information.

## 2. Table of Annual Possession Quantity

(a) Table 1 may be used for determining if facilities are in compliance with the standard. The possession table can only be used if the following conditions are met:

- (i) No person lives within 10 meters of any release point; and
- (ii) No milk, meat, or vegetables are produced within 100 meters of any release point.

(b) Procedures described in Reference (1) shall be used to determine compliance or exemption from reporting by use of Table 2.

**TABLE 1—ANNUAL POSSESSION QUANTITIES FOR ENVIRONMENTAL COMPLIANCE**

[Annual Possession Quantities (Ci/yr)]

| <b>Radionuclide</b> | <b>Gaseous form*</b> | <b>Liquid/powder forms</b> | <b>Solid form*</b> |
|---------------------|----------------------|----------------------------|--------------------|
| Ac-225              | 9.6E-05              | 9.6E-02                    | 9.6E + 01          |
| Ac-227              | 1.6E-07              | 1.6E-04                    | 1.6E-01            |
| Ac-228              | 3.4E-03              | 3.4E + 00                  | 3.4E + 03          |
| Ag-106              | 1.6E + 00            | 1.6E + 03                  | 1.6E + 06          |
| Ag-106m             | 2.6E-03              | 2.6E + 00                  | 2.6E + 03          |
| Ag-108m             | 6.5E-06              | 6.5E-03                    | 6.5E + 00          |
| Ag-110m             | 9.4E-05              | 9.4E-02                    | 9.4E + 01          |
| Ag-111              | 6.7E-02              | 6.7E + 01                  | 6.7E + 04          |
| Al-26               | 4.0E-06              | 4.0E-03                    | 4.0E + 00          |
| Am-241              | 2.3E-06              | 2.3E-03                    | 2.3E + 00          |
| Am-242              | 1.8E-02              | 1.8E + 01                  | 1.8E + 04          |
| Am-242m             | 2.5E-06              | 2.5E-03                    | 2.5E + 00          |
| Am-243              | 2.3E-06              | 2.3E-03                    | 2.3E + 00          |



|         |           |           |           |
|---------|-----------|-----------|-----------|
| Am-244  | 4.6E-02   | 4.6E + 01 | 4.6E + 04 |
| Am-245  | 7.0E + 00 | 7.0E + 03 | 7.0E + 06 |
| Am-246  | 9.8E-01   | 9.8E + 02 | 9.8E + 05 |
| Ar-37   | 1.4E + 06 |           |           |
| Ar-41   | 1.4E + 00 |           |           |
| As-72   | 2.9E-02   | 2.9E + 01 | 2.9E + 04 |
| As-73   | 6.0E-02   | 6.0E + 01 | 6.0E + 04 |
| As-74   | 4.3E-03   | 4.3E + 00 | 4.3E + 03 |
| As-76   | 8.8E-02   | 8.8E + 01 | 8.8E + 04 |
| As-77   | 7.9E-01   | 7.9E + 02 | 7.9E + 05 |
| At-211  | 1.0E-02   | 1.0E + 01 | 1.0E + 04 |
| Au-193  | 4.2E-01   | 4.2E + 02 | 4.2E + 05 |
| Au-194  | 3.5E-02   | 3.5E + 01 | 3.5E + 04 |
| Au-195  | 3.3E-03   | 3.3E + 00 | 3.3E + 03 |
| Au-198  | 4.6E-02   | 4.6E + 01 | 4.6E + 04 |
| Au-199  | 1.5E-01   | 1.5E + 02 | 1.5E + 05 |
| Ba-131  | 1.0E-02   | 1.0E + 01 | 1.0E + 04 |
| Ba-133  | 4.9E-05   | 4.9E-02   | 4.9E + 01 |
| Ba-133m | 9.3E-02   | 9.3E + 01 | 9.3E + 04 |
| Ba-135m | 5.8E-01   | 5.8E + 02 | 5.8E + 05 |
| Ba-139  | 4.7E + 00 | 4.7E + 03 | 4.7E + 06 |
| Ba-140  | 2.1E-03   | 2.1E + 00 | 2.1E + 03 |
| Ba-141  | 1.3E + 00 | 1.3E + 03 | 1.3E + 06 |
| Ba-142  | 1.1E + 00 | 1.1E + 03 | 1.1E + 06 |
| Be-7    | 2.3E-02   | 2.3E + 01 | 2.3E + 04 |
| Be-10   | 3.0E-03   | 3.0E + 00 | 3.0E + 03 |
| Bi-206  | 3.1E-03   | 3.1E + 00 | 3.1E + 03 |
| Bi-207  | 8.4E-06   | 8.4E-03   | 8.4E + 00 |
| Bi-210  | 4.2E-03   | 4.2E + 00 | 4.2E + 03 |
| Bi-212  | 4.7E-02   | 4.7E + 01 | 4.7E + 04 |

|         |           |           |           |
|---------|-----------|-----------|-----------|
| Bi-213  | 6.0E-02   | 6.0E + 01 | 6.0E + 04 |
| Bi-214  | 1.4E-01   | 1.4E + 02 | 1.4E + 05 |
| Bk-249  | 7.0E-04   | 7.0E-01   | 7.0E + 02 |
| Bk-250  | 1.0E-01   | 1.0E + 02 | 1.0E + 05 |
| Br-77   | 7.5E-02   | 7.5E + 01 | 7.5E + 04 |
| Br-80   | 1.2E + 01 | 1.2E + 04 | 1.2E + 07 |
| Br-80m  | 1.5E + 00 | 1.5E + 03 | 1.5E + 06 |
| Br-82   | 1.6E-02   | 1.6E + 01 | 1.6E + 04 |
| Br-83   | 9.9E + 00 | 9.9E + 03 | 9.9E + 06 |
| Br-84   | 5.6E-01   | 5.6E + 02 | 5.6E + 05 |
| C-11    | 1.3E + 00 | 1.3E + 03 | 1.3E + 06 |
| C-14    | 2.9E-01   | 2.9E + 02 | 2.9E + 05 |
| Ca-41   | 2.7E-02   | 2.7E + 01 | 2.7E + 04 |
| Ca-45   | 5.8E-02   | 5.8E + 01 | 5.8E + 04 |
| Ca-47   | 1.1E-02   | 1.1E + 01 | 1.1E + 04 |
| Cd-109  | 5.0E-03   | 5.0E + 00 | 5.0E + 03 |
| Cd-113  | 3.3E-04   | 3.3E-01   | 3.3E + 02 |
| Cd-113m | 4.4E-04   | 4.4E-01   | 4.4E + 02 |
| Cd-115  | 5.4E-02   | 5.4E + 01 | 5.4E + 04 |
| Cd-115m | 1.0E-02   | 1.0E + 01 | 1.0E + 04 |
| Cd-117  | 5.6E-02   | 5.6E + 01 | 5.6E + 04 |
| Cd-117m | 1.3E-01   | 1.3E + 02 | 1.3E + 05 |
| Ce-139  | 2.6E-03   | 2.6E + 00 | 2.6E + 03 |
| Ce-141  | 1.8E-02   | 1.8E + 01 | 1.8E + 04 |
| Ce-143  | 1.0E-01   | 1.0E + 02 | 1.0E + 05 |
| Ce-144  | 1.7E-03   | 1.7E + 00 | 1.7E + 03 |
| Cf-248  | 2.0E-05   | 2.0E-02   | 2.0E + 01 |
| Cf-249  | 1.7E-06   | 1.7E-03   | 1.7E + 00 |
| Cf-250  | 4.0E-06   | 4.0E-03   | 4.0E + 00 |
| Cf-251  | 1.7E-06   | 1.7E-03   | 1.7E + 00 |

|         |           |           |           |
|---------|-----------|-----------|-----------|
| Cf-252  | 6.4E-06   | 6.4E-03   | 6.4E + 00 |
| Cf-253  | 3.3E-04   | 3.3E-01   | 3.3E + 02 |
| Cf-254  | 3.6E-06   | 3.6E-03   | 3.6E + 00 |
| Cl-36   | 1.9E-04   | 1.9E-01   | 1.9E + 02 |
| Cl-38   | 6.5E-01   | 6.5E + 02 | 6.5E + 05 |
| Cm-242  | 6.0E-05   | 6.0E-02   | 6.0E + 01 |
| Cm-243  | 3.3E-06   | 3.3E-03   | 3.3E + 00 |
| Cm-244  | 4.2E-06   | 4.2E-03   | 4.2E + 00 |
| Cm-245  | 2.3E-06   | 2.3E-03   | 2.3E + 00 |
| Cm-246  | 2.3E-06   | 2.3E-03   | 2.3E + 00 |
| Cm-247  | 2.3E-06   | 2.3E-03   | 2.3E + 00 |
| Cm-248  | 6.4E-07   | 6.4E-04   | 6.4E-01   |
| Cm-249  | 4.6E + 00 | 4.6E + 03 | 4.6E + 06 |
| Cm-250  | 1.1E-07   | 1.1E-04   | 1.1E-01   |
| Co-56   | 2.4E-04   | 2.4E-01   | 2.4E + 02 |
| Co-57   | 1.6E-03   | 1.6E + 00 | 1.6E + 03 |
| Co-58   | 9.0E-04   | 9.0E-01   | 9.0E + 02 |
| Co-58m  | 1.7E-01   | 1.7E + 02 | 1.7E + 05 |
| Co-60   | 1.6E-05   | 1.6E-02   | 1.6E + 01 |
| Co-60m  | 4.0E + 00 | 4.0E + 03 | 4.0E + 06 |
| Co-61   | 3.8E + 00 | 3.8E + 03 | 3.8E + 06 |
| Cr-49   | 9.0E-01   | 9.0E + 02 | 9.0E + 05 |
| Cr-51   | 6.3E-02   | 6.3E + 01 | 6.3E + 04 |
| Cs-129  | 1.5E-01   | 1.5E + 02 | 1.5E + 05 |
| Cs-131  | 2.8E-01   | 2.8E + 02 | 2.8E + 05 |
| Cs-132  | 1.3E-02   | 1.3E + 01 | 1.3E + 04 |
| Cs-134  | 5.2E-05   | 5.2E-02   | 5.2E + 01 |
| Cs-134m | 3.2E-01   | 3.2E + 02 | 3.2E + 05 |
| Cs-135  | 2.4E-02   | 2.4E + 01 | 2.4E + 04 |
| Cs-136  | 2.1E-03   | 2.1E + 00 | 2.1E + 03 |

|         |           |           |           |
|---------|-----------|-----------|-----------|
| Cs-137  | 2.3E-05   | 2.3E-02   | 2.3E + 01 |
| Cs-138  | 4.4E-01   | 4.4E + 02 | 4.4E + 05 |
| Cu-61   | 4.0E-01   | 4.0E + 02 | 4.0E + 05 |
| Cu-64   | 5.2E-01   | 5.2E + 02 | 5.2E + 05 |
| Cu-67   | 1.5E-01   | 1.5E + 02 | 1.5E + 05 |
| Dy-157  | 4.4E-01   | 4.4E + 02 | 4.4E + 05 |
| Dy-165  | 5.6E + 00 | 5.6E + 03 | 5.6E + 06 |
| Dy-166  | 8.1E-02   | 8.1E + 01 | 8.1E + 04 |
| Er-169  | 4.0E-01   | 4.0E + 02 | 4.0E + 05 |
| Er-171  | 3.6E-01   | 3.6E + 02 | 3.6E + 05 |
| Es-253  | 2.6E-04   | 2.6E-01   | 2.6E + 02 |
| Es-254  | 2.3E-05   | 2.3E-02   | 2.3E + 01 |
| Es-254m | 1.8E-03   | 1.8E + 00 | 1.8E + 03 |
| Eu-152  | 1.6E-05   | 1.6E-02   | 1.6E + 01 |
| Eu-152m | 3.5E-01   | 3.5E + 02 | 3.5E + 05 |
| Eu-154  | 2.0E-05   | 2.0E-02   | 2.0E + 01 |
| Eu-155  | 5.2E-04   | 5.2E-01   | 5.2E + 02 |
| Eu-156  | 3.2E-03   | 3.2E + 00 | 3.2E + 03 |
| F-18    | 5.6E-01   | 5.6E + 02 | 5.6E + 05 |
| Fe-52   | 4.9E-02   | 4.9E + 01 | 4.9E + 04 |
| Fe-55   | 1.4E-01   | 1.4E + 02 | 1.4E + 05 |
| Fe-59   | 1.3E-03   | 1.3E + 00 | 1.3E + 03 |
| Fm-254  | 1.8E-02   | 1.8E + 01 | 1.8E + 04 |
| Fm-255  | 4.0E-03   | 4.0E + 00 | 4.0E + 03 |
| Fr-223  | 1.4E-01   | 1.4E + 02 | 1.4E + 05 |
| Ga-66   | 5.6E-02   | 5.6E + 01 | 5.6E + 04 |
| Ga-67   | 1.1E-01   | 1.1E + 02 | 1.1E + 05 |
| Ga-68   | 7.6E-01   | 7.6E + 02 | 7.6E + 05 |
| Ga-72   | 3.6E-02   | 3.6E + 01 | 3.6E + 04 |
| Gd-152  | 4.4E-06   | 4.4E-03   | 4.4E + 00 |

|         |           |           |           |
|---------|-----------|-----------|-----------|
| Gd-153  | 2.0E-03   | 2.0E + 00 | 2.0E + 03 |
| Gd-159  | 6.8E-01   | 6.8E + 02 | 6.8E + 05 |
| Ge-68   | 2.3E-04   | 2.3E-01   | 2.3E + 02 |
| Ge-71   | 2.6E + 00 | 2.6E + 03 | 2.6E + 06 |
| Ge-77   | 1.0E-01   | 1.0E + 02 | 1.0E + 05 |
| H-3     | 1.5E + 01 | 1.5E + 04 | 1.5E + 07 |
| Hf-181  | 2.5E-03   | 2.5E + 00 | 2.5E + 03 |
| Hg-193m | 9.5E-02   | 9.5E + 01 | 9.5E + 04 |
| Hg-197  | 2.4E-01   | 2.4E + 02 | 2.4E + 05 |
| Hg-197m | 2.5E-01   | 2.5E + 02 | 2.5E + 05 |
| Hg-203  | 5.2E-03   | 5.2E + 00 | 5.2E + 03 |
| Ho-166  | 2.8E-01   | 2.8E + 02 | 2.8E + 05 |
| Ho-166m | 6.0E-06   | 6.0E-03   | 6.0E + 00 |
| I-123   | 4.9E-01   | 4.9E + 02 | 4.9E + 05 |
| I-124   | 9.3E-03   | 9.3E + 00 | 9.3E + 03 |
| I-125   | 6.2E-03   | 6.2E + 00 | 6.2E + 03 |
| I-126   | 3.7E-03   | 3.7E + 00 | 3.7E + 03 |
| I-128   | 9.3E + 00 | 9.3E + 03 | 9.3E + 06 |
| I-129   | 2.6E-04   | 2.6E-01   | 2.6E + 02 |
| I-130   | 4.6E-02   | 4.6E + 01 | 4.6E + 04 |
| I-131   | 6.7E-03   | 6.7E + 00 | 6.7E + 03 |
| I-132   | 2.0E-01   | 2.0E + 02 | 2.0E + 05 |
| I-133   | 6.7E-02   | 6.7E + 01 | 6.7E + 04 |
| I-134   | 3.2E-01   | 3.2E + 02 | 3.2E + 05 |
| I-135   | 1.2E-01   | 1.2E + 02 | 1.2E + 05 |
| In-111  | 4.9E-02   | 4.9E + 01 | 4.9E + 04 |
| In-113m | 2.1E + 00 | 2.1E + 03 | 2.1E + 06 |
| In-114m | 4.9E-03   | 4.9E + 00 | 4.9E + 03 |
| In-115  | 2.7E-04   | 2.7E-01   | 2.7E + 02 |
| In-115m | 1.4E + 00 | 1.4E + 03 | 1.4E + 06 |

|         |           |           |           |
|---------|-----------|-----------|-----------|
| In-116m | 3.5E-01   | 3.5E + 02 | 3.5E + 05 |
| In-117  | 1.3E + 00 | 1.3E + 03 | 1.3E + 06 |
| In-117m | 7.6E-02   | 7.6E + 01 | 7.6E + 04 |
| Ir-190  | 3.5E-03   | 3.5E + 00 | 3.5E + 03 |
| Ir-192  | 9.7E-04   | 9.7E-01   | 9.7E + 02 |
| Ir-194  | 2.5E-01   | 2.5E + 02 | 2.5E + 05 |
| Ir-194m | 1.5E-04   | 1.5E-01   | 1.5E + 02 |
| K-40    | 6.8E-05   | 6.8E-02   | 6.8E + 01 |
| K-42    | 2.9E-01   | 2.9E + 02 | 2.9E + 05 |
| K-43    | 6.0E-02   | 6.0E + 01 | 6.0E + 04 |
| K-44    | 4.9E-01   | 4.9E + 02 | 4.9E + 05 |
| Kr-79   | 7.0E + 00 |           |           |
| Kr-81   | 1.8E + 02 |           |           |
| Kr-83m  | 2.0E + 04 |           |           |
| Kr-85   | 8.4E + 02 |           |           |
| Kr-85m  | 1.1E + 01 |           |           |
| Kr-87   | 2.0E + 00 |           |           |
| Kr-88   | 4.2E-01   |           |           |
| La-140  | 1.6E-02   | 1.6E + 01 | 1.6E + 04 |
| La-141  | 1.1E + 00 | 1.1E + 03 | 1.1E + 06 |
| La-142  | 2.3E-01   | 2.3E + 02 | 2.3E + 05 |
| Lu-177  | 1.4E-01   | 1.4E + 02 | 1.4E + 05 |
| Lu-177m | 3.5E-04   | 3.5E-01   | 3.5E + 02 |
| Mg-28   | 2.1E-02   | 2.1E + 01 | 2.1E + 04 |
| Mn-52   | 3.5E-03   | 3.5E + 00 | 3.5E + 03 |
| Mn-52m  | 5.2E-01   | 5.2E + 02 | 5.2E + 05 |
| Mn-53   | 5.7E-02   | 5.7E + 01 | 5.7E + 04 |
| Mn-54   | 2.5E-04   | 2.5E-01   | 2.5E + 02 |
| Mn-56   | 2.5E-01   | 2.5E + 02 | 2.5E + 05 |
| Mo-93   | 1.5E-03   | 1.5E + 00 | 1.5E + 03 |

|         |           |           |           |
|---------|-----------|-----------|-----------|
| Mo-99** | 5.7E-02   | 5.7E + 01 | 5.7E + 04 |
| Mo-101  | 8.4E-01   | 8.4E + 02 | 8.4E + 05 |
| Na-22   | 3.2E-05   | 3.2E-02   | 3.2E + 01 |
| Na-24   | 2.6E-02   | 2.6E + 01 | 2.6E + 04 |
| Nb-90   | 2.5E-02   | 2.5E + 01 | 2.5E + 04 |
| Nb-93m  | 1.2E-02   | 1.2E + 01 | 1.2E + 04 |
| Nb-94   | 6.0E-06   | 6.0E-03   | 6.0E + 00 |
| Nb-95   | 2.3E-03   | 2.3E + 00 | 2.3E + 03 |
| Nb-95m  | 2.0E-02   | 2.0E + 01 | 2.0E + 04 |
| Nb-96   | 2.5E-02   | 2.5E + 01 | 2.5E + 04 |
| Nb-97   | 1.0E + 00 | 1.0E + 03 | 1.0E + 06 |
| Nd-147  | 3.0E-02   | 3.0E + 01 | 3.0E + 04 |
| Nd-149  | 1.1E + 00 | 1.1E + 03 | 1.1E + 06 |
| Ni-56   | 2.0E-03   | 2.0E + 00 | 2.0E + 03 |
| Ni-57   | 2.1E-02   | 2.1E + 01 | 2.1E + 04 |
| Ni-59   | 2.2E-02   | 2.2E + 01 | 2.2E + 04 |
| Ni-63   | 1.4E-01   | 1.4E + 02 | 1.4E + 05 |
| Ni-65   | 7.0E-01   | 7.0E + 02 | 7.0E + 05 |
| Np-235  | 3.0E-02   | 3.0E + 01 | 3.0E + 04 |
| Np-237  | 1.8E-06   | 1.8E-03   | 1.8E + 00 |
| Np-238  | 1.9E-02   | 1.9E + 01 | 1.9E + 04 |
| Np-239  | 1.0E-01   | 1.0E + 02 | 1.0E + 05 |
| Np-240  | 6.5E-01   | 6.5E + 02 | 6.5E + 05 |
| Np-240m | 4.7E + 00 | 4.7E + 03 | 4.7E + 06 |
| Os-185  | 9.2E-04   | 9.2E-01   | 9.2E + 02 |
| Os-191m | 9.0E-01   | 9.0E + 02 | 9.0E + 05 |
| Os-191  | 3.8E-02   | 3.8E + 01 | 3.8E + 04 |
| Os-193  | 2.9E-01   | 2.9E + 02 | 2.9E + 05 |
| P-32    | 1.7E-02   | 1.7E + 01 | 1.7E + 04 |
| P-33    | 1.2E-01   | 1.2E + 02 | 1.2E + 05 |

|         |           |           |           |
|---------|-----------|-----------|-----------|
| Pa-230  | 6.3E-04   | 6.3E-01   | 6.3E + 02 |
| Pa-231  | 8.3E-07   | 8.3E-04   | 8.3E-01   |
| Pa-233  | 9.3E-03   | 9.3E + 00 | 9.3E + 03 |
| Pa-234  | 9.3E-02   | 9.3E + 01 | 9.3E + 04 |
| Pb-203  | 8.3E-02   | 8.3E + 01 | 8.3E + 04 |
| Pb-205  | 1.2E-02   | 1.2E + 01 | 1.2E + 04 |
| Pb-209  | 1.1E + 01 | 1.1E + 04 | 1.1E + 07 |
| Pb-210  | 5.5E-05   | 5.5E-02   | 5.5E + 01 |
| Pb-211  | 1.2E-01   | 1.2E + 02 | 1.2E + 05 |
| Pb-212  | 6.0E-03   | 6.0E + 00 | 6.0E + 03 |
| Pb-214  | 1.2E-01   | 1.2E + 02 | 1.2E + 05 |
| Pd-103  | 2.1E-01   | 2.1E + 02 | 2.1E + 05 |
| Pd-107  | 8.2E-02   | 8.2E + 01 | 8.2E + 04 |
| Pd-109  | 9.4E-01   | 9.4E + 02 | 9.4E + 05 |
| Pm-143  | 7.6E-04   | 7.6E-01   | 7.6E + 02 |
| Pm-144  | 1.1E-04   | 1.1E-01   | 1.1E + 02 |
| Pm-145  | 5.2E-04   | 5.2E-01   | 5.2E + 02 |
| Pm-146  | 4.4E-05   | 4.4E-02   | 4.4E + 01 |
| Pm-147  | 2.6E-02   | 2.6E + 01 | 2.6E + 04 |
| Pm-148  | 1.7E-02   | 1.7E + 01 | 1.7E + 04 |
| Pm-148m | 7.6E-04   | 7.6E-01   | 7.6E + 02 |
| Pm-149  | 2.8E-01   | 2.8E + 02 | 2.8E + 05 |
| Pm-151  | 1.2E-01   | 1.2E + 02 | 1.2E + 05 |
| Po-210  | 9.3E-05   | 9.3E-02   | 9.3E + 01 |
| Pr-142  | 2.8E-01   | 2.8E + 02 | 2.8E + 05 |
| Pr-143  | 1.0E-01   | 1.0E + 02 | 1.0E + 05 |
| Pr-144  | 1.5E + 01 | 1.5E + 04 | 1.5E + 07 |
| Pt-191  | 6.4E-02   | 6.4E + 01 | 6.4E + 04 |
| Pt-193  | 2.1E-02   | 2.1E + 01 | 2.1E + 04 |
| Pt-193m | 4.8E-01   | 4.8E + 02 | 4.8E + 05 |



|         |           |           |           |
|---------|-----------|-----------|-----------|
| Pt-195m | 1.4E-01   | 1.4E + 02 | 1.4E + 05 |
| Pt-197  | 1.1E + 00 | 1.1E + 03 | 1.1E + 06 |
| Pt-197m | 3.6E + 00 | 3.6E + 03 | 3.6E + 06 |
| Pu-236  | 7.0E-06   | 7.0E-03   | 7.0E + 00 |
| Pu-237  | 2.3E-02   | 2.3E + 01 | 2.3E + 04 |
| Pu-238  | 2.7E-06   | 2.7E-03   | 2.7E + 00 |
| Pu-239  | 2.5E-06   | 2.5E-03   | 2.5E + 00 |
| Pu-240  | 2.5E-06   | 2.5E-03   | 2.5E + 00 |
| Pu-241  | 1.3E-04   | 1.3E-01   | 1.3E + 02 |
| Pu-242  | 2.5E-06   | 2.5E-03   | 2.5E + 00 |
| Pu-243  | 3.8E + 00 | 3.8E + 03 | 3.8E + 06 |
| Pu-244  | 2.4E-06   | 2.4E-03   | 2.4E + 00 |
| Pu-245  | 2.1E-01   | 2.1E + 02 | 2.1E + 05 |
| Pu-246  | 4.8E-03   | 4.8E + 00 | 4.8E + 03 |
| Ra-223  | 1.3E-04   | 1.3E-01   | 1.3E + 02 |
| Ra-224  | 3.2E-04   | 3.2E-01   | 3.2E + 02 |
| Ra-225  | 1.3E-04   | 1.3E-01   | 1.3E + 02 |
| Ra-226  | 5.5E-06   | 5.5E-03   | 5.5E + 00 |
| Ra-228  | 1.3E-05   | 1.3E-02   | 1.3E + 01 |
| Rb-81   | 4.2E-01   | 4.2E + 02 | 4.2E + 05 |
| Rb-83   | 1.4E-03   | 1.4E + 00 | 1.4E + 03 |
| Rb-84   | 2.0E-03   | 2.0E + 00 | 2.0E + 03 |
| Rb-86   | 1.7E-02   | 1.7E + 01 | 1.7E + 04 |
| Rb-87   | 1.0E-02   | 1.0E + 01 | 1.0E + 04 |
| Rb-88   | 1.7E + 00 | 1.7E + 03 | 1.7E + 06 |
| Rb-89   | 6.4E-01   | 6.4E + 02 | 6.4E + 05 |
| Re-184  | 1.8E-03   | 1.8E + 00 | 1.8E + 03 |
| Re-184m | 3.6E-04   | 3.6E-01   | 3.6E + 02 |
| Re-186  | 1.9E-01   | 1.9E + 02 | 1.9E + 05 |
| Re-187  | 9.3E + 00 | 9.3E + 03 | 9.3E + 06 |

|         |           |           |           |
|---------|-----------|-----------|-----------|
| Re-188  | 3.7E-01   | 3.7E + 02 | 3.7E + 05 |
| Rh-103m | 1.7E + 02 | 1.7E + 05 | 1.7E + 08 |
| Rh-105  | 3.4E-01   | 3.4E + 02 | 3.4E + 05 |
| Ru-97   | 8.3E-02   | 8.3E + 01 | 8.3E + 04 |
| Ru-103  | 3.1E-03   | 3.1E + 00 | 3.1E + 03 |
| Ru-105  | 2.9E-01   | 2.9E + 02 | 2.9E + 05 |
| Ru-106  | 5.9E-04   | 5.9E-01   | 5.9E + 02 |
| S-35    | 7.5E-02   | 7.5E + 01 | 7.5E + 04 |
| Sb-117  | 2.0E + 00 | 2.0E + 03 | 2.0E + 06 |
| Sb-122  | 3.9E-02   | 3.9E + 01 | 3.9E + 04 |
| Sb-124  | 6.0E-04   | 6.0E-01   | 6.0E + 02 |
| Sb-125  | 1.4E-04   | 1.4E-01   | 1.4E + 02 |
| Sb-126  | 1.8E-03   | 1.8E + 00 | 1.8E + 03 |
| Sb-126m | 7.6E-01   | 7.6E + 02 | 7.6E + 05 |
| Sb-127  | 2.0E-02   | 2.0E + 01 | 2.0E + 04 |
| Sb-129  | 1.8E-01   | 1.8E + 02 | 1.8E + 05 |
| Sc-44   | 1.4E-01   | 1.4E + 02 | 1.4E + 05 |
| Sc-46   | 4.0E-04   | 4.0E-01   | 4.0E + 02 |
| Sc-47   | 1.1E-01   | 1.1E + 02 | 1.1E + 05 |
| Sc-48   | 1.1E-02   | 1.1E + 01 | 1.1E + 04 |
| Sc-49   | 1.0E + 01 | 1.0E + 04 | 1.0E + 07 |
| Se-73   | 1.6E-01   | 1.6E + 02 | 1.6E + 05 |
| Se-75   | 1.1E-03   | 1.1E + 00 | 1.1E + 03 |
| Se-79   | 6.9E-03   | 6.9E + 00 | 6.9E + 03 |
| Si-31   | 4.7E + 00 | 4.7E + 03 | 4.7E + 06 |
| Si-32   | 7.2E-04   | 7.2E-01   | 7.2E + 02 |
| Sm-147  | 1.4E-05   | 1.4E-02   | 1.4E + 01 |
| Sm-151  | 3.5E-02   | 3.5E + 01 | 3.5E + 04 |
| Sm-153  | 2.4E-01   | 2.4E + 02 | 2.4E + 05 |
| Sn-113  | 1.9E-03   | 1.9E + 00 | 1.9E + 03 |

|         |           |           |           |
|---------|-----------|-----------|-----------|
| Sn-117m | 2.3E-02   | 2.3E + 01 | 2.3E + 04 |
| Sn-119m | 2.8E-02   | 2.8E + 01 | 2.8E + 04 |
| Sn-123  | 1.8E-02   | 1.8E + 01 | 1.8E + 04 |
| Sn-125  | 7.2E-03   | 7.2E + 00 | 7.2E + 03 |
| Sn-126  | 4.7E-06   | 4.7E-03   | 4.7E + 00 |
| Sr-82   | 1.9E-03   | 1.9E + 00 | 1.9E + 03 |
| Sr-85   | 1.9E-03   | 1.9E + 00 | 1.9E + 03 |
| Sr-85m  | 1.5E + 00 | 1.5E + 03 | 1.5E + 06 |
| Sr-87m  | 1.2E + 00 | 1.2E + 03 | 1.2E + 06 |
| Sr-89   | 2.1E-02   | 2.1E + 01 | 2.1E + 04 |
| Sr-90   | 5.2E-04   | 5.2E-01   | 5.2E + 02 |
| Sr-91   | 1.2E-01   | 1.2E + 02 | 1.2E + 05 |
| Sr-92   | 2.5E-01   | 2.5E + 02 | 2.5E + 05 |
| Ta-182  | 4.4E-04   | 4.4E-01   | 4.4E + 02 |
| Tb-157  | 2.2E-03   | 2.2E + 00 | 2.2E + 03 |
| Tb-160  | 8.4E-04   | 8.4E-01   | 8.4E + 02 |
| Tc-95   | 9.0E-02   | 9.0E + 01 | 9.0E + 04 |
| Tc-95m  | 1.4E-03   | 1.4E + 00 | 1.4E + 03 |
| Tc-96   | 5.6E-03   | 5.6E + 00 | 5.6E + 03 |
| Tc-96m  | 7.0E-01   | 7.0E + 02 | 7.0E + 05 |
| Tc-97   | 1.5E-03   | 1.5E + 00 | 1.5E + 03 |
| Tc-97m  | 7.2E-02   | 7.2E + 01 | 7.2E + 04 |
| Tc-98   | 6.4E-06   | 6.4E-03   | 6.4E + 00 |
| Tc-99   | 9.0E-03   | 9.0E + 00 | 9.0E + 03 |
| Tc-99m  | 1.4E + 00 | 1.4E + 03 | 1.4E + 06 |
| Tc-101  | 3.8E + 00 | 3.8E + 03 | 3.8E + 06 |
| Te-121  | 6.0E-03   | 6.0E + 00 | 6.0E + 03 |
| Te-121m | 5.3E-04   | 5.3E-01   | 5.3E + 02 |
| Te-123  | 1.2E-03   | 1.2E + 00 | 1.2E + 03 |
| Te-123m | 2.7E-03   | 2.7E + 00 | 2.7E + 03 |

|         |           |           |           |
|---------|-----------|-----------|-----------|
| Te-125m | 1.5E-02   | 1.5E + 01 | 1.5E + 04 |
| Te-127  | 2.9E + 00 | 2.9E + 03 | 2.9E + 06 |
| Te-127m | 7.3E-03   | 7.3E + 00 | 7.3E + 03 |
| Te-129  | 6.5E + 00 | 6.5E + 03 | 6.5E + 06 |
| Te-129m | 6.1E-03   | 6.1E + 00 | 6.1E + 03 |
| Te-131  | 9.4E-01   | 9.4E + 02 | 9.4E + 05 |
| Te-131m | 1.8E-02   | 1.8E + 01 | 1.8E + 04 |
| Te-132  | 6.2E-03   | 6.2E + 00 | 6.2E + 03 |
| Te-133  | 1.2E + 00 | 1.2E + 03 | 1.2E + 06 |
| Te-133m | 2.9E-01   | 2.9E + 02 | 2.9E + 05 |
| Te-134  | 4.4E-01   | 4.4E + 02 | 4.4E + 05 |
| Th-226  | 3.0E-02   | 3.0E + 01 | 3.0E + 04 |
| Th-227  | 6.4E-05   | 6.4E-02   | 6.4E + 01 |
| Th-228  | 2.9E-06   | 2.9E-03   | 2.9E + 00 |
| Th-229  | 4.9E-07   | 4.9E-04   | 4.9E-01   |
| Th-230  | 3.2E-06   | 3.2E-03   | 3.2E + 00 |
| Th-231  | 8.4E-01   | 8.4E + 02 | 8.4E + 05 |
| Th-232  | 6.0E-07   | 6.0E-04   | 6.0E-01   |
| Th-234  | 2.0E-02   | 2.0E + 01 | 2.0E + 04 |
| Ti-44   | 5.2E-06   | 5.2E-03   | 5.2E + 00 |
| Ti-45   | 4.0E-01   | 4.0E + 02 | 4.0E + 05 |
| Tl-200  | 4.4E-02   | 4.4E + 01 | 4.4E + 04 |
| Tl-201  | 1.8E-01   | 1.8E + 02 | 1.8E + 05 |
| Tl-202  | 1.0E-02   | 1.0E + 01 | 1.0E + 04 |
| Tl-204  | 2.5E-02   | 2.5E + 01 | 2.5E + 04 |
| Tm-170  | 2.4E-02   | 2.4E + 01 | 2.4E + 04 |
| Tm-171  | 5.9E-02   | 5.9E + 01 | 5.9E + 04 |
| U-230   | 5.0E-05   | 5.0E-02   | 5.0E + 01 |
| U-231   | 1.4E-01   | 1.4E + 02 | 1.4E + 05 |
| U-232   | 1.3E-06   | 1.3E-03   | 1.3E + 00 |

|         |           |           |           |
|---------|-----------|-----------|-----------|
| U-233   | 7.6E-06   | 7.6E-03   | 7.6E + 00 |
| U-234   | 7.6E-06   | 7.6E-03   | 7.6E + 00 |
| U-235   | 7.0E-06   | 7.0E-03   | 7.0E + 00 |
| U-236   | 8.4E-06   | 8.4E-03   | 8.4E + 00 |
| U-237   | 4.7E-02   | 4.7E + 01 | 4.7E + 04 |
| U-238   | 8.6E-06   | 8.6E-03   | 8.6E + 00 |
| U-239   | 8.3E + 00 | 8.3E + 03 | 8.3E + 06 |
| U-240   | 1.8E-01   | 1.8E + 02 | 1.8E + 05 |
| V-48    | 1.4E-03   | 1.4E + 00 | 1.4E + 03 |
| V-49    | 1.3E + 00 | 1.3E + 03 | 1.3E + 06 |
| W-181   | 1.1E-02   | 1.1E + 01 | 1.1E + 04 |
| W-185   | 1.6E-01   | 1.6E + 02 | 1.6E + 05 |
| W-187   | 1.1E-01   | 1.1E + 02 | 1.1E + 05 |
| W-188   | 1.0E-02   | 1.0E + 01 | 1.0E + 04 |
| Xe-122  | 7.6E-02   | 7.6E + 01 | 7.6E + 04 |
| Xe-123  | 1.6E + 00 | 1.6E + 03 | 1.6E + 06 |
| Xe-125  | 6.0E-01   |           |           |
| Xe-127  | 7.0E + 00 |           |           |
| Xe-129m | 7.6E + 01 |           |           |
| Xe-131m | 2.2E + 02 |           |           |
| Xe-133  | 5.2E + 01 |           |           |
| Xe-133m | 6.0E + 01 |           |           |
| Xe-135  | 7.6E + 00 |           |           |
| Xe-135m | 4.2E + 00 |           |           |
| Xe-138  | 9.9E-01   |           |           |
| Y-86    | 2.8E-02   | 2.8E + 01 | 2.8E + 04 |
| Y-87    | 2.3E-02   | 2.3E + 01 | 2.3E + 04 |
| Y-88    | 2.5E-04   | 2.5E-01   | 2.5E + 02 |
| Y-90    | 1.1E-01   | 1.1E + 02 | 1.1E + 05 |
| Y-90m   | 4.3E-01   | 4.3E + 02 | 4.3E + 05 |

|        |           |           |           |
|--------|-----------|-----------|-----------|
| Y-91   | 1.8E-02   | 1.8E + 01 | 1.8E + 04 |
| Y-91m  | 1.6E + 00 | 1.6E + 03 | 1.6E + 06 |
| Y-92   | 7.0E-01   | 7.0E + 02 | 7.0E + 05 |
| Y-93   | 3.8E-01   | 3.8E + 02 | 3.8E + 05 |
| Yb-169 | 5.5E-03   | 5.5E + 00 | 5.5E + 03 |
| Yb-175 | 2.1E-01   | 2.1E + 02 | 2.1E + 05 |
| Zn-62  | 8.6E-02   | 8.6E + 01 | 8.6E + 04 |
| Zn-65  | 4.4E-04   | 4.4E-01   | 4.4E + 02 |
| Zn-69  | 2.7E + 01 | 2.7E + 04 | 2.7E + 07 |
| Zn-69m | 2.0E-01   | 2.0E + 02 | 2.0E + 05 |
| Zr-86  | 2.4E-02   | 2.4E + 01 | 2.4E + 04 |
| Zr-88  | 2.7E-04   | 2.7E-01   | 2.7E + 02 |
| Zr-89  | 1.6E-02   | 1.6E + 01 | 1.6E + 04 |
| Zr-93  | 2.8E-03   | 2.8E + 00 | 2.8E + 03 |
| Zr-95  | 6.4E-04   | 6.4E-01   | 6.4E + 02 |
| Zr-97  | 4.6E-02   | 4.6E + 01 | 4.6E + 04 |

\*Radionuclides boiling at 100 °C or less, or exposed to a temperature of 100 °C, must be considered a gas. Capsules containing radionuclides in liquid or powder form can be considered to be solids.

\*\*Mo-99 contained in a generator to produce Technetium-99 can be assumed to be a solid.

### 3. Table of Concentration Levels

(a) Table 2 may be used for determining if facilities are in compliance with the standard.

1. The concentration table as applied to emission estimates can only be used if all releases are from point sources and concentrations have been measured at the stack or vent using EPA-approved methods, and the distance between each stack or vent and the nearest resident is greater than 3 times the diameter of the stack or vent. Procedures provided in Ref. (1) shall be used to determine compliance or exemption from reporting by use of Table 2.

2. The concentration table may be used to determine compliance with the standard based on environmental measurements provided these measurements are made in conformance with the requirements of §61.107(b)(5).

### 4. NCRP Screening Model

The procedures described in Reference (4) may be used to determine doses to members of the general public from emissions of radionuclides to the atmosphere. Both the total dose from all

radionuclides emitted, and the dose caused by radioactive iodine must be considered in accordance with the procedures in Ref. (1).

### 5. The COMPLY Computer Code

The COMPLY computer code may be used to determine compliance with subpart I. The compliance model in the COMPLY computer code may be used to determine the dose to members of the general public from emissions of radionuclides to the atmosphere. The EPA may add radionuclides to all or any part of COMPLY to cover radionuclides that may be used by the regulated community.

**TABLE 2—CONCENTRATION LEVELS FOR ENVIRONMENTAL COMPLIANCE**

| <b>Radionuclide</b> | <b>Concentration (Ci/m<sup>3</sup>)</b> | <b>Radionuclide</b> | <b>Concentration (Ci/m<sup>3</sup>)</b> |
|---------------------|---|---------------------|---|
| Ac-225              | 9.1E-14                                 | Bi-207              | 1.0E-14                                 |
| Ac-227              | 1.6E-16                                 | Bi-210              | 2.9E-13                                 |
| Ac-228              | 3.7E-12                                 | Bi-212              | 5.6E-11                                 |
| Ag-106              | 1.9E-09                                 | Bi-213              | 7.1E-11                                 |
| Ag-106m             | 1.2E-12                                 | Bi-214              | 1.4E-10                                 |
| Ag-108m             | 7.1E-15                                 | Bk-249              | 5.6E-13                                 |
| Ag-110m             | 9.1E-14                                 | Bk-250              | 9.1E-11                                 |
| Ag-111              | 2.5E-12                                 | Br-77               | 4.2E-11                                 |
| Al-26               | 4.8E-15                                 | Br-80               | 1.4E-08                                 |
| Am-241              | 1.9E-15                                 | Br-80m              | 1.8E-09                                 |
| Am-242              | 1.5E-11                                 | Br-82               | 1.2E-11                                 |
| Am-242m             | 2.0E-15                                 | Br-83               | 1.2E-08                                 |
| Am-243              | 1.8E-15                                 | Br-84               | 6.7E-10                                 |
| Am-244              | 4.0E-11                                 | C-11                | 1.5E-09                                 |
| Am-245              | 8.3E-09                                 | C-14                | 1.0E-11                                 |
| Am-246              | 1.2E-09                                 | Ca-41               | 4.2E-13                                 |
| Ar-37               | 1.6E-03                                 | Ca-45               | 1.3E-12                                 |
| Ar-41               | 1.7E-09                                 | Ca-47               | 2.4E-12                                 |
| As-72               | 2.4E-11                                 | Cd-109              | 5.9E-13                                 |
| As-73               | 1.1E-11                                 | Cd-113              | 9.1E-15                                 |
| As-74               | 2.2E-12                                 | Cd-113m             | 1.7E-14                                 |
| As-76               | 5.0E-11                                 | Cd-115              | 1.6E-11                                 |

|         |         |         |         |
|---------|---------|---------|---------|
| As-77   | 1.6E-10 | Cd-115m | 8.3E-13 |
| At-211  | 1.1E-11 | Cd-117  | 6.7E-11 |
| Au-193  | 3.8E-10 | Cd-117m | 1.6E-10 |
| Au-194  | 3.2E-11 | Ce-139  | 2.6E-12 |
| Au-195  | 3.1E-12 | Ce-141  | 6.3E-12 |
| Au-198  | 2.1E-11 | Ce-143  | 3.0E-11 |
| Au-199  | 4.8E-11 | Ce-144  | 6.2E-13 |
| Ba-131  | 7.1E-12 | Cf-248  | 1.8E-14 |
| Ba-133  | 5.9E-14 | Cf-249  | 1.4E-15 |
| Ba-133m | 5.9E-11 | Cf-250  | 3.2E-15 |
| Ba-135m | 1.8E-10 | Cf-251  | 1.4E-15 |
| Ba-139  | 5.6E-09 | Cf-252  | 5.6E-15 |
| Ba-140  | 1.3E-12 | Cf-253  | 3.1E-13 |
| Ba-141  | 1.4E-09 | Cf-254  | 3.0E-15 |
| Ba-142  | 1.3E-09 | Cl-36   | 2.7E-15 |
| Be-7    | 2.3E-11 | Cl-38   | 7.7E-10 |
| Be-10   | 1.6E-12 | Cm-242  | 5.3E-14 |
| Bi-206  | 2.3E-12 | Cm-243  | 2.6E-15 |
| Cm-244  | 3.3E-15 | Eu-156  | 1.9E-12 |
| Cm-245  | 1.8E-15 | F-18    | 6.7E-10 |
| Cm-246  | 1.9E-15 | Fe-52   | 5.6E-11 |
| Cm-247  | 1.9E-15 | Fe-55   | 9.1E-12 |
| Cm-248  | 5.0E-16 | Fe-59   | 6.7E-13 |
| Cm-249  | 3.7E-09 | Fm-254  | 2.0E-11 |
| Cm-250  | 9.1E-17 | Fm-255  | 4.3E-12 |
| Co-56   | 1.8E-13 | Fr-223  | 3.3E-11 |
| Co-57   | 1.3E-12 | Ga-66   | 6.2E-11 |
| Co-58   | 6.7E-13 | Ga-67   | 7.1E-11 |
| Co-58m  | 1.2E-10 | Ga-68   | 9.1E-10 |
| Co-60   | 1.7E-14 | Ga-72   | 3.8E-11 |



|         |         |         |         |
|---------|---------|---------|---------|
| Co-60m  | 4.3E-09 | Gd-152  | 5.0E-15 |
| Co-61   | 4.5E-09 | Gd-153  | 2.1E-12 |
| Cr-49   | 1.1E-09 | Gd-159  | 2.9E-10 |
| Cr-51   | 3.1E-11 | Ge-68   | 2.0E-13 |
| Cs-129  | 1.4E-10 | Ge-71   | 2.4E-10 |
| Cs-131  | 3.3E-11 | Ge-77   | 1.0E-10 |
| Cs-132  | 4.8E-12 | H-3     | 1.5E-09 |
| Cs-134  | 2.7E-14 | Hf-181  | 1.9E-12 |
| Cs-134m | 1.7E-10 | Hg-193m | 1.0E-10 |
| Cs-135  | 4.0E-13 | Hg-197  | 8.3E-11 |
| Cs-136  | 5.3E-13 | Hg-197m | 1.1E-10 |
| Cs-137  | 1.9E-14 | Hg-203  | 1.0E-12 |
| Cs-138  | 5.3E-10 | Ho-166  | 7.1E-11 |
| Cu-61   | 4.8E-10 | Ho-166m | 7.1E-15 |
| Cu-64   | 5.3E-10 | I-123   | 4.3E-10 |
| Cu-67   | 5.0E-11 | I-124   | 6.2E-13 |
| Dy-157  | 5.0E-10 | I-125   | 1.2E-13 |
| Dy-165  | 6.7E-09 | I-126   | 1.1E-13 |
| Dy-166  | 1.1E-11 | I-128   | 1.1E-08 |
| Er-169  | 2.9E-11 | I-129   | 9.1E-15 |
| Er-171  | 4.0E-10 | I-130   | 4.5E-11 |
| Es-253  | 2.4E-13 | I-131   | 2.1E-13 |
| Es-254  | 2.0E-14 | I-132   | 2.3E-10 |
| Es-254m | 1.8E-12 | I-133   | 2.0E-11 |
| Eu-152  | 2.0E-14 | I-134   | 3.8E-10 |
| Eu-152m | 3.6E-10 | I-135   | 1.2E-10 |
| Eu-154  | 2.3E-14 | In-111  | 3.6E-11 |
| Eu-155  | 5.9E-13 | In-113m | 2.5E-09 |
| In-114m | 9.1E-13 | Nb-95   | 2.2E-12 |
| In-115  | 7.1E-14 | Nb-95m  | 1.4E-11 |

|         |         |         |         |
|---------|---------|---------|---------|
| In-115m | 1.6E-09 | Nb-96   | 2.4E-11 |
| In-116m | 4.2E-10 | Nb-97   | 1.2E-09 |
| In-117  | 1.6E-09 | Nd-147  | 7.7E-12 |
| In-117m | 9.1E-11 | Nd-149  | 7.1E-10 |
| Ir-190  | 2.6E-12 | Ni-56   | 1.7E-12 |
| Ir-192  | 9.1E-13 | Ni-57   | 1.8E-11 |
| Ir-194  | 1.1E-10 | Ni-59   | 1.5E-11 |
| Ir-194m | 1.7E-13 | Ni-63   | 1.4E-11 |
| K-40    | 2.7E-14 | Ni-65   | 8.3E-10 |
| K-42    | 2.6E-10 | Np-235  | 2.5E-11 |
| K-43    | 6.2E-11 | Np-237  | 1.2E-15 |
| K-44    | 5.9E-10 | Np-238  | 1.4E-11 |
| Kr-79   | 8.3E-09 | Np-239  | 3.8E-11 |
| Kr-81   | 2.1E-07 | Np-240  | 7.7E-10 |
| Kr-83m  | 2.3E-05 | Np-240m | 5.6E-09 |
| Kr-85   | 1.0E-06 | Os-185  | 1.0E-12 |
| Kr-85m  | 1.3E-08 | Os-191m | 2.9E-10 |
| Kr-87   | 2.4E-09 | Os-191  | 1.1E-11 |
| Kr-88   | 5.0E-10 | Os-193  | 9.1E-11 |
| La-140  | 1.2E-11 | P-32    | 3.3E-13 |
| La-141  | 7.7E-10 | P-33    | 2.4E-12 |
| La-142  | 2.7E-10 | Pa-230  | 3.2E-13 |
| Lu-177  | 2.4E-11 | Pa-231  | 5.9E-16 |
| Lu-177m | 3.6E-13 | Pa-233  | 4.8E-12 |
| Mg-28   | 1.5E-11 | Pa-234  | 1.1E-10 |
| Mn-52   | 2.8E-12 | Pb-203  | 6.2E-11 |
| Mn-52m  | 6.2E-10 | Pb-205  | 5.6E-12 |
| Mn-53   | 1.5E-11 | Pb-209  | 1.3E-08 |
| Mn-54   | 2.8E-13 | Pb-210  | 2.8E-15 |
| Mn-56   | 2.9E-10 | Pb-211  | 1.4E-10 |

|         |         |         |         |
|---------|---------|---------|---------|
| Mo-93   | 1.1E-12 | Pb-212  | 6.3E-12 |
| Mo-99   | 1.4E-11 | Pb-214  | 1.2E-10 |
| Mo-101  | 1.0E-09 | Pd-103  | 3.8E-11 |
| Na-22   | 2.6E-14 | Pd-107  | 3.1E-11 |
| Na-24   | 2.6E-11 | Pd-109  | 4.8E-10 |
| Nb-90   | 2.6E-11 | Pm-143  | 9.1E-13 |
| Nb-93m  | 1.0E-11 | Pm-144  | 1.3E-13 |
| Nb-94   | 7.1E-15 | Pm-145  | 6.2E-13 |
| Pm-146  | 5.3E-14 | Re-184m | 3.7E-13 |
| Pm-147  | 1.1E-11 | Re-186  | 1.8E-11 |
| Pm-148  | 5.0E-12 | Re-187  | 2.6E-10 |
| Pm-148m | 6.7E-13 | Re-188  | 1.7E-10 |
| Pm-149  | 4.2E-11 | Rh-103m | 2.1E-07 |
| Pm-151  | 7.1E-11 | Rh-105  | 1.3E-10 |
| Po-210  | 7.1E-15 | Ru-97   | 6.7E-11 |
| Pr-142  | 1.1E-10 | Ru-103  | 2.6E-12 |
| Pr-143  | 7.1E-12 | Ru-105  | 2.8E-10 |
| Pr-144  | 1.8E-08 | Ru-106  | 3.4E-13 |
| Pt-191  | 4.3E-11 | S-35    | 1.3E-12 |
| Pt-193  | 1.8E-11 | Sb-117  | 2.4E-09 |
| Pt-193m | 4.8E-11 | Sb-122  | 1.4E-11 |
| Pt-195m | 3.2E-11 | Sb-124  | 5.3E-13 |
| Pt-197  | 4.0E-10 | Sb-125  | 1.6E-13 |
| Pt-197m | 2.6E-09 | Sb-126  | 1.4E-12 |
| Pu-236  | 5.9E-15 | Sb-126m | 9.1E-10 |
| Pu-237  | 1.9E-11 | Sb-127  | 7.1E-12 |
| Pu-238  | 2.1E-15 | Sb-129  | 7.7E-11 |
| Pu-239  | 2.0E-15 | Sc-44   | 1.7E-10 |
| Pu-240  | 2.0E-15 | Sc-46   | 4.2E-13 |
| Pu-241  | 1.0E-13 | Sc-47   | 3.8E-11 |

|        |         |         |         |
|--------|---------|---------|---------|
| Pu-242 | 2.0E-15 | Sc-48   | 9.1E-12 |
| Pu-243 | 4.2E-09 | Sc-49   | 1.2E-08 |
| Pu-244 | 2.0E-15 | Se-73   | 1.7E-10 |
| Pu-245 | 2.1E-10 | Se-75   | 1.7E-13 |
| Pu-246 | 2.2E-12 | Se-79   | 1.1E-13 |
| Ra-223 | 4.2E-14 | Si-31   | 5.6E-09 |
| Ra-224 | 1.5E-13 | Si-32   | 3.4E-14 |
| Ra-225 | 5.0E-14 | Sm-147  | 1.4E-14 |
| Ra-226 | 3.3E-15 | Sm-151  | 2.1E-11 |
| Ra-228 | 5.9E-15 | Sm-153  | 5.9E-11 |
| Rb-81  | 5.0E-10 | Sn-113  | 1.4E-12 |
| Rb-83  | 3.4E-13 | Sn-117m | 5.6E-12 |
| Rb-84  | 3.6E-13 | Sn-119m | 5.3E-12 |
| Rb-86  | 5.6E-13 | Sn-123  | 1.1E-12 |
| Rb-87  | 1.6E-13 | Sn-125  | 1.7E-12 |
| Rb-88  | 2.1E-09 | Sn-126  | 5.3E-15 |
| Rb-89  | 7.1E-10 | Sr-82   | 6.2E-13 |
| Re-184 | 1.5E-12 | Sr-85   | 1.8E-12 |
| Sr-85m | 1.6E-09 | Th-232  | 6.2E-16 |
| Sr-87m | 1.4E-09 | Th-234  | 2.2E-12 |
| Sr-89  | 1.8E-12 | Ti-44   | 6.2E-15 |
| Sr-90  | 1.9E-14 | Ti-45   | 4.8E-10 |
| Sr-91  | 9.1E-11 | Tl-200  | 4.5E-11 |
| Sr-92  | 2.9E-10 | Tl-201  | 1.0E-10 |
| Ta-182 | 4.5E-13 | Tl-202  | 5.0E-12 |
| Tb-157 | 2.5E-12 | Tl-204  | 1.2E-12 |
| Tb-160 | 7.7E-13 | Tm-170  | 3.3E-12 |
| Tc-95  | 1.0E-10 | Tm-171  | 2.6E-11 |
| Tc-95m | 1.4E-12 | U-230   | 1.5E-14 |
| Tc-96  | 5.6E-12 | U-231   | 4.2E-11 |

|         |         |         |         |
|---------|---------|---------|---------|
| Tc-96m  | 6.7E-10 | U-232   | 1.3E-15 |
| Tc-97   | 7.1E-13 | U-233   | 7.1E-15 |
| Tc-97m  | 7.1E-12 | U-234   | 7.7E-15 |
| Tc-98   | 6.7E-15 | U-235   | 7.1E-15 |
| Tc-99   | 1.4E-13 | U-236   | 7.7E-15 |
| Tc-99m  | 1.7E-09 | U-237   | 1.0E-11 |
| Tc-101  | 4.5E-09 | U-238   | 8.3E-15 |
| Te-121  | 1.0E-12 | U-239   | 4.3E-09 |
| Te-121m | 1.2E-13 | U-240   | 1.3E-10 |
| Te-123  | 1.4E-13 | V-48    | 1.0E-12 |
| Te-123m | 2.0E-13 | V-49    | 1.6E-10 |
| Te-125m | 3.6E-13 | W-181   | 6.7E-12 |
| Te-127  | 1.0E-09 | W-185   | 2.6E-12 |
| Te-127m | 1.5E-13 | W-187   | 7.7E-11 |
| Te-129  | 7.7E-09 | W-188   | 5.3E-13 |
| Te-129m | 1.4E-13 | Xe-122  | 9.1E-11 |
| Te-131  | 9.1E-11 | Xe-123  | 1.6E-09 |
| Te-131m | 1.0E-12 | Xe-125  | 1.1E-11 |
| Te-132  | 7.1E-13 | Xe-127  | 8.3E-09 |
| Te-133  | 9.1E-10 | Xe-129m | 9.1E-08 |
| Te-133m | 2.2E-10 | Xe-131m | 2.6E-07 |
| Te-134  | 5.3E-10 | Xe-133  | 6.2E-08 |
| Th-226  | 3.4E-11 | Xe-133m | 7.1E-08 |
| Th-227  | 3.8E-14 | Xe-135  | 9.1E-09 |
| Th-228  | 3.1E-15 | Xe-135m | 5.0E-09 |
| Th-229  | 5.3E-16 | Xe-138  | 1.2E-09 |
| Th-230  | 3.4E-15 | Y-86    | 3.0E-11 |
| Th-231  | 2.9E-10 | Y-87    | 1.7E-11 |
| Y-88    | 2.7E-13 | Zn-65   | 9.1E-14 |
| Y-90    | 1.3E-11 | Zn-69   | 3.2E-08 |

|        |         |        |         |
|--------|---------|--------|---------|
| Y-90m  | 1.9E-10 | Zn-69m | 1.7E-10 |
| Y-91   | 2.1E-12 | Zr-86  | 2.4E-11 |
| Y-91m  | 1.3E-09 | Zr-88  | 3.1E-13 |
| Y-92   | 8.3E-10 | Zr-89  | 1.3E-11 |
| Y-93   | 2.9E-10 | Zr-93  | 2.6E-12 |
| Yb-169 | 3.7E-12 | Zr-95  | 6.7E-13 |
| Yb-175 | 4.3E-11 | Zr-97  | 3.8E-11 |
| Zn-62  | 9.1E-11 |        |         |

### 6. References

(1) Environmental Protection Agency, "A Guide for Determining Compliance with the Clean Air Act Standards for Radionuclides Emissions from NRC-Licensed and Non-DOE Federal Facilities", EPA 520/1-89-002, October 1989.

(2) Environmental Protection Agency, "User's Guide for the COMPLY Code", EPA 520/1-89-003, October 1989.

(3) Environmental Protection Agency, "Background Information Document: Procedures Approved for Demonstrating Compliance with 40 CFR Part 61, Subpart I", EPA 520/1-89-001, January 1989.

(4) National Council on Radiation Protection and Measurement, "Screening Techniques for Determining Compliance with Environmental Standards" NCRP Commentary No. 3, Revision of January 1989 with addendum of October, 1989.

[54 FR 51711, Dec. 15, 1989]

**Appendix M**

40 C.F.R. Part 63 Subpart ZZZZ- *NESHAP for Reciprocating Internal Combustion Engines*

## Subpart ZZZZ—National Emissions Standards for Hazardous Air Pollutants for Stationary Reciprocating Internal Combustion Engines

SOURCE: 69 FR 33506, June 15, 2004, unless otherwise noted.

### WHAT THIS SUBPART COVERS

#### §63.6580 What is the purpose of subpart ZZZZ?

Subpart ZZZZ establishes national emission limitations and operating limitations for hazardous air pollutants (HAP) emitted from stationary reciprocating internal combustion engines (RICE) located at major and area sources of HAP emissions. This subpart also establishes requirements to demonstrate initial and continuous compliance with the emission limitations and operating limitations.

[73 FR 3603, Jan. 18, 2008]

#### §63.6585 Am I subject to this subpart?

You are subject to this subpart if you own or operate a stationary RICE at a major or area source of HAP emissions, except if the stationary RICE is being tested at a stationary RICE test cell/stand.

(a) A stationary RICE is any internal combustion engine which uses reciprocating motion to convert heat energy into mechanical work and which is not mobile. Stationary RICE differ from mobile RICE in that a stationary RICE is not a non-road engine as defined at 40 CFR 1068.30, and is not used to propel a motor vehicle or a vehicle used solely for competition.

(b) A major source of HAP emissions is a plant site that emits or has the potential to emit any single HAP at a rate of 10 tons (9.07 megagrams) or more per year or any combination of HAP at a rate of 25 tons (22.68 megagrams) or more per year, except that for oil and gas production facilities, a major source of HAP emissions is determined for each surface site.

(c) An area source of HAP emissions is a source that is not a major source.

(d) If you are an owner or operator of an area source subject to this subpart, your status as an entity subject to a standard or other requirements under this subpart does not subject you to the obligation to obtain a permit under 40 CFR part 70 or 71, provided you are not required to obtain a permit under 40 CFR 70.3(a) or 40 CFR 71.3(a) for a reason other than your status as an area source under this subpart. Notwithstanding the previous sentence, you must continue to comply with the provisions of this subpart as applicable.

(e) If you are an owner or operator of a stationary RICE used for national security purposes, you may be eligible to request an exemption from the requirements of this subpart as described in 40 CFR part 1068, subpart C.

(f) The emergency stationary RICE listed in paragraphs (f)(1) through (3) of this section are not subject to this subpart. The stationary RICE must meet the definition of an emergency stationary RICE in §63.6675, which includes operating according to the provisions specified in §63.6640(f).

(1) Existing residential emergency stationary RICE located at an area source of HAP emissions that do not operate or are not contractually obligated to be available for more than 15 hours per calendar year



for the purposes specified in §63.6640(f)(2)(ii) and (iii) and that do not operate for the purpose specified in §63.6640(f)(4)(ii).

(2) Existing commercial emergency stationary RICE located at an area source of HAP emissions that do not operate or are not contractually obligated to be available for more than 15 hours per calendar year for the purposes specified in §63.6640(f)(2)(ii) and (iii) and that do not operate for the purpose specified in §63.6640(f)(4)(ii).

(3) Existing institutional emergency stationary RICE located at an area source of HAP emissions that do not operate or are not contractually obligated to be available for more than 15 hours per calendar year for the purposes specified in §63.6640(f)(2)(ii) and (iii) and that do not operate for the purpose specified in §63.6640(f)(4)(ii).

[69 FR 33506, June 15, 2004, as amended at 73 FR 3603, Jan. 18, 2008; 78 FR 6700, Jan. 30, 2013]

### **§63.6590 What parts of my plant does this subpart cover?**

This subpart applies to each affected source.

(a) *Affected source.* An affected source is any existing, new, or reconstructed stationary RICE located at a major or area source of HAP emissions, excluding stationary RICE being tested at a stationary RICE test cell/stand.

#### (1) *Existing stationary RICE.*

(i) For stationary RICE with a site rating of more than 500 brake horsepower (HP) located at a major source of HAP emissions, a stationary RICE is existing if you commenced construction or reconstruction of the stationary RICE before December 19, 2002.

(ii) For stationary RICE with a site rating of less than or equal to 500 brake HP located at a major source of HAP emissions, a stationary RICE is existing if you commenced construction or reconstruction of the stationary RICE before June 12, 2006.

(iii) For stationary RICE located at an area source of HAP emissions, a stationary RICE is existing if you commenced construction or reconstruction of the stationary RICE before June 12, 2006.

(iv) A change in ownership of an existing stationary RICE does not make that stationary RICE a new or reconstructed stationary RICE.

(2) *New stationary RICE.* (i) A stationary RICE with a site rating of more than 500 brake HP located at a major source of HAP emissions is new if you commenced construction of the stationary RICE on or after December 19, 2002.

(ii) A stationary RICE with a site rating of equal to or less than 500 brake HP located at a major source of HAP emissions is new if you commenced construction of the stationary RICE on or after June 12, 2006.

(iii) A stationary RICE located at an area source of HAP emissions is new if you commenced construction of the stationary RICE on or after June 12, 2006.

(3) *Reconstructed stationary RICE.* (i) A stationary RICE with a site rating of more than 500 brake HP located at a major source of HAP emissions is reconstructed if you meet the definition of reconstruction in §63.2 and reconstruction is commenced on or after December 19, 2002.

(ii) A stationary RICE with a site rating of equal to or less than 500 brake HP located at a major source of HAP emissions is reconstructed if you meet the definition of reconstruction in §63.2 and reconstruction is commenced on or after June 12, 2006.

(iii) A stationary RICE located at an area source of HAP emissions is reconstructed if you meet the definition of reconstruction in §63.2 and reconstruction is commenced on or after June 12, 2006.

(b) *Stationary RICE subject to limited requirements.* (1) An affected source which meets either of the criteria in paragraphs (b)(1)(i) through (ii) of this section does not have to meet the requirements of this subpart and of subpart A of this part except for the initial notification requirements of §63.6645(f).

(i) The stationary RICE is a new or reconstructed emergency stationary RICE with a site rating of more than 500 brake HP located at a major source of HAP emissions that does not operate or is not contractually obligated to be available for more than 15 hours per calendar year for the purposes specified in §63.6640(f)(2)(ii) and (iii).

(ii) The stationary RICE is a new or reconstructed limited use stationary RICE with a site rating of more than 500 brake HP located at a major source of HAP emissions.

(2) A new or reconstructed stationary RICE with a site rating of more than 500 brake HP located at a major source of HAP emissions which combusts landfill or digester gas equivalent to 10 percent or more of the gross heat input on an annual basis must meet the initial notification requirements of §63.6645(f) and the requirements of §§63.6625(c), 63.6650(g), and 63.6655(c). These stationary RICE do not have to meet the emission limitations and operating limitations of this subpart.

(3) The following stationary RICE do not have to meet the requirements of this subpart and of subpart A of this part, including initial notification requirements:

(i) Existing spark ignition 2 stroke lean burn (2SLB) stationary RICE with a site rating of more than 500 brake HP located at a major source of HAP emissions;

(ii) Existing spark ignition 4 stroke lean burn (4SLB) stationary RICE with a site rating of more than 500 brake HP located at a major source of HAP emissions;

(iii) Existing emergency stationary RICE with a site rating of more than 500 brake HP located at a major source of HAP emissions that does not operate or is not contractually obligated to be available for more than 15 hours per calendar year for the purposes specified in §63.6640(f)(2)(ii) and (iii).

(iv) Existing limited use stationary RICE with a site rating of more than 500 brake HP located at a major source of HAP emissions;

(v) Existing stationary RICE with a site rating of more than 500 brake HP located at a major source of HAP emissions that combusts landfill gas or digester gas equivalent to 10 percent or more of the gross heat input on an annual basis;

(c) *Stationary RICE subject to Regulations under 40 CFR Part 60.* An affected source that meets any of the criteria in paragraphs (c)(1) through (7) of this section must meet the requirements of this part by meeting the requirements of 40 CFR part 60 subpart IIII, for compression ignition engines or 40 CFR part 60 subpart JJJJ, for spark ignition engines. No further requirements apply for such engines under this part.

(1) A new or reconstructed stationary RICE located at an area source;

(2) A new or reconstructed 2SLB stationary RICE with a site rating of less than or equal to 500 brake HP located at a major source of HAP emissions;

(3) A new or reconstructed 4SLB stationary RICE with a site rating of less than 250 brake HP located at a major source of HAP emissions;

(4) A new or reconstructed spark ignition 4 stroke rich burn (4SRB) stationary RICE with a site rating of less than or equal to 500 brake HP located at a major source of HAP emissions;

(5) A new or reconstructed stationary RICE with a site rating of less than or equal to 500 brake HP located at a major source of HAP emissions which combusts landfill or digester gas equivalent to 10 percent or more of the gross heat input on an annual basis;

(6) A new or reconstructed emergency or limited use stationary RICE with a site rating of less than or equal to 500 brake HP located at a major source of HAP emissions;

(7) A new or reconstructed compression ignition (CI) stationary RICE with a site rating of less than or equal to 500 brake HP located at a major source of HAP emissions.

[69 FR 33506, June 15, 2004, as amended at 73 FR 3604, Jan. 18, 2008; 75 FR 9674, Mar. 3, 2010; 75 FR 37733, June 30, 2010; 75 FR 51588, Aug. 20, 2010; 78 FR 6700, Jan. 30, 2013]

### **§63.6595 When do I have to comply with this subpart?**

(a) *Affected sources.* (1) If you have an existing stationary RICE, excluding existing non-emergency CI stationary RICE, with a site rating of more than 500 brake HP located at a major source of HAP emissions, you must comply with the applicable emission limitations, operating limitations and other requirements no later than June 15, 2007. If you have an existing non-emergency CI stationary RICE with a site rating of more than 500 brake HP located at a major source of HAP emissions, an existing stationary CI RICE with a site rating of less than or equal to 500 brake HP located at a major source of HAP emissions, or an existing stationary CI RICE located at an area source of HAP emissions, you must comply with the applicable emission limitations, operating limitations, and other requirements no later than May 3, 2013. If you have an existing stationary SI RICE with a site rating of less than or equal to 500 brake HP located at a major source of HAP emissions, or an existing stationary SI RICE located at an area source of HAP emissions, you must comply with the applicable emission limitations, operating limitations, and other requirements no later than October 19, 2013.

(2) If you start up your new or reconstructed stationary RICE with a site rating of more than 500 brake HP located at a major source of HAP emissions before August 16, 2004, you must comply with the applicable emission limitations and operating limitations in this subpart no later than August 16, 2004.

(3) If you start up your new or reconstructed stationary RICE with a site rating of more than 500 brake HP located at a major source of HAP emissions after August 16, 2004, you must comply with the applicable emission limitations and operating limitations in this subpart upon startup of your affected source.

(4) If you start up your new or reconstructed stationary RICE with a site rating of less than or equal to 500 brake HP located at a major source of HAP emissions before January 18, 2008, you must comply with the applicable emission limitations and operating limitations in this subpart no later than January 18, 2008.

(5) If you start up your new or reconstructed stationary RICE with a site rating of less than or equal to 500 brake HP located at a major source of HAP emissions after January 18, 2008, you must comply

with the applicable emission limitations and operating limitations in this subpart upon startup of your affected source.

(6) If you start up your new or reconstructed stationary RICE located at an area source of HAP emissions before January 18, 2008, you must comply with the applicable emission limitations and operating limitations in this subpart no later than January 18, 2008.

(7) If you start up your new or reconstructed stationary RICE located at an area source of HAP emissions after January 18, 2008, you must comply with the applicable emission limitations and operating limitations in this subpart upon startup of your affected source.

(b) *Area sources that become major sources.* If you have an area source that increases its emissions or its potential to emit such that it becomes a major source of HAP, the compliance dates in paragraphs (b)(1) and (2) of this section apply to you.

(1) Any stationary RICE for which construction or reconstruction is commenced after the date when your area source becomes a major source of HAP must be in compliance with this subpart upon startup of your affected source.

(2) Any stationary RICE for which construction or reconstruction is commenced before your area source becomes a major source of HAP must be in compliance with the provisions of this subpart that are applicable to RICE located at major sources within 3 years after your area source becomes a major source of HAP.

(c) If you own or operate an affected source, you must meet the applicable notification requirements in §63.6645 and in 40 CFR part 63, subpart A.

[69 FR 33506, June 15, 2004, as amended at 73 FR 3604, Jan. 18, 2008; 75 FR 9675, Mar. 3, 2010; 75 FR 51589, Aug. 20, 2010; 78 FR 6701, Jan. 30, 2013]

## **EMISSION AND OPERATING LIMITATIONS**

### **§63.6600 What emission limitations and operating limitations must I meet if I own or operate a stationary RICE with a site rating of more than 500 brake HP located at a major source of HAP emissions?**

Compliance with the numerical emission limitations established in this subpart is based on the results of testing the average of three 1-hour runs using the testing requirements and procedures in §63.6620 and Table 4 to this subpart.

(a) If you own or operate an existing, new, or reconstructed spark ignition 4SRB stationary RICE with a site rating of more than 500 brake HP located at a major source of HAP emissions, you must comply with the emission limitations in Table 1a to this subpart and the operating limitations in Table 1b to this subpart which apply to you.

(b) If you own or operate a new or reconstructed 2SLB stationary RICE with a site rating of more than 500 brake HP located at major source of HAP emissions, a new or reconstructed 4SLB stationary RICE with a site rating of more than 500 brake HP located at major source of HAP emissions, or a new or reconstructed CI stationary RICE with a site rating of more than 500 brake HP located at a major source of HAP emissions, you must comply with the emission limitations in Table 2a to this subpart and the operating limitations in Table 2b to this subpart which apply to you.

(c) If you own or operate any of the following stationary RICE with a site rating of more than 500 brake HP located at a major source of HAP emissions, you do not need to comply with the emission limitations in Tables 1a, 2a, 2c, and 2d to this subpart or operating limitations in Tables 1b and 2b to this subpart: an existing 2SLB stationary RICE; an existing 4SLB stationary RICE; a stationary RICE that combusts landfill gas or digester gas equivalent to 10 percent or more of the gross heat input on an annual basis; an emergency stationary RICE; or a limited use stationary RICE.

(d) If you own or operate an existing non-emergency stationary CI RICE with a site rating of more than 500 brake HP located at a major source of HAP emissions, you must comply with the emission limitations in Table 2c to this subpart and the operating limitations in Table 2b to this subpart which apply to you.

[73 FR 3605, Jan. 18, 2008, as amended at 75 FR 9675, Mar. 3, 2010]

**§63.6601 What emission limitations must I meet if I own or operate a new or reconstructed 4SLB stationary RICE with a site rating of greater than or equal to 250 brake HP and less than or equal to 500 brake HP located at a major source of HAP emissions?**

Compliance with the numerical emission limitations established in this subpart is based on the results of testing the average of three 1-hour runs using the testing requirements and procedures in §63.6620 and Table 4 to this subpart. If you own or operate a new or reconstructed 4SLB stationary RICE with a site rating of greater than or equal to 250 and less than or equal to 500 brake HP located at major source of HAP emissions manufactured on or after January 1, 2008, you must comply with the emission limitations in Table 2a to this subpart and the operating limitations in Table 2b to this subpart which apply to you.

[73 FR 3605, Jan. 18, 2008, as amended at 75 FR 9675, Mar. 3, 2010; 75 FR 51589, Aug. 20, 2010]

**§63.6602 What emission limitations and other requirements must I meet if I own or operate an existing stationary RICE with a site rating of equal to or less than 500 brake HP located at a major source of HAP emissions?**

If you own or operate an existing stationary RICE with a site rating of equal to or less than 500 brake HP located at a major source of HAP emissions, you must comply with the emission limitations and other requirements in Table 2c to this subpart which apply to you. Compliance with the numerical emission limitations established in this subpart is based on the results of testing the average of three 1-hour runs using the testing requirements and procedures in §63.6620 and Table 4 to this subpart.

[78 FR 6701, Jan. 30, 2013]

**§63.6603 What emission limitations, operating limitations, and other requirements must I meet if I own or operate an existing stationary RICE located at an area source of HAP emissions?**

Compliance with the numerical emission limitations established in this subpart is based on the results of testing the average of three 1-hour runs using the testing requirements and procedures in §63.6620 and Table 4 to this subpart.

(a) If you own or operate an existing stationary RICE located at an area source of HAP emissions, you must comply with the requirements in Table 2d to this subpart and the operating limitations in Table 2b to this subpart that apply to you.

(b) If you own or operate an existing stationary non-emergency CI RICE with a site rating of more than 300 HP located at an area source of HAP that meets either paragraph (b)(1) or (2) of this section, you do not have to meet the numerical CO emission limitations specified in Table 2d of this subpart.

Existing stationary non-emergency CI RICE with a site rating of more than 300 HP located at an area source of HAP that meet either paragraph (b)(1) or (2) of this section must meet the management practices that are shown for stationary non-emergency CI RICE with a site rating of less than or equal to 300 HP in Table 2d of this subpart.

(1) The area source is located in an area of Alaska that is not accessible by the Federal Aid Highway System (FAHS).

(2) The stationary RICE is located at an area source that meets paragraphs (b)(2)(i), (ii), and (iii) of this section.

(i) The only connection to the FAHS is through the Alaska Marine Highway System (AMHS), or the stationary RICE operation is within an isolated grid in Alaska that is not connected to the statewide electrical grid referred to as the Alaska Railbelt Grid.

(ii) At least 10 percent of the power generated by the stationary RICE on an annual basis is used for residential purposes.

(iii) The generating capacity of the area source is less than 12 megawatts, or the stationary RICE is used exclusively for backup power for renewable energy.

(c) If you own or operate an existing stationary non-emergency CI RICE with a site rating of more than 300 HP located on an offshore vessel that is an area source of HAP and is a nonroad vehicle that is an Outer Continental Shelf (OCS) source as defined in 40 CFR 55.2, you do not have to meet the numerical CO emission limitations specified in Table 2d of this subpart. You must meet all of the following management practices:

(1) Change oil every 1,000 hours of operation or annually, whichever comes first. Sources have the option to utilize an oil analysis program as described in §63.6625(i) in order to extend the specified oil change requirement.

(2) Inspect and clean air filters every 750 hours of operation or annually, whichever comes first, and replace as necessary.

(3) Inspect fuel filters and belts, if installed, every 750 hours of operation or annually, whichever comes first, and replace as necessary.

(4) Inspect all flexible hoses every 1,000 hours of operation or annually, whichever comes first, and replace as necessary.

(d) If you own or operate an existing non-emergency CI RICE with a site rating of more than 300 HP located at an area source of HAP emissions that is certified to the Tier 1 or Tier 2 emission standards in Table 1 of 40 CFR 89.112 and that is subject to an enforceable state or local standard that requires the engine to be replaced no later than June 1, 2018, you may until January 1, 2015, or 12 years after the installation date of the engine (whichever is later), but not later than June 1, 2018, choose to comply with the management practices that are shown for stationary non-emergency CI RICE with a site rating of less than or equal to 300 HP in Table 2d of this subpart instead of the applicable emission limitations in Table 2d, operating limitations in Table 2b, and crankcase ventilation system requirements in §63.6625(g). You must comply with the emission limitations in Table 2d and operating limitations in Table 2b that apply for non-emergency CI RICE with a site rating of more than 300 HP located at an area source of HAP emissions by January 1, 2015, or 12 years after the installation date of the engine (whichever is later), but not later than June 1, 2018. You must also comply with the crankcase ventilation system requirements in

§63.6625(g) by January 1, 2015, or 12 years after the installation date of the engine (whichever is later), but not later than June 1, 2018.

(e) If you own or operate an existing non-emergency CI RICE with a site rating of more than 300 HP located at an area source of HAP emissions that is certified to the Tier 3 (Tier 2 for engines above 560 kilowatt (kW)) emission standards in Table 1 of 40 CFR 89.112, you may comply with the requirements under this part by meeting the requirements for Tier 3 engines (Tier 2 for engines above 560 kW) in 40 CFR part 60 subpart IIII instead of the emission limitations and other requirements that would otherwise apply under this part for existing non-emergency CI RICE with a site rating of more than 300 HP located at an area source of HAP emissions.

(f) An existing non-emergency SI 4SLB and 4SRB stationary RICE with a site rating of more than 500 HP located at area sources of HAP must meet the definition of remote stationary RICE in §63.6675 on the initial compliance date for the engine, October 19, 2013, in order to be considered a remote stationary RICE under this subpart. Owners and operators of existing non-emergency SI 4SLB and 4SRB stationary RICE with a site rating of more than 500 HP located at area sources of HAP that meet the definition of remote stationary RICE in §63.6675 of this subpart as of October 19, 2013 must evaluate the status of their stationary RICE every 12 months. Owners and operators must keep records of the initial and annual evaluation of the status of the engine. If the evaluation indicates that the stationary RICE no longer meets the definition of remote stationary RICE in §63.6675 of this subpart, the owner or operator must comply with all of the requirements for existing non-emergency SI 4SLB and 4SRB stationary RICE with a site rating of more than 500 HP located at area sources of HAP that are not remote stationary RICE within 1 year of the evaluation.

[75 FR 9675, Mar. 3, 2010, as amended at 75 FR 51589, Aug. 20, 2010; 76 FR 12866, Mar. 9, 2011; 78 FR 6701, Jan. 30, 2013]

#### **§63.6604 What fuel requirements must I meet if I own or operate a stationary CI RICE?**

(a) If you own or operate an existing non-emergency, non-black start CI stationary RICE with a site rating of more than 300 brake HP with a displacement of less than 30 liters per cylinder that uses diesel fuel, you must use diesel fuel that meets the requirements in 40 CFR 80.510(b) for nonroad diesel fuel.

(b) Beginning January 1, 2015, if you own or operate an existing emergency CI stationary RICE with a site rating of more than 100 brake HP and a displacement of less than 30 liters per cylinder that uses diesel fuel and operates or is contractually obligated to be available for more than 15 hours per calendar year for the purposes specified in §63.6640(f)(2)(ii) and (iii) or that operates for the purpose specified in §63.6640(f)(4)(ii), you must use diesel fuel that meets the requirements in 40 CFR 80.510(b) for nonroad diesel fuel, except that any existing diesel fuel purchased (or otherwise obtained) prior to January 1, 2015, may be used until depleted.

(c) Beginning January 1, 2015, if you own or operate a new emergency CI stationary RICE with a site rating of more than 500 brake HP and a displacement of less than 30 liters per cylinder located at a major source of HAP that uses diesel fuel and operates or is contractually obligated to be available for more than 15 hours per calendar year for the purposes specified in §63.6640(f)(2)(ii) and (iii), you must use diesel fuel that meets the requirements in 40 CFR 80.510(b) for nonroad diesel fuel, except that any existing diesel fuel purchased (or otherwise obtained) prior to January 1, 2015, may be used until depleted.

(d) Existing CI stationary RICE located in Guam, American Samoa, the Commonwealth of the Northern Mariana Islands, at area sources in areas of Alaska that meet either §63.6603(b)(1) or §63.6603(b)(2), or are on offshore vessels that meet §63.6603(c) are exempt from the requirements of this section.

[78 FR 6702, Jan. 30, 2013]

## **GENERAL COMPLIANCE REQUIREMENTS**

### **§63.6605 What are my general requirements for complying with this subpart?**

(a) You must be in compliance with the emission limitations, operating limitations, and other requirements in this subpart that apply to you at all times.

(b) At all times you must operate and maintain any affected source, including associated air pollution control equipment and monitoring equipment, in a manner consistent with safety and good air pollution control practices for minimizing emissions. The general duty to minimize emissions does not require you to make any further efforts to reduce emissions if levels required by this standard have been achieved. Determination of whether such operation and maintenance procedures are being used will be based on information available to the Administrator which may include, but is not limited to, monitoring results, review of operation and maintenance procedures, review of operation and maintenance records, and inspection of the source.

[75 FR 9675, Mar. 3, 2010, as amended at 78 FR 6702, Jan. 30, 2013]

## **TESTING AND INITIAL COMPLIANCE REQUIREMENTS**

### **§63.6610 By what date must I conduct the initial performance tests or other initial compliance demonstrations if I own or operate a stationary RICE with a site rating of more than 500 brake HP located at a major source of HAP emissions?**

If you own or operate a stationary RICE with a site rating of more than 500 brake HP located at a major source of HAP emissions you are subject to the requirements of this section.

(a) You must conduct the initial performance test or other initial compliance demonstrations in Table 4 to this subpart that apply to you within 180 days after the compliance date that is specified for your stationary RICE in §63.6595 and according to the provisions in §63.7(a)(2).

(b) If you commenced construction or reconstruction between December 19, 2002 and June 15, 2004 and own or operate stationary RICE with a site rating of more than 500 brake HP located at a major source of HAP emissions, you must demonstrate initial compliance with either the proposed emission limitations or the promulgated emission limitations no later than February 10, 2005 or no later than 180 days after startup of the source, whichever is later, according to §63.7(a)(2)(ix).

(c) If you commenced construction or reconstruction between December 19, 2002 and June 15, 2004 and own or operate stationary RICE with a site rating of more than 500 brake HP located at a major source of HAP emissions, and you chose to comply with the proposed emission limitations when demonstrating initial compliance, you must conduct a second performance test to demonstrate compliance with the promulgated emission limitations by December 13, 2007 or after startup of the source, whichever is later, according to §63.7(a)(2)(ix).

(d) An owner or operator is not required to conduct an initial performance test on units for which a performance test has been previously conducted, but the test must meet all of the conditions described in paragraphs (d)(1) through (5) of this section.

(1) The test must have been conducted using the same methods specified in this subpart, and these methods must have been followed correctly.



(2) The test must not be older than 2 years.

(3) The test must be reviewed and accepted by the Administrator.

(4) Either no process or equipment changes must have been made since the test was performed, or the owner or operator must be able to demonstrate that the results of the performance test, with or without adjustments, reliably demonstrate compliance despite process or equipment changes.

(5) The test must be conducted at any load condition within plus or minus 10 percent of 100 percent load.

[69 FR 33506, June 15, 2004, as amended at 73 FR 3605, Jan. 18, 2008]

**§63.6611 By what date must I conduct the initial performance tests or other initial compliance demonstrations if I own or operate a new or reconstructed 4SLB SI stationary RICE with a site rating of greater than or equal to 250 and less than or equal to 500 brake HP located at a major source of HAP emissions?**

If you own or operate a new or reconstructed 4SLB stationary RICE with a site rating of greater than or equal to 250 and less than or equal to 500 brake HP located at a major source of HAP emissions, you must conduct an initial performance test within 240 days after the compliance date that is specified for your stationary RICE in §63.6595 and according to the provisions specified in Table 4 to this subpart, as appropriate.

[73 FR 3605, Jan. 18, 2008, as amended at 75 FR 51589, Aug. 20, 2010]

**§63.6612 By what date must I conduct the initial performance tests or other initial compliance demonstrations if I own or operate an existing stationary RICE with a site rating of less than or equal to 500 brake HP located at a major source of HAP emissions or an existing stationary RICE located at an area source of HAP emissions?**

If you own or operate an existing stationary RICE with a site rating of less than or equal to 500 brake HP located at a major source of HAP emissions or an existing stationary RICE located at an area source of HAP emissions you are subject to the requirements of this section.

(a) You must conduct any initial performance test or other initial compliance demonstration according to Tables 4 and 5 to this subpart that apply to you within 180 days after the compliance date that is specified for your stationary RICE in §63.6595 and according to the provisions in §63.7(a)(2).

(b) An owner or operator is not required to conduct an initial performance test on a unit for which a performance test has been previously conducted, but the test must meet all of the conditions described in paragraphs (b)(1) through (4) of this section.

(1) The test must have been conducted using the same methods specified in this subpart, and these methods must have been followed correctly.

(2) The test must not be older than 2 years.

(3) The test must be reviewed and accepted by the Administrator.

(4) Either no process or equipment changes must have been made since the test was performed, or the owner or operator must be able to demonstrate that the results of the performance test, with or without adjustments, reliably demonstrate compliance despite process or equipment changes.

**§63.6615 When must I conduct subsequent performance tests?**

If you must comply with the emission limitations and operating limitations, you must conduct subsequent performance tests as specified in Table 3 of this subpart.

**§63.6620 What performance tests and other procedures must I use?**

(a) You must conduct each performance test in Tables 3 and 4 of this subpart that applies to you.

(b) Each performance test must be conducted according to the requirements that this subpart specifies in Table 4 to this subpart. If you own or operate a non-operational stationary RICE that is subject to performance testing, you do not need to start up the engine solely to conduct the performance test. Owners and operators of a non-operational engine can conduct the performance test when the engine is started up again. The test must be conducted at any load condition within plus or minus 10 percent of 100 percent load for the stationary RICE listed in paragraphs (b)(1) through (4) of this section.

(1) Non-emergency 4SRB stationary RICE with a site rating of greater than 500 brake HP located at a major source of HAP emissions.

(2) New non-emergency 4SLB stationary RICE with a site rating of greater than or equal to 250 brake HP located at a major source of HAP emissions.

(3) New non-emergency 2SLB stationary RICE with a site rating of greater than 500 brake HP located at a major source of HAP emissions.

(4) New non-emergency CI stationary RICE with a site rating of greater than 500 brake HP located at a major source of HAP emissions.

(c) [Reserved]

(d) You must conduct three separate test runs for each performance test required in this section, as specified in §63.7(e)(3). Each test run must last at least 1 hour, unless otherwise specified in this subpart.

(e)(1) You must use Equation 1 of this section to determine compliance with the percent reduction requirement:

$$\frac{C_i - C_o}{C_i} \times 100 = R \quad (\text{Eq. 1})$$

Where:

$C_i$  = concentration of carbon monoxide (CO), total hydrocarbons (THC), or formaldehyde at the control device inlet,

$C_o$  = concentration of CO, THC, or formaldehyde at the control device outlet, and

R = percent reduction of CO, THC, or formaldehyde emissions.

(2) You must normalize the CO, THC, or formaldehyde concentrations at the inlet and outlet of the control device to a dry basis and to 15 percent oxygen, or an equivalent percent carbon dioxide (CO<sub>2</sub>). If pollutant concentrations are to be corrected to 15 percent oxygen and CO<sub>2</sub> concentration is measured in lieu of oxygen concentration measurement, a CO<sub>2</sub> correction factor is needed. Calculate the CO<sub>2</sub> correction factor as described in paragraphs (e)(2)(i) through (iii) of this section.

(i) Calculate the fuel-specific  $F_o$  value for the fuel burned during the test using values obtained from Method 19, Section 5.2, and the following equation:

$$F_o = \frac{0.209 F_d}{F_c} \quad (\text{Eq. 2})$$

Where:

$F_o$  = Fuel factor based on the ratio of oxygen volume to the ultimate  $\text{CO}_2$  volume produced by the fuel at zero percent excess air.

0.209 = Fraction of air that is oxygen, percent/100.

$F_d$  = Ratio of the volume of dry effluent gas to the gross calorific value of the fuel from Method 19,  $\text{dsm}^3/\text{J}$  ( $\text{dscf}/10^6 \text{ Btu}$ ).

$F_c$  = Ratio of the volume of  $\text{CO}_2$  produced to the gross calorific value of the fuel from Method 19,  $\text{dsm}^3/\text{J}$  ( $\text{dscf}/10^6 \text{ Btu}$ )

(ii) Calculate the  $\text{CO}_2$  correction factor for correcting measurement data to 15 percent  $\text{O}_2$ , as follows:

$$X_{\text{CO}_2} = \frac{5.9}{F_o} \quad (\text{Eq. 3})$$

Where:

$X_{\text{CO}_2}$  =  $\text{CO}_2$  correction factor, percent.

5.9 = 20.9 percent  $\text{O}_2$ —15 percent  $\text{O}_2$ , the defined  $\text{O}_2$  correction value, percent.

(iii) Calculate the CO, THC, and formaldehyde gas concentrations adjusted to 15 percent  $\text{O}_2$  using  $\text{CO}_2$  as follows:

$$C_{\text{adj}} = C_d \frac{X_{\text{CO}_2}}{\% \text{CO}_2} \quad (\text{Eq. 4})$$

Where:

$C_{\text{adj}}$  = Calculated concentration of CO, THC, or formaldehyde adjusted to 15 percent  $\text{O}_2$ .

$C_d$  = Measured concentration of CO, THC, or formaldehyde, uncorrected.

$X_{\text{CO}_2}$  =  $\text{CO}_2$  correction factor, percent.

$\% \text{CO}_2$  = Measured  $\text{CO}_2$  concentration measured, dry basis, percent.

(f) If you comply with the emission limitation to reduce CO and you are not using an oxidation catalyst, if you comply with the emission limitation to reduce formaldehyde and you are not using NSCR, or if you comply with the emission limitation to limit the concentration of formaldehyde in the stationary RICE exhaust and you are not using an oxidation catalyst or NSCR, you must petition the Administrator for operating limitations to be established during the initial performance test and continuously monitored thereafter; or for approval of no operating limitations. You must not conduct the initial performance test until after the petition has been approved by the Administrator.

(g) If you petition the Administrator for approval of operating limitations, your petition must include the information described in paragraphs (g)(1) through (5) of this section.

(1) Identification of the specific parameters you propose to use as operating limitations;

(2) A discussion of the relationship between these parameters and HAP emissions, identifying how HAP emissions change with changes in these parameters, and how limitations on these parameters will serve to limit HAP emissions;

(3) A discussion of how you will establish the upper and/or lower values for these parameters which will establish the limits on these parameters in the operating limitations;

(4) A discussion identifying the methods you will use to measure and the instruments you will use to monitor these parameters, as well as the relative accuracy and precision of these methods and instruments; and

(5) A discussion identifying the frequency and methods for recalibrating the instruments you will use for monitoring these parameters.

(h) If you petition the Administrator for approval of no operating limitations, your petition must include the information described in paragraphs (h)(1) through (7) of this section.

(1) Identification of the parameters associated with operation of the stationary RICE and any emission control device which could change intentionally (e.g., operator adjustment, automatic controller adjustment, etc.) or unintentionally (e.g., wear and tear, error, etc.) on a routine basis or over time;

(2) A discussion of the relationship, if any, between changes in the parameters and changes in HAP emissions;

(3) For the parameters which could change in such a way as to increase HAP emissions, a discussion of whether establishing limitations on the parameters would serve to limit HAP emissions;

(4) For the parameters which could change in such a way as to increase HAP emissions, a discussion of how you could establish upper and/or lower values for the parameters which would establish limits on the parameters in operating limitations;

(5) For the parameters, a discussion identifying the methods you could use to measure them and the instruments you could use to monitor them, as well as the relative accuracy and precision of the methods and instruments;

(6) For the parameters, a discussion identifying the frequency and methods for recalibrating the instruments you could use to monitor them; and

(7) A discussion of why, from your point of view, it is infeasible or unreasonable to adopt the parameters as operating limitations.

(i) The engine percent load during a performance test must be determined by documenting the calculations, assumptions, and measurement devices used to measure or estimate the percent load in a specific application. A written report of the average percent load determination must be included in the notification of compliance status. The following information must be included in the written report: the engine model number, the engine manufacturer, the year of purchase, the manufacturer's site-rated brake horsepower, the ambient temperature, pressure, and humidity during the performance test, and all assumptions that were made to estimate or calculate percent load during the performance test must be clearly explained. If measurement devices such as flow meters, kilowatt meters, beta analyzers, stain gauges, etc. are used, the model number of the measurement device, and an estimate of its accurate in percentage of true value must be provided.

**§63.6625 What are my monitoring, installation, collection, operation, and maintenance requirements?**

(a) If you elect to install a CEMS as specified in Table 5 of this subpart, you must install, operate, and maintain a CEMS to monitor CO and either O<sub>2</sub> or CO<sub>2</sub> according to the requirements in paragraphs (a)(1) through (4) of this section. If you are meeting a requirement to reduce CO emissions, the CEMS must be installed at both the inlet and outlet of the control device. If you are meeting a requirement to limit the concentration of CO, the CEMS must be installed at the outlet of the control device.

(1) Each CEMS must be installed, operated, and maintained according to the applicable performance specifications of 40 CFR part 60, appendix B.

(2) You must conduct an initial performance evaluation and an annual relative accuracy test audit (RATA) of each CEMS according to the requirements in §63.8 and according to the applicable performance specifications of 40 CFR part 60, appendix B as well as daily and periodic data quality checks in accordance with 40 CFR part 60, appendix F, procedure 1.

(3) As specified in §63.8(c)(4)(ii), each CEMS must complete a minimum of one cycle of operation (sampling, analyzing, and data recording) for each successive 15-minute period. You must have at least two data points, with each representing a different 15-minute period, to have a valid hour of data.

(4) The CEMS data must be reduced as specified in §63.8(g)(2) and recorded in parts per million or parts per billion (as appropriate for the applicable limitation) at 15 percent oxygen or the equivalent CO<sub>2</sub> concentration.

(b) If you are required to install a continuous parameter monitoring system (CPMS) as specified in Table 5 of this subpart, you must install, operate, and maintain each CPMS according to the requirements in paragraphs (b)(1) through (6) of this section. For an affected source that is complying with the emission limitations and operating limitations on March 9, 2011, the requirements in paragraph (b) of this section are applicable September 6, 2011.

(1) You must prepare a site-specific monitoring plan that addresses the monitoring system design, data collection, and the quality assurance and quality control elements outlined in paragraphs (b)(1)(i) through (v) of this section and in §63.8(d). As specified in §63.8(f)(4), you may request approval of monitoring system quality assurance and quality control procedures alternative to those specified in paragraphs (b)(1) through (5) of this section in your site-specific monitoring plan.

(i) The performance criteria and design specifications for the monitoring system equipment, including the sample interface, detector signal analyzer, and data acquisition and calculations;

(ii) Sampling interface (e.g., thermocouple) location such that the monitoring system will provide representative measurements;

(iii) Equipment performance evaluations, system accuracy audits, or other audit procedures;

(iv) Ongoing operation and maintenance procedures in accordance with provisions in §63.8(c)(1)(ii) and (c)(3); and

(v) Ongoing reporting and recordkeeping procedures in accordance with provisions in §63.10(c), (e)(1), and (e)(2)(i).

(2) You must install, operate, and maintain each CPMS in continuous operation according to the procedures in your site-specific monitoring plan.

(3) The CPMS must collect data at least once every 15 minutes (see also §63.6635).

(4) For a CPMS for measuring temperature range, the temperature sensor must have a minimum tolerance of 2.8 degrees Celsius (5 degrees Fahrenheit) or 1 percent of the measurement range, whichever is larger.

(5) You must conduct the CPMS equipment performance evaluation, system accuracy audits, or other audit procedures specified in your site-specific monitoring plan at least annually.

(6) You must conduct a performance evaluation of each CPMS in accordance with your site-specific monitoring plan.

(c) If you are operating a new or reconstructed stationary RICE which fires landfill gas or digester gas equivalent to 10 percent or more of the gross heat input on an annual basis, you must monitor and record your fuel usage daily with separate fuel meters to measure the volumetric flow rate of each fuel. In addition, you must operate your stationary RICE in a manner which reasonably minimizes HAP emissions.

(d) If you are operating a new or reconstructed emergency 4SLB stationary RICE with a site rating of greater than or equal to 250 and less than or equal to 500 brake HP located at a major source of HAP emissions, you must install a non-resettable hour meter prior to the startup of the engine.

(e) If you own or operate any of the following stationary RICE, you must operate and maintain the stationary RICE and after-treatment control device (if any) according to the manufacturer's emission-related written instructions or develop your own maintenance plan which must provide to the extent practicable for the maintenance and operation of the engine in a manner consistent with good air pollution control practice for minimizing emissions:

(1) An existing stationary RICE with a site rating of less than 100 HP located at a major source of HAP emissions;

(2) An existing emergency or black start stationary RICE with a site rating of less than or equal to 500 HP located at a major source of HAP emissions;

(3) An existing emergency or black start stationary RICE located at an area source of HAP emissions;

(4) An existing non-emergency, non-black start stationary CI RICE with a site rating less than or equal to 300 HP located at an area source of HAP emissions;

(5) An existing non-emergency, non-black start 2SLB stationary RICE located at an area source of HAP emissions;

(6) An existing non-emergency, non-black start stationary RICE located at an area source of HAP emissions which combusts landfill or digester gas equivalent to 10 percent or more of the gross heat input on an annual basis.

(7) An existing non-emergency, non-black start 4SLB stationary RICE with a site rating less than or equal to 500 HP located at an area source of HAP emissions;

(8) An existing non-emergency, non-black start 4SRB stationary RICE with a site rating less than or equal to 500 HP located at an area source of HAP emissions;

(9) An existing, non-emergency, non-black start 4SLB stationary RICE with a site rating greater than 500 HP located at an area source of HAP emissions that is operated 24 hours or less per calendar year; and

(10) An existing, non-emergency, non-black start 4SRB stationary RICE with a site rating greater than 500 HP located at an area source of HAP emissions that is operated 24 hours or less per calendar year.

(f) If you own or operate an existing emergency stationary RICE with a site rating of less than or equal to 500 brake HP located at a major source of HAP emissions or an existing emergency stationary RICE located at an area source of HAP emissions, you must install a non-resettable hour meter if one is not already installed.

(g) If you own or operate an existing non-emergency, non-black start CI engine greater than or equal to 300 HP that is not equipped with a closed crankcase ventilation system, you must comply with either paragraph (g)(1) or paragraph (2) of this section. Owners and operators must follow the manufacturer's specified maintenance requirements for operating and maintaining the open or closed crankcase ventilation systems and replacing the crankcase filters, or can request the Administrator to approve different maintenance requirements that are as protective as manufacturer requirements. Existing CI engines located at area sources in areas of Alaska that meet either §63.6603(b)(1) or §63.6603(b)(2) do not have to meet the requirements of this paragraph (g). Existing CI engines located on offshore vessels that meet §63.6603(c) do not have to meet the requirements of this paragraph (g).

(1) Install a closed crankcase ventilation system that prevents crankcase emissions from being emitted to the atmosphere, or

(2) Install an open crankcase filtration emission control system that reduces emissions from the crankcase by filtering the exhaust stream to remove oil mist, particulates and metals.

(h) If you operate a new, reconstructed, or existing stationary engine, you must minimize the engine's time spent at idle during startup and minimize the engine's startup time to a period needed for appropriate and safe loading of the engine, not to exceed 30 minutes, after which time the emission standards applicable to all times other than startup in Tables 1a, 2a, 2c, and 2d to this subpart apply.

(i) If you own or operate a stationary CI engine that is subject to the work, operation or management practices in items 1 or 2 of Table 2c to this subpart or in items 1 or 4 of Table 2d to this subpart, you have the option of utilizing an oil analysis program in order to extend the specified oil change requirement in Tables 2c and 2d to this subpart. The oil analysis must be performed at the same frequency specified for changing the oil in Table 2c or 2d to this subpart. The analysis program must at a minimum analyze the following three parameters: Total Base Number, viscosity, and percent water content. The condemning limits for these parameters are as follows: Total Base Number is less than 30 percent of the Total Base Number of the oil when new; viscosity of the oil has changed by more than 20 percent from the viscosity of the oil when new; or percent water content (by volume) is greater than 0.5. If all of these condemning limits are not exceeded, the engine owner or operator is not required to change the oil. If any of the limits are exceeded, the engine owner or operator must change the oil within 2 business days of receiving the results of the analysis; if the engine is not in operation when the results of the analysis are received, the engine owner or operator must change the oil within 2 business days or before commencing operation, whichever is later. The owner or operator must keep records of the parameters that are analyzed as part of the program, the results of the analysis, and the oil changes for the engine. The analysis program must be part of the maintenance plan for the engine.

(j) If you own or operate a stationary SI engine that is subject to the work, operation or management practices in items 6, 7, or 8 of Table 2c to this subpart or in items 5, 6, 7, 9, or 11 of Table 2d to this subpart, you have the option of utilizing an oil analysis program in order to extend the specified oil change

requirement in Tables 2c and 2d to this subpart. The oil analysis must be performed at the same frequency specified for changing the oil in Table 2c or 2d to this subpart. The analysis program must at a minimum analyze the following three parameters: Total Acid Number, viscosity, and percent water content. The condemning limits for these parameters are as follows: Total Acid Number increases by more than 3.0 milligrams of potassium hydroxide (KOH) per gram from Total Acid Number of the oil when new; viscosity of the oil has changed by more than 20 percent from the viscosity of the oil when new; or percent water content (by volume) is greater than 0.5. If all of these condemning limits are not exceeded, the engine owner or operator is not required to change the oil. If any of the limits are exceeded, the engine owner or operator must change the oil within 2 business days of receiving the results of the analysis; if the engine is not in operation when the results of the analysis are received, the engine owner or operator must change the oil within 2 business days or before commencing operation, whichever is later. The owner or operator must keep records of the parameters that are analyzed as part of the program, the results of the analysis, and the oil changes for the engine. The analysis program must be part of the maintenance plan for the engine.

[69 FR 33506, June 15, 2004, as amended at 73 FR 3606, Jan. 18, 2008; 75 FR 9676, Mar. 3, 2010; 75 FR 51589, Aug. 20, 2010; 76 FR 12866, Mar. 9, 2011; 78 FR 6703, Jan. 30, 2013]

**§63.6630 How do I demonstrate initial compliance with the emission limitations, operating limitations, and other requirements?**

(a) You must demonstrate initial compliance with each emission limitation, operating limitation, and other requirement that applies to you according to Table 5 of this subpart.

(b) During the initial performance test, you must establish each operating limitation in Tables 1b and 2b of this subpart that applies to you.

(c) You must submit the Notification of Compliance Status containing the results of the initial compliance demonstration according to the requirements in §63.6645.

(d) Non-emergency 4SRB stationary RICE complying with the requirement to reduce formaldehyde emissions by 76 percent or more can demonstrate initial compliance with the formaldehyde emission limit by testing for THC instead of formaldehyde. The testing must be conducted according to the requirements in Table 4 of this subpart. The average reduction of emissions of THC determined from the performance test must be equal to or greater than 30 percent.

(e) The initial compliance demonstration required for existing non-emergency 4SLB and 4SRB stationary RICE with a site rating of more than 500 HP located at an area source of HAP that are not remote stationary RICE and that are operated more than 24 hours per calendar year must be conducted according to the following requirements:

(1) The compliance demonstration must consist of at least three test runs.

(2) Each test run must be of at least 15 minute duration, except that each test conducted using the method in appendix A to this subpart must consist of at least one measurement cycle and include at least 2 minutes of test data phase measurement.

(3) If you are demonstrating compliance with the CO concentration or CO percent reduction requirement, you must measure CO emissions using one of the CO measurement methods specified in Table 4 of this subpart, or using appendix A to this subpart.

(4) If you are demonstrating compliance with the THC percent reduction requirement, you must measure THC emissions using Method 25A, reported as propane, of 40 CFR part 60, appendix A.



(5) You must measure O<sub>2</sub> using one of the O<sub>2</sub> measurement methods specified in Table 4 of this subpart. Measurements to determine O<sub>2</sub> concentration must be made at the same time as the measurements for CO or THC concentration.

(6) If you are demonstrating compliance with the CO or THC percent reduction requirement, you must measure CO or THC emissions and O<sub>2</sub> emissions simultaneously at the inlet and outlet of the control device.

[69 FR 33506, June 15, 2004, as amended at 78 FR 6704, Jan. 30, 2013]

## **CONTINUOUS COMPLIANCE REQUIREMENTS**

### **§63.6635 How do I monitor and collect data to demonstrate continuous compliance?**

(a) If you must comply with emission and operating limitations, you must monitor and collect data according to this section.

(b) Except for monitor malfunctions, associated repairs, required performance evaluations, and required quality assurance or control activities, you must monitor continuously at all times that the stationary RICE is operating. A monitoring malfunction is any sudden, infrequent, not reasonably preventable failure of the monitoring to provide valid data. Monitoring failures that are caused in part by poor maintenance or careless operation are not malfunctions.

(c) You may not use data recorded during monitoring malfunctions, associated repairs, and required quality assurance or control activities in data averages and calculations used to report emission or operating levels. You must, however, use all the valid data collected during all other periods.

[69 FR 33506, June 15, 2004, as amended at 76 FR 12867, Mar. 9, 2011]

### **§63.6640 How do I demonstrate continuous compliance with the emission limitations, operating limitations, and other requirements?**

(a) You must demonstrate continuous compliance with each emission limitation, operating limitation, and other requirements in Tables 1a and 1b, Tables 2a and 2b, Table 2c, and Table 2d to this subpart that apply to you according to methods specified in Table 6 to this subpart.

(b) You must report each instance in which you did not meet each emission limitation or operating limitation in Tables 1a and 1b, Tables 2a and 2b, Table 2c, and Table 2d to this subpart that apply to you. These instances are deviations from the emission and operating limitations in this subpart. These deviations must be reported according to the requirements in §63.6650. If you change your catalyst, you must reestablish the values of the operating parameters measured during the initial performance test. When you reestablish the values of your operating parameters, you must also conduct a performance test to demonstrate that you are meeting the required emission limitation applicable to your stationary RICE.

(c) The annual compliance demonstration required for existing non-emergency 4SLB and 4SRB stationary RICE with a site rating of more than 500 HP located at an area source of HAP that are not remote stationary RICE and that are operated more than 24 hours per calendar year must be conducted according to the following requirements:

(1) The compliance demonstration must consist of at least one test run.

(2) Each test run must be of at least 15 minute duration, except that each test conducted using the method in appendix A to this subpart must consist of at least one measurement cycle and include at least 2 minutes of test data phase measurement.

(3) If you are demonstrating compliance with the CO concentration or CO percent reduction requirement, you must measure CO emissions using one of the CO measurement methods specified in Table 4 of this subpart, or using appendix A to this subpart.

(4) If you are demonstrating compliance with the THC percent reduction requirement, you must measure THC emissions using Method 25A, reported as propane, of 40 CFR part 60, appendix A.

(5) You must measure O<sub>2</sub> using one of the O<sub>2</sub> measurement methods specified in Table 4 of this subpart. Measurements to determine O<sub>2</sub> concentration must be made at the same time as the measurements for CO or THC concentration.

(6) If you are demonstrating compliance with the CO or THC percent reduction requirement, you must measure CO or THC emissions and O<sub>2</sub> emissions simultaneously at the inlet and outlet of the control device.

(7) If the results of the annual compliance demonstration show that the emissions exceed the levels specified in Table 6 of this subpart, the stationary RICE must be shut down as soon as safely possible, and appropriate corrective action must be taken (e.g., repairs, catalyst cleaning, catalyst replacement). The stationary RICE must be retested within 7 days of being restarted and the emissions must meet the levels specified in Table 6 of this subpart. If the retest shows that the emissions continue to exceed the specified levels, the stationary RICE must again be shut down as soon as safely possible, and the stationary RICE may not operate, except for purposes of startup and testing, until the owner/operator demonstrates through testing that the emissions do not exceed the levels specified in Table 6 of this subpart.

(d) For new, reconstructed, and rebuilt stationary RICE, deviations from the emission or operating limitations that occur during the first 200 hours of operation from engine startup (engine burn-in period) are not violations. Rebuilt stationary RICE means a stationary RICE that has been rebuilt as that term is defined in 40 CFR 94.11(a).

(e) You must also report each instance in which you did not meet the requirements in Table 8 to this subpart that apply to you. If you own or operate a new or reconstructed stationary RICE with a site rating of less than or equal to 500 brake HP located at a major source of HAP emissions (except new or reconstructed 4SLB engines greater than or equal to 250 and less than or equal to 500 brake HP), a new or reconstructed stationary RICE located at an area source of HAP emissions, or any of the following RICE with a site rating of more than 500 brake HP located at a major source of HAP emissions, you do not need to comply with the requirements in Table 8 to this subpart: An existing 2SLB stationary RICE, an existing 4SLB stationary RICE, an existing emergency stationary RICE, an existing limited use stationary RICE, or an existing stationary RICE which fires landfill gas or digester gas equivalent to 10 percent or more of the gross heat input on an annual basis. If you own or operate any of the following RICE with a site rating of more than 500 brake HP located at a major source of HAP emissions, you do not need to comply with the requirements in Table 8 to this subpart, except for the initial notification requirements: a new or reconstructed stationary RICE that combusts landfill gas or digester gas equivalent to 10 percent or more of the gross heat input on an annual basis, a new or reconstructed emergency stationary RICE, or a new or reconstructed limited use stationary RICE.

(f) If you own or operate an emergency stationary RICE, you must operate the emergency stationary RICE according to the requirements in paragraphs (f)(1) through (4) of this section. In order for the engine to be considered an emergency stationary RICE under this subpart, any operation other than emergency operation, maintenance and testing, emergency demand response, and operation in non-emergency

situations for 50 hours per year, as described in paragraphs (f)(1) through (4) of this section, is prohibited. If you do not operate the engine according to the requirements in paragraphs (f)(1) through (4) of this section, the engine will not be considered an emergency engine under this subpart and must meet all requirements for non-emergency engines.

(1) There is no time limit on the use of emergency stationary RICE in emergency situations.

(2) You may operate your emergency stationary RICE for any combination of the purposes specified in paragraphs (f)(2)(i) through (iii) of this section for a maximum of 100 hours per calendar year. Any operation for non-emergency situations as allowed by paragraphs (f)(3) and (4) of this section counts as part of the 100 hours per calendar year allowed by this paragraph (f)(2).

(i) Emergency stationary RICE may be operated for maintenance checks and readiness testing, provided that the tests are recommended by federal, state or local government, the manufacturer, the vendor, the regional transmission organization or equivalent balancing authority and transmission operator, or the insurance company associated with the engine. The owner or operator may petition the Administrator for approval of additional hours to be used for maintenance checks and readiness testing, but a petition is not required if the owner or operator maintains records indicating that federal, state, or local standards require maintenance and testing of emergency RICE beyond 100 hours per calendar year.

(ii) Emergency stationary RICE may be operated for emergency demand response for periods in which the Reliability Coordinator under the North American Electric Reliability Corporation (NERC) Reliability Standard EOP-002-3, Capacity and Energy Emergencies (incorporated by reference, see §63.14), or other authorized entity as determined by the Reliability Coordinator, has declared an Energy Emergency Alert Level 2 as defined in the NERC Reliability Standard EOP-002-3.

(iii) Emergency stationary RICE may be operated for periods where there is a deviation of voltage or frequency of 5 percent or greater below standard voltage or frequency.

(3) Emergency stationary RICE located at major sources of HAP may be operated for up to 50 hours per calendar year in non-emergency situations. The 50 hours of operation in non-emergency situations are counted as part of the 100 hours per calendar year for maintenance and testing and emergency demand response provided in paragraph (f)(2) of this section. The 50 hours per year for non-emergency situations cannot be used for peak shaving or non-emergency demand response, or to generate income for a facility to supply power to an electric grid or otherwise supply power as part of a financial arrangement with another entity.

(4) Emergency stationary RICE located at area sources of HAP may be operated for up to 50 hours per calendar year in non-emergency situations. The 50 hours of operation in non-emergency situations are counted as part of the 100 hours per calendar year for maintenance and testing and emergency demand response provided in paragraph (f)(2) of this section. Except as provided in paragraphs (f)(4)(i) and (ii) of this section, the 50 hours per year for non-emergency situations cannot be used for peak shaving or non-emergency demand response, or to generate income for a facility to an electric grid or otherwise supply power as part of a financial arrangement with another entity.

(i) Prior to May 3, 2014, the 50 hours per year for non-emergency situations can be used for peak shaving or non-emergency demand response to generate income for a facility, or to otherwise supply power as part of a financial arrangement with another entity if the engine is operated as part of a peak shaving (load management program) with the local distribution system operator and the power is provided only to the facility itself or to support the local distribution system.

(ii) The 50 hours per year for non-emergency situations can be used to supply power as part of a financial arrangement with another entity if all of the following conditions are met:

(A) The engine is dispatched by the local balancing authority or local transmission and distribution system operator.

(B) The dispatch is intended to mitigate local transmission and/or distribution limitations so as to avert potential voltage collapse or line overloads that could lead to the interruption of power supply in a local area or region.

(C) The dispatch follows reliability, emergency operation or similar protocols that follow specific NERC, regional, state, public utility commission or local standards or guidelines.

(D) The power is provided only to the facility itself or to support the local transmission and distribution system.

(E) The owner or operator identifies and records the entity that dispatches the engine and the specific NERC, regional, state, public utility commission or local standards or guidelines that are being followed for dispatching the engine. The local balancing authority or local transmission and distribution system operator may keep these records on behalf of the engine owner or operator.

[69 FR 33506, June 15, 2004, as amended at 71 FR 20467, Apr. 20, 2006; 73 FR 3606, Jan. 18, 2008; 75 FR 9676, Mar. 3, 2010; 75 FR 51591, Aug. 20, 2010; 78 FR 6704, Jan. 30, 2013]

## **NOTIFICATIONS, REPORTS, AND RECORDS**

### **§63.6645 What notifications must I submit and when?**

(a) You must submit all of the notifications in §§63.7(b) and (c), 63.8(e), (f)(4) and (f)(6), 63.9(b) through (e), and (g) and (h) that apply to you by the dates specified if you own or operate any of the following;

(1) An existing stationary RICE with a site rating of less than or equal to 500 brake HP located at a major source of HAP emissions.

(2) An existing stationary RICE located at an area source of HAP emissions.

(3) A stationary RICE with a site rating of more than 500 brake HP located at a major source of HAP emissions.

(4) A new or reconstructed 4SLB stationary RICE with a site rating of greater than or equal to 250 HP located at a major source of HAP emissions.

(5) This requirement does not apply if you own or operate an existing stationary RICE less than 100 HP, an existing stationary emergency RICE, or an existing stationary RICE that is not subject to any numerical emission standards.

(b) As specified in §63.9(b)(2), if you start up your stationary RICE with a site rating of more than 500 brake HP located at a major source of HAP emissions before the effective date of this subpart, you must submit an Initial Notification not later than December 13, 2004.

(c) If you start up your new or reconstructed stationary RICE with a site rating of more than 500 brake HP located at a major source of HAP emissions on or after August 16, 2004, you must submit an Initial Notification not later than 120 days after you become subject to this subpart.

(d) As specified in §63.9(b)(2), if you start up your stationary RICE with a site rating of equal to or less than 500 brake HP located at a major source of HAP emissions before the effective date of this subpart and you are required to submit an initial notification, you must submit an Initial Notification not later than July 16, 2008.

(e) If you start up your new or reconstructed stationary RICE with a site rating of equal to or less than 500 brake HP located at a major source of HAP emissions on or after March 18, 2008 and you are required to submit an initial notification, you must submit an Initial Notification not later than 120 days after you become subject to this subpart.

(f) If you are required to submit an Initial Notification but are otherwise not affected by the requirements of this subpart, in accordance with §63.6590(b), your notification should include the information in §63.9(b)(2)(i) through (v), and a statement that your stationary RICE has no additional requirements and explain the basis of the exclusion (for example, that it operates exclusively as an emergency stationary RICE if it has a site rating of more than 500 brake HP located at a major source of HAP emissions).

(g) If you are required to conduct a performance test, you must submit a Notification of Intent to conduct a performance test at least 60 days before the performance test is scheduled to begin as required in §63.7(b)(1).

(h) If you are required to conduct a performance test or other initial compliance demonstration as specified in Tables 4 and 5 to this subpart, you must submit a Notification of Compliance Status according to §63.9(h)(2)(ii).

(1) For each initial compliance demonstration required in Table 5 to this subpart that does not include a performance test, you must submit the Notification of Compliance Status before the close of business on the 30th day following the completion of the initial compliance demonstration.

(2) For each initial compliance demonstration required in Table 5 to this subpart that includes a performance test conducted according to the requirements in Table 3 to this subpart, you must submit the Notification of Compliance Status, including the performance test results, before the close of business on the 60th day following the completion of the performance test according to §63.10(d)(2).

(i) If you own or operate an existing non-emergency CI RICE with a site rating of more than 300 HP located at an area source of HAP emissions that is certified to the Tier 1 or Tier 2 emission standards in Table 1 of 40 CFR 89.112 and subject to an enforceable state or local standard requiring engine replacement and you intend to meet management practices rather than emission limits, as specified in §63.6603(d), you must submit a notification by March 3, 2013, stating that you intend to use the provision in §63.6603(d) and identifying the state or local regulation that the engine is subject to.

[73 FR 3606, Jan. 18, 2008, as amended at 75 FR 9677, Mar. 3, 2010; 75 FR 51591, Aug. 20, 2010; 78 FR 6705, Jan. 30, 2013]

### **§63.6650 What reports must I submit and when?**

(a) You must submit each report in Table 7 of this subpart that applies to you.

(b) Unless the Administrator has approved a different schedule for submission of reports under §63.10(a), you must submit each report by the date in Table 7 of this subpart and according to the requirements in paragraphs (b)(1) through (b)(9) of this section.

(1) For semiannual Compliance reports, the first Compliance report must cover the period beginning on the compliance date that is specified for your affected source in §63.6595 and ending on June 30 or December 31, whichever date is the first date following the end of the first calendar half after the compliance date that is specified for your source in §63.6595.

(2) For semiannual Compliance reports, the first Compliance report must be postmarked or delivered no later than July 31 or January 31, whichever date follows the end of the first calendar half after the compliance date that is specified for your affected source in §63.6595.

(3) For semiannual Compliance reports, each subsequent Compliance report must cover the semiannual reporting period from January 1 through June 30 or the semiannual reporting period from July 1 through December 31.

(4) For semiannual Compliance reports, each subsequent Compliance report must be postmarked or delivered no later than July 31 or January 31, whichever date is the first date following the end of the semiannual reporting period.

(5) For each stationary RICE that is subject to permitting regulations pursuant to 40 CFR part 70 or 71, and if the permitting authority has established dates for submitting semiannual reports pursuant to 40 CFR 70.6(a)(3)(iii)(A) or 40 CFR 71.6 (a)(3)(iii)(A), you may submit the first and subsequent Compliance reports according to the dates the permitting authority has established instead of according to the dates in paragraphs (b)(1) through (b)(4) of this section.

(6) For annual Compliance reports, the first Compliance report must cover the period beginning on the compliance date that is specified for your affected source in §63.6595 and ending on December 31.

(7) For annual Compliance reports, the first Compliance report must be postmarked or delivered no later than January 31 following the end of the first calendar year after the compliance date that is specified for your affected source in §63.6595.

(8) For annual Compliance reports, each subsequent Compliance report must cover the annual reporting period from January 1 through December 31.

(9) For annual Compliance reports, each subsequent Compliance report must be postmarked or delivered no later than January 31.

(c) The Compliance report must contain the information in paragraphs (c)(1) through (6) of this section.

(1) Company name and address.

(2) Statement by a responsible official, with that official's name, title, and signature, certifying the accuracy of the content of the report.

(3) Date of report and beginning and ending dates of the reporting period.

(4) If you had a malfunction during the reporting period, the compliance report must include the number, duration, and a brief description for each type of malfunction which occurred during the reporting period and which caused or may have caused any applicable emission limitation to be exceeded. The report must also include a description of actions taken by an owner or operator during a malfunction of an affected source to minimize emissions in accordance with §63.6605(b), including actions taken to correct a malfunction.

(5) If there are no deviations from any emission or operating limitations that apply to you, a statement that there were no deviations from the emission or operating limitations during the reporting period.

(6) If there were no periods during which the continuous monitoring system (CMS), including CEMS and CPMS, was out-of-control, as specified in §63.8(c)(7), a statement that there were no periods during which the CMS was out-of-control during the reporting period.

(d) For each deviation from an emission or operating limitation that occurs for a stationary RICE where you are not using a CMS to comply with the emission or operating limitations in this subpart, the Compliance report must contain the information in paragraphs (c)(1) through (4) of this section and the information in paragraphs (d)(1) and (2) of this section.

(1) The total operating time of the stationary RICE at which the deviation occurred during the reporting period.

(2) Information on the number, duration, and cause of deviations (including unknown cause, if applicable), as applicable, and the corrective action taken.

(e) For each deviation from an emission or operating limitation occurring for a stationary RICE where you are using a CMS to comply with the emission and operating limitations in this subpart, you must include information in paragraphs (c)(1) through (4) and (e)(1) through (12) of this section.

(1) The date and time that each malfunction started and stopped.

(2) The date, time, and duration that each CMS was inoperative, except for zero (low-level) and high-level checks.

(3) The date, time, and duration that each CMS was out-of-control, including the information in §63.8(c)(8).

(4) The date and time that each deviation started and stopped, and whether each deviation occurred during a period of malfunction or during another period.

(5) A summary of the total duration of the deviation during the reporting period, and the total duration as a percent of the total source operating time during that reporting period.

(6) A breakdown of the total duration of the deviations during the reporting period into those that are due to control equipment problems, process problems, other known causes, and other unknown causes.

(7) A summary of the total duration of CMS downtime during the reporting period, and the total duration of CMS downtime as a percent of the total operating time of the stationary RICE at which the CMS downtime occurred during that reporting period.

(8) An identification of each parameter and pollutant (CO or formaldehyde) that was monitored at the stationary RICE.

(9) A brief description of the stationary RICE.

(10) A brief description of the CMS.

(11) The date of the latest CMS certification or audit.

(12) A description of any changes in CMS, processes, or controls since the last reporting period.

(f) Each affected source that has obtained a title V operating permit pursuant to 40 CFR part 70 or 71 must report all deviations as defined in this subpart in the semiannual monitoring report required by 40 CFR 70.6 (a)(3)(iii)(A) or 40 CFR 71.6(a)(3)(iii)(A). If an affected source submits a Compliance report pursuant to Table 7 of this subpart along with, or as part of, the semiannual monitoring report required by 40 CFR 70.6(a)(3)(iii)(A) or 40 CFR 71.6(a)(3)(iii)(A), and the Compliance report includes all required information concerning deviations from any emission or operating limitation in this subpart, submission of the Compliance report shall be deemed to satisfy any obligation to report the same deviations in the semiannual monitoring report. However, submission of a Compliance report shall not otherwise affect any obligation the affected source may have to report deviations from permit requirements to the permit authority.

(g) If you are operating as a new or reconstructed stationary RICE which fires landfill gas or digester gas equivalent to 10 percent or more of the gross heat input on an annual basis, you must submit an annual report according to Table 7 of this subpart by the date specified unless the Administrator has approved a different schedule, according to the information described in paragraphs (b)(1) through (b)(5) of this section. You must report the data specified in (g)(1) through (g)(3) of this section.

(1) Fuel flow rate of each fuel and the heating values that were used in your calculations. You must also demonstrate that the percentage of heat input provided by landfill gas or digester gas is equivalent to 10 percent or more of the total fuel consumption on an annual basis.

(2) The operating limits provided in your federally enforceable permit, and any deviations from these limits.

(3) Any problems or errors suspected with the meters.

(h) If you own or operate an emergency stationary RICE with a site rating of more than 100 brake HP that operates or is contractually obligated to be available for more than 15 hours per calendar year for the purposes specified in §63.6640(f)(2)(ii) and (iii) or that operates for the purpose specified in §63.6640(f)(4)(ii), you must submit an annual report according to the requirements in paragraphs (h)(1) through (3) of this section.

(1) The report must contain the following information:

(i) Company name and address where the engine is located.

(ii) Date of the report and beginning and ending dates of the reporting period.

(iii) Engine site rating and model year.

(iv) Latitude and longitude of the engine in decimal degrees reported to the fifth decimal place.

(v) Hours operated for the purposes specified in §63.6640(f)(2)(ii) and (iii), including the date, start time, and end time for engine operation for the purposes specified in §63.6640(f)(2)(ii) and (iii).

(vi) Number of hours the engine is contractually obligated to be available for the purposes specified in §63.6640(f)(2)(ii) and (iii).

(vii) Hours spent for operation for the purpose specified in §63.6640(f)(4)(ii), including the date, start time, and end time for engine operation for the purposes specified in §63.6640(f)(4)(ii). The report must



also identify the entity that dispatched the engine and the situation that necessitated the dispatch of the engine.

(viii) If there were no deviations from the fuel requirements in §63.6604 that apply to the engine (if any), a statement that there were no deviations from the fuel requirements during the reporting period.

(ix) If there were deviations from the fuel requirements in §63.6604 that apply to the engine (if any), information on the number, duration, and cause of deviations, and the corrective action taken.

(2) The first annual report must cover the calendar year 2015 and must be submitted no later than March 31, 2016. Subsequent annual reports for each calendar year must be submitted no later than March 31 of the following calendar year.

(3) The annual report must be submitted electronically using the subpart specific reporting form in the Compliance and Emissions Data Reporting Interface (CEDRI) that is accessed through EPA's Central Data Exchange (CDX) ([www.epa.gov/cdx](http://www.epa.gov/cdx)). However, if the reporting form specific to this subpart is not available in CEDRI at the time that the report is due, the written report must be submitted to the Administrator at the appropriate address listed in §63.13.

[69 FR 33506, June 15, 2004, as amended at 75 FR 9677, Mar. 3, 2010; 78 FR 6705, Jan. 30, 2013]

#### **§63.6655 What records must I keep?**

(a) If you must comply with the emission and operating limitations, you must keep the records described in paragraphs (a)(1) through (a)(5), (b)(1) through (b)(3) and (c) of this section.

(1) A copy of each notification and report that you submitted to comply with this subpart, including all documentation supporting any Initial Notification or Notification of Compliance Status that you submitted, according to the requirement in §63.10(b)(2)(xiv).

(2) Records of the occurrence and duration of each malfunction of operation (*i.e.*, process equipment) or the air pollution control and monitoring equipment.

(3) Records of performance tests and performance evaluations as required in §63.10(b)(2)(viii).

(4) Records of all required maintenance performed on the air pollution control and monitoring equipment.

(5) Records of actions taken during periods of malfunction to minimize emissions in accordance with §63.6605(b), including corrective actions to restore malfunctioning process and air pollution control and monitoring equipment to its normal or usual manner of operation.

(b) For each CEMS or CPMS, you must keep the records listed in paragraphs (b)(1) through (3) of this section.

(1) Records described in §63.10(b)(2)(vi) through (xi).

(2) Previous (*i.e.*, superseded) versions of the performance evaluation plan as required in §63.8(d)(3).

(3) Requests for alternatives to the relative accuracy test for CEMS or CPMS as required in §63.8(f)(6)(i), if applicable.

(c) If you are operating a new or reconstructed stationary RICE which fires landfill gas or digester gas equivalent to 10 percent or more of the gross heat input on an annual basis, you must keep the records of your daily fuel usage monitors.

(d) You must keep the records required in Table 6 of this subpart to show continuous compliance with each emission or operating limitation that applies to you.

(e) You must keep records of the maintenance conducted on the stationary RICE in order to demonstrate that you operated and maintained the stationary RICE and after-treatment control device (if any) according to your own maintenance plan if you own or operate any of the following stationary RICE;

(1) An existing stationary RICE with a site rating of less than 100 brake HP located at a major source of HAP emissions.

(2) An existing stationary emergency RICE.

(3) An existing stationary RICE located at an area source of HAP emissions subject to management practices as shown in Table 2d to this subpart.

(f) If you own or operate any of the stationary RICE in paragraphs (f)(1) through (2) of this section, you must keep records of the hours of operation of the engine that is recorded through the non-resettable hour meter. The owner or operator must document how many hours are spent for emergency operation, including what classified the operation as emergency and how many hours are spent for non-emergency operation. If the engine is used for the purposes specified in §63.6640(f)(2)(ii) or (iii) or §63.6640(f)(4)(ii), the owner or operator must keep records of the notification of the emergency situation, and the date, start time, and end time of engine operation for these purposes.

(1) An existing emergency stationary RICE with a site rating of less than or equal to 500 brake HP located at a major source of HAP emissions that does not meet the standards applicable to non-emergency engines.

(2) An existing emergency stationary RICE located at an area source of HAP emissions that does not meet the standards applicable to non-emergency engines.

[69 FR 33506, June 15, 2004, as amended at 75 FR 9678, Mar. 3, 2010; 75 FR 51592, Aug. 20, 2010; 78 FR 6706, Jan. 30, 2013]

### **§63.6660 In what form and how long must I keep my records?**

(a) Your records must be in a form suitable and readily available for expeditious review according to §63.10(b)(1).

(b) As specified in §63.10(b)(1), you must keep each record for 5 years following the date of each occurrence, measurement, maintenance, corrective action, report, or record.

(c) You must keep each record readily accessible in hard copy or electronic form for at least 5 years after the date of each occurrence, measurement, maintenance, corrective action, report, or record, according to §63.10(b)(1).

[69 FR 33506, June 15, 2004, as amended at 75 FR 9678, Mar. 3, 2010]

## **OTHER REQUIREMENTS AND INFORMATION**

### **§63.6665 What parts of the General Provisions apply to me?**

Table 8 to this subpart shows which parts of the General Provisions in §§63.1 through 63.15 apply to you. If you own or operate a new or reconstructed stationary RICE with a site rating of less than or equal to 500 brake HP located at a major source of HAP emissions (except new or reconstructed 4SLB engines greater than or equal to 250 and less than or equal to 500 brake HP), a new or reconstructed stationary RICE located at an area source of HAP emissions, or any of the following RICE with a site rating of more than 500 brake HP located at a major source of HAP emissions, you do not need to comply with any of the requirements of the General Provisions specified in Table 8: An existing 2SLB stationary RICE, an existing 4SLB stationary RICE, an existing stationary RICE that combusts landfill or digester gas equivalent to 10 percent or more of the gross heat input on an annual basis, an existing emergency stationary RICE, or an existing limited use stationary RICE. If you own or operate any of the following RICE with a site rating of more than 500 brake HP located at a major source of HAP emissions, you do not need to comply with the requirements in the General Provisions specified in Table 8 except for the initial notification requirements: A new stationary RICE that combusts landfill gas or digester gas equivalent to 10 percent or more of the gross heat input on an annual basis, a new emergency stationary RICE, or a new limited use stationary RICE.

[75 FR 9678, Mar. 3, 2010]

### **§63.6670 Who implements and enforces this subpart?**

(a) This subpart is implemented and enforced by the U.S. EPA, or a delegated authority such as your State, local, or tribal agency. If the U.S. EPA Administrator has delegated authority to your State, local, or tribal agency, then that agency (as well as the U.S. EPA) has the authority to implement and enforce this subpart. You should contact your U.S. EPA Regional Office to find out whether this subpart is delegated to your State, local, or tribal agency.

(b) In delegating implementation and enforcement authority of this subpart to a State, local, or tribal agency under 40 CFR part 63, subpart E, the authorities contained in paragraph (c) of this section are retained by the Administrator of the U.S. EPA and are not transferred to the State, local, or tribal agency.

(c) The authorities that will not be delegated to State, local, or tribal agencies are:

(1) Approval of alternatives to the non-opacity emission limitations and operating limitations in §63.6600 under §63.6(g).

(2) Approval of major alternatives to test methods under §63.7(e)(2)(ii) and (f) and as defined in §63.90.

(3) Approval of major alternatives to monitoring under §63.8(f) and as defined in §63.90.

(4) Approval of major alternatives to recordkeeping and reporting under §63.10(f) and as defined in §63.90.

(5) Approval of a performance test which was conducted prior to the effective date of the rule, as specified in §63.6610(b).

### **§63.6675 What definitions apply to this subpart?**

Terms used in this subpart are defined in the Clean Air Act (CAA); in 40 CFR 63.2, the General Provisions of this part; and in this section as follows:

*Alaska Railbelt Grid* means the service areas of the six regulated public utilities that extend from Fairbanks to Anchorage and the Kenai Peninsula. These utilities are Golden Valley Electric Association; Chugach Electric Association; Matanuska Electric Association; Homer Electric Association; Anchorage Municipal Light & Power; and the City of Seward Electric System.

*Area source* means any stationary source of HAP that is not a major source as defined in part 63.

*Associated equipment* as used in this subpart and as referred to in section 112(n)(4) of the CAA, means equipment associated with an oil or natural gas exploration or production well, and includes all equipment from the well bore to the point of custody transfer, except glycol dehydration units, storage vessels with potential for flash emissions, combustion turbines, and stationary RICE.

*Backup power for renewable energy* means an engine that provides backup power to a facility that generates electricity from renewable energy resources, as that term is defined in Alaska Statute 42.45.045(l)(5) (incorporated by reference, see §63.14).

*Black start engine* means an engine whose only purpose is to start up a combustion turbine.

*CAA* means the Clean Air Act (42 U.S.C. 7401 *et seq.*, as amended by Public Law 101-549, 104 Stat. 2399).

*Commercial emergency stationary RICE* means an emergency stationary RICE used in commercial establishments such as office buildings, hotels, stores, telecommunications facilities, restaurants, financial institutions such as banks, doctor's offices, and sports and performing arts facilities.

*Compression ignition* means relating to a type of stationary internal combustion engine that is not a spark ignition engine.

*Custody transfer* means the transfer of hydrocarbon liquids or natural gas: After processing and/or treatment in the producing operations, or from storage vessels or automatic transfer facilities or other such equipment, including product loading racks, to pipelines or any other forms of transportation. For the purposes of this subpart, the point at which such liquids or natural gas enters a natural gas processing plant is a point of custody transfer.

*Deviation* means any instance in which an affected source subject to this subpart, or an owner or operator of such a source:

(1) Fails to meet any requirement or obligation established by this subpart, including but not limited to any emission limitation or operating limitation;

(2) Fails to meet any term or condition that is adopted to implement an applicable requirement in this subpart and that is included in the operating permit for any affected source required to obtain such a permit; or

(3) Fails to meet any emission limitation or operating limitation in this subpart during malfunction, regardless of whether or not such failure is permitted by this subpart.

(4) Fails to satisfy the general duty to minimize emissions established by §63.6(e)(1)(i).

*Diesel engine* means any stationary RICE in which a high boiling point liquid fuel injected into the combustion chamber ignites when the air charge has been compressed to a temperature sufficiently high for auto-ignition. This process is also known as compression ignition.

*Diesel fuel* means any liquid obtained from the distillation of petroleum with a boiling point of approximately 150 to 360 degrees Celsius. One commonly used form is fuel oil number 2. Diesel fuel also includes any non-distillate fuel with comparable physical and chemical properties (e.g. biodiesel) that is suitable for use in compression ignition engines.

*Digester gas* means any gaseous by-product of wastewater treatment typically formed through the anaerobic decomposition of organic waste materials and composed principally of methane and CO<sub>2</sub>.

*Dual-fuel engine* means any stationary RICE in which a liquid fuel (typically diesel fuel) is used for compression ignition and gaseous fuel (typically natural gas) is used as the primary fuel.

*Emergency stationary RICE* means any stationary reciprocating internal combustion engine that meets all of the criteria in paragraphs (1) through (3) of this definition. All emergency stationary RICE must comply with the requirements specified in §63.6640(f) in order to be considered emergency stationary RICE. If the engine does not comply with the requirements specified in §63.6640(f), then it is not considered to be an emergency stationary RICE under this subpart.

(1) The stationary RICE is operated to provide electrical power or mechanical work during an emergency situation. Examples include stationary RICE used to produce power for critical networks or equipment (including power supplied to portions of a facility) when electric power from the local utility (or the normal power source, if the facility runs on its own power production) is interrupted, or stationary RICE used to pump water in the case of fire or flood, etc.

(2) The stationary RICE is operated under limited circumstances for situations not included in paragraph (1) of this definition, as specified in §63.6640(f).

(3) The stationary RICE operates as part of a financial arrangement with another entity in situations not included in paragraph (1) of this definition only as allowed in §63.6640(f)(2)(ii) or (iii) and §63.6640(f)(4)(i) or (ii).

*Engine startup* means the time from initial start until applied load and engine and associated equipment reaches steady state or normal operation. For stationary engine with catalytic controls, engine startup means the time from initial start until applied load and engine and associated equipment, including the catalyst, reaches steady state or normal operation.

*Four-stroke engine* means any type of engine which completes the power cycle in two crankshaft revolutions, with intake and compression strokes in the first revolution and power and exhaust strokes in the second revolution.

*Gaseous fuel* means a material used for combustion which is in the gaseous state at standard atmospheric temperature and pressure conditions.

*Gasoline* means any fuel sold in any State for use in motor vehicles and motor vehicle engines, or nonroad or stationary engines, and commonly or commercially known or sold as gasoline.

*Glycol dehydration unit* means a device in which a liquid glycol (including, but not limited to, ethylene glycol, diethylene glycol, or triethylene glycol) absorbent directly contacts a natural gas stream and absorbs water in a contact tower or absorption column (absorber). The glycol contacts and absorbs water vapor and other gas stream constituents from the natural gas and becomes "rich" glycol. This glycol is then regenerated in the glycol dehydration unit reboiler. The "lean" glycol is then recycled.

*Hazardous air pollutants (HAP)* means any air pollutants listed in or pursuant to section 112(b) of the CAA.

*Institutional emergency stationary RICE* means an emergency stationary RICE used in institutional establishments such as medical centers, nursing homes, research centers, institutions of higher education, correctional facilities, elementary and secondary schools, libraries, religious establishments, police stations, and fire stations.

*ISO standard day conditions* means 288 degrees Kelvin (15 degrees Celsius), 60 percent relative humidity and 101.3 kilopascals pressure.

*Landfill gas* means a gaseous by-product of the land application of municipal refuse typically formed through the anaerobic decomposition of waste materials and composed principally of methane and CO<sub>2</sub>.

*Lean burn engine* means any two-stroke or four-stroke spark ignited engine that does not meet the definition of a rich burn engine.

*Limited use stationary RICE* means any stationary RICE that operates less than 100 hours per year.

*Liquefied petroleum gas* means any liquefied hydrocarbon gas obtained as a by-product in petroleum refining of natural gas production.

*Liquid fuel* means any fuel in liquid form at standard temperature and pressure, including but not limited to diesel, residual/crude oil, kerosene/naphtha (jet fuel), and gasoline.

*Major Source*, as used in this subpart, shall have the same meaning as in §63.2, except that:

(1) Emissions from any oil or gas exploration or production well (with its associated equipment (as defined in this section)) and emissions from any pipeline compressor station or pump station shall not be aggregated with emissions from other similar units, to determine whether such emission points or stations are major sources, even when emission points are in a contiguous area or under common control;

(2) For oil and gas production facilities, emissions from processes, operations, or equipment that are not part of the same oil and gas production facility, as defined in §63.1271 of subpart HHH of this part, shall not be aggregated;

(3) For production field facilities, only HAP emissions from glycol dehydration units, storage vessel with the potential for flash emissions, combustion turbines and reciprocating internal combustion engines shall be aggregated for a major source determination; and

(4) Emissions from processes, operations, and equipment that are not part of the same natural gas transmission and storage facility, as defined in §63.1271 of subpart HHH of this part, shall not be aggregated.

*Malfunction* means any sudden, infrequent, and not reasonably preventable failure of air pollution control equipment, process equipment, or a process to operate in a normal or usual manner which causes, or has the potential to cause, the emission limitations in an applicable standard to be exceeded. Failures that are caused in part by poor maintenance or careless operation are not malfunctions.

*Natural gas* means a naturally occurring mixture of hydrocarbon and non-hydrocarbon gases found in geologic formations beneath the Earth's surface, of which the principal constituent is methane. Natural gas may be field or pipeline quality.

*Non-selective catalytic reduction (NSCR)* means an add-on catalytic nitrogen oxides (NO<sub>x</sub>) control device for rich burn engines that, in a two-step reaction, promotes the conversion of excess oxygen, NO<sub>x</sub>, CO, and volatile organic compounds (VOC) into CO<sub>2</sub>, nitrogen, and water.

*Oil and gas production facility* as used in this subpart means any grouping of equipment where hydrocarbon liquids are processed, upgraded (*i.e.*, remove impurities or other constituents to meet contract specifications), or stored prior to the point of custody transfer; or where natural gas is processed, upgraded, or stored prior to entering the natural gas transmission and storage source category. For purposes of a major source determination, facility (including a building, structure, or installation) means oil and natural gas production and processing equipment that is located within the boundaries of an individual surface site as defined in this section. Equipment that is part of a facility will typically be located within close proximity to other equipment located at the same facility. Pieces of production equipment or groupings of equipment located on different oil and gas leases, mineral fee tracts, lease tracts, subsurface or surface unit areas, surface fee tracts, surface lease tracts, or separate surface sites, whether or not connected by a road, waterway, power line or pipeline, shall not be considered part of the same facility. Examples of facilities in the oil and natural gas production source category include, but are not limited to, well sites, satellite tank batteries, central tank batteries, a compressor station that transports natural gas to a natural gas processing plant, and natural gas processing plants.

*Oxidation catalyst* means an add-on catalytic control device that controls CO and VOC by oxidation.

*Peaking unit or engine* means any standby engine intended for use during periods of high demand that are not emergencies.

*Percent load* means the fractional power of an engine compared to its maximum manufacturer's design capacity at engine site conditions. Percent load may range between 0 percent to above 100 percent.

*Potential to emit* means the maximum capacity of a stationary source to emit a pollutant under its physical and operational design. Any physical or operational limitation on the capacity of the stationary source to emit a pollutant, including air pollution control equipment and restrictions on hours of operation or on the type or amount of material combusted, stored, or processed, shall be treated as part of its design if the limitation or the effect it would have on emissions is federally enforceable. For oil and natural gas production facilities subject to subpart HH of this part, the potential to emit provisions in §63.760(a) may be used. For natural gas transmission and storage facilities subject to subpart HHH of this part, the maximum annual facility gas throughput for storage facilities may be determined according to §63.1270(a)(1) and the maximum annual throughput for transmission facilities may be determined according to §63.1270(a)(2).

*Production field facility* means those oil and gas production facilities located prior to the point of custody transfer.

*Production well* means any hole drilled in the earth from which crude oil, condensate, or field natural gas is extracted.

*Propane* means a colorless gas derived from petroleum and natural gas, with the molecular structure C<sub>3</sub>H<sub>8</sub>.

*Remote stationary RICE* means stationary RICE meeting any of the following criteria:

(1) Stationary RICE located in an offshore area that is beyond the line of ordinary low water along that portion of the coast of the United States that is in direct contact with the open seas and beyond the line marking the seaward limit of inland waters.

(2) Stationary RICE located on a pipeline segment that meets both of the criteria in paragraphs (2)(i) and (ii) of this definition.

(i) A pipeline segment with 10 or fewer buildings intended for human occupancy and no buildings with four or more stories within 220 yards (200 meters) on either side of the centerline of any continuous 1-mile (1.6 kilometers) length of pipeline. Each separate dwelling unit in a multiple dwelling unit building is counted as a separate building intended for human occupancy.

(ii) The pipeline segment does not lie within 100 yards (91 meters) of either a building or a small, well-defined outside area (such as a playground, recreation area, outdoor theater, or other place of public assembly) that is occupied by 20 or more persons on at least 5 days a week for 10 weeks in any 12-month period. The days and weeks need not be consecutive. The building or area is considered occupied for a full day if it is occupied for any portion of the day.

(iii) For purposes of this paragraph (2), the term pipeline segment means all parts of those physical facilities through which gas moves in transportation, including but not limited to pipe, valves, and other appurtenance attached to pipe, compressor units, metering stations, regulator stations, delivery stations, holders, and fabricated assemblies. Stationary RICE located within 50 yards (46 meters) of the pipeline segment providing power for equipment on a pipeline segment are part of the pipeline segment. Transportation of gas means the gathering, transmission, or distribution of gas by pipeline, or the storage of gas. A building is intended for human occupancy if its primary use is for a purpose involving the presence of humans.

(3) Stationary RICE that are not located on gas pipelines and that have 5 or fewer buildings intended for human occupancy and no buildings with four or more stories within a 0.25 mile radius around the engine. A building is intended for human occupancy if its primary use is for a purpose involving the presence of humans.

*Residential emergency stationary RICE* means an emergency stationary RICE used in residential establishments such as homes or apartment buildings.

*Responsible official* means responsible official as defined in 40 CFR 70.2.

*Rich burn engine* means any four-stroke spark ignited engine where the manufacturer's recommended operating air/fuel ratio divided by the stoichiometric air/fuel ratio at full load conditions is less than or equal to 1.1. Engines originally manufactured as rich burn engines, but modified prior to December 19, 2002 with passive emission control technology for NO<sub>x</sub> (such as pre-combustion chambers) will be considered lean burn engines. Also, existing engines where there are no manufacturer's recommendations regarding air/fuel ratio will be considered a rich burn engine if the excess oxygen content of the exhaust at full load conditions is less than or equal to 2 percent.

*Site-rated HP* means the maximum manufacturer's design capacity at engine site conditions.

*Spark ignition* means relating to either: A gasoline-fueled engine; or any other type of engine with a spark plug (or other sparking device) and with operating characteristics significantly similar to the theoretical Otto combustion cycle. Spark ignition engines usually use a throttle to regulate intake air flow to control power during normal operation. Dual-fuel engines in which a liquid fuel (typically diesel fuel) is used for CI and gaseous fuel (typically natural gas) is used as the primary fuel at an annual average ratio of less than 2 parts diesel fuel to 100 parts total fuel on an energy equivalent basis are spark ignition engines.

*Stationary reciprocating internal combustion engine (RICE)* means any reciprocating internal combustion engine which uses reciprocating motion to convert heat energy into mechanical work and which is not mobile. Stationary RICE differ from mobile RICE in that a stationary RICE is not a non-road engine as defined at 40 CFR 1068.30, and is not used to propel a motor vehicle or a vehicle used solely for competition.



*Stationary RICE test cell/stand* means an engine test cell/stand, as defined in subpart P P P P P of this part, that tests stationary RICE.

*Stoichiometric* means the theoretical air-to-fuel ratio required for complete combustion.

*Storage vessel with the potential for flash emissions* means any storage vessel that contains a hydrocarbon liquid with a stock tank gas-to-oil ratio equal to or greater than 0.31 cubic meters per liter and an American Petroleum Institute gravity equal to or greater than 40 degrees and an actual annual average hydrocarbon liquid throughput equal to or greater than 79,500 liters per day. Flash emissions occur when dissolved hydrocarbons in the fluid evolve from solution when the fluid pressure is reduced.

*Subpart* means 40 CFR part 63, subpart Z Z Z Z.

*Surface site* means any combination of one or more graded pad sites, gravel pad sites, foundations, platforms, or the immediate physical location upon which equipment is physically affixed.

*Two-stroke engine* means a type of engine which completes the power cycle in single crankshaft revolution by combining the intake and compression operations into one stroke and the power and exhaust operations into a second stroke. This system requires auxiliary scavenging and inherently runs lean of stoichiometric.

[69 FR 33506, June 15, 2004, as amended at 71 FR 20467, Apr. 20, 2006; 73 FR 3607, Jan. 18, 2008; 75 FR 9679, Mar. 3, 2010; 75 FR 51592, Aug. 20, 2010; 76 FR 12867, Mar. 9, 2011; 78 FR 6706, Jan. 30, 2013]

**Table 1a to Subpart Z Z Z Z of Part 63—Emission Limitations for Existing, New, and Reconstructed Spark Ignition, 4SRB Stationary RICE >500 HP Located at a Major Source of HAP Emissions**

As stated in §§63.6600 and 63.6640, you must comply with the following emission limitations at 100 percent load plus or minus 10 percent for existing, new and reconstructed 4SRB stationary RICE >500 HP located at a major source of HAP emissions:

| For each . . .          | You must meet the following emission limitation, except during periods of startup . . .   | During periods of startup you must . . .  |
|-------------------------|---|---|
| 1. 4SRB stationary RICE | a. Reduce formaldehyde emissions by 76 percent or more. If you commenced construction or reconstruction between December 19, 2002 and June 15, 2004, you may reduce formaldehyde emissions by 75 percent or more until June 15, 2007 or | Minimize the engine's time spent at idle and minimize the engine's startup time at startup to a period needed for appropriate and safe loading of the engine, not to exceed 30 minutes, after which time the non-startup emission limitations apply. <sup>1</sup> |
|                         | b. Limit the concentration of formaldehyde in the stationary RICE exhaust to 350 ppbvd or less at 15 percent O <sub>2</sub>   |   |

<sup>1</sup> Sources can petition the Administrator pursuant to the requirements of 40 CFR 63.6(g) for alternative work practices.

[75 FR 9679, Mar. 3, 2010, as amended at 75 FR 51592, Aug. 20, 2010]

**Table 1b to Subpart ZZZZ of Part 63—Operating Limitations for Existing, New, and Reconstructed SI 4SRB Stationary RICE >500 HP Located at a Major Source of HAP Emissions**

As stated in §§63.6600, 63.6603, 63.6630 and 63.6640, you must comply with the following operating limitations for existing, new and reconstructed 4SRB stationary RICE >500 HP located at a major source of HAP emissions:

| For each . . .   | You must meet the following operating limitation, except during periods of startup . . .   |
|--|--|
| 1. existing, new and reconstructed 4SRB stationary RICE >500 HP located at a major source of HAP emissions complying with the requirement to reduce formaldehyde emissions by 76 percent or more (or by 75 percent or more, if applicable) and using NSCR; or existing, new and reconstructed 4SRB stationary RICE >500 HP located at a major source of HAP emissions complying with the requirement to limit the concentration of formaldehyde in the stationary RICE exhaust to 350 ppbvd or less at 15 percent O <sub>2</sub> and using NSCR; | a. maintain your catalyst so that the pressure drop across the catalyst does not change by more than 2 inches of water at 100 percent load plus or minus 10 percent from the pressure drop across the catalyst measured during the initial performance test; and b. maintain the temperature of your stationary RICE exhaust so that the catalyst inlet temperature is greater than or equal to 750 °F and less than or equal to 1250 °F. <sup>1</sup> |
| 2. existing, new and reconstructed 4SRB stationary RICE >500 HP located at a major source of HAP emissions complying with the requirement to reduce formaldehyde emissions by 76 percent or more (or by 75 percent or more, if applicable) and not using NSCR; or  | Comply with any operating limitations approved by the Administrator.   |
| existing, new and reconstructed 4SRB stationary RICE >500 HP located at a major source of HAP emissions complying with the requirement to limit the concentration of formaldehyde in the stationary RICE exhaust to 350 ppbvd or less at 15 percent O <sub>2</sub> and not using NSCR.   |  |

<sup>1</sup>Sources can petition the Administrator pursuant to the requirements of 40 CFR 63.8(f) for a different temperature range.

[78 FR 6706, Jan. 30, 2013]

**Table 2a to Subpart ZZZZ of Part 63—Emission Limitations for New and Reconstructed 2SLB and Compression Ignition Stationary RICE >500 HP and New and Reconstructed 4SLB Stationary RICE ≥250 HP Located at a Major Source of HAP Emissions**

As stated in §§63.6600 and 63.6640, you must comply with the following emission limitations for new and reconstructed lean burn and new and reconstructed compression ignition stationary RICE at 100 percent load plus or minus 10 percent:

| For each<br>...               | <b>You must meet the following emission<br/>limitation, except during periods of startup<br/>...</b>   | <b>During periods of startup you<br/>must . . .</b>   |
|-------------------------------|--|---|
| 1. 2SLB<br>stationary<br>RICE | a. Reduce CO emissions by 58 percent or more; or<br>b. Limit concentration of formaldehyde in the stationary RICE exhaust to 12 ppmvd or less at 15 percent O <sub>2</sub> . If you commenced construction or reconstruction between December 19, 2002 and June 15, 2004, you may limit concentration of formaldehyde to 17 ppmvd or less at 15 percent O <sub>2</sub> until June 15, 2007 | Minimize the engine's time spent at idle and minimize the engine's startup time at startup to a period needed for appropriate and safe loading of the engine, not to exceed 30 minutes, after which time the non-startup emission limitations apply. <sup>1</sup> |
| 2. 4SLB<br>stationary<br>RICE | a. Reduce CO emissions by 93 percent or more; or   |   |
|                               | b. Limit concentration of formaldehyde in the stationary RICE exhaust to 14 ppmvd or less at 15 percent O <sub>2</sub>   |   |
| 3. CI<br>stationary<br>RICE   | a. Reduce CO emissions by 70 percent or more; or   |   |
|                               | b. Limit concentration of formaldehyde in the stationary RICE exhaust to 580 ppbvd or less at 15 percent O <sub>2</sub>  |   |

<sup>1</sup>Sources can petition the Administrator pursuant to the requirements of 40 CFR 63.6(g) for alternative work practices.

[75 FR 9680, Mar. 3, 2010]

**Table 2b to Subpart ZZZZ of Part 63—Operating Limitations for New and Reconstructed 2SLB and CI Stationary RICE >500 HP Located at a Major Source of HAP Emissions, New and Reconstructed 4SLB Stationary RICE ≥250 HP Located at a Major Source of HAP Emissions, Existing CI Stationary RICE >500 HP**

As stated in §§63.6600, 63.6601, 63.6603, 63.6630, and 63.6640, you must comply with the following operating limitations for new and reconstructed 2SLB and CI stationary RICE >500 HP located at a major source of HAP emissions; new and reconstructed 4SLB stationary RICE ≥250 HP located at a major source of HAP emissions; and existing CI stationary RICE >500 HP:

| For each . . .                                  | <b>You must meet the following operating<br/>limitation, except during periods of<br/>startup . . .</b> |
|---|---|
| 1. New and reconstructed 2SLB and CI stationary | a. maintain your catalyst so that the pressure  |

|   |   |
|---|---|
| <p>RICE &gt;500 HP located at a major source of HAP emissions and new and reconstructed 4SLB stationary RICE <math>\geq</math>250 HP located at a major source of HAP emissions complying with the requirement to reduce CO emissions and using an oxidation catalyst; and</p> <p>New and reconstructed 2SLB and CI stationary RICE &gt;500 HP located at a major source of HAP emissions and new and reconstructed 4SLB stationary RICE <math>\geq</math>250 HP located at a major source of HAP emissions complying with the requirement to limit the concentration of formaldehyde in the stationary RICE exhaust and using an oxidation catalyst.</p> | <p>drop across the catalyst does not change by more than 2 inches of water at 100 percent load plus or minus 10 percent from the pressure drop across the catalyst that was measured during the initial performance test; and</p> <p>b. maintain the temperature of your stationary RICE exhaust so that the catalyst inlet temperature is greater than or equal to 450 °F and less than or equal to 1350 °F.<sup>1</sup></p> |
| <p>2. Existing CI stationary RICE &gt;500 HP complying with the requirement to limit or reduce the concentration of CO in the stationary RICE exhaust and using an oxidation catalyst</p>   | <p>a. maintain your catalyst so that the pressure drop across the catalyst does not change by more than 2 inches of water from the pressure drop across the catalyst that was measured during the initial performance test; and</p>   |
|   | <p>b. maintain the temperature of your stationary RICE exhaust so that the catalyst inlet temperature is greater than or equal to 450 °F and less than or equal to 1350 °F.<sup>1</sup></p>   |
| <p>3. New and reconstructed 2SLB and CI stationary RICE &gt;500 HP located at a major source of HAP emissions and new and reconstructed 4SLB stationary RICE <math>\geq</math>250 HP located at a major source of HAP emissions complying with the requirement to reduce CO emissions and not using an oxidation catalyst; and</p>  | <p>Comply with any operating limitations approved by the Administrator.</p>   |
| <p>New and reconstructed 2SLB and CI stationary RICE &gt;500 HP located at a major source of HAP emissions and new and reconstructed 4SLB stationary RICE <math>\geq</math>250 HP located at a major source of HAP emissions complying with the requirement to limit the concentration of formaldehyde in the stationary RICE exhaust and not using an oxidation catalyst; and</p>  |   |
| <p>existing CI stationary RICE &gt;500 HP complying with the requirement to limit or reduce the concentration of CO in the stationary RICE exhaust and not using an oxidation catalyst.</p>   |   |

<sup>1</sup>Sources can petition the Administrator pursuant to the requirements of 40 CFR 63.8(f) for a different temperature range.

[78 FR 6707, Jan. 30, 2013]

**Table 2c to Subpart ZZZZ of Part 63—Requirements for Existing Compression Ignition Stationary RICE Located at a Major Source of HAP Emissions and Existing Spark Ignition Stationary RICE ≤500 HP Located at a Major Source of HAP Emissions**

As stated in §§63.6600, 63.6602, and 63.6640, you must comply with the following requirements for existing compression ignition stationary RICE located at a major source of HAP emissions and existing spark ignition stationary RICE ≤500 HP located at a major source of HAP emissions:

| For each . . .  | You must meet the following requirement, except during periods of startup . . .   | During periods of startup you must . . .  |
|---|---|---|
| 1. Emergency stationary CI RICE and black start stationary CI RICE <sup>1</sup> | a. Change oil and filter every 500 hours of operation or annually, whichever comes first. <sup>2</sup><br>b. Inspect air cleaner every 1,000 hours of operation or annually, whichever comes first, and replace as necessary;<br>c. Inspect all hoses and belts every 500 hours of operation or annually, whichever comes first, and replace as necessary. <sup>3</sup>   | Minimize the engine's time spent at idle and minimize the engine's startup time at startup to a period needed for appropriate and safe loading of the engine, not to exceed 30 minutes, after which time the non-startup emission limitations apply. <sup>3</sup> |
| 2. Non-Emergency, non-black start stationary CI RICE <100 HP                    | a. Change oil and filter every 1,000 hours of operation or annually, whichever comes first. <sup>2</sup><br>b. Inspect air cleaner every 1,000 hours of operation or annually, whichever comes first, and replace as necessary;<br>c. Inspect all hoses and belts every 500 hours of operation or annually, whichever comes first, and replace as necessary. <sup>3</sup> |   |
| 3. Non-Emergency, non-black   | Limit concentration of  |   |

|  |   |  |
|--|---|--|
| start CI stationary RICE<br>100≤HP≤300 HP  | CO in the stationary RICE exhaust to 230 ppmvd or less at 15 percent O <sub>2</sub> .   |  |
| 4. Non-Emergency, non-black start CI stationary RICE<br>300<HP≤500                             | a. Limit concentration of CO in the stationary RICE exhaust to 49 ppmvd or less at 15 percent O <sub>2</sub> ; or<br>b. Reduce CO emissions by 70 percent or more.  |  |
| 5. Non-Emergency, non-black start stationary CI RICE >500 HP                                   | a. Limit concentration of CO in the stationary RICE exhaust to 23 ppmvd or less at 15 percent O <sub>2</sub> ; or<br>b. Reduce CO emissions by 70 percent or more.  |  |
| 6. Emergency stationary SI RICE and black start stationary SI RICE. <sup>1</sup>               | a. Change oil and filter every 500 hours of operation or annually, whichever comes first; <sup>2</sup><br>b. Inspect spark plugs every 1,000 hours of operation or annually, whichever comes first, and replace as necessary;<br>c. Inspect all hoses and belts every 500 hours of operation or annually, whichever comes first, and replace as necessary. <sup>3</sup> |  |
| 7. Non-Emergency, non-black start stationary SI RICE <100 HP that are not 2SLB stationary RICE | a. Change oil and filter every 1,440 hours of operation or annually, whichever comes first; <sup>2</sup><br>b. Inspect spark plugs every 1,440 hours of operation or annually, whichever comes first, and replace as necessary;   |  |
|  | c. Inspect all hoses and belts every 1,440 hours of   |  |

|  |   |  |
|--|---|--|
|  | operation or annually, whichever comes first, and replace as necessary. <sup>3</sup>  |  |
| 8. Non-Emergency, non-black start 2SLB stationary SI RICE <100 HP  | a. Change oil and filter every 4,320 hours of operation or annually, whichever comes first; <sup>2</sup><br>b. Inspect spark plugs every 4,320 hours of operation or annually, whichever comes first, and replace as necessary; |  |
|  | c. Inspect all hoses and belts every 4,320 hours of operation or annually, whichever comes first, and replace as necessary. <sup>3</sup>  |  |
| 9. Non-emergency, non-black start 2SLB stationary RICE $100 \leq \text{HP} \leq 500$   | Limit concentration of CO in the stationary RICE exhaust to 225 ppmvd or less at 15 percent O <sub>2</sub> .  |  |
| 10. Non-emergency, non-black start 4SLB stationary RICE $100 \leq \text{HP} \leq 500$  | Limit concentration of CO in the stationary RICE exhaust to 47 ppmvd or less at 15 percent O <sub>2</sub> .   |  |
| 11. Non-emergency, non-black start 4SRB stationary RICE $100 \leq \text{HP} \leq 500$  | Limit concentration of formaldehyde in the stationary RICE exhaust to 10.3 ppmvd or less at 15 percent O <sub>2</sub> .   |  |
| 12. Non-emergency, non-black start stationary RICE $100 \leq \text{HP} \leq 500$ which combusts landfill or digester gas equivalent to 10 percent or more of the gross heat input on an annual basis | Limit concentration of CO in the stationary RICE exhaust to 177 ppmvd or less at 15 percent O <sub>2</sub> .  |  |

<sup>1</sup>If an emergency engine is operating during an emergency and it is not possible to shut down the engine in order to perform the work practice requirements on the schedule required in Table 2c of this subpart, or if performing the work practice on the required schedule would otherwise pose an

unacceptable risk under federal, state, or local law, the work practice can be delayed until the emergency is over or the unacceptable risk under federal, state, or local law has abated. The work practice should be performed as soon as practicable after the emergency has ended or the unacceptable risk under federal, state, or local law has abated. Sources must report any failure to perform the work practice on the schedule required and the federal, state or local law under which the risk was deemed unacceptable.

<sup>2</sup>Sources have the option to utilize an oil analysis program as described in §63.6625(i) or (j) in order to extend the specified oil change requirement in Table 2c of this subpart.

<sup>3</sup>Sources can petition the Administrator pursuant to the requirements of 40 CFR 63.6(g) for alternative work practices.

[78 FR 6708, Jan. 30, 2013, as amended at 78 FR 14457, Mar. 6, 2013]

**Table 2d to Subpart ZZZZ of Part 63—Requirements for Existing Stationary RICE Located at Area Sources of HAP Emissions**

As stated in §§63.6603 and 63.6640, you must comply with the following requirements for existing stationary RICE located at area sources of HAP emissions:

| <b>For each . . .</b>   | <b>You must meet the following requirement, except during periods of startup . . .</b>   | <b>During periods of startup you must . . .</b>  |
|---|--|--|
| 1. Non-Emergency, non-black start CI stationary RICE $\leq 300$ HP              | a. Change oil and filter every 1,000 hours of operation or annually, whichever comes first; <sup>1</sup><br>b. Inspect air cleaner every 1,000 hours of operation or annually, whichever comes first, and replace as necessary;<br>c. Inspect all hoses and belts every 500 hours of operation or annually, whichever comes first, and replace as necessary. | Minimize the engine's time spent at idle and minimize the engine's startup time at startup to a period needed for appropriate and safe loading of the engine, not to exceed 30 minutes, after which time the non-startup emission limitations apply. |
| 2. Non-Emergency, non-black start CI stationary RICE $300 < \text{HP} \leq 500$ | a. Limit concentration of CO in the stationary RICE exhaust to 49 ppmvd at 15 percent O <sub>2</sub> ; or  |  |
|   | b. Reduce CO   |  |



|   |  |  |
|---|--|--|
|   | emissions by 70 percent or more.   |  |
| 3. Non-Emergency, non-black start CI stationary RICE >500 HP  | a. Limit concentration of CO in the stationary RICE exhaust to 23 ppmvd at 15 percent O <sub>2</sub> ; or  |  |
|   | b. Reduce CO emissions by 70 percent or more.  |  |
| 4. Emergency stationary CI RICE and black start stationary CI RICE. <sup>2</sup>  | a. Change oil and filter every 500 hours of operation or annually, whichever comes first; <sup>1</sup>   |  |
|   | b. Inspect air cleaner every 1,000 hours of operation or annually, whichever comes first, and replace as necessary; and  |  |
|   | c. Inspect all hoses and belts every 500 hours of operation or annually, whichever comes first, and replace as necessary.  |  |
| 5. Emergency stationary SI RICE; black start stationary SI RICE; non-emergency, non-black start 4SLB stationary RICE >500 HP that operate 24 hours or less per calendar year; non-emergency, non-black start 4SRB stationary RICE >500 HP that operate 24 hours or less per calendar year. <sup>2</sup> | a. Change oil and filter every 500 hours of operation or annually, whichever comes first; <sup>1</sup> ;<br>b. Inspect spark plugs every 1,000 hours of operation or annually, whichever comes first, and replace as necessary; and<br>c. Inspect all hoses and belts every 500 hours of operation or annually, whichever comes first, and replace as necessary. |  |

|  |   |  |
|--|---|--|
| 6. Non-emergency, non-black start<br>2SLB stationary RICE                | a. Change oil and filter every 4,320 hours of operation or annually, whichever comes first; <sup>1</sup>                    |  |
|  | b. Inspect spark plugs every 4,320 hours of operation or annually, whichever comes first, and replace as necessary; and     |  |
|  | c. Inspect all hoses and belts every 4,320 hours of operation or annually, whichever comes first, and replace as necessary. |  |
| 7. Non-emergency, non-black start<br>4SLB stationary RICE $\leq$ 500 HP  | a. Change oil and filter every 1,440 hours of operation or annually, whichever comes first; <sup>1</sup>                    |  |
|  | b. Inspect spark plugs every 1,440 hours of operation or annually, whichever comes first, and replace as necessary; and     |  |
|  | c. Inspect all hoses and belts every 1,440 hours of operation or annually, whichever comes first, and replace as necessary. |  |
| 8. Non-emergency, non-black start<br>4SLB remote stationary RICE >500 HP | a. Change oil and filter every 2,160 hours of operation or annually, whichever comes first; <sup>1</sup>                    |  |
|  | b. Inspect spark plugs every 2,160 hours of operation or annually, whichever comes first, and replace as necessary; and     |  |

|  |   |  |
|--|---|--|
|  | c. Inspect all hoses and belts every 2,160 hours of operation or annually, whichever comes first, and replace as necessary. |  |
| 9. Non-emergency, non-black start 4SLB stationary RICE >500 HP that are not remote stationary RICE and that operate more than 24 hours per calendar year | Install an oxidation catalyst to reduce HAP emissions from the stationary RICE.   |  |
| 10. Non-emergency, non-black start 4SRB stationary RICE ≤500 HP  | a. Change oil and filter every 1,440 hours of operation or annually, whichever comes first; <sup>1</sup>                    |  |
|  | b. Inspect spark plugs every 1,440 hours of operation or annually, whichever comes first, and replace as necessary; and     |  |
|  | c. Inspect all hoses and belts every 1,440 hours of operation or annually, whichever comes first, and replace as necessary. |  |
| 11. Non-emergency, non-black start 4SRB remote stationary RICE >500 HP   | a. Change oil and filter every 2,160 hours of operation or annually, whichever comes first; <sup>1</sup>                    |  |
|  | b. Inspect spark plugs every 2,160 hours of operation or annually, whichever comes first, and replace as necessary; and     |  |
|  | c. Inspect all hoses and belts every 2,160 hours of operation or annually, whichever comes first, and replace               |  |

|  |   |  |
|--|---|--|
|  | as necessary.   |  |
| 12. Non-emergency, non-black start 4SRB stationary RICE >500 HP that are not remote stationary RICE and that operate more than 24 hours per calendar year              | Install NSCR to reduce HAP emissions from the stationary RICE.  |  |
| 13. Non-emergency, non-black start stationary RICE which combusts landfill or digester gas equivalent to 10 percent or more of the gross heat input on an annual basis | a. Change oil and filter every 1,440 hours of operation or annually, whichever comes first; <sup>1</sup><br>b. Inspect spark plugs every 1,440 hours of operation or annually, whichever comes first, and replace as necessary; and |  |
|  | c. Inspect all hoses and belts every 1,440 hours of operation or annually, whichever comes first, and replace as necessary.   |  |

<sup>1</sup>Sources have the option to utilize an oil analysis program as described in §63.6625(i) or (j) in order to extend the specified oil change requirement in Table 2d of this subpart.

<sup>2</sup>If an emergency engine is operating during an emergency and it is not possible to shut down the engine in order to perform the management practice requirements on the schedule required in Table 2d of this subpart, or if performing the management practice on the required schedule would otherwise pose an unacceptable risk under federal, state, or local law, the management practice can be delayed until the emergency is over or the unacceptable risk under federal, state, or local law has abated. The management practice should be performed as soon as practicable after the emergency has ended or the unacceptable risk under federal, state, or local law has abated. Sources must report any failure to perform the management practice on the schedule required and the federal, state or local law under which the risk was deemed unacceptable.

[78 FR 6709, Jan. 30, 2013]

**Table 3 to Subpart ZZZZ of Part 63—Subsequent Performance Tests**

As stated in §§63.6615 and 63.6620, you must comply with the following subsequent performance test requirements:

| <b>For each . . .</b>                        | <b>Complying with the requirement to . . .</b> | <b>You must . . .</b> |
|--|--|-----------------------|
| 1. New or reconstructed 2SLB stationary RICE | Reduce CO emissions                            | Conduct subsequent    |

|  |  |   |
|--|--|---|
| >500 HP located at major sources; new or reconstructed 4SLB stationary RICE $\geq 250$ HP located at major sources; and new or reconstructed CI stationary RICE >500 HP located at major sources | and not using a CEMS   | performance tests semiannually. <sup>1</sup>  |
| 2. 4SRB stationary RICE $\geq 5,000$ HP located at major sources   | Reduce formaldehyde emissions  | Conduct subsequent performance tests semiannually. <sup>1</sup>                           |
| 3. Stationary RICE >500 HP located at major sources and new or reconstructed 4SLB stationary RICE $250 \leq \text{HP} \leq 500$ located at major sources   | Limit the concentration of formaldehyde in the stationary RICE exhaust | Conduct subsequent performance tests semiannually. <sup>1</sup>                           |
| 4. Existing non-emergency, non-black start CI stationary RICE >500 HP that are not limited use stationary RICE   | Limit or reduce CO emissions and not using a CEMS                      | Conduct subsequent performance tests every 8,760 hours or 3 years, whichever comes first. |
| 5. Existing non-emergency, non-black start CI stationary RICE >500 HP that are limited use stationary RICE   | Limit or reduce CO emissions and not using a CEMS                      | Conduct subsequent performance tests every 8,760 hours or 5 years, whichever comes first. |

<sup>1</sup>After you have demonstrated compliance for two consecutive tests, you may reduce the frequency of subsequent performance tests to annually. If the results of any subsequent annual performance test indicate the stationary RICE is not in compliance with the CO or formaldehyde emission limitation, or you deviate from any of your operating limitations, you must resume semiannual performance tests.

[78 FR 6711, Jan. 30, 2013]

**Table 4 to Subpart ZZZZ of Part 63—Requirements for Performance Tests**

As stated in §§63.6610, 63.6611, 63.6620, and 63.6640, you must comply with the following requirements for performance tests for stationary RICE:

| <b>For each . . .</b>                 | <b>Complying with the requirement to . . .</b> | <b>You must . . .</b>   | <b>Using . . .</b> | <b>According to the following requirements . . .</b>  |
|---------------------------------------|--|---|--------------------|---|
| 1. 2SLB, 4SLB, and CI stationary RICE | a. reduce CO emissions                         | i. Select the sampling port location and the number/location of traverse points at the inlet and outlet |                    | (a) For CO and O <sub>2</sub> measurement, ducts $\leq 6$ inches in diameter may be sampled at a single point located at the duct centroid and ducts >6 and |

|                         |                                  |  |  |   |
|-------------------------|----------------------------------|--|--|---|
|                         |                                  | of the control device; and   |  | <p>≤12 inches in diameter may be sampled at 3 traverse points located at 16.7, 50.0, and 83.3% of the measurement line ('3-point long line'). If the duct is &gt;12 inches in diameter <i>and</i> the sampling port location meets the two and half-diameter criterion of Section 11.1.1 of Method 1 of 40 CFR part 60, appendix A-1, the duct may be sampled at '3-point long line'; otherwise, conduct the stratification testing and select sampling points according to Section 8.1.2 of Method 7E of 40 CFR part 60, appendix A-4.</p> |
|                         |                                  | ii. Measure the O <sub>2</sub> at the inlet and outlet of the control device; and  | (1) Method 3 or 3A or 3B of 40 CFR part 60, appendix A-2, or ASTM Method D6522-00 (Reapproved 2005) <sup>ac</sup> (heated probe not necessary) | (b) Measurements to determine O <sub>2</sub> must be made at the same time as the measurements for CO concentration.  |
|                         |                                  | iii. Measure the CO at the inlet and the outlet of the control device  | (1) ASTM D6522-00 (Reapproved 2005) <sup>abc</sup> (heated probe not necessary) or Method 10 of 40 CFR part 60, appendix A-4                   | (c) The CO concentration must be at 15 percent O <sub>2</sub> , dry basis.  |
| 2. 4SRB stationary RICE | a. reduce formaldehyde emissions | i. Select the sampling port location and the number/location of traverse points at the inlet and outlet of the control device; and |  | (a) For formaldehyde, O <sub>2</sub> , and moisture measurement, ducts ≤6 inches in diameter may be sampled at a single point located at the duct centroid and ducts >6 and ≤12 inches in diameter  |

|  |  |  |  |  |
|--|--|--|--|--|
|  |  |  |  | may be sampled at 3 traverse points located at 16.7, 50.0, and 83.3% of the measurement line (‘3-point long line’). If the duct is >12 inches in diameter <i>and</i> the sampling port location meets the two and half-diameter criterion of Section 11.1.1 of Method 1 of 40 CFR part 60, appendix A, the duct may be sampled at ‘3-point long line’; otherwise, conduct the stratification testing and select sampling points according to Section 8.1.2 of Method 7E of 40 CFR part 60, appendix A. |
|  |  | ii. Measure O <sub>2</sub> at the inlet and outlet of the control device; and  | (1) Method 3 or 3A or 3B of 40 CFR part 60, appendix A-2, or ASTM Method D6522-00 (Reapproved 2005) <sup>a</sup> (heated probe not necessary)            | (a) Measurements to determine O <sub>2</sub> concentration must be made at the same time as the measurements for formaldehyde or THC concentration.  |
|  |  | iii. Measure moisture content at the inlet and outlet of the control device; and   | (1) Method 4 of 40 CFR part 60, appendix A-3, or Method 320 of 40 CFR part 63, appendix A, or ASTM D 6348-03 <sup>a</sup>                                | (a) Measurements to determine moisture content must be made at the same time and location as the measurements for formaldehyde or THC concentration.   |
|  |  | iv. If demonstrating compliance with the formaldehyde percent reduction requirement, measure formaldehyde at the inlet and the outlet of the | (1) Method 320 or 323 of 40 CFR part 63, appendix A; or ASTM D6348-03 <sup>a</sup> , provided in ASTM D6348-03 Annex A5 (Analyte Spiking Technique), the | (a) Formaldehyde concentration must be at 15 percent O <sub>2</sub> , dry basis. Results of this test consist of the average of the three 1-hour or longer runs.   |

|                    |   |  |   |   |
|--------------------|---|--|---|---|
|                    |   | control device   | percent R must be greater than or equal to 70 and less than or equal to 130 |   |
|                    |   | v. If demonstrating compliance with the THC percent reduction requirement, measure THC at the inlet and the outlet of the control device | (1) Method 25A, reported as propane, of 40 CFR part 60, appendix A-7        | (a) THC concentration must be at 15 percent O <sub>2</sub> , dry basis. Results of this test consist of the average of the three 1-hour or longer runs.   |
| 3. Stationary RICE | a. limit the concentration of formaldehyde or CO in the stationary RICE exhaust | i. Select the sampling port location and the number/location of traverse points at the exhaust of the stationary RICE; and               |   | (a) For formaldehyde, CO, O <sub>2</sub> , and moisture measurement, ducts ≤6 inches in diameter may be sampled at a single point located at the duct centroid and ducts >6 and ≤12 inches in diameter may be sampled at 3 traverse points located at 16.7, 50.0, and 83.3% of the measurement line ('3-point long line'). If the duct is >12 inches in diameter <i>and</i> the sampling port location meets the two and half-diameter criterion of Section 11.1.1 of Method 1 of 40 CFR part 60, appendix A, the duct may be sampled at '3-point long line'; otherwise, conduct the stratification testing and select sampling points according to Section 8.1.2 of Method 7E of 40 CFR part 60, appendix A. If using a control device, the sampling site must be located at the outlet of the control device. |



|  |  |  |  |  |
|--|--|--|--|--|
|  |  | ii. Determine the O <sub>2</sub> concentration of the stationary RICE exhaust at the sampling port location; and | (1) Method 3 or 3A or 3B of 40 CFR part 60, appendix A-2, or ASTM Method D6522-00 (Reapproved 2005) <sup>a</sup> (heated probe not necessary)  | (a) Measurements to determine O <sub>2</sub> concentration must be made at the same time and location as the measurements for formaldehyde or CO concentration.  |
|  |  | iii. Measure moisture content of the station-ary RICE exhaust at the sampling port location; and                 | (1) Method 4 of 40 CFR part 60, appendix A-3, or Method 320 of 40 CFR part 63, appendix A, or ASTM D 6348-03 <sup>a</sup>  | (a) Measurements to determine moisture content must be made at the same time and location as the measurements for formaldehyde or CO concentration.              |
|  |  | iv. Measure formalde-hyde at the exhaust of the station-ary RICE; or   | (1) Method 320 or 323 of 40 CFR part 63, appendix A; or ASTM D6348-03 <sup>a</sup> , provided in ASTM D6348-03 Annex A5 (Analyte Spiking Technique), the percent R must be greater than or equal to 70 and less than or equal to 130 | (a) Formaldehyde concentration must be at 15 percent O <sub>2</sub> , dry basis. Results of this test consist of the average of the three 1-hour or longer runs. |
|  |  | v. measure CO at the exhaust of the station-ary RICE   | (1) Method 10 of 40 CFR part 60, appendix A-4, ASTM Method D6522-00 (2005) <sup>ac</sup> , Method 320 of 40 CFR part 63, appendix A, or ASTM D6348-03 <sup>a</sup>   | (a) CO concentration must be at 15 percent O <sub>2</sub> , dry basis. Results of this test consist of the average of the three 1-hour or longer runs.           |

<sup>a</sup>You may also use Methods 3A and 10 as options to ASTM-D6522-00 (2005). You may obtain a copy of ASTM-D6522-00 (2005) from at least one of the following addresses: American Society for Testing and Materials, 100 Barr Harbor Drive, West Conshohocken, PA 19428-2959, or University Microfilms International, 300 North Zeeb Road, Ann Arbor, MI 48106.

<sup>b</sup>You may obtain a copy of ASTM-D6348-03 from at least one of the following addresses: American Society for Testing and Materials, 100 Barr Harbor Drive, West Conshohocken, PA 19428-2959, or University Microfilms International, 300 North Zeeb Road, Ann Arbor, MI 48106.

[79 FR 11290, Feb. 27, 2014]

**Table 5 to Subpart ZZZZ of Part 63—Initial Compliance With Emission Limitations, Operating Limitations, and Other Requirements**

As stated in §§63.6612, 63.6625 and 63.6630, you must initially comply with the emission and operating limitations as required by the following:

| For each . . .   | Complying with the requirement to . . .                                      | You have demonstrated initial compliance if . . .   |
|--|--|---|
| 1. New or reconstructed non-emergency 2SLB stationary RICE >500 HP located at a major source of HAP, new or reconstructed non-emergency 4SLB stationary RICE ≥250 HP located at a major source of HAP, non-emergency stationary CI RICE >500 HP located at a major source of HAP, and existing non-emergency stationary CI RICE >500 HP located at an area source of HAP | a. Reduce CO emissions and using oxidation catalyst, and using a CPMS        | i. The average reduction of emissions of CO determined from the initial performance test achieves the required CO percent reduction; and<br>ii. You have installed a CPMS to continuously monitor catalyst inlet temperature according to the requirements in §63.6625(b); and<br>iii. You have recorded the catalyst pressure drop and catalyst inlet temperature during the initial performance test. |
| 2. Non-emergency stationary CI RICE >500 HP located at a major source of HAP, and existing non-emergency stationary CI RICE >500 HP located at an area source of HAP   | a. Limit the concentration of CO, using oxidation catalyst, and using a CPMS | i. The average CO concentration determined from the initial performance test is less than or equal to the CO emission limitation; and   |
|  |  | ii. You have installed a CPMS to continuously monitor catalyst inlet temperature according to the requirements in §63.6625(b); and  |
|  |  | iii. You have recorded the catalyst pressure drop and catalyst inlet temperature during the initial performance test.   |
| 3. New or reconstructed non-emergency 2SLB stationary RICE >500 HP located at a major source of HAP, new or reconstructed non-emergency 4SLB stationary RICE ≥250 HP located at a major source of  | a. Reduce CO emissions and not using oxidation catalyst                      | i. The average reduction of emissions of CO determined from the initial performance test achieves the required CO percent reduction; and<br>ii. You have installed a CPMS to continuously monitor operating   |

|  |   |  |
|--|---|--|
| <p>HAP, non-emergency stationary CI RICE &gt;500 HP located at a major source of HAP, and existing non-emergency stationary CI RICE &gt;500 HP located at an area source of HAP</p>  |   | <p>parameters approved by the Administrator (if any) according to the requirements in §63.6625(b); and<br/>iii. You have recorded the approved operating parameters (if any) during the initial performance test.</p>  |
| <p>4. Non-emergency stationary CI RICE &gt;500 HP located at a major source of HAP, and existing non-emergency stationary CI RICE &gt;500 HP located at an area source of HAP</p>  | <p>a. Limit the concentration of CO, and not using oxidation catalyst</p> | <p>i. The average CO concentration determined from the initial performance test is less than or equal to the CO emission limitation; and<br/>ii. You have installed a CPMS to continuously monitor operating parameters approved by the Administrator (if any) according to the requirements in §63.6625(b); and</p>                     |
|  |   | <p>iii. You have recorded the approved operating parameters (if any) during the initial performance test.</p>  |
| <p>5. New or reconstructed non-emergency 2SLB stationary RICE &gt;500 HP located at a major source of HAP, new or reconstructed non-emergency 4SLB stationary RICE ≥250 HP located at a major source of HAP, non-emergency stationary CI RICE &gt;500 HP located at a major source of HAP, and existing non-emergency stationary CI RICE &gt;500 HP located at an area source of HAP</p> | <p>a. Reduce CO emissions, and using a CEMS</p>                           | <p>i. You have installed a CEMS to continuously monitor CO and either O<sub>2</sub> or CO<sub>2</sub> at both the inlet and outlet of the oxidation catalyst according to the requirements in §63.6625(a); and<br/>ii. You have conducted a performance evaluation of your CEMS using PS 3 and 4A of 40 CFR part 60, appendix B; and</p> |
|  |   | <p>iii. The average reduction of CO calculated using §63.6620 equals or exceeds the required percent reduction. The initial test comprises the first 4-hour period after successful validation of the CEMS. Compliance is based on the average percent reduction achieved during the 4-hour period.</p>                                  |
| <p>6. Non-emergency stationary CI RICE &gt;500 HP located at a major source of HAP, and existing non-emergency stationary CI RICE &gt;500 HP located at an area source of HAP</p>  | <p>a. Limit the concentration of CO, and using a CEMS</p>                 | <p>i. You have installed a CEMS to continuously monitor CO and either O<sub>2</sub> or CO<sub>2</sub> at the outlet of the oxidation catalyst according to the requirements in §63.6625(a); and</p>  |

|  |   |   |
|--|---|---|
|  |   | ii. You have conducted a performance evaluation of your CEMS using PS 3 and 4A of 40 CFR part 60, appendix B; and   |
|  |   | iii. The average concentration of CO calculated using §63.6620 is less than or equal to the CO emission limitation. The initial test comprises the first 4-hour period after successful validation of the CEMS. Compliance is based on the average concentration measured during the 4-hour period.               |
| 7. Non-emergency 4SRB stationary RICE >500 HP located at a major source of HAP | a. Reduce formaldehyde emissions and using NSCR     | i. The average reduction of emissions of formaldehyde determined from the initial performance test is equal to or greater than the required formaldehyde percent reduction, or the average reduction of emissions of THC determined from the initial performance test is equal to or greater than 30 percent; and |
|  |   | ii. You have installed a CPMS to continuously monitor catalyst inlet temperature according to the requirements in §63.6625(b); and  |
|  |   | iii. You have recorded the catalyst pressure drop and catalyst inlet temperature during the initial performance test.   |
| 8. Non-emergency 4SRB stationary RICE >500 HP located at a major source of HAP | a. Reduce formaldehyde emissions and not using NSCR | i. The average reduction of emissions of formaldehyde determined from the initial performance test is equal to or greater than the required formaldehyde percent reduction or the average reduction of emissions of THC determined from the initial performance test is equal to or greater than 30 percent; and  |
|  |   | ii. You have installed a CPMS to continuously monitor operating parameters approved by the Administrator (if any) according to  |

|   |  |   |
|---|--|---|
|   |  | the requirements in §63.6625(b); and  |
|   |  | iii. You have recorded the approved operating parameters (if any) during the initial performance test.  |
| 9. New or reconstructed non-emergency stationary RICE >500 HP located at a major source of HAP, new or reconstructed non-emergency 4SLB stationary RICE $250 \leq \text{HP} \leq 500$ located at a major source of HAP, and existing non-emergency 4SRB stationary RICE >500 HP located at a major source of HAP  | a. Limit the concentration of formaldehyde in the stationary RICE exhaust and using oxidation catalyst or NSCR     | i. The average formaldehyde concentration, corrected to 15 percent O <sub>2</sub> , dry basis, from the three test runs is less than or equal to the formaldehyde emission limitation; and<br>ii. You have installed a CPMS to continuously monitor catalyst inlet temperature according to the requirements in §63.6625(b); and                                  |
|   |  | iii. You have recorded the catalyst pressure drop and catalyst inlet temperature during the initial performance test.   |
| 10. New or reconstructed non-emergency stationary RICE >500 HP located at a major source of HAP, new or reconstructed non-emergency 4SLB stationary RICE $250 \leq \text{HP} \leq 500$ located at a major source of HAP, and existing non-emergency 4SRB stationary RICE >500 HP located at a major source of HAP | a. Limit the concentration of formaldehyde in the stationary RICE exhaust and not using oxidation catalyst or NSCR | i. The average formaldehyde concentration, corrected to 15 percent O <sub>2</sub> , dry basis, from the three test runs is less than or equal to the formaldehyde emission limitation; and<br>ii. You have installed a CPMS to continuously monitor operating parameters approved by the Administrator (if any) according to the requirements in §63.6625(b); and |
|   |  | iii. You have recorded the approved operating parameters (if any) during the initial performance test.  |
| 11. Existing non-emergency stationary RICE $100 \leq \text{HP} \leq 500$ located at a major source of HAP, and existing non-emergency stationary CI RICE $300 < \text{HP} \leq 500$ located at an area source of HAP  | a. Reduce CO emissions   | i. The average reduction of emissions of CO or formaldehyde, as applicable determined from the initial performance test is equal to or greater than the required CO or formaldehyde, as applicable, percent reduction.  |
| 12. Existing non-emergency stationary RICE $100 \leq \text{HP} \leq 500$ located at a major source of HAP,  | a. Limit the concentration of formaldehyde or CO   | i. The average formaldehyde or CO concentration, as applicable, corrected to 15 percent O <sub>2</sub> , dry basis,   |

|   |                                  |   |
|---|----------------------------------|---|
| and existing non-emergency stationary CI RICE 300<HP≤500 located at an area source of HAP   | in the stationary RICE exhaust   | from the three test runs is less than or equal to the formaldehyde or CO emission limitation, as applicable.  |
| 13. Existing non-emergency 4SLB stationary RICE >500 HP located at an area source of HAP that are not remote stationary RICE and that are operated more than 24 hours per calendar year | a. Install an oxidation catalyst | i. You have conducted an initial compliance demonstration as specified in §63.6630(e) to show that the average reduction of emissions of CO is 93 percent or more, or the average CO concentration is less than or equal to 47 ppmvd at 15 percent O <sub>2</sub> ;   |
|   |                                  | ii. You have installed a CPMS to continuously monitor catalyst inlet temperature according to the requirements in §63.6625(b), or you have installed equipment to automatically shut down the engine if the catalyst inlet temperature exceeds 1350 °F.   |
| 14. Existing non-emergency 4SRB stationary RICE >500 HP located at an area source of HAP that are not remote stationary RICE and that are operated more than 24 hours per calendar year | a. Install NSCR                  | i. You have conducted an initial compliance demonstration as specified in §63.6630(e) to show that the average reduction of emissions of CO is 75 percent or more, the average CO concentration is less than or equal to 270 ppmvd at 15 percent O <sub>2</sub> , or the average reduction of emissions of THC is 30 percent or more; |
|   |                                  | ii. You have installed a CPMS to continuously monitor catalyst inlet temperature according to the requirements in §63.6625(b), or you have installed equipment to automatically shut down the engine if the catalyst inlet temperature exceeds 1250 °F.   |

[78 FR 6712, Jan. 30, 2013]

**Table 6 to Subpart ZZZZ of Part 63—Continuous Compliance With Emission Limitations, and Other Requirements**

As stated in §63.6640, you must continuously comply with the emissions and operating limitations and work or management practices as required by the following:

| For each . . .  | Complying with the requirement to . . .  | You must demonstrate continuous compliance by . . .   |
|---|--|---|
| 1. New or reconstructed non-emergency 2SLB stationary RICE >500 HP located at a major source of HAP, new or reconstructed non-emergency 4SLB stationary RICE ≥250 HP located at a major source of HAP, and new or reconstructed non-emergency CI stationary RICE >500 HP located at a major source of HAP | a. Reduce CO emissions and using an oxidation catalyst, and using a CPMS                                 | i. Conducting semiannual performance tests for CO to demonstrate that the required CO percent reduction is achieved <sup>a</sup> ; and<br>ii. Collecting the catalyst inlet temperature data according to §63.6625(b); and<br>iii. Reducing these data to 4-hour rolling averages; and            |
|   |  | iv. Maintaining the 4-hour rolling averages within the operating limitations for the catalyst inlet temperature; and  |
|   |  | v. Measuring the pressure drop across the catalyst once per month and demonstrating that the pressure drop across the catalyst is within the operating limitation established during the performance test.  |
| 2. New or reconstructed non-emergency 2SLB stationary RICE >500 HP located at a major source of HAP, new or reconstructed non-emergency 4SLB stationary RICE ≥250 HP located at a major source of HAP, and new or reconstructed non-emergency CI stationary RICE >500 HP located at a major source of HAP | a. Reduce CO emissions and not using an oxidation catalyst, and using a CPMS                             | i. Conducting semiannual performance tests for CO to demonstrate that the required CO percent reduction is achieved <sup>a</sup> ; and<br>ii. Collecting the approved operating parameter (if any) data according to §63.6625(b); and<br>iii. Reducing these data to 4-hour rolling averages; and |
|   |  | iv. Maintaining the 4-hour rolling averages within the operating limitations for the operating parameters established during the performance test.  |
| 3. New or reconstructed non-emergency 2SLB stationary RICE >500 HP located at a major source of HAP, new or reconstructed non-emergency 4SLB stationary RICE ≥250 HP located at a major source  | a. Reduce CO emissions or limit the concentration of CO in the stationary RICE exhaust, and using a CEMS | i. Collecting the monitoring data according to §63.6625(a), reducing the measurements to 1-hour averages, calculating the percent reduction or concentration of CO emissions according to §63.6620;   |

|   |   |  |
|---|---|--|
| of HAP, new or reconstructed non-emergency stationary CI RICE >500 HP located at a major source of HAP, and existing non-emergency stationary CI RICE >500 HP |   | and<br>ii. Demonstrating that the catalyst achieves the required percent reduction of CO emissions over the 4-hour averaging period, or that the emission remain at or below the CO concentration limit; and |
|   |   | iii. Conducting an annual RATA of your CEMS using PS 3 and 4A of 40 CFR part 60, appendix B, as well as daily and periodic data quality checks in accordance with 40 CFR part 60, appendix F, procedure 1.   |
| 4. Non-emergency 4SRB stationary RICE >500 HP located at a major source of HAP  | a. Reduce formaldehyde emissions and using NSCR     | i. Collecting the catalyst inlet temperature data according to §63.6625(b); and  |
|   |   | ii. Reducing these data to 4-hour rolling averages; and  |
|   |   | iii. Maintaining the 4-hour rolling averages within the operating limitations for the catalyst inlet temperature; and  |
|   |   | iv. Measuring the pressure drop across the catalyst once per month and demonstrating that the pressure drop across the catalyst is within the operating limitation established during the performance test.  |
| 5. Non-emergency 4SRB stationary RICE >500 HP located at a major source of HAP  | a. Reduce formaldehyde emissions and not using NSCR | i. Collecting the approved operating parameter (if any) data according to §63.6625(b); and   |
|   |   | ii. Reducing these data to 4-hour rolling averages; and  |
|   |   | iii. Maintaining the 4-hour rolling averages within the operating limitations for the operating parameters established during the performance test.  |
| 6. Non-emergency 4SRB stationary  | a. Reduce   | Conducting semiannual performance  |



|   |  |  |
|---|--|--|
| RICE with a brake HP $\geq 5,000$ located at a major source of HAP  | formaldehyde emissions   | tests for formaldehyde to demonstrate that the required formaldehyde percent reduction is achieved, or to demonstrate that the average reduction of emissions of THC determined from the performance test is equal to or greater than 30 percent. <sup>a</sup> |
| 7. New or reconstructed non-emergency stationary RICE $>500$ HP located at a major source of HAP and new or reconstructed non-emergency 4SLB stationary RICE $250 \leq \text{HP} \leq 500$ located at a major source of HAP | a. Limit the concentration of formaldehyde in the stationary RICE exhaust and using oxidation catalyst or NSCR     | i. Conducting semiannual performance tests for formaldehyde to demonstrate that your emissions remain at or below the formaldehyde concentration limit <sup>a</sup> ; and  |
|   |  | ii. Collecting the catalyst inlet temperature data according to §63.6625(b); and   |
|   |  | iii. Reducing these data to 4-hour rolling averages; and   |
|   |  | iv. Maintaining the 4-hour rolling averages within the operating limitations for the catalyst inlet temperature; and   |
|   |  | v. Measuring the pressure drop across the catalyst once per month and demonstrating that the pressure drop across the catalyst is within the operating limitation established during the performance test.   |
| 8. New or reconstructed non-emergency stationary RICE $>500$ HP located at a major source of HAP and new or reconstructed non-emergency 4SLB stationary RICE $250 \leq \text{HP} \leq 500$ located at a major source of HAP | a. Limit the concentration of formaldehyde in the stationary RICE exhaust and not using oxidation catalyst or NSCR | i. Conducting semiannual performance tests for formaldehyde to demonstrate that your emissions remain at or below the formaldehyde concentration limit <sup>a</sup> ; and  |
|   |  | ii. Collecting the approved operating parameter (if any) data according to §63.6625(b); and  |
|   |  | iii. Reducing these data to 4-hour rolling averages; and   |
|   |  | iv. Maintaining the 4-hour rolling averages within the operating limitations for the operating parameters established during the   |

|  |  |  |
|--|--|--|
|  |  | performance test.  |
| <p>9. Existing emergency and black start stationary RICE <math>\leq 500</math> HP located at a major source of HAP, existing non-emergency stationary RICE <math>&lt; 100</math> HP located at a major source of HAP, existing emergency and black start stationary RICE located at an area source of HAP, existing non-emergency stationary CI RICE <math>\leq 300</math> HP located at an area source of HAP, existing non-emergency 2SLB stationary RICE located at an area source of HAP, existing non-emergency stationary SI RICE located at an area source of HAP which combusts landfill or digester gas equivalent to 10 percent or more of the gross heat input on an annual basis, existing non-emergency 4SLB and 4SRB stationary RICE <math>\leq 500</math> HP located at an area source of HAP, existing non-emergency 4SLB and 4SRB stationary RICE <math>&gt; 500</math> HP located at an area source of HAP that operate 24 hours or less per calendar year, and existing non-emergency 4SLB and 4SRB stationary RICE <math>&gt; 500</math> HP located at an area source of HAP that are remote stationary RICE</p> | <p>a. Work or Management practices</p>   | <p>i. Operating and maintaining the stationary RICE according to the manufacturer's emission-related operation and maintenance instructions; or<br/> ii. Develop and follow your own maintenance plan which must provide to the extent practicable for the maintenance and operation of the engine in a manner consistent with good air pollution control practice for minimizing emissions.</p> |
| <p>10. Existing stationary CI RICE <math>&gt; 500</math> HP that are not limited use stationary RICE</p>   | <p>a. Reduce CO emissions, or limit the concentration of CO in the stationary RICE exhaust, and using oxidation catalyst</p> | <p>i. Conducting performance tests every 8,760 hours or 3 years, whichever comes first, for CO or formaldehyde, as appropriate, to demonstrate that the required CO or formaldehyde, as appropriate, percent reduction is achieved or that your emissions remain at or below the CO or formaldehyde concentration limit; and</p>   |
|  |  | <p>ii. Collecting the catalyst inlet temperature data according to §63.6625(b); and</p>  |

|  |   |   |
|--|---|---|
|  |   | iii. Reducing these data to 4-hour rolling averages; and  |
|  |   | iv. Maintaining the 4-hour rolling averages within the operating limitations for the catalyst inlet temperature; and  |
|  |   | v. Measuring the pressure drop across the catalyst once per month and demonstrating that the pressure drop across the catalyst is within the operating limitation established during the performance test.  |
| 11. Existing stationary CI RICE >500 HP that are not limited use stationary RICE | a. Reduce CO emissions, or limit the concentration of CO in the stationary RICE exhaust, and not using oxidation catalyst | i. Conducting performance tests every 8,760 hours or 3 years, whichever comes first, for CO or formaldehyde, as appropriate, to demonstrate that the required CO or formaldehyde, as appropriate, percent reduction is achieved or that your emissions remain at or below the CO or formaldehyde concentration limit; and |
|  |   | ii. Collecting the approved operating parameter (if any) data according to §63.6625(b); and   |
|  |   | iii. Reducing these data to 4-hour rolling averages; and  |
|  |   | iv. Maintaining the 4-hour rolling averages within the operating limitations for the operating parameters established during the performance test.  |
| 12. Existing limited use CI stationary RICE >500 HP                              | a. Reduce CO emissions or limit the concentration of CO in the stationary RICE exhaust, and using an oxidation catalyst   | i. Conducting performance tests every 8,760 hours or 5 years, whichever comes first, for CO or formaldehyde, as appropriate, to demonstrate that the required CO or formaldehyde, as appropriate, percent reduction is achieved or that your emissions remain at or below the CO or formaldehyde concentration limit; and |

|   |   |   |
|---|---|---|
|   |   | ii. Collecting the catalyst inlet temperature data according to §63.6625(b); and  |
|   |   | iii. Reducing these data to 4-hour rolling averages; and  |
|   |   | iv. Maintaining the 4-hour rolling averages within the operating limitations for the catalyst inlet temperature; and  |
|   |   | v. Measuring the pressure drop across the catalyst once per month and demonstrating that the pressure drop across the catalyst is within the operating limitation established during the performance test.  |
| 13. Existing limited use CI stationary RICE >500 HP   | a. Reduce CO emissions or limit the concentration of CO in the stationary RICE exhaust, and not using an oxidation catalyst | i. Conducting performance tests every 8,760 hours or 5 years, whichever comes first, for CO or formaldehyde, as appropriate, to demonstrate that the required CO or formaldehyde, as appropriate, percent reduction is achieved or that your emissions remain at or below the CO or formaldehyde concentration limit; and |
|   |   | ii. Collecting the approved operating parameter (if any) data according to §63.6625(b); and   |
|   |   | iii. Reducing these data to 4-hour rolling averages; and  |
|   |   | iv. Maintaining the 4-hour rolling averages within the operating limitations for the operating parameters established during the performance test.  |
| 14. Existing non-emergency 4SLB stationary RICE >500 HP located at an area source of HAP that are not remote stationary RICE and that are operated more than 24 hours per calendar year | a. Install an oxidation catalyst  | i. Conducting annual compliance demonstrations as specified in §63.6640(c) to show that the average reduction of emissions of CO is 93 percent or more, or the average CO concentration is less than or equal to 47 ppmvd at 15 percent O <sub>2</sub> ; and  |

|   |                        |  |
|---|------------------------|--|
|   |                        | <p>either</p> <p>ii. Collecting the catalyst inlet temperature data according to §63.6625(b), reducing these data to 4-hour rolling averages; and maintaining the 4-hour rolling averages within the limitation of greater than 450 °F and less than or equal to 1350 °F for the catalyst inlet temperature; or</p> <p>iii. Immediately shutting down the engine if the catalyst inlet temperature exceeds 1350 °F.</p>  |
| <p>15. Existing non-emergency 4SRB stationary RICE &gt;500 HP located at an area source of HAP that are not remote stationary RICE and that are operated more than 24 hours per calendar year</p> | <p>a. Install NSCR</p> | <p>i. Conducting annual compliance demonstrations as specified in §63.6640(c) to show that the average reduction of emissions of CO is 75 percent or more, the average CO concentration is less than or equal to 270 ppmvd at 15 percent O<sub>2</sub>, or the average reduction of emissions of THC is 30 percent or more; and either</p> <p>ii. Collecting the catalyst inlet temperature data according to §63.6625(b), reducing these data to 4-hour rolling averages; and maintaining the 4-hour rolling averages within the limitation of greater than or equal to 750 °F and less than or equal to 1250 °F for the catalyst inlet temperature; or</p> <p>iii. Immediately shutting down the engine if the catalyst inlet temperature exceeds 1250 °F.</p> |

<sup>a</sup>After you have demonstrated compliance for two consecutive tests, you may reduce the frequency of subsequent performance tests to annually. If the results of any subsequent annual performance test indicate the stationary RICE is not in compliance with the CO or formaldehyde emission limitation, or you deviate from any of your operating limitations, you must resume semiannual performance tests.

[78 FR 6715, Jan. 30, 2013]

**Table 7 to Subpart ZZZZ of Part 63—Requirements for Reports**

As stated in §63.6650, you must comply with the following requirements for reports:

| For each . . .  | You must submit a . . . | The report must contain . . .   | You must submit the report . . .  |
|---|-------------------------|---|---|
| <p>1. Existing non-emergency, non-black start stationary RICE <math>100 \leq \text{HP} \leq 500</math> located at a major source of HAP; existing non-emergency, non-black start stationary CI RICE <math>&gt;500</math> HP located at a major source of HAP; existing non-emergency 4SRB stationary RICE <math>&gt;500</math> HP located at a major source of HAP; existing non-emergency, non-black start stationary CI RICE <math>&gt;300</math> HP located at an area source of HAP; new or reconstructed non-emergency stationary RICE <math>&gt;500</math> HP located at a major source of HAP; and new or reconstructed non-emergency 4SLB stationary RICE <math>250 \leq \text{HP} \leq 500</math> located at a major source of HAP</p> | Compliance report       | <p>a. If there are no deviations from any emission limitations or operating limitations that apply to you, a statement that there were no deviations from the emission limitations or operating limitations during the reporting period. If there were no periods during which the CMS, including CEMS and CPMS, was out-of-control, as specified in §63.8(c)(7), a statement that there were not periods during which the CMS was out-of-control during the reporting period; or</p> | <p>i. Semiannually according to the requirements in §63.6650(b)(1)-(5) for engines that are not limited use stationary RICE subject to numerical emission limitations; and<br/>ii. Annually according to the requirements in §63.6650(b)(6)-(9) for engines that are limited use stationary RICE subject to numerical emission limitations.</p> |
|   |                         | <p>b. If you had a deviation from any emission limitation or operating limitation during the reporting period, the information in §63.6650(d). If there were periods during which the CMS, including CEMS and CPMS, was out-of-control, as specified in §63.8(c)(7), the information in §63.6650(e); or</p>   | <p>i. Semiannually according to the requirements in §63.6650(b).</p>  |
|   |                         | <p>c. If you had a malfunction during the reporting period, the information in §63.6650(c)(4).</p>  | <p>i. Semiannually according to the requirements in §63.6650(b).</p>  |
| <p>2. New or reconstructed non-emergency stationary RICE that combusts landfill gas or</p>  | Report                  | <p>a. The fuel flow rate of each fuel and the heating values that were used in your</p>   | <p>i. Annually, according to the requirements in §63.6650.</p>  |

|  |                   |  |  |
|--|-------------------|--|--|
| digester gas equivalent to 10 percent or more of the gross heat input on an annual basis   |                   | calculations, and you must demonstrate that the percentage of heat input provided by landfill gas or digester gas, is equivalent to 10 percent or more of the gross heat input on an annual basis; and |  |
|  |                   | b. The operating limits provided in your federally enforceable permit, and any deviations from these limits; and   | i. See item 2.a.i.   |
|  |                   | c. Any problems or errors suspected with the meters.   | i. See item 2.a.i.   |
| 3. Existing non-emergency, non-black start 4SLB and 4SRB stationary RICE >500 HP located at an area source of HAP that are not remote stationary RICE and that operate more than 24 hours per calendar year  | Compliance report | a. The results of the annual compliance demonstration, if conducted during the reporting period.   | i. Semiannually according to the requirements in §63.6650(b)(1)-(5). |
| 4. Emergency stationary RICE that operate or are contractually obligated to be available for more than 15 hours per year for the purposes specified in §63.6640(f)(2)(ii) and (iii) or that operate for the purposes specified in §63.6640(f)(4)(ii) | Report            | a. The information in §63.6650(h)(1)   | i. annually according to the requirements in §63.6650(h)(2)-(3).     |

[78 FR 6719, Jan. 30, 2013]

**Table 8 to Subpart ZZZZ of Part 63—Applicability of General Provisions to Subpart ZZZZ.**

As stated in §63.6665, you must comply with the following applicable general provisions.

| <b>General provisions citation</b> | <b>Subject of citation</b>   | <b>Applies to subpart</b> | <b>Explanation</b> |
|------------------------------------|------------------------------|---------------------------|--------------------|
| §63.1                              | General applicability of the | Yes.                      |                    |

|                 |   |      |  |
|-----------------|---|------|--|
|                 | General Provisions  |      |  |
| §63.2           | Definitions   | Yes  | Additional terms defined in §63.6675.                                |
| §63.3           | Units and abbreviations   | Yes. |  |
| §63.4           | Prohibited activities and circumvention   | Yes. |  |
| §63.5           | Construction and reconstruction   | Yes. |  |
| §63.6(a)        | Applicability   | Yes. |  |
| §63.6(b)(1)-(4) | Compliance dates for new and reconstructed sources                                | Yes. |  |
| §63.6(b)(5)     | Notification  | Yes. |  |
| §63.6(b)(6)     | [Reserved]  |      |  |
| §63.6(b)(7)     | Compliance dates for new and reconstructed area sources that become major sources | Yes. |  |
| §63.6(c)(1)-(2) | Compliance dates for existing sources   | Yes. |  |
| §63.6(c)(3)-(4) | [Reserved]  |      |  |
| §63.6(c)(5)     | Compliance dates for existing area sources that become major sources              | Yes. |  |
| §63.6(d)        | [Reserved]  |      |  |
| §63.6(e)        | Operation and maintenance   | No.  |  |
| §63.6(f)(1)     | Applicability of standards  | No.  |  |
| §63.6(f)(2)     | Methods for determining compliance  | Yes. |  |
| §63.6(f)(3)     | Finding of compliance   | Yes. |  |
| §63.6(g)(1)-(3) | Use of alternate standard   | Yes. |  |
| §63.6(h)        | Opacity and visible emission standards  | No   | Subpart ZZZZ does not contain opacity or visible emission standards. |
| §63.6(i)        | Compliance extension procedures and criteria                                      | Yes. |  |



|                 |  |      |  |
|-----------------|--|------|--|
| §63.6(j)        | Presidential compliance exemption                                    | Yes. |  |
| §63.7(a)(1)-(2) | Performance test dates   | Yes  | Subpart ZZZZ contains performance test dates at §§63.6610, 63.6611, and 63.6612. |
| §63.7(a)(3)     | CAA section 114 authority  | Yes. |  |
| §63.7(b)(1)     | Notification of performance test                                     | Yes  | Except that §63.7(b)(1) only applies as specified in §63.6645.                   |
| §63.7(b)(2)     | Notification of rescheduling   | Yes  | Except that §63.7(b)(2) only applies as specified in §63.6645.                   |
| §63.7(c)        | Quality assurance/test plan  | Yes  | Except that §63.7(c) only applies as specified in §63.6645.                      |
| §63.7(d)        | Testing facilities   | Yes. |  |
| §63.7(e)(1)     | Conditions for conducting performance tests                          | No.  | Subpart ZZZZ specifies conditions for conducting performance tests at §63.6620.  |
| §63.7(e)(2)     | Conduct of performance tests and reduction of data                   | Yes  | Subpart ZZZZ specifies test methods at §63.6620.                                 |
| §63.7(e)(3)     | Test run duration  | Yes. |  |
| §63.7(e)(4)     | Administrator may require other testing under section 114 of the CAA | Yes. |  |
| §63.7(f)        | Alternative test method provisions                                   | Yes. |  |
| §63.7(g)        | Performance test data analysis, recordkeeping, and reporting         | Yes. |  |
| §63.7(h)        | Waiver of tests  | Yes. |  |
| §63.8(a)(1)     | Applicability of monitoring requirements                             | Yes  | Subpart ZZZZ contains specific requirements for monitoring at §63.6625.          |
| §63.8(a)(2)     | Performance specifications   | Yes. |  |
| §63.8(a)(3)     | [Reserved]   |      |  |

|                  |  |   |  |
|------------------|--|---|--|
| §63.8(a)(4)      | Monitoring for control devices                         | No.   |  |
| §63.8(b)(1)      | Monitoring   | Yes.  |  |
| §63.8(b)(2)-(3)  | Multiple effluents and multiple monitoring systems     | Yes.  |  |
| §63.8(c)(1)      | Monitoring system operation and maintenance            | Yes.  |  |
| §63.8(c)(1)(i)   | Routine and predictable SSM                            | No  |  |
| §63.8(c)(1)(ii)  | SSM not in Startup Shutdown Malfunction Plan           | Yes.  |  |
| §63.8(c)(1)(iii) | Compliance with operation and maintenance requirements | No  |  |
| §63.8(c)(2)-(3)  | Monitoring system installation                         | Yes.  |  |
| §63.8(c)(4)      | Continuous monitoring system (CMS) requirements        | Yes   | Except that subpart ZZZZ does not require Continuous Opacity Monitoring System (COMS). |
| §63.8(c)(5)      | COMS minimum procedures                                | No  | Subpart ZZZZ does not require COMS.  |
| §63.8(c)(6)-(8)  | CMS requirements                                       | Yes   | Except that subpart ZZZZ does not require COMS.  |
| §63.8(d)         | CMS quality control                                    | Yes.  |  |
| §63.8(e)         | CMS performance evaluation                             | Yes   | Except for §63.8(e)(5)(ii), which applies to COMS.                                     |
|                  |  | Except that §63.8(e) only applies as specified in §63.6645. |  |
| §63.8(f)(1)-(5)  | Alternative monitoring method                          | Yes   | Except that §63.8(f)(4) only applies as specified in §63.6645.                         |
| §63.8(f)(6)      | Alternative to relative accuracy test                  | Yes   | Except that §63.8(f)(6) only applies as specified in §63.6645.                         |
| §63.8(g)         | Data reduction   | Yes   | Except that provisions for COMS are not applicable. Averaging periods for              |

|                 |   |   |  |
|-----------------|---|---|--|
|                 |   |   | demonstrating compliance are specified at §§63.6635 and 63.6640. |
| §63.9(a)        | Applicability and State delegation of notification requirements | Yes.  |  |
| §63.9(b)(1)-(5) | Initial notifications   | Yes   | Except that §63.9(b)(3) is reserved.                             |
|                 |   | Except that §63.9(b) only applies as specified in §63.6645. |  |
| §63.9(c)        | Request for compliance extension                                | Yes   | Except that §63.9(c) only applies as specified in §63.6645.      |
| §63.9(d)        | Notification of special compliance requirements for new sources | Yes   | Except that §63.9(d) only applies as specified in §63.6645.      |
| §63.9(e)        | Notification of performance test                                | Yes   | Except that §63.9(e) only applies as specified in §63.6645.      |
| §63.9(f)        | Notification of visible emission (VE)/opacity test              | No  | Subpart ZZZZ does not contain opacity or VE standards.           |
| §63.9(g)(1)     | Notification of performance evaluation                          | Yes   | Except that §63.9(g) only applies as specified in §63.6645.      |
| §63.9(g)(2)     | Notification of use of COMS data                                | No  | Subpart ZZZZ does not contain opacity or VE standards.           |
| §63.9(g)(3)     | Notification that criterion for alternative to RATA is exceeded | Yes   | If alternative is in use.  |
|                 |   | Except that §63.9(g) only applies as specified in §63.6645. |  |

|                       |   |      |  |
|-----------------------|---|------|--|
| §63.9(h)(1)-(6)       | Notification of compliance status                     | Yes  | Except that notifications for sources using a CEMS are due 30 days after completion of performance evaluations. §63.9(h)(4) is reserved. |
|                       |   |      | Except that §63.9(h) only applies as specified in §63.6645.  |
| §63.9(i)              | Adjustment of submittal deadlines                     | Yes. |  |
| §63.9(j)              | Change in previous information                        | Yes. |  |
| §63.10(a)             | Administrative provisions for recordkeeping/reporting | Yes. |  |
| §63.10(b)(1)          | Record retention                                      | Yes  | Except that the most recent 2 years of data do not have to be retained on site.  |
| §63.10(b)(2)(i)-(v)   | Records related to SSM                                | No.  |  |
| §63.10(b)(2)(vi)-(xi) | Records   | Yes. |  |
| §63.10(b)(2)(xii)     | Record when under waiver                              | Yes. |  |
| §63.10(b)(2)(xiii)    | Records when using alternative to RATA                | Yes  | For CO standard if using RATA alternative.   |
| §63.10(b)(2)(xiv)     | Records of supporting documentation                   | Yes. |  |
| §63.10(b)(3)          | Records of applicability determination                | Yes. |  |
| §63.10(c)             | Additional records for sources using CEMS             | Yes  | Except that §63.10(c)(2)-(4) and (9) are reserved.   |
| §63.10(d)(1)          | General reporting requirements                        | Yes. |  |
| §63.10(d)(2)          | Report of performance test results                    | Yes. |  |
| §63.10(d)(3)          | Reporting opacity or VE observations                  | No   | Subpart ZZZZ does not contain opacity or VE standards.   |
| §63.10(d)(4)          | Progress reports                                      | Yes. |  |

|                         |   |      |   |
|-------------------------|---|------|---|
| §63.10(d)(5)            | Startup, shutdown, and malfunction reports        | No.  |   |
| §63.10(e)(1) and (2)(i) | Additional CMS Reports                            | Yes. |   |
| §63.10(e)(2)(ii)        | COMS-related report                               | No   | Subpart ZZZZ does not require COMS.         |
| §63.10(e)(3)            | Excess emission and parameter exceedances reports | Yes. | Except that §63.10(e)(3)(i)(C) is reserved. |
| §63.10(e)(4)            | Reporting COMS data                               | No   | Subpart ZZZZ does not require COMS.         |
| §63.10(f)               | Waiver for recordkeeping/reporting                | Yes. |   |
| §63.11                  | Flares  | No.  |   |
| §63.12                  | State authority and delegations                   | Yes. |   |
| §63.13                  | Addresses   | Yes. |   |
| §63.14                  | Incorporation by reference                        | Yes. |   |
| §63.15                  | Availability of information                       | Yes. |   |

[75 FR 9688, Mar. 3, 2010, as amended at 78 FR 6720, Jan. 30, 2013]

**Appendix A to Subpart ZZZZ of Part 63—Protocol for Using an Electrochemical Analyzer to Determine Oxygen and Carbon Monoxide Concentrations From Certain Engines**

1.0 SCOPE AND APPLICATION. WHAT IS THIS PROTOCOL?

This protocol is a procedure for using portable electrochemical (EC) cells for measuring carbon monoxide (CO) and oxygen (O<sub>2</sub>) concentrations in controlled and uncontrolled emissions from existing stationary 4-stroke lean burn and 4-stroke rich burn reciprocating internal combustion engines as specified in the applicable rule.

1.1 Analytes. What does this protocol determine?

This protocol measures the engine exhaust gas concentrations of carbon monoxide (CO) and oxygen (O<sub>2</sub>).

| Analyte                  | CAS No.   | Sensitivity  |
|--------------------------|-----------|--|
| Carbon monoxide (CO)     | 630-08-00 | Minimum detectable limit should be 2 percent of the nominal range or 1 ppm, whichever is less restrictive. |
| Oxygen (O <sub>2</sub> ) | 7782-44-7 |  |

### *1.2 Applicability. When is this protocol acceptable?*

This protocol is applicable to 40 CFR part 63, subpart ZZZZ. Because of inherent cross sensitivities of EC cells, you must not apply this protocol to other emissions sources without specific instruction to that effect.

### *1.3 Data Quality Objectives. How good must my collected data be?*

Refer to Section 13 to verify and document acceptable analyzer performance.

### *1.4 Range. What is the targeted analytical range for this protocol?*

The measurement system and EC cell design(s) conforming to this protocol will determine the analytical range for each gas component. The nominal ranges are defined by choosing up-scale calibration gas concentrations near the maximum anticipated flue gas concentrations for CO and O<sub>2</sub>, or no more than twice the permitted CO level.

### *1.5 Sensitivity. What minimum detectable limit will this protocol yield for a particular gas component?*

The minimum detectable limit depends on the nominal range and resolution of the specific EC cell used, and the signal to noise ratio of the measurement system. The minimum detectable limit should be 2 percent of the nominal range or 1 ppm, whichever is less restrictive.

## 2.0 SUMMARY OF PROTOCOL

In this protocol, a gas sample is extracted from an engine exhaust system and then conveyed to a portable EC analyzer for measurement of CO and O<sub>2</sub> gas concentrations. This method provides measurement system performance specifications and sampling protocols to ensure reliable data. You may use additions to, or modifications of vendor supplied measurement systems (e.g., heated or unheated sample lines, thermocouples, flow meters, selective gas scrubbers, etc.) to meet the design specifications of this protocol. Do not make changes to the measurement system from the as-verified configuration (Section 3.12).

## 3.0 DEFINITIONS

*3.1 Measurement System.* The total equipment required for the measurement of CO and O<sub>2</sub> concentrations. The measurement system consists of the following major subsystems:

*3.1.1 Data Recorder.* A strip chart recorder, computer or digital recorder for logging measurement data from the analyzer output. You may record measurement data from the digital data display manually or electronically.

*3.1.2 Electrochemical (EC) Cell.* A device, similar to a fuel cell, used to sense the presence of a specific analyte and generate an electrical current output proportional to the analyte concentration.

*3.1.3 Interference Gas Scrubber.* A device used to remove or neutralize chemical compounds that may interfere with the selective operation of an EC cell.

*3.1.4 Moisture Removal System.* Any device used to reduce the concentration of moisture in the sample stream so as to protect the EC cells from the damaging effects of condensation and to minimize errors in measurements caused by the scrubbing of soluble gases.

*3.1.5 Sample Interface.* The portion of the system used for one or more of the following: sample acquisition; sample transport; sample conditioning or protection of the EC cell from any degrading effects of the engine exhaust effluent; removal of particulate matter and condensed moisture.

*3.2 Nominal Range.* The range of analyte concentrations over which each EC cell is operated (normally 25 percent to 150 percent of up-scale calibration gas value). Several nominal ranges can be used for any given cell so long as the calibration and repeatability checks for that range remain within specifications.

*3.3 Calibration Gas.* A vendor certified concentration of a specific analyte in an appropriate balance gas.

*3.4 Zero Calibration Error.* The analyte concentration output exhibited by the EC cell in response to zero-level calibration gas.

*3.5 Up-Scale Calibration Error.* The mean of the difference between the analyte concentration exhibited by the EC cell and the certified concentration of the up-scale calibration gas.

*3.6 Interference Check.* A procedure for quantifying analytical interference from components in the engine exhaust gas other than the targeted analytes.

*3.7 Repeatability Check.* A protocol for demonstrating that an EC cell operated over a given nominal analyte concentration range provides a stable and consistent response and is not significantly affected by repeated exposure to that gas.

*3.8 Sample Flow Rate.* The flow rate of the gas sample as it passes through the EC cell. In some situations, EC cells can experience drift with changes in flow rate. The flow rate must be monitored and documented during all phases of a sampling run.

*3.9 Sampling Run.* A timed three-phase event whereby an EC cell's response rises and plateaus in a sample conditioning phase, remains relatively constant during a measurement data phase, then declines during a refresh phase. The sample conditioning phase exposes the EC cell to the gas sample for a length of time sufficient to reach a constant response. The measurement data phase is the time interval during which gas sample measurements can be made that meet the acceptance criteria of this protocol. The refresh phase then purges the EC cells with CO-free air. The refresh phase replenishes requisite O<sub>2</sub> and moisture in the electrolyte reserve and provides a mechanism to de-gas or desorb any interference gas scrubbers or filters so as to enable a stable CO EC cell response. There are four primary types of sampling runs: pre- sampling calibrations; stack gas sampling; post-sampling calibration checks; and measurement system repeatability checks. Stack gas sampling runs can be chained together for extended evaluations, providing all other procedural specifications are met.

*3.10 Sampling Day.* A time not to exceed twelve hours from the time of the pre-sampling calibration to the post-sampling calibration check. During this time, stack gas sampling runs can be repeated without repeated recalibrations, providing all other sampling specifications have been met.

*3.11 Pre-Sampling Calibration/Post-Sampling Calibration Check.* The protocols executed at the beginning and end of each sampling day to bracket measurement readings with controlled performance checks.

*3.12 Performance-Established Configuration.* The EC cell and sampling system configuration that existed at the time that it initially met the performance requirements of this protocol.

#### 4.0 INTERFERENCES.

When present in sufficient concentrations, NO and NO<sub>2</sub> are two gas species that have been reported to interfere with CO concentration measurements. In the likelihood of this occurrence, it is the protocol user's responsibility to employ and properly maintain an appropriate CO EC cell filter or scrubber for removal of these gases, as described in Section 6.2.12.

## 5.0 SAFETY. [RESERVED]

## 6.0 EQUIPMENT AND SUPPLIES.

### 6.1 What equipment do I need for the measurement system?

The system must maintain the gas sample at conditions that will prevent moisture condensation in the sample transport lines, both before and as the sample gas contacts the EC cells. The essential components of the measurement system are described below.

### 6.2 Measurement System Components.

**6.2.1 Sample Probe.** A single extraction-point probe constructed of glass, stainless steel or other non-reactive material, and of length sufficient to reach any designated sampling point. The sample probe must be designed to prevent plugging due to condensation or particulate matter.

**6.2.2 Sample Line.** Non-reactive tubing to transport the effluent from the sample probe to the EC cell.

**6.2.3 Calibration Assembly (optional).** A three-way valve assembly or equivalent to introduce calibration gases at ambient pressure at the exit end of the sample probe during calibration checks. The assembly must be designed such that only stack gas or calibration gas flows in the sample line and all gases flow through any gas path filters.

**6.2.4 Particulate Filter (optional).** Filters before the inlet of the EC cell to prevent accumulation of particulate material in the measurement system and extend the useful life of the components. All filters must be fabricated of materials that are non-reactive to the gas mixtures being sampled.

**6.2.5 Sample Pump.** A leak-free pump to provide undiluted sample gas to the system at a flow rate sufficient to minimize the response time of the measurement system. If located upstream of the EC cells, the pump must be constructed of a material that is non-reactive to the gas mixtures being sampled.

**6.2.8 Sample Flow Rate Monitoring.** An adjustable rotameter or equivalent device used to adjust and maintain the sample flow rate through the analyzer as prescribed.

**6.2.9 Sample Gas Manifold (optional).** A manifold to divert a portion of the sample gas stream to the analyzer and the remainder to a by-pass discharge vent. The sample gas manifold may also include provisions for introducing calibration gases directly to the analyzer. The manifold must be constructed of a material that is non-reactive to the gas mixtures being sampled.

**6.2.10 EC cell.** A device containing one or more EC cells to determine the CO and O<sub>2</sub> concentrations in the sample gas stream. The EC cell(s) must meet the applicable performance specifications of Section 13 of this protocol.

**6.2.11 Data Recorder.** A strip chart recorder, computer or digital recorder to make a record of analyzer output data. The data recorder resolution (i.e., readability) must be no greater than 1 ppm for CO; 0.1 percent for O<sub>2</sub>; and one degree (either °C or °F) for temperature. Alternatively, you may use a digital or analog meter having the same resolution to observe and manually record the analyzer responses.



*6.2.12 Interference Gas Filter or Scrubber.* A device to remove interfering compounds upstream of the CO EC cell. Specific interference gas filters or scrubbers used in the performance-established configuration of the analyzer must continue to be used. Such a filter or scrubber must have a means to determine when the removal agent is exhausted. Periodically replace or replenish it in accordance with the manufacturer's recommendations.

## 7.0 REAGENTS AND STANDARDS. WHAT CALIBRATION GASES ARE NEEDED?

*7.1 Calibration Gases.* CO calibration gases for the EC cell must be CO in nitrogen or CO in a mixture of nitrogen and O<sub>2</sub>. Use CO calibration gases with labeled concentration values certified by the manufacturer to be within ±5 percent of the label value. Dry ambient air (20.9 percent O<sub>2</sub>) is acceptable for calibration of the O<sub>2</sub> cell. If needed, any lower percentage O<sub>2</sub> calibration gas must be a mixture of O<sub>2</sub> in nitrogen.

*7.1.1 Up-Scale CO Calibration Gas Concentration.* Choose one or more up-scale gas concentrations such that the average of the stack gas measurements for each stack gas sampling run are between 25 and 150 percent of those concentrations. Alternatively, choose an up-scale gas that does not exceed twice the concentration of the applicable outlet standard. If a measured gas value exceeds 150 percent of the up-scale CO calibration gas value at any time during the stack gas sampling run, the run must be discarded and repeated.

### *7.1.2 Up-Scale O<sub>2</sub> Calibration Gas Concentration.*

Select an O<sub>2</sub> gas concentration such that the difference between the gas concentration and the average stack gas measurement or reading for each sample run is less than 15 percent O<sub>2</sub>. When the average exhaust gas O<sub>2</sub> readings are above 6 percent, you may use dry ambient air (20.9 percent O<sub>2</sub>) for the up-scale O<sub>2</sub> calibration gas.

*7.1.3 Zero Gas.* Use an inert gas that contains less than 0.25 percent of the up-scale CO calibration gas concentration. You may use dry air that is free from ambient CO and other combustion gas products (e.g., CO<sub>2</sub>).

## 8.0 SAMPLE COLLECTION AND ANALYSIS

### *8.1 Selection of Sampling Sites.*

*8.1.1 Control Device Inlet.* Select a sampling site sufficiently downstream of the engine so that the combustion gases should be well mixed. Use a single sampling extraction point near the center of the duct (e.g., within the 10 percent centroidal area), unless instructed otherwise.

*8.1.2 Exhaust Gas Outlet.* Select a sampling site located at least two stack diameters downstream of any disturbance (e.g., turbocharger exhaust, crossover junction or recirculation take-off) and at least one-half stack diameter upstream of the gas discharge to the atmosphere. Use a single sampling extraction point near the center of the duct (e.g., within the 10 percent centroidal area), unless instructed otherwise.

*8.2 Stack Gas Collection and Analysis.* Prior to the first stack gas sampling run, conduct that the pre-sampling calibration in accordance with Section 10.1. Use Figure 1 to record all data. Zero the analyzer with zero gas. Confirm and record that the scrubber media color is correct and not exhausted. Then position the probe at the sampling point and begin the sampling run at the same flow rate used during the up-scale calibration. Record the start time. Record all EC cell output responses and the flow rate during the "sample conditioning phase" once per minute until constant readings are obtained. Then begin the "measurement data phase" and record readings every 15 seconds for at least two minutes (or

eight readings), or as otherwise required to achieve two continuous minutes of data that meet the specification given in Section 13.1. Finally, perform the “refresh phase” by introducing dry air, free from CO and other combustion gases, until several minute-to-minute readings of consistent value have been obtained. For each run use the “measurement data phase” readings to calculate the average stack gas CO and O<sub>2</sub> concentrations.

**8.3 EC Cell Rate.** Maintain the EC cell sample flow rate so that it does not vary by more than ±10 percent throughout the pre-sampling calibration, stack gas sampling and post-sampling calibration check. Alternatively, the EC cell sample flow rate can be maintained within a tolerance range that does not affect the gas concentration readings by more than ±3 percent, as instructed by the EC cell manufacturer.

## 9.0 QUALITY CONTROL (RESERVED)

## 10.0 CALIBRATION AND STANDARDIZATION

**10.1 Pre-Sampling Calibration.** Conduct the following protocol once for each nominal range to be used on each EC cell before performing a stack gas sampling run on each field sampling day. Repeat the calibration if you replace an EC cell before completing all of the sampling runs. There is no prescribed order for calibration of the EC cells; however, each cell must complete the measurement data phase during calibration. Assemble the measurement system by following the manufacturer's recommended protocols including for preparing and preconditioning the EC cell. Assure the measurement system has no leaks and verify the gas scrubbing agent is not depleted. Use Figure 1 to record all data.

**10.1.1 Zero Calibration.** For both the O<sub>2</sub> and CO cells, introduce zero gas to the measurement system (e.g., at the calibration assembly) and record the concentration reading every minute until readings are constant for at least two consecutive minutes. Include the time and sample flow rate. Repeat the steps in this section at least once to verify the zero calibration for each component gas.

**10.1.2 Zero Calibration Tolerance.** For each zero gas introduction, the zero level output must be less than or equal to ±3 percent of the up-scale gas value or ±1 ppm, whichever is less restrictive, for the CO channel and less than or equal to ±0.3 percent O<sub>2</sub> for the O<sub>2</sub> channel.

**10.1.3 Up-Scale Calibration.** Individually introduce each calibration gas to the measurement system (e.g., at the calibration assembly) and record the start time. Record all EC cell output responses and the flow rate during this “sample conditioning phase” once per minute until readings are constant for at least two minutes. Then begin the “measurement data phase” and record readings every 15 seconds for a total of two minutes, or as otherwise required. Finally, perform the “refresh phase” by introducing dry air, free from CO and other combustion gases, until readings are constant for at least two consecutive minutes. Then repeat the steps in this section at least once to verify the calibration for each component gas. Introduce all gases to flow through the entire sample handling system (i.e., at the exit end of the sampling probe or the calibration assembly).

**10.1.4 Up-Scale Calibration Error.** The mean of the difference of the “measurement data phase” readings from the reported standard gas value must be less than or equal to ±5 percent or ±1 ppm for CO or ±0.5 percent O<sub>2</sub>, whichever is less restrictive, respectively. The maximum allowable deviation from the mean measured value of any single “measurement data phase” reading must be less than or equal to ±2 percent or ±1 ppm for CO or ±0.5 percent O<sub>2</sub>, whichever is less restrictive, respectively.

**10.2 Post-Sampling Calibration Check.** Conduct a stack gas post-sampling calibration check after the stack gas sampling run or set of runs and within 12 hours of the initial calibration. Conduct up-scale and zero calibration checks using the protocol in Section 10.1. Make no changes to the sampling system or EC cell calibration until all post-sampling calibration checks have been recorded. If either the zero or up-scale calibration error exceeds the respective specification in Sections 10.1.2 and 10.1.4 then all measurement data collected since the previous successful calibrations are invalid and re-calibration and

re-sampling are required. If the sampling system is disassembled or the EC cell calibration is adjusted, repeat the calibration check before conducting the next analyzer sampling run.

## 11.0 ANALYTICAL PROCEDURE

The analytical procedure is fully discussed in Section 8.

## 12.0 CALCULATIONS AND DATA ANALYSIS

Determine the CO and O<sub>2</sub> concentrations for each stack gas sampling run by calculating the mean gas concentrations of the data recorded during the “measurement data phase”.

## 13.0 PROTOCOL PERFORMANCE

Use the following protocols to verify consistent analyzer performance during each field sampling day.

*13.1 Measurement Data Phase Performance Check.* Calculate the mean of the readings from the “measurement data phase”. The maximum allowable deviation from the mean for each of the individual readings is  $\pm 2$  percent, or  $\pm 1$  ppm, whichever is less restrictive. Record the mean value and maximum deviation for each gas monitored. Data must conform to Section 10.1.4. The EC cell flow rate must conform to the specification in Section 8.3.

*Example:* A measurement data phase is invalid if the maximum deviation of any single reading comprising that mean is greater than  $\pm 2$  percent or  $\pm 1$  ppm (the default criteria). For example, if the mean = 30 ppm, single readings of below 29 ppm and above 31 ppm are disallowed).

*13.2 Interference Check.* Before the initial use of the EC cell and interference gas scrubber in the field, and semi-annually thereafter, challenge the interference gas scrubber with NO and NO<sub>2</sub> gas standards that are generally recognized as representative of diesel-fueled engine NO and NO<sub>2</sub> emission values. Record the responses displayed by the CO EC cell and other pertinent data on Figure 1 or a similar form.

*13.2.1 Interference Response.* The combined NO and NO<sub>2</sub> interference response should be less than or equal to  $\pm 5$  percent of the up-scale CO calibration gas concentration.

*13.3 Repeatability Check.* Conduct the following check once for each nominal range that is to be used on the CO EC cell within 5 days prior to each field sampling program. If a field sampling program lasts longer than 5 days, repeat this check every 5 days. Immediately repeat the check if the EC cell is replaced or if the EC cell is exposed to gas concentrations greater than 150 percent of the highest up-scale gas concentration.

*13.3.1 Repeatability Check Procedure.* Perform a complete EC cell sampling run (all three phases) by introducing the CO calibration gas to the measurement system and record the response. Follow Section 10.1.3. Use Figure 1 to record all data. Repeat the run three times for a total of four complete runs. During the four repeatability check runs, do not adjust the system except where necessary to achieve the correct calibration gas flow rate at the analyzer.

*13.3.2 Repeatability Check Calculations.* Determine the highest and lowest average “measurement data phase” CO concentrations from the four repeatability check runs and record the results on Figure 1 or a similar form. The absolute value of the difference between the maximum and minimum average values recorded must not vary more than  $\pm 3$  percent or  $\pm 1$  ppm of the up-scale gas value, whichever is less restrictive.



|                  |  |  |  |  |  |  |  |  |  |  |  |
|------------------|--|--|--|--|--|--|--|--|--|--|--|
| "                |  |  |  |  |  |  |  |  |  |  |  |
| "                |  |  |  |  |  |  |  |  |  |  |  |
| "                |  |  |  |  |  |  |  |  |  |  |  |
| "                |  |  |  |  |  |  |  |  |  |  |  |
| "                |  |  |  |  |  |  |  |  |  |  |  |
| "                |  |  |  |  |  |  |  |  |  |  |  |
| "                |  |  |  |  |  |  |  |  |  |  |  |
| "                |  |  |  |  |  |  |  |  |  |  |  |
| "                |  |  |  |  |  |  |  |  |  |  |  |
| "                |  |  |  |  |  |  |  |  |  |  |  |
| Mean             |  |  |  |  |  |  |  |  |  |  |  |
| Refresh<br>Phase |  |  |  |  |  |  |  |  |  |  |  |
| "                |  |  |  |  |  |  |  |  |  |  |  |
| "                |  |  |  |  |  |  |  |  |  |  |  |
| "                |  |  |  |  |  |  |  |  |  |  |  |
| "                |  |  |  |  |  |  |  |  |  |  |  |

[78 FR 6721, Jan. 30, 2013]

**CERTIFICATE OF SERVICE**

I, Cynthia Hook, hereby certify that a copy of this permit has been mailed by first class mail to Georgia-Pacific Chemicals LLC, P.O. Box 520, Crossett, AR, 71635, on this 6<sup>th</sup> day of October, 2016.



\_\_\_\_\_  
Cynthia Hook, ASIII, Office of Air Quality