

NPDES Notice of Intent (NOI)
Concentrated Animal Feeding Operations(CAFO)
ARG590000

I. GENERAL INFORMATION			
A. TYPE OF BUSINESS	B. CONTACT INFORMATION		C. FACILITY OPERATION STATUS
Concentrated Animal Feeding Operation	Owner/or Operator Name <u>Jason Henson</u> Address (No-POBOX) <u>Hc 72 PO Box 10 Mount Judea Arkansas 72655</u> Telephone: <u>(870) 715-9468 (Cell)</u> Email: <u>jasonh@rittermail.com</u> City: <u>Mount Judea</u> State: <u>AR</u> Zip Code: <u>72655</u>		<input type="checkbox"/> 1. Existing Facility <input checked="" type="checkbox"/> 2. Proposed Facility
D. FACILITY INFORMATION			
Name: <u>C&H Hog Farms</u> Telephone: <u>(870) 688-1318</u> Address: <u>Hc 72 PO Box 10</u> City: <u>Mount Judea</u> State: <u>AR</u> Zip Code: <u>72655</u> County: <u>Newton</u> Latitude: <u>35.55' 13.6"</u> Longitude: <u>93.4' 51.0"</u> If contract operation: Name of Integrator: _____ Address of Integrator: _____			
II CONCENTRATED ANIMAL FEEDING OPERATION CHARACTERISTICS			
A. TYPE AND NUMBER OF ANIMALS		B. Manure, Litter, and/or Wastewater Production and Use	
2. ANIMALS		1. How much manure, litter, and wastewater is generated annually by the facility?tons <u>2,090,181</u> gallons 2. If land applied how many acres of land under the control of the applicant are available for applying the CAFOs manure/litter/wastewater? <u>630.7</u> acres 3. How many tons of manure or litter, or gallons of wastewater produced by the CAFO will be transferred annually to other persons? <u>0</u> tons/gallons (circle one)	
1. TYPE	NO. IN OPEN CONFINEMENT	NO. HOUSED UNDER ROOF	
<input type="checkbox"/> Mature Dairy Cows			
<input type="checkbox"/> Dairy Heifers			
<input type="checkbox"/> Veal Calves			
<input type="checkbox"/> Cattle (not dairy or veal calves)			
<input checked="" type="checkbox"/> Swine (55 lbs. or over)		2,503	
<input checked="" type="checkbox"/> Swine (under 55 lbs.)		4,000	
<input type="checkbox"/> Horses			

<input type="checkbox"/> Sheep or Lambs			
<input type="checkbox"/> Turkeys			
<input type="checkbox"/> Chickens (Broilers)			
<input type="checkbox"/> Chickens (Layers)			
<input type="checkbox"/> Ducks			
<input type="checkbox"/> Other Specify			
3. TOTAL ANIMALS			

C. TOPOGRAPHIC MAP : See Section E Sheet 2

D. TYPE OF CONTAINMENT, STORAGE AND CAPACITY

I. Type of Containment	Total Capacity (in gallons)
<input type="checkbox"/> Lagoon	
<input checked="" type="checkbox"/> Holding Pond	2,735,922
<input type="checkbox"/> Evaporation Pond	
<input checked="" type="checkbox"/> Other: Specify <u>Shallow Pits</u>	759,542

2. Report the total number of acres contributing drainage: 0 acres

3. Type of Storage	Total Number of Days	Total Capacity (gallons/tons)
<input type="checkbox"/> Anaerobic Lagoon		
<input type="checkbox"/> Storage Lagoon		
<input type="checkbox"/> Evaporation Pond		
<input type="checkbox"/> Aboveground Storage Tanks		
<input type="checkbox"/> Belowground Storage Tanks		
<input type="checkbox"/> Roofed Storage Shed		
<input type="checkbox"/> Concrete Pad		
<input type="checkbox"/> Impervious Soil Pad		
<input type="checkbox"/> Other: Specify _____		

E. NUTRIENT MANAGEMENT PLAN

Note: A permit application is not complete until a nutrient management plan (NMP) is submitted with NOI.

1. Please indicate whether a nutrient management plan has been included with this permit application. Yes No (STOP)
2. Is a nutrient management plan being implemented for the facility? Yes No
3. The date of the last review or revision of the nutrient management plan. Date: May 30, 2012
4. If not land applying, describe alternative use(s) of manure, litter, and or wastewater:

F. LAND APPLICATION BEST MANAGEMENT PRACTICES

Please check any of the following best management practices that are being implemented at the facility to control runoff and protect water quality:

- Buffers Setbacks Conservation tillage Constructed wetlands Infiltration field Grass filter Terrace

III. CERTIFICATION

I certify under penalty of law that I have personally examined and am familiar with the information submitted in this application and all attachments and that, based on my inquiry of those individuals immediately responsible for obtaining the information, I believe that the information is true accurate and complete. I am aware that there are significant penalties for submitting false information, including the possibility of fine and imprisonment.

A. Name and Official Title (print or type)

Jason Henson owner

B. Phone No. (870) 688-1318

C. Signature

Jason Henson

D. Date Signed

6-5-12



**DeHaan, Grabs
& Associates, LLC**

Consulting Engineers

www.dgaengineering.com

June 7, 2012

**RE: Jason Henson, C & H Hog Farms, Permit to Construct,
SSection 26, T-15-N, R-20-E, Newton County, AR**

Richard McConnell,
Arkansas Department of Environmental Quality
5301 Northshore Drive
North Little Rock, AR 72118-5317

Dear Richard McConnell:

I have enclosed a construction approval application and NPDES ARG59000 permit for C & H Hog Farms proposed hog operation of 2,500 head farrowing farm. Enclosed is the original copy.

We appreciate your review of these documents and if you have questions, do not hesitate to give me a call or send me an email at Nate@dgaengineering.com.

Cordially

Nathan A. Pesta, P.E.
Senior Project Engineer

Enclosures

cc: Jason Henson, w/encl
Geoff Bates, w/encl

North Dakota Office

P.O. Box 522
Mandan, ND 58554-0522
(701) 663-1116
Fax (701) 667-1356



**DeHaan, Grabs
& Associates, LLC**

Consulting Engineers

www.dgaengineering.com

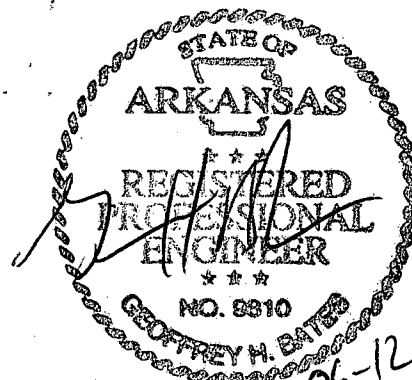

C&H Hog Farms

Major Construction Approval Application

Section 26, T-15-N, R-20-E
Newton County, Arkansas

May 18, 2012

Prepared for:

Jason Henson
Hc 72 PO Box 10
Newton, AR 72655

Prepared by:

DeHaan, Grabs & Associates, LLC
PO Box 522
Mandan, ND 58554

&

Bates & Associates, Inc.
91 Colt Square Dr.
Fayetteville, AR 72703

North Dakota Office

P.O. Box 522

Mandan, ND 58554-0522

(701) 663-1116

Fax (701) 667-1356

Table of Contents

Section A: ADEQ Application

1. NPDES Notice of Intent Application
2. NPDES Permit Application Form 1
3. EPA Form 2B (See NPDES Notice of Intent Application)

Section B: Applicant Disclosure

1. Applicant Disclosure

Section C: Design Report

1. Narrative Summary of Design
2. Design Calculations
3. General Maps
 - 3.1 County Location Map
 - 3.2 Detailed USGS Topographical Map
 - 3.3 USDA Soil Survey Map
 - 3.4 2,000 foot Radius Map

Section D: Site Specific Information

1. Site Specific Information
2. Well Logs and Registration
3. Geological Investigation and Lab Testing Reports

Section E: Facility Plans

Section F: Technical Specifications

1. Earthen Structures
2. Concrete Construction Specifications
3. Steel Reinforcement for Concrete Construction Specifications
4. Quality Assurance Program

Section G: Operation and Maintenance Guideline & Facility Logs

1. Operation and Maintenance Guideline
2. Concrete Construction Specifications

Section H: Nutrient Management Plan (Separate Book)

Section A: ADEQ Notice of Intent
Application

INSTRUCTIONS

GENERAL

This form must be completed by all applicants Exclusions are based on size and whether or not the facility discharges proposed to discharge. See the description of these exclusions in the CAFO permit and regulations at 40 CFR 122.23.

Item I-A

See the note above to be sure that your facility is a "concentrated animal feeding operation" (CAFO).

Item I-B

Use this space to give owner/operator contact information.

Item I-C

Check "proposed" if your facility is not now in operation or is expanding to meet the definition of a CAFO in accordance with the CAFO regulations at 40 CFR 122.23.

Item I-D

Use this space to give a complete legal description of your facility's location including name, address, and latitude/longitude. Also, if a contract grower, the name and address of the integrator.

Item II

Supply all information in item II

Item II-A

Give the maximum number of each type of animal in open confinement or housed under roof (either partially or totally) which are held at your facility for a total of 45 days or more in any 12 month period. Provide the total number of animals confined at the facility.

Item II-B

Provide the total amount of manure, litter, and wastewater generated annually by the facility. Identify if manure, litter, and wastewater generated by the facility is to be land applied and the number of acres, under the control of the CAFO operator, suitable for land application. If the answer to question 3 is yes, provide the estimated annual quantity of manure, litter, and wastewater that the applicant plans to transfer off-site.

Item II-C

Check this box if you have submitted a topographic map of the entire operation, including the production area and land under the operational control of the CAFO operator where manure, litter, and/or wastewater are applied with Form 1.

Item II-D

1. Provide information on the type of containment and the capacity of the containment structure (s).
2. The number of acres that are drained and collected in the containment structure (s).
3. Identify the type of storage for the manure, litter, and/or wastewater. Give the capacity of this storage in days.

Item II-E

Provide information concerning the status of submitting a nutrient management plan for the facility to complete the application. In those cases where the nutrient management plan has not been submitted, provide an explanation. If not land applying, describe the alternative uses of the manure, litter, and wastewater (e.g., composting, pelletizing, energy generation, etc.).

Item II-F

Check any of the identified conservation practices that are being implemented at the facility to control runoff and protect water quality.

Item III

The Clean Water Act provides for severe penalties for submitting false information on this application form.

Section 309(C)(2) of the Clean Water Act provides that "Any person who knowingly makes any false statement, representation, or certification in any application, shall upon conviction, be punished by a fine of no more than \$10,000 or by imprisonment for not more than six months, or both."

Federal regulations require the certification to be signed as follows:

- A. For corporation, by a principal executive officer of at least the level of vice president.
- B. For a partnership or sole proprietorship, by a general partner or the proprietor, respectively; or
- C. For a municipality, State, federal, or other public facility, by either a principal executive officer or ranking elected official.

Arkansas Department of Environmental Quality
NPDES PERMIT APPLICATION
FORM 1

INSTRUCTIONS:

1. This form should be **typed or printed in ink**. If insufficient space is available to address any item please continue on an attached sheet of paper.
2. Please complete the following Section (s):

Sections	A	B	C	D	E	F	G	H	I
POTW	X	X	X	X					X
Industrial User	X	X	X	X	X	X	X		X
Construction Permit Only	X	X	*	X				X	X
Modification	X	X	X	X	X	*	*	X	X
All Other Applicants	X	X	X	X	X				X

* As necessary

3. If you need help on SIC or NAICS go to www.osha.gov/oshstats/sicser.html
4. If you have any questions about this form you may call NPDES Section at 501-682-0622 or go to www.adeq.state.ar.us/water. You may also contact :

Department
Arkansas Department of Health

Information in Regard to
Water Supply

Telephone #
501-661-2623

5. The following EPA Forms in addition to Form 1 is required for processing your application:
 - Form 2A - Municipal Dischargers
 - Form 2B - Concentrated Animal Feeding Operations
 - Form 2C - Existing Manufacturing, Commercial, Mining, and Silvicultural Operations
 - Form 2D - New Sources and New Dischargers Application for Permit to Discharge Process Wastewater
 - Form 2E - Facilities Which Do Not Discharge Process Wastewater (i.e. Domestic, Non contact cooling water)
 - Form 2F - Application for Permit to Discharge Storm Water Discharges Associated With Industrial Activity
6. Where to Submit

Return the completed form by mail to:

Arkansas Department of Environmental Quality
 Permits Branch, Water Division
 5301 Northshore Drive
 North Little Rock, AR 72118

Or by email to:

Water-Permit-Application@adeq.state.ar.us

NPDES PERMIT APPLICATION
FORM 1

ARKANSAS DEPARTMENT OF ENVIRONMENTAL QUALITY
WATER DIVISION
5301 Northshore Drive
North Little Rock, AR 72118-5317
www.adeq.state.ar.us/water

PURPOSE OF THIS APPLICATION

- INITIAL PERMIT APPLICATION FOR NEW FACILITY
 INITIAL PERMIT APPLICATION FOR EXISTING FACILITY
 MODIFICATION OF EXISTING PERMIT
 REISSUANCE (RENEWAL) OF EXISTING PERMIT
 MODIFICATION AND CONSTRUCTION OF EXISTING PERMIT
 CONSTRUCTION PERMIT

SECTION A- GENERAL INFORMATION

1. Legal Applicant Name (who has ultimate decision making responsibility over the operation of a facility or activity):

Jason Henson

Note: The legal name of the applicant must be identical to the name listed with the Arkansas Secretary of State.

2. Operator Type: Private State Federal Partnership Corporation Other

State of Incorporation: Arkansas

3. Facility Name: C&H Hog Farms

4. Is the legal applicant identified in number 1 above, the owner of the facility? Yes No

5. NPDES Permit Number (If Applicable): AR00

6. NPDES General Permit Number (If Applicable): ARG590000

7. NPDES General Storm Water Permit Number (If Applicable): _____

8. Permit Numbers and/or names of any permits issued by ADEQ or EPA for an activity located in Arkansas that is presently held by the applicant or its parent or subsidiary corporation which are not listed above:

Permit Name

Permit Number

Held by

9. Give driving directions to the wastewater treatment plant with respect to known landmarks:

The location for this project is approximately 1.6 miles west of Mt. Judea AR in Newton County. Driving direction from Mt. Judea is approximately 0.8 miles southwest on County Rd. 54 and right on County Rd. 41 for approximately 0.75 miles. The site is located on the left hand side of the road on a logging trail.

10. Facility Physical Location: (Attach a map with location marked; street, route no. or other specific identifier)

Street: HC 72 PO Box 10 Mount Judea, Arkansas, 72655

City: Mount Judea County: Newton State: Arkansas Zip: 72655

11. Facility Mailing Address for permit, DMR, and Invoice (Street or Post Office Box):

Name: Jason Henson Title: President
Street: HC 72 P.O. Box 10
City: Mount Judea State: Arkansas Zip: 72655
E-mail address*: jasonh@rittermail.com Fax: N/A

* Is emailing all documents (permit, letters, DMRs, invoices, etc.) acceptable to the applicant? Yes No

12. Neighboring States Within 20 Miles of the permitted facility (Check all that apply):

Oklahoma Missouri Tennessee Louisiana Texas Mississippi

13. Indicate applicable Standard Industrial Classification (SIC) Codes and NAICS codes for primary processes

_____ SIC Facility Activity under this SIC or NAICS:
_____ NAICS

14. Design Flow: _____ MGD Highest Monthly Average of the last two years Flow: _____ MGD

15. Is Outfall equipped with a diffuser? Yes No

16. Responsible Official (as described on the last page of this application):

Name: Jason Henson Title: President
Address: HC 72 Phone Number: 870-688-1318
E-mail Address: Jasonh@rittermail.com
City: Mount Judea State: AR Zip: 72655

17. Cognizant Official (Duly Authorized Representative of responsible official as describe on the last page of this application):

Name: _____ Title: _____
Address: _____ Phone Number: _____
E-mail Address: _____
City: _____ State: _____ Zip: _____

18. Name, address and telephone number of active consulting engineer firm (If none, so state):

Contact Name: Nathan Pesta
Company Name: DeHaan, Grabs & Associates, LLC
Address: 1701 10th Avenue SW, Bldg 15 Phone Number: 701-663-1116
E-mail Address: nate@dgaengineering.com
City: Mandan State: North Dakota Zip: 58554

19. Wastewater Operator Information

Wastewater Operator Name: _____ License number: _____
Class of municipal wastewater operator: I II III IV
Class of industrial wastewater operator: Basic Advanced

SECTION B: FACILITY AND OUTFALL INFORMATION

1. Facility Location (All information must be based on front door (Gate) location of the facility):

Lat: 35 ° 55 ' 13.60 " Long: -93 ° 4.0 ' 51.00 " County: Newton Nearest Mt. Town: Judea

2. Outfall Location (The location of the end of the pipe Discharge point.):

Outfall No. _____:

Latitude: _____ ° _____ ' _____ " Longitude: _____ ° _____ ' _____ "

Where is the collection point? _____

Name of Receiving Stream (i.e. an unnamed tributary of Mill Creek, thence into Mill Creek; thence into Arkansas River):

N/A

Outfall No. _____:

Latitude: _____ ° _____ ' _____ " Longitude: _____ ° _____ ' _____ "

Where is the collection point? _____

Name of Receiving Stream (i.e. an unnamed tributary of Mill Creek, thence into Mill Creek; thence into Arkansas River):

N/A

3. Monitoring Location (If the monitoring is conducted at a location different than the above Outfall location):

Outfall No. _____:

Lat: _____ ° _____ ' _____ " Long: _____ ° _____ ' _____ "

Outfall No. _____:

Lat: _____ ° _____ ' _____ " Long: _____ ° _____ ' _____ "

Outfall No. _____:

Lat: _____ ° _____ ' _____ " Long: _____ ° _____ ' _____ "

4. Type of Treatment system (Included all components of treatment system and Attach the process flow diagram):

Manure will be stored in the Waste Storage Pond's 1 & 2 and from there will be land applied on Fields 1-17 as shown in the NMP.

5. Do you have, or plan to have, automatic sampling equipment or continuous wastewater flow metering equipment at this facility?

Current:	Flow Metering	<input type="checkbox"/>	Yes	Type: _____	<input checked="" type="checkbox"/>	No	<input type="checkbox"/>	N/A	<input type="checkbox"/>
	Sampling Equipment	<input type="checkbox"/>	Yes	Type: _____	<input checked="" type="checkbox"/>	No	<input type="checkbox"/>	N/A	<input type="checkbox"/>
Planned:	Flow Metering	<input type="checkbox"/>	Yes	Type: _____	<input checked="" type="checkbox"/>	No	<input type="checkbox"/>	N/A	<input type="checkbox"/>
	Sampling Equipment	<input type="checkbox"/>	Yes	Type: _____	<input checked="" type="checkbox"/>	No	<input type="checkbox"/>	N/A	<input type="checkbox"/>

If yes, please indicate the present or future location of this equipment on the sewer schematic and describe the equipment below:

6. Is the proposed or existing facility located above the 100-year flood level? Yes No

NOTE: FEMA Map must be included with this application. Maps can be ordered at www.fema.gov.

If "No", what measures are (or will be) used to protect the facility? _____

7. Population for Municipal and Domestic Sewer Systems: _____

8. Backup Power Generation for Treatment Plants

Are there any permanent backup generators? Yes No

If Yes, How many? _____ Total Horespower (hp)? _____

If No, Please explain? _____

SECTION C – WASTE STORAGE AND DISPOSAL INFORMATION

1. Sludge Disposal Method (Check as many as are applicable):

Landfill

Landfill Site Name _____ ADEQ Solid Waste Permit No. _____

Land Application: ADEQ State Permit No. _____

Septic tank Arkansas Department of Health Permit No.: _____

Distribution and Marketing: Facility receiving sludge:

Name: _____ Address: _____

City: _____ State: _____ Zip: _____ Phone: _____

Rail: _____ Pipe: _____ Other: _____

Subsurface Disposal (Lagooning):

Location of lagoon _____ How old is the lagoon? _____

Surface area of lagoon: _____ Acre Depth: _____ ft Does lagoon have a liner? Yes No

Incineration: Location of incinerator _____

Remains in Treatment Lagoon(s):

How old is the lagoon(s)? _____ Has sludge depth been measured? Yes No

If Yes, Date measured? _____ Sludge Depth? _____ ft If No, When will it be measured? _____

Has sludge ever been removed? Yes No If Yes, When was it removed? _____

Other (Provide complete description): _____

SECTION D - WATER SUPPLY

Water Sources (check as many as are applicable):

Private Well - Distance from Discharge point: Within 5 miles Within 50 miles

Municipal Water Utility (Specify City): Mount Judea

Distance from Discharge point: Within 5 miles Within 50 miles

Surface Water- Name of Surface Water Source: _____

Distance from Discharge point: Within 5 miles Within 50 miles

Lat: _____ ° _____ ' _____ " Long: _____ ° _____ ' _____ "

Other (Specify): _____

Distance from Discharge point: Within 5 miles Within 50 miles

SECTION E: FINANCIAL ASSURANCE AND DISCLOSURE STATEMENT

1. Arkansas Code Annotated § 8-4-203 provides for financial assurance requirements for permitting non-municipal domestic sewage treatment systems. Arkansas Code 8-4-203 (b)(1)(A)(i) – “The department shall not issue, modify, or renew a National Pollutant Discharge Elimination System permit or state permit for a non-municipal domestic sewage treatment works without the permit applicant first demonstrating to the department its financial ability to cover the estimated costs of operating and maintaining the non-municipal domestic sewage treatment works for a minimum period of five (5) years.”

The applicant must provide a detailed estimate of the operation and maintenance (O&M) costs for the facility for a five year period. Once the O&M estimate is approved, the applicant must provide **financial assurance** in order to show that the facility is able to cover the costs of operating and maintaining the treatment system for the next five years.

The minimal financial assurance may be demonstrated to the department by using the following as outlined in Arkansas Code 8-4-203(b)(2):

- A. Obtaining insurance that specifically covers operation and maintenance costs
 - B. Obtaining a letter of credit;
 - C. Obtaining a surety/performance bond;
 - D. Obtaining a trust fund or an escrow account; or
 - E. Using a combination of insurance, letter of credit, surety bond, trust fund, or escrow account.
2. Disclosure Statement:

Arkansas Code Annotated Section 8-1-106 requires that all applicants for any type of permit or transfer of any permit, license, certification or operational authority issued by the Arkansas Department of Environmental Quality (ADEQ) file a Disclosure Statement with their application. The filing of a Disclosure Statement is mandatory. No application can be considered administratively complete without a completed Disclosure Statement. The form may be obtained from the ADEQ web site at:

http://www.adeg.state.ar.us/disclosure_stmt.pdf

SECTION F – INDUSTRIAL ACTIVITY

1. Does an effluent guideline limitation promulgated by EPA ([Link to a Listing of the 40 CFR Effluent Limit Guidelines](#)) under Section 304 of the Clean Water Act (CWA) apply to your facility?

YES (Answer questions 2 and 3) NO

2. What Part of 40 CFR? _____

3. What Subpart(s)? _____

4. Give a brief description of all operations at this facility including primary products or services (attach additional sheets if necessary):

5. Production: (projected for new facilities)

Product(s) Manufactured (Brand name)	Last 12 Months		Highest Production Year of Last 5 Years	
	lbs/day*		lbs/day*	
	Highest Month	Days of Operation	Monthly Average	Days of Operation

* These units could be off-lbs, lbs quenched, lbs cleaned/etched/rinsed, lbs poured, lbs extruded, etc.

SECTION G - WASTEWATER DISCHARGE INFORMATION

Facilities that checked "Yes" in question 1 of Section F are considered Categorical Industrial Users and should skip to question 2.

1. For Non-Categorical Users Only: List average wastewater discharge, maximum discharge, and type of discharge (batch, continuous, or both), for each plant process. Include the reference number from the process flow schematic (reference Figure 1) that corresponds to each process. [New facilities should provide estimates for each discharge.]

No.	Process Description	Average Flow (GPD)	Maximum Flow (GPD)	Type of Discharge (batch, continuous, none)

If batch discharge occurs or will occur, indicate: [New facilities may estimate.]

Number of batch discharges: ____ per day Average discharge per batch: ____ (GPD)

Time of batch discharges ____ at ____
(days of week) (hours of day)

Flow rate: ____ gallons/minute Percent of total discharge: ____

Answer questions 2, 3, and 4 only if you are subject to Categorical Standards.

2. For Categorical Users: Provide the wastewater discharge flows for each of your processes or proposed processes. Include the reference number from the process flow schematic (reference Figure 1) that corresponds to each process. [Note: 1) New facilities should provide estimates for each discharge and 2) Facilities should denote whether the flow was measured or estimated.]

No.	Regulated Process	Average Flow (GPD)	Maximum Flow (GPD)	Type of Discharge (batch, continuous, none)

No.	Unregulated Process	Average Flow (GPD)	Maximum Flow (GPD)	Type of Discharge (batch, continuous, none)

SECTION H -TECHNICAL INFORMATION

Technical information to support this application shall be furnished in appropriate detail to understand the project. Information in this Part is required for obtaining a **construction permit** or for **modification** of the treatment system.

1. Describe the treatment system. Include the types of control equipment to be installed along with their methods of operation and control efficiency.

The Waste handling system will consist of shallow pits underneath the barns, these pits will be emptied by 8" pull-plugs that gravity drains the effluent to Waste Storage Pond 1. From Waste Storage Pond 1 the effluent can gravity drain to Waste Storage Pond 2 by means of 15" Pipe and Riser and an overflow spillway. The containment system has over 270 days of storage.

2. One set of construction plans and specifications, approved (Signed and stamped) by a **Professional Engineer (PE)** registered in Arkansas, must be submitted as follows:
 - a. The plans must show flow rates in addition to pertinent dimensions so that detention times, overflow rates, and loadings per acre, etc. can be calculated.
 - b. Specifications and complete design calculations.
 - c. All treated wastewater discharges should have a flow measuring device such as a weir or Parshall flume installed. Where there is a significant difference between the flow rates of the raw and treated wastewater, a flow measuring device should be provided both before and after treatment.
3. If this application includes a construction permit disturbing five or more acres, a storm water construction permit must be obtained by submitting a notice of intent (NOI) to ADEQ.

SECTION I: SIGNATORY REQUIREMENTS

Cognizant Official (Duly Authorized Representative)

40 CFR 122.22(b) states that all reports required by the permit, or other information requested by the Director, shall be signed by the applicant (or person authorized by the applicant) or by a duly authorized representative of that person. A person is duly authorized representative only if:

- (1) the authorization is made in writing by the applicant (or person authorized by the applicant);
- (2) the authorization specifies either an individual or a position having responsibility for the overall operation of the regulated facility or activity responsibility, or an individual or position having overall responsibility for environmental matters for the company.

The applicant hereby designates the following person as a Cognizant Official, or duly authorized representative, for signing reports, etc., including Discharge Monitoring Reports (DMR) required by the permit, and other information requested by the Director:

Signature of Cognizant Official: JASON Henson Date: 6-5-12
Printed name of Cognizant Official: JASON Henson
Official title of Cognizant Official: President Telephone Number: 870-688-1318

Responsible Official

The information contained in this form must be certified by a **responsible official** as defined in the "signatory requirements for permit applications" (40 CFR 122.22).

Responsible official is defined as follows:

Corporation, a principal officer of at least the level of vice president

Partnership, a general partner

Sole proprietorship: the proprietor

Municipal, state, federal, or other public facility: principal executive officer, or ranking elected official.

____ (Initial) "I certify that the cognizant official designated above is qualified to act as a duly authorized representative under the provisions of 40 CFR 122.22(b)." NOTE: If no duly authorized representative is designated in this section, the Department considers the applicant to be the responsible official for the facility and only reports, etc., signed by the applicant will be accepted by the Department.

____ (Initial) "I certify that, if this facility is a corporation, it is registered with the Secretary of State in Arkansas. Please provide the full name of the corporation if different than that listed in Section A above."

"I certify under penalty of law that this document and all attachments were prepared under my direction or supervision in accordance with a system designed to assure that qualified personnel properly gather and evaluate the information submitted. Based on my inquiry of the person or persons who manage the system, or those persons directly responsible for gathering the information, the information submitted is, to the best of my knowledge and belief, true, accurate, and complete. I am aware that there are significant penalties for submitting false information including the possibility of fine and imprisonment for knowing violations. I further certify under penalty of law that all analyses reported as less than detectable in this application or attachments thereto were performed using the EPA approved test method having the lowest detection limit for the substance tested."

Signature of Responsible Official: JASON Henson Date: 6-5-12
Printed name of Responsible Official: Jason Henson
Official title of Responsible Official: President Telephone Number: 870-688-1318

Section B: Application Disclosure

ARKANSAS DEPARTMENT OF ENVIRONMENTAL QUALITY DISCLOSURE STATEMENT

Instructions for the Completion of this Document:

- A. Individuals, firms or other legal entities with no changes to an ADEQ Disclosure Statement, complete items 1 through 5 and 18.**
- B. Individuals who never submitted an ADEQ Disclosure Statement, complete items 1 through 4, 6, 7, and 16 through 18.**
- C. Firms or other legal entities who never submitted an ADEQ Disclosure Statement, complete 1 through 4, and 6 through 18.**

Mail to:
ADEQ
DISCLOSURE STATEMENT
[List Proper Division(s)]
5301 Northshore Drive
North Little Rock, AR 72118-5317

Hand Deliver to:
ADEQ
DISCLOSURE STATEMENT
[List Proper Division (s)]
5301 Northshore Drive
North Little Rock, AR 72118-5317

1. APPLICANT: (Full Name)

C&H Hog Farms, Inc.

2. MAILING ADDRESS (Number and Street, P.O.Box Or Rural Route):

HC 72 Box 10

3. CITY, STATE, AND ZIPCODE:

Mount Judea, AR 72655

4. (check all that apply.)

- Individual Corporate or Other Entity
 Permit License Certification Operational Authority
 New Application Modification Renewal Application (If no changes from previous disclosure statement, complete number 5 and 18.)
 Air Water Hazardous Waste Regulated Storage Tank Mining Solid Waste
 Environmental Preservation and Technical Service

5. Declaration of No Changes:

The violation history, experience and credentials, involvement in current or pending environmental lawsuits, civil and criminal, have not changed since the last Disclosure Statement I filed with ADEQ on _____

 Signature of Individual or Authorized Representative of Firm or Legal Entity
 (Also complete #18.)

6. Describe the experience and credentials of the Applicant, including the receipt of any past or present permits, licenses, certifications or operational authorization relating to environmental regulation. (Attach additional pages, if necessary.)

The operators of C&H Hog Farms, Inc., Jason Henson, Richard Campbell, and Philip Campbell, already have experience in farming, and especially in swine operations. C&C Hog Barn is jointly owned and operated by Richard Campbell and Philip Campbell. This organization has operated a 325 head gestation and farrowing farm located near Jasper, AR, for the past twelve (12) years. The farm operates in full compliance with state and federal regulations, holds a Regulation 5 permit, and all necessary classifications. This business venture will cease operations after C&H Hog Farms, Inc., becomes operational.

7. List and explain all civil or criminal legal actions by government agencies involving environmental protection laws or regulations against the Applicant * in the last ten (10) years including:

1. Administrative enforcement actions resulting in the imposition of sanctions;
2. Permit or license revocations or denials issued by any state or federal authority;
3. Actions that have resulted in a finding or a settlement of a violation; and
4. Pending actions.

(Attach additional pages, if necessary.)

To date, there have been no civil or criminal legal actions by government agencies involving environmental protection laws or regulations against the applicant and affiliated persons in the past ten (10) years immediately preceding the filing of this application, nor have there been any administrative enforcement actions resulting in the imposition of sanctions, permit or license revocations or denials issued by any state or federal authority against Jason Henson, Richard Campbell, or Philip Campbell.

* Firms or other legal entities shall also include this information for all persons and legal entities identified in sections 8-16 of this Disclosure Statement.

8. List all officers of the Applicant. (Add additional pages, if necessary.)

NAME: Jason Henson TITLE: President
STREET: HC 72 Box 10
CITY, STATE, ZIP: Mount Judea, AR 72655

NAME: Richard Campbell TITLE: Vice - President
STREET: P.O. Box 45
CITY, STATE, ZIP: Vendor, AR 72683

NAME: Philip Campbell TITLE: Secretary
STREET: P.O. Box 41
CITY, STATE, ZIP: Vendor, AR 72683

9. List all directors of the Applicant. (Add additional pages, if necessary.)

NAME: Jason Henson TITLE: President
STREET: HC 72 Box 10
CITY, STATE, ZIP: Mount Judea, AR 72655

NAME: Richard Campbell TITLE: Vice-President
STREET: P.O. Box 45
CITY, STATE, ZIP: Vendor, AR 72683

NAME: Philip Campbell TITLE: Secretary
STREET: P.O. Box 41
CITY, STATE, ZIP: Vendor, AR 72683

10. List all partners of the Applicant. (Add additional pages, if necessary.)

NAME: Jason Henson TITLE: President
STREET: HC 72 Box 10
CITY, STATE, ZIP: Mount Judea, AR 72655

NAME: Richard Campbell TITLE: Vice-President
STREET: P.O. Box 45
CITY, STATE, ZIP: Vendor, AR 72683

NAME: Philip Campbell TITLE: Secretay
STREET: P.O. Box 41
CITY, STATE, ZIP: Vendor, AR 72683

11. List all persons employed by the Applicant in a supervisory capacity or with authority over operations of the facility subject to this application.

NAME: Jason Henson TITLE: President
STREET: HC 72 Box 10
CITY, STATE, ZIP: Mount Judea, AR 72655

NAME: Richard Campbell TITLE: Vice-President
STREET: P.O. Box 45
CITY, STATE, ZIP: Vendor, AR 72683

NAME: Philip Campbell TITLE: Secretary
STREET: P.O. Box 41
CITY, STATE, ZIP: Vendor, AR 72683

12. List all persons or legal entities, who own or control more than five percent (5%) of the Applicant's debt or equity.

NAME: Jason Henson TITLE: President
STREET: HC 72 Box 10
CITY, STATE, ZIP: Mount Judea, AR 72655

NAME: Richard Campbell TITLE: Vice-President
STREET: P.O. Box 45
CITY, STATE, ZIP: Vendor, AR 72683

NAME: Philip Campbell TITLE: Secretary
STREET: P.O. Box
CITY, STATE, ZIP: Vendor, AR 72683

13. List all legal entities, in which the Applicant holds a debt or equity interest of more than five percent (5%).

NAME: C&C Hog Barn TITLE: _____
STREET: HC 31 Box 135
CITY, STATE, ZIP: Jasper, AR 72641

NAME: _____ TITLE: _____
STREET: _____
CITY, STATE, ZIP: _____

NAME: _____ TITLE: _____
STREET: _____
CITY, STATE, ZIP: _____

14. List any parent company of the Applicant. Describe the parent company's ongoing organizational relationship with the Applicant.

NAME: _____
STREET: _____
CITY, STATE, ZIP: _____

Organizational Relationship:

15. List any subsidiary of the Applicant. Describe the subsidiary's ongoing organizational relationship with the Applicant.

NAME: _____
STREET: _____
CITY, STATE, ZIP: _____

Organizational Relationship:

16. List any person who is not now in compliance or has a history of noncompliance with the environmental laws or regulations of this state or any other jurisdiction and who through relationship by blood or marriage or through any other relationship could be reasonably expected to significantly influence the Applicant in a manner which could adversely affect the environment.

NAME: _____ TITLE: _____

STREET: _____

CITY, STATE, ZIP: _____

NAME: _____ TITLE: _____

STREET: _____

CITY, STATE, ZIP: _____

17. List all federal environmental agencies and any other environmental agencies outside this state that have or have had regulatory responsibility over the Applicant.

18. VERIFICATION AND ACKNOWLEDGEMENT

The Applicant agrees to provide any other information the director of the Arkansas Department of Environmental Quality may require at any time to comply with the provisions of the Disclosure Law and any regulations promulgated thereto. The Applicant further agrees to provide the Arkansas Department of Environmental Quality with any changes, modifications, deletions, additions or amendments to any part of this Disclosure Statement as they occur by filing an amended Disclosure Statement.

DELIBERATE FALSIFICATION OR OMISSION OF RELEVANT INFORMATION FROM DISCLOSURE STATEMENTS SHALL BE GROUNDS FOR CIVIL OR CRIMINAL ENFORCEMENT ACTION OR ADMINISTRATIVE DENIAL OF A PERMIT, LICENSE, CERTIFICATION OR OPERATIONAL AUTHORIZATION.

State of Arkansas

County of Newton

I, Jason Henson, swear and affirm that the information contained in this Disclosure Statement is true and correct to the best of my knowledge, information and belief.

APPLICANT SIGNATURE: Jason Henson

COMPANY TITLE: C4H Hog farms

DATE: 6-5-12

SUBSCRIBED AND SWORN TO BEFORE ME THIS 6 DAY OF 5 2012

Glen Smith

NOTARY PUBLIC

MY COMMISSION EXPIRES:
12-31-2012



Section C: Design Report

SECTION C: DESIGN REPORT

C1: NARRATIVE SUMMARY OF DESIGN

CNH Hog Farms is located in Newton County in Northwest Arkansas and is a part of the Newton County Natural Resource District. The farm will have 2 shallow pit confinement barns with a maximum capacity of 6,503 head of swine weighing an average of 150 lbs.

The gestation and farrowing barn is on slatted floors over 2 feet deep shallow pits. The effluent will gravity drain to Waste Storage Pond 1 with pull-plugs and 8" PVC pipe. Waste Storage Pond 1 will gravity drain to Waste Storage Pond 2 with a 15" Pipe and riser and an emergency overflow spillway. The buildings will be totally roofed and all extraneous drainage will be drained away from the site.

The farm is located approximately 1.6 miles to the west of Mount Judea AR. Driving direction from Mount Judea is approximate 0.8 miles southwest on County Road 54 and right on County Road 41 approximately 0.75 miles. The legal location is Section 26, Township 15 North, Range 20 East, Newton County, Arkansas.

The size of the storage is over 270 days of storage. The minimum ADEQ requirements are for 180 days of storage.

All animal waste generated by this complex will be disposed of through land application. The waste will be recycled and utilized on the surrounding grassland. There are approximately 670.4 acres of cropland near the complex. The area will be used to produce hay and pasture, thereby consuming the nutrients in a full cycle system. All land application areas will receive application at rates consistent with infiltration capabilities of the native soil such that there is no runoff to surrounding areas. A buffer strip will be maintained between waste utilization areas, streams, and property boundaries.

C2: DESIGN CALCULATIONS

- a. The waste storage ponds are sized as shown on the following calculations:

Waste Storage Calculations

A. Determine Storage Provided

Type of storage: Earthen Storage Pit Earthen Lagoon Concrete Tank
 Underfloor Concrete Pit Outside Concrete Pit
 Other (describe) _____

NOTE: A scale drawing, calculations and other supporting information will be included. Indicate the location of all diversions, diversion dimensions, and flow directions of surface runoff for the entire facility. Concrete pit or tank storage is assumed to be covered unless specified otherwise.

Rectangular Concrete Pit or Tank (capacity = length x width x depth)

$$\begin{aligned} & \frac{420.3 \text{ feet} \times 114.3 \text{ feet} \times 1.5 \text{ feet}}{227.3 \text{ feet} \times 76.3 \text{ feet} \times 1.7 \text{ feet}} = \frac{72,060 \text{ cubic feet (Manure Pit \#1)}}{29,483 \text{ cubic feet (Manure Pit \#2)}} \\ & = \underline{101,543} \text{ cubic feet TOTAL} \end{aligned}$$

Waste Storage Pond 1 Volume = $[(4 \times \text{sideslope}^2 \times \text{depth}^3) / 3] + (\text{sideslope} \times \text{bottomlength} \times \text{depth}^2) + (\text{sideslope} \times \text{bottomwidth} \times \text{depth}^2) + (\text{bottomwidth} \times \text{bottomlength} \times \text{depth})$

Bottom Length: _____ Bottom Width: _____

Design Full Depth: 9.7 feet, Overflow Depth: 10.7 feet

Side Slopes: 3 :1 and 3 , End Slopes: 3 :1 and 3 :1

Note: Inside slopes for earthen pits or lagoons will be at least 2:1.

Earthen Storage Pit or Lagoon Capacity: 111,122 cubic feet

Waste Storage Pond 2 Volume = $[(4 \times \text{sideslope}^2 \times \text{depth}^3) / 3] + (\text{sideslope} \times \text{bottomlength} \times \text{depth}^2) + (\text{sideslope} \times \text{bottomwidth} \times \text{depth}^2) + (\text{bottomwidth} \times \text{bottomlength} \times \text{depth})$

Bottom Length: _____ Bottom Width: _____

Design Full Depth: 11.7 feet, Overflow Depth: 12.7 feet

Side Slopes: 3 :1 and 3 , End Slopes: 3 :1 and 3 :1

Note: Inside slopes for earthen pits or lagoons will be at least 2:1.

Earthen Storage Pit or Lagoon Capacity: 254,643 cubic feet

NOTE: A minimum of 1.0 foot of freeboard is required for uncovered storage.

TOTAL STORAGE PROVIDED: 467,308 cubic feet

NOTE: The Total Storage Provided will meet or exceed the Minimum Storage Requirement (item o) from Waste Productions Calculation

SECTION C2: DESIGN CALCULATIONS

Waste Production Calculations

A. Facility Information

1. Type of Construction: existing, proposed-new, or expansion

2. Building Area, **Barn 1 Gestation Barn** (Proposed): 421.3 feet by 117.5 feet
Barn 2 Farrowing Barn (Proposed): 367.1 feet by 82.5 feet

3. Animal Capacity	<u>3</u> head of <u>Boars</u>	@	<u>450</u> lbs,	<u>1,350</u> lbs Total
	<u>2,100</u> head of <u>Gestation Sows</u>	@	<u>375</u> lbs,	<u>787,500</u> lbs Total
	<u>400</u> head of <u>Lactating Sow</u>	@	<u>425</u> lbs,	<u>170,000</u> lbs Total
(maximum head counts and average weights)	<u>4,000</u> head of <u>Nursery Pig</u>	@	<u>10</u> lbs,	<u>40,000</u> lbs Total
	_____ head of _____	@	_____ lbs,	_____ lbs Total

Total: 6,503 head Total Animal Weight (TAW): 998,850 lbs

B. Determine Minimum Storage Requirement

The Minimum Storage Requirement is the sum of the animal waste produced (or treatment volume for an anaerobic lagoon), plus the spillage and washwater, plus the pit recharge produced in 180 days. Generally, outside or contributing drainage area runoff is to be diverted. Runoff which is not diverted must be included in the storage requirement.

The following is completed for either Liquid Manure Storage or Anaerobic Lagoon

Liquid Manure Storage

Unit Waste Production (UWP) in cubic feet per day per 1,000 pounds of animal:

<u>Cattle</u>	<u>Swine</u>	<u>Poultry</u>	<u>Other</u>
<input type="checkbox"/> Dairy = 1.3	<input checked="" type="checkbox"/> Nursery Pig = 1.4	<input type="checkbox"/> Layers = 0.9	<input type="checkbox"/> Horse = 0.8
<input type="checkbox"/> Beef = 1.0	<input type="checkbox"/> Grower/Finisher = 1.0	<input type="checkbox"/> Broiler = 1.3	<input type="checkbox"/> Sheep = 0.6
	<input checked="" type="checkbox"/> Boar/Gestating Sow = 0.41	<input type="checkbox"/> Turkey = 0.7	
	<input checked="" type="checkbox"/> Sow and Litter = 0.97		

(a) Manure produced: (TAW x (UWP x 180 days/1,000)) = 97,979 cubic feet / 1,000 lbs
 (TAW x UWP for each type calculated separately and added to find total manure produced)

(b) Spillage and Washwater generated in 180 days: 19,596 cubic feet
 (If unknown, 20% of (a) is used)

(c) Total Manure plus Spillage and Washwater, (a)+(b): 117,575 cubic feet.

Rainfall Data

(d) 25 Year- 24 Hour Rainfall Event: 0.58 Feet

- (e) Precipitation-Evaporation October 1 – April 1) 0.92 Feet
- (f) Top of Waste Storage Pond 1 20,857 Square feet
- (g) Top of Waste Storage Pond 2 35,262 Square feet

- (h) Waste Storage Pond 1 25 Yr-24 Hr Storage Requirement (d) x (f): 12,097 cubic feet
- (i) Waste Storage Pond 2 25 Yr-24 Hr Storage Requirement (d) x (g): 20,452 cubic feet
- (j) Waste Storage Pond 1, 180 Day Net Precip. Requirement (e) x (f): 19,119 cubic feet
- (k) Waste Storage Pond 2, 180 Day Net Precip. Requirement (e) x (g): 32324 cubic feet

Recharge Water -The farrowing barn will be pulled once every three weeks and the Gestation Barn will be pulled once every five weeks on a conservative estimate and will be recharged with 2" of fresh water .

- (l) Recharge Water Produced Average: 366(cubic feet per day) x 180 (180 days in storage period)
= 65,880 cubic feet per 180 days.

Runoff

- (m) Sand Lane and Stacking Pad Area: _____ feet x _____ feet = _____ square feet
- (n) Manure Stacking Pad Area: _____ feet x _____ feet = _____ square feet
- (o) Feed Stacking Pad Area: _____ feet x _____ feet = _____ square feet
- (p) Total Runoff Area: _____ square feet
- (q) Minimum Runoff (Figure 1 from Appendix): _____ inches

NOTE: If a covered storage is used which collects runoff, then the sum of the 25 year, 24 hour storm runoff and the expected runoff for the 180 day storage period is used as the Minimum Runoff in (m).

- (r) Minimum Runoff Storage Requirement (l) x (m)/12 = _____ cubic feet

Minimum Overall Storage Requirement

- (s) Minimum Storage Requirement (c or g) + (h) + (n): 279,436 cubic feet

C3: GENERAL MAPS

1. County Location Map
2. Detailed USGS Topographical Map
3. USDA Soil Survey Map
4. 2,000 feet Radius Map

ARKANSAS

NEWTON COUNTY

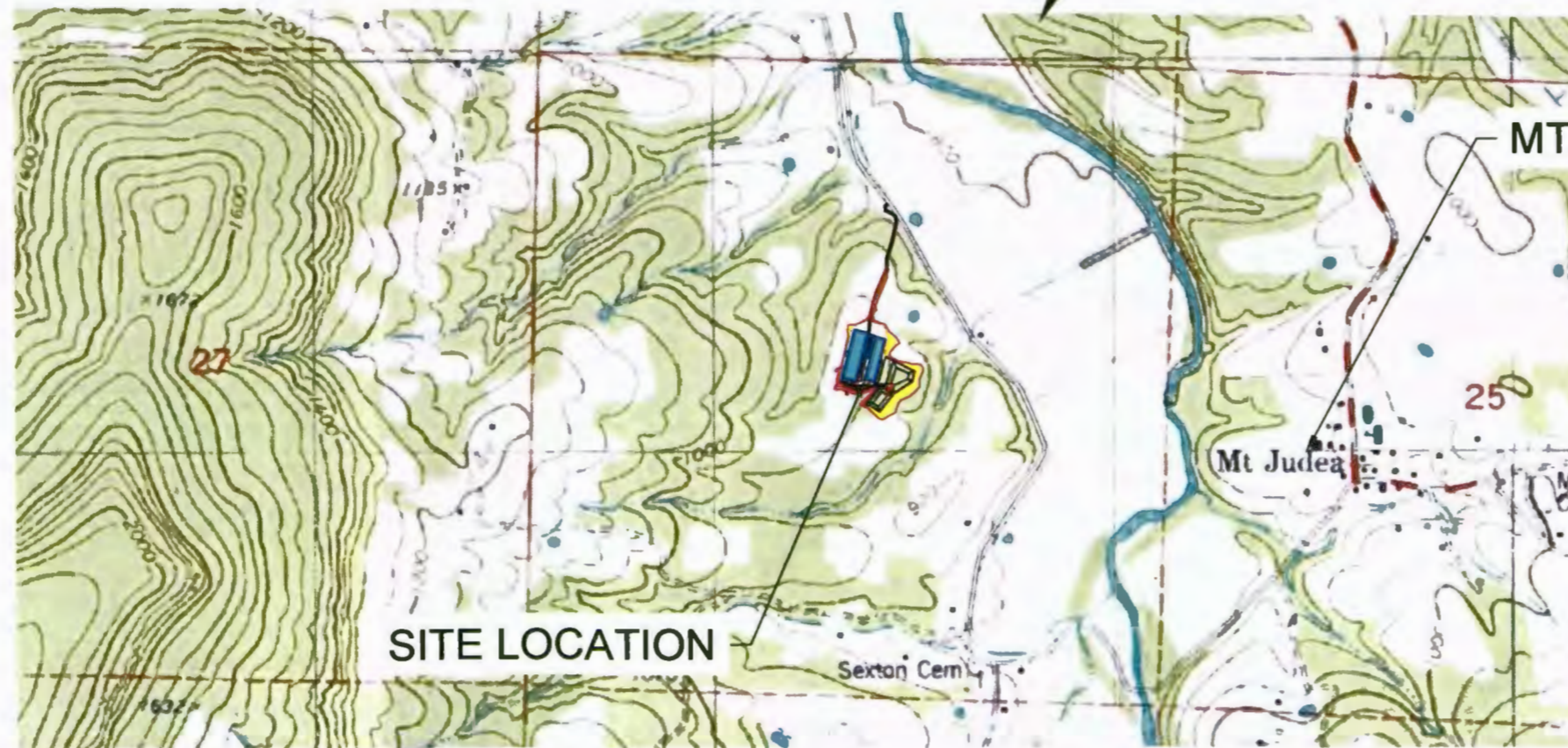
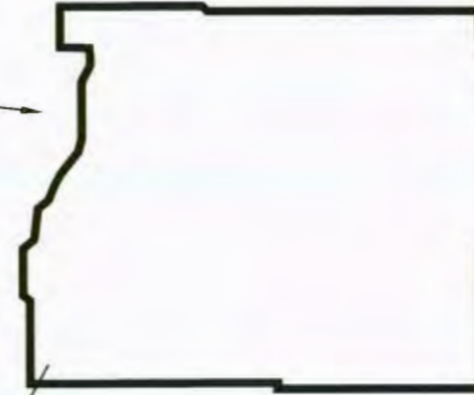
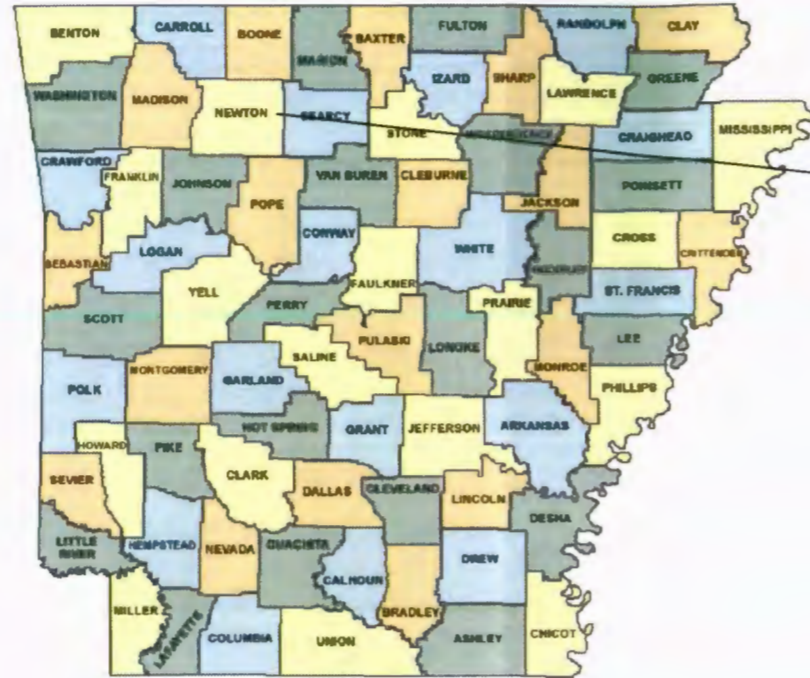

SITE LOCATION

MT. JUDEA

GENERAL NOTES

LEGEND



No.	Revision/Issue	Date

DeHaan, Grabs & Associates, LLC
 Consulting Engineers
 PO Box 522, Mandan, ND 58554
 (701) 663-1116, FAX: (701) 667-1356
 www.dgaengineering.com

C&H HOG FARMS
 GESTATION-FARROWING FARM
 SECTION 26, T 15 N, R 20 W
 NEWTON COUNTY, AR
COUNTY LOCATION MAP

DATE: MAY 22, 2012	SHEET: C.3.1
SCALE: 1" = 1000'	
DRAWN BY: CAS	
CHECKED BY: DLD	

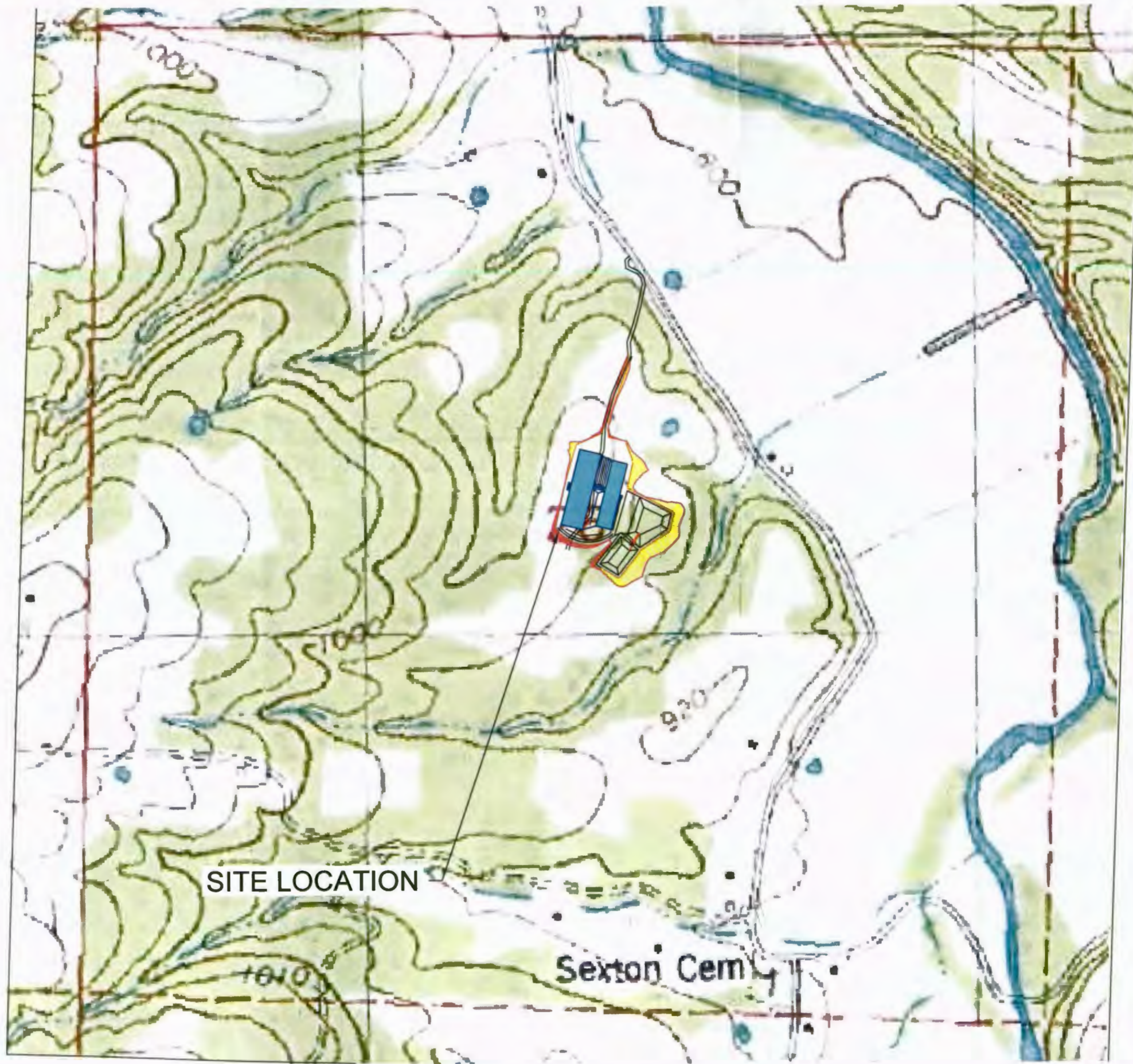

GENERAL NOTES

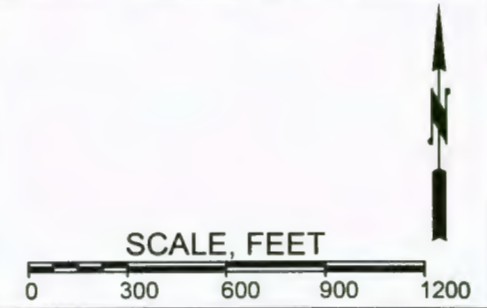

No.	Revision/Issue	Date

DeHaan, Grabs & Associates, LLC
 Consulting Engineers
 PO Box 522, Mandan, ND 58554
 (701) 663-1116, FAX: (701) 667-1356
 www.dgaengineering.com

C&H HOG FARMS
 GESTATION-FARROWING FARM

SECTION 26, T 15 N, R 20 W
 NEWTON COUNTY, AR

DETAILED USGS
 TOPOGRAPHICAL MAP

DATE: MAY 22, 2012	SHEET: C.3.2
SCALE: 1" = 600'	
DRAWN BY: CAS	
CHECKED BY: DLD	



LEGEND

- 3 Arkana-Moko complex, 20 to 40 percent slopes
- 6 Ceda-Kenn complex, frequently flooded
- 11 Enders gravelly loam, 3 to 8 percent slopes
- 13 Enders stony loam, 3 to 20 percent slopes
- 26 Moko-Rock outcrop complex, 15 to 50 percent slopes
- 35 Nella-Enders stony loams, 8 to 20 percent slopes
- 42 Noark very cherty silt loam, 3 to 8 percent slopes
- 43 Noark very cherty silt loam, 8 to 20 percent slopes
- 44 Noark very cherty silt loam, 20 to 40 percent slopes
- 48 Razort loam, occasionally flooded
- 50 Spadra loam, occasionally flooded
- 51 Spadra loam, 2 to 5 percent slopes
- 54 Water

GENERAL NOTES



SCALE, FEET

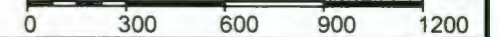

No.	Revision/Issue	Date

DeHaan, Grabs & Associates, LLC
 Consulting Engineers
 PO Box 522, Mandan, ND 58554
 (701) 663-1116, FAX: (701) 667-1356
 www.dgaengineering.com

C&H HOG FARMS
 GESTATION-FARROWING FARM

SECTION 26, T 15 N, R 20 W
 NEWTON COUNTY, AR

USDA SOIL SURVEY MAP

DATE: MAY 22, 2012	SHEET: C.3.3
SCALE: 1" = 600'	
DRAWN BY: CAS	
CHECKED BY: DLD	

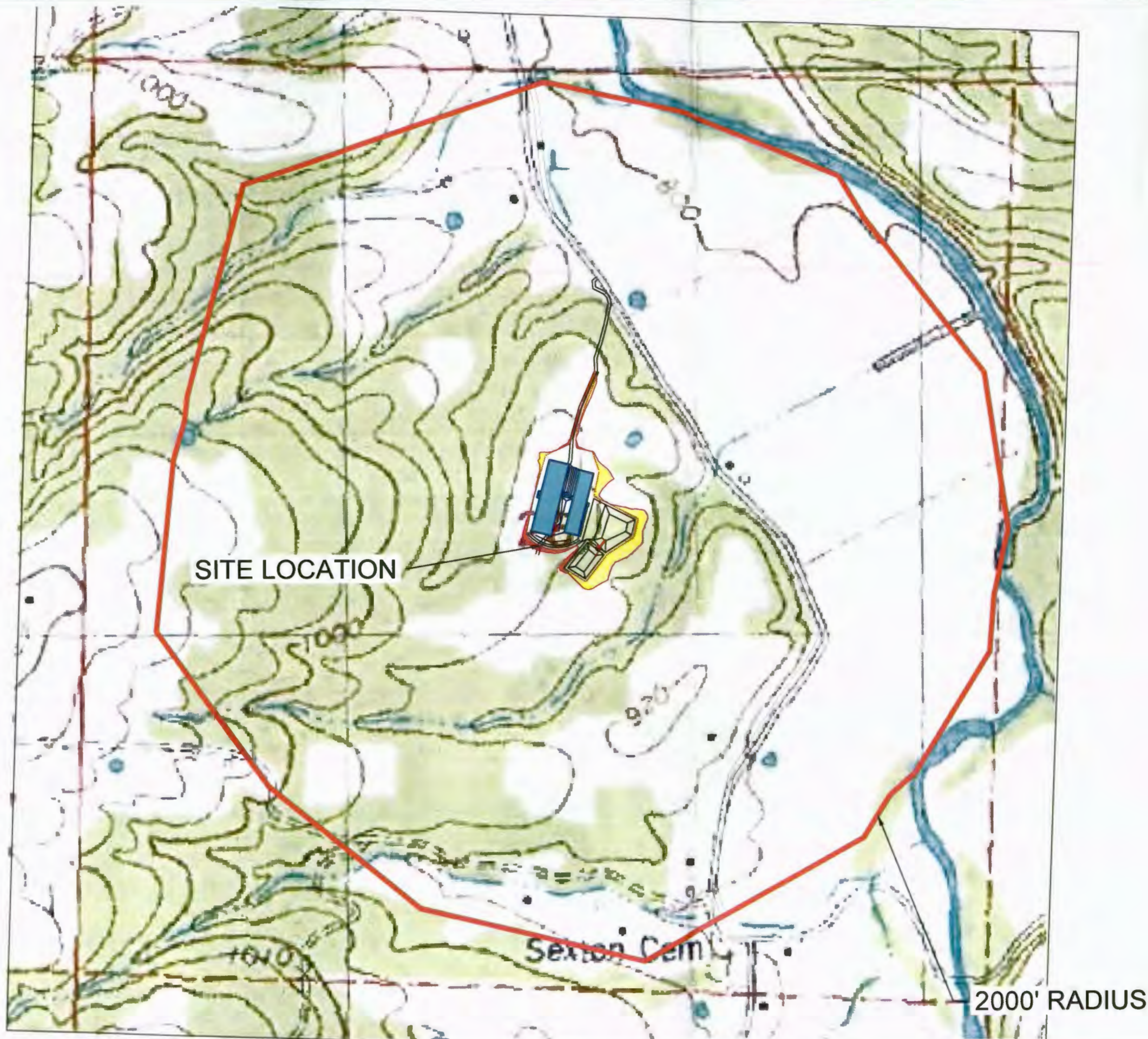

GENERAL NOTES

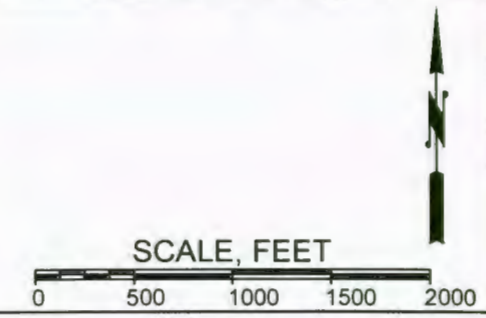

No.	Revision/Issue	Date

DeHaan, Grabs & Associates, LLC
 Consulting Engineers
 PO Box 522, Mandan, ND 58554
 (701) 663-1116, FAX: (701) 667-1356
 www.dgaengineering.com

C&H HOG FARMS
 GESTATION-FARROWING FARM

SECTION 26, T 16 N, R 20 W
 NEWTON COUNTY, AR

2000' RADIUS MAP

DATE: MAY 22, 2012	SHEET: C.3.4
SCALE: 1" = 1000'	
DRAWN BY: CAS	
CHECKED BY: DLD	

Section D: Site Specific Information

SECTION D: SITE SPECIFIC INFORMATION

1. SITE SPECIFIC INFORMATION

1: FACILITY INFORMATION

a. Facility:

NAME: C&H Hog Farms
ADDRESS: HC 72 PO Box 10
Mount Judea, AR 72655
PHONE NUMBER: (870) 688-1318
PRESIDENT: Jason Henson

b. MANAGER:

NAME: Jason Henson
ADDRESS: HC 72 PO Box 10
Mount Judea, AR 72655
PHONE: (870) 715-9468 (cell)
EMAIL: jasonh@rittermail.com

2: LEGAL LOCATION OF FACILITY

SW ¼, Section 26, T15N, R20W, Newton County, AR

3: APPROXIMATE LATITUDE/LONGITUDE OF FACILITY

Latitude: 35° 55' 13.60"
Longitude: -93° 4' 51.00"

4: DRIVING DIRECTIONS:

The location for this project is approximately 1.6 miles west of Mt. Judea AR in Newton County. Driving direction from Mt. Judea is approximately 0.8 miles southwest on County Rd. 54 and right on County Rd. 41 for approximately 0.75 miles. The site is located on the left hand side of the road on a logging trail.

5: SOIL TYPE IN AREA OF CONTROL STRUCTURE

According to the USDA Survey, the soil in the areas of the proposed barn is a Noark very cherty silt loam, 8 to 20% slopes, (43) and Razort loam, occasionally flooded (48). The soil profile for 43 from 0 to 14 inches is very gravelly clay loam, from 14-43 inches is very gravelly silty clay, and from 43-72 inches is very gravelly clay. The soil profile for 48 from 0 to

55 inches is loam, from 55-65 inches is gravelly sandy loam.

6: NAME AND DISTANCE TO THE NEAREST WATERCOURSE

A Tributary to Big Creek is located approximately 355 feet to the southeast.

7: DEPTH TO WATER TABLE AT FACILITY/CONTROL STRUCTURE

The static water level is approximately 189 feet, at a well located approximately 1491.831 feet south and 4320.776 feet east of the Proposed site. (G-128819, see section D3, Well Logs and Registration)

8: SEPARATION DISTANCE FROM CLOSEST RESIDENCES, BUSINESSES, CHURCHES OR SCHOOLS

Mount Judea Elementary school is the nearest local school and is located about 1.103 miles to the east of the site.

1

2 **2. WELL LOGS and REGISTRATION**

3 *See Attached*

Driller DB

Page 1 of 1

STATE OF ARKANSAS
 VIEW REPORT ON WATER WELL CONSTRUCTION & PUMP INSTALLATION
 [HOME PAGE]

A	1. Contractor Name & Number:		ARNOLD WELL DRILLING & PUMP SE (1077)	
	2. Driller Name & Number:		BENJAMIN D. WOODS (2736)	
	3. Pump Installer Name & Number:		UNKNOWN	
	4. Date Well Completed: 08/30/2004		New Well	
5. COUNTY: NEWTON (101)			6 FRACTION 1/4 of 1/4 of 7 SECTION 15N	8 TOWNSHIP 36 9 RANGE 20W
10. LONGITUDE: 93-03-55		11. LATITUDE 35-54-53		

B	DESCRIPTION OF FORMATION	DEPTHS IN FEET		WATER BEARING	IF YES, DEPTH
		FROM	TO		
	OVERBURDEN	0.00	9.00	No	
	WHITE LS	9.00	64.00	No	
	WHITE SD	64.00	145.00	No	
	WHITE LS	145.00	178.00	No	
	WHITE SD	178.00	354.00	No	
	GRAY LS	354.00	395.00	No	
	RED LS	395.00	415.00	No	
	WHITE SD	415.00	436.00	No	
	WHITE LS	436.00	720.00	No	
	GRAY LS	720.00	830.00	No	
	WHITE LS	830.00	846.00	No	
	1. DEPTH TO WATER		3@354', 7@830'		PT
2. TOTAL DEPTH OF WELL 846.00					
3. STATIC WATER LEVEL 189.00 Ft below land surface					
4. YIELD 10 gallons per Y					
5. DIAMETER OF BORE HOLE					

C	PUMP REPORT	
	1 TYPE PUMP	
	2 SETTING DEPTH: 0.00 FEET	
	3 BRAND NAME AND SERIAL NUMBERS:	
	4 RATED CAPACITY 0.00	
	5 TYPE LUBRICATION	
	6 DROP PIPE OR COLUMN PIPE SIZE	
	7 WIRE SIZE:	
	8 PRESSURE TANK: SIZE: MAKE: MODEL:	
	9 DATE OF INSTALLATION OR REPAIR	
10 Is there an abandoned water well on the property? No		

D	1 LAND OWNER OR OTHER CONTACT PERSON NAME: GLENDA & LELMER CAMPBELL STREET ADDRESS: PO BOX 65 CITY: YENDOR, AR 72682	
	CASING FROM TO W/ CASING FROM 0.00 TO 182.00 W/ TYPE CASING STEEL	
	3. SCREEN TYPE: DIA SLOT/A SET FROM FT TO FT TYPE: DIA SLOT/A SET FROM FT TO FT	
	4. GRAVEL PACK FROM: FT TO: FT	
	5. BACK FILLED WITH: CUTTINGS FROM: 0.00 FT TO: 184.00 FT	
	6. SEALED WITH: BENTONITE FROM: 184.00 FT FT TO: 189.00 FT 6. SEALED WITH: FROM: FT TO: FT FROM: FT TO: FT	
	7. DISINFECTED WITH: CHLORINE	
	8. USE OF WELL:	
	9. A/C HEATPUMP TYPE WELLS	
	(For A/C only) Will system also be used for purposes other than Heating and Air Conditioning? No	
	(For A/C open-loop only) Into what medium is water returned?	
11. REMARKS		
12. SIGNED	DATE	

Driller DB

Page 1 of 1

STATE OF ARKANSAS
 VIEW REPORT ON WATER WELL CONSTRUCTION & PUMP INSTALLATION
 (HOME PAGE)

A	1. Contractor Name & Number:		VALLEY WATER WELL DRILLING (1312)	
	2. Driller Name & Number:		UNKNOWN	
	3. Pump Installer Name & Number:		UNKNOWN	
	4. Date Well Completed: 08/11/2003		New Well	
5. COUNTY: NEWTON (101)			6 FRACTION 1/4 of 1/4 of 7 SECTION 12N	8 TOWNSHIP 3S 9 RANGE 20W
11. LONGITUDE: 93-03-57		11. LATITUDE 35-54-18		

B	DESCRIPTION OF FORMATION	DEPTHS IN FEET		WATER BEARING	IF YES, DEPTH
		FROM	TO		
	NONE				
2. TOTAL DEPTH OF WELL 700.00					
3. STATIC WATER LEVEL Ft. below land surface					
4. YIELD					
5. DIAMETER OF BORE HOLE					

C	PUMP REPORT:
1	TYPE PUMP
2	SETTING DEPTH: 0.00 FEET
3	BRAND NAME AND SERIAL NUMBERS
4	RATED CAPACITY 0.00
5	TYPE LUBRICATION
6	DROP PIPE OR COLUMN PIPE SIZE
7	WIRE SIZE:
8	PRESSURE TANK: SIZE MAKE MODEL:
9	DATE OF INSTALLATION OR REPAIR
10	Is there an abandoned water well on the property? No

D	1 LAND OWNER OR OTHER CONTACT PERSON NAME: KAREN BRISTER STREET ADDRESS: CITY:
CASING FROM TO W/ ID CASING FROM TO W/ ID TYPE CASING Well Co. 12	
3. SCREEN TYPE: DIA SLOT/GA SET FROM FT TO FT TYPE: DIA SLOT/GA SET FROM FT TO FT	
4. GRAVEL PACK FROM: FT TO: FT	
5. BACK FILLED WITH: FROM: FT TO: FT	
6. SEALED WITH: FROM: FT TO: FT FROM: FT TO: FT	
7. DISINFECTED WITH:	
8. USE OF WELL:	
9. A/C HEATPUMP TYPE WELLS	
(For A/C only) Will system also be used for purposes other than Heating and Air Conditioning? No	
(For A/C open-loop only) Into what medium is water returned?	
11. REMARKS	
12. SIGNED	DATE

Driller DB

Page 1 of 1

STATE OF ARKANSAS
VIEW REPORT ON WATER WELL CONSTRUCTION & PUMP INSTALLATION

[HOME PAGE]

A	1. Contractor Name & Number:		VALLEY WATER WELL DRILLING (1332)	
	2. Driller Name & Number:		JOHN KING (2313)	
	3. Pump Installer Name & Number:		UNKNOWN	
	4. Date Well Completed: 05/20/1997		New Well	
5. COUNTY: NEWTON (01)			6 FRACTION SE 1/4 of SW 1/4 of	8 TOWNSHIP 14N
			7 SECTION 35	9 RANGE 19W
11. LONGITUDE: 23-05-12		11. LATITUDE 35-54-24		

B	DESCRIPTION OF FORMATION	DEPTHS IN FEET		WATER BEARING	IF YES... DEPTH
		FROM	TO		
	CL	0.00	22.00	No	
	SH	22.00	52.00	No	
	LS	52.00	504.00	No	
	LS	504.00	560.00	No	
	LS	560.00	665.00	No	
	SD	665.00	930.00	No	
	LS	930.00	1035.00	No	
	1. DEPTH TO WATER	1020			FT
	2. TOTAL DEPTH OF WELL	1035.00			
	3. STATIC WATER LEVEL	310.00 Ft. below land surface			
	4. YIELD	gallons per X			
	5. DIAMETER OF BORE HOLE	6.25 IN			

C	PUMP REPORT	
	1 TYPE PUMP	
	2 SETTING DEPTH: 0.00 FEET	
	3 BRAND NAME AND SERIAL NUMBERS:	
	4 RATED CAPACITY 0.00	
	5 TYPE LUBRICATION	
	6 DROP PIPE OR COLUMN PIPE SIZE	
	7 WIRE SIZE:	
	8 PRESSURE TANK SIZE: MAKE: MODEL:	
	9 DATE OF INSTALLATION OR REPAIR	
10 Is there an abandoned water well on the property? No		

D	1 LAND OWNER OR OTHER CONTACT PERSON NAME: KENT MEYER STREET ADDRESS: 221 W. EURANKS CITY: OKLAHOMA CITY, OK	
	CASING FROM TO W/ CASING FROM TO 130.00 W/ TYPE CASING STEEL	
	3. SCREEN TYPE: DIA SLOT/GA SET FROM FT TO FT TYPE: DIA SLOT/GA SET FROM FT TO FT	
	4. GRAVEL PACK FROM: FT TO: FT	
	5. BACK FILLED WITH: drill cuttings FROM: 0.00 FT TO: 125.00 FT	
	6. SEALED WITH: CEMENT FROM: 125.00 FT TO: 130.00 FT 6. SEALED WITH: FROM: FT TO: FT FROM: FT TO: FT	
	7. DISINFECTED WITH: CHLORINE	
	8. USE OF WELL: DOMESTIC	
	9. A/C HEATPUMP TYPE WELLS (For A/C only) Will system also be used for purposes other than Heating and Air Conditioning? No (For A/C open-loop only) Into what medium is water returned?	
	11. REMARKS	
12. SIGNED _____ DATE _____		

1 **3. Geologic Investigation**

2 The USDA Soil Survey predicts that the soil in the location of the storage structures is
3 primarily a Noark very cherty silt loam, 3 to 8% slopes, (42). The soil profile for 42 from
4 0 to 14 inches is very gravelly silt loam, from 14-43 inches is very gravelly silty clay, and
5 from 43-72 inches is very gravelly clay.

6
7 The holding ponds will be constructed with an 18-inch thick liner.

8
9 Geotechnical & Testing Services conducted laboratory tests on some of the samples.
10 Atterburg limits were run on the soil samples for the sandy lean clay. The results were as
11 follows:

Boring #	Depth (ft)	Description	LL	PL	PI
2	3.0- 4.5'	Silty Lean Clay	38	22	16
2	4.5 - 6.0'	Sandy Lean Clay	44	24	20
2	7.0 - 8.5'	Fat Clay w/sand	93	38	55
2	9.5-11'	Sandy Fat Clay	64	23	41
3	7-8.5'	Fat Clay w/sand	58	36	22
3	9.5-11'	Clayey Gravel with Sand	81	44	37

12
13
14 The soil proposed for the holding pond liner is Fat Clay w/sand and Fat Clay w/sand (CL)
15 identified in the soils report at the depths of 7-11' feet in boring numbers 2-3.

16
17 Recompacted soil test are currently being run to determine the Coefficient of Permeability
18 using Darcy's Law. Results will be forwarded on once they are completed by the testing
19 lab.

20
21 Currently it is recommended that the liner be constructed at 95% compaction +-2%
22 Optimum Moisture to meet seepage requirements. This may change based off results
23 from the Recompacted Permeability.

24
25 The seepage rate of any compacted liner that will be used will be less than the maximum
26 allowable seepage rate of 5,000 Gallons/acre/per day as required by Arkansas Department
27 of environment Quality.

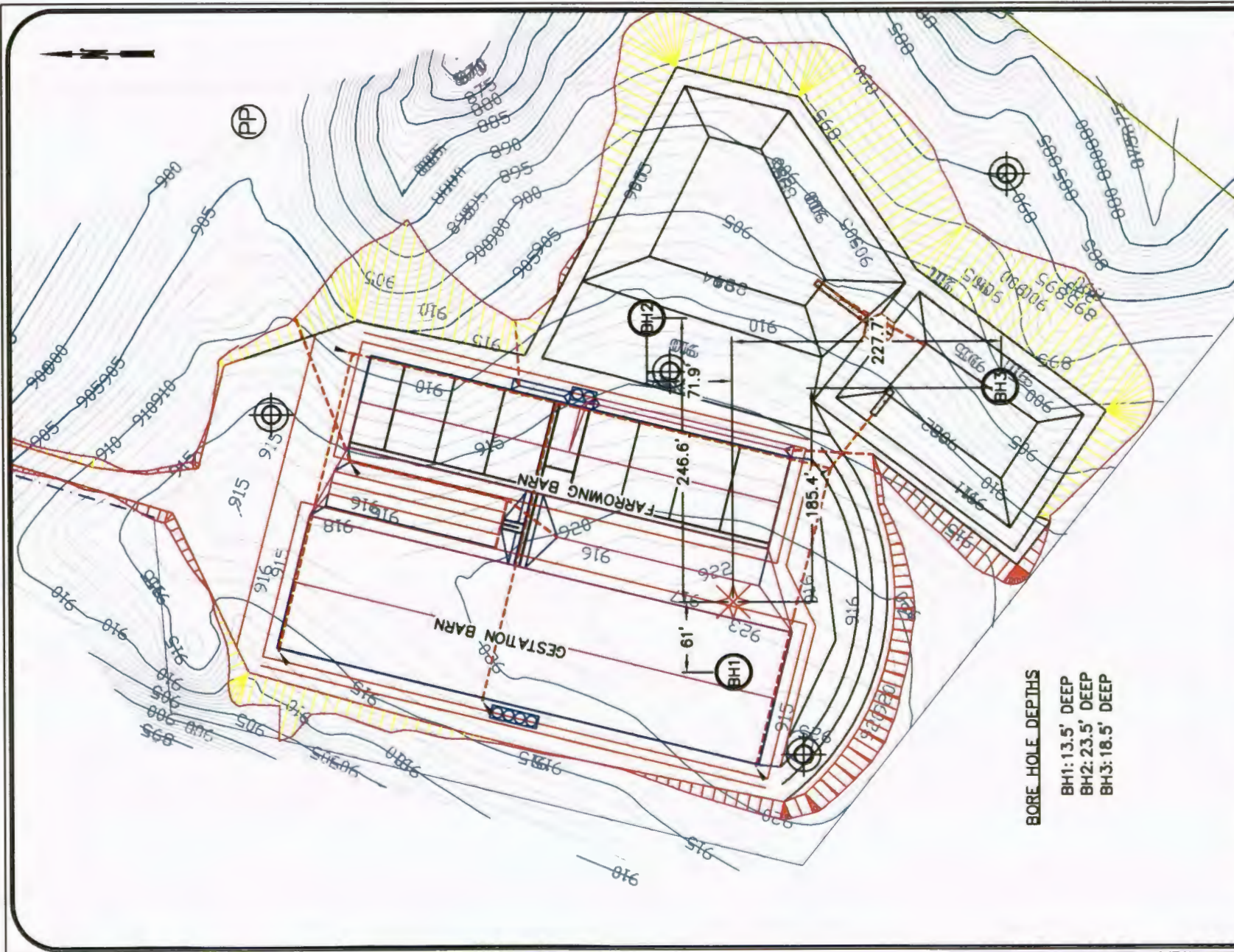

BORE HOLE DEPTHS
 BH1: 13.5' DEEP
 BH2: 23.5' DEEP
 BH3: 18.5' DEEP

GENERAL NOTES

LEGEND

- ◆ BENCHMARK
- ▭ BUILDINGS
- - - FENCELINE
- - - CULVERT/PIPE
- ← DRAINAGE ARROW

SCALE, FEET

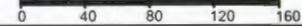

DeHaan, Grabs & Associates, LLC
 Registration Number: C-1341

No.	Revision/Issue	Date

DeHaan, Grabs & Associates, LLC
 Consulting Engineers
 PO Box 522, Mardon, MO 64854
 (701) 663-1116, FAX: (701) 667-1366
 www.dgceengineering.com

JASON HENSON
 GESTATION-FARROWING FARM

SECTION 26, T 16 N, R 20 W
 NEWTON COUNTY, AR

DETAILED
PROPOSED SITE PLAN

DATE: APR 30, 2012
 SCALE: 1" = 80'
 DRAWN BY: NAP
 CHECKED BY: DLD

SHEET:
 3

LOG OF BORING NO.B-1

Proposed Pond and Building Pads
Mt. Judea, Arkansas



Fayetteville, AR

Project No.: 12-15049

Location: Shown on Boring Location Diagram

DEPTH, FT	SYMBOL	SAMPLES	SAMPLE No.	RECOVERY (in.)	DESCRIPTION OF MATERIAL	USCS	%<#200	HAND PENETROMETER, TSF ■				BLOWS PER FT
								0.4	0.8	1.2	1.6	
								LAB. COHESION, TSF ▲				
								WATER CONTENT, % ●				
								PL	LL			
								20	40	60	80	
0					Surface Description=Grass Cover Rootmat = 4"							
			1	12	<u>SILTY SAND</u> medium dense, brown with organics	SM						17
					<u>SILTY CLAY</u> very stiff, tan and orange with organics	CL-ML						
2.5			2	16	<u>LEAN CLAY</u> , with sand very stiff, gray, red and tan	CL						18
			3	18	<u>SANDY LEAN CLAY</u> , with gravel very stiff, orangish brown and red with sandstone fragments	CL						21
5			4	16	<u>SANDY LEAN CLAY</u> , with trace gravel very stiff, brown, tan and red with rootlets and sandstone fragments	CL						30
7.5			5	18	<u>SANDY LEAN CLAY</u> , with gravel very stiff, orange, brown and light gray with chert and sandstone fragments							48
10			6	18		CL						47
12.5			7	18								50
					BOTTOM OF BORING AT 13½ FEET							
15												
17.5												

COMPLETION DEPTH: 13.5 ft.

DATE: 5/14/2012

RIG: Diedrich D-50

DEPTH TO WATER: DURING DRILLING: DRY

AT COMPLETION: DRY

AT 24 HOURS: N/A



LOG OF BORING NO. B-2

Proposed Pond and Building Pads
Mt. Judea, Arkansas



Fayetteville, AR

Project No.: 12-15049

Location: Shown on Boring Location Diagram

DEPTH, FT	SYMBOL	SAMPLES	SAMPLE No.	RECOVERY (in.)	DESCRIPTION OF MATERIAL	USCS	%<#200	HAND PENETROMETER, TSF ■				BLOWS PER FT	
								LAB. COHESION, TSF ▲					
					Surface Description=Grass Cover Rootmat = 2"			0.4	0.8	1.2	1.6		
								WATER CONTENT, % ●					
								PL ----- LL					
								20	40	60	80		
0			1	13	<u>SILT</u> , with sand medium dense, brown with organics	SM							25
2.5			2	15	<u>CLAYEY GRAVEL</u> , with sand dense, red and tan with chert fragments	GC							30
			3	18	<u>CLAYEY SAND / SANDY LEAN CLAY</u> dense, very stiff, red and tan with extremely weathered sandstone fragments and chert fragments	CL							30
5			4	18		SC							26
7.5			5	18	<u>FAT CLAY</u> , with sand very stiff, light gray, red and orangish tan	CH							22
10			6	17	<u>SANDY FAT CLAY</u> very stiff, light gray, red and orangish tan	CH							25
12.5			7	15	<u>GRAVELLY FAT CLAY</u> very stiff, light gray, red and orangish tan with chert fragments	CH							65
15			8	18	<u>FAT CLAY</u> , with gravel very stiff, light gray and tan with chert fragments	CH							34
17.5					<u>FAT CLAY</u> very stiff, tan with ferrous nodules	CH							

COMPLETION DEPTH: 18.5 ft.

DATE: 5/15/2012

RIG: Diedrich D-50

DEPTH TO WATER: DURING DRILLING: DRY

AT COMPLETION: DRY

AT 24 HOURS: N/A



LOG OF BORING NO.B-2

Proposed Pond and Building Pads
Mt. Judea, Arkansas



Fayetteville, AR

Project No.: 12-15049

Location: Shown on Boring Location Diagram

DEPTH, FT	SYMBOL	SAMPLES	SAMPLE No.	RECOVERY (in.)	DESCRIPTION OF MATERIAL	USCS	% <#200	HAND PENETROMETER, TSF ■				BLOWS PER FT
								LAB. COHESION, TSF ▲				
			9	18				0.4	0.8	1.2	1.6	20
					BOTTOM OF BORING AT 18½ FEET			WATER CONTENT, % ●				
								PL ————— LL				
								20	40	60	80	
20												
22.5												
25												
27.5												
30												
32.5												
35												

LOG OF BORING NO.B-3

Proposed Pond and Building Pads
Mt. Judea, Arkansas



Fayetteville, AR

Project No.: 12-15049

Location: Shown on Boring Location Diagram

DEPTH, FT	SYMBOL	SAMPLES	SAMPLE No.	RECOVERY (in.)	DESCRIPTION OF MATERIAL	USCS	%<#200	HAND PENETROMETER, TSF ■				BLOWS PER FT
								LAB. COHESION, TSF ▲				
					Surface Description=Grass Cover Rootmat = 4"			0.4	0.8	1.2	1.6	
								WATER CONTENT, % ●				
								PL	LL			
								20	40	60	80	
0			1	10	<u>SILT</u> , with sand and trace gravel medium dense, orangish brown with organics and chert fragments	ML						13
2.5			2	18	<u>CLAYEY SAND</u> , with gravel medium dense, orangish tan and brown with chert fragments	SC						29
			3	16	<u>CLAYEY GRAVEL</u> , with sand dense, red and brown with sandstone and chert fragments	GC						38
5			4	16	<u>CHERT SEAM</u> = 6"							72
7.5			5	18	<u>FAT CLAY</u> , with sand very stiff, light gray, brown and orangish tan, blocky	CH						24
10			6	11	<u>CLAYEY GRAVEL</u> , with sand very dense, brown and tan with chert fragments	GC						50/5"
12.5					AUGER REFUSAL AT 11½ FEET							
15												
17.5												

COMPLETION DEPTH: 11.5 ft.

DATE: 5/14/2012

RIG: Diedrich D-50

DEPTH TO WATER: DURING DRILLING: DRY

AT COMPLETION: DRY

AT 24 HOURS: N/A



GTS, Inc.

Geotechnical & Testing Services

1915 N. Shiloh Dr, Suite 1
Fayetteville, Arkansas 72704

Office: (479) 521-7645
Fax: (479) 521-6232

Office Locations

Fayetteville, Arkansas
Van Buren, Arkansas
Tulsa, Oklahoma

PROJECT Proposed Pond and Building Pads

JOB NO. 12-15049 **DATE** 5/22/2012

	BORING NO.	SIEVE SIZE	PERCENT PASSING
	B-2		
		3.00"	N/A
		1.50"	N/A
		1.00"	N/A
		3/4"	N/A
		3/8"	N/A
		No. 4	N/A
		No. 10	N/A
		No. 40	N/A
		No. 200	N/A

VISUAL CLASSIFICATION Red and Tan Clayey Sand / Sandy Lean Clay with Extremely Weathered Sandstone Fragments and Chert

ASTM DESCRIPTION	AASHTO CLASSIFICATION	AASHTO GI
N/A	N/A	N/A

GRAIN SIZE DISTRIBUTION CURVE

U.S. STANDARD SIEVE OPENINGS IN INCHES & STANDARD SIEVE NUMBERS

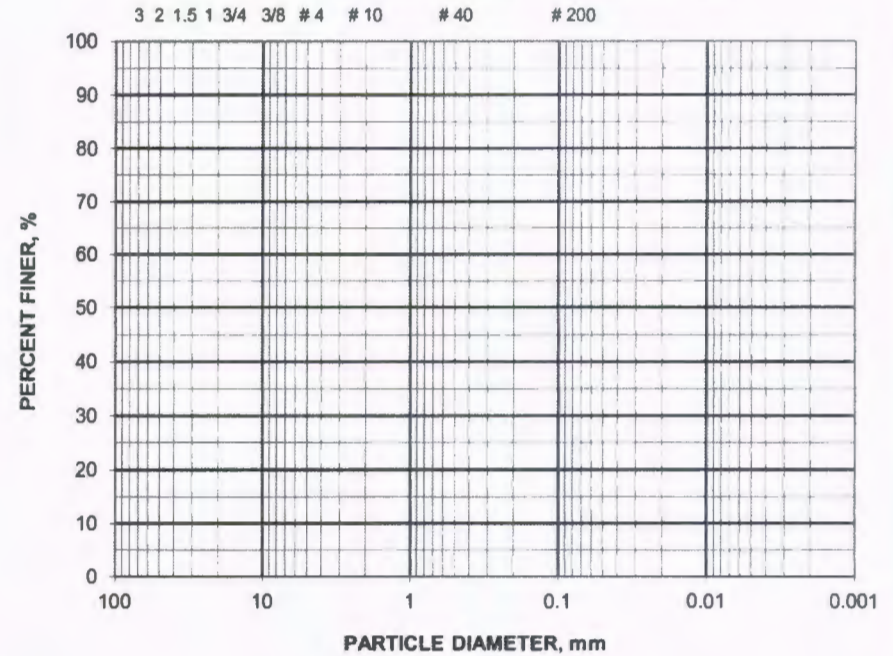

PLASTICITY CHART

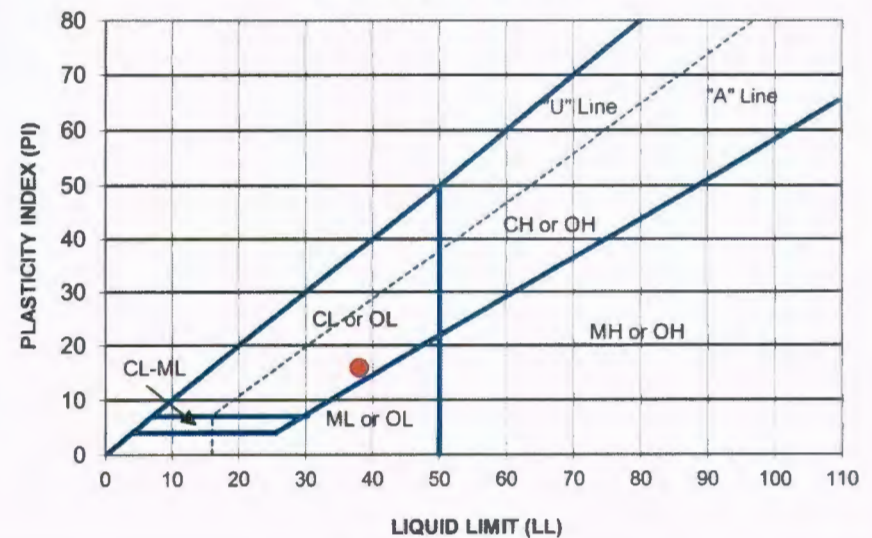

GTS, Inc.

Geotechnical & Testing Services

1915 N. Shiloh Dr, Suite 1
Fayetteville, Arkansas 72704

Office: (479) 521-7645
Fax: (479) 521-6232

Office Locations

Fayetteville, Arkansas
Van Buren, Arkansas
Tulsa, Oklahoma

PROJECT Proposed Pond and Building Pads

JOB NO. 12-15049 **DATE** 5/22/2012

BORING NO.	B-2	SIEVE SIZE	PERCENT PASSING
SAMPLE NO.	S-4	3.00"	N/A
		1.50"	N/A
DEPTH (FT)	4.5-6	1.00"	N/A
		3/4"	N/A
PLASTIC LIMIT	24	3/8"	N/A
		No. 4	N/A
LIQUID LIMIT	44	No. 10	N/A
		No. 40	N/A
PLASTICITY INDEX	20	No. 200	N/A
VISUAL CLASSIFICATION	Red and Tan Clayey Sand / Sandy Lean Clay with Extremely Weathered Sandstone Fragments and Chert		

ASTM DESCRIPTION	AASHTO CLASSIFICATION	AASHTO GI
N/A	N/A	N/A

GRAIN SIZE DISTRIBUTION CURVE

U.S. STANDARD SIEVE OPENINGS IN INCHES & STANDARD SIEVE NUMBERS

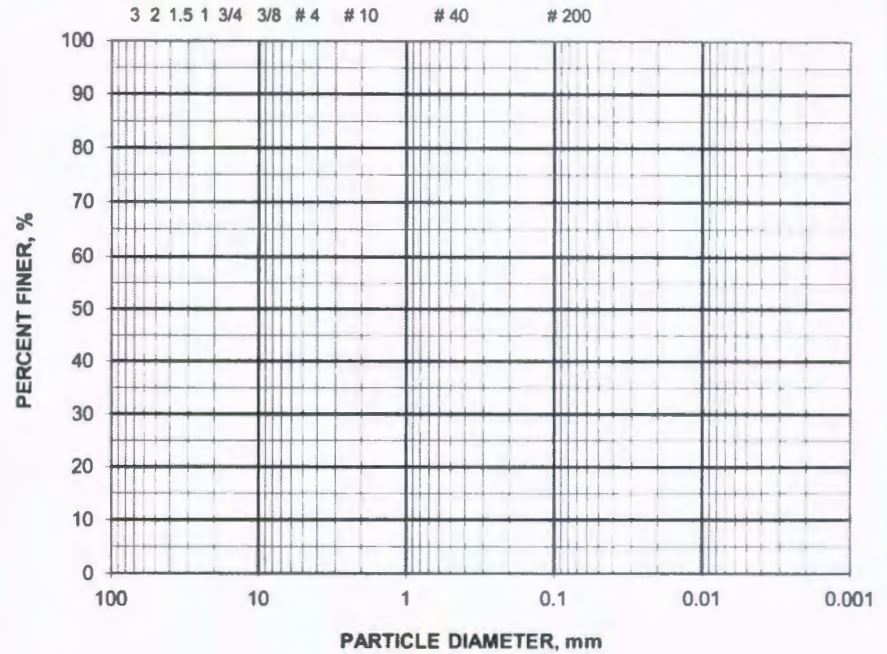

PLASTICITY CHART

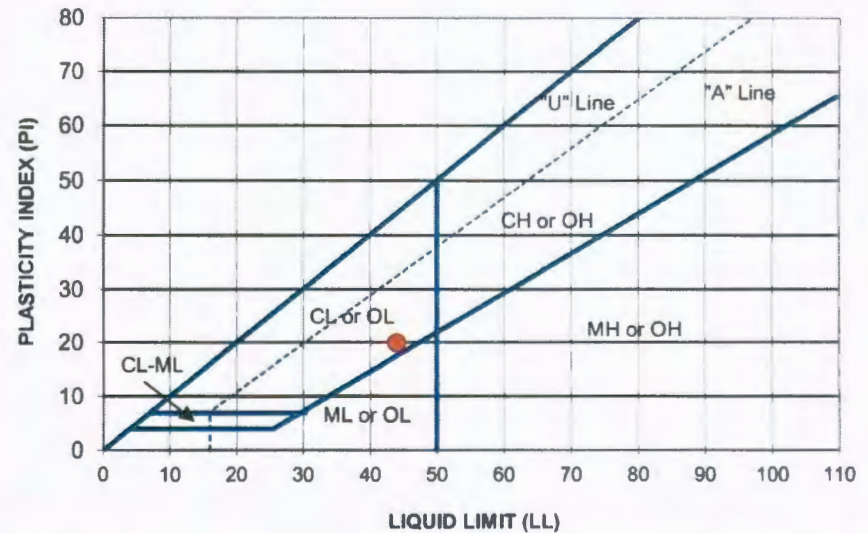

GTS, Inc.

Geotechnical & Testing Services

1915 N. Shiloh Dr. Suite 1
Fayetteville, Arkansas 72704Office: (479) 521-7645
Fax: (479) 521-6232**Office Locations**Fayetteville, Arkansas
Van Buren, Arkansas
Tulsa, Oklahoma**PROJECT** Proposed Pond and Building Pads**JOB NO.** 12-15049 **DATE** 5/22/2012**BORING NO.**

B-2

SIEVE SIZE**PERCENT PASSING****SAMPLE NO.**

S-5

3.00"

N/A

1.50"

N/A

DEPTH (FT)

7-8.5

1.00"

N/A

3/4"

N/A

PLASTIC LIMIT

38

3/8"

N/A

No. 4

N/A

LIQUID LIMIT

93

No. 10

N/A

No. 40

N/A

PLASTICITY INDEX

55

No. 200

N/A

VISUAL CLASSIFICATION

Light Gray, Red and Orangish Tan Fat Clay with Sand

ASTM DESCRIPTION

N/A

AASHTO CLASSIFICATION

N/A

AASHTO GI

N/A

GRAIN SIZE DISTRIBUTION CURVE

U.S. STANDARD SIEVE OPENINGS IN INCHES & STANDARD SIEVE NUMBERS

3 2 1.5 1 3/4 3/8 # 4 # 10 # 40 # 200

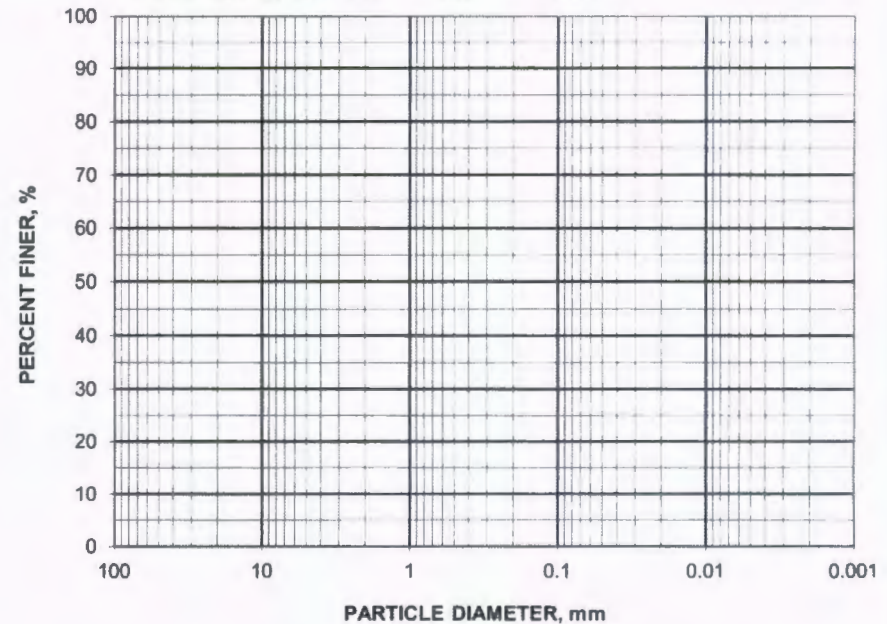
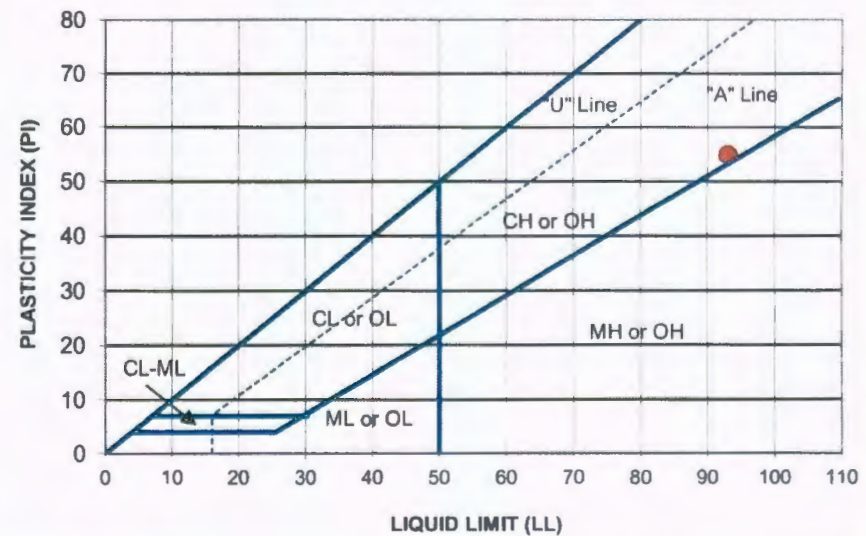
**PLASTICITY CHART**

GTS, Inc.

Geotechnical & Testing Services

1915 N. Shiloh Dr. Suite 1
Fayetteville, Arkansas 72704

Office: (479) 521-7645
Fax: (479) 521-6232

Office Locations

Fayetteville, Arkansas
Van Buren, Arkansas
Tulsa, Oklahoma

PROJECT Proposed Pond and Building Pads

JOB NO. 12-15049 DATE 5/22/2012

BORING NO.

B-2

SAMPLE NO.

S-6

DEPTH (FT)

9.5-11

PLASTIC LIMIT

23

LIQUID LIMIT

64

PLASTICITY INDEX

41

SIEVE SIZE

3.00"

1.50"

1.00"

3/4"

3/8"

No. 4

No. 10

No. 40

No. 200

PERCENT PASSING

N/A

N/A

N/A

N/A

N/A

N/A

N/A

N/A

N/A

VISUAL CLASSIFICATION

Light Gray, Red and Orangish Tan Sandy Fat Clay

ASTM DESCRIPTION

N/A

AASHTO CLASSIFICATION

N/A

AASHTO GI

N/A

GRAIN SIZE DISTRIBUTION CURVE

U.S. STANDARD SIEVE OPENINGS IN INCHES & STANDARD SIEVE NUMBERS

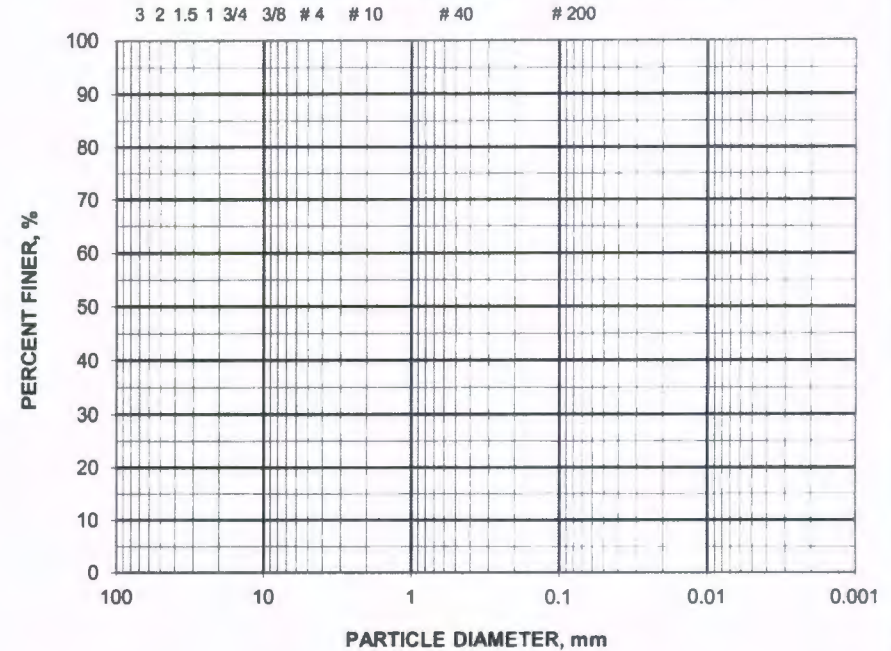

PLASTICITY CHART

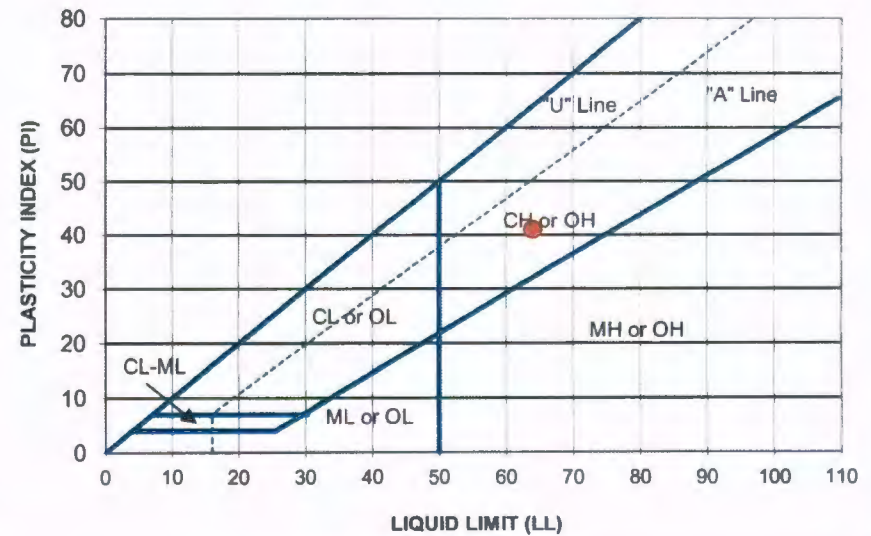

GTS, Inc.

Geotechnical & Testing Services

1915 N. Shiloh Dr, Suite 1
Fayetteville, Arkansas 72704

Office (479) 521-7645
Fax (479) 521-6232

Office Locations

Fayetteville, Arkansas
Van Buren, Arkansas
Tulsa, Oklahoma

PROJECT Proposed Pond and Building Pads

JOB NO. 12-15049 DATE 5/22/2012

BORING NO.

B-3

SAMPLE NO.

S-5

DEPTH (FT)

7-8.5

PLASTIC LIMIT

36

LIQUID LIMIT

58

PLASTICITY INDEX

22

SIEVE SIZE

3.00"

1.50"

1.00"

3/4"

3/8"

No. 4

No. 10

No. 40

No. 200

PERCENT PASSING

N/A

N/A

N/A

N/A

N/A

N/A

N/A

N/A

N/A

VISUAL CLASSIFICATION

Light Gray, Brown and Orangish Tan, Blocky, Fat Clay with Sand

ASTM DESCRIPTION

N/A

AASHTO CLASSIFICATION

N/A

AASHTO GI

N/A

GRAIN SIZE DISTRIBUTION CURVE

U.S. STANDARD SIEVE OPENINGS IN INCHES & STANDARD SIEVE NUMBERS

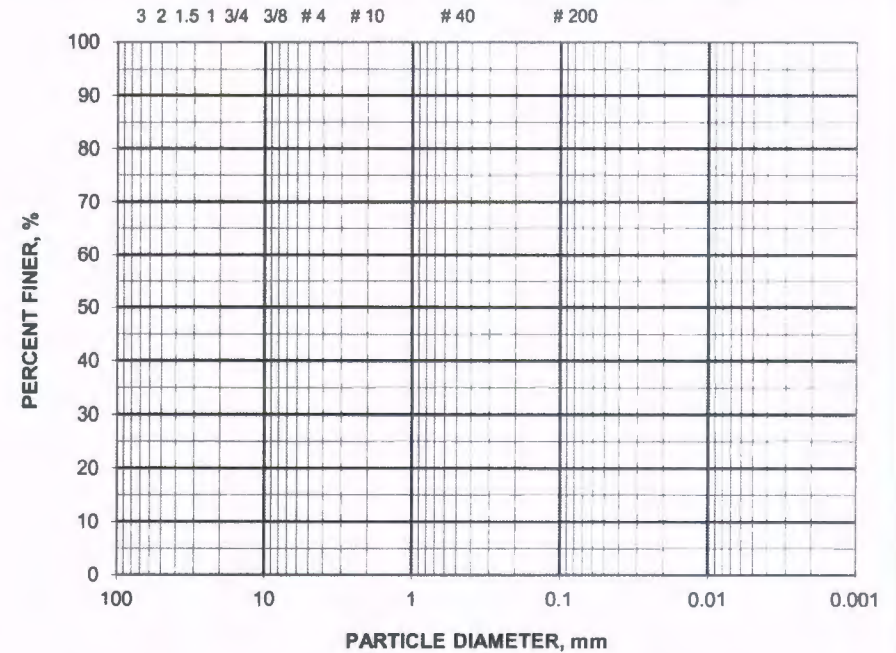

PLASTICITY CHART

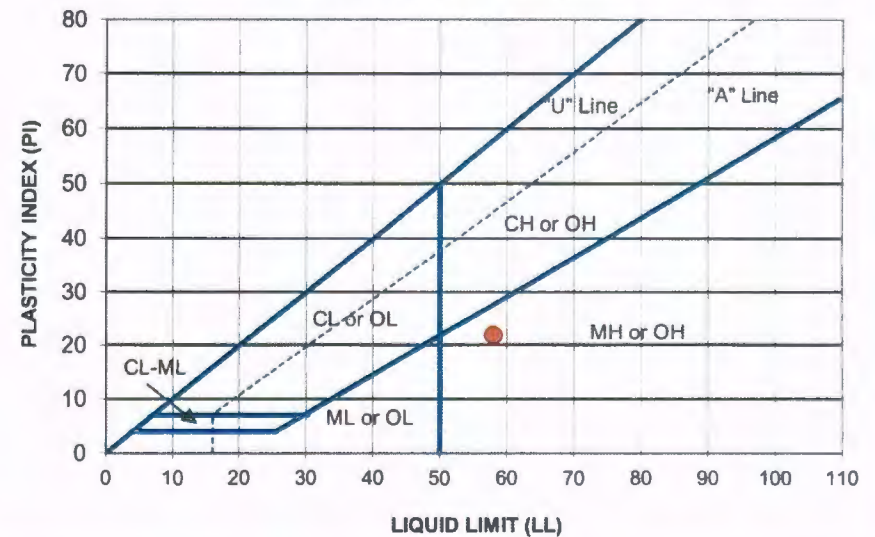

GTS, Inc.

Geotechnical & Testing Services

1915 N. Shiloh Dr, Suite 1
Fayetteville, Arkansas 72704

Office (479) 521-7645
Fax (479) 521-6232

Office Locations

Fayetteville, Arkansas
Van Buren, Arkansas
Tulsa, Oklahoma

PROJECT Proposed Pond and Building Pads

JOB NO. 12-15049 **DATE** 5/22/2012

BORING NO.	B-3		
		SIEVE SIZE	PERCENT PASSING
SAMPLE NO.	S-6	3.00"	N/A
		1.50"	N/A
DEPTH (FT)	9.5-11	1.00"	N/A
		3/4"	N/A
PLASTIC LIMIT	44	3/8"	N/A
		No. 4	N/A
LIQUID LIMIT	81	No. 10	N/A
		No. 40	N/A
PLASTICITY INDEX	37	No. 200	N/A

VISUAL CLASSIFICATION Brown and Tan Clayey Gravel with Sand and Chert Fragments

ASTM DESCRIPTION	AASHTO CLASSIFICATION	AASHTO GI
N/A	N/A	N/A

GRAIN SIZE DISTRIBUTION CURVE

U.S. STANDARD SIEVE OPENINGS IN INCHES & STANDARD SIEVE NUMBERS

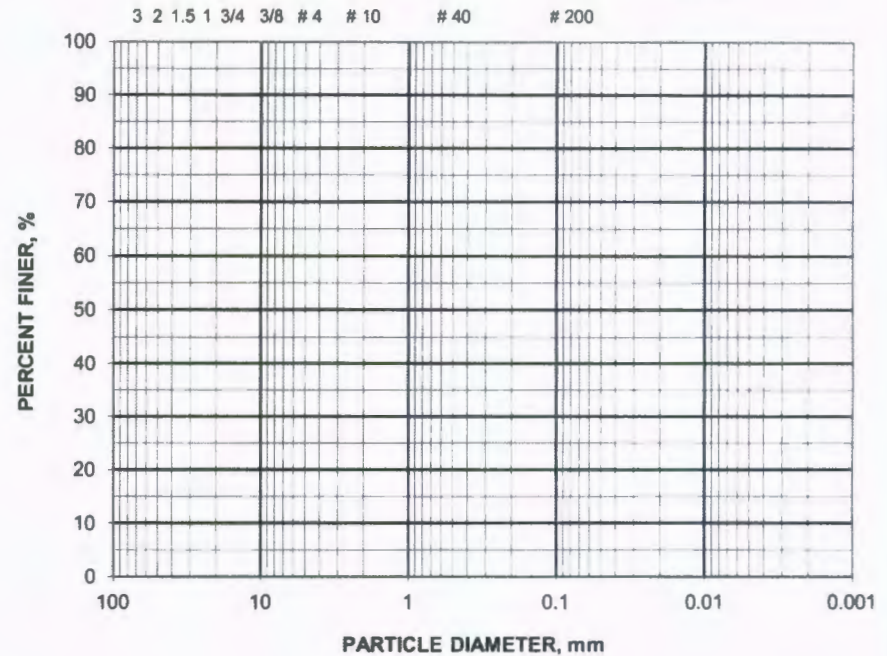

PLASTICITY CHART

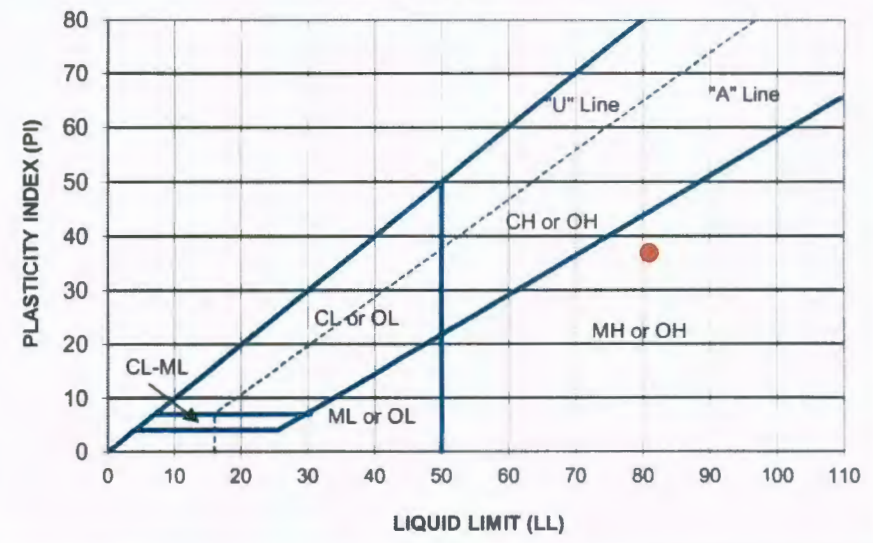

Section E: Facility Plans

C & H HOG FARMS GESTATION-FARROWING FARM

ENGINEERING PLAN SHEETS

SECTION 26, T 15 N, R 20 W
NEWTON COUNTY, ARKANSAS

DATE: JUNE 1, 2012

SHEET INDEX

SHEET 1	–	USGS SITE LOCATION MAP
SHEET 2	–	EXISTING SITE PLAN
SHEET 3	–	PROPOSED SITE PLAN
SHEET 4	–	DETAILED PROPOSED SITE PLAN
SHEET 5	–	PROPOSED SITE PLAN SUBGRADE DESIGN
SHEET 6	–	PROPOSED SITE PLAN FINAL DESIGN
SHEET 7	–	WASTE STORAGE POND FINAL DESIGN
SHEET 8	–	PROPOSED SITE PLAN CROSS SECTION
SHEET 9	–	BARN CROSS SECTIONS
SHEET 10	–	WASTE STORAGE POND & BARN CROSS SECTIONS
SHEET 11	–	WASTE STORAGE POND CROSS SECTIONS
SHEET 12	–	DIVERSION & LOADOUT CROSS SECTIONS & PROFILES
SHEET 13	–	POND INLET & MAXIMUM BERM DETAILS
SHEET 14	–	WASTE STORAGE POND 1 STAGE STORAGE TABLE
SHEET 15	–	WASTE STORAGE POND 2 STAGE STORAGE TABLE
SHEET 16	–	PIPE CLEANOUT LOCATIONS & DETAILS
SHEET 17	–	CLEANOUT & STANDARD BEDDING DETAIL
SHEET 18	–	SPILLWAY/SPLASHPAD PLAN VIEW & DETAIL
SHEET 19	–	GESTATION – FARROWING BUILDING PLAN VIEW
SHEET 20	–	GESTATION BUILDING PLAN VIEW
SHEET 21	–	GESTATION BUILDING CROSS SECTION
SHEET 22	–	FARROWING BUILDING PLAN VIEW
SHEET 23	–	FARROWING BUILDING CROSS SECTIONS 1
SHEET 24	–	FARROWING BUILDING CROSS SECTIONS 2
SHEET 25	–	TABLE OF QUANTITIES

GENERAL NOTES

No.	Revision/Issue	Date

**DeHaan, Grabs
& Associates, LLC**
Consulting Engineers
PO Box 522, Mandan, ND 58554
(701) 663-1116, FAX: (701) 667-1356
www.dgaengineering.com

**C & H HOG FARMS
GESTATION-FARROWING FARM**

SECTION 26, T 15 N, R 20 W
NEWTON COUNTY, AR

COVER SHEET

DATE: JUN 1, 2012	SHEET: COVER
SCALE: NONE	
DRAWN BY: NAP	
CHECKED BY: DLD	

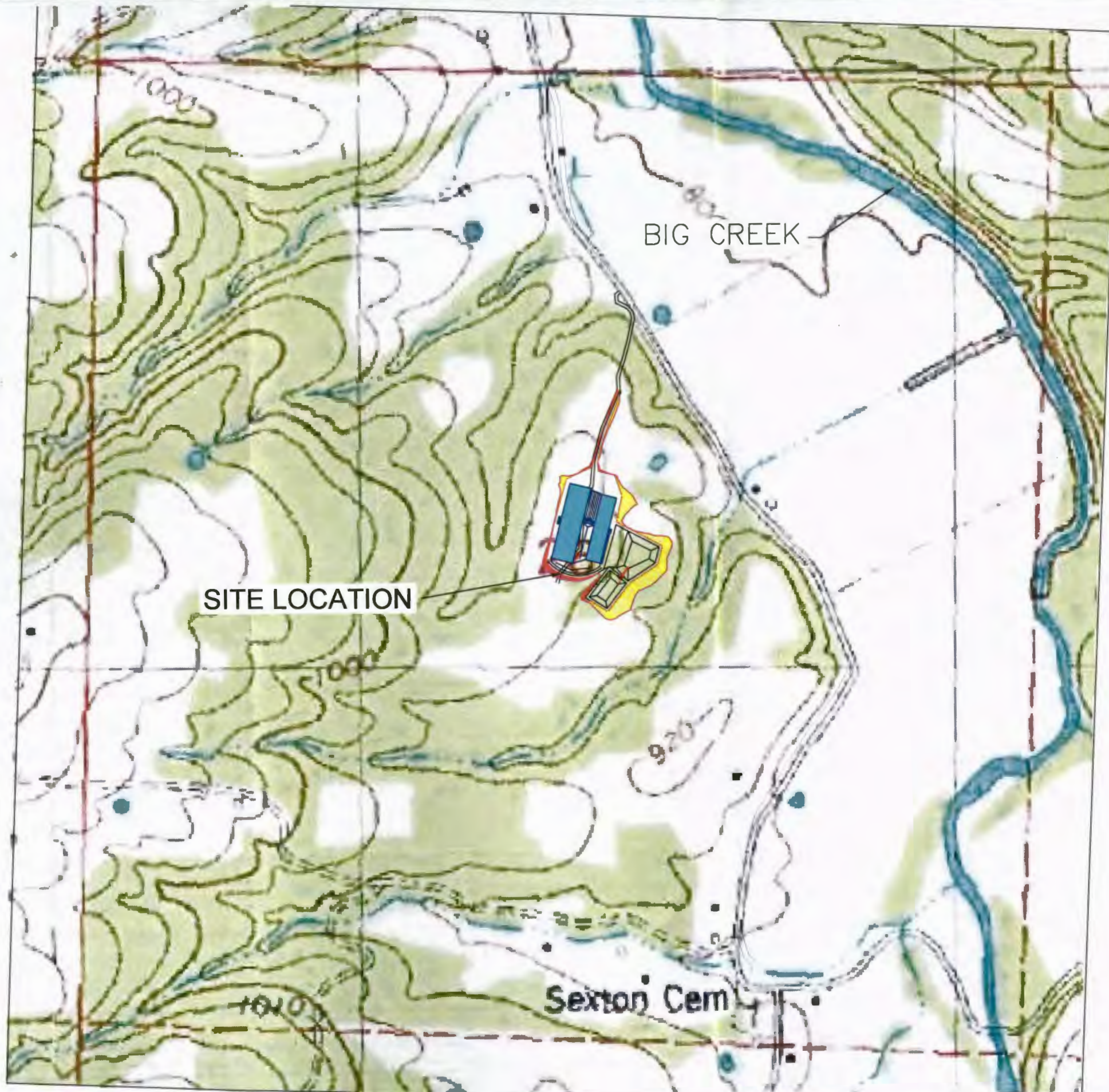

GENERAL NOTES

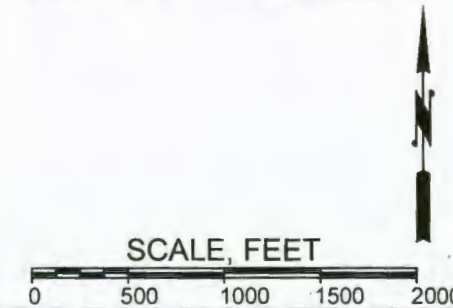

No.	Revision/Issue	Date

DeHaan, Grabs & Associates, LLC
 Consulting Engineers
 PO Box 522, Mandan, ND 58554
 (701) 663-1116, FAX: (701) 667-1356
 www.dgaengineering.com

C&H HOG FARMS
 GESTATION-FARROWING FARM

SECTION 26, T 15 N, R 20 W
 NEWTON COUNTY, AR

USGS MAP

DATE: MAY 22, 2012	SHEET: 1
SCALE: 1" = 1000'	
DRAWN BY: CAS	
CHECKED BY: DLD	



COUNTY ROAD 41

LOGGING ROAD

DRAW

APPROXIMATE MIDDLE OF SECTION 26

APPROXIMATE PROPERTY BOUNDARY

DRAW



Benchmarks			
TBM #	Northing	Easting	Elevation
1	580,264.50	994,267.97	925.68
2	580,715.06	994,563.20	915.64
3	580,375.60	994,600.08	914.71
4	580,090.02	994,770.77	889.80

GENERAL NOTES

LEGEND

- ◆ BENCHMARK
- ▭ BUILDINGS
- - - FENCELINE
- - - CULVERT/PIPE
- ← DRAINAGE ARROW

SCALE, FEET

No.	Revision/Issue	Date

DeHaan, Grabs & Associates, LLC
 Consulting Engineers
 PO Box 522, Mandan, ND 58854
 (701) 663-1116, FAX: (701) 667-1356
 www.dgaengineering.com

C & H HOG FARMS
 GESTATION-FARROWING FARM

SECTION 26, T 15 N, R 20 W
 NEWTON COUNTY, AR

EXISTING SITE PLAN

DATE: APR 30, 2012	SHEET: 2
SCALE: 1" = 200'	
DRAWN BY: NAP	
CHECKED BY: DLD	



Benchmarks				
TBM #	Northing,	Easting	Elevation	Description
1	580,264.50	994,267.97	925.68	Elevation
2	580,715.06	994,563.20	915.64	Elevation
3	580,375.60	994,600.08	914.71	Elevation
4	580,090.02	994,770.77	889.80	Elevation



GENERAL NOTES

LEGEND

- ◆ BENCHMARK
- BUILDINGS
- - - FENCELINE
- - - CULVERT/PIPE
- ← DRAINAGE ARROW

SCALE, FEET

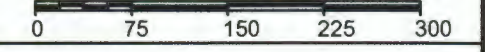

No.	Revision/Issue	Date

DeHaan, Grabs & Associates, LLC
 Consulting Engineers
 PO Box 522, Mandan, ND 58554
 (701) 663-1116, FAX: (701) 667-1356
 www.dgoengineering.com

**C & H HOG FARMS
 GESTATION-FARROWING FARM**

SECTION 26, T 15 N, R 20 W
 NEWTON COUNTY, AR

PROPOSED SITE PLAN

DATE: APR 30, 2012	3
SCALE: 1" = 150'	
DRAWN BY: NAP	
CHECKED BY: DLD	

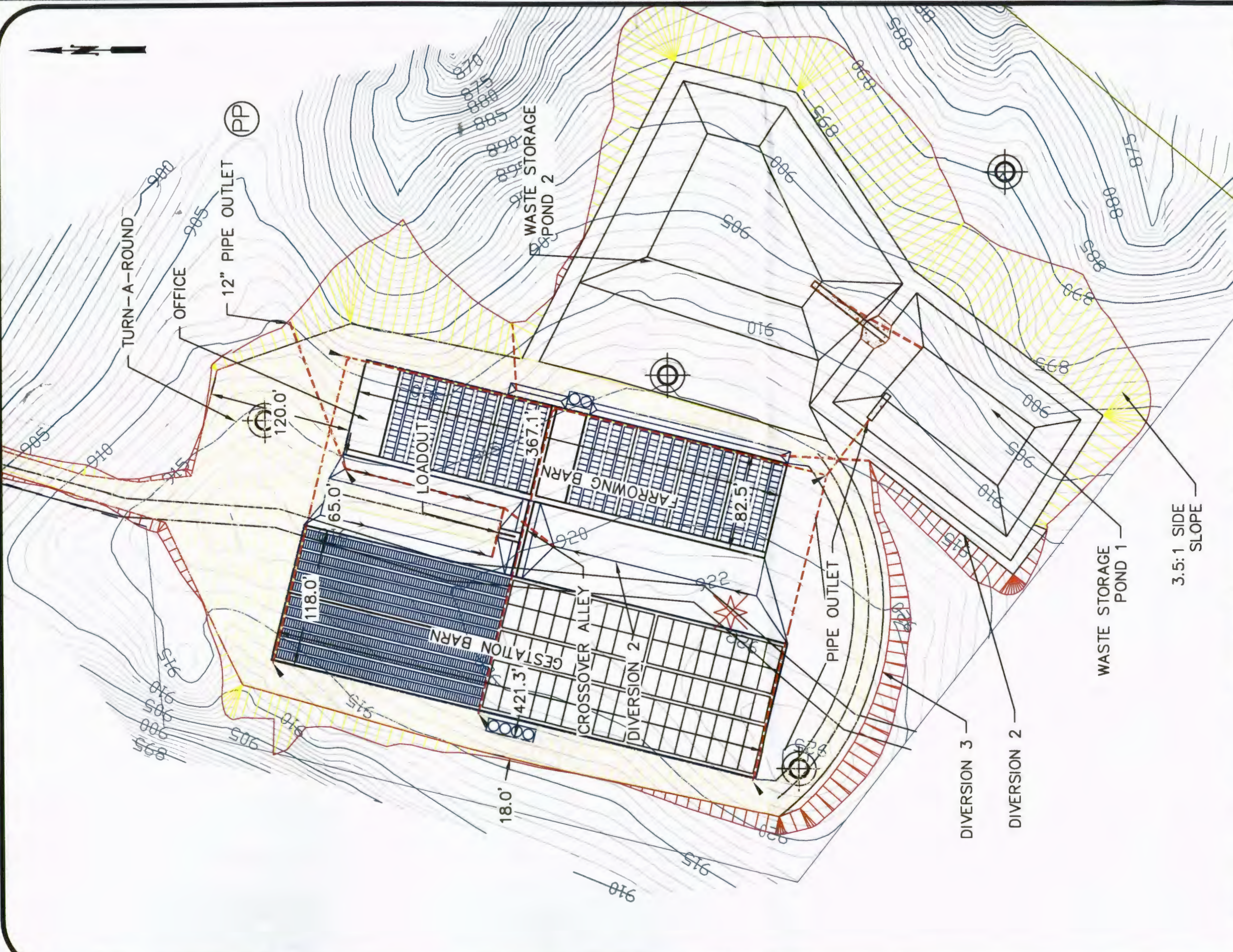

GENERAL NOTES

LEGEND

- ◆ BENCHMARK
- ▭ BUILDINGS
- - - FENCELINE
- - - CULVERT/PIPE
- ← DRAINAGE ARROW

SCALE, FEET

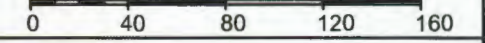

No.	Revision/Issue	Date

DeHaan, Grabs & Associates, LLC
 Consulting Engineers
 PO Box 522, Mandan, ND 58554
 (701) 663-1116, FAX: (701) 667-1356
 www.dgaengineering.com

C & H HOG FARMS
GESTATION-FARROWING FARM

SECTION 26, T 15 N, R 20 W
 NEWTON COUNTY, AR

DETAILED PROPOSED SITE PLAN

DATE: APR 30, 2012	SHEET: 4
SCALE: 1" = 80'	
DRAWN BY: NAP	
CHECKED BY: DLD	

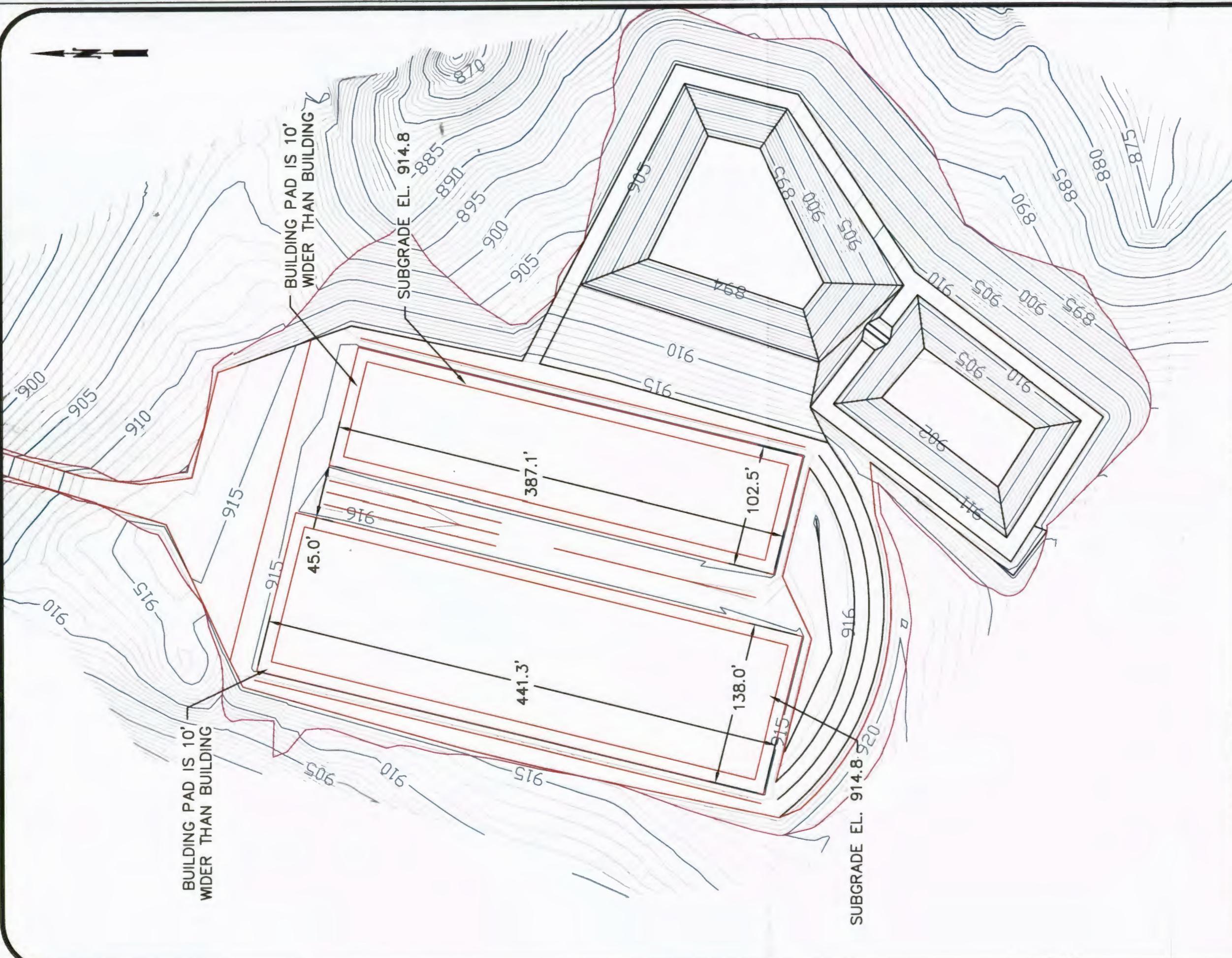

GENERAL NOTES

LEGEND

- ◆ BENCHMARK
- ▭ BUILDINGS
- - - FENCELINE
- - - CULVERT/PIPE
- ← DRAINAGE ARROW

SCALE, FEET

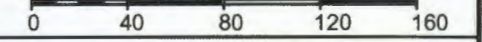

No.	Revision/Issue	Date

DeHaan, Grabs & Associates, LLC
 Consulting Engineers
 PO Box 522, Mandan, ND 58554
 (701) 663-1116, FAX: (701) 667-1366
 www.dgoengineering.com

C & H HOG FARMS
 GESTATION-FARROWING FARM

SECTION 26, T 15 N, R 20 W
 NEWTON COUNTY, AR

PROPOSED SITE PLAN
SUBGRADE DESIGN

DATE: APR 30, 2012	SHEET: 5
SCALE: 1" = 80'	
DRAWN BY: NAP	
CHECKED BY: DLD	

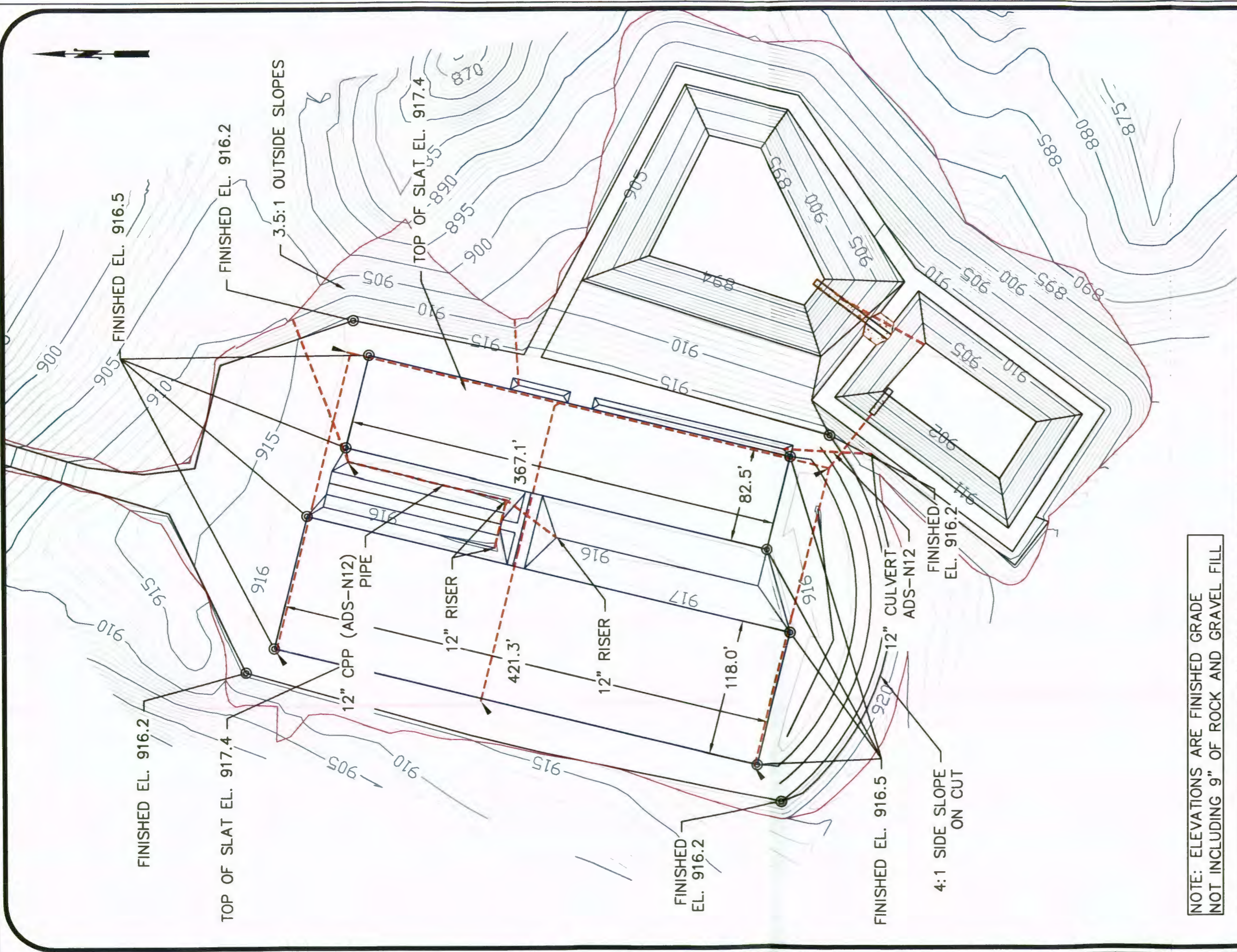

GENERAL NOTES

LEGEND

- BENCHMARK
- ▭ BUILDINGS
- - - FENCELINE
- - - CULVERT/PIPE
- ← DRAINAGE ARROW

SCALE, FEET

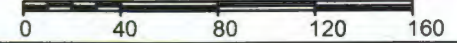

No.	Revision/Issue	Date

DeHaan, Grabs & Associates, LLC
 Consulting Engineers
 PO Box 522, Mandan, ND 58554
 (701) 663-1116, FAX: (701) 667-1356
 www.dgaengineering.com

C & H HOG FARMS
 GESTATION-FARROWING FARM

SECTION 26, T 18 N, R 20 W
 NEWTON COUNTY, AR

PROPOSED SITE PLAN
FINAL DESIGN

DATE: APR 30, 2012	6
SCALE: 1" = 80'	
DRAWN BY: NAP	
CHECKED BY: DLD	

NOTE: ELEVATIONS ARE FINISHED GRADE
 NOT INCLUDING 9" OF ROCK AND GRAVEL FILL

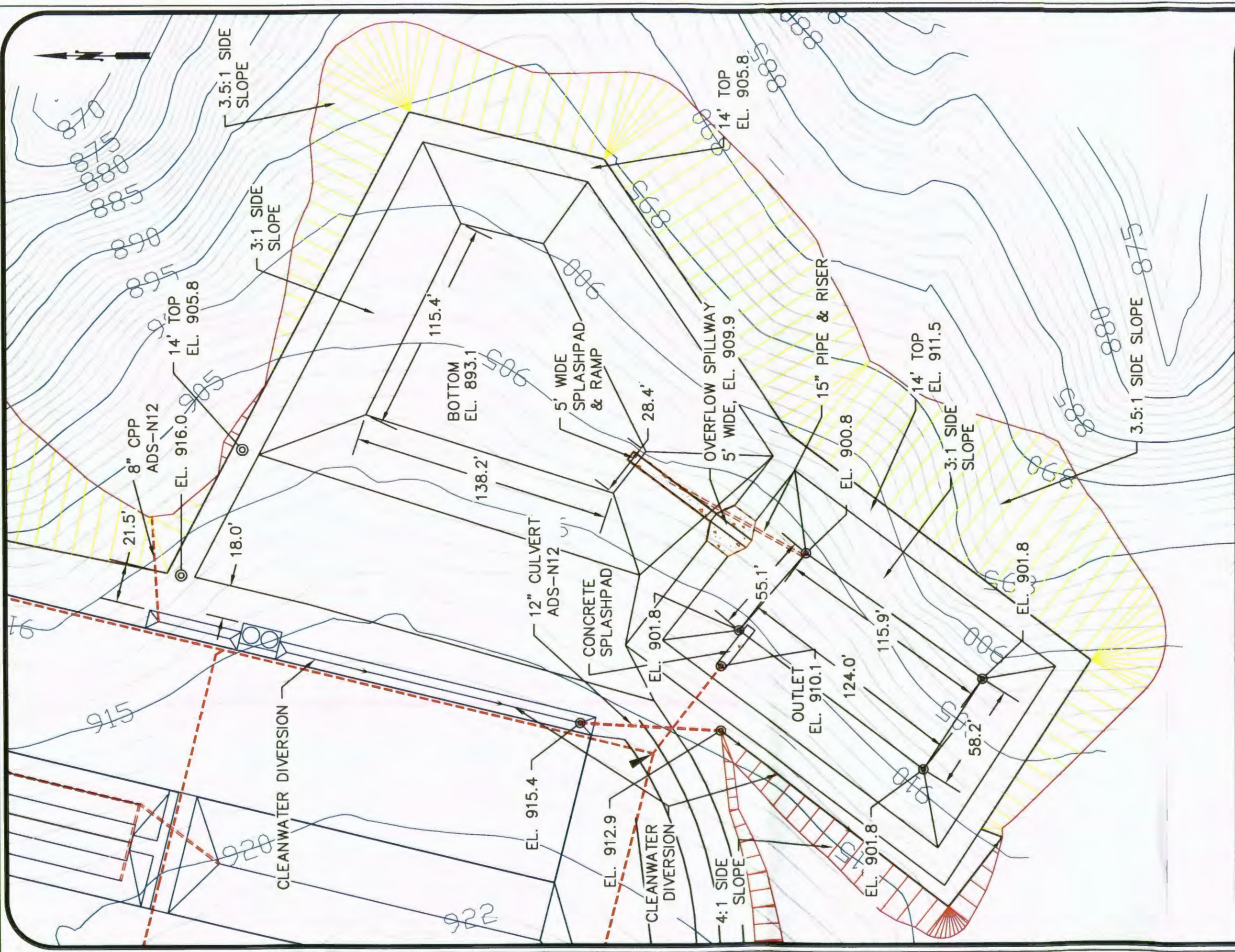

GENERAL NOTES

LEGEND

- ◆ BENCHMARK
- ▭ BUILDINGS
- - - FENCELINE
- - - CULVERT/PIPE
- ← DRAINAGE ARROW

SCALE, FEET

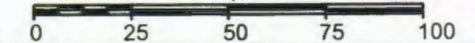

No.	Revision/Issue	Date

DeHaan, Grabs & Associates, LLC
 Consulting Engineers
 PO Box 522, Mandan, ND 58554
 (701) 663-1116, FAX: (701) 667-1356
 www.dgoengineering.com

C & H HOG FARMS
 GESTATION-FARROWING FARM

SECTION 26, T 15 N, R 20 W
 NEWTON COUNTY, AR

WASTE STORAGE POND
 FINAL DESIGN

DATE: APR 30, 2012	SHEET: 7
SCALE: 1" = 50'	
DRAWN BY: NAP	
CHECKED BY: DLD	

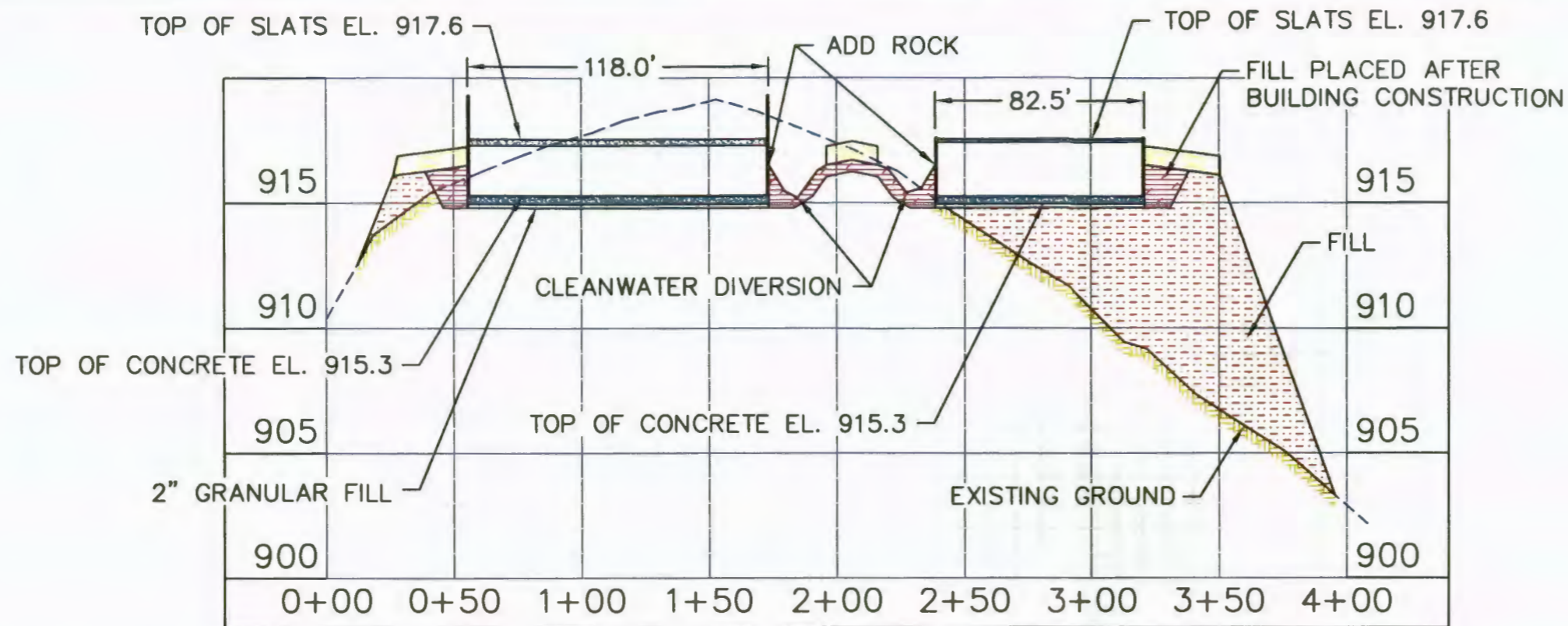

SCALE:
 VERTICAL: 1"=6'
 HORIZONTAL: 1"=60'

$\frac{A-A}{8}$ BARN CROSS SECTION

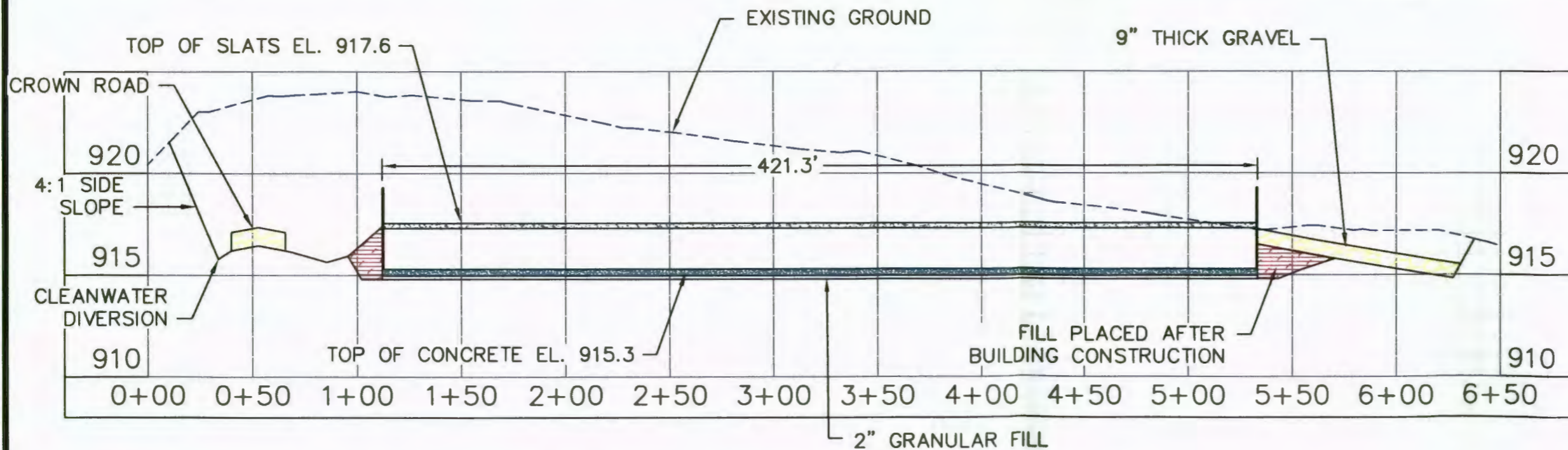
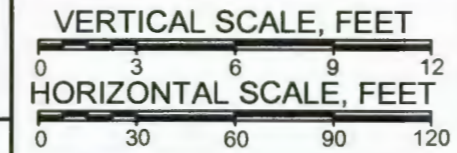

$\frac{B-B}{8}$ BARN CROSS SECTION

GENERAL NOTES

- GRAVEL
- FILL
- CONCRETE
- STRIPPING
- EXISTING GROUND

No.	Revision/Issue	Date

DeHaan, Grabs & Associates, LLC
 Consulting Engineers
 PO Box 522, Mandan, ND 58554
 (701) 663-1116, FAX: (701) 667-1356
 www.dgaengineering.com

C & H HOG FARMS
 GESTATION-FARROWING FARM

SECTION 26, T 15 N, R 20 W
 NEWTON COUNTY, AR

BARN CROSS SECTIONS

DATE: APR 30, 2012	SHEET: 9
SCALE: AS SHOWN	
DRAWN BY: NAP	
CHECKED BY: DLD	

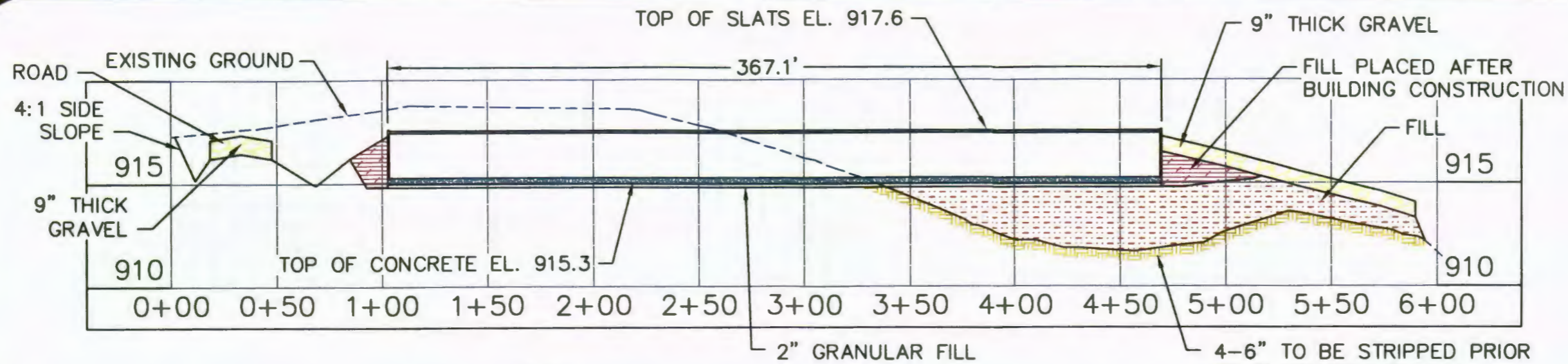

C-C
8 BARN CROSS SECTION

SCALE:
VERTICAL: 1"=6'
HORIZONTAL: 1"=60'

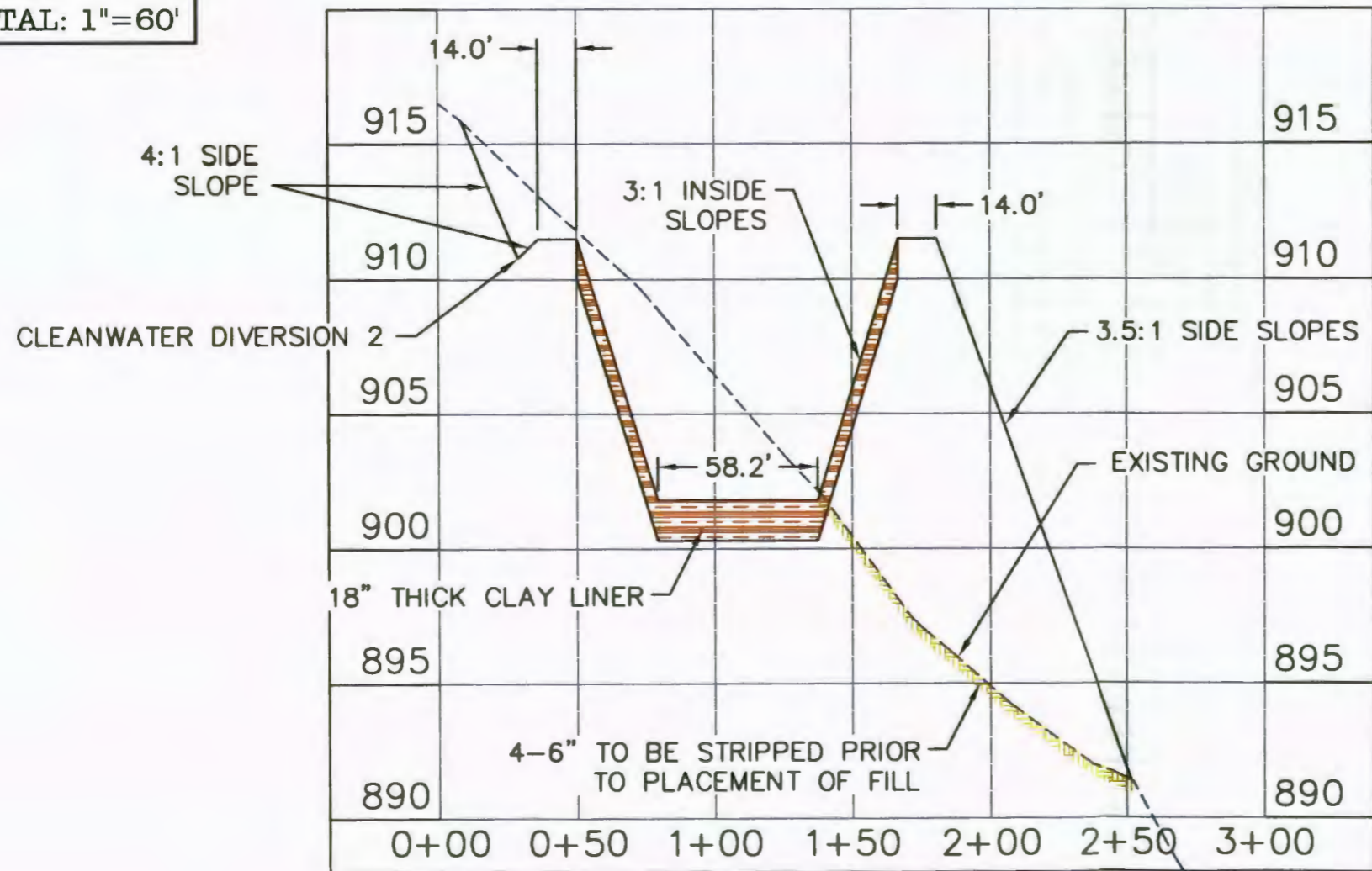
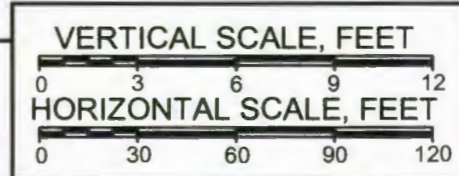

D-D
8 WASTE STORAGE POND 1 CROSS SECTION

GENERAL NOTES

- GRAVEL
- FILL
- CONCRETE
- STRIPPING
- EXISTING GROUND

No.	Revision/Issue	Date

DeHaan, Grabs & Associates, LLC
Consulting Engineers
PO Box 522, Mandan, ND 58554
(701) 663-1116, FAX: (701) 667-1356
www.dgaengineering.com

C & H HOG FARMS
GESTATION-FARROWING FARM

SECTION 26, T 15 N, R 20 W
NEWTON COUNTY, AR

WASTE STORAGE POND
& BARN CROSS SECTIONS

DATE: APR 30, 2012	SHEET: 10
SCALE: AS SHOWN	
DRAWN BY: NAP	
CHECKED BY: DLD	

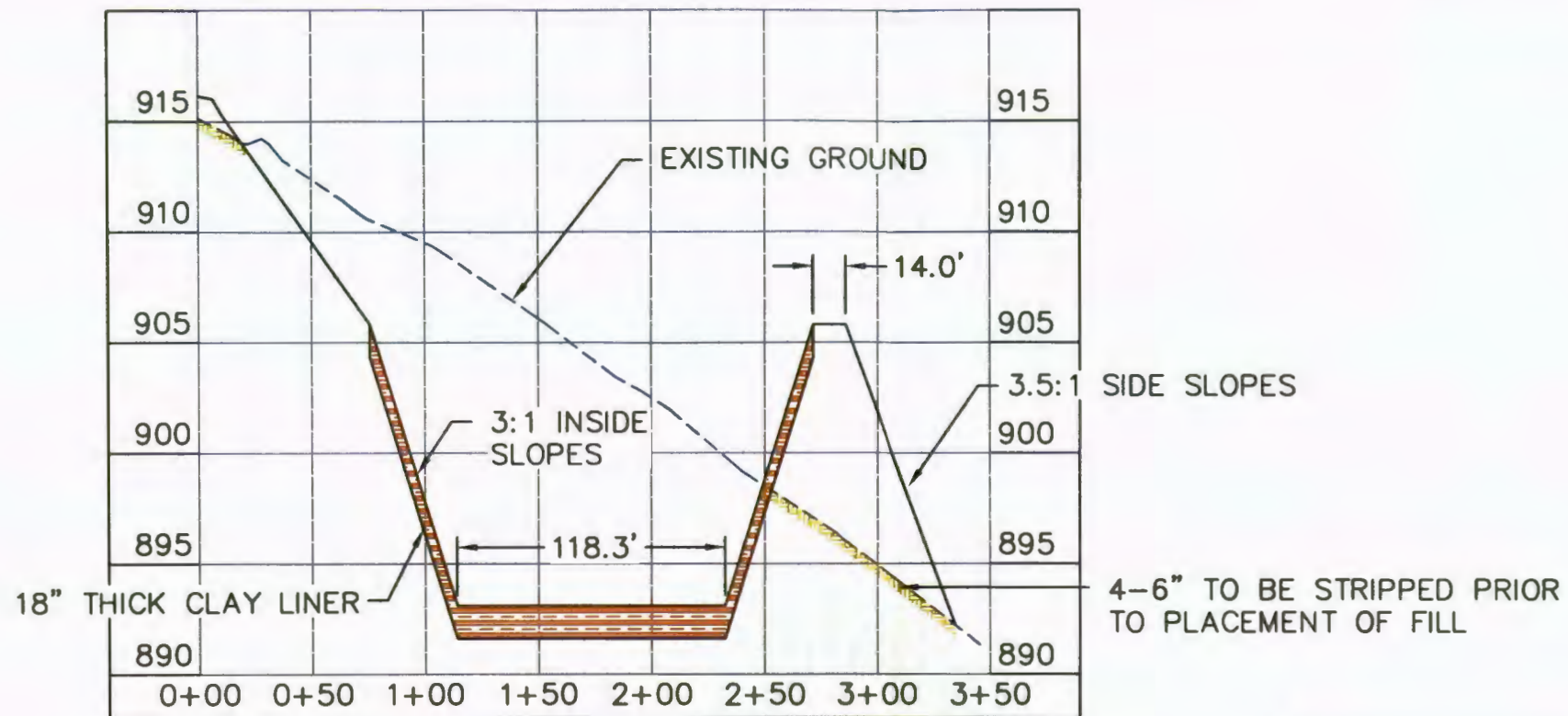

SCALE:
 VERTICAL: 1"=8'
 HORIZONTAL: 1"=80'

E-E
 8 WASTE STORAGE POND 2 CROSS SECTION

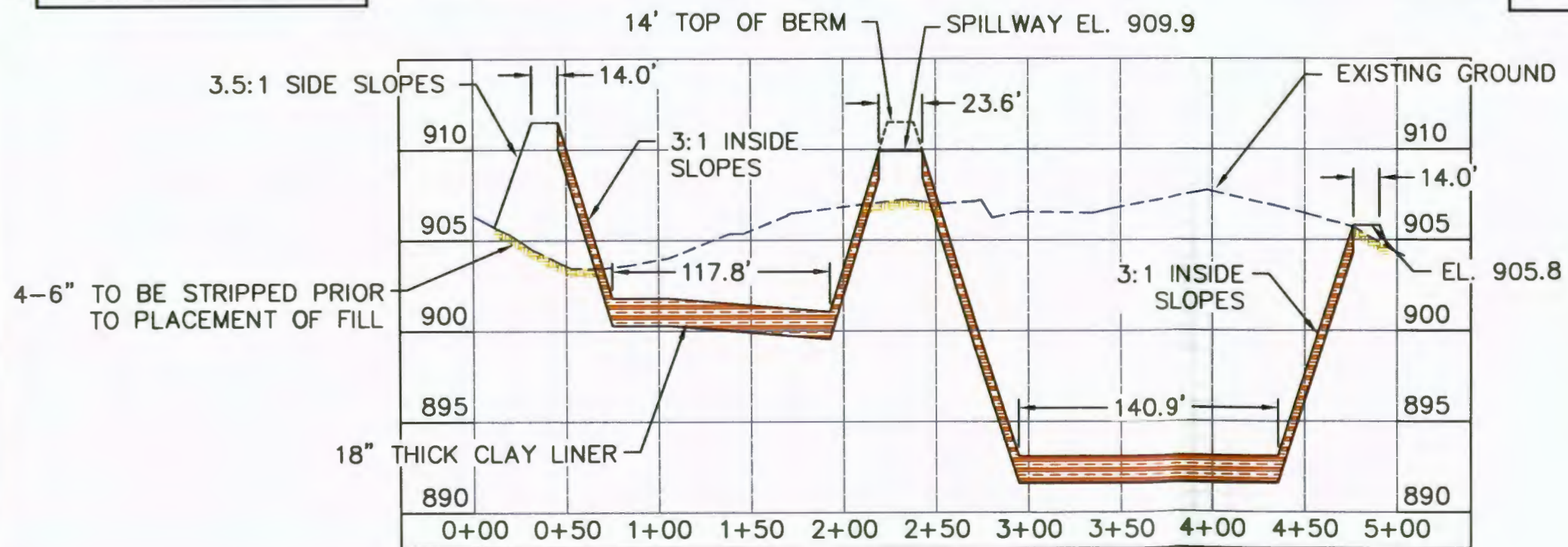
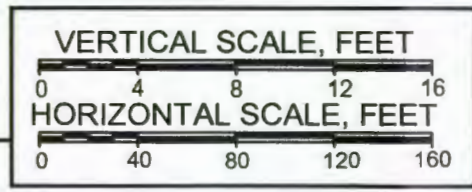

F-F
 8 WASTE STORAGE POND 1 & 2 CROSS SECTION

GENERAL NOTES

- GRAVEL
- FILL
- CONCRETE
- STRIPPING
- EXISTING GROUND

No.	Revision/Issue	Date

DeHaan, Grabs & Associates, LLC
 Consulting Engineers
 PO Box 522, Mondon, ND 58554
 (701) 663-1116, FAX: (701) 667-1356
 www.dgaengineering.com

C & H HOG FARMS
 GESTATION-FARROWING FARM

SECTION 26, T 18 N, R 20 W
 NEWTON COUNTY, AR

WASTE STORAGE
 POND CROSS SECTIONS

DATE: APR 30, 2012	SHEET: 11
SCALE: AS SHOWN	
DRAWN BY: NAP	
CHECKED BY: DLD	

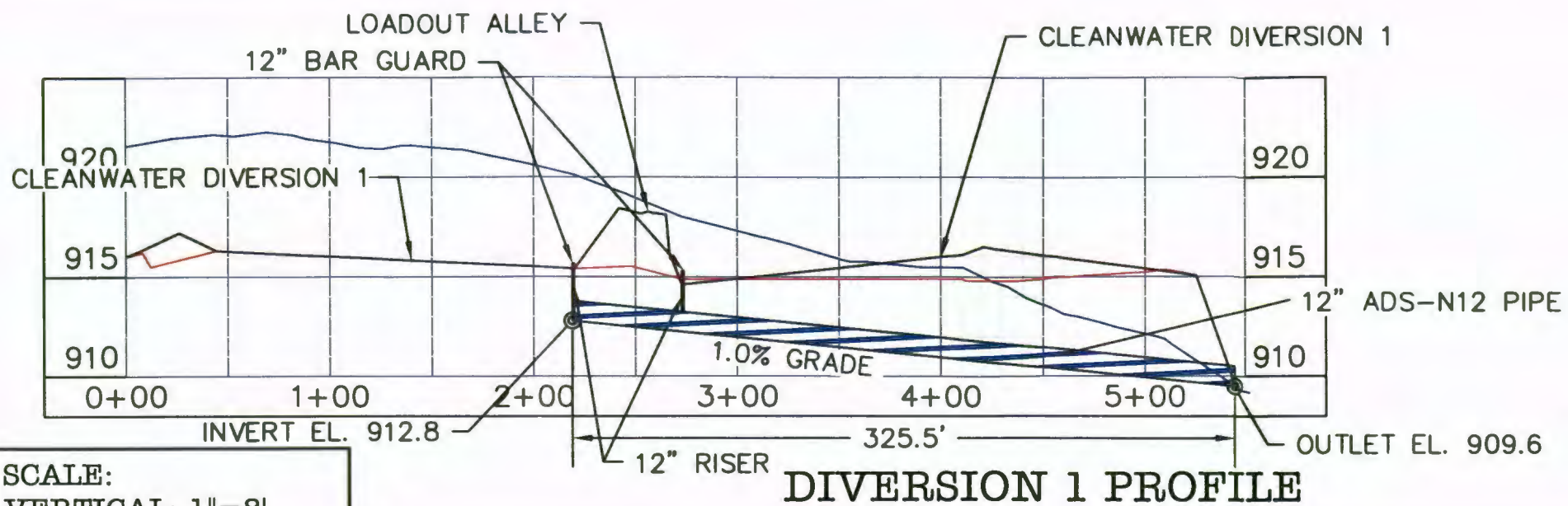

SCALE:
 VERTICAL: 1"=8'
 HORIZONTAL: 1"=80'

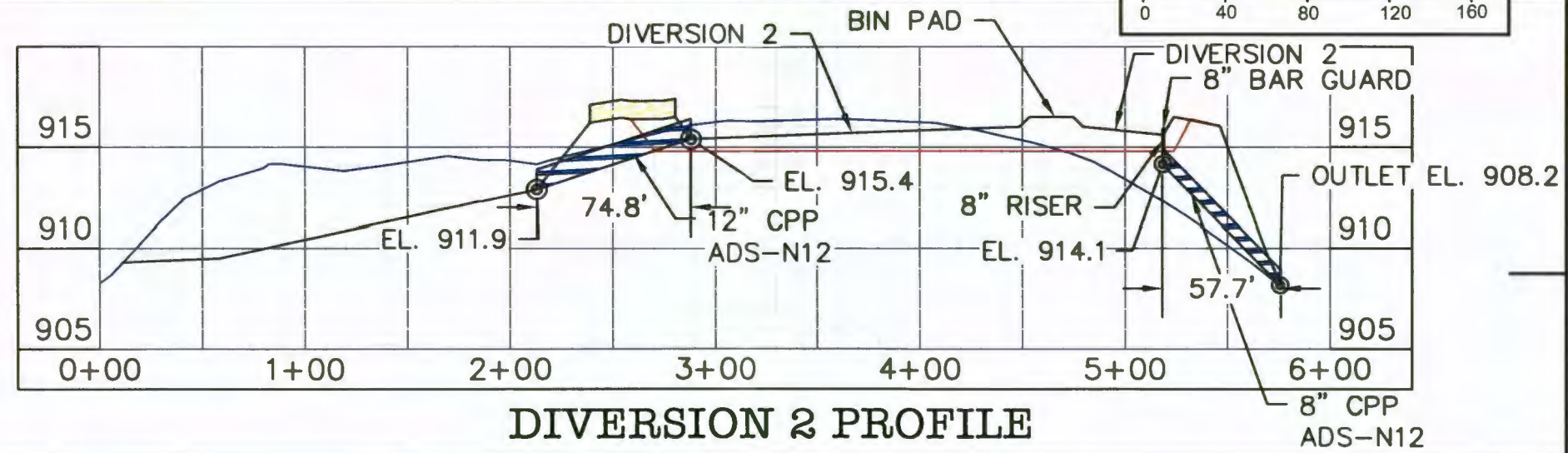
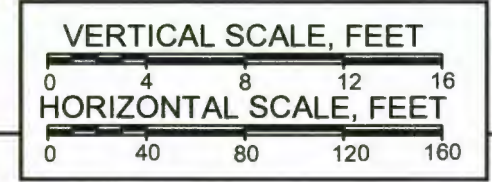

DIVERSION 2 PROFILE

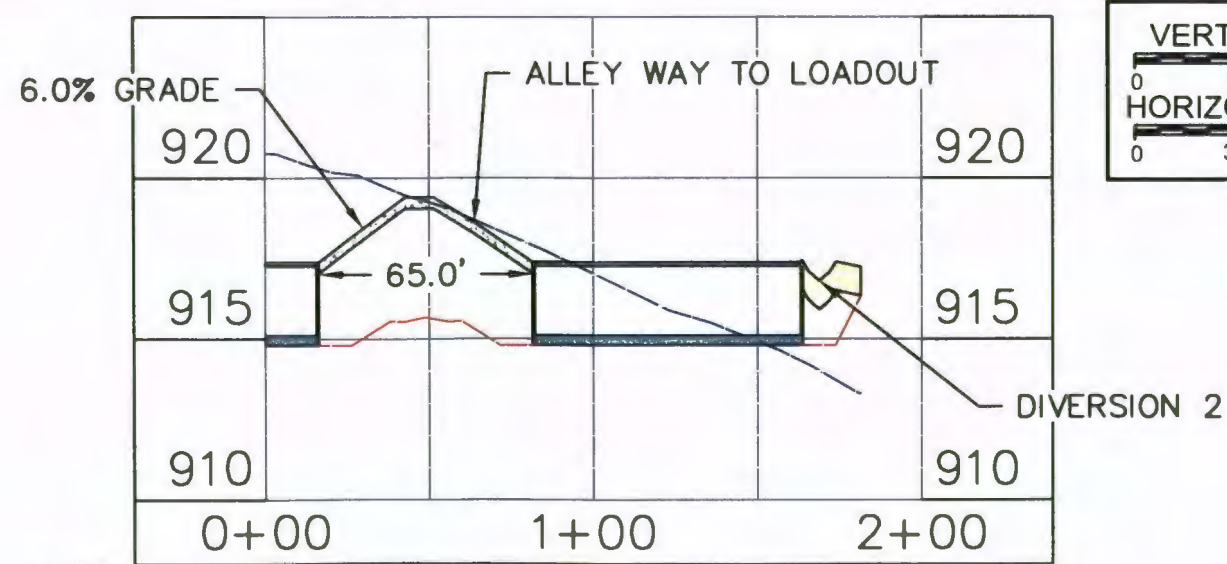

G-G
 8 LOADOUT HALLWAY CROSS SECTION

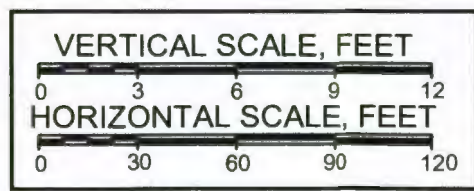

SCALE:
 VERTICAL: 1"=6'
 HORIZONTAL: 1"=60'

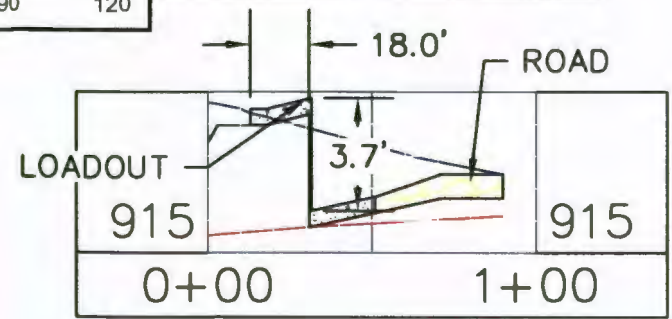

H-H
 8 LOADOUT CROSS SECTION

GENERAL NOTES

- GRAVEL
- FILL
- CONCRETE
- STRIPPING
- EXISTING GROUND

No.	Revision/Issue	Date

DeHaan, Grabs & Associates, LLC
 Consulting Engineers
 PO Box 522, Mandan, ND 58554
 (701) 663-1116, FAX: (701) 667-1356
 www.dgaengineering.com

C & H HOG FARMS
 GESTATION-FARROWING FARM
 SECTION 28, T 15 N, R 20 W
 NEWTON COUNTY, AR
 DIVERSION & LOADOUT
 CROSS SECTIONS & PROFILES

DATE: APR 30, 2012	SHEET: 12
SCALE: AS SHOWN	
DRAWN BY: NAP	
CHECKED BY: DLD	

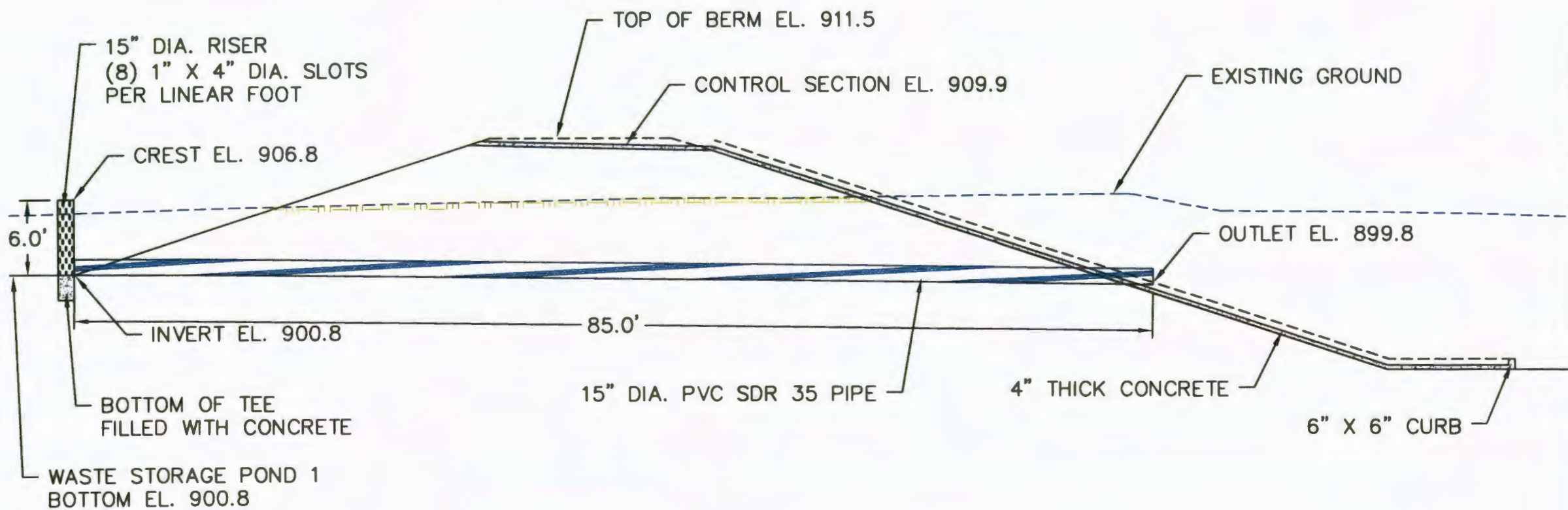



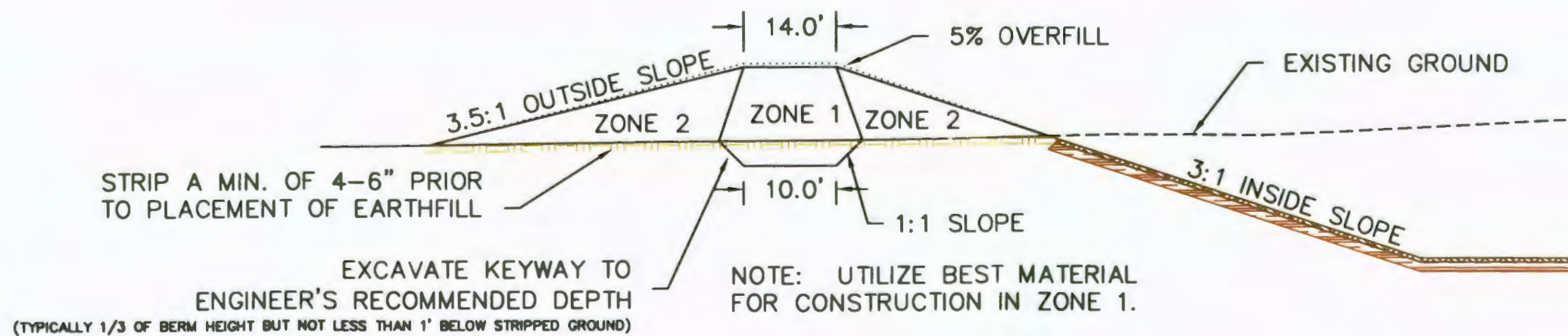

PIPE INLET DETAILS
SCALE: 1" = 10'



TYPICAL HOLDING POND MAXIMUM BERM DETAIL
NOT TO SCALE

GENERAL NOTES

-  GRAVEL
-  FILL
-  CONCRETE
-  STRIPPING
-  EXISTING GROUND

No.	Revision/Issue	Date

DeHaan, Grabs & Associates, LLC
Consulting Engineers
PO Box 522, Mandan, ND 58554
(701) 663-1116, FAX (701) 667-1356
www.dgoengineering.com



C & H HOG FARMS
GESTATION-FARROWING FARM

SECTION 26, T 16 N, R 20 W
NEWTON COUNTY, AR

POND INLET & MAXIMUM BERM DETAILS

DATE: APR 30, 2012	SHEET: 13
SCALE: AS SHOWN	
DRAWN BY: NAP	
CHECKED BY: DLD	

GENERAL NOTES

-  INSITU MATERIAL
-  CLAY LINER

SCALE, FEET

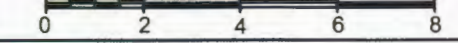

Waste Storage Pond 1 Stage Storage Table						
Elevation (ft)	Stage (ft)	Area (ft ²)	Volume (ft ³)	Cum. Volume (ft ³)	Cum. Volume (acre-feet)	
911.5	10.7	20,850	33,002	131,134	3.0	Top
910.5	9.7	19,139	21,770	111,122	2.6	Freeboard
25 Year-24 Hour Stage/Overflow El.						
909.8	9.0	17,976	8,780	98,132	2.3	
909.3	8.5	17,144	8,376	89,352	2.1	
908.8	8.0	16,360	7,980	80,976	1.9	
908.3	7.5	15,560	7,593	72,996	1.7	
907.8	7.0	14,812	7,217	65,403	1.5	
907.3	6.5	14,056	6,847	58,186	1.3	
906.8	6.0	13,332	6,488	51,339	1.2	
906.3	5.5	12,620	6,138	44,851	1.0	
905.8	5.0	11,932	5,796	38,713	0.9	
905.3	4.5	11,252	5,463	32,917	0.8	
904.8	4.0	10,600	5,140	27,454	0.6	
904.3	3.5	9,960	4,826	22,314	0.5	
903.8	3.0	9,344	4,520	17,488	0.4	
903.3	2.5	8,736	4,224	12,968	0.3	
902.8	2.0	8,160	3,937	8,744	0.2	
902.3	1.5	7,588	3,658	4,807	0.1	
901.8	1.0	7,044	1,005	1,149	0.0	
901.3	0.5	576	144	144	0.0	Sludge El.
900.8	0.0	0	0	0	0.0	Bottom

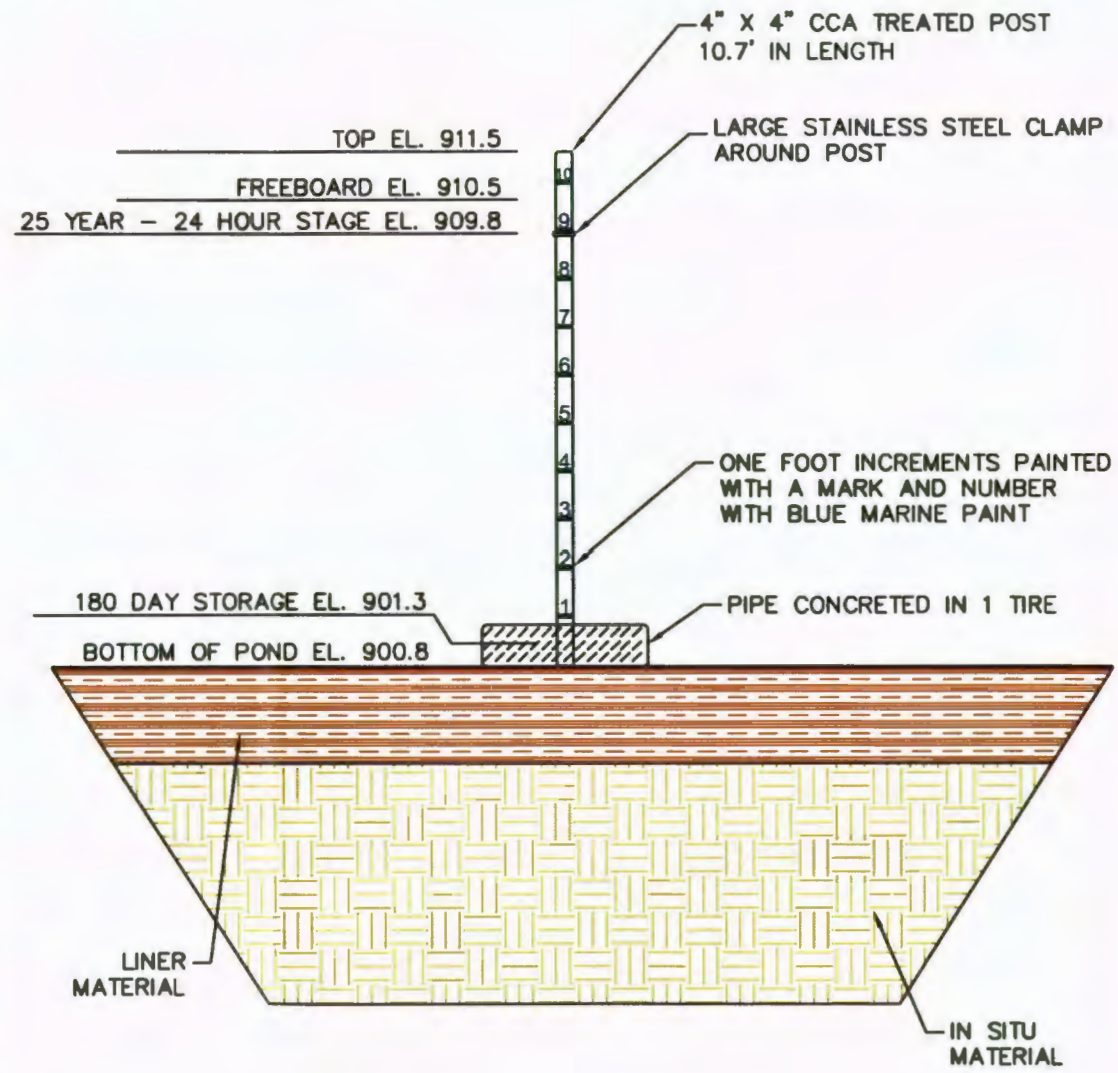

WASTE STORAGE POND 1

No.	Revision/Issue	Date

DeHaan, Grabs & Associates, LLC
 Consulting Engineers
 PO Box 522, Mandan, ND 58554
 (701) 663-1116, FAX: (701) 667-1356
 www.dgaengineering.com

C & H HOG FARMS
 GESTATION-FARROWING FARM
 SECTION 26, T 15 N, R 20 W
 NEWTON COUNTY, AR

**WASTE STORAGE POND 1
 STAGE STORAGE TABLE**

DATE: MAY 30, 2012	SHEET: 14
SCALE: 1" = 4'	
DRAWN BY: CAS	
CHECKED BY: DLD	

Waste Storage Pond 2 Stage Storage Table						
Elevation (ft)	Stage (ft)	Area (ft ²)	Volume (ft ³)	Cum. Volume (ft ³)	Cum. Volume (acre-feet)	
905.8	12.7	35,259	56,719	288,788	6.6	Top
904.8	11.7	32,994	34,994	254,643	5.8	Freeboard
25 Year-24 Hour Stage/Must Pumpdown						
904.1	11.0	31,469	12,420	232,069	5.3	
903.7	10.6	30,631	15,045	219,649	5.0	
903.2	10.1	29,549	14,521	204,604	4.7	
902.7	9.6	28,535	14,005	190,083	4.4	
902.2	9.1	27,485	13,499	176,078	4.0	
901.7	8.6	26,511	13,003	162,579	3.7	
901.2	8.1	25,501	12,516	149,576	3.4	
900.7	7.6	24,563	12,039	137,060	3.1	
900.2	7.1	23,593	11,571	125,021	2.9	
899.7	6.6	22,691	11,114	113,450	2.6	
899.2	6.1	21,765	10,664	102,336	2.3	
898.7	5.6	20,891	10,226	91,672	2.1	
898.2	5.1	20,013	9,796	81,446	1.9	
897.7	4.6	19,171	9,376	71,650	1.6	
897.2	4.1	18,333	8,966	62,274	1.4	
896.7	3.6	17,531	8,566	53,308	1.2	
896.2	3.1	16,733	8,174	44,742	1.0	
895.7	2.6	15,963	7,792	36,568	0.8	
895.2	2.1	15,205	7,420	28,776	0.7	
894.7	1.6	14,475	4,278	21,356	0.5	
894.2	1.1	13,759	9,484	17,078	0.4	180 Day Stage
893.7	0.6	13,063	7,594	7,594	0.2	
893.1	0.0	12,252	0	0	0.0	Bottom

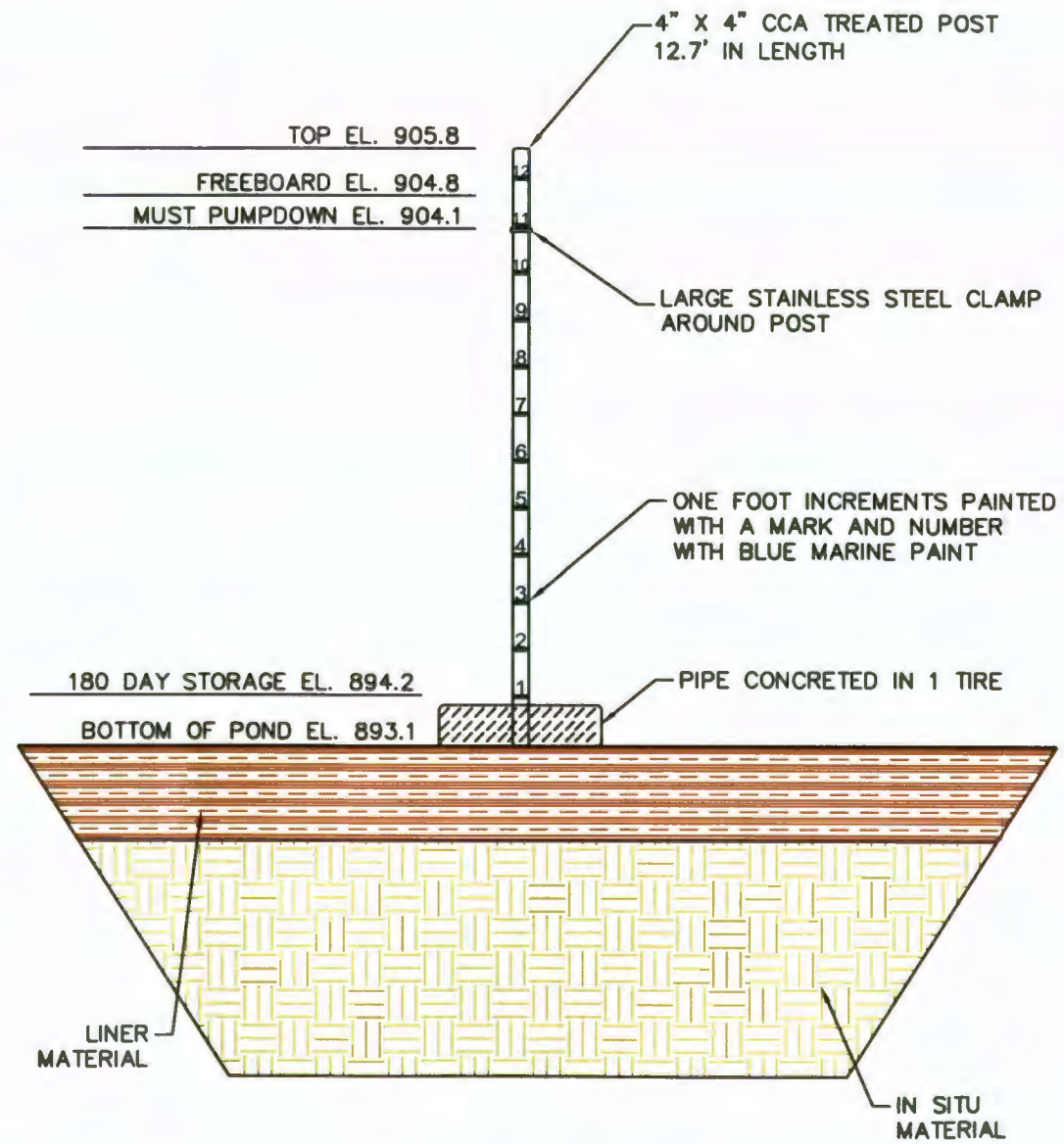

WASTE STORAGE POND 2

GENERAL NOTES

- INSITU MATERIAL
- CLAY LINER

SCALE, FEET



No.	Revision/Issue	Date

DeHaan, Grabs & Associates, LLC
 Consulting Engineers
 PO Box 522, Mandan, ND 58554
 (701) 663-1116, FAX: (701) 667-1356
 www.dgaengineering.com

C & H HOG FARMS
 GESTATION-FARROWING FARM

SECTION 26, T 16 N, R 20 W
 NEWTON COUNTY, AR

WASTE STORAGE POND 2
 STAGE STORAGE TABLE

DATE: MAY 30, 2012	15
SCALE: 1" = 4'	
DRAWN BY: CAS	
CHECKED BY: DLD	

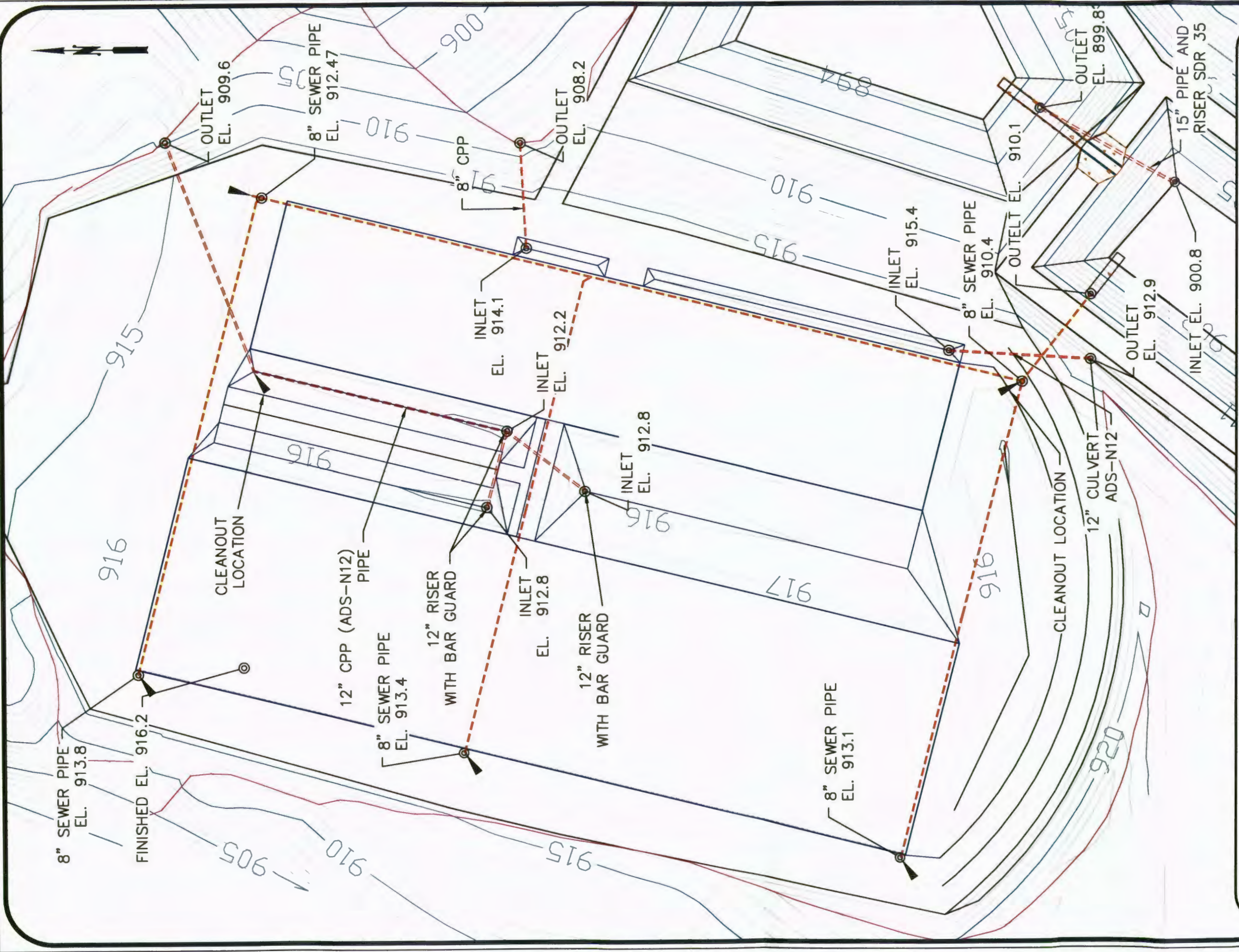

GENERAL NOTES

LEGEND

- ◆ BENCHMARK
- ▭ BUILDINGS
- - - FENCELINE
- - - CULVERT/PIPE
- ▲ CLEANOUT

SCALE, FEET

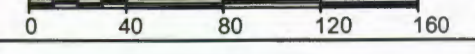

No.	Revision/Issue	Date

DeHaan, Grabs & Associates, LLC
 Consulting Engineers
 PO Box 522, Mandan, ND 58554
 (701) 663-1116, FAX: (701) 667-1356
 www.dgoengineering.com

C & H HOG FARMS
 GESTATION-FARROWING FARM

SECTION 26, T 15 N, R 20 W
 NEWTON COUNTY, AR

PIPE CLEANOUT LOCATIONS & DETAILS

DATE: APR 30, 2012	SHEET: 16
SCALE: 1" = 80'	
DRAWN BY: NAP	
CHECKED BY: DLD	

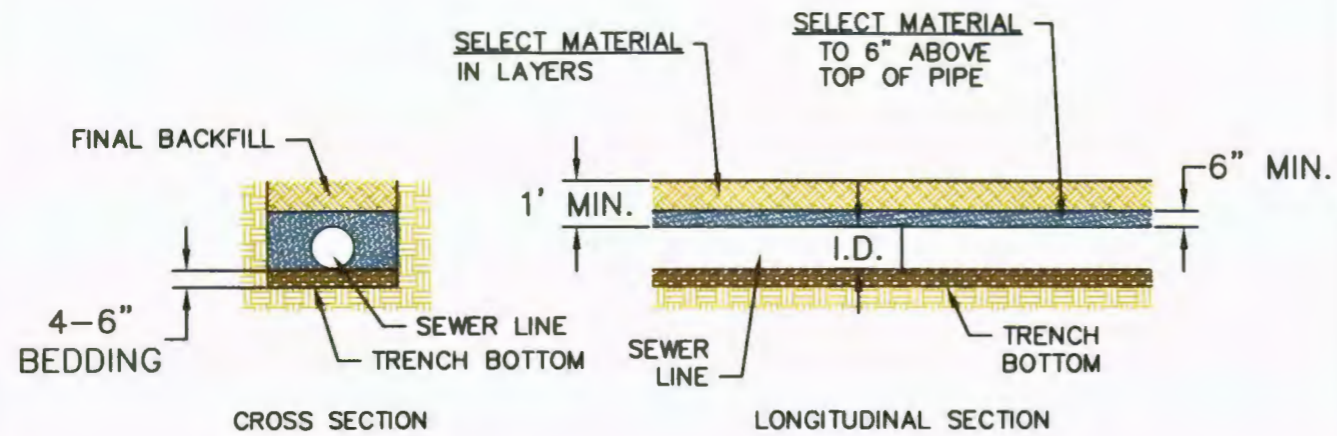

**STANDARD BEDDING DETAILS
FOR ADS-N12 PIPE OR EQUIVALENT**
NOT TO SCALE

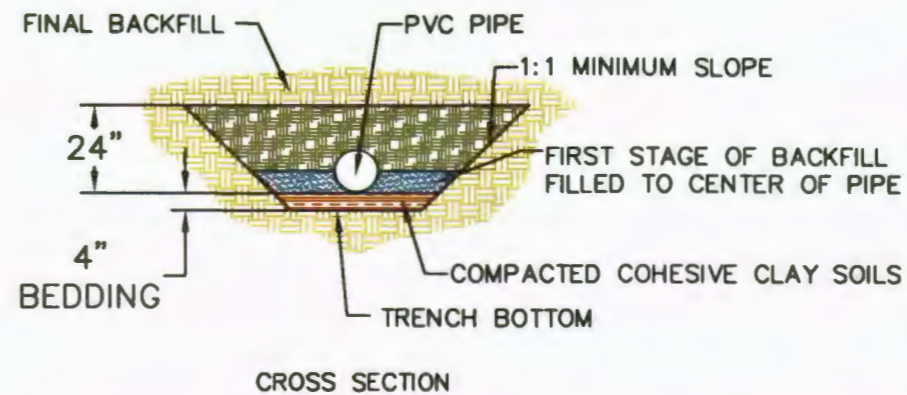

**STANDARD BEDDING DETAILS
FOR PVC PIPE OR EQUIVALENT
PLACED THROUGH BERM**
NOT TO SCALE

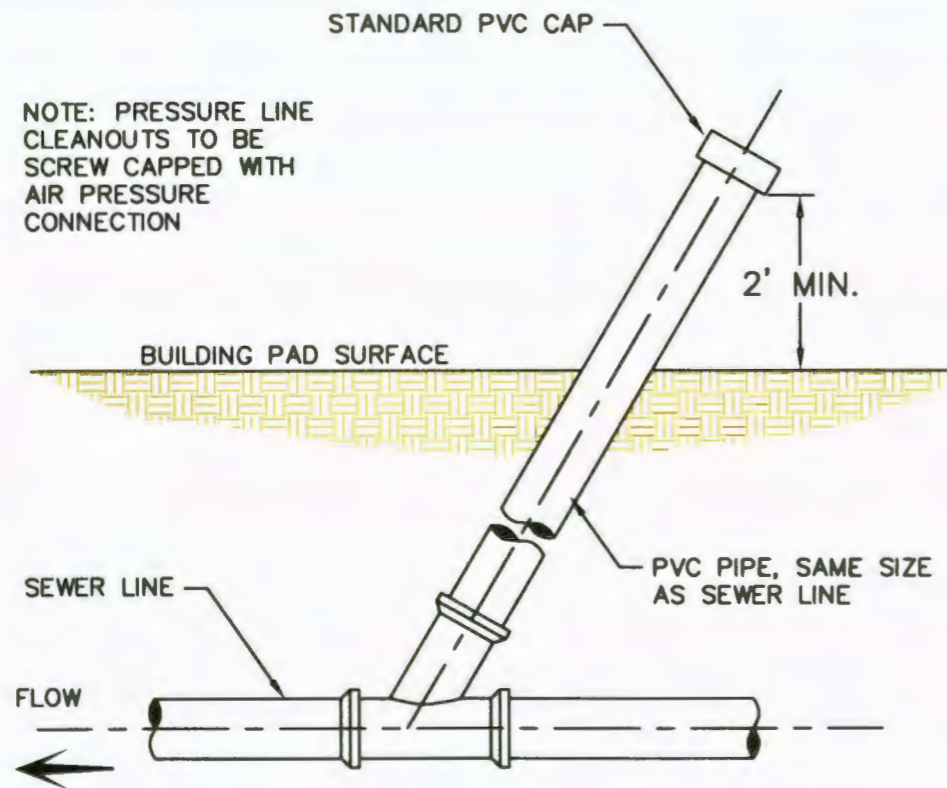

TYPICAL CLEANOUT DETAIL
NOT TO SCALE

ADS DUAL WALL TRENCHING & PIPELINE CONSTRUCTION NOTES

1. Select backfill shall consist of granular soil which meets the USCS soil type GM, GC, SM, or SC. Material shall have a maximum particle size of 1/2 inch diameter and shall be compacted in 6 inch layers (ma.) to a density not less than 85% of the Standard Proctor Density.
2. Unclassified backfill shall consist of excavated material, provided it is free from lumps of clay, stone, boulders and other debris. Material shall be wetted and compacted with available rubber tired construction equipment until approved by the Engineer.
3. In location where the trench bottom contains rocks or is unsuitable for pipe to rest on, as determined by the engineer, the pipe shall be bedded as shown.
4. In locations where the proposed pipelines cross existing utilities, the utility crossing details shall be determined in the field by the Engineer. Prior to trench excavation, existing utilities shall be located and exposed by the Contractor.
5. Select backfill shall be placed under the haunches of all pipe using the shovel slicing method or other method, approved by the Engineer.
6. All trenching excavation shall be braced and/or shored in accordance with OSHA Trench Safety Regulations.

GENERAL NOTES

No.	Revision/Issue	Date

DeHaan, Grabs & Associates, LLC
Consulting Engineers
PO Box 522, Mandan, ND 58554
(701) 663-1116, FAX: (701) 667-1356
www.dgaengineering.com

**C & H HOG FARMS
GESTATION-FARROWING FARM**

SECTION 26, T 15 N, R 20 W
NEWTON COUNTY, AR

**CLEANOUT & STANDARD
BEDDING DETAIL**

DATE: MAY 30, 2012	SHEET: 17
SCALE: NONE	
DRAWN BY: CAS	
CHECKED BY: DLD	

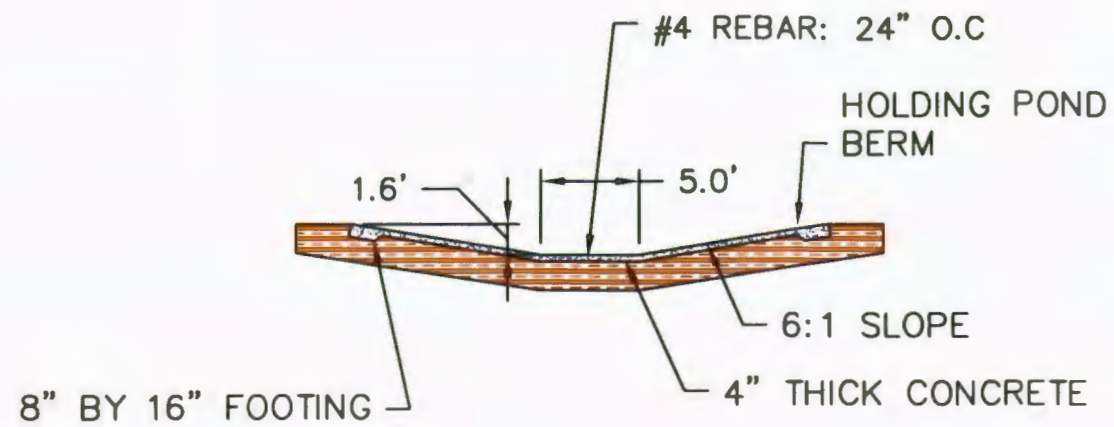
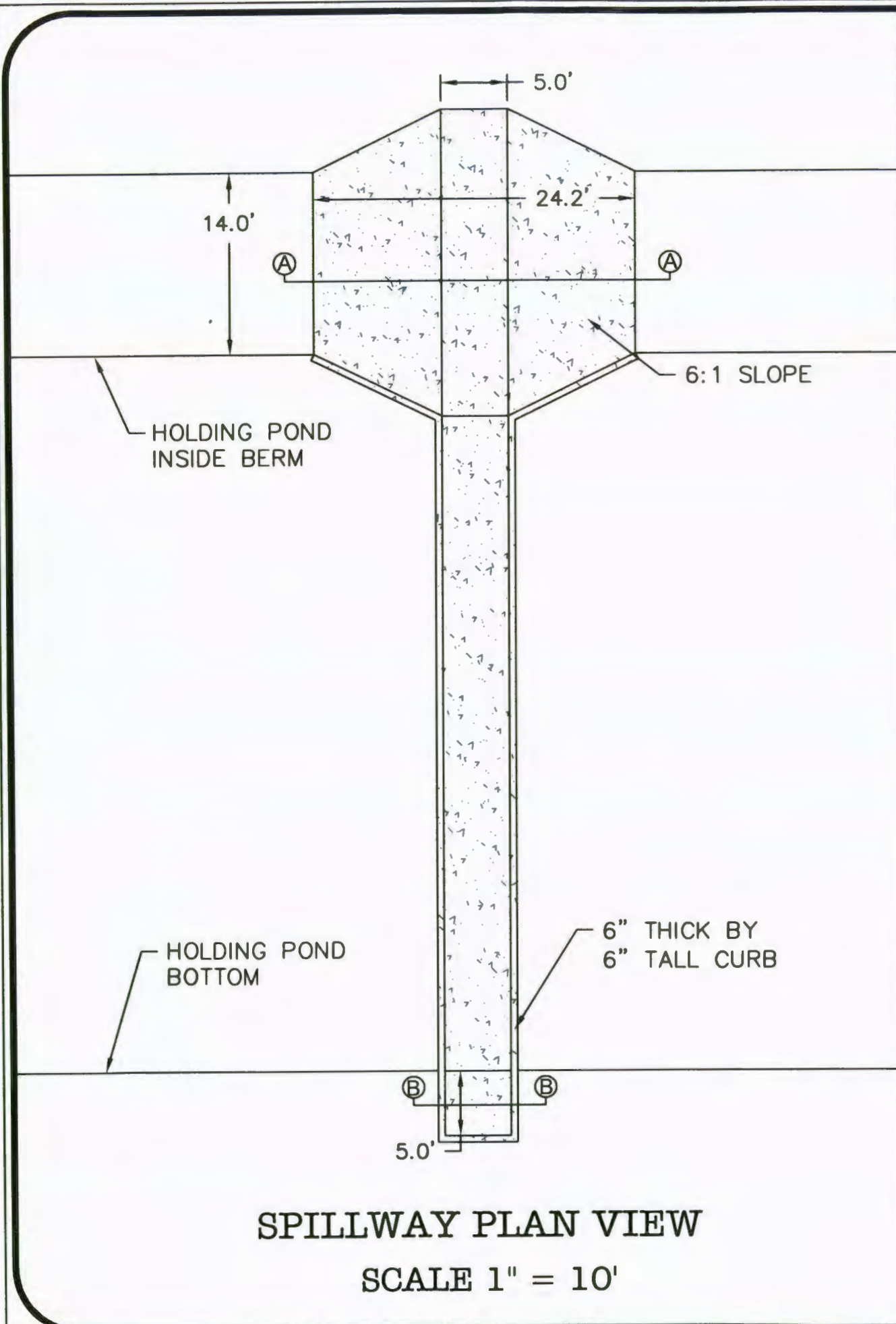

SECTION A-A

SCALE 1" = 10'

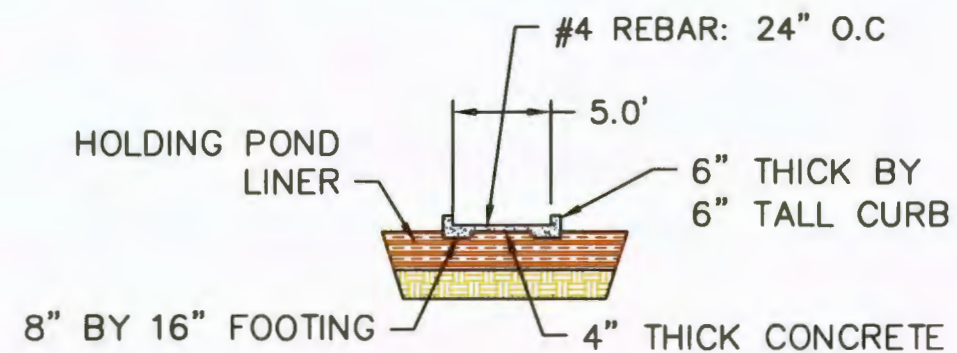

SECTION B-B

SCALE 1" = 10'

NOTE: SPLASH PAD FROM BARN WILL BE 5' WIDE WITH 6" X 6" CURB

GENERAL NOTES

No.	Revision/Issue	Date

DeHaan, Grabs & Associates, LLC
 Consulting Engineers
 PO Box 522, Mandan, ND 58554
 (701) 663-1116, FAX: (701) 667-1356
 www.dgaengineering.com

C & H HOG FARMS
 GESTATION-FARROWING FARM

SECTION 26, T 18 N, R 20 W
 NEWTON COUNTY, AR

SPILLWAY/SPLASHPAD
PLAN VIEW & DETAIL

DATE:
 MAY 30, 2012

SCALE:
 NONE

DRAWN BY:
 CAS

CHECKED BY:
 DLD

SHEET:

18

GESTATION BARN

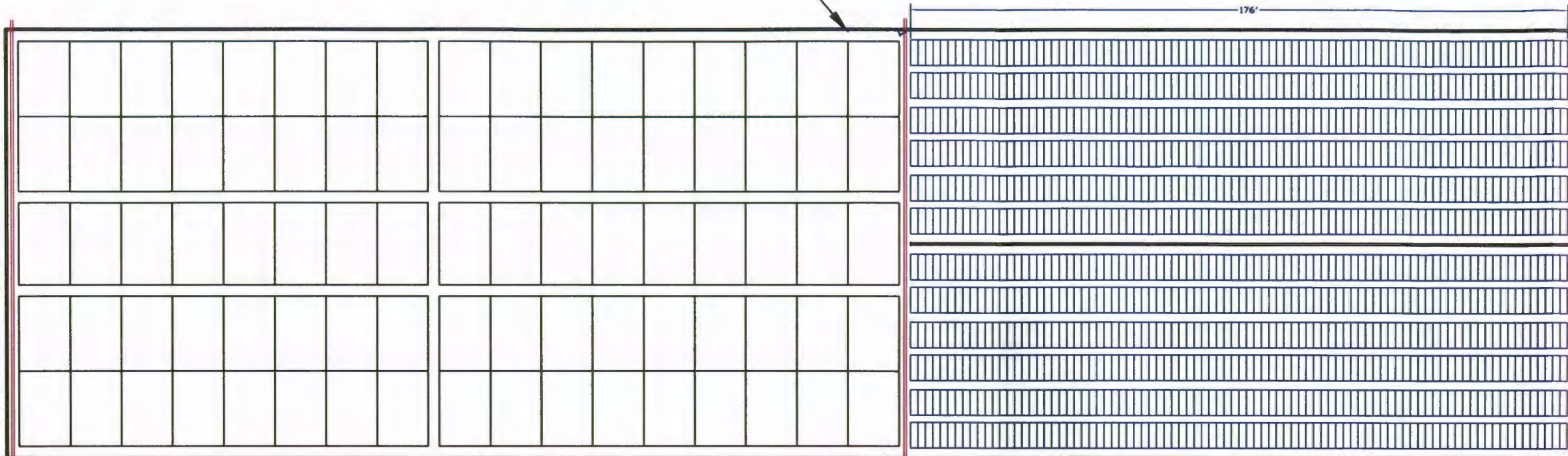

FARROWING/NURSERY BARN

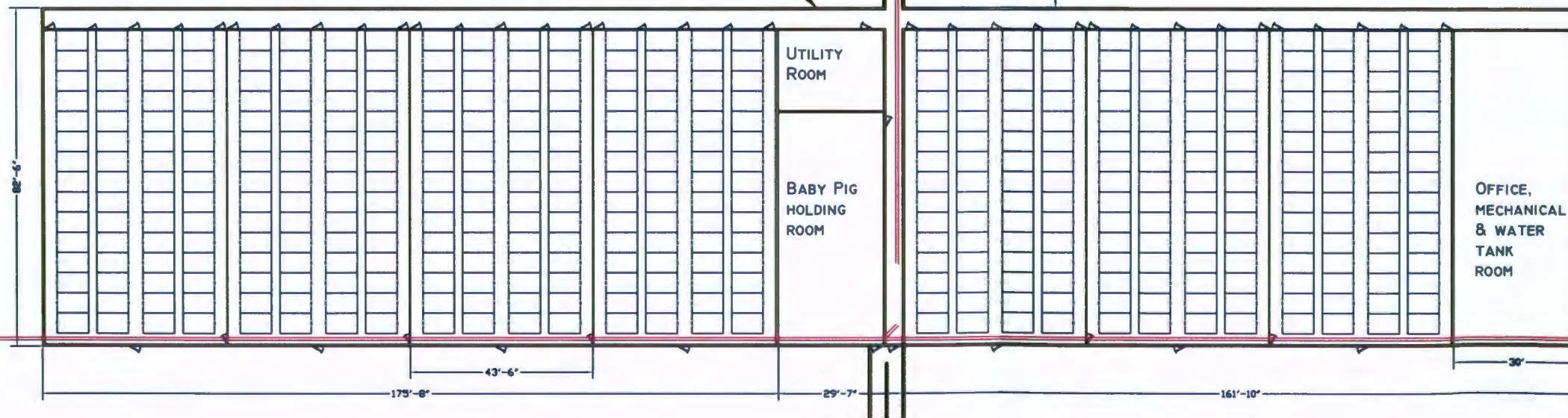

GENERAL NOTES

SCALE, FEET

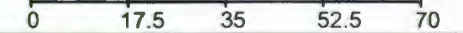

No.	Revision/Issue	Date

DeHaan, Grabs & Associates, LLC
 Consulting Engineers
 PO Box 522, Mandan, ND 58554
 (701) 663-1116, FAX: (701) 667-1356
 www.dgaengineering.com

C & H HOG FARMS
 GESTATION-FARROWING FARM
 SECTION 26, T 16 N, R 20 W
 NEWTON COUNTY, AR
GESTATION - FARROWING
BUILDING PLAN VIEW

DATE: MAY 23, 2012	SHEET: 19
SCALE: 1" = 35'	
DRAWN BY: CAS	
CHECKED BY: DLD	

GENERAL NOTES

SCALE, FEET

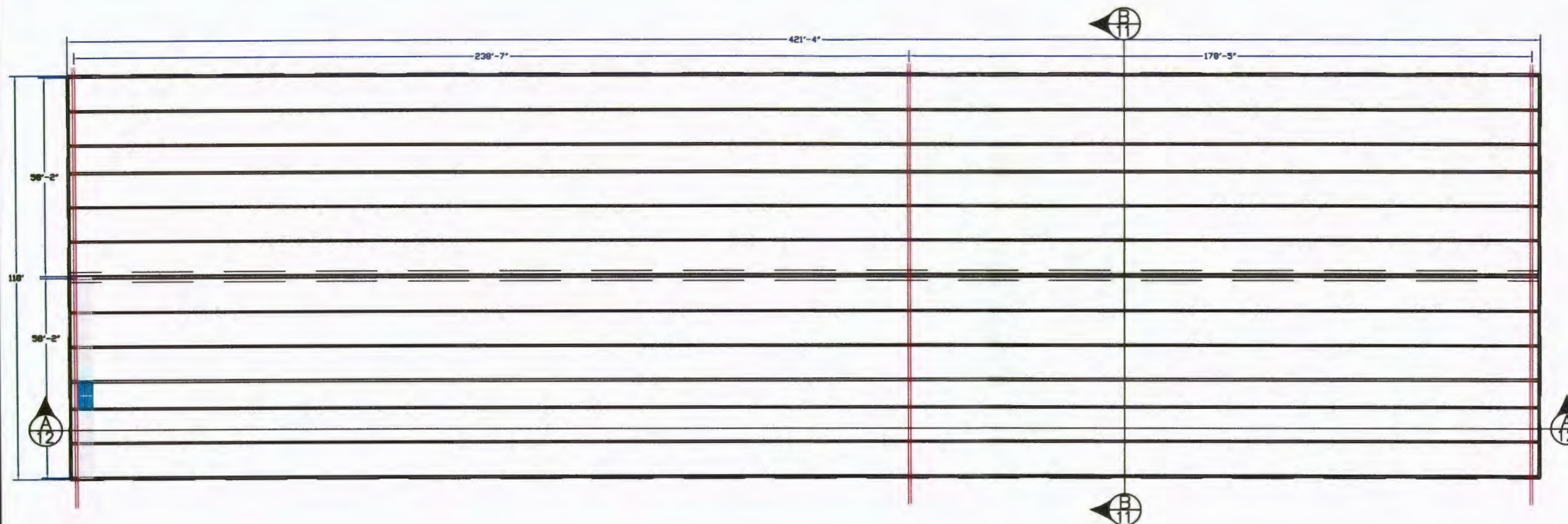
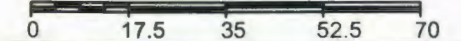

No.	Revision/Issue	Date

DeHaan, Grabs & Associates, LLC
 Consulting Engineers
 PO Box 522, Mandan, ND 58554
 (701) 663-1116, FAX: (701) 667-1356
 www.dgaengineering.com

C & H HOG FARMS
 GESTATION-FARROWING FARM
 SECTION 26, T 18 N, R 20 W
 NEWTON COUNTY, AR

GESTATION BUILDING PLAN VIEW

- 1. CONCRETE: (UNLESS OTHERWISE NOTED)**
 A. CONCRETE WALLS, FLOORS: 4000 PSI MINIMUM 28 DAY STRENGTH
 B. CONCRETE FOOTINGS: 4000 PSI MINIMUM 28 DAY STRENGTH
 C. ALL CONCRETE TO BE AIR ENTRAINED
 D. 3"-4" CONCRETE SLUMP ON HORIZONTAL POURS PRIOR TO ADDITIVES
 E. 5" MAXIMUM CONCRETE SLUMP ON VERTICAL POURS PRIOR TO ADDITIVES
 F. PIT WALL CONCRETE DESIGN BASED OFF OF A 3'-8" BACKFILL DEPTH AGAINST THE 4'-0" PIT WALL
 G. REFER TO ENGINEER SPECIFICATIONS FOR ADDITIONAL CONCRETE CONSTRUCTION REQUIREMENTS

- 2. REINFORCING STEEL: (UNLESS OTHERWISE NOTED)**
 A. ALL REBAR GRADE 60
 B. LAP ALL REINFORCING BAR SPLICES A MIN. OF 40 DIAMETERS
 C. PROVIDE BENT BARS AT ALL CORNERS AND WALL INTERSECTIONS TO MATCH THE HORIZONTAL REINFORCING STEEL (SEE DETAILS)
 D. EXTERIOR WALL FOOTING: TWO RUNS OF CONTINUOUS #5 HORIZONTAL REBAR
 E. PIT FLOORS : #3 REBAR @ 24" O.C. BOTH WAYS
 F. FOUNDATION WALLS: #3 VERTICAL REBAR @ 24" O.C. #3 HORIZONTAL REBAR @ 24" O.C.
 G. PIT WALLS: 2 - #3 HORIZONTAL REBAR #3 VERTICAL REBAR @ 24" O.C.

- 3. COLD JOINTS (UNLESS OTHERWISE NOTED)**
 A. WALLS (SEE DETAIL)
 B. PIT SLAB (SEE DETAIL)
- 4. CONTROL JOINTS (UNLESS OTHERWISE NOTED)**
 A. WALLS (SEE DETAIL)
 B. PIT SLAB (SEE DETAIL)
- 5. MISC. (UNLESS OTHERWISE NOTED)**
 A. WATERSTOP TO BE USED ON ALL EXTERIOR PIT SLAB/PIT WALL JOINTS (SEE DETAILS)
 B. FIELD VERIFY LOCATION OF FRESH WATER PIPE KNOCKOUT: R.O. 6" DIA.

DATE: MAY 23, 2012	SHEET: 20
SCALE: 1" = 35'	
DRAWN BY: CAS	
CHECKED BY: DLD	

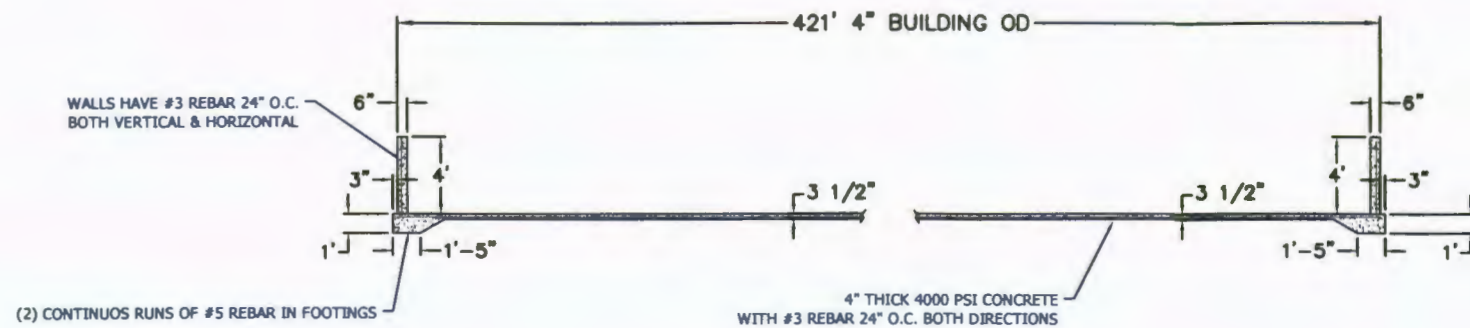

A-A
10
GESTATION BARN CROSS SECTION

GENERAL NOTES

SCALE, FEET



No.	Revision/Issue	Date

DeHaan, Grabs & Associates, LLC
 Consulting Engineers
 PO Box 522, Mandan, ND 58554
 (701) 663-1116, FAX: (701) 667-1356
 www.dgoengineering.com

C & H HOG FARMS
 GESTATION-FARROWING FARM
 SECTION 26, T 15 N, R 20 W
 NEWTON COUNTY, AR
GESTATION BUILDING
CROSS SECTIONS

DATE: MAY 23, 2012	SHEET: 21
SCALE: 1" = 30'	
DRAWN BY: CAS	
CHECKED BY: DLD	

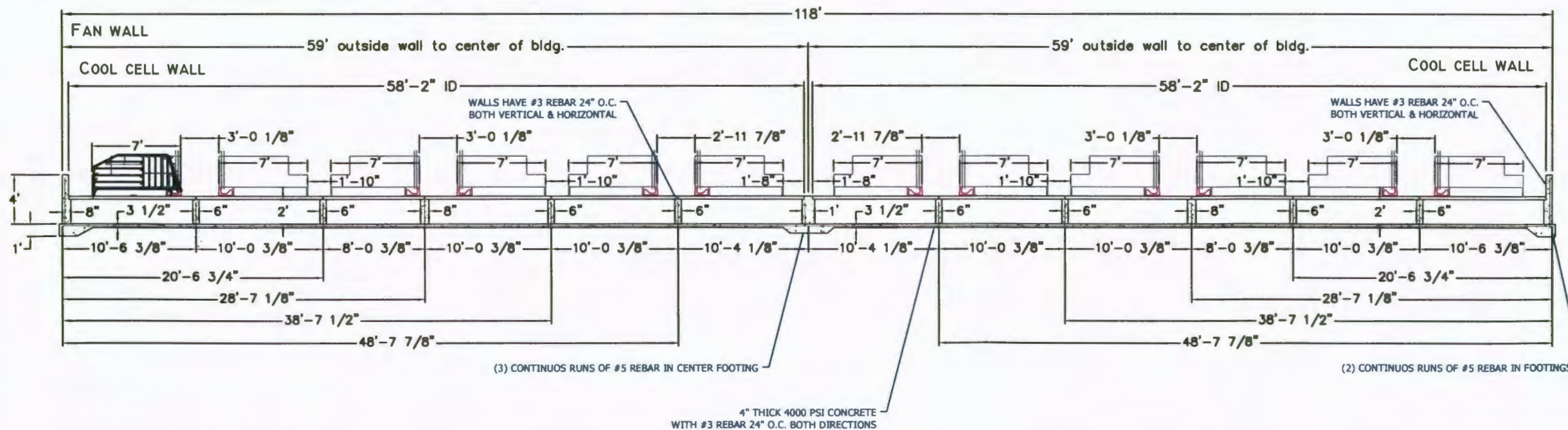

B-B
10
GESTATION BARN CROSS SECTION

GENERAL NOTES

SCALE, FEET

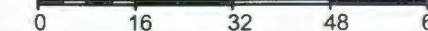

No.	Revision/Issue	Date

DeHaan, Grabs & Associates, LLC
 Consulting Engineers
 PO Box 522, Mandan, ND 58554
 (701) 663-1116, FAX: (701) 667-1356
 www.dgaengineering.com

C & H HOG FARMS
 GESTATION-FARROWING FARM

SECTION 26, T 16 N, R 20 W
 NEWTON COUNTY, AR

FARROWING BUILDING PLAN VIEW

DATE: MAY 23, 2012	SHEET: 22
SCALE: 1" = 32'	
DRAWN BY: CAS	
CHECKED BY: DLD	

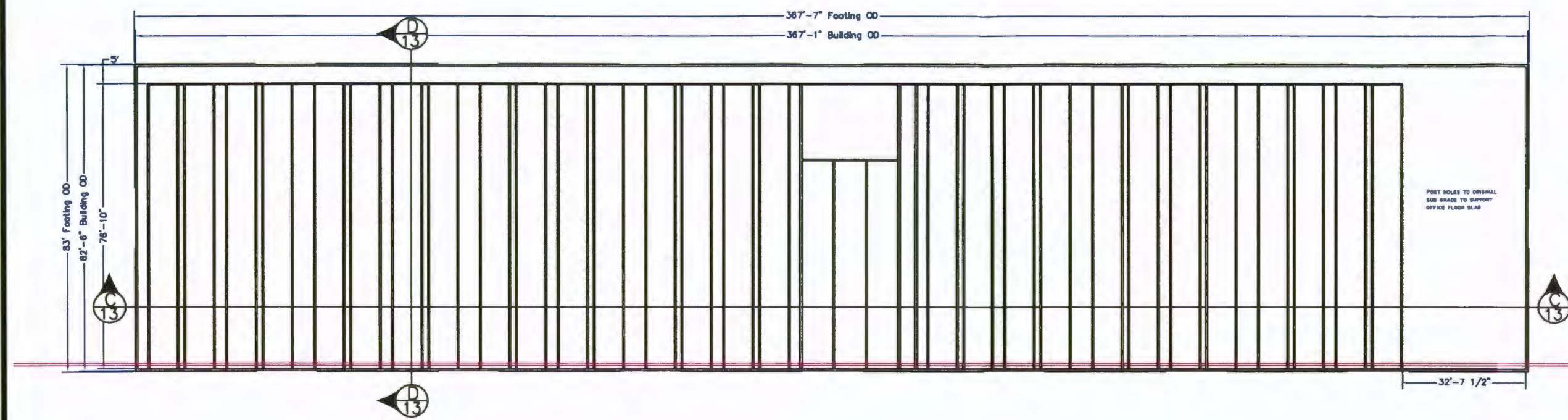

- CONCRETE: (UNLESS OTHERWISE NOTED)**
 - CONCRETE WALLS, FLOORS: 4000 PSI MINIMUM 28 DAY STRENGTH
 - CONCRETE FOOTINGS: 4000 PSI MINIMUM 28 DAY STRENGTH
 - ALL CONCRETE TO BE AIR ENTRAINED
 - 3"-4" CONCRETE SLUMP ON HORIZONTAL POURS PRIOR TO ADDITIVES
 - 5" MAXIMUM CONCRETE SLUMP ON VERTICAL POURS PRIOR TO ADDITIVES
 - PIT WALL CONCRETE DESIGN BASED OFF OF A 2'-0" BACKFILL DEPTH AGAINST THE 2'-6" PIT WALL
 - REFER TO ENGINEER SPECIFICATIONS FOR ADDITIONAL CONCRETE CONSTRUCTION REQUIREMENTS
- REINFORCING STEEL: (UNLESS OTHERWISE NOTED)**
 - ALL REBAR GRADE 60
 - LAP ALL REINFORCING BAR SPLICES A MIN. OF 40 DIAMETERS
 - PROVIDE BENT BARS AT ALL CORNERS AND WALL INTERSECTIONS TO MATCH THE HORIZONTAL REINFORCING STEEL. (SEE DETAILS)
 - EXTERIOR WALL FOOTING: TWO RUNS OF CONTINUOUS #4 HORIZONTAL REBAR
 - PIT FLOORS : 6" x 6" #10 WWM
 - FOUNDATION WALLS: #4 VERTICAL REBAR @ 12" O.C.
#4 HORIZONTAL REBAR @ 12" O.C.
 - PIT WALLS: #4 HORIZONTAL REBAR @ 12" O.C.
#4 VERTICAL REBAR @ 16" O.C.

- COLD JOINTS (UNLESS OTHERWISE NOTED)**
 - WALLS (SEE DETAIL)
 - PIT SLAB (SEE DETAIL)
- CONTROL JOINTS (UNLESS OTHERWISE NOTED)**
 - WALLS (SEE DETAIL)
 - PIT SLAB (SEE DETAIL)
- MISC. (UNLESS OTHERWISE NOTED)**
 - WATERSTOP TO BE USED ON ALL EXTERIOR PIT SLAB/PIT WALL JOINTS (SEE DETAILS)
 - FIELD VERIFY LOCATION OF FRESH WATER PIPE KNOCKOUT: R.O. 6" DIA.

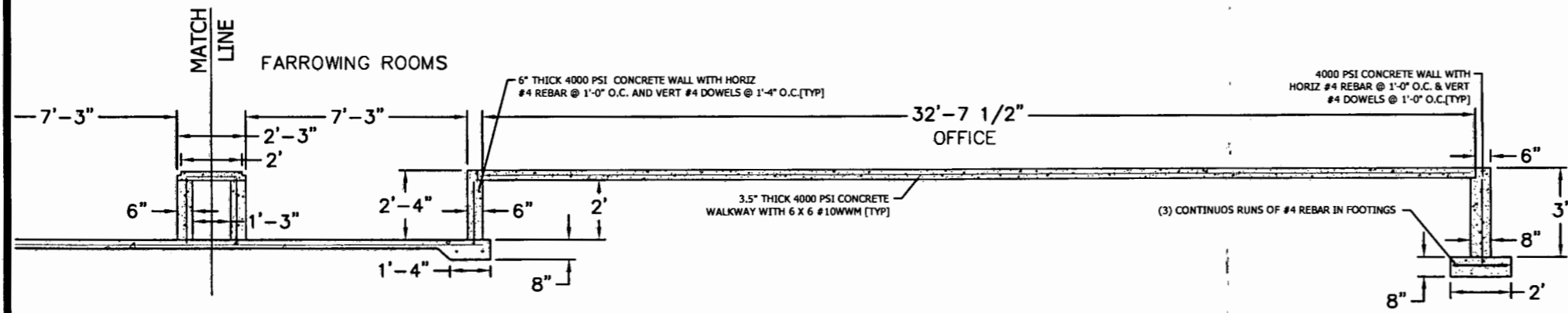
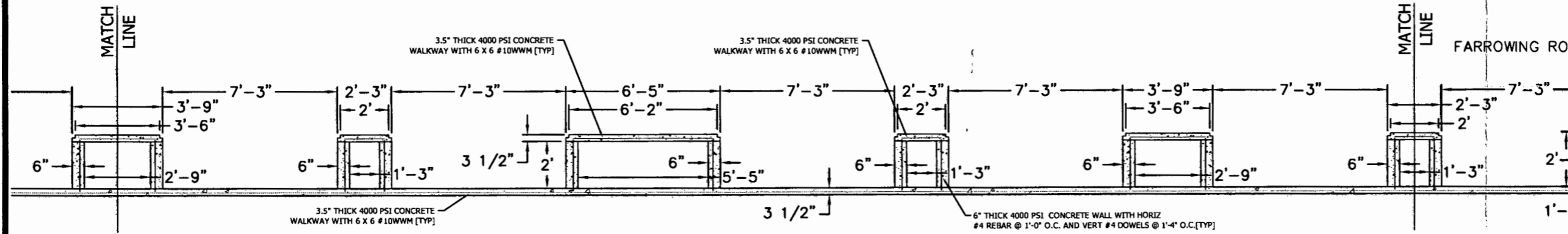
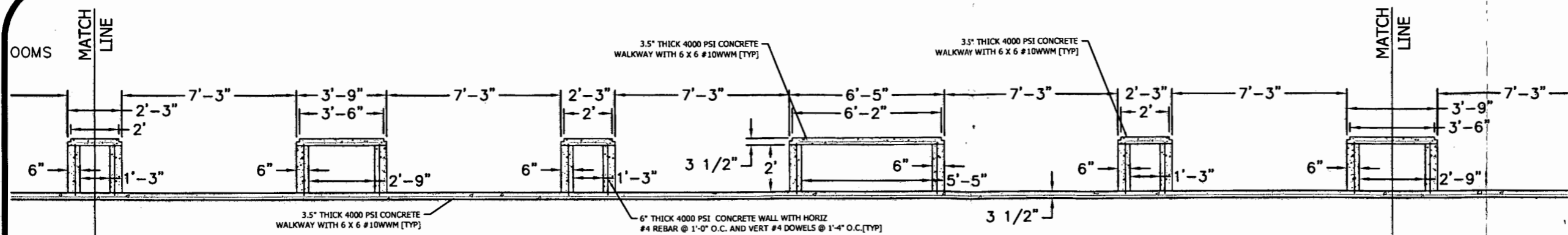

C-C
12
FARROWING/NURSERY CROSS SECTION

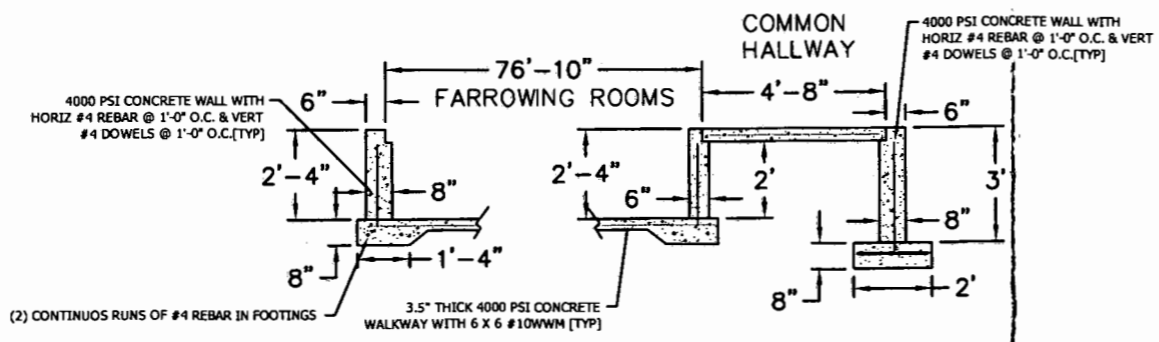

D-D
12
FARROWING/NURSERY CROSS SECTION

GENERAL NOTES

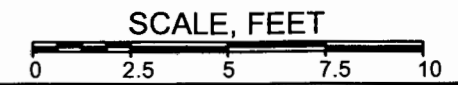

No.	Revision/Issue	Date

DeHaan, Grabs & Associates, LLC
 Consulting Engineers
 PO Box 522, Mandan, ND 58554
 (701) 663-1116, FAX: (701) 667-1356
 www.dgoengineering.com

C & H HOG FARMS
 GESTATION-FARROWING FARM
 SECTION 26, T 15 N, R 20 W
 NEWTON COUNTY, AR
FARROWING BUILDING
CROSS SECTIONS 2

DATE: MAY 23, 2012	SHEET: 24
SCALE: 1" = 5'	
DRAWN BY: CAS	
CHECKED BY: DLD	

Table of Quantities		
Item	Quantity	Unit
Stripping (Includes soil removal, replacement and compaction)		
Stripping Removal	2,460	YD ³
Replacement	1,890	YD ³
Excavation		
Subgrade Design	37,680	YD ³
Earthfill		
Subgrade Design	19,820	YD ³
Backfill: Final Design	2,470	YD ³
2" Granular Fill	620	YD ³
9" Thick Gravel	1,910	YD ³
Concrete		
Gestation Barn Flat work (Floor & Footings)	692	YD ³
Gestation Walls (Pit, Divider & Stem)	288	YD ³
Farrowing Barn Flat work (Floor and Footings)	377	YD ³
Farrowing Barn Walls	132	YD ³
Farrowing Barn Caps	84	YD ³
Overflow Spillway and Splashpad and Ramp	19	YD ³
Pipes (To include all appurtenances and fittings)		
15" PVC Pipe SDR 35	85	LFT
15" Riser PVC SDR 35	1	Lump Sum
12" Corrugated Plastic Pipe (ADS-N12)	440	LFT
12" Riser	3	Lump Sum
8" Corrugated Plastic Pipe (ADS-N12) or Equivalent	58	LFT
8" Riser	1	Lump Sum
8" PVC SDR 35	1,272	LFT
8" PVC SDR 35 Cleanouts	5	Lump Sum
12" Corrugated Plastic Pipe Cleanout	2	Lump Sum
Miscellaneous		
Seeding	2.2	Acres
Staff Gage	2	Lump Sum

GENERAL NOTES

No.	Revision/Issue	Date

DeHaan, Grabs & Associates, LLC
 Consulting Engineers
 PO Box 522, Mandan, ND 58554
 (701) 663-1116, FAX: (701) 667-1356
 www.dgaengineering.com

C & H HOG FARMS
 GESTATION-FARROWING FARM
 SECTION 26, T 15 N, R 20 W
 NEWTON COUNTY, AR

TABLE OF QUANTITIES

DATE: MAY 30, 2012	SHEET: 25
SCALE: NONE	
DRAWN BY: CAS	
CHECKED BY: DLD	



Section F: Technical Specifications

SECTION F. TECHNICAL SPECIFICATIONS

TABLE OF CONTENTS

1. EARTHEN STRUCTURES

- 1.1 SAFETY
- 1.2 SITE PREPARATION
- 1.3 EMBANKMENT CORE TRENCH
- 1.4 EXCAVATION
- 1.5 HOLDING POND EMBANKMENT
- 1.6 HOLDING POND LINER
- 1.7 HOLDING POND INLET STRUCTURES
- 1.8 BUILDING PAD /DRIVEWAY/ SERVICE ROAD
- 1.9 CULVERTS
- 1.10 FENCING
- 1.11 TOPSOIL
- 1.12 SEEDING
- 1.13 GRAVEL ROAD ROCK
- 1.14 LIQUID LEVEL GAGE
- 1.15 CLEAN UP

2. CONCRETE CONSTRUCTION SPECIFICATION

- 2.1 SCOPE
- 2.2 MATERIALS
- 2.3 STRENGTH OF CONCRETE
- 2.4 AIR CONTENT AND CONSISTENCY
- 2.5 DESIGN OF THE CONCRETE MIX
- 2.6 INSPECTION AND TESTING
- 2.7 HANDLING AND MEASUREMENT OF MATERIALS
- 2.8 MIXERS AND MIXING
- 2.9 FORMS
- 2.10 PREPARATION OF FORMS AND SUBGRADE
- 2.11 CONVEYING
- 2.12 PLACING
- 2.13 CONSTRUCTION JOINTS
- 2.14 EXPANSION AND CONSTRUCTION JOINTS
- 2.15 WATERSTOPS
- 2.16 REMOVAL OF FORMS
- 2.17 FINISHING FORMED SURFACES
- 2.18 FINISHING UNFORMED SURFACES
- 2.19 CURING

- 2.20 REMOVAL AND REPLACEMENT OR REPAIR
- 2.21 CONCRETING IN COLD WEATHER
- 2.22 CONCRETING IN HOT WEATHER
- 2.23 MEASUREMENT AND PAYMENT
- 2.24 ITEMS OF WORK AND CONSTRUCTION DETAILS

3. STEEL REINFORCEMENT FOR CONCRETE CONSTRUCTION SPECIFICATIONS

- 3.1 SCOPE
- 3.2 MATERIALS
- 3.3 BAR SCHEDULE, LISTS AND DIAGRAMS
- 3.4 BENDING
- 3.5 SPLICING BAR REINFORCEMENT
- 3.6 SPLICING WELDING WIRE FABRIC
- 3.7 PLACING
- 3.8 STORAGE
- 3.9 MEASUREMENT AND PAYMENT
- 3.10 ITEMS OF WORK AND CONSTRUCTION DETAILS

4. QUALITY ASSURANCE PROGRAM

- 4.1 LINES OF AUTHORITY
- 4.2 SPECIALIZED SKILLS OR WORK QUALIFICATIONS
- 4.3 OBSERVATION AND OVERSIGHT DUTIES
- 4.4 TEST PROCEDURES, FREQUENCIES AND REPORTING

1. EARTHEN STRUCTURES

1.1 SAFETY

The contractor is solely responsible for being aware of and meeting all safety requirements for work on this site. These may include but are not limited to requirements set forth by OSHA, the State or the County. The contractor is also responsible for locating any underground power lines, pipelines, phone lines, etc. in the area of excavation. This shall include notifying the Arkansas One-Call System at least two days prior to the start of excavation activities.

If at any time, the contractor feels that due to site conditions, the construction techniques outlined in the Plans and Technical Specifications are not safe, he shall immediately stop work and contact the engineer, and an alternative method shall be determined.

1.2 SITE PREPARATION

The foundation and borrow area of all proposed earthwork areas shall be cleared of all old equipment, old buildings, trees, stumps, roots, brush and boulders and stripped of all sod and topsoil. All channel banks and sharp breaks shall be sloped no steeper than 1:1. All topsoil containing substantial organic matter shall be removed and stockpiled. The surface of any area that will have fill placed on it will be thoroughly scarified to a minimum depth of 4 inches before placement of compacted fill. All drainage channels crossing fill areas shall be cleaned and widened to accommodate compaction equipment. Such channels shall be backfilled with suitable material as specified for compacted earthfill and compacted to the same specifications as the overlying fill. All waste material shall be buried away from the fill area.

1.3 EMBANKMENT CORE TRENCH

The core trench for the holding pond and settling basin shall be excavated to the lines and grades shown on the plan or as revised by the Engineer due to conditions encountered during site preparation. Backfill for the core trench, as designated Zone 1 on the plans, shall be made with the most impervious material encountered during excavation of borrow areas. Material unsuitable for use as fill excavated from the core trench shall be treated as waste and disposed of away from the fill area. If no designation of Zones is shown on the plans, all material shall be considered equivalent to Zone 1 material. The contractor shall notify the engineer before core trench excavation begins.

1.4 EXCAVATION

Unless specified by the Engineer, no borrow material shall be taken from areas outside the holding pond impoundment area or designated borrow areas except for excavation of ditches or other structures shown on the plans or for the reshaping of pens. All materials undesirable for fill purposes shall be stripped from the borrow areas and either stockpiled

for later use as topsoil or disposed of properly. The impoundment area shall be excavated to the lines and grades as shown on the plans. Any borrow areas outside the impoundment area shall be graded and left in a well-drained condition.

The contractor shall be responsible for the removal of excess water from any portion of the job site and all necessary equipment. In addition, the contractor is responsible for ensuring that all applicable permits have been obtained prior to any dewatering. Pumping of ponded water, if necessary during construction, shall be conducted in a timely manner to prevent saturation of large areas of the borrow pit and outletted to an acceptable drainage course as determined by the Engineer.

Excavation is considered integral to fill placement, therefore payment will be made for only one.

1.5 HOLDING POND EMBANKMENT

Fill shall be placed at the lowest point along the centerline of the embankment in horizontal layers not to exceed 6 inches in compacted depth to specified densities before placement of a successive layer. The fill shall be placed over the entire length and width of the embankment along one side of the holding pond except in areas where sectionalized construction is authorized by the Engineer. Where less impervious material is encountered in the borrow area, it shall be placed in the outer portions of the embankment (Zone 2 on Plans) as part of each lift and compacted the same as the rest of the embankment if authorized by the Engineer. Rocks larger than 6 inches in diameter shall not be used in the fill.

The contractor shall be responsible for any water needed to raise the moisture content of fill material prior to compaction. The contractor shall also provide any equipment necessary to apply this water to fill. Care should be taken to prevent excessive cracking of compacted fill before a successive layer is placed.

Compaction shall be performed to each lift by means of controlled travel of compaction equipment so that each lift of the fill area has been uniformly compacted to a final density consistent with 95% Standard Proctor Density (ASTM D-698). Each pass of soil loading and compaction equipment should travel parallel to the centerline of the embankment. The moisture content at the time of compaction shall be consistent with the requirements of compaction to achieve final density.

1.6 HOLDING POND LINER

The holding pond's final grades shall be over cut by a minimum of 18 inches, scarified and padded with a minimum of 18 inches of well compacted low permeable soil. Liner material shall not contain significant amounts of organic material, frozen material, ice or rocks larger than four inches in diameter and shall not be placed on a frozen surface. The liner shall be placed in horizontal layers not to exceed 6 inches in compacted depth. Each lift shall be compacted by means of controlled travel of compaction equipment so that the

fill area has been uniformly compacted to 95.0% Standard Proctor Density (ASTM D-698) as determined by a testing lab approved by the Engineer. The moisture content at the time of compaction shall be $\pm 2\%$ of optimum moisture content.

Any lenses or seams of sand, gravel or other porous material encountered during excavation for the pond liner shall be over cut and disposed of properly. The over cut shall be to the bottom of the lens or seam or at least two feet. The over cut area shall be refilled and compacted to the same standards as the Holding Pond Embankment. The liner shall then be constructed on top of the over cut fill.

1.7 HOLDING POND INLET STRUCTURES

The inlet structure shall be defined as beginning at the basin riser and including the inlet pipe and splash pad or erosion control as shown on the plans as well as all supports and fasteners. The inlet structures shall be installed to the lines and grades as shown on the plans. The inlet pipe shall be a minimum of 1120 PVC SDR 35 pipe of the size shown in the plans, and shall meet ASTM D1785 or D2241. Pipe compound shall meet ASTM D1784, Class 12454-B. Fittings and appurtenances shall be made of the same material as the pipe. The trench bottom must provide uniform support for the pipe at specified lines and grades. Clods, rocks and other hard objects that may contact the pipe must be removed. Where rocks and other hard objects cannot be completely removed, the trench bottom must be over cut a minimum of four inches and backfilled to grade with compacted fine-grained soil. Initial backfill to six inches above the top of pipe shall consist of soil that is free of rocks, hard clods or other objects more than one inch in diameter. Portions of the trench that pass through a constructed berm shall have side slopes not steeper than 1:1 to allow for adequate compaction of backfill. Earth fill shall be worked and compacted under the haunches of the pipe to provide continuous support in layers not more than six inches thick. Final backfill shall consist of remaining earthfill from the top of the initial backfill to the ground surface, including mounding for settlement. Final backfill shall be free of debris, rocks or other objects with a three inch nominal diameter or larger. All backfill shall be compacted to the same specifications as that portion of the holding pond embankment or sideslope through which it is passing. Portions of the pipe that will be permanently exposed to sunlight must be primed with PVC solvent and painted with two coats of high-quality exterior latex paints.

1.8 BUILDING PAD /DRIVEWAY/ SERVICE ROAD

Earthfill shall be placed to the lines and grades as shown on the plans on all areas for proposed building construction. Compaction shall be performed to each 8 inch loose fill lift by means of a minimum of 6 passes of a standard sheepsfoot roller so that the sheepsfoot roller walks out of each lift to ensure the area has been uniformly compacted; or the compaction shall be performed to each lift by means of controlled travel of loaded rubber-tired compaction equipment or standard sheepsfoot roller so that the fill area has been uniformly compacted to 95% Standard Proctor Density (ASTM D-698) as determined by a testing lab approved by the Engineer. Each pass of soil loading and compaction equipment should travel parallel to the length of the buildings. The moisture

content at the time of compaction for cohesive soils shall be consistent with the requirements of compaction at the optimum moisture content.

If Proctor Density tests are to be performed on-site, a minimum of 2 field density tests per 8 inch lift per building site shall be performed during construction to verify compaction quality or as determined by the Engineer based on compaction results. The compaction tests are to be paid for by the Owner. Nuclear or other standard field density test methods are acceptable for this project. Grade tolerance on building site earthwork shall be -0.10 to +0.10 ft.

1.9 CULVERTS

The Culvert structures shall be installed to the lines and grades as shown on the plans. The culvert shall be ADS N-12 smooth lined corrugated high density polyethylene pipe or equivalent if Class I, II, or III backfill (Angular crushed stone-Clayey sands or sand clay mixtures) is used. If Class IV backfill (inorganic silts-lean clay) is used ADS N-12 High Performance or equivalent shall be used instead. Fittings and appurtenances shall be made of the same material as the pipe.

Stable and uniform bedding shall be provided for the pipe and any protruding features of its joints and or fittings. The middle of the bedding equal to 1/3 of the pipe O.S. should be loosely placed with the remainder compacted to a minimum of 90% standard proctor density. Class I, II, and III materials are suitable for use as bedding. Initial backfill and the haunching is the most important and shall first be worked and compacted under the haunches of the pipe to provide continuous support up to the pipe centerline in layers not more than six inches thick. The remainder of the initial backfill shall then be placed in layers not more than six inches thick. Care must be taken during initial backfill to ensure that tamping or vibratory equipment does not deform or displace the culvert. Class I, II, and III materials are suitable for use in initial backfill and haunches. It is important to use materials that have similar backfill strengths. Final backfill shall consist of the remaining earth fill from the top of the initial backfill to the ground surface, including mounding for settlement. Final backfill shall be free of debris, rocks or other objects with a three inch nominal diameter or larger.

1.10 FENCING

The fencing shall be 4 wire barbed fencing and shall meet local Natural Resource Conservation Service specifications. The fence shall be built in a location and maintained to exclude livestock from the holding pond and to alert people to its location. A sign shall be posted on all sides of the holding pond. The sign shall be constructed of weather resistant materials bearing the wording similar to the following: DANGER, MANURE POND, NO SWIMMING OR HUNTING.

1.11 TOPSOIL

All pond cut and fill areas above the maximum operating elevation, and the entire back slope of the embankment, as well as the top and outside slopes of all settling basins and diversion channels shall be covered with a minimum of 6 inches of topsoil. The topsoil

shall be placed during the normal fill operation, so no additional payment will be made for same. Topsoil shall be worked and bonded to the underlying fill and compacted to the same specifications as the underlying fill. All borrow areas should also be spread with 6 inches of topsoil before the contractor leaves the site.

1.12 GRAVEL-ROAD ROCK

Gravel for access road areas to the locations, dimensions and grades shall be installed as shown on the drawings. Final elevation tolerances are $\pm 0.1'$. Contractor shall have the equipment and ability to transfer elevations from construction stakes and blue tops.

- a) All gravel earthfills shall have a workmanlike finish (i.e. smoothed and graded with proper equipment).
- b) The gravel fill materials, noted in drawings, for roads will have a 5" sub base and a 4" thick cap shall be:
 - 1) Creek Gravel Sub base
Gravel shall have a screened base rock consisting of stones less than 6" in diameter.
 - 2) Road Rock Final Grade
The road rock should meet the requirements as defined by owner.
- c) The gravel shall be compacted in 6" lifts by 2 passes over entire surface with a vibratory roller or rubber tire type compactor.
- d) Gravel shall be leveled and graded with a road grader.
- e) The access road shall be shaped as shown on drawings.

1.13 SEEDING

All ponds cut and fill areas above the maximum operating elevation, and the entire back slope of the embankment, as well as the top and outside slopes of the settling basins and the diversions in their entirety shall be seeded to perennial grass. Grass shall be seeded and fertilized as recommended by the local NRCS field office. All borrow areas should be similarly seeded unless their intended land use dictates otherwise (i.e. farmland).

1.14 LIQUID LEVEL GAGE

A liquid level gage shall be installed in the holding pond at a location that is readily visible. The gage should be constructed of pressure treated wood, noncorrosive metal, PVC or fiberglass and anchored in concrete with divisions marked in one foot increments tied to the design water elevation. Another style of liquid level gage may be used upon approval by the engineer.

1.15 CLEAN UP

During construction the Contractor shall keep the work site, areas adjacent to the work site and access roads in an orderly condition. Any spillage or debris resulting from the Contractor's operations shall be immediately removed. Upon completion, all debris, etc. shall be removed from the area. All access roads, other than public, shall be graded, smoothed over and left in a well-drained condition prior to equipment removal.

2. CONCRETE CONSTRUCTION SPECIFICATION

2.1 SCOPE

The work shall consist of furnishing, forming, placing, finishing, and curing portland cement concrete as required to build the structures described in Section 24 of this specification.

2.2 MATERIALS

Aggregates shall conform to the requirements of Material Specification 522 unless otherwise specified. The grading of coarse aggregates shall be as specified in Section 24.

Portland cement shall conform to the requirements of Material Specification 531 for the specified type.

Fly ash shall conform to the requirements of Material Specification 532.

Air-entraining admixtures shall conform to the requirements of Material Specification 533. If air-entraining cement is used, any additional air-entraining admixture shall be of the same type as that in cement.

Water reducing and/or retarding admixtures shall conform to the requirements of Material Specification 533.

Curing compound shall conform to the requirements of Material Specification 534.

Preformed expansion joint filler shall conform to the requirements of Material Specification 535.

Waterstops shall conform to the requirements of Material Specifications 537 and 538 for the specified kinds.

Water used in mixing and curing concrete shall be clean and free from injurious amounts of oil, salt, acid, alkali, organic matter or other deleterious substances.

2.3 STRENGTH OF CONCRETE

All concrete shall have the minimum compressive strength as specified on the included plans. Compressive strength shall be tested in conformance with Section 6 of this document.

2.4 AIR CONTENT AND CONSISTENCY

Unless otherwise specified in Section 24, the slump shall be 3 to 5 inches. If air entrainment is specified, the air content by volume shall be 5 to 8 percent of the volume of the concrete. When specified, directed or approved by the Engineer or his designated representative, a water-reducing, set-retarding or other admixture shall be used. High Range Water Reducing Agents (Superplasticizers) may be used to increase workability reduce water content and control concrete temperature in hot weather. The maximum slump after adding high range water reducing agents shall be 7-1/2 inches.

2.5 DESIGN OF THE CONCRETE MIX

The proportions of the aggregates shall be such as to produce a concrete mixture that will work readily into the corners and angles of the forms and around reinforcement when consolidated, but will not segregate or exude free water during consolidation.

Fly ash may be used as a partial substitution for Portland cement in an amount not greater than 25 percent (by weight) of the cement in the concrete mix, unless otherwise specified.

2.6 INSPECTION AND TESTING

The Engineer or his designated representative shall have free entry to the plant and equipment furnishing concrete under the contract. Proper facilities shall be provided for the Engineer or his designated representative to inspect materials, equipment and processes and to obtain samples of the concrete. All tests and inspections will be conducted so as not to interfere unnecessarily with manufacture and delivery of the concrete.

Slump and a minimum of 3 cylinders shall be taken at an interval of no more than once each 100 CY of concrete or once per pour, whichever is greater. One cylinder of each set shall be tested at 7 days and one at 28 days. The third shall be kept for re-testing if necessary. If any of the 28-day tests fail to meet the minimum compressive strength specified on the construction plans, the extra cylinder shall be tested. If both the 28-day and the extra cylinder fail to meet the minimum required compressive strength, a minimum of 3 concrete cores shall be taken of the area in question and tested for compressive strength at the contractor's expense. In the event that the compressive strength of the core samples fails to meet the specified minimum, the area in question shall be removed and replaced per Section 20 of this document and retested. As an alternative to removal and replacement, retrofitting options may be submitted to the engineer for approval on a case by case basis.

2.7 HANDLING AND MEASUREMENT OF MATERIALS

Materials shall be stockpiled and batched by methods that will prevent segregation or contamination of aggregates and insure accurate proportioning of the ingredients of the mix.

Except as otherwise provided in Section 8, cement and aggregates shall be measured as follows:

Cement shall be measured by weight or in bags of 94 pounds each. When cement is measured in bags, no fraction of a bag shall be used unless weighed.

Aggregates shall be measured by weight. Mix proportions shall be based on saturated, surface-dry weights. The batch weight of each aggregate shall be the required saturated, surface-dry weight plus the weight of surface moisture it contains.

Water shall be measured, by volume or by weight, to an accuracy within one percent of the total quantity of water required for the batch.

Admixtures shall be measured within a limit of accuracy of three percent.

2.8 MIXERS AND MIXING

Concrete shall be uniform and thoroughly mixed when delivered to the work site. Variations in slump of more than one (1) inch within a batch will be considered evidence of inadequate mixing and shall be corrected by increasing mixing time or other acceptable alternative.

For stationary mixers, the mixing time after all cement and aggregates are in the mixer drum shall be not less than 1-1/2 minutes. When concrete is mixed in a truck mixer, the number of revolutions of the drum or blades at mixing speed shall be not less than 70 nor more than 100.

No mixing water in excess of the amount called for by the job mix shall be added to the concrete during mixing or hauling or after arrival at the delivery point.

2.9 FORMS

Forms shall be of wood, plywood, steel or other approved material and shall be mortar tight. The forms and associated falsework shall be substantial and unyielding and shall be constructed so that the finished concrete will conform to the specified dimensions and contours. Form surfaces shall be smooth and free from holes, dents, sags or other irregularities. Forms shall be coated with a non-staining form release agent before being set into place.

Metal ties or anchorages within the forms shall be equipped with cones, she-bolts or other devices that permit their removal to a depth of at least one inch without injury to the concrete. Ties designed to break off the surface of the concrete shall not be used

without cones.

All edges that will be exposed to view when the structure is completed shall be chamfered, unless finished with molding tools as specified in Section 18.

2.10 PREPARATION OF FORMS AND SUBGRADE

Prior to placement of concrete, the forms and subgrade shall be free of chips, sawdust, debris, water, ice, snow, extraneous oil, mortar, or other harmful substances or coatings and the temperature of all surfaces to be in contact with the new concrete shall be not be less than 40°F. Any oil on the reinforcing steel or other surfaces required to be bonded to the concrete shall be removed. Rock surfaces shall be cleaned by air-water cutting, wet sandblasting or wire brush scrubbing, as necessary, and shall be wetted immediately prior to placement of concrete. Placement of concrete on mud, dried earth or un-compacted fill or frozen subgrade will not be permitted. Earth surfaces shall be firm and damp. Granular subgrade material, if required, shall be graded and compacted as described in Section 24 of this specification.

Items to be embedded in the concrete shall be positioned accurately and anchored firmly.

Weepholes in walls or slabs shall be formed with nonferrous materials.

2.11 CONVEYING

Concrete shall be delivered to the site and discharged into the forms within 1-1/2 hours after the introduction of the cement to the aggregates. In hot weather or under conditions contributing to quick stiffening of the concrete, the time between the introduction of the cement to the aggregates and discharge shall not exceed 45 minutes.

The Engineer or his designated representative may allow a longer time, provided the setting time of the concrete is increased a corresponding amount by the addition of an approved set-retarding admixture. In any case, concrete shall be conveyed from the mixer to the forms as rapidly as practicable by methods that will prevent segregation of the aggregates and no loss of mortar occurs.

2.12 PLACING

The Contractor shall give reasonable notice to the Engineer or his designated representative each time he intends to place concrete. Such notice shall provide sufficient time for the Engineer or his designated representative to inspect the subgrade, forms, steel reinforcement and other preparations for compliance with the specifications. "Other preparations" include but are not limited to the concrete mixing plant, delivery equipment system, placing, finishing, and curing equipment and system, schedule of work, workforce, heating or cooling facilities if applicable. Deficiencies are to be corrected before concrete is delivered for placing.

When placing the concrete, it shall be conveyed to the forms in such a manner to prevent

segregation of aggregates. The concrete shall be deposited as closely as possible to its final position in the forms and shall be worked into the corners and angles of the forms and around all reinforcement and embedded items in a manner to prevent segregation of aggregates or excessive laitance. Formed concrete shall be placed in horizontal layers not more than 20 inches thick. Concrete shall not be dropped more than 10 feet vertically unless suitable equipment is used to prevent segregation. When high range water reducing agents are used, the concrete shall not be allowed to drop more than 15 feet. Hoppers and chutes, pipes or "elephant trunks" shall be used as necessary to prevent segregation and the splashing of mortar on the forms and reinforcing steel above the layer being placed.

Immediately after the concrete is placed in the forms, it shall be consolidated by spading, hand tamping or vibration as necessary to insure smooth surfaces and dense concrete. Each layer shall be consolidated to insure monolithic bond with the preceding layer. If the surface of a layer of concrete in-place sets to the degree that it will not flow and merge with the succeeding layer when spaded or vibrated, the Contractor shall discontinue placing concrete and shall make a construction joint according to the procedure specified in Section 13.

If placing is discontinued when an incomplete horizontal layer is in place, the unfinished end of the layer shall be formed by a vertical bulkhead.

2.13 CONSTRUCTION JOINTS

Construction joints shall be made at the locations shown on the drawings. If construction joints are needed which are not shown on the drawings, they shall be placed in locations approved by the Engineer or his designated representative.

Where a feather edge would be produced at a construction joint, as in the top surface of a sloping wall, an insert form shall be used so that the resulting edge thickness on either side of the joint is not less than 6-inches.

In walls and columns, as each lift is completed, the top surfaces shall be immediately and carefully protected from any condition that might adversely affect the hardening of the concrete.

Steel tying and form construction adjacent to concrete in-place shall not be started until the concrete has cured at least 12-hours. Before new concrete is deposited on or against concrete that has hardened, the forms shall be re-tightened. New concrete shall not be placed until the hardened concrete has cured at least 12-hours.

Surfaces of construction joints shall be cleaned of all unsatisfactory concrete, laitance, coatings or debris by washing and scrubbing with a wire brush or wire broom or by other means approved by the Engineer or his designated representative. The surfaces shall be kept moist for at least one hour prior to placement of the new concrete.

2.14 EXPANSION AND CONTRACTION JOINTS

Expansion and contraction joints shall be made only at locations shown on the drawings.

Exposed concrete edges at expansion and contraction joints shall be carefully tooled or chamfered, and the joints shall be free of mortar and concrete. Joint filler shall be left exposed for its full length with clean and true edges.

Preformed expansion joint filler shall be held firmly in the correct position as the concrete is placed.

When open joints are specified, they shall be constructed by the insertion and subsequent removal of a wooden strip, metal plate or other suitable template in such a manner that the corners of the concrete will not be chipped or broken. The edges of open joints shall be finished with an edging tool prior to removal of the joint strips.

2.15 WATERSTOPS

Waterstops shall be held firmly in the correct position as the concrete is placed. Joints in metal waterstops shall be soldered, brazed or welded. Joints in rubber or plastic waterstops shall be cemented, welded or vulcanized as recommended by the manufacturer. Joints shall be watertight and of a strength equivalent to that specified in Material Specification 537. Intersecting waterstop joints shall be prefabricated and supplied by the same manufacturer providing the waterstop.

2.16 REMOVAL OF FORMS

Forms shall be removed in such a way as to prevent damage to the concrete. Supports shall be removed in a manner that will permit the concrete to take the stresses due to its own weight uniformly and gradually.

2.17 FINISHING FORMED SURFACES

Immediately after the removal of the forms:

- a. All fins and irregular projections shall be removed from exposed surfaces.
- b. Unless otherwise specified in Section 24, the holes produced on all surfaces by the removal of form ties, cone-bolts, and she-bolts shall be cleaned, wetted and filled with a dry-pack mortar consisting of one part portland cement, three parts sand that will pass a No. 16 sieve, and just sufficient water to produce a consistency such that the filling is at the point of becoming rubbery when the material is solidly packed.

2.18 FINISHING UNFORMED SURFACES

All exposed surfaces of the concrete shall be accurately screeded to grade and then float

finished, unless specified otherwise.

Excessive floating or troweling of surfaces while the concrete is soft will not be permitted.

The addition of dry cement or water to the surface of the screeded concrete to expedite finishing will not be allowed.

Joints and edges on unformed surfaces that will be exposed to view shall be chamfered or finished with molding tools.

2.19 CURING

Concrete shall be prevented from drying for a curing period of at least 7 days after it is placed. Exposed surfaces shall be kept continuously moist for the entire period, or until curing compound is applied as specified below. Moisture shall be maintained by sprinkling, flooding or fog spraying or by covering with continuously moistened canvas, cloth mats, straw, sand or other approved material. Wood forms left in-place during the curing period shall be kept continuously wet. Formed surfaces shall be thoroughly wetted immediately after forms are removed and shall be kept wet until patching and repairs are completed. Water or covering shall be applied in such a way that the concrete surface is not eroded or otherwise damaged.

Concrete, except at construction joints, may be coated with the approved curing compound in lieu of continued application of moisture, except as otherwise specified in Section 24. The compound shall be sprayed on the moist concrete surfaces as soon as free water has disappeared, but shall not be applied to any surface until patching, repairs and finishing of that surface are completed. The compound shall be applied at a uniform rate of not less than one gallon per 175 square feet of surface and shall form a continuous adherent membrane over the entire surface. Curing compound shall be thoroughly mixed before applying and continuously agitated during application. Curing compound shall not be applied to surfaces requiring bond to subsequently placed concrete, such as construction joints, shear plates, reinforcing steel and other embedded items. If the membrane is damaged during the curing period, the damaged area shall be re-sprayed at the rate of application specified above. Surfaces covered by the membrane shall not be trafficked unless protected from wear.

2.20 REMOVAL AND REPLACEMENT OR REPAIR

When concrete is honeycombed, damaged or otherwise defective, the Contractor shall remove and replace the structure or structural member containing the defective concrete or, where feasible, correct or repair the defective parts. The Engineer or his designated representative will determine the required extent of removal, replacement or repair. Prior to starting repair work the Contractor shall obtain the Engineer's or his designated representative's approval of his plan for effecting the repair. The Contractor shall perform all repair work in the presence of the Engineer or his designated representative.

2.21 CONCRETING IN COLD WEATHER

Concrete shall not be mixed nor placed when the daily minimum atmospheric temperature is less than 40°F unless facilities are provided to prevent the concrete from freezing or appropriate non-chloride based accelerators are used. If accelerators or antifreeze compounds are planned to be used, the Engineer shall be notified at least 2 days prior to their use for review.

2.22 CONCRETING IN HOT WEATHER

The Contractor shall apply effective means to maintain the temperature of the concrete below 90°F during mixing, conveying and placing.

2.23 MEASUREMENT AND PAYMENT

For items of work for which specific unit prices are established in the contract, concrete will be measured to the neat lines shown on the drawings and the volume of concrete will be computed to the nearest 0.1 cubic yard. Measurement of concrete placed against the sides of an excavation without the use of intervening forms will be made only to the neat lines or pay limits shown on the drawings. No deduction in volume will be made for chamfers, rounded or beveled edges or for any void or embedded item that is less than five (5) cubic feet in volume.

Payment for each item of structure concrete will be made at the contract unit price or the contract lump sum, whichever is applicable, for that item. Such payment will constitute full compensation for all labor, materials, equipment, transportation, tools, forms, falsework, bracing and all other items necessary and incidental to the completion of the work, except items listed for payment elsewhere in the contract.

Compensation for any item of work described in the contract but not listed in the bid schedule will be included in the payment for the item of work to which it is made subsidiary. Such items and the items to which they are made subsidiary are identified in Section 24 of this specification.

2.24 ITEMS OF WORK AND CONSTRUCTION DETAILS

Items of work to be performed in conformance with this specification and the construction details therefore are:

2.24.1 Reinforced Concrete

2.24.1.1 This item shall consist of furnishing and placing concrete as shown in the plans.

2.24.1.2 Cement shall be Type I, IA (air-entrained), II or IIA (air-entrained).

2.24.1.3 Concrete shall be air-entrained. The air content (by

volume) of the concrete at time of placement shall be 5 to 8 percent.

- 2.24.1.4 The gradation of the coarse aggregate shall be Size No. 57 as defined in ASTM C-33.
- 2.24.1.5 At least 30% of the total weight of aggregate shall be coarse aggregate crushed limestone.
- 2.24.1.6 Slump shall be 3" plus or minus 1" for concrete without admixtures. If water reducing agents the maximum slump may be increased to 7.5".
- 2.24.1.6 The temperature of the concrete at the time of placement shall not be less than 40oF nor greater than 90oF.
- 2.24.1.7 Non-shrink grout shall be used everywhere that grouting is required.
- 2.24.1.8 The contractor shall be required to have, as a minimum, two mechanical vibrators in working condition for consolidation of concrete on the site during concrete placement operations.
- 2.24.1.9 The granular subgrade shall meet the Nebraska Department of Roads gradation 47B (fine aggregate for concrete), and shall be compacted as follows:
 - 2.24.1.9.1 The subgrade material shall be thoroughly wet prior to compaction.
 - 2.24.1.9.2 Compaction shall be accomplished while the material is wet from the above step.
 - 2.24.1.9.3 The subgrade shall be compacted by 2 (minimum) passes of a hand-directed, vibratory compactor over the entire surface.
- 2.24.1.7 Payment for concrete will be made as per agreement between the Contractor and Cooperator, which may or may not be a contract lump sum price.

2.24.2 Subsidiary Item, Waterstops

This item shall consist of furnishing and installing the waterstops as shown on the drawings. Separate payment will not be made for waterstops, as compensation

will be considered in the payment for concrete.

2.24.3 Subsidiary Item, Grouting between gang slat panels

This item shall consist of furnishing and placing grout between the gang slat panels as described on the drawings. Separate payment will not be made for grouting, as compensation will be considered in the payment for concrete.

2.24.4 Subsidiary Item, Grouting between slat support girders

This item shall consist of furnishing and placing grout between the slat support girders as described on the drawings. Separate payment will not be made for grouting, as compensation will be considered in the payment for concrete.

3. STEEL REINFORCEMENT FOR CONCRETE CONSTRUCTION SPECIFICATION

3.1 SCOPE

The work shall consist of furnishing and placing steel reinforcement for reinforced concrete or pneumatically applied mortar.

3.2 MATERIALS

Steel reinforcement shall conform to the requirements of Material Specification 539. Before reinforcement is placed, the surfaces of the bars and fabric and any metal supports shall be cleaned to remove any loose, flaky rust, mill scale, oil, grease or other undesirable coatings or foreign substances. Epoxy-coated steel reinforcement shall be free of surface damage. After placement, the reinforcement shall be maintained in a clean and serviceable condition until it is completely embedded within the concrete.

3.3 BAR SCHEDULE, LISTS AND DIAGRAMS

Any supplemental bar schedules, bar lists or bar-bending diagrams required in Section 10 of this specification to accomplish the fabrication and placement of steel reinforcement shall be provided by the Contractor. Prior to placement of reinforcement, the Contractor shall furnish four copies of any such lists or diagrams to the Engineer or his designated representative for approval. Acceptance of the reinforcement will not be based on approval of these lists or diagrams, but will be based on inspection of the steel reinforcement after it has been placed, tied, supported and ready to receive concrete.

3.4 BENDING

Reinforcement shall be cut and bent in compliance with the requirements of the American Concrete Institute Standard 315. Bars shall not be bent or straightened in a manner that will injure or weaken the material. Bars with kinks, cracks or improper bends will be rejected.

3.5 SPLICING BAR REINFORCEMENT

Locations for splices of reinforcement shall be left to the judgment of the Contractor. Splice lengths shall meet the requirements of ACI Standard 318 "Building Code Requirements for Reinforced Concrete" and are given in Section 10 of this specification. Locations where splices of reinforcement are not allowed are described in Section 10 of this specification.

3.6 SPLICING WELDED WIRE FABRIC

Unless otherwise specified, welded wire fabric shall be spliced in the following manner:

- a. Adjacent sections shall be spliced end to end (longitudinal lap) by

overlapping a minimum of one full mesh plus two (2) inches plus the length of the two end overhangs. The splice length is measured from the end of the longitudinal wires in one piece of fabric to the end of the longitudinal wire in the lapped piece of fabric.

- b. Adjacent sections shall be spliced side to side (transverse lap) a minimum of one full mesh plus two (2) inches. The splice length shall be measured from the centerline of the first longitudinal wire in one piece of fabric to the centerline of the first longitudinal wire in the lapped piece of fabric.

3.7 PLACING

Reinforcement shall be accurately placed and secured in position in a manner that will prevent its displacement during the placement of concrete. Tack welding of bars will not be permitted. Metal chairs, metal hangers, metal spacers and concrete chairs may be used to support the reinforcement. Metal hangers, spacers and ties shall be placed in such a manner that they will not be exposed in the finished concrete surface. The legs of metal chairs or side form spacers that may be exposed on any face of slabs, walls, beams or other concrete surfaces shall have a protective coating or finish by means of hot dip galvanizing, epoxy coating, plastic coating, or be stainless steel. Metal chairs and spacers not fully covered by a protective coating or finish shall have a minimum cover of 3/4 inch of concrete over the unprotected metal portion except for those with plastic coatings may have a minimum cover of 1/2 inch of concrete over the unprotected metal portion. Pre-cast concrete chairs shall be manufactured of the same class of concrete as specified for the structure and shall have the tie wires securely anchored in the chair or a V-shaped groove at least 3/4 inch in depth molded into the upper surface to receive the steel bar at the point of support. Pre-cast concrete chairs shall be clean and moist at the time concrete is placed.

High density or structural plastic rebar accessories, designed to insure maximum concrete bond, may be substituted for metal or concrete accessories in spacer applications as approved by the Engineer or his designated representative. Exposure of plastic rebar accessories at the finished concrete surface shall be kept to a minimum. Plastic rebar accessories, when used, shall be staggered along adjacent parallel bars and shall be placed at intervals no closer than twelve (12) inches. Plastic rebar accessories shall not be used in concrete section six (6) inches or less in thickness.

3.8 STORAGE

Steel reinforcement stored at the work site shall be placed on platforms, skids or other supports and in a manner that contact with the ground is avoided and be protected from mechanical damage and/or corrosion.

3.9 MEASUREMENT AND PAYMENT

For items of work for which specific unit prices are established in the contract, the weight of steel reinforcement placed in the concrete in accordance with the drawings will be

determined to the nearest pound by computation from the placing drawings. Measurement of hooks and bends will be based on the requirements of ACI Standard 315. Computation of weights of reinforcement will be based on the unit weights established in Tables 34-1 and 34-2 of this specification. Computation of weights for welded wire fabric not shown in Table 34-2 shall be based on ACI Standard 315. The area of welded wire fabric reinforcement placed in the concrete in accordance with the drawings will be determined to the nearest square foot by computation from the placing drawings with no allowance for required laps. The weight of steel reinforcing in extra splices or extra-length splices approved for the convenience of the Contractor or the weight of supports and ties will not be included in the measurement for payment.

Payment for furnishing and placing reinforcing steel will be made at the contract unit price. Such payment will constitute full compensation for all labor, materials, equipment and all other items necessary and incidental to the completion of the work including preparing and furnishing bar schedules, lists or diagrams; furnishing and attaching ties and supports; and furnishing, transporting, storing, cutting, bending, cleaning and securing all reinforcements.

Compensation for any item of work described in the contract, but not listed in the bid schedule, will be included in the payment for the item of work to which it is made subsidiary. Such items to which they are made subsidiary are identified in Section 10 of this specification.

Bar Size No.	Weight (lb./ft.)
3	0.376
4	0.668
5	1.043
6	1.502
7	2.044
8	2.670
9	3.400
10	4.303
11	5.313
14	7.650
18	13.600

<i>Style Designation</i>		
By Steel Wire Gauge	By W-Number	(lb./100 Sq. Ft.)
6 x 6 - 10 x 10	6 x 6 - W1.4 x W1.4	21
6 x 6 - 8 x 8	6 x 6 - W2.1 x W2.1	30
6 x 6 - 6 x 6	6 x 6 - W2.9 x W2.9	42
6 x 6 - 4 x 4	6 x 6 - W4.0 x W4.0	58

4 x 4 - 10 x 10	4 x 4 - W1.4 x W1.4	31
4 x 4 - 8 x 8	4 x 4 - W2.1 x W2.1	44
4 x 4 - 6 x 6	4 x 4 - W2.9 x W2.9	62
4 x 4 - 4 x 4	4 x 4 - W4.0 x W4.0	85
4 x 12 - 8 x 12	4 x 12 - W2.1 x W0.9*	25
4 x 12 - 7 x 11	4 x 12 - W2.5 x W1.1*	31

NOTE: Style Designation is defined in ACI Standard 315 of the American Concrete Institute.

*Welded smooth wire fabric with wires smaller than Size W1.4 is manufactured from galvanized wire.

3.10 ITEMS OF WORK AND CONSTRUCTION DETAILS

Items of work to be performed in conformance with this specification and the construction details therefore are:

3.10.1 Reinforcing Steel

- 3.10.1.1 This item shall consist of furnishing and placing reinforcing steel as shown on the plans.
- 3.10.1.2 All reinforcing steel (bars and wire mesh) shall be Grade 60.
- 3.10.1.3 Splice lengths shall be 25", 33", and 41" for #3, #4, and #5 bars respectively.
- 3.10.1.4 There shall be no splicing of the bars in the endwall beam (the heavily reinforced section of the endwall near the top) unless the splice occurs directly behind the center of the girder/endwall connection.
- 3.10.1.5 If any shop drawings are developed, copies will be given to the Engineer for review prior to construction.
- 3.10.1.6 Payment for reinforcing steel will be made as per agreement between the Contractor and Cooperator, which may or may not be a contract lump sum price.

4. QUALITY ASSURANCE PROGRAM

4.1 LINES OF AUTHORITY

- 4.1.1 The ENGINEER will act in the capacity of the OWNER and will ensure the project is completed according to the DRAWINGS and SPECIFICATIONS.
- 4.1.2 The CONTRACTOR shall keep on the work site a copy of current DRAWINGS and SPECIFICATIONS.
- 4.1.3 In case of conflict between the DRAWINGS and SPECIFICATIONS, the SPECIFICATIONS shall govern. Figured dimensions on DRAWINGS shall govern over general DRAWINGS.
- 4.1.4 Any discrepancies found between the DRAWINGS and SPECIFICATIONS and site conditions or any inconsistencies or ambiguities in the DRAWINGS or SPECIFICATIONS shall be immediately reported to the ENGINEER, who shall promptly correct such inconsistencies or ambiguities.

4.2 SPECIALIZED SKILLS OR WORK QUALIFICATIONS

- 4.2.1 Any testing or inspection conducted will be under the approval of the ENGINEER.
- 4.2.2 All sampling and testing will be conducted by an authorized representative of the ENGINEER or by a testing company approved to conduct tests as specified in the SPECIFICATIONS.

4.3 OBSERVATION AND OVERSIGHT DUTIES

- 4.3.1 The ENGINEER or his representative will stake out the construction of the facility.
- 4.3.2 The construction will be inspected by the ENGINEER or his assigned representative.
- 4.3.3 During the construction of the following components the ENGINEER will have a representative on site.
 - 4.3.3.1 Placement of Reinforcement in floor
 - 4.3.3.2 Pouring of concrete floor
 - 4.3.3.3 Reinforcement of concrete wall and columns.

4.3.3.4 Pouring of concrete wall and columns.

4.3.4 After finished construction, the site will be measured by the ENGINEER to ensure it was constructed as planned.

4.4 TEST PROCEDURES, FREQUENCIES AND REPORTING

4.4.1 The Construction of the Site will meet the SPECIFICATIONS identified in this section.

4.4.2 The Concrete placement will be tested as identified in the SPECIFICATIONS under section F.2.6. Slump and a minimum of 3 cylinders shall be taken at an interval of no more that once each 100 CY of concrete or once per pour, whichever is greater. If the slump is not between 3 to 5 inches the concrete should be refused until it is the correct slump. One cylinder of each set shall be tested at 7 days and one at 28 days. The third shall be kept for re-testing if necessary. If any of the 28-day tests fail to meet the minimum compressive strength specified on the construction plans, the extra cylinder shall be tested. If the both the 28-day and the extra cylinder fail to meet the minimum required compressive strength, a minimum of 3 concrete cores shall be taken of the area in question and tested for compressive strength at the contractor's expense

4.4.3 A final certification and report will be conducted by the ENGINEER to ensure that the facility is within + 5 % in dimensions and that the liner as well as all critical components were constructed according to the DRAWINGS and SPECIFICATIONS.

Section G: Operation and Maintenance
Guideline

SECTION G: OPERATION & MAINTENANCE GUIDELINE

The owner acknowledges responsibility for the proper operation and maintenance of the animal waste management system. Although the design is based on the best available technical knowledge, it must be recognized that any system creates some risks, and therefore needs to be properly operated and maintained, including periodic inspection. In addition, maximum efficiency cannot be obtained unless the system is properly operated and maintained so that it will function safely in its intended manner.

Recognizing this, this Manual has been prepared as a general guideline for operating and maintaining the system. This Manual is not inclusive of all of the provisions of the General Water Pollution Control Permit for Concentrated Animal Feeding Operations, therefore the owner should review the permit in its entirety.

It is recommended that the following list be reviewed and be used as a checklist to ensure major elements of operation and maintenance are consistently being observed.

I. General Considerations

- A. Any discharge from the waste management system or land application sites must be reported as soon as possible, but no later than twenty-four hours after the discharge was discovered. The discharge must be reported to the State of Arkansas at (800) 322-4012.
- B. All inspections should be documented on the forms included with this manual or other suitable forms. Documentation must be maintained on site and be made available to the ADEQ when requested.
- C. Travel of vehicles and livestock should be confined to designated areas to prevent erosion and enhance vegetation.
- D. Maintain grades around containment structures to assure positive surface drainage away from the structures in all directions. Fill any settled areas which may collect water.
- E. Any discovered damage to any facility component must be repaired as soon as possible to original specifications.
- F. Do not allow trees to grow adjacent to holding ponds, to avoid root damage to the structures.

- G. Manage vegetation growth on and near facility components so that adequate component inspection is possible.
- H. Control vegetation growth on the holding pond interior below the must Pumpdown elevation to prevent liner damage from roots.
- I. Maintain the overall system (i.e. pens, building covers, diversion channels, stacking pads settling basins and risers) to ensure that all contaminated runoff enters the containment structures.

II. Waste Application Considerations

- A. Land application must be planned and carried out to prevent holding pond levels from rising above the Must Pumpdown elevation. In the event that this level is exceeded, the producer has 14 pump-able days to restore the pond to a level at or below the Must Pumpdown elevation as required by the AR regulations.
- B. Whenever possible, apply downwind from any residences. Avoid applying on calm, humid days, since these conditions restrict the dispersion and dilution of odors. Application on weekends or holidays, when people in the area are more likely to be outdoors, should also be avoided.
- C. Do not apply waste on snow or frozen ground unless unavoidable. Consult Regulation 5 for conditions that must be followed in these circumstances
- D. Do not apply waste material immediately after rain or within twelve hours of forecasted rain unless it can be immediately incorporated into the soil.

III. Inspection and Documentation

- A. Items to be Performed Daily
 - 1. Year Round
 - a. Record any measurable precipitation.
 - b. Record the date that livestock are brought in to and removed from the facility.
 - 2. During Periods of Land Application
 - a. Record the days each field is applied to, as well as weather conditions including; temperature and wind speed and direction.
 - b. Inspect and record the condition of the land application fields being used.
 - c. Inspect and record the condition of all land application equipment

being used.

- d. Inspect and record the condition of the holding pond liner and embankment near the pump intake if pumping is taking place.

B. Items to be Performed Weekly

The entire Waste Management System must be inspected weekly. This includes but is not limited to the following.

1. Record the depth of water in all evaporative ponds.
2. Inspect risers and pipe to ensure they are not plugged or damaged. Clean any significant sediment build up as soon as possible.
3. Inspect evaporative ponds for signs of leaking or seepage, excessive settling, excessive vegetation growth or damage due to vehicles or equipment, rodents or erosion. Report any leakage as detailed above and make plans to rectify any problems as soon as possible.
4. Inspect fences and safety signs around facility, if applicable, to ensure they are present and in good condition. If necessary repair immediately.
5. Record any livestock mortalities and how the carcasses were properly disposed of.(i.e. rendering service receipt, location of burial, etc.)

C. Items to be Performed Annually

1. Conduct soil and manure nutrient testing as required by the Nutrient Management Plan.
2. Prepare an annual Nutrient Management Plan based on current data.
3. Prepare and submit a report to the ADEQ on the form provided by ADEQ by the date instructed.

IV. Items pertaining to the control of odors, flies and other nuisances

- A. As much as is reasonable, standing water and wet pen conditions shall be prevented or eliminated by routine pen maintenance.
- B. Mortalities shall be promptly disposed of in an appropriate manner (composting).
- C. If insects become problematic, a pesticide program will be undertaken for control.

V. Record Keeping

- A. The following items should be kept on site at all times.
 1. Copy of the approved General Water Pollution Control Permit for Concentrated Animal Feeding Operations Application.
 2. Copy of current nutrient management plan.

- B. The following items should be kept on site for a period of 5 years from the date they are created.
1. Inspection reports from all inspections listed above.
 2. Soil and manure nutrient test results.
 3. Calculations of allowable manure application rates and actual rates applied.
 4. Documentation of any action taken to correct deficiencies.
 5. Documentation of any discharge, steps taken to minimize it and the estimated volume discharged.

I have reviewed the above Operation and Maintenance Manual for my Waste Management System and agree to provide the necessary resources to properly implement its provisions.

JASON HENSON
Operator

6-5-12
Date

**C&H Hog Farms
Application for Permit to Construct and Operate a
Livestock Waste Control Facility**

LAST PAGE

**MAP(S)/PLAN(S) SCANNED IN
SEPARATE FILE**

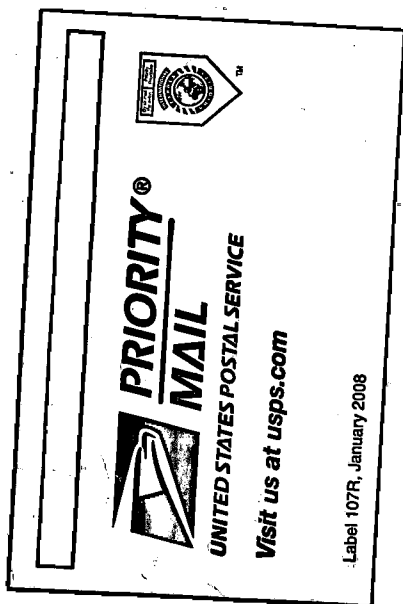

DeHaan, Grabs & Associates, LLC
PO Box 522
Mandan ND 58554



Richard McConnell
Arkansas Dept of Env Quality
5301 Northshore Drive
North Little Rock AR 72118-5317

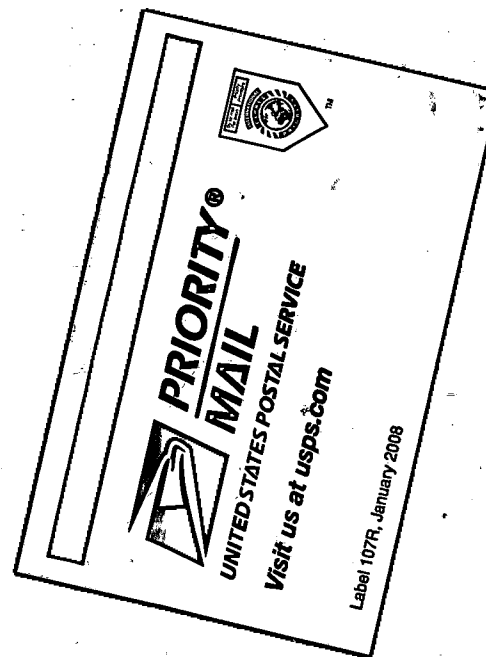



**DeHaan, Grabs
& Associates, LLC**

Consulting Engineers

www.dgaengineering.com

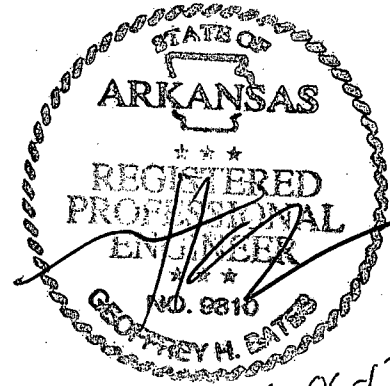

06-06-12

**Nutrient
Management Plan
For
C&H Hog Farms
Newton County, AR**

Prepared by DeHaan, Grabs & Associates, LLC,

May 2012

North Dakota Office

P.O. Box 522

Mandan, ND 58554-0522

(701) 663-1116

Fax (701) 667-1356

Nutrient Management Plan Table of Contents

A. Introduction

1. Narrative for Nutrient Management Plan
2. Signature Page
3. Contact Information
4. References Page
5. Local County Ordinances

B. Nutrient Utilization Plan

C. Land Application Calculations

1. Land Application Calculation Spreadsheet
2. Phosphorus Index & RUSLE 2 Calculations
3. 5 Year Crop Rotation, Yield Goals & Crop Nutrient Uptake

D. Phosphorus Based Field list

E. Inventory of Water Wells

F. Land Treatment Information and Land Application Maps

1. Waste Utilization Summary Sheet
2. Overall Site Map
3. WQRA Maps
4. Soil Survey Maps

G. Signed Manure Application Lease Agreements

H. Soil Test Reports

I. Nutrient Tests Results and How to

J. Mortality Disposal Actions

K. Livestock Feed Management

L. Odor Control

M. Waste Storage Pond Pumping Plan

N. Record Keeping and Land Application Log Forms

1. Manure Source Details
2. Annual Report Form for Permitted Confined Animal Facilities
3. Previous Manure Applications and Nitrogen Credits
4. Calculating Residual/Supplemental Nitrogen Amounts
5. Fertilizer Recommendations and Crop Requirements
6. Determining the Manure Application Rate
7. Animal Waste Land Application Record for Permitted Confined Animal Facilities



Section A: Introduction

NARRATIVE FOR C&H HOG FARMS NUTRIENT MANAGEMENT PLAN

This Nutrient Management Plan was developed for C&H Hog Farms. The farm located approximately 1.6 miles to the west of Mt. Judea AR. Driving directions from Mt. Judea is approximate 0.8 miles southwest on County Rd 54 and right on County rd 41 approximately 0.75 miles. The site is located on the left hand side of the road on a logging trail. The legal location is Section 26, Township 15 North, Range 20 West, Newton County, Arkansas. This Nutrient Management Plan was developed as a joint effort between C&H Hog Farms, the Natural Resources Conservation, and DeHaan, Grabs & Associates, LLC.

The total available for crop uptake of N (18,497 lbs) and available P₂O₅ (14,213 lbs) produced annually by the livestock was determined by DeHaan, Grabs & Associates, LLC using Arkansas Nutrient Management Planner with 2009 PI. The Waste Storage Ponds have capacity of 3,495,464 gallons (this includes the shallow pits). The Waste Storage Ponds have capacity at the Must Pumpdown Elevation of 2,469,903 gallons. The volume between the Freeboard and the Must Pumpdown Elevation is 35,564 gallons. Effluent from Waste Storage Pond 1 will be applied through a Vac Tanker, whereas the effluent from Waste Storage Pond 2 will applied through a traveling gun and a permanent pipeline. The rate will be calculated in accordance to the crop needs using the Nutrient Management Planner with 2009 PI. The NMP includes 670.4 acres of agricultural land, most of which is available for manure application. After excluded acres the land available is approximately 630.7 acres. The typical crops grown are native grass (Bermudagrass and Fescue) either taken off as rotated pasture or hay. When calculating projected land base requirements and RUSLE 2 calculations, predicted crop yield goals was used. When calculating annual nutrient application needs, actual yields on a per field basis will be used.

The record keeping section is important for the proper application of nutrients from the facility. Records of commercial fertilizer will also be maintained. The facility will maintain the following documentation from each application of manure or wastewater: current soil sample analysis, current manure or wastewater analysis, records showing equipment calibration, a Water Quality Risk Assessment (WQRA) map showing actual area application, and a completed Arkansas Nutrient Management Planner summary showing calculated application rate.

Nutrient Management Plan

The Nutrient Management Plan (NMP) is an important part of the conservation management system (CMS) for your Animal Feeding Operation (AFO). This NMP documents the planning decisions and operation and maintenance for the animal feeding operation. It includes background information and provides guidance, reference information and Web-based sites where up-to-date information can be obtained. Refer to the Producer Activity document for information about day-to-day management activities and recordkeeping. Both this document and the Producer Activity document shall remain in the possession of the producer/landowner.

Farm contact information: C&H Hog Farms, (Jason Henson)

870-688-1318
HC 72 PO Box 10
Mount Judea, AR 72655

Latitude/Longitude: 35, 55', 13.60" & -93, 4' 51.0"

Plan Period: 2012-2017

Animal Type: Swine

Animal Units: 999

Owner/Operator

As the owner/operator of this NMP, I, as the decision maker, have been involved in the planning process and agree that the items/practices listed in each element of the NMP are needed. I understand that I am responsible for keeping all the necessary records associated with the implementation of this NMP. It is my intention to implement/accomplish this NMP in a timely manner as described in the plan.

Signature: Jason Henson

Date: 6-5-12

Name: Jason Henson

Conservation Planner

As a Conservation Planner, I certify that I have reviewed both the Nutrient Management Plan and Producer Nutrient Management Activities documents for technical adequacy and that the elements of the documents are technically compatible, reasonable and can be implemented.

Signature: Nathan A. Pesta

Date: June 1, 2012

Name: Nathan A. Pesta, P.E.

Title: Senior Project Engineer

Manure and Wastewater Handling and Storage

Signature: Geoffrey H. Bates

Date: June 6-2012

Name: Geoffrey H. Bates, P.E.

Title: President

Nutrient Management

The Nutrient Management component of this plan meets the AR Nutrient Management 590 Practice Standard.

Signature: Geoffrey H. Bates

Date: June 6-2012

Name: Geoffrey H. Bates P.E.

Title: President

Sensitive data as defined in the Privacy Act of 1974 (5 U.S.C. 552a, as amended) is contained in this report, generated from information systems managed by the USDA Natural Resources Conservation Service (NRCS). Handling this data must be in accordance with the permitted routine uses in the NRCS System of Records at http://www.nrcs.usda.gov/about/foia/408_45.html. Additional information may be found at http://www.ocio.usda.gov/qi_request/privacy_statement.html.

The U.S. Department of Agriculture (USDA) prohibits discrimination in all its programs and activities on the basis of race, color, national origin, age, disability, and where applicable, sex, marital status, familial status, parental status, religion, sexual orientation, genetic information, political beliefs, reprisal, or because all or a part of an individual's income is derived from any public assistance program. (Not all prohibited bases apply to all programs.) Persons with disabilities who require alternative means for communication of program information (Braille, large print, audiotope, etc.) should contact USDA's TARGET Center at (202) 720-2600 (voice and TDD). To file a complaint of discrimination write to USDA, Director, Office of Civil Rights, 1400 Independence Avenue, S.W., Washington, D.C. 20250-9410 or call (800) 795-3272 (voice) or (202) 720-6382 (TDD). USDA is an equal opportunity provider and employer.

NUTRIENT MANAGEMENT PLAN CONTACT INFORMATION

1. **Facility:**
NAME: C&H Hog Farms
ADDRESS: HC 72 PO Box 10
Mount Judea, AR 72655
PHONE NUMBER: (870) 688-1318
EMAIL: jasonh@rittermail.com
MANAGER: Jason Henson

2. **Owners:**
NAME: Jason Henson
ADDRESS: HC 72 PO Box 10
Mount Judea, AR 72655
PHONE NUMBER: (870) 715-9468

3. **NMP Developed by:** DeHaan, Grabs & Associates, LLC
NAME: Nathan A. Pesta
ADDRESS: P.O. Box 522
Mandan, ND 58554
PHONE NUMBER: (701) 663-1116
CELL NUMBER: (701) 400-3950

4. **Legal Location of Facility**
Middle, Section 26, T-15-N, R-20-E, Newton County, AR

NUTRIENT MANAGEMENT PLAN INFORMATION

Type of Livestock:..... Swine
Number of head: 6503
Average Weight:.....153.6 lbs

Total Number of
Acres Included in NMP after excluded acres:.....630.7 acres

References

The nutrient management plan was developed based on compliance criteria described in the following documents:

- Arkansas Pollution Control and Ecology Commission Regulation 5 dated March 28, 2008

- USDA, Natural Resources Conservation Service (NRCS) conservation practice standard Nutrient Management ("590") dated December 2004

- _____ County zoning ordinance for animal feeding operations dated/amended

Land Base

The nutrient management plan has sufficient land base to meet land application on a Nitrogen (N)-based for fields 5-9. Fields 1-4 and 10-17 are in addition and will be applied on a Phosphorus (P)-based manure application rate. P-based levels for spreading manure generally requires a significantly greater land base the N-based. When necessary, fields targeted for phosphorus-based manure application are identified in the Manure Application Planning section of this plan.

Local Zoning Ordinances

Operator Name: C&H Hog Farms County: Newton

The livestock operator is responsible for complying with all local ordinances. The operator shall address all of the following items and ensure any local requirements are met and/or included in this plan.

1. Does the county have any ordinances that require special permitting or approvals for siting animal feeding operations or land application of manure? ___ Yes X No

If yes, has the county permitted or approved this site? ___ Yes ___ No

If no, do you intend to get approval or obtain local permits prior to land application of manure? ___ Yes ___ No

Application of manure cannot occur until the operator obtains all local approvals.

2. Is the land application area, or any portion, located within the jurisdictional area of a city or town? ___ Yes X No

If yes, does the city or town have any special permitting for siting animal feeding operations or application of manure within their jurisdictional area? ___ Yes X No

If yes, has the city or town permitted or approved this site? ___ Yes ___ No

If no, do you intend to get approval or obtain local permits prior to land application of manure? ___ Yes ___ No

Application of manure cannot occur until the operator obtains local approval.

3. Are there specific setback distances that the county or city requires for application of manure? (For example, some local governments require specific setbacks from residences and public right-of-ways.) ___ Yes X No

If yes, show the applicable setbacks on the required field maps and exclude these areas from the total number of acres.

4. Is the land application site located in a wellhead protection area? ___ Yes X No

If yes, the producer needs to contact the local county, city or public water supply official to discuss specific requirements.

(Operator Signature)

(Date)

Section B: Nutrient Utilization Plan

B. NUTRIENT UTILIZATION PLAN

The Following is in this section:

1. Location
2. Record Keeping
3. Soil Sampling
4. Manure Sampling
5. Nutrient Budget for Land Application
6. Timing, Rate, and Frequency of Liquid and Solid Manure Applications
7. Land Application of Liquid Manure
8. Amounts of Nitrogen Applied
9. Solid Accumulation in the Retention Storage Pond
10. Check Valves/Safety Switches
11. Effluent/Solids Easement Agreement
12. Prevention of Destruction of Endangered or Threatened Species
13. Setback Requirements
14. Typical Crops Grown and Crop Yields for the Land Application Areas
15. Nutrient Utilization Plan Amendments

B. NUTRIENT UTILIZATION PLAN

1. **Location**

This plan is for C& H Hog Farms which is located in Newton County, Arkansas with a legal description of Section 26, Township 15 North, Range 20 West.

2. **Record Keeping.**

- a. A liquid manure pumping data sheet will be completed at the end of all pumping events by the person(s) responsible for monitoring the application event.

The pumping data sheet will include calculations for rate, gallons applied, hours of application time, type of crop applied to, method of application and total acres to be applied.

- b. A solids manure application data sheet will be completed at the end of all land application events by the person(s) responsible for monitoring the application event.

The application data sheet will include calculations for rate, cubic feet or tons applied, type of crop applied to, method of application and total acres to be applied.

- c. During Periods of Land Application, daily inspections shall be conducted and record the following

- 1) Record the days each field is applied to, as well as weather conditions including; temperature, wind speed and wind direction.
- 2) Inspect and record the condition of the land application fields being used.
- 3) Inspect and record the condition of all land application equipment being used.
- 4) Inspect and record the condition of the waste storage pond liner and embankment near the pump intake if pumping is taking place

- d. Inspections after Rainfall events shall be conducted and record the following:

- 1) Record the depth of the water in all retention ponds.
- 2) Inspect risers and pipe to ensure they are not plugged or damaged. Clean any significant sediment build up as soon as possible.
- 3) Inspect storage ponds for signs of leaking or seepage, excessive settling, excessive vegetation growth or damage due to vehicles or equipment, rodents or erosion. Report any leakage as detailed above and make plans to rectify any problems.

- 4) Inspect fences and safety signs around the facility, if applicable, to ensure they are present and in good condition. If necessary repair immediately.
 - 5) Record any livestock mortalities and how the carcasses were properly disposed of. (i.e. rendering service receipts, location of burial, etc.)
- f. Annual inspections shall be conducted and record the following.
- 1) Conduct soil and manure testing as required by this plan.
 - 2) Prepare an annual Nutrient Management Plan based on current data.
 - 3) Annual reporting should be completed as referenced in http://www.adeq.state.ar.us/water/forms_inst.htm
3. **Soil Sampling.**
- a. Composite base-line soil test samples for a new facility or a new land application area and land receiving liquid manure will be taken at least annually.
 - b. Soil samples will be taken before the land application of liquid and solids manure to determine the manure application rate appropriate to the land application area.
 - c. Samples will be taken as follows:
 - 1) At least 20 cores taken to a depth of 24 inches shall be collected for each field.
 - a) One composite sample shall consist of the top six inches of no fewer than 20 combined. The other sample shall be the remaining six to 24 inches of at least 6-8 combined.
 - b) Phosphorus, copper and zinc shall be tested from the combined top six inches of the cores from a field.
 - c) Nitrate-N and chloride shall be tested from the combined six to 24 inches of the cores from a field.
 - d) The core composite portions of any sample, when mixed together, shall represent the field at the depths from the cores.
 - e) The soil samples shall be taken at least every 40 acres.

- 2) The samples will then be mixed in a plastic bucket (not metal) to form a representative composite sample for the field.
- 3) A subsample will be taken from the mixed composite and placed in the cloth bag provided by the analytical laboratory.
- 4) Soil samples for Nitrate-N and Phosphorus shall be taken no less than annually. The soil samples shall be certified by the person taking the samples as being a representative sample of the soil and of the nutrient values of the field being tested.
- 5) A copy of the certification of each composite soil sample and the laboratory results for each sample shall be maintained in the office of the facility and made available to the Department of Health or designee upon inspection. The certification will show the date the sample was taken, the approximate locations in the field from which the cores were taken, the depth or depths of the cores that constitutes the sample, the name of the person who took the sample and the date the sample delivered to a laboratory.

4. **Manure Sampling.**

- a. Manure samples in conjunction with soil samples, will be taken prior to land application to determine land application rate.
- b. Liquid and solid manure samples will be analyzed by a certified laboratory for pH, total dissolved salts, potassium, total nitrogen, ammonium-nitrogen and phosphorus.

5. **Nutrient Budget for Land Application.**

- a. Nutrient loss due to volatilization, evaporation, and crop uptake will be accounted for each time liquid manure is applied to the land application area.
- b. In addition, communications with the farmer(s) will ensure proper planning of commercial fertilizer applications with liquid manure applications so that excess nutrients will not be applied to the land.

6. **Timing, Rate, and Frequency of Liquid and Solid Manure Applications.**

- a. Liquid and solid manure will be applied at agronomic rates.

Weather conditions and nutrient holding capacity of the soil will determine the timing and rate of application.

- b. Liquid and solid manure will not be applied to land classified as highly erodible according to the conservation compliance provisions of the Federal Food Security Act of 1985, saturated or frozen ground, or during a rainfall event.

Most land applications will be conducted in the spring, summer and fall.

- c. Liquid manure will not be applied to land classified as highly erodible according to the conservation compliance provisions of the Federal Food Security Act of 1985, saturated or frozen ground, or during a rainfall event.

Most land applications will be conducted in the spring, summer and fall.

- d. Land application will be conducted in a manner which will prevent a discharge or drainage of manure to ground or surface waters of the State.
- e. Land application practices are managed so as to reduce or minimize ponding or puddling of liquid manure on the site, contamination of ground or surface waters, and occurrence of nuisance conditions such as odors, flies, and rodents.
- f. Land application practices will minimize the possibility of contamination of surface and groundwaters of the State.

7. Land Application of Liquid Manure

- a. Careful scheduling of the land application activities will reduce the threat of odor emissions to residents near the facility.
- b. Days with low humidity are best for land application.
 - Applications on holidays and weekends when people are most likely to be outdoors will be avoided when possible.
- c. The use of sprinkler for land application will be one of the methods for liquid application. The use of a vactanker and equipment to knife inject or spread the nutrients on top the land for land application will be one of the methods for land application.

8. Amounts of Nitrogen Applied.

- a. Liquid manure will typically be applied at agronomic rates for nitrogen, however, the phosphorus application will follow the Arkansas Nutrient Management Planner phosphorous index risk assessment to ensure that the phosphorus levels are not becoming a risk to surface water pollution.
 - b. Calculations for quantity of liquid manure that can be applied to agronomic rates to crop production land are performed by the staff soil scientist or or land application formulas prepared by University of Arkansas Extension.
 - c. $\text{Max. application (lbs/ac)/Manure N Content (lbs/ac-in)} = \text{Max. manure application (ac-in)}$.
 - d. $\text{Acres for application} \times \text{Max. manure application (ac-in)} \times 27154 = \text{Max. pumping volume (gallons)}$.
 - e. The spreadsheet log for land application can be utilized for land application calculations.
9. **Solid Accumulation in the Retention Storage Pond.**
- a. The design and operation of the waste storage pond at the facility provides for desludging during each waste removal.
 - b. If or when pond desludging becomes necessary, Jason Henson- will land apply the solids at agronomic rates and in accordance with local, state, and federal regulations.

- c. Solids will be land farmed utilizing available technology at the time of application.
10. **Check Valves/Safety Switches**
 - With the utilization of subsoil land application equipment, the use of check valves/safety switches are not necessary.
 11. **Effluent/Solids Easement Agreement.**
Easements are found in Section G
 12. **Prevention of Destruction of Endangered or Threatened Species.**
 - a. Animal manure handling, treatment and management plans are designed with the intention of reducing any harm or destruction of endangered or threatened species or contribute to the taking of any federally endangered or threatened species of plant, fish, or wildlife; nor interfere with or cause harm to migratory birds.
 - b. C&H Hog Farms will notify the appropriate fish and wildlife agency in the event of any significant fish, wildlife, or migratory bird/endangered species kill or die-off on or near a retention pond or in the field where waste has been applied and which could reasonably have resulted from waste management at the facility.
 13. **Setback Requirements.**
 - a. Manure shall not be applied any closer than a 100 feet to any down-gradient surface waters, open tile line intake structures, sinkholes, agricultural well heads or other conduits to surface waters.
 - b. Incorporate surface applications of solid forms of manure or some commercial fertilizer nitrogen formulations (i.e. Urea) into the soil within 24 hours of application.
 - c. When applying liquid forms of manure with irrigation equipment select application conditions when there is high humidity, little/no wind blowing, a forth coming rainfall event, and or other conditions that will minimize volatilization losses into the atmosphere. The basis for applying manure under these conditions shall be documented in the nutrient management plans.
 14. **Typical Crops Grown and Crop Yields for the Land Application Areas:**
 - a. Pasture – 6.5 tons/acre
 - b. Hay - 6.5 tons/acres

15. **Nutrient Utilization Plan Amendments.**

- a. This plan may be amended when it fails to provide for protection of environmental resources or as appropriate.
- b. This plan will also need to be amended with Arkansas DEQ approval when one of the following conditions exist:
 - 1) Additional land to which waste will be applied is not described in the approved plans.
 - 2) A procedure will be used that is not described in an approved plan.
 - 3) Land described in an approved plan is no longer available for nutrient application.

Section C: Land Application Calculations

SECTION C. Land Application Calculations

The following Information is attached

1. Land Application Calculation Spreadsheet
2. Phosphorus Index & RUSLE 2 Calculations
3. Yield Goal & Crop Nutrient Uptake

C. Land Application CalculationsC&H Hog Farms
01-Jun-12**1. Estimate the total nutrients (NPK) in the excreted manure.**

Nutrients per storage period = # of animals x weight (lbs) x daily nutrient production (lb/day/1,000 lb)

	# of Animals	Average Weight (lbs.)	Daily Nutrient Production (lb/day/1,000 lbs)	Storage Period	Total Nutrients
Nitrogen					
Farrowing Sows	400	425	0.47	365	29,164
Breeding/Gestation	2100	375	0.19	365	54,613
Boars	3	450	0.15	365	74
Nursery Pigs	4000	10	0.60	365	8,760
Finisher Pigs	0	150	0.42	365	0
Total Nitrogen	6,503				92,611
Phosphorus					
Farrowing Sows	400	425	0.15	365	9,308
Breeding/Gestation	2100	375	0.063	365	18,109
Boars	3	450	0.05	365	25
Nursery Pigs	4000	10	0.25	365	3,650
Finisher Pigs	0	150	0.16	365	0
Total Phosphorus	6,503				31,091
Potassium					
Lactating Sows	400	425	0.3	365	18,615
Breeding/Gestation	2100	375	0.123	365	35,355
Boars	3	450	0.10	365	49
Nursery Pigs	4000	10	0.35	365	5,110
Finisher Pigs	0	150	0.22	365	0
Total Potassium	6,503				59,129

2. Add nutrients contained in wastewater.

Nutrients in the wastewater = Number of animals x daily wastewater production (gal./day/cow) x daily nutrient production (lb/day/1,000 gal)

	# of Animals	Daily Wastewater Production (gal./day/cow)	Daily Nutrient Production (lb/day/1,000 gal)	Storage Period	Total Nutrients
Nitrogen					
Farrowing Sows	400	0	0	365	0
Breeding/Gestation	2100	0	0	365	0
Boars	3	0	0	365	0
Nursery Pigs	4000	0	0	365	0
Finisher Pigs	0	0	0	365	0
Total Nitrogen	6,503				0
Phosphorus					
Farrowing Sows	400	0	0	365	0
Breeding/Gestation	2100	0	0	365	0
Boars	3	0	0	365	0
Nursery Pigs	4000	0	0	365	0
Finisher Pigs	0	0	0	365	0
Total Phosphorus	6,503				0
Potassium					
Farrowing Sows	400	0	0	365	0
Breeding/Gestation	2100	0	0	365	0
Boars	3	0	0	365	0
Nursery Pigs	4000	0	0	365	0
Finisher Pigs	0	0	0	365	0

Total Potassium 6,503

0

Total Nutrients Produced

Total N	92,611 lbs
Total P	31,091 lbs
Total K	59,129 lbs

Convert to Fertilizer Form

Total N	92,611 lbs
Total P ₂ O ₅	71,198 lbs
Total K ₂ O	71,546 lbs

3. Subtract nutrients lost during storage

Nutrients after storage losses = Total nutrients produced x fraction retained = Amount for land applic

Solids (assume 0% of nutrients retained in solids)

Item	Nutrients (lbs)	Percent of Orig.	Available for Land Application (lbs)
Total N	0	0.65	0
Total P ₂ O ₅	0	0.80	0
Total K ₂ O	0	0.80	0

Liquids (assume 100% of nutrients retained in liquids)

Item	Nutrients (lbs)	Percent of Orig.	Available for Land Application (lbs)
Total N	92,611	0.73	67,143
Total P ₂ O ₅	71,198	0.85	60,518
Total K ₂ O	71,546	0.85	60,814

4. Determine the plant available nutrients

Estimate the amount of nutrients that will be available each year after the third consecutive year of a
 Plant available nutrients = Amount applied x fraction available

Solids (assume 0% of nutrients retained in solids)

Item	Nutrients (lbs)	Percent Avail.	Available for Land Application (lbs)
Total N	0	0.73	0
Total P ₂ O ₅	0	0.90	0
Total K ₂ O	0	0.93	0

Liquids (assume 100% of nutrients retained in liquids)

Item	Nutrients (lbs)	Percent Avail.	Available for Land Application (lbs)
Total N	67,143	0.73	49,014
Total P ₂ O ₅	60,518	0.90	54,466
Total K ₂ O	60,814	0.93	56,557

5. Determine the nutrients required by the crop and soil to produce the yield goal

5a (1). Estimate the amount of nutrients removed by the crop using table 6-6.

Assume using an average of Bermudagrass (3.25 tons/acre) x (2 cuttings)

Nutrient Uptake

N	244.4 lbs/acre
P	24.7 lbs/acre
K	182 lbs/acre

Convert to Fertilizer Form

N	244 lbs/acre
P ₂ O ₅	57 lbs/acre
K ₂ O	220 lbs/acre

5a (2). Add to the plant requirements additional nitrogen to replace anticipated denitrification losses

SECTION C2: DESIGN CALCULATIONS

Waste Production Calculations

A. Facility Information

1. Type of Construction: existing, proposed-new, or expansion

2. Building Area, **Barn 1 Gestation Barn** (Proposed): 421.3 feet by 117.5 feet
Barn 2 Farrowing Barn (Proposed): 367.1 feet by 82.5 feet

3. Animal Capacity	<u>3</u> head of <u>Boars</u>	@	<u>450</u> lbs,	<u>1,350</u> lbs Total
	<u>2,100</u> head of <u>Gestation Sows</u>	@	<u>375</u> lbs,	<u>787,500</u> lbs Total
	<u>400</u> head of <u>Lactating Sow</u>	@	<u>425</u> lbs,	<u>170,000</u> lbs Total
(maximum head counts and average weights)	<u>4,000</u> head of <u>Nursery Pig</u>	@	<u>10</u> lbs,	<u>40,000</u> lbs Total
	_____ head of _____	@	_____ lbs,	_____ lbs Total

Total: 6,503 head

Total Animal Weight (TAW): 998,850 lbs

B. Determine Minimum Storage Requirement

The Minimum Storage Requirement is the sum of the animal waste produced (or treatment volume for an anaerobic lagoon), plus the spillage and washwater, plus the pit recharge produced in 180 days. Generally, outside or contributing drainage area runoff is to be diverted. Runoff which is not diverted must be included in the storage requirement.

The following is completed for either **Liquid Manure Storage** or **Anaerobic Lagoon**

Liquid Manure Storage

Unit Waste Production (UWP) in cubic feet per day per 1,000 pounds of animal:

<u>Cattle</u>	<u>Swine</u>	<u>Poultry</u>	<u>Other</u>
<input type="checkbox"/> Dairy = 1.3	<input checked="" type="checkbox"/> Nursery Pig = 1.4	<input type="checkbox"/> Layers = 0.9	<input type="checkbox"/> Horse = 0.8
<input type="checkbox"/> Beef = 1.0	<input type="checkbox"/> Grower/Finisher = 1.0	<input type="checkbox"/> Broiler = 1.3	<input type="checkbox"/> Sheep = 0.6
	<input checked="" type="checkbox"/> Boar/Gestating Sow = 0.41	<input type="checkbox"/> Turkey = 0.7	
	<input checked="" type="checkbox"/> Sow and Litter = 0.97		

(a) Manure produced: (TAW x (UWP x 180 days/1,000)) = 97,979 cubic feet / 1,000 lbs
 (TAW x UWP for each type calculated separately and added to find total manure produced)

(b) Spillage and Washwater generated in 180 days: 19,596 cubic feet
 (If unknown, 20% of (a) is used)

(c) Total Manure plus Spillage and Washwater, (a)+(b): 117,575 cubic feet.

Rainfall Data

(d) 25 Year- 24 Hour Rainfall Event: 0.58 Feet

- (e) Precipitation-Evaporation October 1 – April 1) 0.92 Feet
- (f) Top of Waste Storage Pond 1 20,857 Square feet
- (g) Top of Waste Storage Pond 2 35,262 Square feet

- (h) Waste Storage Pond 1 25 Yr-24 Hr Storage Requirement (d) x (f): 12,097 cubic feet
- (i) Waste Storage Pond 2 25 Yr-24 Hr Storage Requirement (d) x (g): 20,452 cubic feet
- (j) Waste Storage Pond 1, 180 Day Net Precip. Requirement (e) x (f): 19,119 cubic feet
- (k) Waste Storage Pond 2, 180 Day Net Precip. Requirement (e) x (g): 32324 cubic feet

Recharge Water -The farrowing barn will be pulled once every three weeks and the Gestation Barn will be pulled once every five weeks on a conservative estimate and will be recharged with 2" of fresh water .

- (l) Recharge Water Produced Average: 366(cubic feet per day) x 180 (180 days in storage period)
= 65,880 cubic feet per 180 days.

Runoff

- (m) Sand Lane and Stacking Pad Area: _____ feet x _____ feet = _____ square feet
- (n) Manure Stacking Pad Area: _____ feet x _____ feet = _____ square feet
- (o) Feed Stacking Pad Area: _____ feet x _____ feet = _____ square feet
- (p) Total Runoff Area: _____ square feet
- (q) Minimum Runoff (Figure 1 from Appendix): _____ inches

NOTE: If a covered storage is used which collects runoff, then the sum of the 25 year, 24 hour storm runoff and the expected runoff for the 180 day storage period is used as the Minimum Runoff in (m).

- (r) Minimum Runoff Storage Requirement (l) x (m)/12 = _____ cubic feet

Minimum Overall Storage Requirement

- (s) Minimum Storage Requirement (c or g) + (h) + (n): 279,436 cubic feet

Waste Storage Calculations

A. Determine Storage Provided

Type of storage: Earthen Storage Pit Earthen Lagoon Concrete Tank
 Underfloor Concrete Pit Outside Concrete Pit
 Other (describe) _____

NOTE: A scale drawing, calculations and other supporting information will be included. Indicate the location of all diversions, diversion dimensions, and flow directions of surface runoff for the entire facility. Concrete pit or tank storage is assumed to be covered unless specified otherwise.

Rectangular Concrete Pit or Tank (capacity = length x width x depth)

$$\begin{aligned} & \underline{420.3} \text{ feet} \times \underline{114.3} \text{ feet} \times \underline{1.5} \text{ feet} = \underline{72,060} \text{ cubic feet (Manure Pit \#1)} \\ & \underline{227.3} \text{ feet} \times \underline{76.3} \text{ feet} \times \underline{1.7} \text{ feet} = \underline{29,483} \text{ cubic feet (Manure Pit \#2)} \\ & \hspace{15em} = \underline{101,543} \text{ cubic feet TOTAL} \end{aligned}$$

Waste Storage Pond 1 Volume = $[(4 \times \text{sideslope}^2 \times \text{depth}^3) / 3] + (\text{sideslope} \times \text{bottomlength} \times \text{depth}^2) + (\text{sideslope} \times \text{bottomwidth} \times \text{depth}^2) + (\text{bottomwidth} \times \text{bottomlength} \times \text{depth})$

Bottom Length: _____ Bottom Width: _____
 Design Full Depth: 9.7 feet, Overflow Depth: 10.7 feet
 Side Slopes: 3 :1 and 3 , End Slopes: 3 :1 and 3 :1

Note: Inside slopes for earthen pits or lagoons will be at least 2:1.

Earthen Storage Pit or Lagoon Capacity: 111,122 cubic feet

Waste Storage Pond 2 Volume = $[(4 \times \text{sideslope}^2 \times \text{depth}^3) / 3] + (\text{sideslope} \times \text{bottomlength} \times \text{depth}^2) + (\text{sideslope} \times \text{bottomwidth} \times \text{depth}^2) + (\text{bottomwidth} \times \text{bottomlength} \times \text{depth})$

Bottom Length: _____ Bottom Width: _____
 Design Full Depth: 11.7 feet, Overflow Depth: 12.7 feet
 Side Slopes: 3 :1 and 3 , End Slopes: 3 :1 and 3 :1

Note: Inside slopes for earthen pits or lagoons will be at least 2:1.

Earthen Storage Pit or Lagoon Capacity: 254,643 cubic feet

NOTE: A minimum of 1.0 foot of freeboard is required for uncovered storage.

TOTAL STORAGE PROVIDED: 467,308 cubic feet

NOTE: The Total Storage Provided will meet or exceed the Minimum Storage Requirement (item o) from Waste Productions Calculation

5 Year Crop Rotation & Yield Goal & Crop Nutrient Needs

Table 1. 5 Year Crop Rotation

Years	Fields	Commodity
One-Five	1, 2, & 4	Bermudagrass teamed with Tall Fescue, Rotational Pasture
One-Five	3 & 5-17	Bermudagrass teamed with Tall Fescue, Hay

Table 2. Plant Nutrient Uptake

County	State	Commodity	#Yield Goals (Tons)	% of the Dry Harvested Material			Nutrient Uptake, lb of nutrients		
				N	P	K	N	P	K
Newton	NORTH DAKOTA	#FORAGE, HAY (BERMUDAGRASS)	6.5	1.88	0.19	1.4	244.4	24.7	182
McHenry	NORTH DAKOTA	#FORAGE, ROTATIONAL PASTURE (BERMUDAGRASS)	6.5	1.88	0.19	1.4	244.4	24.7	182

* From Table 6.6 of Part 651 Agricultural Waste Mangement Field Handbook

#U of A Cooperative Extension Service, yield goal for Northern Arkansas

Table 3. Convert Plant Nutrient Needs (N, P, K) to Fertilizer Form

	Hay	Pasture
N	244.4	244.4
P ₂ O ₅	56.6	56.6
K ₂ O	220.2	220.2

Comments:

Arkansas Nutrient Management Planner with 2009 PI (ver 3/3/2010)

Planner:	Nathan A. Pesta, P.E.	Date:	5/25/2012
Plan Description:	Jason Henson: Fields 1-10		

This worksheet is intended to assist in the writing of Nutrient Management Plans for the application of manure to pasture and hay land. To do this, the worksheet estimates the litter production for the farm, estimates the P Index risk value for the defined conditions of each field, assists with the allocation of nutrients to the various receiving fields, and estimates the amount of litter available for off farm use. This worksheet is the result of an effort to develop a reliable training/planning tool faithful to the 2009 Arkansas P Index developed by a multi-agency effort. However, no guarantees are made, and any observed problems or suggestions for improvement should be directed to Karl VanDevender at kvan@uaex.edu.

County Information

Farm county	Newton
R	270
10-Yr EI	110
Kf adjusted for frost?	Yes

Nutrient Source and Description Information

Manure Source	Source Type	Amount Available		N Concentration		P2O5 Concentration		K2O Concentration		Water Extractible P		Alum Used?
WSP#1	Liquid Biosolids	1230	1000 gal	37.60	lb/1000 gal	28.90	lb/1000 gal	29.10	lb/1000 gal	1.90	lb/1000 gal	No
WSP#2	Liquid Manure	1531	1000 gal	30.20	lb/1000 gal	23.20	lb/1000 gal	23.40	lb/1000 gal	0.07	lb/1000 gal	No

Nutrient Loss and Mineralization Factors

Nutrient Source Description	N		P2O5		K2O	
	Storage Losses (%)	Appl. Losses (%)	Storage Losses (%)	Appl. Losses (%)	Storage Losses (%)	Appl. Losses (%)
WSP#1	60%	50%	80%		80%	
WSP#2	60%	50%	80%		80%	

Estimated Plant Available Nutrients

Nutrient Source Description	N		P2O5		K2O		Water Extractible P	
	Concentration	Total (lb)	Concentration	Total (lb)	Concentration	Total (lb)	Concentration	Total (lb)
WSP#1	7.52 lb/1000 gal	9,250	5.78 lb/1000 gal	7,109	5.82 lb/1000 gal	7,159	1.90 lb/1000 gal	2337
WSP#2	6.04 lb/1000 gal	9,247	4.64 lb/1000 gal	7,104	4.68 lb/1000 gal	7,165	0.07 lb/1000 gal	107.17
Totals		18,497		14,213		14,324		2,444

Field P Index Calculations

Field	Soil Test P		Soil Map Unit	Slope Gradient (%)				Slope Length (ft)				Flooding Frequency
	ppm	lb/ac		Min	Max	Rep	Used	Min	Max	Rep	Used	

Comments:

Arkansas Nutrient Management Planner with 2009 PI (ver 3/3/2010)

Planner:	Nathan A. Pesta, P.E.	Date:	5/25/2012
Plan Description:	Jason Henson: Fields 1-10		

H1	83	110	42	3	8	5	5.5	15	75	45	45	None
H2	72	96	43	8	20	14	14	15	30	20	45	None
H3	42	56	48	0	3	2	14	15	75	45	23	Occasional
H4	50	67	43	8	20	14	14	15	30	20	23	None
H5	65	86	48	#N/A	#N/A	#N/A	0.2	#N/A	#N/A	#N/A	5	#N/A
H6	76	101	48	#N/A	#N/A	#N/A	0.2	#N/A	#N/A	#N/A	4	#N/A
H7	178	237	48	#N/A	#N/A	#N/A	0.2	#N/A	#N/A	#N/A	4	#N/A
H8	46	61	51	2	5	2.5	3.5	15	75	45	12	None
H9	52	69	50	#N/A	#N/A	#N/A	0.2	#N/A	#N/A	#N/A	7	#N/A
H10	69	92	51	2	5	2.5	3.5	15	75	45	15	None

Field	Field Area (ac)	Buffer Length (ft)	Buffer Width (ft)	Appl Area (ac)	Predominate Vegetation	Percent Ground Cover	Conservation Support Practices (P)	RUSLE 1 (ton/ac)	RUSLE 2 (ton/ac)
H1	19.70	1,800	100	15.57	Grass	95-100	None in place	0.12	0.18
H2	19.30	1,000	100	17.00	Grass	95-100	None in place	0.34	6.60
H3	15.90	1,000	100	13.60	Grass	95-100	None in place	0.24	0.01
H4	10.40	700	100	8.79	Grass	95-100	None in place	0.28	5.40
H5	24.90	500	100	23.75	Grass	95-100	None in place		0.05
H6	36.60	900	100	34.53	Grass	95-100	None in place		0.05
H7	79.80	2,400	100	74.29	Grass	95-100	None in place		1.10
H8	15.50			15.50	Grass	95-100	None in place	0.06	1.30
H9	45.10	1,680	100	41.24	Grass	95-100	None in place		0.49
H10	34.30	500	100	33.15	Grass	95-100	None in place	0.06	1.30
	302			277					

Field	Pasture Use	Application Method	Application Timing	Nutrient Source	Application Rate		Pre BMP PI Value	P Index Range	Target Post BMPs PI Values
H1	Rotational Grazing	Surface Applied	March-June	WSP#1	25.00	1000 gal/ac	65	Medium	
H2	Rotational Grazing	Surface Applied	March-June	WSP#1	9.90	1000 gal/ac	80	High	
H3	Hayland	Surface Applied	March-June	WSP#1	10.00	1000 gal/ac	47	Medium	
H4	Rotational Grazing	Surface Applied	March-June	WSP#1	9.90	1000 gal/ac	75	High	
H5	Hayland	Surface Applied	March-June	WSP#2	81.00	1000 gal/ac			
H6	Hayland	Surface Applied	March-June	WSP#2	81.00	1000 gal/ac			
H7	Hayland	Surface Applied	March-June	WSP#2	81.00	1000 gal/ac			
H8	Hayland	Surface Applied	March-June	WSP#2	81.00	1000 gal/ac	56	Medium	
H9	Hayland	Surface Applied	March-June	WSP#2	81.00	1000 gal/ac			
H10	Hayland	Surface Applied	March-June	WSP#1	18.00	1000 gal/ac	52	Medium	

Comments:

Arkansas Nutrient Management Planner with 2009 PI (ver 3/3/2010)

Planner:	Nathan A. Pesta, P.E.	Date:	5/25/2012
Plan Description:	Jason Henson: Fields 1-10		

Best Management Practices

Field	Diversion	Terrace	Pond	Filter Strip	Grassed Waterway	Fencing	Riparian Forest Buffer	Riparian Herbaceous Cover	Field Borders	Post BMP PI Value	P Index Range
H1										65	Medium
H2										80	High
H3										47	Medium
H4										75	High
H5											
H6											
H7											
H8										56	Medium
H9											
H10										52	Medium

Field Nutrient Application Planning

Per Acre Basis

Field	Nutrient Source	Application			Nutrient Recommendation (lb/ac)			Nutrients Applied (lb/ac)			Surpluses / Deficits (lb/ac)		
		PI Max	Planned		N	P2O5	K2O	N	P2O5	K2O	N	P2O5	K2O
H1	WSP#1	25.00	25.00	1000 gal/ac	489	57	220	188	145	146	-301	88	-75
H2	WSP#1	9.90	9.90	1000 gal/ac	489	57	220	74	57	58	-415	0	-162
H3	WSP#1	10.00	10.00	1000 gal/ac	489	57	220	75	58	58	-414	1	-162
H4	WSP#1	9.90	9.90	1000 gal/ac	489	57	220	74	57	58	-415	0	-162
H5	WSP#2	81.00	81.00	1000 gal/ac	489	57	220	489	376	379	0	319	159
H6	WSP#2	81.00	81.00	1000 gal/ac	489	57	220	489	376	379	0	319	159
H7	WSP#2	81.00	81.00	1000 gal/ac	489	57	220	489	376	379	0	319	159
H8	WSP#2	81.00	81.00	1000 gal/ac	489	57	220	489	376	379	0	319	159
H9	WSP#2	81.00	81.00	1000 gal/ac	489	57	220	489	376	379	0	319	159
H10	WSP#1	18.00	18.00	1000 gal/ac	489	57	220	135	104	105	-354	47	-115

Per Field Basis

Field	Nutrient Source	Application			Nutrient Recommendation (lbs)			Nutrients Applied (lbs)			Surpluses / Deficits (lb)		
		PI Max	Planned		N	P2O5	K2O	N	P2O5	K2O	N	P2O5	K2O
H1	WSP#1	389.19	389.19	1000 gal	7,613	887	3,425	2,927	2,250	2,265	-4,686	1,362	-1,160
H2	WSP#1	168.34	168.34	1000 gal	8,315	969	3,741	1,266	973	980	-7,049	4	-2,761
H3	WSP#1	136.04	136.04	1000 gal	6,653	775	2,993	1,023	786	792	-5,629	11	-2,201
H4	WSP#1	87.05	87.05	1000 gal	4,300	501	1,934	655	503	507	-3,645	2	-1,428
H5	WSP#2	1923.92	1923.92	1000 gal	11,615	1,354	5,225	11,621	8,927	9,004	6	7,573	3,778
H6	WSP#2	2797.24	2797.24	1000 gal	16,887	1,968	7,597	16,895	12,979	13,091	8	11,011	5,494
H7	WSP#2	6017.52	6017.52	1000 gal	36,328	4,235	16,344	36,346	27,921	28,162	18	23,687	11,818
H8	WSP#2	1255.50	1255.50	1000 gal	7,580	884	3,410	7,583	5,826	5,876	4	4,942	2,466
H9	WSP#2	3340.70	3340.70	1000 gal	20,168	2,351	9,074	20,178	15,501	15,634	10	13,150	6,561
H10	WSP#1	596.74	596.74	1000 gal	16,211	1,890	7,293	4,487	3,449	3,473	-11,724	1,559	-3,820
Totals					135,669	15,814	61,037	102,981	79,115	79,784	-32,688	63,301	18,747

Comments:

Arkansas Nutrient Management Planner with 2009 PI (ver 3/3/2010)

Planner:	Nathan A. Pesta, P.E.	Date:	5/25/2012
Plan Description:	Jason Henson: Fields 1-10		

**Manure Distribution Summary
Units Applied by Field and Source**

Field	Source			
	WSP#1 (1000 gal)	WSP#2 (1000 gal)		
H1	389.19			
H2	168.34			
H3	136.04			
H4	87.05			
H5		1,923.92		
H6		2,797.24		
H7		6,017.52		
H8		1,255.50		
H9		3,340.70		
H10	596.74			
Total Applied	1,377	15335		
Available	1,230	1531		
Deficit/Surplus	-147	-13804		

Supplemental Documentation of Inputs and Results for P Index and RUSLE Calculations

Field	H1	H2	H3	H4	H5	H6	H7	H8	H9	H10
Soil Map Unit	42	43	48	43	48	48	48	51	50	51
Soil Name	Noark very c	Noark very c	Razort loam,	Noark very c	Soil Name C	Soil Name C	Soil Name C	Spadra loam	Soil Name C	Spadra loam
Primary Litter Source	WSP#1	WSP#1	WSP#1	WSP#1	WSP#2	WSP#2	WSP#2	WSP#2	WSP#2	WSP#1
Source Type	Liquid Biosol	Liquid Biosol	Liquid Biosol	Liquid Biosol	Liquid Manur	Liquid Manur	Liquid Manur	Liquid Manur	Liquid Manur	Liquid Biosol
WEP (lb/ton)	1.9	1.9	1.9	1.9	0.07	0.07	0.07	0.07	0.07	1.9
TP Used (lb/ton)	12.6200873	12.6200873	12.6200873	12.6200873	10.1310044	10.1310044	10.1310044	10.1310044	10.1310044	12.6200873
Litter Appl. Rate (tons/acre)	25	9.9	10	9.9	81	81	81	81	81	18
WEP rate (lb/ac)	47.5	18.81	19	18.81	5.67	5.67	5.67	5.67	5.67	34.2
TP rate (lb/ac)	315.502183	124.938865	126.200873	124.938865	820.611354	820.611354	820.611354	820.611354	820.611354	227.161572
Alum Used	No	No	No	No	No	No	No	No	No	No
Mineralization Coef	0.05	0.05	0.05	0.05	0.05	0.05	0.05	0.05	0.05	0.05
WEP coef	0.029	0.029	0.029	0.029	0.031	0.031	0.031	0.031	0.031	0.029
WEP Source Value	1.76610317	0.69937685	0.70644127	0.69937685	1.4389291	1.4389291	1.4389291	1.4389291	1.4389291	1.27159428
Soil Test P	110.39	95.76	55.86	66.5	86.45	101.08	236.74	61.18	69.16	91.77
Soil coef	0.0018	0.0018	0.0018	0.0018	0.0018	0.0018	0.0018	0.0018	0.0018	0.0018
Soil P Source Value	0.198702	0.172368	0.100548	0.1197	0.15561	0.181944	0.426132	0.110124	0.124488	0.165186
Total P Source Value	1.96480517	0.87174485	0.80698927	0.81907685	1.5945391	1.6208731	1.8650611	1.5490531	1.5634171	1.43678028
R factor	270	270	270	270	270	270	270	270	270	270
Kf	0.43	0.43	0.37	0.43				0.37		0.37
Adj Kf For Freezing?	Yes	Yes	Yes	Yes	Yes	Yes	Yes	Yes	Yes	Yes
Kf Used	0.35	0.35	0.3	0.35				0.3		0.3
Slope Gradient (%)	5.5	14	14	14	0.2	0.2	0.2	3.5	0.2	3.5
Slope Length (ft)	45	45	23	23	5	4	4	12	7	15

Comments:

Arkansas Nutrient Management Planner with 2009 PI (ver 3/3/2010)

Planner:	Nathan A. Pesta, P.E.							Date:	5/25/2012		
Plan Description:	Jason Henson: Fields 1-10										
Rusle LS	0.44	1.2	0.98	0.98	0.05	0.05	0.05	0.26	0.05	0.26	
Vegetal Canopy: Type	Grass	Grass	Grass	Grass	Grass	Grass	Grass	Grass	Grass	Grass	
Percent of Ground Coverd	95-100	95-100	95-100	95-100	95-100	95-100	95-100	95-100	95-100	95-100	
C Factor	0.003	0.003	0.003	0.003	0.003	0.003	0.003	0.003	0.003	0.003	
Cons. Support Practices (P)	None in plac	None in plac	None in plac	None in plac	None in plac	None in plac	None in plac	None in plac	None in plac	None in plac	
Calc. P Factor?	No	No	No	No	No	No	No	No	No	No	
Soil Hydrologic Group	B	B	B	B				B		B	
EI	110	110	110	110	110	110	110	110	110	110	
P Factor	1	1	1	1	1	1	1	1	1	1	
RUSLE 1 (ton/ac)	0.12474	0.3402	0.23814	0.27783				0.06318		0.06318	
RUSLE 2 (ton/ac)	0.18	6.6	0.0061	5.4	0.05	0.05	1.1	1.3	0.49	1.3	
RUSLE ? Used (ton/ac)	0.18	6.6	0.0061	5.4	0.05	0.05	1.1	1.3	0.49	1.3	
Soil Erosion LRV	0	1	0	1	0	0	0.1	0.1	0	0.1	
Pasture Use	Rotational G	Rotational G	Hayland	Rotational G	Hayland	Hayland	Hayland	Hayland	Hayland	Hayland	
Runoff Curve Numbers	61	61	58	61				58		58	
Soil Runoff Class	VL	L	N	L				N		N	
Soil Runoff Class LRV	0.15	0.2	0.1	0.2				0.1		0.1	
Flooding Frequency	None	None	Occasional	None	#N/A	#N/A	#N/A	None	#N/A	None	
Flooding Frequency LRV	0	0	0.5	0				0		0	
Application Method	Surface App	Surface App	Surface App	Surface App	Surface App	Surface App	Surface App	Surface App	Surface App	Surface App	
Application Method LRV	0.2	0.2	0.2	0.2	0.2	0.2	0.2	0.2	0.2	0.2	
Application Timing	March-June	March-June	March-June	March-June	March-June	March-June	March-June	March-June	March-June	March-June	
Application Timing LRV	0.25	0.25	0.25	0.25	0.25	0.25	0.25	0.25	0.25	0.25	
Total P Transport Value	0.6	1.65	1.05	1.65				0.65		0.65	
Calc PI	0	0	0	0	9	9	9	0	9	0	
Pre BMP PI Value	65	80	47	75				56		52	
PI Range	Medium	High	Medium	High				Medium		Medium	
Diversion %	0	0	0	0	0	0	0	0	0	0	
Terrace %	0	0	0	0	0	0	0	0	0	0	
Pond %	0	0	0	0	0	0	0	0	0	0	
Filter Strip %	0	0	0	0	0	0	0	0	0	0	
Grassed WaterWay %	0	0	0	0	0	0	0	0	0	0	
Fencing %	0	0	0	0	0	0	0	0	0	0	
Riparian Forst Buffer %	0	0	0	0	0	0	0	0	0	0	
Riparian Herbaceous Buffer %	0	0	0	0	0	0	0	0	0	0	
Field Borderrs %	0	0	0	0	0	0	0	0	0	0	
Total SMV	1	1	1	1	1	1	1	1	1	1	
Post BMP PI Value	65	80	47	75				56		52	
PI Range	Medium	High	Medium	High				Medium		Medium	

Comments:

Arkansas Nutrient Management Planner with 2009 PI (ver 3/3/2010)

Planner:		Date:	5/25/2012
Plan Description:	C&H Hog Farms: Fields 11-17		

This worksheet is intended to assist in the writing of Nutrient Management Plans for the application of manure to pasture and hay land. To do this, the worksheet estimates the litter production for the farm, estimates the P Index risk value for the defined conditions of each field, assists with the allocation of nutrients to the various receiving fields, and estimates the amount of litter available for off farm use. This worksheet is the result of an effort to develop a reliable training/planning tool faithful to the 2009 Arkansas P Index developed by a multi-agency effort. However, no guarantees are made, and any observed problems or suggestions for improvement should be directed to Karl VanDevender at kvan@uaex.edu.

County Information

Farm county	Newton
R	270
10-Yr EI	110
Kf adjusted for frost?	Yes

Nutrient Source and Description Information

Manure Source	Source Type	Amount Available		N Concentration		P2O5 Concentration		K2O Concentration		Water Extractible P		Alum Used?
WSP#1	Liquid Biosolids	1230	1000 gal	37.60	lb/1000 gal	28.90	lb/1000 gal	29.10	lb/1000 gal	1.90	lb/1000 gal	No
WSP#2	Liquid Manure	1531	1000 gal	30.20	lb/1000 gal	23.20	lb/1000 gal	23.40	lb/1000 gal	0.70	lb/1000 gal	No

Nutrient Loss and Mineralization Factors

Nutrient Source Description	N		P2O5		K2O	
	Storage Losses (%)	Appl. Losses (%)	Storage Losses (%)	Appl. Losses (%)	Storage Losses (%)	Appl. Losses (%)
WSP#1	60%	50%	80%		80%	
WSP#2	60%	50%	80%		80%	

Estimated Plant Available Nutrients

Nutrient Source Description	N			P2O5			K2O			Water Extractible P		
	Concentration		Total (lb)	Concentration		Total (lb)	Concentration		Total (lb)	Concentration		Total (lb)
WSP#1	7.52	lb/1000 gal	9,250	5.78	lb/1000 gal	7,109	5.82	lb/1000 gal	7,159	1.90	lb/1000 gal	2337
WSP#2	6.04	lb/1000 gal	9,247	4.64	lb/1000 gal	7,104	4.68	lb/1000 gal	7,165	0.70	lb/1000 gal	1071.7
Totals			18,497			14,213			14,324			3,409

Field P Index Calculations

Soil Test P	Soil Map	Slope Gradient (%)	Slope Length (ft)	Flooding
-------------	----------	--------------------	-------------------	----------

Comments:

Arkansas Nutrient Management Planner with 2009 PI (ver 3/3/2010)

Planner: _____ Date: 5/25/2012

Plan Description: C&H Hog Farms: Fields 11-17

Field	ppm	lb/ac	Soil map Unit	Min	Max	Rep	Used	Min	Max	Rep	Used	Frequency
H11	57	76	43	8	20	14	14	15	30	20	20	None
H12	19	25	50	0	3	2	2	15	75	45	45	Occasional
H13	48	64	43	8	20	14	14	15	30	20	20	None
H14	52	69	43	8	20	14	14	15	30	20	20	None
H15	15	20	43	8	20	14	14	15	30	20	20	None
H16	48	64	50	0	3	2	2	15	75	45	45	Occasional
H17	50	67	1	3	8	5	5.5	15	75	45	45	None

Field	Field Area (ac)	Buffer Length (ft)	Buffer Width (ft)	Appl Area (ac)	Predominate Vegetation	Percent Ground Cover	Conservation Support Practices (P)	RUSLE 1 (ton/ac)	RUSLE 2 (ton/ac)
H11	20.70			20.70	Grass	95-100	None in place	0.28	5.20
H12	28.70	2,200	100	23.65	Grass	95-100	None in place	0.05	0.91
H13	66.90	2,300	100	61.62	Grass	95-100	None in place	0.28	5.20
H14	18.00			18.00	Grass	95-100	None in place	0.28	5.20
H15	66.30	2,300	100	61.02	Grass	95-100	None in place	0.28	5.20
H16	79.60			79.60	Grass	95-100	None in place	0.05	0.91
H17	88.70			88.70	Grass	95-100	None in place	0.12	1.10

369

353

Field	Pasture Use	Application Method	Application Timing	Nutrient Source	Application Rate		Pre BMP PI Value	P Index Range	Target Post BMPs PI Values
H11	Hayland	Surface Applied	March-June	WSP#1	9.90	1000 gal/ac	72	High	
H12	Hayland	Surface Applied	March-June	WSP#1	15.00	1000 gal/ac	64	Medium	
H13	Hayland	Surface Applied	March-June	WSP#1	9.90	1000 gal/ac	70	High	
H14	Hayland	Surface Applied	March-June	WSP#1	9.90	1000 gal/ac	71	High	
H15	Hayland	Surface Applied	March-June	WSP#1	9.90	1000 gal/ac	63	Medium	
H16	Hayland	Surface Applied	March-June	WSP#1	14.00	1000 gal/ac	64	Medium	
H17	Hayland	Surface Applied	March-June	WSP#1	18.00	1000 gal/ac	58	Medium	

Comments:

Arkansas Nutrient Management Planner with 2009 PI (ver 3/3/2010)

Planner:		Date:	5/25/2012
Plan Description:	C&H Hog Farms: Fields 11-17		

Best Management Practices

Field	Diversion	Terrace	Pond	Filter Strip	Grassed Waterway	Fencing	Riparian Forest Buffer	Riparian Herbaceous Cover	Field Borders	Post BMP PI Value	P Index Range
H11										72	High
H12										64	Medium
H13										70	High
H14										71	High
H15										63	Medium
H16										64	Medium
H17										58	Medium

Field Nutrient Application Planning

Per Acre Basis

Field	Nutrient Source	Application			Nutrient Recommendation (lb/ac)			Nutrients Applied (lb/ac)			Surpluses / Deficits (lb/ac)		
		PI Max	Planned		N	P2O5	K2O	N	P2O5	K2O	N	P2O5	K2O
H11	WSP#1	9.90	9.90	1000 gal/ac	489	57	220	74	57	58	-415	0	-162
H12	WSP#1	15.00	15.00	1000 gal/ac	489	57	220	113	87	87	-376	30	-133
H13	WSP#1	9.90	9.90	1000 gal/ac	489	57	220	74	57	58	-415	0	-162
H14	WSP#1	9.90	9.90	1000 gal/ac	489	57	220	74	57	58	-415	0	-162
H15	WSP#1	9.90	9.90	1000 gal/ac	489	57	220	74	57	58	-415	0	-162
H16	WSP#1	14.00	14.00	1000 gal/ac	489	57	220	105	81	81	-384	24	-139
H17	WSP#1	18.00	18.00	1000 gal/ac	489	57	220	135	104	105	-354	47	-115

Per Field Basis

Field	Nutrient Source	Application			Nutrient Recommendation (lbs)			Nutrients Applied (lbs)			Surpluses / Deficits (lb)		
		PI Max	Planned		N	P2O5	K2O	N	P2O5	K2O	N	P2O5	K2O
H11	WSP#1	204.93	204.93	1000 gal	10,122	1,180	4,554	1,541	1,184	1,193	-8,581	5	-3,361
H12	WSP#1	354.74	354.74	1000 gal	11,565	1,348	5,203	2,668	2,050	2,065	-8,897	702	-3,138
H13	WSP#1	610.04	610.04	1000 gal	30,132	3,512	13,556	4,587	3,526	3,550	-25,545	14	-10,006
H14	WSP#1	178.20	178.20	1000 gal	8,802	1,026	3,960	1,340	1,030	1,037	-7,462	4	-2,923
H15	WSP#1	604.10	604.10	1000 gal	29,839	3,478	13,424	4,543	3,492	3,516	-25,296	14	-9,909
H16	WSP#1	1114.40	1114.40	1000 gal	38,924	4,537	17,512	8,380	6,441	6,486	-30,544	1,904	-11,026
H17	WSP#1	1596.60	1596.60	1000 gal	43,374	5,056	19,514	12,006	9,228	9,292	-31,368	4,172	-10,222

Comments:

Arkansas Nutrient Management Planner with 2009 PI (ver 3/3/2010)

Planner:		Date:	5/25/2012
Plan Description:	C&H Hog Farms: Fields 11-17		

Totals	172,758	20,137	77,724	35,066	26,952	27,139	-137,693	6,815	-50,585
--------	---------	--------	--------	--------	--------	--------	----------	-------	---------

Comments:

Arkansas Nutrient Management Planner with 2009 PI (ver 3/3/2010)

Planner:								Date:	5/25/2012
Plan Description:	C&H Hog Farms: Fields 11-17								
Slope Gradient (%)	14	2	14	14	14	2	5.5		
Slope Length (ft)	20	45	20	20	20	45	45		
Rusle LS	0.98	0.21	0.98	0.98	0.98	0.21	0.44		
Vegetal Canopy: Type	Grass	Grass	Grass	Grass	Grass	Grass	Grass		
Percent of Ground Coverd	95-100	95-100	95-100	95-100	95-100	95-100	95-100		
C Factor	0.003	0.003	0.003	0.003	0.003	0.003	0.003		
Cons. Support Practices (P)	None in plac	None in plac	None in plac	None in plac	None in plac	None in plac	None in plac		
Calc. P Factor?	No	No	No	No	No	No	No		
Soil Hydrologic Group	B	B	B	B	B	B	C		
EI	110	110	110	110	110	110	110		
P Factor	1	1	1	1	1	1	1		
RUSLE 1 (ton/ac)	0.27783	0.05103	0.27783	0.27783	0.27783	0.05103	0.12474		
RUSLE 2 (ton/ac)	5.2	0.91	5.2	5.2	5.2	0.91	1.1		
RUSLE ? Used (ton/ac)	5.2	0.91	5.2	5.2	5.2	0.91	1.1		
Soil Erosion LRV	1	0	1	1	1	0	0.1		
Pasture Use	Hayland	Hayland	Hayland	Hayland	Hayland	Hayland	Hayland		
Runoff Curve Numbers	58	58	58	58	58	58	71		
Soil Runoff Class	N	N	N	N	N	N	L		
Soil Runoff Class LRV	0.1	0.1	0.1	0.1	0.1	0.1	0.2		
Flooding Frequency	None	Occasional	None	None	None	Occasional	None		
Flooding Frequency LRV	0	0.5	0	0	0	0.5	0		
Application Method	Surface App	Surface App	Surface App	Surface App	Surface App	Surface App	Surface App		
Application Method LRV	0.2	0.2	0.2	0.2	0.2	0.2	0.2		
Application Timing	March-June	March-June	March-June	March-June	March-June	March-June	March-June		
Application Timing LRV	0.25	0.25	0.25	0.25	0.25	0.25	0.25		
Total P Transport Value	1.55	1.05	1.55	1.55	1.55	1.05	0.75		
Calc PI	0	0	0	0	0	0	0		
Pre BMP PI Value	72	64	70	71	63	64	58		
PI Range	High	Medium	High	High	Medium	Medium	Medium		
Diversions %	0	0	0	0	0	0	0		
Terrace %	0	0	0	0	0	0	0		
Pond %	0	0	0	0	0	0	0		
Filter Strip %	0	0	0	0	0	0	0		
Grassed WaterWay %	0	0	0	0	0	0	0		
Fencing %	0	0	0	0	0	0	0		
Riparian Forst Buffer %	0	0	0	0	0	0	0		
Riparian Herbaceous Buffer %	0	0	0	0	0	0	0		
Field Borderrs %	0	0	0	0	0	0	0		
Total SMV	1	1	1	1	1	1	1		
Post BMP PI Value	72	64	70	71	63	64	58		
PI Range	High	Medium	High	High	Medium	Medium	Medium		

RUSLE2 Erosion Calculation Record

Info: Field 1: SW ¼, Section 25, T 15 N, R 20 W

profiles\Newton Default

Inputs:

Location: Arkansas\Newton County

Soil: 42 NOARK VERY CHERTY SILT LOAM, 3 TO 8 PERCENT SLOPES\NOARK very gravelly silt loam 100%

Slope length (horiz): 45 ft

Avg. slope steepness: 5.5 %

Contouring: a. rows up-and-down hill

Strips/barriers: (none)

Diversion/terrace, sediment basin: (none)

Base management: a.Single Year/Single Crop Templates\Pasture\Cont grz warm seas past cmz17

Outputs:

T value: 5.0 t/ac/yr

Soil loss for cons. plan: 0.18 t/ac/yr

RUSLE2 Erosion Calculation Record

Info: Field 2: SW ¼ Section 25 Township 15N Range 20W

profiles\Newton Default

Inputs:

Location: Arkansas\Newton County

Soil: 43 NOARK VERY CHERTY SILT LOAM, 8 TO 20 PERCENT SLOPES\NOARK very gravelly silt loam 100%

Slope length (horiz): 45 ft

Avg. slope steepness: 14 %

Contouring: a. rows up-and-down hill

Strips/barriers: (none)

Diversion/terrace, sediment basin: (none)

Base management: a.Single Year/Single Crop Templates\Pasture\Rot grz warm seas past cmz17

Outputs:

T value: 5.0 t/ac/yr

Soil loss for cons. plan: 6.6 t/ac/yr

RUSLE2 Erosion Calculation Record

Info: Field 3: SW ¼, Section 25, T 15 N, R 20 W

profiles\Newton Default

Inputs:

Location: Arkansas\Newton County

Soil: 48 RAZORT LOAM, OCCASIONALLY FLOODED\RAZORT loam 95%

Slope length (horiz): 20 ft

Avg. slope steepness: 1.5 %

Contouring: a. rows up-and-down hill

Strips/barriers: (none)

Diversion/terrace, sediment basin: (none)

Base management: a.Single Year/Single Crop Templates\Bermudagrass\Bermudagrass hay; NT, z17*

Outputs:

T value: 5.0 t/ac/yr

Soil loss for cons. plan: 0.0061 t/ac/yr

RUSLE2 Erosion Calculation Record

Info: Field 4: NW ¼ Section 36 Township 15N Range 20W

profiles\Newton Default

Inputs:

Location: Arkansas\Newton County

Soil: 43 NOARK VERY CHERTY SILT LOAM, 8 TO 20 PERCENT SLOPES\NOARK very gravelly silt loam 100%

Slope length (horiz): 23 ft

Avg. slope steepness: 14 %

Contouring: a. rows up-and-down hill

Strips/barriers: (none)

Diversion/terrace, sediment basin: (none)

Base management: a.Single Year/Single Crop Templates\Pasture\Rot grz warm seas past cmz17

Outputs:

T value: 5.0 t/ac/yr

Soil loss for cons. plan: 5.4 t/ac/yr

RUSLE2 Erosion Calculation Record

Info: Field 5: NE1/4 Section 26 Township 15N Range 20W

profiles\Newton Default

Inputs:

Location: Arkansas\Newton County

Soil: 48 RAZORT LOAM, OCCASIONALLY FLOODED\RAZORT loam 95%

Slope length (horiz): 5.0 ft

Avg. slope steepness: 0.010 %

Contouring: a. rows up-and-down hill

Strips/barriers: (none)

Diversion/terrace, sediment basin: (none)

Base management: a.Single Year/Single Crop Templates\ Bermudagrass\Bermudagrass hay; NT, z17*

Outputs:

T value: 5.0 t/ac/yr

Soil loss for cons. plan: 0.050 t/ac/yr

RUSLE2 Erosion Calculation Record

Info: Field 6: NE ¼ Section 26 Township 15N Range 20W

profiles\Newton Default

Inputs:

Location: Arkansas\Newton County

Soil: 48 RAZORT LOAM, OCCASIONALLY FLOODED\RAZORT loam 95%

Slope length (horiz): 4.0 ft

Avg. slope steepness: 0.010 %

Contouring: a. rows up-and-down hill

Strips/barriers: (none)

Diversion/terrace, sediment basin: (none)

Base management: a.Single Year/Single Crop Templates\Bermudagrass\Bermudagrass hay; NT, z17*

Outputs:

T value: 5.0 t/ac/yr

Soil loss for cons. plan: 0.050 t/ac/yr

RUSLE2 Erosion Calculation Record

Info: Field 7: E ½ Section 26 Township 15N Range 20W

profiles\Newton Default

Inputs:

Location: Arkansas\Newton County

Soil: 48 RAZORT LOAM, OCCASIONALLY FLOODED\RAZORT loam 95%

Slope length (horiz): 4.0 ft

Avg. slope steepness: 3.0 %

Contouring: a. rows up-and-down hill

Strips/barriers: (none)

Diversion/terrace, sediment basin: (none)

Base management: a.Single Year/Single Crop Templates\ Bermudagrass\Bermudagrass hay; NT, z17*

Outputs:

T value: 5.0 t/ac/yr

Soil loss for cons. plan: 1.1 t/ac/yr

RUSLE2 Erosion Calculation Record

Info: Field 8: NE ¼ Section 35 Township 15N Range 20W

profiles\Newton Default

Inputs:

Location: Arkansas\Newton County

Soil: 51 SPADRA LOAM, 2 TO 5 PERCENT SLOPES\SPADRA loam 95%

Slope length (horiz): 12 ft

Avg. slope steepness: 3.5 %

Contouring: a. rows up-and-down hill

Strips/barriers: (none)

Diversion/terrace, sediment basin: (none)

Base management: a.Single Year/Single Crop Templates\ Bermudagrass\Bermudagrass hay; NT, z17*

Outputs:

T value: 5.0 t/ac/yr

Soil loss for cons. plan: 1.3 t/ac/yr

RUSLE2 Erosion Calculation Record

Info: Field 9: NE ¼ Section 35 Township 15N Range 20W

profiles\Newton Default

Inputs:

Location: Arkansas\Newton County

Soil: 50 SPADRA LOAM, OCCASIONALLY FLOODED\SPADRA loam 95%

Slope length (horiz): 7.0 ft

Avg. slope steepness: 1.0 %

Contouring: a. rows up-and-down hill

Strips/barriers: (none)

Diversion/terrace, sediment basin: (none)

Base management: a.Single Year/Single Crop Templates\Hay\ Bermudagrass\Bermudagrass hay; NT, z17*

Outputs:

T value: 5.0 t/ac/yr

Soil loss for cons. plan: 0.49 t/ac/yr

RUSLE2 Erosion Calculation Record

Info: Field 10: NE ¼ Section 35 Township 15N Range 20W

profiles\Newton Default

Inputs:

Location: Arkansas\Newton County

Soil: 51 SPADRA LOAM, 2 TO 5 PERCENT SLOPES\SPADRA loam 95%

Slope length (horiz): 15 ft

Avg. slope steepness: 3.5 %

Contouring: a. rows up-and-down hill

Strips/barriers: (none)

Diversion/terrace, sediment basin: (none)

Base management: a.Single Year/Single Crop Templates\ Bermudagrass\Bermudagrass hay; NT, z17*

Outputs:

T value: 5.0 t/ac/yr

Soil loss for cons. plan: 1.3 t/ac/yr

RUSLE2 Erosion Calculation Record

Info: Field 11: N ½ Section 35 Township 15N Range 20W

profiles\Newton Default

Inputs:

Location: Arkansas\Newton County

Soil: 43 NOARK VERY CHERTY SILT LOAM, 8 TO 20 PERCENT SLOPES\NOARK very gravelly silt loam 100%

Slope length (horiz): 20 ft

Avg. slope steepness: 14 %

Contouring: a. rows up-and-down hill

Strips/barriers: (none)

Diversion/terrace, sediment basin: (none)

Base management: a.Single Year/Single Crop Templates\ Bermudagrass\Bermudagrass hay; NT, z17*

Outputs:

T value: 5.0 t/ac/yr

Soil loss for cons. plan: 5.2 t/ac/yr

RUSLE2 Erosion Calculation Record

Info: Field 12: SE ¼ Section 35 Township 15N Range 20W

profiles\Newton Default

Inputs:

Location: Arkansas\Newton County

Soil: 50 SPADRA LOAM, OCCASIONALLY FLOODED\SPADRA loam 95%

Slope length (horiz): 45 ft

Avg. slope steepness: 2.0 %

Contouring: a. rows up-and-down hill

Strips/barriers: (none)

Diversion/terrace, sediment basin: (none)

Base management: a.Single Year/Single Crop Templates\Bermudagrass\Bermudagrass hay; NT, z17*

Outputs:

T value: 5.0 t/ac/yr

Soil loss for cons. plan: 0.91 t/ac/yr

RUSLE2 Erosion Calculation Record

Info: Field 13: South ½ and North ½ of Sections 35 and 2 Township 15N and 14N Range 20W

profiles\Newton Default

Inputs:

Location: Arkansas\Newton County

Soil: 43 NOARK VERY CHERTY SILT LOAM, 8 TO 20 PERCENT SLOPES\NOARK very gravelly silt loam 100%

Slope length (horiz): 20 ft

Avg. slope steepness: 14 %

Contouring: a. rows up-and-down hill

Strips/barriers: (none)

Diversion/terrace, sediment basin: (none)

Base management: a.Single Year/Single Crop Templates\Bermudagrass\Bermudagrass hay; NT, z17*

Outputs:

T value: 5.0 t/ac/yr

Soil loss for cons. plan: 5.2 t/ac/yr

RUSLE2 Erosion Calculation Record

Info: Field 14: SW ¼ Section 35 Township 15N Range 20W

profiles\Newton Default

Inputs:

Location: Arkansas\Newton County

Soil: 43 NOARK VERY CHERTY SILT LOAM, 8 TO 20 PERCENT SLOPES\NOARK very gravelly silt loam 100%

Slope length (horiz): 20 ft

Avg. slope steepness: 14 %

Contouring: a. rows up-and-down hill

Strips/barriers: (none)

Diversion/terrace, sediment basin: (none)

Base management: a.Single Year/Single Crop Templates\Bermudagrass\Bermudagrass hay; NT, z17*

Outputs:

T value: 5.0 t/ac/yr

Soil loss for cons. plan: 5.2 t/ac/yr

RUSLE2 Erosion Calculation Record

Info: Field 15: NE ¼ Section 2 Township 14N Range 20W

profiles\Newton Default

Inputs:

Location: Arkansas\Newton County

Soil: 43 NOARK VERY CHERTY SILT LOAM, 8 TO 20 PERCENT SLOPES\NOARK very gravelly silt loam 100%

Slope length (horiz): 20 ft

Avg. slope steepness: 14 %

Contouring: a. rows up-and-down hill

Strips/barriers: (none)

Diversion/terrace, sediment basin: (none)

Base management: a.Single Year/Single Crop Templates\Bermudagrass\Bermudagrass hay; NT, z17*

Outputs:

T value: 5.0 t/ac/yr

Soil loss for cons. plan: 5.2 t/ac/yr

RUSLE2 Erosion Calculation Record

Info: Field 16: All and SE ¼ Sections 2 and 3 Township 14N Range 20W

profiles\Newton Default

Inputs:

Location: Arkansas\Newton County

Soil: 50 SPADRA LOAM, OCCASIONALLY FLOODED\SPADRA loam 95%

Slope length (horiz): 45 ft

Avg. slope steepness: 2.0 %

Contouring: a. rows up-and-down hill

Strips/barriers: (none)

Diversion/terrace, sediment basin: (none)

Base management: a.Single Year/Single Crop Templates\Bermudagrass\Bermudagrass hay; NT, z17*

Outputs:

T value: 5.0 t/ac/yr

Soil loss for cons. plan: 0.91 t/ac/yr

RUSLE2 Erosion Calculation Record

Info: Field 17: NE ¼ and S ½ Sections 3 and 34 Township 14N and 15N Range 20W

profiles\Newton Default

Inputs:

Location: Arkansas\Newton County

Soil: 1 ARKANA VERY CHERTY SILT LOAM, 3 TO 8 PERCENT SLOPES\ARKANA very gravelly silt loam 100%

Slope length (horiz): 45 ft

Avg. slope steepness: 2.0 %

Contouring: a. rows up-and-down hill

Strips/barriers: (none)

Diversion/terrace, sediment basin: (none)

Base management: a.Single Year/Single Crop Templates\Bermudagrass\Bermudagrass hay; NT, z17*

Outputs:

T value: 2.0 t/ac/yr

Soil loss for cons. plan: 1.1 t/ac/yr

Section D: Phosphorous Based Field List

Section E: Inventory of Water Wells

Inventory of Water Wells

Field ID	Location (Legal)	Well Depth (Ft.)	Use of Well <u>1/</u>	Required Setback Distance From Well For Manure Application (Ft.)	
				Distance From Field	State Rule
4	SW/4 of, Sec 25, T 15N, R 20 W	846	Private	NA	100
10	SE/4 of, Sec 35 T 15 N, R 20 W	700	Private	NA	100
14	SW/4, Sec 35, T 15 N, R 20 W	1035	Private	NA	100

- 1/ Well Use Categories:
- Producer (Owned)
 - Private
 - Public
 - Irrigation

Section F: Land Treatment Information and
Land Application Maps

SECTION F. Land Treatment Information and Land Application Maps

The following Information is attached

1. Waste Utilization Summary Spreadsheet
2. Overall Site Map
3. WQRA Maps
4. Soil Survey Maps

F.1 Waste Utilization Summary Spreadsheet

Field ID	Acres	Setbacks	Useable Acres	Land Use	Quarter	Section	Township	Range	County	Owner of Land
Area	(Acres)	(Acres)	(Acres)							
1	19.7	4.1	15.6	Grassland	SW 1/4	25	15N	20W	Newton	Jason Henson
2	19.3	2.3	17.0	Grassland	SW 1/4	25	15N	20W	Newton	Jason Henson
3	15.9	2.3	13.6	Grassland	SW 1/4	25	15N	20W	Newton	Charles Campbell
4	10.4	1.6	8.8	Grassland	NW 1/4	36	15N	20W	Newton	Jason Henson
5	24.9	1.2	23.8	Grassland	NE 1/4	26	15N	20W	Newton	Sean Crickets/Rickets
6	36.6	2.1	34.5	Grassland	NE1/4	26	15N	20W	Newton	William Rickets/Crickets
7	79.8	5.5	74.3	Grassland	E 1/2	26	15N	20W	Newton	E.G. Campbell
8	15.5	0.0	15.5	Grassland	NE 1/4	35	15N	20W	Newton	Charles Campbell
9	45.1	3.9	41.2	Grassland	NE 1/4	35	15N	20W	Newton	Charles Campbell
10	34.3	1.2	33.2	Grassland	NE 1/4	35	15N	20W	Newton	Charles Campbell
11	20.7	0.0	20.7	Grassland	N 1/2	35	15N	20W	Newton	Charles Campbell
12	28.7	5.1	23.7	Grassland	SE 1/4	35	15N	20W	Newton	Barbara Hufley
13	66.9	5.3	61.6	Grassland	S 1/2 & N 1/2	35&2	15N&14N	20W	Newton	Barbara Hufley
14	18.0	0.0	18.0	Grassland	SW1/4	35	15N	20W	Newton	Charles Campbell
15	66.3	5.3	61.0	Grassland	NW 1/4	2	14N	20W	Newton	Barbara Hufley
16	79.6	0.0	79.6	Grassland	All & SE 1/4	2&3	15N&14N	20W	Newton	Clayel Criner
17	88.7	0.0	88.7	Grassland	NE 1/4&S 1/2	3&34	15N&14N	20W	Newton	Barbara Hufley
Total	670.4	39.7	630.7							Jason Criner





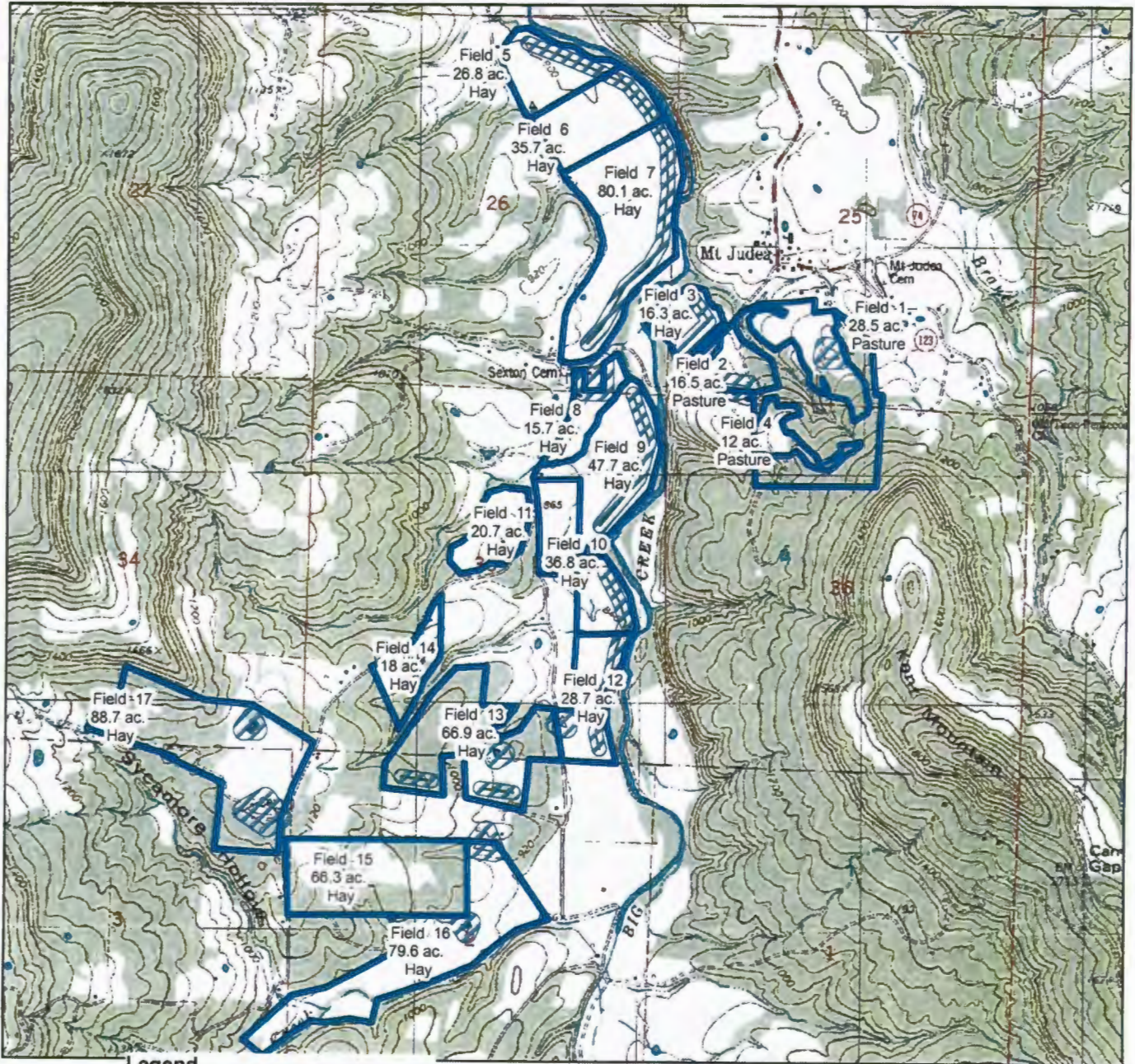

Topographic

Customer(s): JASON HENSON

Approximate Acres: 685



Legend

-  Henson
-  Buffer_Output5.shp
-  Resource Inventory (Line)
-  Buffer_Output.shp
-  Resource Inventory (Polygon)
-  Resource Inventory (Line)

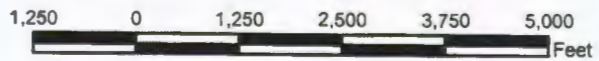







Conservation Map

Customer(s): JASON HENSON

Approximate Acres: 685



Legend

-  Henson
-  Buffer_Output5.shp
-  Resource Inventory (Line)
-  Buffer_Output.shp
-  Resource Inventory (Polygon)
-  Resource Inventory (Line)

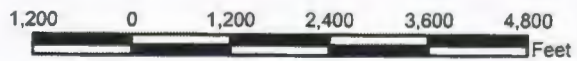



LEGEND

- 2 Arkana-Moko complex, 8 to 20 percent slopes
- 3 Arkana-Moko complex, 20 to 40 percent slopes
- 6 Ceda-Kenn complex, frequently flooded
- 7 Clarksville very cherty silt loam, 20 to 50 percent slopes
- 8 Eden-Newnata complex, 8 to 20 percent slopes
- 9 Eden-Newnata complex, 20 to 40 percent slopes
- 15 Enders-Leesburg stony loams, 8 to 20 percent slopes
- 16 Enders-Leesburg stony loams, 20 to 40 percent slopes
- 26 Moko-Rock outcrop complex, 15 to 50 percent slopes
- 37 Nella-Steprock complex, 8 to 20 percent slopes
- 38 Nella-Steprock-Mountainburg very stony loams, 20 to 40 percent slopes
- 39 Nella-Steprock-Mountainburg very stony loams, 40 to 60 percent slopes
- 42 Noark very cherty silt loam, 3 to 8 percent slopes
- 43 Noark very cherty silt loam, 8 to 20 percent slopes
- 44 Noark very cherty silt loam, 20 to 40 percent slopes
- 48 Razort loam, occasionally flooded
- 50 Spadra loam, occasionally flooded
- 51 Spadra loam, 2 to 5 percent slopes
- 54 Water

GENERAL NOTES

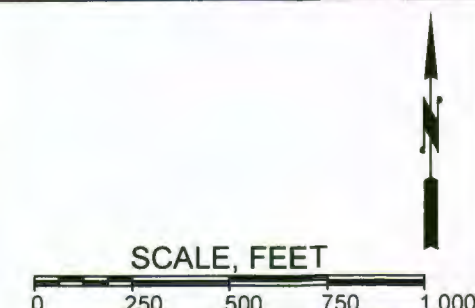

No.	Revision/Issue	Date

DeHaan, Grabs & Associates, LLC
 Consulting Engineers
 PO Box 522, Mandan, ND 58554
 (701) 663-1116, FAX: (701) 667-1356
 www.dgaengineering.com

C&H HOG FARMS
 GESTATION-FARROWING FARM

SECTION 25 AND 36, T 15 N, R 20 W
 NEWTON COUNTY, AR

FIELDS 1-4

DATE: MAY 29, 2012	SHEET: 1
SCALE: 1" = 500'	
DRAWN BY: NAP	
CHECKED BY: DLD	

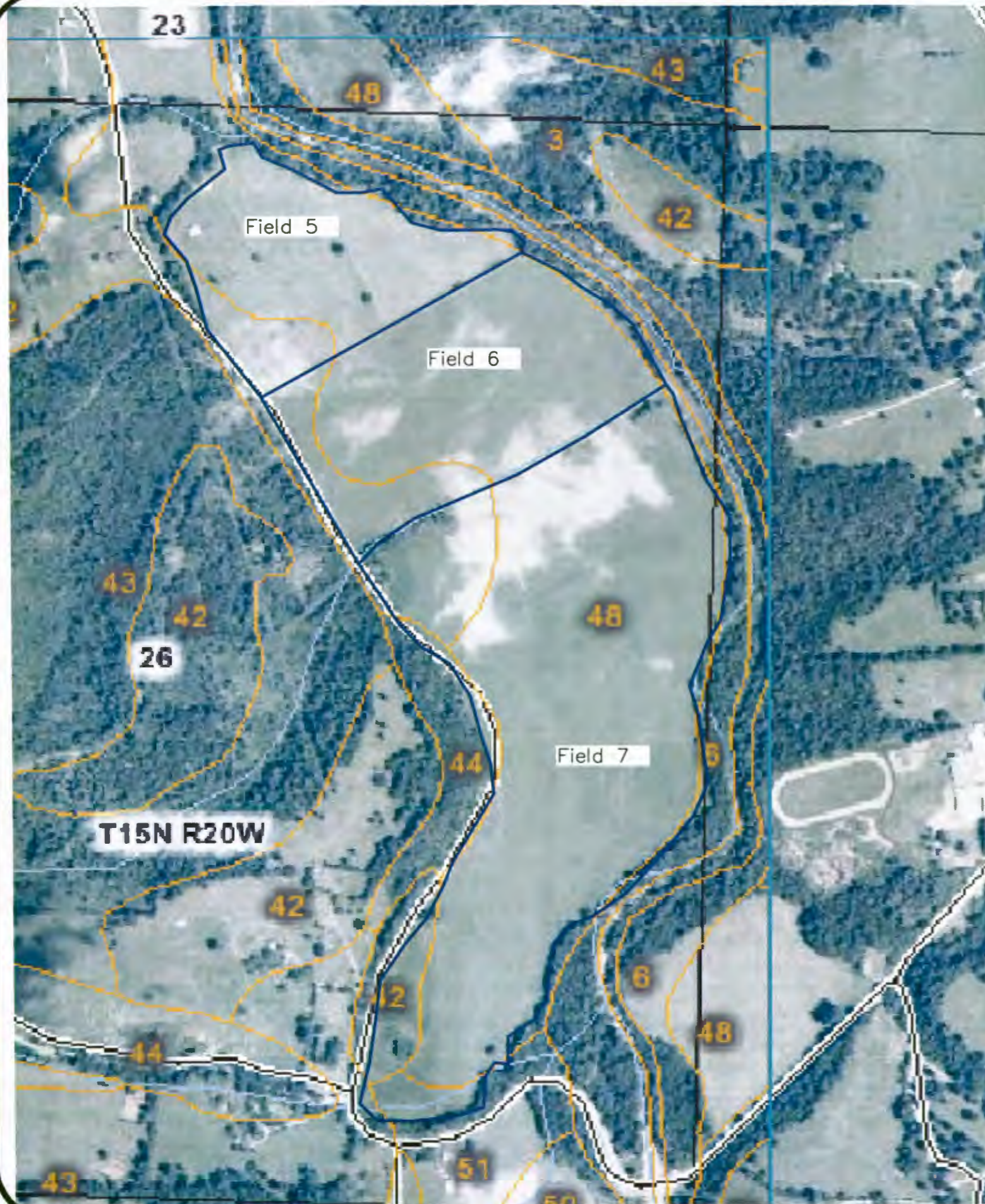

LEGEND

- 3 Arkana-Moko complex, 20 to 40 percent slopes
- 6 Ceda-Kenn complex, frequently flooded
- 11 Enders gravelly loam, 3 to 8 percent slopes
- 13 Enders stony loam, 3 to 20 percent slopes
- 26 Moko-Rock outcrop complex, 15 to 50 percent slopes
- 35 Nella-Enders stony loams, 8 to 20 percent slopes
- 42 Noark very cherty silt loam, 3 to 8 percent slopes
- 43 Noark very cherty silt loam, 8 to 20 percent slopes
- 44 Noark very cherty silt loam, 20 to 40 percent slopes
- 48 Razort loam, occasionally flooded
- 50 Spadra loam, occasionally flooded
- 51 Spadra loam, 2 to 5 percent slopes
- 54 Water

GENERAL NOTES

SCALE, FEET

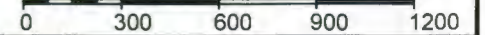

No.	Revision/Issue	Date

DeHaan, Grabs & Associates, LLC
 Consulting Engineers
 PO Box 522, Mandan, ND 58554
 (701) 663-1116, FAX: (701) 667-1356
 www.dgaengineering.com

C&H HOG FARMS
 GESTATION-FARROWING FARM

SECTION 26, T 15 N, R 20 W
 NEWTON COUNTY, AR

FIELDS 5-7

DATE: MAY 29, 2012	SHEET: 2
SCALE: 1" = 600'	
DRAWN BY: NAP	
CHECKED BY: DLD	



LEGEND

- 1 Arkana very cherty silt loam, 3 to 8 percent slopes
- 2 Arkana-Moko complex, 8 to 20 percent slopes
- 6 Ceda-Kenn complex, frequently flooded
- 11 Enders gravelly loam, 3 to 8 percent slopes
- 13 Enders stony loam, 3 to 20 percent slopes
- 26 Moko-Rock outcrop complex, 15 to 50 percent slopes
- 35 Nella-Enders stony loams, 8 to 20 percent slopes
- 37 Nella-Steprock complex, 8 to 20 percent slopes
- 42 Noark very cherty silt loam, 3 to 8 percent slopes
- 43 Noark very cherty silt loam, 8 to 20 percent slopes
- 44 Noark very cherty silt loam, 20 to 40 percent slopes
- 48 Razort loam, occasionally flooded
- 50 Spadra loam, occasionally flooded
- 51 Spadra loam, 2 to 5 percent slopes
- 54 Water

GENERAL NOTES

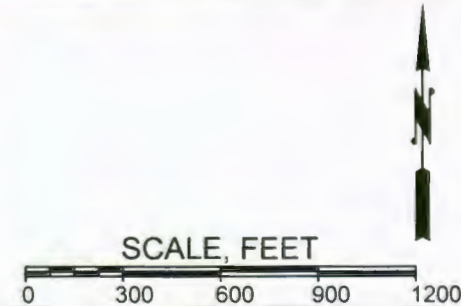

No.	Revision/Issue	Date

DeHaan, Grabs & Associates, LLC
 Consulting Engineers
 PO Box 522, Mandan, ND 58554
 (701) 663-1116, FAX: (701) 667-1356
 www.dgaengineering.com

C&H HOG FARMS
GESTATION-FARROWING FARM

SECTION 26, T 15 N, R 20 W
 NEWTON COUNTY, AR

FIELDS 8-15

DATE: MAY 29, 2012	SHEET: 3
SCALE: 1" = 600'	
DRAWN BY: NAP	
CHECKED BY: DLD	

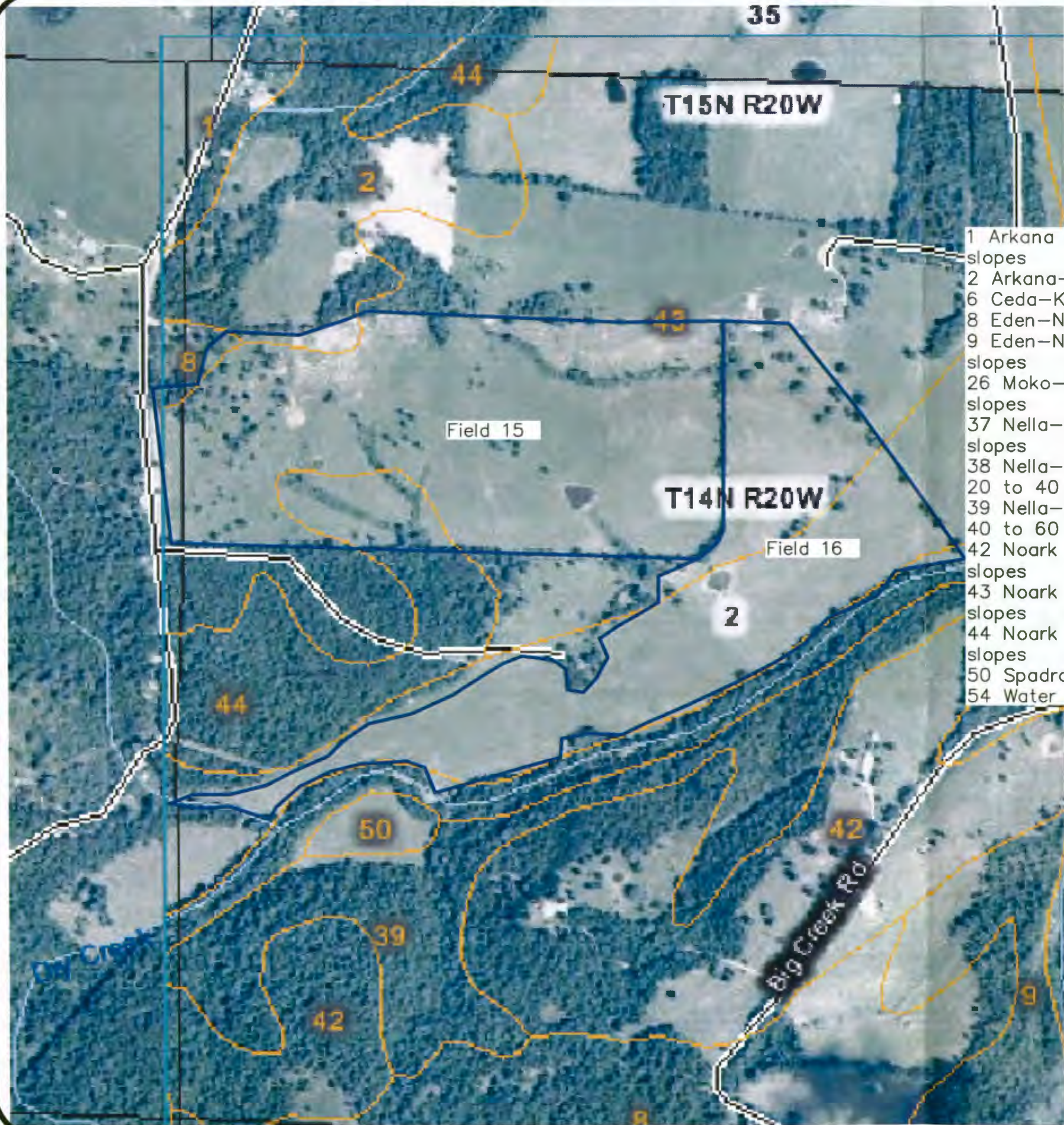

LEGEND

- 1 Arkana very cherty silt loam, 3 to 8 percent slopes
- 2 Arkana-Moko complex, 8 to 20 percent slopes
- 6 Ceda-Kenn complex, frequently flooded
- 8 Eden-Newnata complex, 8 to 20 percent slopes
- 9 Eden-Newnata complex, 20 to 40 percent slopes
- 26 Moko-Rock outcrop complex, 15 to 50 percent slopes
- 37 Nella-Steprock complex, 8 to 20 percent slopes
- 38 Nella-Steprock-Mountainburg very stony loams, 20 to 40 percent slopes
- 39 Nella-Steprock-Mountainburg very stony loams, 40 to 60 percent slopes
- 42 Noark very cherty silt loam, 3 to 8 percent slopes
- 43 Noark very cherty silt loam, 8 to 20 percent slopes
- 44 Noark very cherty silt loam, 20 to 40 percent slopes
- 50 Spadra loam, occasionally flooded
- 54 Water

GENERAL NOTES

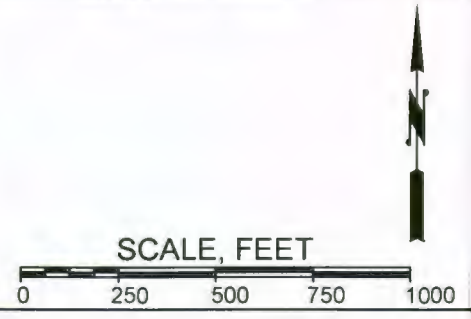

No.	Revision/Issue	Date

DeHaan, Grabs & Associates, LLC
 Consulting Engineers
 PO Box 522, Mandan, ND 58554
 (701) 663-1116, FAX: (701) 667-1356
 www.dgaengineering.com

C&H HOG FARMS
 GESTATION-FARROWING FARM

SECTION 3, T 14 N, R 20 W
 NEWTON COUNTY, AR

FIELDS 15-16

DATE: MAY 29, 2012	SHEET: 4
SCALE: 1" = 500'	
DRAWN BY: NAP	
CHECKED BY: DLD	

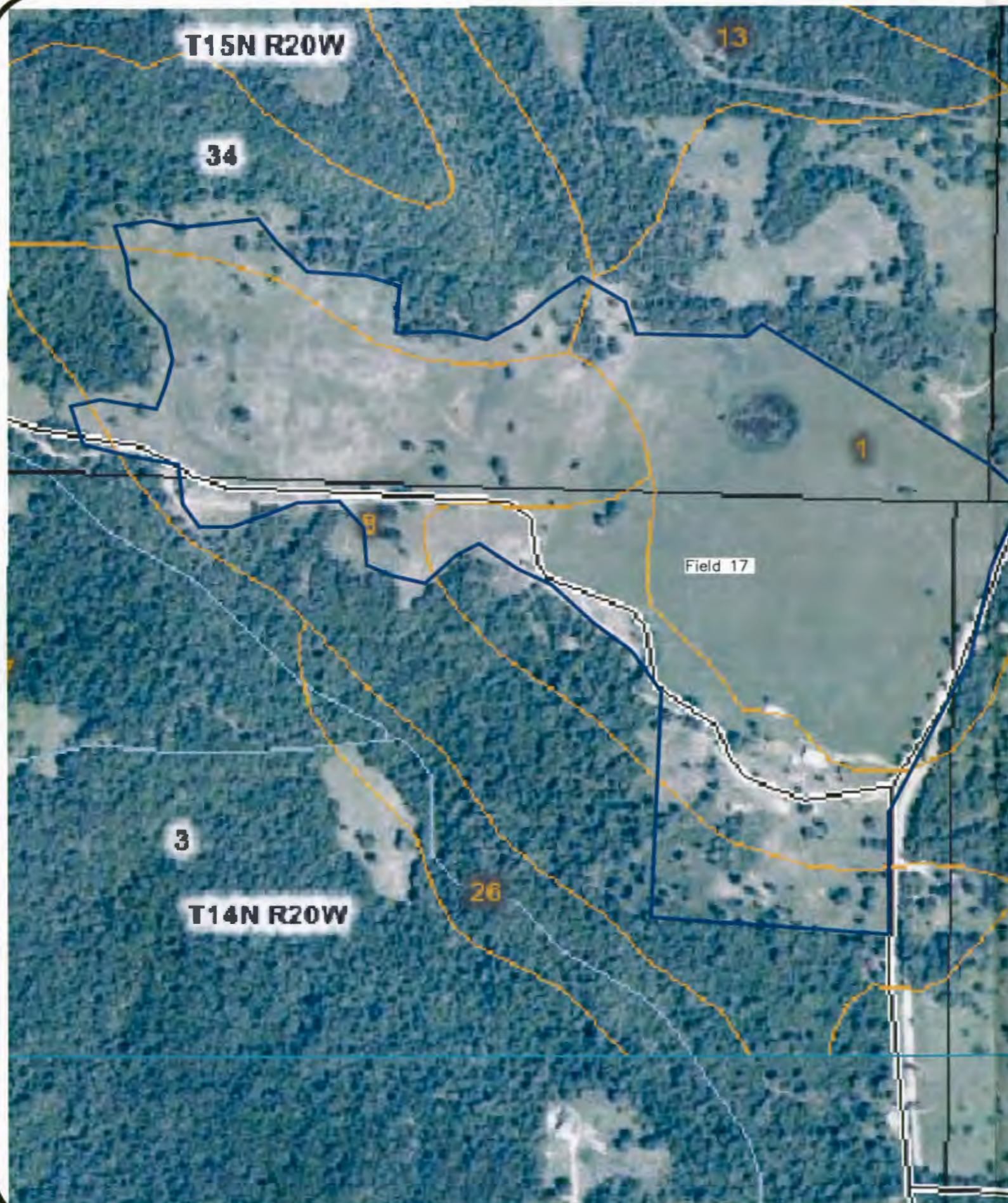

LEGEND

- 1 Arkana very cherty silt loam, 3 to 8 percent slopes
- 2 Arkana-Moko complex, 8 to 20 percent slopes
- 8 Eden-Newnata complex, 8 to 20 percent slopes
- 13 Enders stony loam, 3 to 20 percent slopes
- 26 Moko-Rock outcrop complex, 15 to 50 percent slopes
- 36 Nella-Enders stony loams, 20 to 40 percent slopes
- 37 Nella-Steprock complex, 8 to 20 percent slopes
- 39 Nella-Steprock-Mountainburg very stony loams, 40 to 60 percent slopes
- 43 Noark very cherty silt loam, 8 to 20 percent slopes
- 44 Noark very cherty silt loam, 20 to 40 percent slopes

GENERAL NOTES

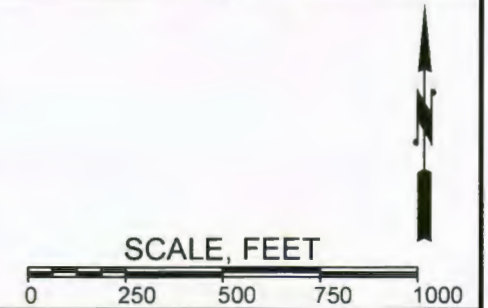

No.	Revision/Issue	Date

DeHaan, Grabs & Associates, LLC
 Consulting Engineers
 PO Box 522, Mandan, ND 58554
 (701) 663-1116, FAX: (701) 667-1356
 www.dgaengineering.com

C&H HOG FARMS
 GESTATION-FARROWING FARM

SECTION 3, T 14 N, R 20 W
 NEWTON COUNTY, AR

FIELD 17

DATE: MAY 29, 2012	SHEET: 5
SCALE: 1" = 500'	
DRAWN BY: NAP	
CHECKED BY: DLD	

Section G: Signed Manure Application
Lease Agreements

SECTION G. SIGNED MANURE APPLICATION LEASE AGREEMENTS

Signed easements are shown for Fields 1-17.

LAND USE CONTRACT

I, Loretta Ricketts, Landowner, agree to allow Jason Henson, Operation Owner, to land apply waste from his/her Hog Farm operation located in the 1/4 of Section 26 in Township 15 N and Range 20W in Newton County to 34.5 acres of my property located in Newton County. A description of the areas to be used as land application sites are as follows:

Site No.	¼ Section	Section	Township	Range	Latitude	Longitude	Available Acreage*
6	NE	26	15 N	20W	35.926	-93.069	34.5

*Available acreage is the total acreage minus buffer zone areas.

I am also aware that the land applicator or the owner of the operation is to apply waste according to the management plan and guidelines and conditions set forth by the Arkansas Department of Environmental Quality.

In addition to these guidelines, the following requirements must also be satisfied when applying waste to my land:

Jason Henson 6-5-12 Loretta Ricketts 5-19-12
 Operation Owner Signature Date Landowner Signature Date

LAND USE CONTRACT

I, Shan Ricketts, Landowner, agree to allow Jason Henson, Operation Owner, to land apply waste from his/her Hog Farm operation located in the 1/4 of Section 26 in Township 15N and Range 20W in Newton County to 23.8 acres of my property located in Newton County. A description of the areas to be used as land application sites are as follows:

Site No.	1/4 Section	Section	Township	Range	Latitude	Longitude	Available Acreage*
5	NE	26	15N	20W	35.928	-93.071	23.8

*Available acreage is the total acreage minus buffer zone areas.

I am also aware that the land applicator or the owner of the operation is to apply waste according to the management plan and guidelines and conditions set forth by the Arkansas Department of Environmental Quality.

In addition to these guidelines, the following requirements must also be satisfied when applying waste to my land:

Jason Henson 6-5-12 Shan Ricketts 5-19-12
 Operation Owner Signature Date Landowner Signature Date

LAND USE CONTRACT

I, Jacen Criner, Landowner, agree to allow Jason Henson, Operation Owner, to land apply waste from his/her Hog Farm operation located in the 1/4 of Section 26 in Township 15 N and Range 20 W in Newton County to 88.7 acres of my property located in Newton County. A description of the areas to be used as land application sites are as follows:

Site No.	1/4 Section	Section	Township	Range	Latitude	Longitude	Available Acreage
17	NE	3	14N	20W	35.901	-93.087	88.7
and	SW	34	15N	20W			
and	SE	34	15N	20W			

*Available acreage is the total acreage minus buffer zone areas.

I am also aware that the land applicator or the owner of the operation is to apply waste according to the management plan and guidelines and conditions set forth by the Arkansas Department of Environmental Quality.

In addition to these guidelines, the following requirements must also be satisfied when applying waste to my land:

Jason Henson
Operation Owner Signature

6-5-12
Date

Jacen Criner
Landowner Signature

5-19-12
Date

LAND USE CONTRACT

I, Jason Henson Landowner, agree to allow Jason Henson Operation Owner to land apply waste from his/her Hog Farm operation located in the 1/4 of Section 26 in Township 15 N and Range 20 W in Newton County to 41.4 acres of my property located in Newton County. A description of the areas to be used as land application sites are as follows:

Site No.	1/4 Section	Section	Township	Range	Latitude	Longitude	Available Acreage*
1	SW	25	15 N	20W	35.917	-93.058	15.6
2	SW	25	15 N	20W	35.916	-93.062	17.0
4	NW	36	15 N	20W	35.914	-93.062	8.8

*Available acreage is the total acreage minus buffer zone areas.

I am also aware that the land applicator or the owner of the operation is to apply waste according to the management plan and guidelines and conditions set forth by the Arkansas Department of Environmental Quality.

In addition to these guidelines, the following requirements must also be satisfied when applying waste to my land:

JASON HENSON Operation Owner Signature 3-21-12 Date JASON HENSON Landowner Signature 3-21-12 Date

LAND USE CONTRACT

I, E. G. Campbell Landowner, agree to allow Jason Henson Operation Owner
 to land apply waste from his/her Hog Farm Type of Operation operation located in the 1/4 of
 Section 26 in Township 15 N Township and Range 20 W Range in
Newton County of Operation County to 74.3 Total Acreage Available acres of my property located in
Newton County of Application Site County. A description of the areas to be used as land
 application sites are as follows:

Site No.	1/4 Section	Section	Township	Range	Latitude	Longitude	Available Acreage*
7	NE	26	15 N	20 W	35.922	-93.067	74.3
and	SE						

*Available acreage is the total acreage minus buffer zone areas.

I am also aware that the land applicator or the owner of the operation is to apply waste according to the management plan and guidelines and conditions set forth by the Arkansas Department of Environmental Quality.

In addition to these guidelines, the following requirements must also be satisfied when applying waste to my land:

Jason Henson Operation Owner Signature 3-21-12 Date E. G. Campbell Landowner Signature 3-21-12 Date

LAND USE CONTRACT

I, Charles W. Campbell, Landowner, agree to allow Jason Henson, Operation Owner, to land apply waste from his/her Hog Farm operation located in the 1/4 of Section 26 in Township 15 N and Range 20 W in Newton County to 103.5 acres of my property located in Newton County. A description of the areas to be used as land application sites are as follows:

Site No.	1/4 Section	Section	Township	Range	Latitude	Longitude	Available Acreage
3	SW	25	15N	20W	35.918	-93.065	13.6
8	NE	35	15N	20W	35.914	-93.071	15.5
9	NE	35	15N	20W	35.911	-93.068	41.2
10	NE	35	15N	20W	35.910	-93.071	33.2

*Available acreage is the total acreage minus buffer zone areas.

I am also aware that the land applicator or the owner of the operation is to apply waste according to the management plan and guidelines and conditions set forth by the Arkansas Department of Environmental Quality.

In addition to these guidelines, the following requirements must also be satisfied when applying waste to my land:

Jason Henson 10-24-11 Charles W Campbell 10-24-11
 Operation Owner Signature Date Landowner Signature Date

LAND USE CONTRACT

I, Charles W. Campbell, Landowner, agree to allow Jason Henson, Operation Owner, to land apply waste from his/her Hog Farm operation located in the 1/4 of Section 26 in Township 15N and Range 20W in Newton County to 61.6 acres of my property located in Newton County. A description of the areas to be used as land application sites are as follows:

Site No.	1/4 Section	Section	Township	Range	Latitude	Longitude	Available Acreage
13	SW	35	15N	20W	35.902	-93.076	61.6
and	SE	35	15N	20W			
and	NW	2	14N	20W			
and	NE	2	14N	20W			

*Available acreage is the total acreage minus buffer zone areas.

I am also aware that the land applicator or the owner of the operation is to apply waste according to the management plan and guidelines and conditions set forth by the Arkansas Department of Environmental Quality.

In addition to these guidelines, the following requirements must also be satisfied when applying waste to my land:

Jason Henson 10-24-11 Charles W Campbell 10-24-11
 Operation Owner Signature Date Landowner Signature Date

LAND USE CONTRACT

I, Barbara Hufley, Landowner, agree to allow Jason Henson, Operation Owner, to land apply waste from his/her Hog Farm operation located in the 1/4 of Section 26 in Township 15 N and Range 20 W in Newton County to 63.4 acres of my property located in Newton County. A description of the areas to be used as land application sites are as follows:

Site No.	1/4 Section	Section	Township	Range	Latitude	Longitude	Available Acreage*
11	NW	35	15 N	20 W	35.910	-93.074	20.7
and	NE	35	15 N	20 W			
12	SE	35	15 N	20 W	35.901	-93.069	23.7
14	SW	35	15 N	20 W	35.905	-93.078	18.0

*Available acreage is the total acreage minus buffer zone areas.

I am also aware that the land applicator or the owner of the operation is to apply waste according to the management plan and guidelines and conditions set forth by the Arkansas Department of Environmental Quality.

In addition to these guidelines, the following requirements must also be satisfied when applying waste to my land:

Jason Henson 11/1/11 Barbara Hufley 11/1/11
 Operation Owner Signature Date Landowner Signature Date

LAND USE CONTRACT

I, Barbara Hufley, Landowner agree to allow Jason Henson, Operation Owner
 to land apply waste from his/her Hog Farm operation located in the 1/4 of
(Type of Operation) 1/4 Section
 Section 26 in Township 15 N and Range 20W in
Section Township Range
Newton County to 79.6 acres of my property located in
County of Operation Total Acreage Available
Newton County. A description of the areas to be used as land
County of Application Site
 application sites are as follows:

Site No.	1/4 Section	Section	Township	Range	Latitude	Longitude	Available Acreage*
16	All	2	14N	20W	35.894	-93.076	79.6
and	SE	3	14N	20W			

*Available acreage is the total acreage minus buffer zone areas.

I am also aware that the land applicator or the owner of the operation is to apply waste according to the management plan and guidelines and conditions set forth by the Arkansas Department of Environmental Quality.

In addition to these guidelines, the following requirements must also be satisfied when applying waste to my land:

Jason Henson 11/1/11 Barbara Hufley 11/1/11
Operation Owner Signature Date Landowner Signature Date

LAND USE CONTRACT

I, Clayel Criner, Landowner, agree to allow Jason Henson, Operation Owner, to land apply waste from his/her Hog Farm operation located in the 1/4 of Section 26 in Township 15 N and Range 20 W in Newton County to 61 acres of my property located in Newton County. A description of the areas to be used as land application sites are as follows:

Site No.	1/4 Section	Section	Township	Range	Latitude	Longitude	Available Acreage*
15	NW	2	14N	20W	35.896	-93.078	61

*Available acreage is the total acreage minus buffer zone areas.

I am also aware that the land applicator or the owner of the operation is to apply waste according to the management plan and guidelines and conditions set forth by the Arkansas Department of Environmental Quality.

In addition to these guidelines, the following requirements must also be satisfied when applying waste to my land:

Jason Henson 3-21-12 Clayel Criner 3-21-12
 Operation Owner Signature Date Landowner Signature Date

LAND USE CONTRACT

I, Barbara Hufley, Landowner, agree to allow Jason Aenson, Operation Owner, to land apply waste from his/her Hog Farm operation located in the 1/4 of Section 15 IV in Township 20 and Range _____ in _____ County to _____ acres of my property located in _____ County. A description of the areas to be used as land application sites are as follows:

Site No.	1/4 Section	Section	Township	Range	Latitude	Longitude	Available Acreage*

*Available acreage is the total acreage minus buffer zone areas.

I am also aware that the land applicator or the owner of the operation is to apply waste according to the management plan and guidelines and conditions set forth by the Arkansas Department of Environmental Quality.

In addition to these guidelines, the following requirements must also be satisfied when applying waste to my land:

Jason Aenson
Operation Owner Signature

Date

Barbara Hufley 11/1/11
Landowner Signature

Date

Section H: Soil Test Reports

SECTION H. SOIL TESTS REPORTS

Land application soil tests for nutrient application are attached. Prior to application the results will be recorded in the analysis sheets.

Cooperative Extension Service
Soil Analysis Report
Soil Testing And Research Laboratory
Marianna, AR 72360
<http://www.uark.edu/depts/soiltest>

The University of Arkansas is an equal opportunity/affirmative action institution

JASON HENSON	Client ID: 8706881318
HC 72 BOX 10	
MTN JUDEA	AR 72655
Date Processed:	2/17/2012
Field ID:	1
Acres	23
Lime Applied in the last 4 years:	No
Leveled in past 4 years:	No
Irrigation:	Unknown
County:	Pope
Lab Number:	36722
Sample Number:	931074

1. Nutrient Availability Index

Nutrient	Concentration		Soil Test Level (Mehlich 3)
	ppm	lb/acre	
P	83	166	Above Optimum
K	191	382	Above Optimum
Ca	1397	2794	--
Mg	114	228	--
SO4-S	16	32	--
Zn	4.4	8.8	--
Fe	123	246	--
Mn	205	410	--
Cu	1.0	2.0	--
B	0.0	0.0	--
NO3-N	24	48	--

2. Soil Properties

Property	Value	Units
Soil pH (1:2 soil-water)	6.6	--
Soil EC (1:2 soil-water)		umhos/cm
Soil ECEC	11	cmolc/kg
Organic Matter (Loss on Ignition)		%
Estimated Soil Texture	Silt Loam	

Estimated Base Saturation (%)				
Total	Ca	Mg	K	Na
77.2	63.6	8.7	4.5	0.5

3. Recommendations (Notice: State and/or federal nutrient management regulations may supersede these agronomic recommendations.)

Crop	N	P2O5	K2O	SO4S	Zn	B	Lime
Last Crop	Pasture (207)						
Crop 1	Warm-Season Grasses (MNT) (207)						
Crop 2	Warm-Season Grasses (MNT) (207)						
Crop 3							

4. Crop 1 Notes:

Apply the recommended rates of N, P, and K, in spring when night temperatures are > 60 degrees F for 1 week. For higher production, topdress an additional 60 lb N/Acre after every 4 to 6 weeks of grazing. For fall grazing apply 50 lb N/Acre in early August. Do not apply N after September 1.

5. Crop 2 Notes:

Apply the recommended rates of N, P, and K, in spring when night temperatures are > 60 degrees F for 1 week. For higher production, topdress an additional 60 lb N/Acre after every 4 to 6 weeks of grazing. For fall grazing apply 50 lb N/Acre in early August. Do not apply N after September 1.

6. Crop 3 Notes:

Cooperative Extension Service
Soil Analysis Report
Soil Testing And Research Laboratory
Marianna, AR 72360
<http://www.uark.edu/depts/soiltest>

The University of Arkansas is an equal opportunity/affirmative action institution

JASON HENSON	Client ID:	8706881318
HC 72 BOX 10		
MTN JUDEA	AR	72655
Date Processed:	2/17/2012	
Field ID:	2	
Acres	20	
Lime Applied in the last 4 years:	No	
Leveled in past 4 years:	No	
Irrigation:	Unknown	
County:	Pope	
Lab Number:	36723	
Sample Number:	931075	

1. Nutrient Availability Index

Nutrient	Concentration		Soil Test Level (Mehlich-3)
	ppm	lb/acre	
P	72	144	Above Optimum
K	224	448	Above Optimum
Ca	1247	2494	--
Mg	90	180	--
SO4-S	15	30	--
Zn	3.5	7.0	--
Fe	96	192	--
Mn	235	470	--
Cu	0.8	1.6	--
B	0.0	0.0	--
NO3-N	31	62	--

2. Soil Properties

Property	Value	Units
Soil pH (1:2 soil-water)	6.6	--
Soil EC (1:2 soil-water)		umhos/cm
Soil ECEC	10	cmolc/kg
Organic Matter (Loss on Ignition)		%
Estimated Soil Texture	Silt Loam	

Estimated Base Saturation (%)				
Total	Ca	Mg	K	Na
75.3	61.6	7.4	5.7	0.6

3. Recommendations (Notice: State and/or federal nutrient management regulations may supersede these agronomic recommendations.)

Crop		N	P2O5	K2O	SO4S	Zn	B	Lime
Last Crop	Pasture (207)	----- lb/acre -----						
Crop 1	Warm-Season Grasses (MNT) (207)	60	0	0	0	0	0	0
Crop 2	Warm-Season Grasses (MNT) (207)	60	0	0	0	0	0	0
Crop 3								

4. Crop 1 Notes:

Apply the recommended rates of N, P, and K, in spring when night temperatures are > 60 degrees F for 1 week. For higher production, topdress an additional 60 lb N/Acre after every 4 to 6 weeks of grazing. For fall grazing apply 50 lb N/Acre in early August. Do not apply N after September 1.

5. Crop 2 Notes:

Apply the recommended rates of N, P, and K, in spring when night temperatures are > 60 degrees F for 1 week. For higher production, topdress an additional 60 lb N/Acre after every 4 to 6 weeks of grazing. For fall grazing apply 50 lb N/Acre in early August. Do not apply N after September 1.

6. Crop 3 Notes:

U of A UNIVERSITY OF ARKANSAS

DIVISION OF AGRICULTURE

Cooperative Extension Service
 Soil Analysis Report
 Soil Testing And Research Laboratory
 Marianna, AR 72360
<http://www.uark.edu/depts/soiltest>

The University of Arkansas is an equal opportunity/affirmative action institution

JASON HENSON	Client ID: 8706881318
HC 72 BOX 10	
MTN JUDEA	AR 72655
Date Processed:	2/17/2012
Field ID:	3
Acres	30
Lime Applied in the last 4 years:	No
Leveled in past 4 years:	No
Irrigation:	Unknown
County:	Pope
Lab Number:	36724
Sample Number:	931076

1. Nutrient Availability Index

Nutrient	Concentration		Soil Test Level (Mehlich 3)
	ppm	lb/acre	
P	42	84	Optimum
K	65	130	Low
Ca	3329	6658	--
Mg	59	118	--
SO4-S	11	22	--
Zn	6.1	12.2	--
Fe	95	190	--
Mn	152	304	--
Cu	1.6	3.2	--
B	0.0	0.0	--
NO3-N	10	20	--

2. Soil Properties

Property	Value	Units
Soil pH (1:2 soil-water)	7.5	--
Soil EC (1:2 soil-water)		umhos/cm
Soil ECEC	19	cmolc/kg
Organic Matter (Loss on Ignition)		%
Estimated Soil Texture	Silty Clay Loam - Clay Loam	

Estimated Base Saturation (%)				
Total	Ca	Mg	K	Na
89.7	85.8	2.5	0.9	0.4

3. Recommendations (Notice: State and/or federal nutrient management regulations may supersede these agronomic recommendations.)

Crop	N	P2O5	K2O	SO4S	Zn	B	Lime
Last Crop	Pasture (207)						
Crop 1	Warm-Season Grasses (MNT) (207)						
Crop 2	Warm-Season Grasses (MNT) (207)						
Crop 3							

4. Crop 1 Notes:

Apply the recommended rates of N, P, and K, in spring when night temperatures are > 60 degrees F for 1 week. For higher production, topdress an additional 60 lb N/Acre after every 4 to 6 weeks of grazing. For fall grazing apply 50 lb N/Acre in early August. Do not apply N after September 1. If S deficiency has occurred previously on this field apply 20 lb SO4-S/Acre.

5. Crop 2 Notes:

Apply the recommended rates of N, P, and K, in spring when night temperatures are > 60 degrees F for 1 week. For higher production, topdress an additional 60 lb N/Acre after every 4 to 6 weeks of grazing. For fall grazing apply 50 lb N/Acre in early August. Do not apply N after September 1. If S deficiency has occurred previously on this field apply 20 lb SO4-S/Acre.

6. Crop 3 Notes:

Cooperative Extension Service
Soil Analysis Report
Soil Testing And Research Laboratory
Marianna, AR 72360
<http://www.uark.edu/depts/soiltest>

The University of Arkansas is an equal opportunity/affirmative action institution

JASON HENSON	Client ID: 8706881318
HC 72 BOX 10	
MTN JUDEA	AR 72655
Date Processed:	2/17/2012
Field ID:	4
Acres	13
Lime Applied in the last 4 years:	No
Leveled in past 4 years:	No
Irrigation:	Unknown
County:	Pope
Lab Number:	36725
Sample Number:	931077

1. Nutrient Availability Index

Nutrient	Concentration		Soil Test Level (Mehlich 3)
	ppm	lb/acre	
P	50	100	Optimum
K	120	240	Medium
Ca	1230	2460	--
Mg	118	236	--
SO4-S	12	24	--
Zn	2.7	5.4	--
Fe	135	270	--
Mn	46	92	--
Cu	0.7	1.4	--
B	0.0	0.0	--
NO3-N	15	30	--

2. Soil Properties

Property	Value	Units
Soil pH (1:2 soil-water)	5.6	---
Soil EC (1:2 soil-water)		umhos/cm
Soil ECEC	12	cmolc/kg
Organic Matter (Loss on Ignition)		%
Estimated Soil Texture	Silt Loam - Silty Clay Loam	

Estimated Base Saturation (%)				
Total	Ca	Mg	K	Na
62.5	51.3	8.2	2.6	0.4

3. Recommendations (Notice: State and/or federal nutrient management regulations may supersede these agronomic recommendations.)

Crop	N	P2O5	K2O	SO4S	Zn	B	Lime
Last Crop Pasture (207)	----- lb/acre -----						
Crop 1 Warm-Season Grasses (MNT) (207)	60	0	60	0	0	0	4000
Crop 2 Warm-Season Grasses (MNT) (207)	60	0	60	0	0	0	4000
Crop 3							

4. Crop 1 Notes:

Apply the recommended rates of N, P, and K, in spring when night temperatures are > 60 degrees F for 1 week. For higher production, topdress an additional 60 lb N/Acre after every 4 to 6 weeks of grazing. For fall grazing apply 50 lb N/Acre in early August. Do not apply N after September 1. If S deficiency has occurred previously on this field apply 20 lb SO4-S/Acre.

5. Crop 2 Notes:

Apply the recommended rates of N, P, and K, in spring when night temperatures are > 60 degrees F for 1 week. For higher production, topdress an additional 60 lb N/Acre after every 4 to 6 weeks of grazing. For fall grazing apply 50 lb N/Acre in early August. Do not apply N after September 1. If S deficiency has occurred previously on this field apply 20 lb SO4-S/Acre.

6. Crop 3 Notes:

Cooperative Extension Service
Soil Analysis Report
Soil Testing And Research Laboratory
Marianna, AR 72360
<http://www.uark.edu/depts/soiltest>

The University of Arkansas is an equal opportunity/affirmative action institution

JASON HENSON	Client ID: 8706881318
HC 72 BOX 10	
MTN JUDEA	AR 72655
Date Processed:	2/17/2012
Field ID:	5
Acres	40
Lime Applied in the last 4 years:	No
Leveled in past 4 years:	No
Irrigation:	Unknown
County:	Pope
Lab Number:	36726
Sample Number:	931078

1. Nutrient Availability Index

Nutrient	Concentration		Soil Test Level (Mehlich 3)
	ppm	lb/acre	
P	65	130	Above Optimum
K	108	216	Medium
Ca	2507	5014	--
Mg	118	236	--
SO4-S	12	24	--
Zn	6.1	12.2	--
Fe	134	268	--
Mn	128	256	--
Cu	1.7	3.4	--
B	0.0	0.0	--
NO3-N	15	30	--

2. Soil Properties

Property	Value	Units
Soil pH (1:2 soil-water)	6.7	---
Soil EC (1:2 soil-water)		umhos/cm
Soil ECEC	17	cmolc/kg
Organic Matter (Loss on Ignition)		%
Estimated Soil Texture	Silty Clay Loam - Clay Loam	

Estimated Base Saturation (%)				
Total	Ca	Mg	K	Na
82.2	74.4	5.8	1.6	0.3

3. Recommendations (Notice: State and/or federal nutrient management regulations may supersede these agronomic recommendations.)

Crop	N	P2O5	K2O	SO4S	Zn	B	Lime
Last Crop	Pasture (207)						
Crop 1	60	0	60	0	0	0	0
Crop 2	60	0	60	0	0	0	0
Crop 3							

4. Crop 1 Notes:

Apply the recommended rates of N, P, and K, in spring when night temperatures are > 60 degrees F for 1 week. For higher production, topdress an additional 60 lb N/Acre after every 4 to 6 weeks of grazing. For fall grazing apply 50 lb N/Acre in early August. Do not apply N after September 1. If S deficiency has occurred previously on this field apply 20 lb SO4-S/Acre.

5. Crop 2 Notes:

Apply the recommended rates of N, P, and K, in spring when night temperatures are > 60 degrees F for 1 week. For higher production, topdress an additional 60 lb N/Acre after every 4 to 6 weeks of grazing. For fall grazing apply 50 lb N/Acre in early August. Do not apply N after September 1. If S deficiency has occurred previously on this field apply 20 lb SO4-S/Acre.

6. Crop 3 Notes:

Cooperative Extension Service
Soil Analysis Report
Soil Testing And Research Laboratory
Marianna, AR 72360
<http://www.uark.edu/depts/soiltest>

The University of Arkansas is an equal opportunity/affirmative action institution.

JASON HENSON	Client ID: 8706881318
HC 72 BOX 10	
MTN JUDEA	AR 72655
Date Processed:	2/17/2012
Field ID:	6
Acres	40
Lime Applied in the last 4 years:	No
Leveled in past 4 years:	No
Irrigation:	Unknown
County:	Pope
Lab Number:	36727
Sample Number:	931079

1. Nutrient Availability Index

Nutrient	Concentration		Soil Test Level (Mehlich 3)
	ppm	lb/acre	
P	76	152	Above Optimum
K	136	272	Optimum
Ca	876	1752	--
Mg	59	118	--
SO4-S	13	26	--
Zn	2.1	4.2	--
Fe	128	256	--
Mn	188	376	--
Cu	0.5	1.0	--
B	0.0	0.0	--
NO3-N	15	30	--

2. Soil Properties

Property	Value	Units
Soil pH (1:2 soil-water)	6.2	---
Soil EC (1:2 soil-water)		umhos/cm
Soil ECEC	8	cmolc/kg
Organic Matter (Loss on Ignition)		%
Estimated Soil Texture	Silt Loam	

Estimated Base Saturation (%)				
Total	Ca	Mg	K	Na
67.8	56.4	6.3	4.5	0.6

3. Recommendations (Notice: State and/or federal nutrient management regulations may supersede these agronomic recommendations.)

Crop		N	P2O5	K2O	SO4S	Zn	B	Lime
		lb/acre						
Last Crop	Pasture (207)							
Crop 1	Warm-Season Grasses (MNT) (207)	60	0	0	0	0	0	0
Crop 2	Warm-Season Grasses (MNT) (207)	60	0	0	0	0	0	0
Crop 3								

4. Crop 1 Notes:

Apply the recommended rates of N, P, and K, in spring when night temperatures are > 60 degrees F for 1 week. For higher production, topdress an additional 60 lb N/Acre after every 4 to 6 weeks of grazing. For fall grazing apply 50 lb N/Acre in early August. Do not apply N after September 1.

5. Crop 2 Notes:

Apply the recommended rates of N, P, and K, in spring when night temperatures are > 60 degrees F for 1 week. For higher production, topdress an additional 60 lb N/Acre after every 4 to 6 weeks of grazing. For fall grazing apply 50 lb N/Acre in early August. Do not apply N after September 1.

6. Crop 3 Notes:

Cooperative Extension Service
Soil Analysis Report
Soil Testing And Research Laboratory
Marianna, AR 72360
<http://www.uark.edu/depts/soiltest>

The University of Arkansas is an equal opportunity/affirmative action institution

JASON HENSON	Client ID: 8706881318
HC 72 BOX 10	
MTN JUDEA	AR 72655
Date Processed:	2/17/2012
Field ID:	7
Acres	150
Lime Applied in the last 4 years:	No
Leveled in past 4 years:	No
Irrigation:	Unknown
County:	Pope
Lab Number:	36728
Sample Number:	931080

1. Nutrient Availability Index

Nutrient	Concentration		Soil Test Level (Mehlich 3)
	ppm	lb/acre	
P	178	356	Above Optimum
K	207	414	Above Optimum
Ca	1228	2456	--
Mg	154	308	--
SO4-S	14	28	--
Zn	14.5	29.0	--
Fe	218	436	--
Mn	168	336	--
Cu	3.2	6.4	--
B	0.0	0.0	--
NO3-N	12	24	--

2. Soil Properties

Property	Value	Units
Soil pH (1:2 soil-water)	6.3	--
Soil EC (1:2 soil-water)		umhos/cm
Soil ECEC	11	cmolc/kg
Organic Matter (Loss on Ignition)		%
Estimated Soil Texture	Silt Loam	

Estimated Base Saturation (%)				
Total	Ca	Mg	K	Na
72.8	55.7	11.6	4.8	0.7

3. Recommendations (Notice: State and/or federal nutrient management regulations may supersede these agronomic recommendations.)

Crop	N	P2O5	K2O	SO4S	Zn	B	Lime
Last Crop	Pasture (207) ----- lb/acre -----						
Crop 1	60	0	0	0	0	0	0
Crop 2	60	0	0	0	0	0	0
Crop 3							

4. Crop 1 Notes:

Apply the recommended rates of N, P, and K, in spring when night temperatures are > 60 degrees F for 1 week. For higher production, topdress an additional 60 lb N/Acre after every 4 to 6 weeks of grazing. For fall grazing apply 50 lb N/Acre in early August. Do not apply N after September 1.

5. Crop 2 Notes:

Apply the recommended rates of N, P, and K, in spring when night temperatures are > 60 degrees F for 1 week. For higher production, topdress an additional 60 lb N/Acre after every 4 to 6 weeks of grazing. For fall grazing apply 50 lb N/Acre in early August. Do not apply N after September 1.

6. Crop 3 Notes:

UNIVERSITY OF ARKANSAS
DIVISION OF AGRICULTURE

Cooperative Extension Service
Soil Analysis Report
Soil Testing And Research Laboratory
Marianna, AR 72360
<http://www.uark.edu/depts/soiltest>

The University of Arkansas is an equal opportunity/affirmative action institution

JASON HENSON	Client ID:	8706881318
HC 72 BOX 10		
MTN JUDEA	AR	72655
Date Processed:	2/17/2012	
Field ID:	8	
Acres	12	
Lime Applied in the last 4 years:	No	
Leveled in past 4 years:	No	
Irrigation:	Unknown	
County:	Pope	
Lab Number:	36729	
Sample Number:	931081	

Nutrient Availability Index

Nutrient	Concentration		Soil Test Level (Mehlich 3)
	ppm	lb/acre	
	46	92	Optimum
	45	90	Very Low
	1948	3896	--
	52	104	--
	8	16	--
	2.1	4.2	--
	124	248	--
	193	386	--
	0.8	1.6	--
	0.0	0.0	--
	6	12	--

2. Soil Properties

Property	Value	Units
Soil pH (1:2 soil-water)	7.0	--
Soil EC (1:2 soil-water)		umhos/cm
Soil ECEC	12	cmolc/kg
Organic Matter (Loss on Ignition)		%
Estimated Soil Texture	Silt Loam - Silty Clay Loam	

Estimated Base Saturation (%)				
Total	Ca	Mg	K	Na
83.8	78.9	3.5	0.9	0.5

Recommendations (Notice: State and/or federal nutrient management regulations may supersede these agronomic recommendations.)

Crop	N	P2O5	K2O	SO4S	Zn	B	Lime
Pasture (207)	----- lb/acre -----						
Warm-Season Grasses (MNT) (207)	60	0	160	0	0	0	0
Warm-Season Grasses (MNT) (207)	60	0	160	0	0	0	0

Top 1 Notes:

Use recommended rates of N, P, and K, in spring when night temperatures are > 60 degrees F for 1 week. For higher production, topdress an additional 10 lb N/Acre after every 4 to 6 weeks of grazing. For fall grazing apply 50 lb N/Acre in early August. Do not apply N after September 1. If nutrient deficiency has occurred previously on this field apply 20 lb SO4-S/Acre.

Top 2 Notes:

Use recommended rates of N, P, and K, in spring when night temperatures are > 60 degrees F for 1 week. For higher production, topdress an additional 10 lb N/Acre after every 4 to 6 weeks of grazing. For fall grazing apply 50 lb N/Acre in early August. Do not apply N after September 1. If nutrient deficiency has occurred previously on this field apply 20 lb SO4-S/Acre.

Top 3 Notes:

U of A UNIVERSITY OF ARKANSAS DIVISION OF AGRICULTURE

Cooperative Extension Service
Soil Analysis Report
Soil Testing And Research Laboratory
Marianna, AR 72360
<http://www.uark.edu/depts/soiltest>

The University of Arkansas is an equal opportunity/affirmative action institution

JASON HENSON	Client ID:	8706881318
HC 72 BOX 10		
MTN JUDEA	AR	72655
Date Processed:	2/17/2012	
Field ID:	9	
Acres	40	
Lime Applied in the last 4 years:	No	
Leveled in past 4 years:	No	
Irrigation:	Unknown	
County:	Pope	
Lab Number:	36730	
Sample Number:	931082	

1. Nutrient Availability Index

Nutrient	Concentration		Soil Test Level (Mehlich 3)
	ppm	lb/acre	
P	52	104	Above Optimum
K	45	90	Very Low
Ca	2276	4552	--
Mg	59	118	--
SO4-S	9	18	--
Zn	1.6	3.2	--
Fe	121	242	--
Mn	109	218	--
Cu	1.3	2.6	--
B	0.0	0.0	--
NO3-N	7	14	--

2. Soil Properties

Property	Value	Units
Soil pH (1:2 soil-water)	7.2	--
Soil EC (1:2 soil-water)		umhos/cm
Soil ECEC	14	cmolc/kg
Organic Matter (Loss on Ignition)		%
Estimated Soil Texture	Silt Loam - Silty Clay Loam	

Estimated Base Saturation (%)				
Total	Ca	Mg	K	Na
85.8	81.0	3.5	0.8	0.4

3. Recommendations (Notice: State and/or federal nutrient management regulations may supersede these agronomic recommendations.)

Crop	N	P2O5	K2O	SO4S	Zn	B	Lime
Last Crop	Pasture (207)						
Crop 1	60	0	160	0	0	0	0
Crop 2	60	0	160	0	0	0	0
Crop 3							

4. Crop 1 Notes:

Apply the recommended rates of N, P, and K, in spring when night temperatures are > 60 degrees F for 1 week. For higher production, topdress an additional 60 lb N/Acre after every 4 to 6 weeks of grazing. For fall grazing apply 50 lb N/Acre in early August. Do not apply N after September 1. If S deficiency has occurred previously on this field apply 20 lb SO4-S/Acre.

5. Crop 2 Notes:

Apply the recommended rates of N, P, and K, in spring when night temperatures are > 60 degrees F for 1 week. For higher production, topdress an additional 60 lb N/Acre after every 4 to 6 weeks of grazing. For fall grazing apply 50 lb N/Acre in early August. Do not apply N after September 1. If S deficiency has occurred previously on this field apply 20 lb SO4-S/Acre.

6. Crop 3 Notes:

Cooperative Extension Service
Soil Analysis Report
Soil Testing And Research Laboratory
Marianna, AR 72360
<http://www.uark.edu/depts/soiltest>

The University of Arkansas is an equal opportunity/affirmative action institution.

JASON HENSON	Client ID:	8706881318
HC 72 BOX 10		
MTN JUDEA	AR	72655
Date Processed:	2/17/2012	
Field ID:	10	
Acres	.35	
Lime Applied in the last 4 years:	No	
Leveled in past 4 years:	No	
Irrigation:	Unknown	
County:	Pope	
Lab Number:	36731	
Sample Number:	931083	

1. Nutrient Availability Index

Nutrient	Concentration		Soil Test Level (Mehlich 3)
	ppm	lb/acre	
P	69	138	Above Optimum
K	114	228	Medium
Ca	2153	4306	--
Mg	99	198	--
SO4-S	13	26	--
Zn	3.8	7.6	--
Fe	157	314	--
Mn	135	270	--
Cu	1.3	2.6	--
B	0.0	0.0	--
NO3-N	132	264	--

2. Soil Properties

Property	Value	Units
Soil pH (1:2 soil-water)	6.8	---
Soil EC (1:2 soil-water)		umhos/cm
Soil ECEC	14	cmolc/kg
Organic Matter (Loss on Ignition)		%
Estimated Soil Texture	Silty Clay Loam - Clay Loam	

Estimated Base Saturation (%)				
Total	Ca	Mg	K	Na
82.7	74.4	5.7	2.0	0.6

3. Recommendations (Notice: State and/or federal nutrient management regulations may supersede these agronomic recommendations.)

Crop	N	P2O5	K2O	SO4S	Zn	B	Lime
Last Crop	Pasture (207)						
Crop 1	60	0	60	0	0	0	0
Crop 2	60	0	60	0	0	0	0
Crop 3							

4. Crop 1 Notes:

Apply the recommended rates of N, P, and K, in spring when night temperatures are > 60 degrees F for 1 week. For higher production, topdress an additional 60 lb N/Acre after every 4 to 6 weeks of grazing. For fall grazing apply 50 lb N/Acre in early August. Do not apply N after September 1.

5. Crop 2 Notes:

Apply the recommended rates of N, P, and K, in spring when night temperatures are > 60 degrees F for 1 week. For higher production, topdress an additional 60 lb N/Acre after every 4 to 6 weeks of grazing. For fall grazing apply 50 lb N/Acre in early August. Do not apply N after September 1.

6. Crop 3 Notes:

Cooperative Extension Service
Soil Analysis Report
Soil Testing And Research Laboratory
Marianna, AR 72360
<http://www.uark.edu/depts/soiltest>

The University of Arkansas is an equal opportunity/affirmative action institution

JASON HENSON	Client ID:	8706881318
HC 72 BOX 10		
MTN JUDEA	AR	72655
Date Processed:	2/17/2012	
Field ID:	11	
Acres	20	
Lime Applied in the last 4 years:	No	
Leveled in past 4 years:	No	
Irrigation:	Unknown	
County:	Pope	
Lab Number:	36732	
Sample Number:	931084	

1. Nutrient Availability Index

Nutrient	Concentration		Soil Test Level (Mehlich 3)
	ppm	lb/acre	
P	57	114	Above Optimum
K	292	584	Above Optimum
Ca	737	1474	--
Mg	170	340	--
SO4-S	17	34	--
Zn	2.9	5.8	--
Fe	132	264	--
Mn	92	184	--
Cu	0.6	1.2	--
B	0.0	0.0	--
NO3-N	46	92	--

2. Soil Properties

Property	Value	Units
Soil pH (1:2 soil-water)	5.3	--
Soil EC (1:2 soil-water)		umhos/cm
Soil ECEC	10	cmolc/kg
Organic Matter (Loss on Ignition)		%
Estimated Soil Texture	Silt Loam	

Estimated Base Saturation (%)				
Total	Ca	Mg	K	Na
56.8	35.4	13.6	7.2	0.6

3. Recommendations (Notice: State and/or federal nutrient management regulations may supersede these agronomic recommendations.)

Crop		N	P2O5	K2O	SO4S	Zn	B	Lime
Last Crop	Pasture (207)	----- lb/acre -----						
Crop 1	Warm-Season Grasses (MNT) (207)	60	0	0	0	0	0	5000
Crop 2	Warm-Season Grasses (MNT) (207)	60	0	0	0	0	0	5000
Crop 3								

4. Crop 1 Notes:

Apply the recommended rates of N, P, and K, in spring when night temperatures are > 60 degrees F for 1 week. For higher production, topdress an additional 60 lb N/Acre after every 4 to 6 weeks of grazing. For fall grazing apply 50 lb N/Acre in early August. Do not apply N after September 1.

5. Crop 2 Notes:

Apply the recommended rates of N, P, and K, in spring when night temperatures are > 60 degrees F for 1 week. For higher production, topdress an additional 60 lb N/Acre after every 4 to 6 weeks of grazing. For fall grazing apply 50 lb N/Acre in early August. Do not apply N after September 1.

6. Crop 3 Notes:

Cooperative Extension Service
Soil Analysis Report
Soil Testing And Research Laboratory
Marianna, AR 72360
<http://www.uark.edu/depts/soiltest>

The University of Arkansas is an equal opportunity/affirmative action institution

JASON HENSON	Client ID:	8706881318
HC 72 BOX 10		
MTN JUDEA	AR	72655
Date Processed:	2/17/2012	
Field ID:	12	
Acres	30	
Lime Applied in the last 4 years:	No	
Leveled in past 4 years:	No	
Irrigation:	Unknown	
County:	Pope	
Lab Number:	36715	
Sample Number:	931063	

1. Nutrient Availability Index

Nutrient	Concentration		Soil Test Level (Mehlich 3)
	ppm	lb/acre	
P	19	38	Low
K	52	104	Very Low
Ca	1173	2346	--
Mg	26	52	--
SO4-S	8	16	--
Zn	1.6	3.2	--
Fe	101	202	--
Mn	326	652	--
Cu	0.8	1.6	--
B	0.0	0.0	--
NO3-N	12	24	--

2. Soil Properties

Property	Value	Units
Soil pH (1:2 soil-water)	6.9	--
Soil EC (1:2 soil-water)		umhos/cm
Soil ECEC	9	cmolc/kg
Organic Matter (Loss on Ignition)		%
Estimated Soil Texture	Silt Loam	

Estimated Base Saturation (%)				
Total	Ca	Mg	K	Na
71.5	66.9	2.5	1.5	0.6

3. Recommendations (Notice: State and/or federal nutrient management regulations may supersede these agronomic recommendations.)

Crop	N	P2O5	K2O	SO4S	Zn	B	Lime
Last Crop	Pasture (207)						
Crop 1	60	70	160	0	0	0	0
Crop 2							
Crop 3							

4. Crop 1 Notes:

Apply the recommended rates of N, P, and K, in spring when night temperatures are > 60 degrees F for 1 week. For higher production, topdress an additional 60 lb N/Acre after every 4 to 6 weeks of grazing. For fall grazing apply 50 lb N/Acre in early August. Do not apply N after September 1. If S deficiency has occurred previously on this field apply 20 lb SO4-S/Acre.

5. Crop 2 Notes:

6. Crop 3 Notes:

U of A UNIVERSITY OF ARKANSAS DIVISION OF AGRICULTURE

Cooperative Extension Service
Soil Analysis Report
Soil Testing And Research Laboratory
Marianna, AR 72360
<http://www.uark.edu/depts/soiltest>

The University of Arkansas is an equal opportunity/affirmative action institution

JASON HENSON	Client ID:	8706881318
HC 72 BOX 10		
MTN JUDEA	AR	72655
Date Processed:	2/17/2012	
Field ID:	13	
Acres	60	
Lime Applied in the last 4 years:	No	
Leveled in past 4 years:	No	
Irrigation:	Unknown	
County:	Pope	
Lab Number:	36716	
Sample Number:	931064	

1. Nutrient Availability Index

Nutrient	Concentration		Soil Test Level (Mehlich 3)
	ppm	lb/acre	
P	48	96	Optimum
K	165	330	Optimum
Ca	1626	3252	--
Mg	131	262	--
SO4-S	15	30	--
Zn	5.6	11.2	--
Fe	84	168	--
Mn	409	818	--
Cu	0.7	1.4	--
B	0.0	0.0	--
NO3-N	29	58	--

2. Soil Properties

Property	Value	Units
Soil pH (1:2 soil-water)	7.1	--
Soil EC (1:2 soil-water)		umhos/cm
Soil ECEC	12	cmolc/kg
Organic Matter (Loss on Ignition)		%
Estimated Soil Texture	Silt Loam	

Estimated Base Saturation (%)				
Total	Ca	Mg	K	Na
82.9	69.6	9.3	3.6	0.3

3. Recommendations (Notice: State and/or federal nutrient management regulations may supersede these agronomic recommendations.)

Crop	N	P2O5	K2O	SO4S	Zn	B	Lime
Last Crop	Pasture (207)						
Crop 1	60	0	0	0	0	0	0
Crop 2							
Crop 3							

4. Crop 1 Notes:

Apply the recommended rates of N, P, and K, in spring when night temperatures are > 60 degrees F for 1 week. For higher production, topdress an additional 60 lb N/Acre after every 4 to 6 weeks of grazing. For fall grazing apply 50 lb N/Acre in early August. Do not apply N after September 1.

5. Crop 2 Notes:

6. Crop 3 Notes:

U of A UNIVERSITY OF ARKANSAS DIVISION OF AGRICULTURE

Cooperative Extension Service
Soil Analysis Report
Soil Testing And Research Laboratory
Marianna, AR 72360
<http://www.uark.edu/depts/soiltest>

The University of Arkansas is an equal opportunity/affirmative action institution

JASON HENSON	Client ID:	8706881318
HC 72 BOX 10		
MTN. JUDEA	AR	72655
Date Processed:	2/17/2012	
Field ID:	14	
Acres	15	
Lime Applied in the last 4 years:	No	
Leveled in past 4 years:	No	
Irrigation:	Unknown	
County:	Pope	
Lab Number:	36717	
Sample Number:	931065	

1. Nutrient Availability Index

Nutrient	Concentration		Soil Test Level (Mehlich 3)
	ppm	lb/acre	
P	52	104	Above Optimum
K	144	288	Optimum
Ca	2840	5680	--
Mg	89	178	--
SO4-S	12	24	--
Zn	10.8	21.6	--
Fe	83	166	--
Mn	254	508	--
Cu	1.3	2.6	--
B	0.3	0.6	--
NO3-N	27	54	--

2. Soil Properties

Property	Value	Units
Soil pH (1:2 soil-water)	7.8	--
Soil EC (1:2 soil-water)		umhos/cm
Soil ECEC	17	cmolc/kg
Organic Matter (Loss on Ignition)		%
Estimated Soil Texture	Silty Clay Loam - Clay Loam	

Estimated Base Saturation (%)				
Total	Ca	Mg	K	Na
88.5	81.8	4.3	2.1	0.2

3. Recommendations (Notice: State and/or federal nutrient management regulations may supersede these agronomic recommendations.)

Crop	N	P2O5	K2O	SO4S	Zn	B	Lime
Last Crop Pasture (207)	----- lb/acre -----						
Crop 1 Warm-Season Grasses (MNT) (207)	60	0	0	0	0	0	0
Crop 2							
Crop 3							

4. Crop 1 Notes:

Apply the recommended rates of N, P, and K; in spring when night temperatures are > 60 degrees F for 1 week. For higher production, topdress-an additional 60 lb N/Acre after every 4 to 6 weeks of grazing. For fall grazing apply 50 lb N/Acre in early August. Do not apply N after September 1. If S deficiency has occurred previously on this field apply 20 lb SO4-S/Acre.

5. Crop 2 Notes:

6. Crop 3 Notes:

U of A UNIVERSITY OF ARKANSAS

DIVISION OF AGRICULTURE

Cooperative Extension Service
Soil Analysis Report
 Soil Testing And Research Laboratory
 Marianna, AR 72360
<http://www.uark.edu/depts/soiltest>

The University of Arkansas is an equal opportunity/affirmative action institution

JASON HENSON HC 72 BOX 10 MTN JUDEA	Client ID: 8706881318 AR 72655
Date Processed:	2/17/2012
Field ID:	15
Acres:	65
Lime Applied in the last 4 years:	No
Leveled in past 4 years:	No
Irrigation:	Unknown
County:	Pope
Lab Number:	36718
Sample Number:	931066

1. Nutrient Availability Index

Nutrient	Concentration		Soil Test Level (Mehlich-3)
	ppm	lb/acre	
P	15	30	Very Low
K	86	172	Low
Ca	525	1050	--
Mg	50	100	--
SO4-S	11	22	--
Zn	1.8	3.6	--
Fe	110	220	--
Mn	382	764	--
Cu	0.4	0.8	--
B	0.0	0.0	--
NO3-N	10	20	--

2. Soil Properties

Property	Value	Units
Soil pH (1:2 soil-water)	5.8	---
Soil EC (1:2 soil-water)		umhos/cm
Soil ECEC	7	cmolc/kg
Organic Matter (Loss on Ignition)		%
Estimated Soil Texture	Silt Loam	

Estimated-Base Saturation (%)				
Total	Ca	Mg	K	Na
45.3	35.9	5.7	3.0	0.8

3. Recommendations (Notice: State and/or federal nutrient management regulations may supersede these agronomic recommendations.)

Crop	N	P2O5	K2O	SO4S	Zn	B	Lime
Last Crop	----- lb/acre -----						
Crop 1	60	100	110	0	0	0	0
Crop 2							
Crop 3							

4. Crop 1 Notes:

Apply the recommended rates of N, P, and K, in spring when night temperatures are > 60 degrees F for 1 week. For higher production, topdress an additional 60 lb N/Acre after every 4 to 6 weeks of grazing. For fall grazing apply 50 lb N/Acre in early August. Do not apply N after September 1.
 If S deficiency has occurred previously on this field apply 20 lb SO4-S/Acre.

5. Crop 2 Notes:

6. Crop 3 Notes:

U of A UNIVERSITY OF ARKANSAS DIVISION OF AGRICULTURE

Cooperative Extension Service
Soil Analysis Report
Soil Testing And Research Laboratory
Marianna, AR 72360
<http://www.uark.edu/depts/soiltest>

The University of Arkansas is an equal opportunity/affirmative action institution

JASON HENSON	Client ID: 8706881318
HC 72 BOX 10	
MTN JUDEA	AR 72655
Date Processed:	2/17/2012
Field ID:	16
Acres	60
Lime Applied in the last 4 years:	No
Leveled in past 4 years:	No
Irrigation:	Unknown
County:	Pope
Lab Number:	36719
Sample Number:	931067

1. Nutrient Availability Index

Nutrient	Concentration		Soil Test Level (Mehlich 3)
	ppm	lb/acre	
P	48	96	Optimum
K	160	320	Optimum
Ca	632	1264	--
Mg	89	178	--
SO4-S	11	22	--
Zn	2.4	4.8	--
Fe	136	272	--
Mn	142	284	--
Cu	0.8	1.6	--
B	0.0	0.0	--
NO3-N	6	12	--

2. Soil Properties

Property	Value	Units
Soil pH (1:2 soil-water)	5.4	--
Soil EC (1:2 soil-water)		umhos/cm
Soil ECEC	9	cmolc/kg
Organic Matter (Loss on Ignition)		%
Estimated Soil Texture	Silt Loam	

Estimated Base Saturation (%)				
Total	Ca	Mg	K	Na
49.2	35.6	8.4	4.6	0.6

3. Recommendations (Notice: State and/or federal nutrient management regulations may supersede these agronomic recommendations.)

Crop	N	P2O5	K2O	SO4S	Zn	B	Lime
Last Crop	Pasture (207)						
Crop 1	60	0	0	0	0	0	5000
Crop 2							
Crop 3							

4. Crop 1 Notes:

Apply the recommended rates of N, P, and K, in spring when night temperatures are > 60 degrees F for 1 week. For higher production, topdress an additional 60 lb N/Acre after every 4 to 6 weeks of grazing. For fall grazing apply 50 lb N/Acre in early August. Do not apply N after September 1. If S deficiency has occurred previously on this field apply 20 lb SO4-S/Acre.

5. Crop 2 Notes:

6. Crop 3 Notes:

Cooperative Extension Service
Soil Analysis Report
Soil Testing And Research Laboratory
Marianna, AR 72360
<http://www.uark.edu/depts/soiltest>

The University of Arkansas is an equal opportunity/affirmative action institution

JASON HENSON	Client ID: 8706881318
HC 72 BOX 10	
MTN JUDEA	AR 72655
Date Processed:	2/17/2012
Field ID:	17
Acres:	110
Lime Applied in the last 4 years:	No
Leveled in past 4 years:	No
Irrigation:	Unknown
County:	Pope
Lab Number:	36720
Sample Number:	931068

1. Nutrient Availability Index

Nutrient	Concentration		Soil Test Level (Mehlich 3)
	ppm	lb/acre	
P	50	100	Optimum
K	57	114	Very Low
Ca	1641	3282	--
Mg	49	98	--
SO4-S	10	20	--
Zn	3.6	7.2	±
Fe	139	278	--
Mn	181	362	--
Cu	1.0	2.0	--
B	0.0	0.0	--
NO3-N	15	30	--

2. Soil Properties

Property	Value	Units
Soil pH (1:2 soil-water)	7.5	--
Soil EC (1:2 soil-water)		umhos/cm
Soil ECEC	11	cmolc/kg
Organic Matter (Loss on Ignition)		%
Estimated Soil Texture	Silt Loam	

Estimated Base Saturation (%)				
Total	Ca	Mg	K	Na
81.5	75.9	3.8	1.4	0.5

3. Recommendations (Notice: State and/or federal nutrient management regulations may supersede these agronomic recommendations.)

Crop	N	P2O5	K2O	SO4S	Zn	B	Lime
Last Crop Pasture (207)	----- lb/acre -----						
Crop 1 Warm-Season Grasses (MNT) (207)	60	0	160	0	0	0	0
Crop 2							
Crop 3							

4. Crop 1 Notes:

Apply the recommended rates of N, P, and K, in spring when night temperatures are > 60 degrees F for 1 week. For higher production, topdress an additional 60 lb N/Acre after every 4 to 6 weeks of grazing. For fall grazing apply 50 lb N/Acre in early August. Do not apply N after September 1. If S deficiency has occurred previously on this field apply 20 lb SO4-S/Acre.

5. Crop 2 Notes:

6. Crop 3 Notes:

Section I: Nutrient Test Results and How to

SECTION I. NUTRIENT TESTS RESULTS & HOW TO

The nutrient tests have not been conducted at this time; however, the nutrient tests will be conducted prior to application and recorded on the log forms shown in Section N.

Laboratories Providing Manure Testing Services

- Agvise Laboratories
902 13th St. N, P.O. Box 187
Benson, MN 56215
(320) 843-4109
<http://www.agviselabs.com>
- A&L Heartland Labs, Inc.
111 Linn Street, P.O. Box 455
Atlantic, IA 50022
(800) 434-0109
(712) 243-5213
<http://allabs.com>
- Servi-Tech Laboratories
1602 Park Dr. West
Hastings, NE 68902
(402) 463-3522
(800) 557-7509
<http://www.servitechlabs.com>
- Ward Laboratories
4007 Cherry Ave., P.O. Box 788
Kearney, NE 68848
(308) 234-2418
(800) 887-7645
<http://www.wardlab.com/>
- Midwest Laboratories
13611 "B" St.
Omaha, NE 68144
(402) 334-7770
<https://www.midwestlabs.com/>
- Stearns DHIA Laboratories
825 12th Street South, PO Box 227
Sauk Centre, MN 56378
(320) 352-2028
<http://www.stearnsdhialab.com/>
- University of Arkansas
1366 West Altheimer Dr
Fayetteville, AR 72704
(479) 575-3908

How to Sample Manure for Nutrient Analysis

A field-by-field nutrient management program requires multiple components to maintain adequate fertility for crop growth and development. A well-designed soil sampling plan, including proper soil test interpretations along with manure sampling, manure nutrient analysis, equipment calibration, appropriate application rates and application methods are all necessary components of a nutrient management plan. Implementing these components allows manure to be recognized and used as a credible nutrient resource, potentially reducing input costs and the potential of environmental impacts.

Animal manure has long been used as a source of nutrients for crop growth. Standard nutrient values are guides to determine the amount of nutrients that animal manure will supply as a fertilizer source. Iowa State University Extension publication, *Managing Manure Nutrients for Crop Production* (PM 1811), recommends manure nutrient content and credits by type of animal, handling system and application methods.

While "book values" like those in PM-1811 are reasonable average values, an individual farm's manure analyses can vary from those averages by 50 percent or more. Species, age of animal, feed rations, water use, bedding type, management, and other factors make every farm's manure different. Two key factors affecting the nutrient content of manure are manure handling and type of storage structures used. Each handling system results in different types of nutrient losses—some unavoidable and others that can be controlled to a certain degree. Because every livestock production and manure management system is unique, the best way to assess manure nutrients is by sampling and analyzing the manure at a laboratory.

This publication describes how to sample solid, semi-solid, and liquid manure. Manure with greater than 20 percent solids (by weight) is classified as dry manure and is handled as a solid, usually with box-type spreaders. Manure with 10 to 20 percent solids is classified as semi-solid manure and can usually be handled as a liquid. Semi-solid manure usually requires the use of chopper pumps to provide thorough agitation before pumping. Manure with less than 10 percent solids is classified as liquid manure and is handled with pumps, pipes, tank wagons, and irrigation equipment.

A representative manure sample is needed to provide an accurate reflection of the nutrient content. Unfortunately, manure nutrient content is not uniform within storage structures, so obtaining a representative sample can be challenging. Mixing and sampling strategies should therefore insure that samples simulate as closely as possible the type of manure that will be applied.

When to Sample Manure

Sampling manure prior to application will ensure that you receive the analysis in time to adjust nutrient application rates based on the nutrient concentration of the manure. However, sampling manure prior to application may not completely reflect the nutrient concentration of the manure due to storage and handling losses if long periods of time pass before application begins or when liquid storage facilities are not adequately agitated while sampling. "Pre-sampling" such as dipping samples off the top of storage structure for nitrogen (N) and potassium (K) concentrations, can be done to estimate application rates. (See page 3 for more on pre-sampling). Producers must remember to go back and determine the actual nutrient rates applied by using manure samples collected during application and calculating volumes.

For best results, manure should be sampled at the time of application or as close as possible to application. Sampling during application will help to ensure that samples are well-mixed and representative of the manure being applied. Because manure nutrient analysis typically takes several days at a lab, sampling at the time of application will not provide immediate manure nutrient recommendations. The results can, however, be used for subsequent manure applications and to adjust commercial fertilizer application. This is why it is important to develop a manure sampling history and use those analyses in a nutrient management plan. A manure sampling history will also help you recognize if unplanned changes have occurred to your system if management and other factors have remained constant. A manure sampling history will give you confidence in using manure, and show you how consistent nutrient concentration is from year to year.

Take manure samples annually for three years for new facilities, followed with samples every three to five years, unless animal management practices, feed rations, or manure handling and storage methods change drastically from present methods. If you apply manure several times a

year, take samples when you plan to apply the bulk of manure. For example, it may be appropriate to sample in the spring when manure that has accumulated all winter will be applied. If storages are emptied twice a year, it may be necessary to sample in both spring and fall since the different storage temperatures in summer versus winter will affect manure nutrient levels. *NOTE: Implementation of future federal regulations may require concentrated animal feeding operations (> 1,000 animal units) to sample annually. Please check state and federal requirements to determine sampling frequency.*

How to Sample Semi-Solid or Liquid Manure

In liquid and semi-solid systems, settled solids can contain over 90 percent of the phosphorus (P), so complete agitation is needed to accurately sample the entire storage if all the manure in the storage structure is going to be applied. If, however, solids will purposely be left on the bottom of the storage structure when the manure is pumped out, as is sometimes the case with lagoons, then complete agitation during sampling may generate artificially high nutrient values. In this case agitation of the solids or sludge on the bottom of a lagoon is not needed for nutrient analysis.

Liquid manure is best sampled during land application, for it is potentially more difficult and dangerous to sample from liquid storage facilities than dry manure systems. When sampling manure during application is not possible, or pre-application analysis is desired for determining rates, refer to the section on sampling from a storage facility. If sampling from a liquid storage facility, use caution to prevent accidents, such as falling into the manure storage facility or being overcome with hazardous gases produced by manure. Have two people present at all times. Never enter confined manure storage spaces without appropriate safety gear such as a self-contained breathing apparatus.

Ideally, liquid manure should be agitated so a representative sample can be obtained for laboratory analysis. When agitating a storage pit below a building, be sure to provide adequate ventilation for both animals and humans. When agitating outdoor unformed pits, monitor activities closely to prevent erosion of berms or destruction of pit liners.

Liquid Manure Sample Preparation

All liquid samples should be handled as follows:

- Prior to sampling label a plastic bottle with your name, date and sample identification number using a waterproof pen.
- If the sample cannot be mailed or transported to a laboratory within a few hours, it should be frozen. Place the container in a tightly sealed plastic bag and keep it cold or frozen until it arrives at the laboratory.
- Most manure analysis laboratories do have plastic bottles available for sample collection. Do not use glass containers, as expansion of the gases in the sample can cause the container to break.

Liquid Manure Sampling During Land Application

Liquid Manure Applied with Tank Wagons

- Since settling begins as soon as agitation stops, samples should be collected as soon as possible after the manure tank wagon is filled unless the tanker has an agitator.
- Immediately after filling the tank wagon, use a clean plastic pail to collect manure from the loading or unloading port or the opening near the bottom of the tank. Be

sure the port or opening does not have a solids accumulation from prior loads.

- Use a ladle to stir the sample in the bucket to get the solids spinning in suspension. While the liquid is spinning remove a ladle full and carefully pour in the sample bottle. See Figure 1.
- Repeat this procedure and take another sample until the sample bottle is three-quarters full (Make sure the manure solids have not settled to the bottom of the bucket as each ladle is extracted; it is important to

include the solids in the sample). Screw the lid on tightly.



Figure 1. Collecting a liquid manure sample.

Liquid Manure Applied by Irrigation Systems

- Place catch pans or buckets randomly in the field to collect liquid manure that is applied by an irrigation system. Inexpensive aluminum roasting

pans or plastic buckets can be used as catch pans. Use several pans at different distances from the sprinkler head.

- Immediately after the manure has been applied, collect manure from catch pans or buckets and combine the manure in one bucket to make one composite sample.
- Use a ladle to stir the sample in the bucket. While the liquid is spinning remove a ladle full and carefully pour into a sample bottle. See Figure 1.
- Repeat this procedure and take another sample until the sample bottle is three-quarters full. Screw the lid on tightly.

Liquid Manure Sampling from Storage Facilities

For best sampling results, samples should be taken with a sampling probe or tube (see Figure 2). Probes can be constructed out of 1.5-inch diameter PVC pipe. Cut the PVC pipe a foot longer than the depth of the pit. Run a 1/4-inch rod or string through the length of the pipe and attach a plug such as a rubber stopper or rubber ball (see Figure 3). The rod or the string must be longer than the pipe. If using a rod, bend the top over to prevent it from falling out of the pipe.

- Insert the pipe slowly into the pit or lagoon, with the stopper open, to the full depth of the pit.



Figure 2. Sampling earthen basin with sampling probe.

- Pull the string or rod to close the bottom of the pipe and extract the vertical profile sample inside the pipe (be careful not to tip the pipe and dump the sample).
- Release the sample carefully into a bucket.
- Repeat the process at least three times around the pit or lagoon creating a composite sample in the bucket.
- Use a ladle to stir the sample in the bucket to get the solids spinning in suspension. While the liquid is spinning,

take a ladle full and carefully pour into a sample bottle.

- Repeat again and take another sample until sample bottle is three-quarters full. Make sure the manure solids have not settled to the bottom of the bucket as each dipper is extracted; it is important to include the solids in the sample. Screw the lid on tightly.



Figure 3. Rubber stopper attached to a metal rod to serve as a stopper for PVC manure sampling tube.

Pre-Sampling Nitrogen and Potassium from Liquid Manure

If the procedures described above for sampling liquid manure are impractical due to lack of sampling equipment, or the inability to agitate the manure, manure samples can be dipped off the top of stored liquid manure to analyze for N and K concentrations. Research has shown that top-dipped liquid samples represent approximately 90 percent of the N concentration measured in mixed, field-collected samples. Multiply the results of the N concentration from top-dipped samples by 1.1 for a better estimate of the N concentration of the liquid storage facility. Dipping a sample from the surface of a liquid storage pit does NOT provide a good estimate of P concentration in the pit and is not recommended.

How to Sample Dry or Solid Manure

In solid manure handling systems, many of which include bedding, the proportions of fecal matter, urine, and bedding will vary from one location to another within sites, and often from season to season as well. It is necessary to take samples from various places in the manure pile, stack, or litter to obtain a representative sample for analysis. It may even be beneficial to sample several times per year based on the bedding content.

Manure sampling is best done in the field as manure is applied. This ensures that losses that occur during handling, storage, and application are taken into account and that manure is better mixed, reducing stratification found during sampling storage facilities. As with field sampling of liquid manure, results will not be available in time to adjust current application rates. However, sampling during application will still allow producers to adjust any planned future commercial fertilizer rates and manure application in subsequent years. The following method describes a procedure for collecting dry or solid manure samples from the field.

Dry Manure Sampling During Land Application

Collect manure samples according to the following field sampling procedure.

- Spread a sheet of plastic or tarp on the field. A 10-foot-by-10-foot sheet works well for sampling manure.
- Fill the spreader with a load of manure.
- Drive the tractor and manure spreader over the top of the plastic to spread manure over the sheet.
- Collect subsamples as described below (Steps 1-3, Com-

posite Sample Collection).

- Samples should be collected to represent the first, middle and last part of the storage facility or loads applied and should be correlated as to which loads are applied on certain fields to track changes in nutrient concentrations throughout the storage facility.

Sampling from Dry or Solid Storage Facilities and Open Lots

Manure should be sampled at the time of application, but if time and management practices prevent this, manure samples can be collected from the storage facility. Sampling from storages is not generally recommended due to difficulty in collecting a representative sample. Although solid manure storages are generally not fully enclosed and gases are somewhat diluted, always exercise caution when sampling from storage facilities. If you have to enter a confined storage facility, follow the safety recommendations described previously in the section on sampling liquid manure storages.

Open Paved Lots

Manure that accumulates on paved feedlots and is scraped and hauled to the field is classified as scrape-and-haul feedlot manure. Manure is usually removed from the feedlot daily or several times a week.

- Collect manure by scraping a shovel across approximately 25 feet of the paved feedlot. This process should be repeated ten or more times, taking care to sample in a direction that slices through the large-scale variations of moisture, bedding, depth, age, etc. (See Figure 4). Avoid manure that is excessively wet (near waterers) or contains unusual amounts of feed and hay.
- Use the shovel to thoroughly mix manure by continuously scooping the outside of the pile to the center of the pile.
- Collect subsamples from this pile using the hand-in-bag



Figure 4. Sampling a feed-lot for manure sample.

method that is described below (Steps 1-3 Composite Sample Collection).
 • This may need to be done several times to collect several composite samples for analysis.

Barn Gutter

Manure that accumulates in a barn or housing facility, is temporarily stored in a gutter, and then removed by a barn cleaner is classified as barn gutter manure. Manure is usually removed from the barn once or twice daily.

- Shovel a vertical "slice" of manure from the gutter, making sure the shovel reaches to the bottom of the gutter.
- Remove manure from the gutter and pile it on the barn floor. Mix the manure with a shovel or pitchfork to ensure that bedding is mixed thoroughly with manure. When collecting samples from a gutter, be sure to include the liquid that accumulates in the gutter's bottom. Discard foreign material and also take care not to add large amounts of barn lime.
- Repeat steps one and two from various locations along the gutter.
- Mix each pile thoroughly and collect subsamples from each pile using the hand-and-bag method that is described below (Steps 1-3, Composite Sample Collection).

Dry Stack and Manure with Litter

Manure that is stored outside in a solid waste storage facility, such as a stacking shed or horizontal concrete silo located above ground, is classified as a dry stack. These facilities are usually covered to prevent the addition of extra water. Dry

manure with litter should also be sampled in the following manner.

- Remove manure from 10 to 20 locations throughout the dry stack and place it in a pile using a pitchfork or shovel. Manure should be collected from the center of the stack as well as from near the outside walls, to get samples that represent all ages and moisture levels of manure in the stack. A bucket loader can cut a path into the center of the pile to provide access for sampling. Subsamples should be collected to the depth the litter will be removed for application.
- Thoroughly mix manure with the shovel by continuously scooping the outside of the pile to the center of the pile.
- Collect a composite manure sample as described below (Steps 1-3, Composite Sample Collection).

Composite Sample Collection for Dry or Solid Samples

1. Whether collecting from a plastic tarp in the field, a feedlot, a storage facility, or a barn, sample in a grid pattern so that all areas are represented. Combine 10 to 20 subsamples in a bucket or pile and mix thoroughly. More subsamples will produce more accurate results and are often required to produce a composite that best represents nutrient levels.
2. The final composite sample that will be submitted for nutrient analysis should be collected using the hand-in-bag method. To collect a composite sample from the mixed subsamples, place a one-gallon resealable freezer bag turned inside out over one hand. With the covered hand, grab a representative handful of manure and turn the freezer bag right side out over the sample with the free hand. Be careful not to get manure in the sealable tracks.
3. Squeeze excess air out of the bag, seal, and place it in another plastic bag to prevent leaks. Label the bag with your name, date, and sample identification number with a waterproof pen and freeze it immediately to prevent nutrient losses and minimize odors. For manure with a high degree of variability, multiple samples may need to be analyzed. Manure samples should be mailed or delivered to the laboratory as soon as possible after sampling.

Manure samples should be sent to a lab for chemical analysis as quickly as possible to avoid nutrient losses. For a list of commercial laboratories, please call your ISU Extension office or visit the Web at: <http://extension.agron.iastate.edu/immag/sp.html>.

Table 1. Conversion Factors

To switch from	Multiply by	To get
mg/l	1.0	ppm
ppm	0.0001	percent
ppm	0.00834	lb/1,000 gal
ppm	0.002	lb/ton
ppm	0.2265	lb/acre-inch
lb/1,000 gal	0.012	percent
lb/ton	0.05	percent
percent	83.4	lb/1,000 gal
percent	20.0	lb/ton
percent	2265	lb/acre-inch
P (elemental)	2.29	P ₂ O ₅
K (elemental)	1.2	K ₂ O

Additional Information and Resources

Basic manure analyses determined by laboratories include total nitrogen, total phosphorus, and total potassium. Results from commercial laboratories are presented either as a percent of the sample weight, as pounds per ton, as pounds per 1,000 gallons of manure, or in parts per million (ppm). Table 1 shows factors used to convert between measurements. Usually, nutrients are expressed as N, P₂O₅, or K₂O on a wet or "as received" basis, but some labs may instead report data on an elemental (P instead of P₂O₅, K instead of K₂O) or dry (without water) basis; so, be sure to confirm the units. In any case, manure values from commercial laboratories express nutrients as the total amount of nutrient in the manure sample. Some primary nutrients, such as N and P, may not be completely available for plant growth the first year manure is applied. A portion of some nutrients present in manure are in an organic form and unavailable for immediate plant uptake. Organic forms require transformation to an inorganic form to be available for plant uptake. This transformation is dependent on temperature, moisture, chemical environment, and time. Availability of nutrients can be limited by field losses, which are affected by the type of manure and by manure application methods. These losses are not accounted for in laboratory results. Refer to the ISU Extension publication *Managing Manure Nutrients for Crop Production* (PM 1811) for nutrient availability estimates and losses due to types of manure application methods.

PM 1518k *Manure Storage Poses Invisible Risks*
 PM 1941 *Calibration and Uniformity of Solid Manure Spreaders* (12/03)
 PM 1948 *Calibrating Liquid Manure Applicators* (02/04)
 PM 1811 *Managing Manure Nutrients for Crop Production*

Additional resources may be found on the Iowa Manure Management Action Group (IMMAG) Web page at:
<http://extension.agron.iastate.edu/immag/default.htm>

Prepared by Angela Rieck-Hinz, extension program specialist, Dept. of Agronomy; Jeffery Lorimor, associate professor, and Tom L. Richard, associate professor, Dept. of Agricultural and Biosystems Engineering and Kris Kohl, ISU field specialist- Agricultural Engineering.

Photos submitted by John Sawyer, Kris Kohl, Joel DeJong, Jeff Lorimor and Charles Wittman

Reviewed by: John Sawyer, ISU; Chris Murray, Iowa Natural Resources Conservation Service and Marty Schwager, Iowa Pork Producers Association.

File: Agronomy 7-4

... and justice for all
 The U.S. Department of Agriculture (USDA) prohibits discrimination in all its programs and activities on the basis of race, color, national origin, gender, religion, age, disability, political beliefs, sexual orientation, and marital or family status. (Not all prohibited bases apply to all programs.) Many materials can be made available in alternative formats for ADA clients. To file a complaint of discrimination, write USDA, Office of Civil Rights, Room 326-W, Whitten Building, 14th and Independence Avenue, SW, Washington, DC 20250-9410 or call 202-720-5964.

Issued in furtherance of Cooperative Extension work, Acts of May 8 and June 30, 1914, in cooperation with the U.S. Department of Agriculture. Stanley R. Johnson, director, Cooperative Extension Service, Iowa State University of Science and Technology, Ames, Iowa.



Section J: Mortality Disposal Actions

SECTION J. Livestock Mortality Management Plan

Mortalities will be disposed of in the LWCF. The primary method of carcass disposal is composting by use of a In-Vessel Composter called a BIOvator. If the BIOvator is not functioning rendering will be used, the mortalities will be picked up within 24 hours if possible, and temporary storage areas will be placed in a manner that runoff does not affect water of the state.

The following is an Excerpt from Act 87 of 1963-Code 2-33-101 and Act 150 of 1985-Code 19-6-448 by the Arkansas Livestock and Poultry Commission

Carcasses may be buried at a site at least 100 yards away from a well and in a place where a stream cannot be contaminated. Anthrax carcasses are to be covered with 1 inch of lime. Other carcasses may be covered with lime, particularly when needed to control odors. All carcasses are to be covered with at least 2 feet of dirt. Carcasses are not to be buried in a landfill, without prior approval of the State Veterinarian.

Act 87 of 1963, Act 150 of 1985, and Act 522 of 1993: Disposal of carcass of animal dying from contagious or infectious disease.

9141. Any person that has the care or control of any animal that dies from any contagious disease shall immediately cremate or bury the animal.

9142. An animal which has died from any contagious disease shall not be transported, except to the nearest crematory. The transportation of the animal to the crematory shall be pursuant to such regulations as the director may adopt.

9143. An animal which has died from any contagious disease shall not be used for the food of any human being, domestic animal, or fowl.



Section K: Livestock Feed Management



Environmental Nutrition: Nutrient Management Strategies to Reduce Nutrient Excretion of Swine

E. T. KORNEGAY, PAS and A. F. HARPER, PAS

Department of Animal and Poultry Sciences, Virginia Polytechnic Institute and State University, Blacksburg, VA 24061-0306

Abstract

Intensive production of swine has brought an increase in the volume of manure produced on farms with limited land area. Exceeding the capacity of soil and crops to handle this volume of manure results in nutrient accumulation in and on the soil that can produce leakage of nutrients to the environment and pollution could result. Environmental nutrition is defined as the concept of formulating cost-effective diets and feeding animals to meet their minimum mineral needs for acceptable performance, reproduction, and carcass quality with minimal excretion of minerals. Pigs normally excrete 45 to 60% of N, 50 to 80% of Ca and P, and 70 to 95% of K, Na, Mg, Cu, Zn, Mn, and Fe when fed diets containing commonly used feedstuffs. Although it is not possible to make pigs 100% efficient in utilization of nutrients, it is possible to reduce the amount of nutrients excreted through careful nutrient management. Several strategies are possible for reducing nutrients excreted: 1) improvements in feed efficiency, 2) more accurate nutrient requirement information for animals and compositional data for feed ingredients,

3) reduced feeding of excess nutrients through overformulation, 4) feeding for optimal rather than maximum performance, 5) use of crystalline amino acids and high quality protein, 6) improving the availability of P and some other minerals, 7) use of phase feeding and separate-sex feeding, and 8) reduced feed waste. Some strategies have a much greater potential for reducing nutrients excreted than other strategies. In the future, diet formulation and feeding systems must be integrated into total production systems so that swine production systems are environmentally safe as well as economically viable.

(Key Words: Environment, Nutrient Management, Pigs.)

Introduction

Pigs traditionally have been fed to maximize performance with little or no regard for nutrients excreted. During the past decades, advances in genetics, nutrition, housing, physiology, disease control, and management have resulted in major improvements in the efficiency of swine production. Along with these improvements has been an increase in the size and intensity of production units to maximize the benefits from these improvements and to optimize the use of capital, labor, and

facilities. This large increase in size of animal units, however, has led to an overall increase in environmental burdens, such as excessive amounts of waste and odor. Commercial swine production is an essential component of our food supply. However, this important agricultural enterprise is being restricted in some countries and will be restricted in other countries if solutions to the problem of manure disposal and odor control are not developed and implemented.

Because of the high nutrient content of manure, and thus fertilizing value, land application has been the major means of manure disposal. However, there are limits to the amount of manure that can be applied to the land because of nutrient build-up in and on the soil. The potential environmental impact of nutrient contamination of the environment is perceived as a major issue facing livestock producers in many countries (15, 19, 40, 90). A major concern for surface water quality is the eutrophication of lakes and streams (20), and P, not N, is the limiting nutrient for algae and other aquatic plant growth (75, 80). Also, an excessive build-up of nutrient levels in the soil is of long-term concern because of potential pollution through ground water and soil

erosion and run-off, as well as a potential reduction in crop yield.

To avoid leakage to the environment and potential pollution, governments in many countries are passing legislation requiring nutrient management plans for each farm, thus the amount of manure that can be applied to the land is being regulated (35). Most states in the U.S. are starting to monitor farms where large numbers of food-producing animals are maintained on a small acreage. Coffey (15) has stated that technology does exist for concentrated production of livestock in an environmentally sound manner. However, he also said that even though good technology exists today, there are opportunities for reducing nutrients excreted, and thus reducing land requirements.

Managing manure in swine confinement systems has always been a problem, and it will be a much greater problem and challenge in the future because the volume of manure per production unit has increased as production units have increased in size and intensity. Also, environmental concerns have increased and will continue to increase in the future as indicated by all trade magazines and newspapers for livestock and poultry agriculture. Two equally important approaches must be taken in dealing with this challenge: First, the amount of nutrients being excreted must be reduced; and second, the nutrients that are excreted must be recycled in a manner that is not damaging to the environment. It was stated in 1981 by the Agricultural Research Council (4) that the concept of a minimum requirement of a mineral that sustains an acceptable standard performance of pigs needed to be developed and should be cost-beneficial. Environmental nutrition is defined as the concept of formulating cost-effective diets and feeding animals to meet their minimum mineral needs for acceptable performance, reproduction, and carcass quality with minimal excretion of minerals. This paper discusses methods of reducing nutrient excretion in manure as an

important component of the solution to this environmental problem.

Assumptions and Nutrients of Concern

There are four basic assumptions in this concept of environmental nutrition. 1) All animals will excrete some nutrients; therefore, 100% efficiency will not be reached. 2) The total farm production system must be sustainable and nutrients should not become detrimental to the environment. 3) Manure is biodegradable — it is made up of various organic and inorganic nutrients and can serve as a source of nutrients for both plants and animals when managed properly. 4) Swine producers want to contribute to a healthy environment; consumers, however, must recognize that additional production costs may result and must ultimately be paid by them.

Digestion and retention coefficients for N and several minerals are given in Table 1 for various sizes of pigs. Generally, pigs only retain from 20 to 55% of the N consumed. The amount of Ca and P retained can vary from 20 to 72% with slightly more Ca retained than P. The retention of Mg, Na, and K vary from 5 to 38% of that consumed. The retention of Zn, Cu, Fe, and Mn is also low, with values ranging from 8 to 45% of the intake. Younger animals may be slightly more efficient than older animals, but there is also a larger database for the younger animals. Other factors can influence the retention of N and minerals. The amount of minerals retained as a percentage of intake decreases as intake increases. The retention of chemically bound forms of some minerals will be increased if they are released in the digestive tract. For example, phytase can enhance the retention of Ca, P, and Zn. Fiber is known to decrease the retention of some minerals. Therefore, the bioavailability of the mineral source will influence the retention of minerals.

Of the nutrients present in manure, N, P, K, and trace minerals (probably Cu and Zn) are of greatest concern. There is general agreement that P and N are currently the two elements in manure that limits the rate of land application, but there is disagreement as to which one is of greatest concern. In the Netherlands, manure disposal is a major concern on swine and poultry farms because of the small land base of these farms (28). However, within Dutch animal agriculture, the dairy and swine industries are the largest contributors to manure production. In the Netherlands, there are laws that regulate the amount and method of waste disposal. These regulations will become more restrictive by the year 2000 (28).

Nitrogen is used as the base to regulate the amount of manure that can be applied to the land in many areas, including the U.S. However, in the future it is likely that N and P will be the nutrients that limit land application of manure in more intensive swine and poultry producing areas. Results of a recent livestock nutrient assessment in North Carolina (7) supports the position that P may well be the nutrient that determines the amount of manure that can be applied to many soils and crops. Barker and Zublena (7) reported that statewide animal and poultry manure could provide about 20% of the N and 66% of the P requirements of all nonlegume agronomic crops and forage. However, these researchers found that 3 of 100 counties in North Carolina had enough manure to exceed all crop N requirements, and 18 counties had enough manure to exceed crop P needs.

High P levels in the soil have also been reported for many states. Sweeten (86) estimated that for the 145.5 metric tons of manure produced annually by livestock and poultry in the U.S., pigs excrete about 23% of the P and poultry excrete about 13%. Dairy cattle excreted 12% of the total P in all manure. Sims (84) reported that

TABLE 1. Digestion and retention of nitrogen and minerals by different classes of pigs.

Minerals	Class or size of pigs			
	Young	Finishing	Gestating	Lactating
Nitrogen				
Digested, %	75 to 88	75 to 88	88	—
Retained, %	40 to 50	40 to 50	35 to 45	20 to 40
Calcium				
Digested, %	55 to 75	40 to 50	10 to 37	19 to 26
Retained, %	40 to 72	25 to 50	35	—
Phosphorus				
Digested, %	20 to 70	20 to 50	3 to 45	1 to 35
Retained, %	20 to 60	20 to 45	20 to 35	20
Magnesium				
Digested, %	20 to 45	28 to 38	14 to 21	7 to 18
Retained, %	20 to 38	15 to 26	—	—
Sodium				
Digested, %	—	35 to 70	—	—
Retained, %	—	13 to 26	—	—
Potassium				
Digested, %	—	60 to 80	—	—
Retained, %	5 to 10	10 to 20	—	5
Zinc digested, %	20 to 45	10 to 20	—	—
Copper digested, %	18 to 25	10 to 20	—	—
Iron digested, %	30 to 35	5 to 35	—	—
Manganese digested, %	17 to 40	8 to 18	—	—

Data for this table was adapted from Adeola (1), Adeola et al. (2), Apgar and Kornegay (3), Bruce and Sundstal (11), Coppoolse et al. (18), Dungalhoef et al. (29), Everts (32), Jongbloed (43), Jongbloed et al. (46, 47), Kornegay et al. (56), Kornegay (50), Kornegay and Kite (54), Kornegay and Qian (55), Lantzsich and Drochner (58), Lindemann et al. (62), Moore et al. (64), Näsi (66), Pallauf et al. (71, 72, 73, 74), Qian et al. (76), Swinkels et al. (87), Verstegen (91), Vipperman et al. (94), Yi et al. (98).

extractable concentration of P, Cu, and Zn in the Ap and upper B horizon (D. C. Martens and E. T. Kornegay, unpublished data). The average annual rate of application per acre was 21.9 lb of Cu, 7.1 lb of Zn, and 378.6 lb of P. The application of a similar amount of Cu from CuSO_4 resulted in similar increases in Cu. For example, high quality deep core soil samples taken in the spring of 1996 revealed that the increases varied based on soil type and treatment (Table 3). There were 9.0-, 19.6-, and 3.6-fold increases in extractable Cu for silt loam (0 to 12 in), sandy loam (0 to 10 in), and clay loam (0 to 4 in) soils, respectively, in the Ap horizon when Cu-rich pig manure and CuSO_4 were added. There were 2.1-, 2.5-, and 2.6-fold increases in extractable Zn, respectively, when Cu-rich pig manure was added. Also, there were 2.4-, 5.7-, and 11.7-fold increases in extractable P, respectively, when Cu-rich pig manure was added. There were some increases in the upper B or A_2 horizons, but the magnitude of the increases was much less and the total concentration for all soils and treatments was much less. Little effect of treatments for the different soil types was observed below the upper B or A_2 horizon. The Cu (2.3 to 2.6 ppm) and Zn (16.8 to 20.3 ppm) concentrations of the grain grown on these soils were not changed. Corn ear leaf tissue had a slightly higher Cu concentration (113 to 172% of controls) but Zn concentrations were similar. Phosphorus was not measured in plant tissue and grain. Grain yield was not decreased by Cu application during any year on the three soil types.

Strategies for Reducing Nutrients Excreted

The following strategies for reducing nutrients excreted will be briefly discussed and examples given: 1) Improvement of feed efficiency; 2) Reduction of "overformulation" or nutrient excesses; 3) More accurate

recent surveys reveal that several states had found greater than 50% of the soil samples tested for crop production to be rated high or excessive in P. These states include Maine, Connecticut, Delaware, Maryland, Michigan, Minnesota, Virginia, North Carolina, South Carolina, Ohio, Iowa, Idaho, Indiana, Illinois, Utah, Wisconsin, Wyoming, Arizona, and Washington. The impact of high P levels in the soil has been reviewed recently by Pierzynski et al. (75), Sharpley (79), Sharpley et al. (80, 81), and Crenshaw and Johanson (20). Phosphorus currently is the nutrient that regulates the amount of waste that can be applied to the land in some countries and

will probably replace N in other countries, but in the long-term Cu and Zn may be of concern.

Soil analyses of a Sampson County, NC, bermudagrass pasture that was fertilized with swine lagoon effluent to satisfy N requirements showed approximately a 400% increase in P and Zn, a 100% increase in K, and a 300% increase in Cu to a depth of 91 cm during the 3-yr period of application (Table 2; 65).

Starting in 1978 through 1992, the application of Cu-rich pig manure (from pigs fed 255 ppm Cu as CuSO_4) at an average annual rate of 80 ton/acre (22.4% DM) to three soil types increased the soil DTPA (diethylenetriaminepentaacetic acid)

TABLE 2. Soil analyses for a Sampson County, NC bermuda-grass pasture fertilized with swine lagoon effluent^a.

Depth (cm)	P ^b		K ^b		Zn		Cu	
	1990	1992	1990	1992	1990	1992	1990	1992
	(ppm)							
0 to 15	118	212	147	191	1.28	5.28	0.47	2.65
15 to 30	39	190	184	183	0.38	2.39	0.48	1.65
30 to 61	4	46	355	1389	0.20	1.38	0	1.78
61 to 91	3	14	298	797	0.26	1.02	0	1.21

^aSwine lagoon effluent was added at a rate to meet the N needs of the bermudagrass pasture. Initial sample was taken June 28, 1990 and final sample taken December 2, 1992. Adapted from Mueller et al. (65).

^bAssumed P₂O₅ contained 43.64% P and K₂O contained 82.98% K.

nutrient requirements of animals and compositional information for feed ingredients; 4) Feeding for optimal rather than maximum performance; 5) Use of crystalline amino acids and high quality protein; 6) Improvement of the availability of P and some other minerals; 7) Use of phase feeding and separate-sex feeding; and 8) Reduction of feed waste. Other strategies, such as controlling disease and parasites, providing a comfortable environment, and reducing stress are also very important and can lead to improved efficiency, but will not be discussed in this paper. Some strategies have a much greater potential for reducing nutrients excreted than others, and some strategies will be more applicable than others depending on the individual farm situation.

Improvement of Feed Efficiency. Improvements in overall feed efficiency can produce a major reduction in the excretion of nutrients. Coffey (15) reported that a reduction in the feed to gain ratio of 0.25 percentage units (i.e., 3.00 vs 3.25), would reduce N excretion by 5 to 10%. Henry and Dourmad (40) reported for growing-finishing pigs that for each 0.1 percentage unit decrease in feed to gain ratio there was a 3% decrease in N output. Feed efficiency can be improved in several

ways: 1) Improvements in the genetic potential of animals can have a tremendous impact on feed efficiency. 2) Proper formulation of diets using high quality ingredients will also improve feed efficiency. 3) The use of certain processing and feeding methods can further improve feed efficiency. 4) Although sometimes controversial, the use of repartitioning agents can result in improvements in feed efficiency and major improvements in carcass muscling.

Reduction of Overformulation or Nutrient Excesses. The amount of nutrients excreted can be reduced by decreasing "overformulation" or the inclusion of excess levels of nutrients in the diet. Traditionally, the main consideration of diet formulation was to maximize the growth and health of the animal. Little concern was shown for excess nutrients excreted. Results of numerous surveys of the nutrient composition of diets being fed indicate that excesses of several nutrients continues to be included in the diet. Some nutritionists refer to these excesses as a safety factor. Excess nutrients may be included in the diet to account for the variability of nutrient composition of feed ingredients, or to make up for a lack of knowledge concerning the availability of the nutrients in the feed

ingredients used. More recently, it has been argued that higher nutrient levels are required because of possible genetic differences in nutrient requirements. Whether this is true or not remains to be proven. Results of surveys reported by Cromwell (22) of the Ca and P recommendations of several universities and feed companies indicated that feeding excess P may be a common practice (Table 4). The average range of university recommendations were 110 to 120% of NRC (69) guidelines, whereas the average range of industry recommendations were 120 to 130% of NRC (69) guidelines. Spears (85) reported results of diets analyzed by the North Carolina Feed Testing Laboratory for sows and finishing pigs (Table 5). Excesses of most minerals were observed. The median levels as a percentage of NRC (69) guidelines were 140 to 192 for Ca, P, and Na; 390 to 525 for K and Mg; 334 to 776 for Cu, Fe, and Zn; and 770 to 3,100 for Mn. Minerals such as P, Cu, and Zn may be of greater environmental concern. Other surveys in the past have reported similar results of the inclusion of excess nutrients in the diet.

A large decrease in the excretion of minerals can be obtained by diet formulation to more accurately meet nutrient requirements. Latimer and Pointillart (59) reported that finishing pigs fed diets containing 0.5% P grew as fast and as efficiently as those fed 0.6% P, but P excretion was 33% less for pigs fed the lower level of P. Walz et al. (95) reported that supplemental amino acids (lysine, methionine + cystine, threonine, and tryptophan) improved protein retention of pigs fed a low protein diet (25% less than recommended by German guidelines); N excretion was reduced approximately 30%. The use of more precise composition and nutrient availability data for feed ingredients, and better defined nutrient requirements for animals, will allow for the formulation of diets that better meet the needs of the animal at the various stages of production. A reduction in the amount of excess

TABLE 3. Mehlich-3 extractable Cu, Zn, and P concentrations in three soil types after 16 annual applications of Cu-rich manure and CuSO₄.

Horizon	Depth (cm)	Class ^a	Cu			Zn			P		
			Control	Cu manure	Cu sulfate	Control	Cu manure	Cu sulfate	Control	Cu manure	Cu sulfate
			(ppm ^b)			(ppm ^b)			(ppm ^b)		
Bertie											
A _p	0 to 29	fsl	4.3 ^d	35.3 ^c	42.1 ^c	15.8 ^d	32.7 ^c	15.1 ^d	295.0 ^d	697.5 ^c	295.0 ^d
Upper B	30 to 61	fsl	0.4 ^d	2.2 ^c	1.5 ^c	0.8 ^d	1.6 ^c	0.8 ^c	9.1 ^d	230.2 ^c	11.9 ^d
Lower B	62 to 86	fsl	0.4 ^c	0.3 ^c	0.3 ^c	0.5 ^c	0.4 ^c	0.6 ^c	0.8 ^c	11.4 ^c	0.1 ^c
Upper C	87 to 112	sil	0.3 ^c	0.2 ^c	0.4 ^c	0.4 ^c	0.4 ^c	0.4 ^c	0.1 ^c	0.9 ^c	0.1 ^c
Lower C	113 to 133	sil	0.2 ^c	0.5 ^c	0.4 ^c	0.4 ^c	0.6 ^c	0.5 ^c	0.1 ^c	0.9 ^c	0.1 ^c
Guernsey											
A _p	0 to 25	sil	3.1 ^d	59.6 ^c	62.2 ^c	19.5 ^d	49.4 ^c	21.2 ^d	176.3 ^d	1011.7 ^c	199.1 ^d
Upper B	26 to 50	sic	0.6 ^d	3.0 ^c	1.6 ^{cd}	1.1 ^d	2.2 ^c	0.8 ^d	15.4 ^d	83.2 ^c	19.1 ^d
Middle B	51 to 75	sicl	1.1 ^c	0.7 ^c	0.7 ^c	0.9 ^c	0.5 ^c	0.5 ^c	1.9 ^c	1.2 ^c	3.6 ^c
Lower B	76 to 100	sic	0.6 ^c	1.2 ^c	1.4 ^c	0.5 ^c	0.7 ^c	0.7 ^c	0.1 ^c	0.1 ^c	0.1 ^c
Starr-Dyke											
A _p	0 to 11	sicl	14.8 ^d	53.7 ^c	54.2 ^c	16.9 ^d	43.2 ^c	23.1 ^d	38.3 ^d	447.9 ^c	77.2 ^d
A ₂	12 to 25	sic	1.8 ^d	9.8 ^c	9.2 ^c	2.5 ^d	7.6 ^c	3.4 ^d	0.2 ^d	130.7 ^c	0.3 ^d
Upper B	26 to 50	c	1.0 ^c	1.1 ^c	1.2 ^c	1.0 ^c	0.9 ^c	0.8 ^c	0.1 ^c	2.0 ^c	0.1 ^c
Middle B	51 to 75	c	0.5 ^c	0.5 ^c	0.5 ^c	0.5 ^c	0.4 ^c	0.4 ^c	0.1 ^c	0.1 ^c	0.1 ^c
Lower B	76 to 100	c	0.8 ^c	0.6 ^c	0.7 ^c	1.0 ^c	0.5 ^d	0.7 ^{cd}	0.1 ^c	0.1 ^c	0.1 ^c

^aFsl = fine sandy loam, scl = sandy clay loam, sil = silt loam, sicl = silty clay loam, and c = clay.

^bppm = mg/dm³. Multiply mg/dm³ (ppm) by 1.78 to get lb/acre.

^{cd}Means on the same line with different superscript letters are different ($P < 0.05$).

nutrients fed will reduce the amount of nutrients excreted.

More Accurate Estimates of Animal Nutrient Requirements and Compositional Information for Feed Ingredients. Recommended nutrient requirements have been published for the various classes of pigs in a number of countries, including the U.S. (69), United Kingdom (4), Australia (78), Netherlands (12, 13), and France (42). However, these recommendations often vary and, in many cases, are only estimates for an "average" type of animal under "average" environmental conditions. Some of the variation in the estimated nutrient requirements developed by the different countries could be explained by differences in genetic potential, feeding methods, environmental conditions, ingredients used,

animal response criteria, and even the philosophy of the authors. With the exception of P, nutrient requirements are generally based on the total nutrient rather than the available nutrient. In some cases, such as NRC (69), nutrient requirements are based on corn-soybean meal diets or diets with similar availabilities of nutrients as in a corn-soybean meal diet. Also, these requirements are often based upon the use of certain feed-grade mineral sources. In pigs, the use of the "ideal protein" concept as first proposed by ARC (4) is being developed and may be incorporated in a new revision of U.S. NRC nutrient guidelines for swine. Reassessment of "ideal protein" continues as indicated by recent publications (5, 6, 9, 33). Along with the use of ideal protein is the use of ileal digestibility values of amino acids (8, 61, 88),

which allow for more precise dietary formulation when using a variety of feed ingredients.

Available nutrient requirements of animals can only be accurately met if the compositional data of feed ingredients are expressed on an available nutrient compositional basis. Thus, more knowledge of the availability of the nutrients in ingredients will be required to take the full benefit of more precisely balancing the needs of animals.

Pig type has changed during the last decade because of strong consumer pressure for leaner, heavier muscled carcasses. For example, the nutrient needs of the high lean growth lines of pigs may be greater than those of pigs with lower potential for lean growth. Daily feed intake could influence the percentage composition of nutrients required,

TABLE 4. Comparison of Ca and P requirements and allowances recommended by universities and feed companies^a.

Mineral	Growing-Finishing		Gestation	Lactation
	20 to 50 kg	50 to 100 kg		
(%)				
Calcium				
NRC (69)	0.60	0.50	0.75	0.75
1986 Survey ^a				
Universities	0.66	0.59	0.82	0.79
Feed industry	0.74	0.63	0.95	0.93
1988 Survey ^b				
Universities	0.64	0.58	0.84	0.84
Feed industry	0.73	0.62	0.93	0.90
Phosphorus				
NRC (69)	0.50	0.40	0.60	0.60
1986 Survey ^a				
Universities (n=25)	0.55	0.49	0.66	0.63
Feed industry (n=35)	0.60	0.52	0.77	0.76
1988 Survey ^b				
Universities (n=7)	0.54	0.49	0.68	0.68
Feed industry (n=21)	0.60	0.52	0.76	0.74

^aOverfield (70) reported by Cromwell (22).

^bSurvey conducted in 1988 (Cromwell, 22).

and it may be necessary to increase the percentage composition if pigs eat less than the predicted feed intakes. However, most of this information must be developed and tested. Also, the requirements of barrows, gilts and boars are probably different, especially during the finishing phase of production.

Feeding for Optimal Rather than Maximum Performance. In the future, diets can be formulated so that animals perform at slightly less than maximum because the benefit of adding additional units of a nutrient to achieve maximum performance produces benefits at a decreasing rate. This practice increases nutrient costs per unit of performance improvement at an increasing rate as the animal approaches maximum performance. As the maximum response is reached, or as the performance curve reaches a plateau, a greater amount of the nutrient is required to get a change in the response (Figure 1). In a series of three trials, Combs et al. (16) fit

asymptotic models of the effect of total Ca+P intake (varied above and below NRC recommended requirement) and days on test (weaning to market). Diminishing returns in response to Ca+P input are shown in Figure 2 for performance measurements. This principle of diminishing returns in response to nutrient input is not new. Heady et al. (38) reported that in 14 of 16 yr, swine diets formulated using the diminishing return concept would have produced greater profits than diets formulated for maximum gain. Diminishing returns were also observed when Kornegay (52) fit asymptotic models to combined data from a number of research trials conducted from 1969 to 1986 to evaluate the Ca+P needs of growing-finishing swine. More recently, Gahl et al. (34) reported that the most economical daily weight gain does not necessarily occur when daily weight gain is maximized and would change as feedstuffs and input costs change. Diminishing returns for N gain of

pigs fed six levels of lysine from three supplemental sources (Figure 3) has been demonstrated by Gahl et al. (34); their paper includes a good discussion of the diminishing returns in response to nutrient input.

Another consideration in evaluating nutrient addition is the response criteria measured. It is well known that the amount of P required to maximize growth is less than the amount required to maximize bone integrity (69). Perhaps, from the perspective of animal well-being, attempts to maximize bone integrity are most important. But from an environmental perspective, attempts to maximize bone integrity results in excessive excretion of P (20). Combs et al. (17) observed that growing-finishing pigs fed diets that provided NRC (69) requirements for Ca and P maintained approximately 100% of maximum growth and feed efficiency, but approximately 120 to 130% of the NRC (69) Ca and P requirement was required to maximize bone development. Although maximizing bone development is not necessary for the production of a market pig, a more difficult question is how much bone development is required to prevent damage to the carcass during mechanical processing that occurs during slaughter. As the

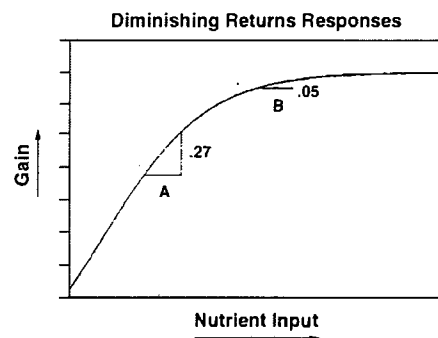

Figure 1. Example of diminishing returns for nutrient inputs as the level of nutrient fed increases. Adapted from Crenshaw et al. (21). At point A, one unit of input produces 0.27 units of gain, whereas, at point B, one unit of input produces 0.05 units of gain.

TABLE 5. Mineral concentrations in sow and finishing swine diets^a.

Minerals	Sow			
	Requirement NRC (69)	Range	Median ^b	Median requirement
Calcium, %	0.75	0.62 to 2.01	1.21	1.61
Phosphorus, %	0.60	0.45 to 1.17	0.84	1.40
Sodium, %	0.15	0.13 to 0.45	0.22	1.47
Magnesium, %	0.04	0.12 to 0.44	0.21	5.25
Potassium, %	0.20	0.43 to 1.15	0.78	3.90
Copper, ppm	5	12 to 222	22	4.40
Iron, ppm	80	162 to 698	376	4.70
Manganese, ppm	10	28 to 203	77	7.70
Zinc, ppm	50	79 to 497	167	3.34

Minerals	Finishing swine			
	Requirement	Range	Median ^b	Median requirement
Calcium, %	0.50	0.57 to 1.38	0.96	1.92
Phosphorus, %	0.40	0.45 to 0.78	0.62	1.55
Sodium, %	0.10	0.13 to 0.29	0.19	1.90
Magnesium, %	0.04	0.13 to 0.21	0.16	4.00
Potassium, %	0.17	0.48 to 0.93	0.72	4.23
Copper, ppm	3	9 to 281	20	6.67
Iron, ppm	40	131 to 503	311	7.76
Manganese, ppm	2	37 to 160	62	31.0
Zinc, ppm	50	103 to 205	149	2.98

^aResults are from analyses conducted recently at the North Carolina Feed Testing Laboratory (n=26 for sow and n=17 for finishing diets). Adapted from Spears (85).

^bThe median level for each mineral indicates that 50% of the sample analyzed were below and 50% were above the median value.

cost of disposing of P increases, the Ca and P levels fed will decrease. In the future, nutritionists will formulate for 95 to 98% of maximum response rather than trying to approach 100% of maximum response. Therefore, the industry will feed below rather than above the nutrient requirements of animals to maximize growth and bone development. How much of a safety margin will be desirable will depend upon the availability of accurate knowledge of the requirements and compositional information for the feedstuffs.

Use of Crystalline Amino Acids and High Quality Protein. The concept of ideal protein and the use of crystalline amino acids are now

widely accepted. The use of crystalline amino acids in nonruminant feeding can substantially reduce the amount of N excreted without affecting performance (23, 41, 49, 89). Henry and Dourmad (41) and Van der Honing et al. (89) reported that N excretion can be reduced 15 to 20% when crude protein levels are reduced two percentage units and crystalline amino acids are added to correct amino acid balance. Cromwell (23) reported that the crude protein level of swine diets can be reduced about two percentage units (i.e., 14 vs 16% crude protein) by using crystalline lysine; this can result in a 22% decrease in N excreted (Table 6). The crude protein

level of corn-soybean meal diets can be reduced about four percentage units (i.e., 10 vs 14% crude protein) by using four amino acids (lysine, threonine, tryptophan, and methionine); this can result in a 41% decrease in N excreted. After summarizing the results of 10 studies, Kerr and Easter (49) suggested that for each 1 percentage unit reduction in dietary protein combined with crystalline amino acid supplementation, total N losses (fecal and urinary) could be reduced approximately 8%. The use of low quality protein sources such as hydrolyzed hog hair meal, and high levels of crude fiber increase N excretion (50, 51). Also, as nonruminant animals are fed more precisely to meet their amino acid needs, feed efficiency will be improved, which can further reduce N excreted as well as the excretion of other nutrients.

Improve the Availability of P and Some Other Minerals. The amount of P excreted can be significantly decreased, if the availability of the bound (or unavailable) P, known as phytate P, in plants is improved. It has been demonstrated in pigs and poultry that the use of an exogenous enzyme, phytase, can improve plant P availability, thereby reducing P excretion. For example, in a corn soybean meal diet, commonly used for pigs and poultry, two-thirds of the P is bound and is unavailable (24). However, by using the appropriate amount of microbial phytase, 20 to 50% of the bound P can be released and made available to the animal. Thus, the amount of inorganic P that must be added to meet the P requirement is reduced. If total dietary P levels are decreased, then the amount of P excreted can be decreased 20 to 50% (27, 46, 47). Estimates of reductions in fecal P resulting from different levels of supplemental phytase representing 25 studies and 17 references (26, 29, 30, 31, 37, 39, 55, 60, 63, 66, 67, 68, 72, 82, 83, 93, 96) were used in a data set (Kornegay, unpublished data) to determine the relationship between supplemental phytase levels and fecal P reduction.

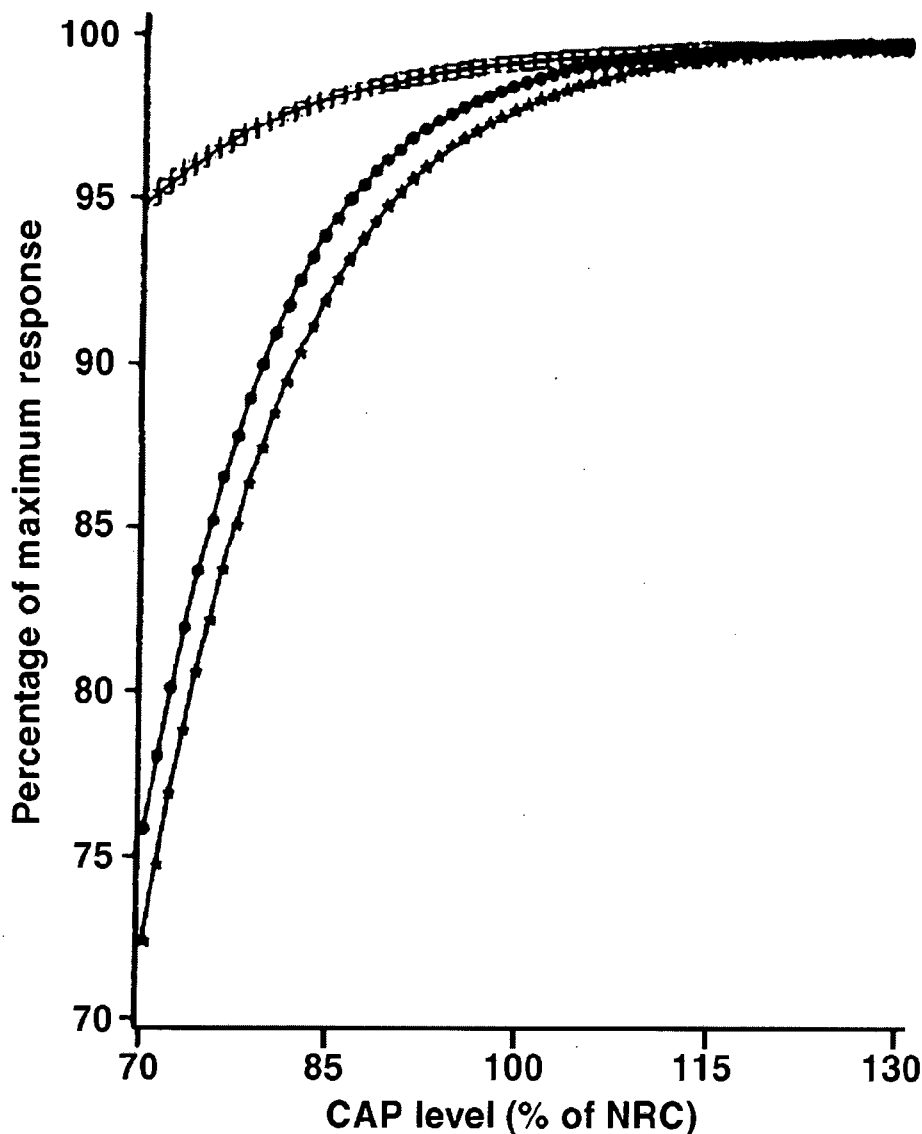

Figure 2. Percentage of maximum average daily gain (*) average daily feed intake (•) and gain:feed ratio (□) associated with each increase in average daily Ca and P (CAP) intake for growing-finishing pigs. Taken from Combs et al. (16).

The model included study as a fixed effect and the linear and quadratic effects of phytase level (units per kilogram). The quadratic effect was not significant ($P < 0.97$) and was removed from the model used to derive the following equation: $Y = 25.57 + 0.0106X$, $R^2 = 0.95$, where Y equals the fecal P reduction (percentage of adequate P level), and X = supplemental phytase level (units per kilogram). Based on this equation, 500 U/kg of dietary phytase would result in a 30.9% decrease in fecal P,

which is higher than 21.5% observed in a recent growing-finishing study (37). Assuming that a 21% reduction in P excretion results in a similar reduction in P content of land applied manure, then 21% less application area would be needed under a given P loading rate.

The nutritional, environmental, and economic considerations for using phytase in pig and poultry diets were recently reviewed (53). Based on response surface equations and nonlinear and linear equations

calculated from the data, it was concluded that the magnitude of the response to microbial phytase is influenced by the dietary level of available P (and total P including phytate P), the amount of phytase activity added, and the Ca to available P ratio. Currently in the U.S., based on replacement values of inorganic P by microbial phytase calculated from nonlinear and linear equations, the cost of adding phytase range from one to three times the cost of an equivalent amount of inorganic P (53). This cost, however, does not include any cost for P disposal. Based on a representative feeder-to-finish swine farm generated from the Duplin County, NC Swine Database, Zhu et al. (99) estimated that for a 20% reduction in P excretion, with the inclusion of 500 U/kg of phytase, the savings in manure disposal cost would be \$0.42 per hog with a net advantage of \$0.16 per hog for using phytase. A genetically engineered microbial phytase is now being marketed in the several countries, including the U.S. The addition of microbial phytase to high phytate diets also releases Ca (57, 77, 78, 92), Zn (10, 60, 96), and some amino acids (48, 97) that may be bound by the phytate complex.

Use of Phase Feeding and Separate-Sex Feeding. The requirement of animals for most available amino acids and minerals, expressed as a percentage of the total diet, decreases as the animals grow heavier. Phase feeding, as some have described it, is a way to more precisely meet the nutrient needs of growing and finishing pigs. This concept applied to dietary crude protein is illustrated in Table 7 and Figure 4. It is known that nutrient requirements change (perhaps weekly) as pigs grow; if a producer is able to change the formulation of the diet as the nutrient requirements change, then the nutrient needs of the animal can be met more precisely, thereby, reducing the total quantity of nutrients excreted. Henry and Dourmad (41) reported that N excretion could be reduced approximately 15% when

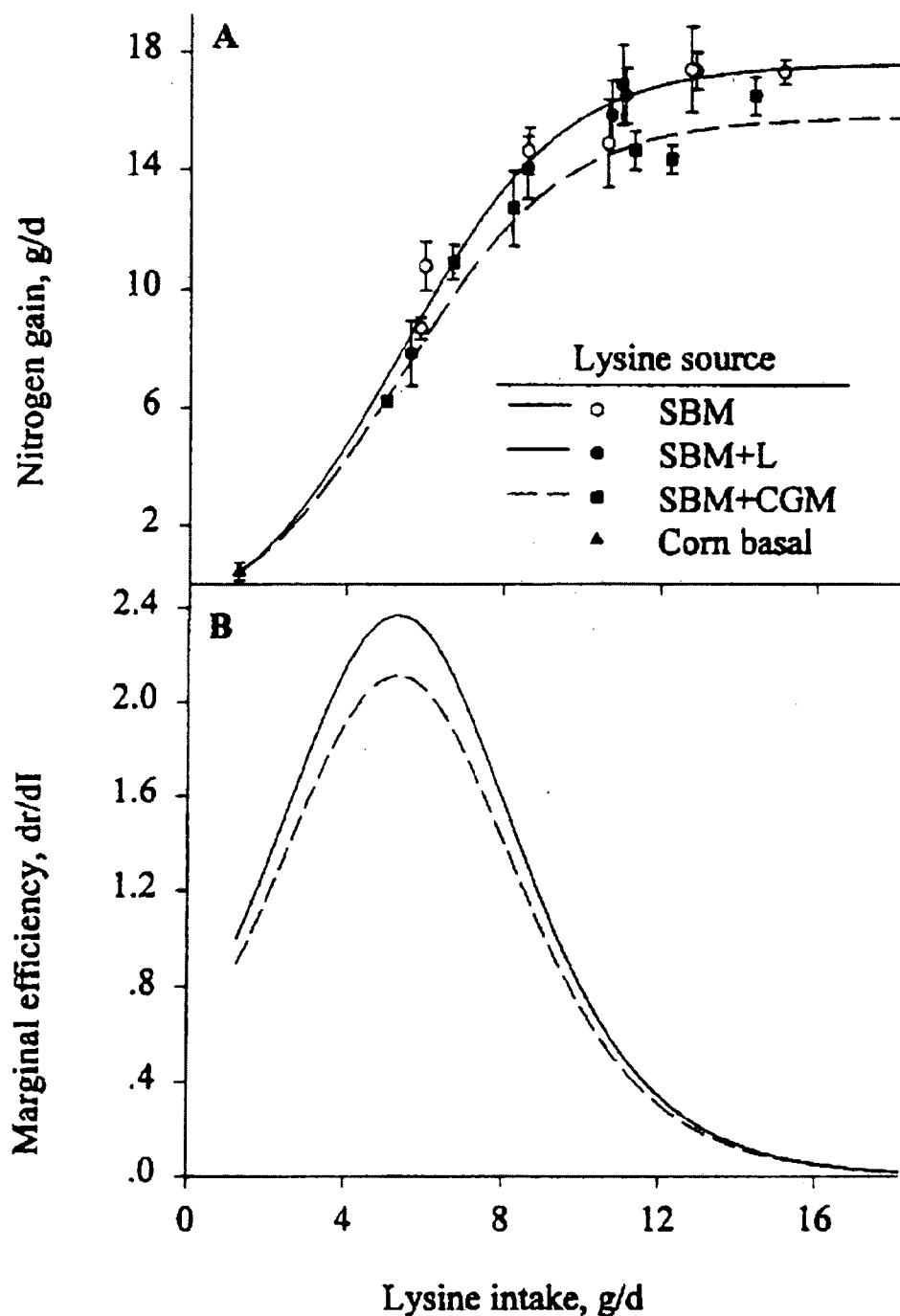

Figure 3. Diminishing returns in nitrogen gain (grams per day) of pigs fed diets with graded concentrations of lysine. Panel A: Predicted curves estimated using a logistic equation. Data points \pm SE ($n = 4$) for each treatment group. Panel B: Marginal efficiency of nitrogen gain with respect to lysine intake calculated as the first derivative of the predicted curves in Panel A. Marginal efficiency is defined as the incremental response in nitrogen gain to an incremental unit of lysine intake. Taken from Gahl et al. (34).

the feeding of 14% CP diet was initiated at 60 kg body weight, rather than the continuous feeding of 16% CP grower diet to market weight. In a further study, Chauvel and Ganier

(14) reported a 9% reduction in N excretion between a multiphase system in which the proportions of an 18.9 and 14.9% CP (4.1 and 2.6 g digestible lysine/Mcal net energy,

respectively) were changed weekly from 24 to 107 kg vs a two-phase system, in which an 18.1% CP (3.6 g lysine/Mcal net energy) diet was fed to 66 kg and a 16.1% CP (3.1 g lysine/Mcal net energy) diet was fed to 107 kg. Also, the excretion of P and other minerals would be reduced a similar amount, if the finishing diet contained a lower level of these minerals. Henry and Dourmad (41) suggested that this change could be made gradually by changing the ratio in which a "high" protein and P (and other minerals) grower diet is mixed with a "low" protein and P (and other minerals) finishing diet.

Separate-sex or split-sex feeding of swine can further improve feed efficiency. It is well established that gilts consume less feed on an ad libitum basis and require greater diet nutrient density than barrows (25). By penning and feeding gilts and barrows separately, producers can more precisely formulate diets for specific sexes and avoid overfortification and excessive excretion of nutrients. Furthermore, increased fat deposition and decreased rate of lean deposition occurs at an earlier growth stage in barrows than in gilts; therefore, dietary protein and amino acid levels can be more precisely changed at different growth stages for each sex. Under such precise feeding conditions, the total quantity of N and other minerals fed and excreted can be reduced.

Reduction of Feed Waste. Another simple, yet sometimes difficult and overlooked way to improve feed efficiency is to improve design and operation of feeders, so that feed waste is minimized. Studies have shown that feed waste accounts for up to 3 to 8% of the feed fed. The impact that feed waste has on feed efficiency and income loss, as well as the amount of N and P excreted in pigs is shown in Table 8 (36). A 5% level of feed waste can result in an income loss of \$1.77 per market pig depending on market condition, and an additional 327 g of N and 82 g of P excreted per pig. The use of proper feeder designs, regular maintenance,

TABLE 6. Theoretical model of the effects of reducing dietary protein and supplementing with amino acids on N excretion by 90-kg finishing pigs^a.

N balance	14 % CP	12% CP + Lys	10% CP + Lys + Thr + Trp + Met
N intake, g/d	67	58	50
N digested and absorbed, g/d	60	51	43
N excreted in feces, g/d	7	7	7
N retained, g/d	26	26	26
N excreted in urine, g/d	34	25	17
N excreted, total, g/d	41	32	24
Reduction in N excretion, %	-	22	41

^aAssumes an intake of 3,000 g/d, a growth rate of 900 g/d, a carcass lean tissue gain of 400 g/d, a carcass protein gain of 100 g/d (or 16 g of N/d), and that carcass N retention represents 60% of the total N retention. Adapted from Cromwell (23).

TABLE 7. Effect of feeding strategy during the growing-finishing period (25 to 105 kg) on N output^a.

Item	Single-feed 17% CP	Two-feeds ^b 17-15% CP	Three-feeds ^c 17-15-13% CP
N output, g/d	31.9	29.0	26.7
Percentage of two-feed strategy	110	100	92

^aAdapted from Henry and Dourmad (40).

^bCrude protein changed at 55 kg.

^cCrude protein changed at 50 and 75 kg.

TABLE 8. Feed waste impacts on nutrient management^a.

Feed waste (%)	Feed loss per pig (kg)	Income loss per pig (\$)	Feed N waste per pig (g)	Feed P waste per pig (g)
1	2.8	0.36	63	18
3	8.2	1.07	195	50
5	13.6	1.77	327	82
7	19.1	2.48	459	114

^aBased on growing-finishing pigs from 22.7 to 113.5 kg body weight, 3:1 feed:gain ratio, 2.4% N and 0.60% P in the diet and \$0.13/kg diet cost. Adapted from Harper (36).

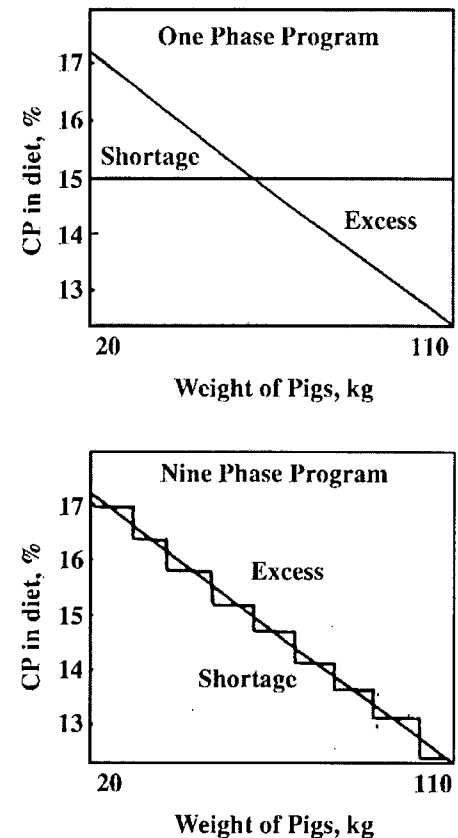

Figure 4. Example of a one phase and a nine phase feeding program for the growing and finishing phase.

and careful adjustment of feeders is essential for the prevention of excessive feed waste.

Conclusions

As swine production units have become larger and more intensive, the need for environmentally sound methods to use and dispose of excreted nutrients has increased. Safe and effective disposal of waste nutrients in swine production depends on reducing the quantity of nutrients excreted by the animals coupled with recycling of the excess nutrients in a manner that is not harmful to the environment. In the future, swine feed formulators must focus on optimizing swine performance while reducing or minimizing nutrient excretion. This review describes existing and emerging

technologies that would allow this goal to be achieved. Some individual technologies will have a greater impact on reduced nutrient excretion than others. Furthermore, employing these technologies together in an environmental nutrition approach to swine feeding has the potential to significantly reduce excess nutrients for disposal in swine production.



Literature Cited

1. Adeola, O. 1995. Digestive utilization of minerals by weanling pigs fed copper-and phytase-supplemented diets. *Can. J. Anim. Sci.* 75:603.
2. Adeola, O., B. V. Lawrence, A. L. Sutton, and T. R. Cline. 1995. Phytase-induced changes in mineral utilization in zinc-supplemented diets for pigs. *J. Anim. Sci.* 73:3384.
3. Apgar, G. A., and E. T. Kornegay. 1996. Mineral balance of finishing pigs fed copper sulfate or a copper lysine complex at growth stimulating levels. *J. Anim. Sci.* 74:1594.
4. ARC. 1981. The Nutrient Requirements for Farm Livestock. 3. Pigs. Agricultural Research Council, London, UK.
5. Baker, D. H. 1996. Advances in amino acid nutrition and metabolism of swine and poultry. In *Nutrient Management of Food Animals to Enhance and Protect the Environment*. E. T. Kornegay (Ed.). p 51. CRC Press, Inc., Boca Raton, FL.
6. Baker, H., and T. K. Chung. 1992. Ideal protein for swine and poultry. *Kyowa Hakko Technical Review-4*. Nutri-Quest Inc., Chesterfield, MO.
7. Barker, J. C., and J. P. Zublena. 1995. Livestock manure nutrient assessment in North Carolina. In *Proc. of 7th Int. Symp. on Agric. and Food Processing Wastes*. Sponsored by ASAE, Chicago, IL.
8. Batterham, E. S. 1994a. Ileal digestibilities of amino acids in feedstuffs for pigs. In *Amino Acids in Farm Animal Nutrition*. J.P.F. D'Mello (Ed.). p 113. CAB International, Wallingford, Oxon, UK.
9. Batterham, E. S. 1994b. Protein and energy relationships for growing pigs. In *Principles of Pig Science*. D.J.A. Cole, J. Wiseman, and M. A. Varley (Eds.). p 107. University Press, Nottingham, Oxon, UK.
10. Biehl, R. R., D. H. Baker, and H. F. DeLuca. 1995. 1-Hydroxylated cholecalciferol compounds act additively with microbial phytase to improve phosphorus, zinc and manganese in chicks fed soy-based diets. *J. Nutr.* 125:2407.
11. Bruce, J.A.M., and F. Sundstael. 1995. The effect of microbial phytase in diets for pigs on apparent ileal and faecal digestibility, pH and flow of digesta measurements in growing pigs fed a high-fibre diet. *Can. J. Anim. Sci.* 75:121.
12. Centraal Veevoederbureau (CVB). 1990. Revised table on available phosphorus in feedstuffs for pigs. Centraal Veevoederbureau, Lelystad, The Netherlands (in Dutch).
13. Centraal Veevoederbureau (CVB). 1991. Table of feedstuffs. Information about composition, digestibility and feeding value. Centraal Veevoederbureau, Lelystad, The Netherlands (in Dutch).
14. Chauvel, J., and R. Granier. 1996. Effet de l'alimentation multiphase sur la croissance et les rejets azotes du porc charcutier. *J. Rec. Porc. France* 28:249.
15. Coffey, M. T. 1992. An industry perspective on environmental and waste management issues: challenge for the feed industry. *Georgia Nutr. Conf.*, p 144. Athens, GA.
16. Combs, N. R., E. T. Kornegay, M. D. Lindemann, and D. R. Notter. 1991a. Calcium and phosphorus requirement of swine from weaning to market weight: 1. Development of response curves for performance. *J. Anim. Sci.* 69:673.
17. Combs, N. R., Kornegay, E. T., Lindemann, M. D., Notter, D. R., Wilson, J. H., and Mason, J. P. 1991b. Calcium and phosphorus requirement of swine from weaning to market weight: II. Development of response curves for bone criteria and comparison of bending and shear bone testing. *J. Anim. Sci.* 69:682.
18. Coppoolse, J., A. M. van Vuuren, J., Huisman, W.M.M.A. Janssen, A. W. Jongbloed, N. P. Lenis, P.C.M. Simons. 1990. Excretion of nitrogen, phosphorus and potassium by livestock, now and tomorrow. DLO, Wageningen, The Netherlands.
19. Council for Agricultural Science and Technology. 1995. Integrated Animal Waste Management Task Force Report No. 128. Council for Agricultural Science and Technology, Ames, IA.
20. Crenshaw, T. D., and J. C. Johanson. 1995. Nutritional strategies for waste reduction management: Minerals. In *New Horizons In Anim. Nutr. and Health*. J. B. Longenecker and J. W. Spears (Eds.). The Institute of Nutrition of the University of North Carolina, Chapel Hill, Nov. 7 and 8, Chapel Hill, NC.
21. Crenshaw, T. D., M. J. Gahl, K. P. Blemings, and N. J. Benevenga. 1994. Swine feeding programs optimum performance and economic considerations. In *Tenth Annual Carolina Swine Nutr. Conf.*, Nov. 10, p 21. Raleigh, NC.
22. Cromwell, G. L. 1989. An evaluation of the requirements and biological availability of calcium and phosphorus for swine. In *Feed Phosphates in Monogastric Nutrition*, Texasgulf Nutrition Symposium, May 23, Raleigh, NC.
23. Cromwell, G. L. 1994. Feeding strategies urged as techniques to decrease pollution from hog manure. *Feedstuffs*, July 25, p 9.
24. Cromwell, G. L., and R. D. Coffey. 1991. Phosphorus — a key essential nutrient, yet a possible major pollutant — its central role in animal nutrition. In *Biotechnology in the Feed Industry*. T. P. Lyons (Ed.). p 133. Alltech Technical Publications, Nicholasville, KY.
25. Cromwell, G. L., T. R. Cline, J. D. Crenshaw, T. D. Crenshaw, R. C. Ewan, C. R. Hamilton, A. J. Lewis, D. C. Mahan, E. R. Miller, J. E. Pettigrew, L. F. Tribble, and T. L. Veum. 1993a. The dietary protein and(or) lysine requirements of barrows and gilts. *J. Anim. Sci.* 71:1510.
26. Cromwell, G. L., R. D. Coffey, G. R. Parker, H. J. Monegue, and J. H. Randolph. 1995. Efficacy of a recombinant-derived phytase in improving the bioavailability of phosphorus in corn-soybean meal diets for pigs. *J. Anim. Sci.* 73:2000.
27. Cromwell, G. L., T. S. Stahly, R. D. Coffey, H. J. Monegue, and J. H. Randolph. 1993b. Efficacy of phytase in improving the bioavailability of phosphorus in soybean meal and corn-soybean meal diets for pigs. *J. Anim. Sci.* 71:1831.
28. de Lange, C.F.M. 1994. Formulation of diets to minimize the contribution of livestock to environmental pollution. *American Feed Industry Association Nutrition Council Symp.*, Nov. 10–11, St. Louis, MO.
29. Dungalhoef, M., M. Rodehutsord, H. Spiekers, and E. Pfeffer. 1994. Effects of supplemental microbial phytase on availability of phosphorus contained in maize, wheat and triticale to pigs. *Anim. Feed Sci. Technol.* 49:1.
30. Eeckhout, W., and M. De Paepe. 1992a. Influence d'une phytase microbienne sur la digestibilité apparente du phosphore d'aliments pour porcelets. *Rev. L'Agric.* 45:183.
31. Eeckhout, W. and M. De Paepe. 1992b. Phytase de ble, phytase microbienne et digestibilité apparente du phosphore d'un aliment simple pour porcelets. *Rev. L'Agric.* 45:195.
32. Everts, H. 1994. Nitrogen and energy metabolism of sows during several reproductive cycles in relation to nitrogen intake. *Doctoral Dissertation*, University of Wageningen, The Netherlands.
33. Fuller, M. F., R. MacWilliam, T. C. Wang, and L. R. Giles. 1989. The optimum dietary amino acid pattern for growing pigs. 2. Requirements for maintenance and for tissue protein accretion. *Br. J. Nutr.* 62:255.
34. Gahl, M. J., T. D. Crenshaw, and N. J. Benevenga. 1995. Diminishing returns in weight, nitrogen, and lysine gain of pigs fed six levels of lysine from three supplemental sources. *J. Anim. Sci.* 73:3177.

35. Hacker, R. R., and Z. Du. 1993. Livestock pollution and politics. In Nitrogen flow in pig production and environmental consequences. M.W.A. Versteegen, L. A. den Hartog, G.J.M. van Kempen, and C.J.H.M. Metz. EAAP Publ. 69. p 3. Pudoc Scientific Publishers, Wageningen, The Netherlands.
36. Harper, A. F. 1994. Feeding technologies to reduce excess nutrients in swine diets. In Proc. Meeting the Challenge of Environmental Management on Hog Farms. Second Annual Virginia Tech Swine Producers Seminar. August 4. p 44. Carson, VA.
37. Harper, A. F., E. T. Kornegay, and T. C. Schell. 1997. Phytase supplementation of low phosphorus growing-finishing pig diets improves performance, phosphorus digestibility and bone mineralization, and reduces phosphorus excretion. *J. Anim. Sci.* 75:(in press).
38. Heady, E. O., R. Woodworth, D. R. Catron, and G. C. Ashton. 1954. New procedures in estimating feed substitution rates and in determining economic efficiency in pork production. *Agric. Exp. Sta. Res. Bull.* p 893. Iowa State College, Ames, IA.
39. Helander, E. 1995. Efficiency of microbial phytases on phosphorus utilization in growing-finishing pigs. Doctoral Dissertation, University of Helsinki, Helsinki, Finland.
40. Henry, Y., and J. Y. Dourmad. 1992. Protein nutrition and N pollution. *Feed Mix.* (May):25.
41. Henry, Y., and J. Y. Dourmad. 1993. Feeding strategies for minimizing nitrogen outputs in pigs. In Nitrogen flow in pig production and environmental consequences. Proc. First Int. Symp. on Nitrogen flow in Pig Production and Environmental Consequences. EAAP Publication No. 69. p 137.
42. INRA. 1984. L'alimentation des animaux monogastriques, porc, lapin, volailles. Institut National De La Recherche Agronomique, Paris, France.
43. Jongbloed, A. W. 1991. Developments in the production and composition in manure from pigs and poultry. In *Mest & Milieu in 2000*. H.A.C. Verkerk (Ed.). Dienst Landbouwkundig Onderzoek, Wageningen, The Netherlands (in Dutch).
44. Jongbloed, A. W., P. A. Kemme, Z. Mroz, and R. ten Bruggencate. 1995a. Apparent total tract digestibility of organic matter, N, Ca, Mg, and P in growing pigs as affected by levels of Ca, microbial phytase and phytate. Proc. 2nd European Symp. on Feed Enzymes. p 198. Noordwijkerhout, The Netherlands.
45. Jongbloed, A. W., P. A. Kemme, Z. Mroz, M. Makinen, and A. K. Kies. 1995b. Effect of phytate, phytase and lactic acid on faecal digestibility of ash and some minerals in pigs. *Manipulating Pig Production V:191*.
46. Jongbloed, A. W., P. A. Kemme, and Z. Mroz. 1991. Effect of supplementary microbial phytase in diets for pigs on digestibility of P and phytic acid in different sections of the alimentary tract. *J. Anim. Sci.* 69(Suppl. 1):385.
47. Jongbloed, A. W., Z. Mroz, and P. A. Kemme. 1992. The effect of supplementary *Aspergillus niger* phytase in diets for pigs on concentration and apparent digestibility of dry matter, total phosphorus, and phytic acid in different sections of the alimentary tract. *J. Anim. Sci.* 70:1159.
48. Kemme, P. A., A. W. Jongbloed, Z. Mroz, and M. Makinen. 1995. Apparent ileal digestibility of protein and amino acids from a maize-soybean meal diet with or without extrinsic phytate and phytase in pigs. Abstract presented at the Int. Symp. on Nutr. Management of Food Animals to Enhance the Environment, June 4-7, Blacksburg, VA.
49. Kerr, B. J., and R. A. Easter. 1995. Effect of feeding reduced protein, amino acid supplemented diets on nitrogen and energy balance in grower pigs. *J. Anim. Sci.* 73:3000.
50. Kornegay, E. T. 1978a. Feeding value and digestibility of soybean hulls for swine. *J. Anim. Sci.* 47:1272.
51. Kornegay, E. T. 1978b. Protein digestibility of hydrolyzed hog hair meal for swine. *Anim. Feed Sci. Technol.* 3:323.
52. Kornegay, E. T. 1986. Calcium and phosphorus in swine nutrition. In *Calcium and Phosphorus in Swine Nutrition*. p 1. National Feed Ingredients Assoc., Des Moines, IA.
53. Kornegay, E. T. 1996. Nutritional, environmental and economical considerations for using phytase in pig and poultry diets. In *Nutrient Management of Food Animals to Enhance and Protect the Environment*. E. T. Kornegay (Ed.). p 277. CRC Press, Inc., Boca Raton, FL.
54. Kornegay, E. T. and B. Kite. 1983. Phosphorus in swine. VI. Utilization of nitrogen, calcium and performance of gravid gilts fed two dietary phosphorus levels for five parities. *J. Anim. Sci.* 57:1463.
55. Kornegay, E. T. and H. Qian. 1996. Replacement of inorganic phosphorus by microbial phytase for young pigs fed a corn soybean meal diet. *Br. J. Nutr.* 76:563.
56. Kornegay, E. T., M. R. Holland, K. E. Webb, Jr., K. P. Bovard, and J. D. Hedges. 1977. Nutrient characterization of swine fecal waste and utilization of these nutrients by swine. *J. Anim. Sci.* 44:608.
57. Kornegay, E. T., J. S. Radcliffe, and D. M. Denbow. 1996. Influence of Natuphos® Phytase on Calcium Bioavailability in Plant Ingredients and Development of Calcium Equivalency Values for Swine and Poultry. In *Phytase in Animal Nutrition and Waste Management*. M. B. Coelho and E. T. Kornegay (Eds.). p 419. BASF Corp., Mount Olive, NJ.
58. Lantzsich, H.-J. and W. Drochner. 1995. Efficacy of microbial phytase (A. Niger) on apparent absorption and retention of some minerals in breeding sows. Proc. 2nd European Symp. on Feed Enzymes. p 300. Noordwijkerhout, The Netherlands.
59. Latimer, P., and A. Pointillart. 1993. Effects of three levels of dietary phosphorus (.4, .5, .6% P) on performance, carcass, traits, bone mineralization and excreted phosphorus of growing-finishing swine. In 25th French Swine Days Report. 25:52.
60. Lei, X. G., P. Ku, E. R. Miller, D. E. Ullrey, and M. T. Yokoyama. 1993. Supplemental microbial phytase improves bioavailability of dietary zinc to weanling pigs. *J. Nutr.* 123:1117.
61. Lenis, N. P. 1992. Digestible amino acids for pigs. Assessment of requirements on ileal digestible basis. *Pig News and Information* 13, 31N.
62. Lindemann, M. D., E. T. Kornegay, and R. J. Moore. 1986. Digestibility and feeding value of peanut hulls for swine. *J. Anim. Sci.* 62:412.
63. Liu, J., D. W. Bollinger, D. R. Ledoux, and T. L. Veum. 1996. Effects of dietary calcium concentrations on performance and bone characteristics of growing-finishing pigs fed low phosphorus corn-soybean meal diets supplemented with microbial phytase. *J. Anim. Sci.* 74(Suppl. 1):180. (Abs.).
64. Moore, R. J., E. T. Kornegay, and M. D. Lindemann. 1986. Effect of salinomycin on nutrient absorption and retention by growing pigs fed corn-soybean meal diets with or without oat hulls or wheat bran. *Can. J. Anim. Sci.* 66:257.
65. Mueller, J. P., J. P. Zublena, M. H. Poore, J. C. Barker, and J. T. Green. 1994. Managing pasture and hay fields receiving nutrients from anaerobic swine waste lagoons, N.C. Cooperative Ext. Service, AG-506.
66. Näsi, M. 1990. Microbial phytase supplementation for improving availability of plant phosphorus in the diet of the growing pig. *J. Agric. Sci. Finl.* 62:435.
67. Näsi, M. and E. Helander. 1994. Effects of microbial phytase supplementation and soaking of barley-soybean meal on availability of plant phosphorus for growing pigs. *Sect. A. Anim. Sci. Acta Agric. Scand.* 44:79.
68. Näsi, J. M., J. T. Piironen, and K. H. Partanen. 1995. Interaction between phytase and acid phosphatase activities in degradation of phytates of maize and barley based pig diets. Proc. 2nd European Symp. on Feed Enzymes. p 219. Noordwijkerhout, The Netherlands.
69. NRC. 1988. Nutrient requirements of swine. (9th Rev. Ed.). National Research Council. National Academy Press, Washington, DC.
70. Overfield, J. J., J. Krug, and R. Adkins. 1986. Swine Nutrient Requirement Survey. A report prepared for the Swine Committee of the AFIA Nutrition Council.
71. Pallauf, V. J., D. Hohler, and G. Rimbach. 1992a. Effect of microbial phytase supplementation to a maize-soya-diet on the apparent absorption on Mg, Fe, Cu, Mn and Zn and parameters of Zn-status in piglets. *J. Anim. Physiol. Anim. Nutr.* 68:1.
72. Pallauf, V. J., D. Holer, G. Rimbach, and H. Neusser. 1992b. Effect of microbial phytase

- supplementation to a maize-soy-diet on the apparent absorption of phosphorus and calcium in piglets. *J. Anim. Physiol. a. Anim. Nutr.* 67:30.
73. Pallauf, J., G. Rimbach, S. Pippig, B. Schindler, and E. Most. 1994a. Effect of phytase supplementation to a phytate-rich diet based on wheat, barley and soya on the bioavailability of dietary phosphorus, calcium, magnesium, zinc and protein in piglets. *Agric. Res.* 47:39.
74. Pallauf, J., G. Rimbach, S. Pippig, B. Schindler, D. Hohler and E. Most. 1994b. Dietary effect of phytogenic phytase and an addition of microbial phytase to a diet based on field beans, wheat, peas and barley on the utilization of phosphorus, calcium, magnesium, zinc and protein in piglets. *Z. Ernährungswiss* 33:128.
75. Pierzynski, G. M., J. T. Sims, and G. F. Vance. 1994. *Soils and Environmental Quality*. Lewis Publishers, CRC Press, Boca Raton, FL.
76. Qian, H., E. T. Kornegay, and D. E. Conner, Jr. 1996. Adverse effects of wide calcium:phosphorus ratios on supplemental phytase efficacy for weanling pigs fed two dietary phosphorus levels. *J. Anim. Sci.* 74:1288.
77. Radcliffe, J. S., E. T. Kornegay, and D. E. Conner, Jr. 1995. The effect of phytase on calcium release in weanling pigs fed corn-soybean meal diets. *J. Anim. Sci.* 73(Suppl. 1):173.
78. SCA. 1987. *Feeding standards for Australian livestock*. V. Pigs. Editorial and publishing unit, CSIRO, East Melbourne, Australia.
79. Sharpley, A. N. 1995. Dependence of runoff phosphorus on extractable soil phosphorus. *J. Environ. Qual.* 24:920.
80. Sharpley, A. N., S. C. Chapra, R. Wedepohl, J. T. Sims, T. C. Daniel, and K. R. Reddy. 1994. Managing agricultural phosphorus for protection of surface waters: Issues and options. *J. Environ. Qual.* 23:437.
81. Sharpley, A. N., T. C. Daniel, and D. R. Edwards. 1993. Phosphorus movement in the landscape. *J. Prod. Agric.* 6:492.
82. Shih, B.-L., and A.-L. Hsu. 1997. Effects of dietary phytase supplementation on the growth performance, bone mechanical properties and phosphorus excretion of finishing pigs. *J. Taiwan Livestock Res.* 30 (In press).
83. Simons, P.C.M., H.A.J. Versteegh, A. W. Jongbloed, P. A. Kemme, P. Slump, K. D. Bos, M.G.E. Wolters, R. F. Beudeker, and G. J. Verschoor. 1990. Improvement of phosphorus availability by microbial phytase in broilers and pigs. *Br. J. Nutr.* 64:525.
84. Sims, J. T. 1993. Environmental soil testing for phosphorus. *J. Prod. Agric.* 6: 501.
85. Spears, J. W. 1996. Optimizing mineral levels and sources for farm animals. In *Nutrient Management of Food Animals to Enhance and Protect the Environment*. E. T. Kornegay (Ed.). p 259. CRC Press, Inc., Boca Raton, FL.
86. Sweeten, J. M. 1992. *Livestock and Poultry Waste Management: A National Overview*. In *National Livestock, Poultry and Aquaculture Waste Management*. J. Blake, J. Donald, and W. Magette (Ed.). p 4. Amer. Soc. Agric. Eng., St. Joseph, MI.
87. Swinkels, J.W.G.M., E. T. Kornegay, and M.W.A. Versteegen. 1994. Biology of zinc and biological value of dietary organic zinc complexes and chelates. *Nutr. Res. Rev.* 7:129.
88. Tanksley, T. D., Jr., and D. A. Knabe. 1984. Ileal digestibilities of amino acids in pig feeds and their use in formulating diets. In *Recent Advances in Animal Nutrition—1984*. p 75. Butterworths, London, UK.
89. Van der Honing, Y., A. W. Jongbloed, and N. P. Lenis, 1993. Nutrition management to reduce environmental pollution by pigs. VII World Conf. on Anim. Prod., Edmonton, AB, Canada. (Abs.).
90. Van Horn, H. H. 1992. Achieving environmental balance with manure and cropping systems. *Georgia Nutr. Conf.* p 110. Athens, GA.
91. Versteegen, M. 1995. Strategies in the Netherlands for animal waste reduction management. In *New Horizons in Animal Nutrition and Health*. J. B. Longenecker and J. W. Spears (Eds.). p 79. The Institute of Nutrition, The University of North Carolina, Chapel Hill, NC.
92. Veum, T. L. 1996a. Influence of high dietary calcium or calcium:phosphorus ratios on the effectiveness of microbial phytase for swine. In *Phytase in Animal Nutrition and Waste Management*. M. B. Coelho and E. T. Kornegay (Eds.). p 381. BASF Corp., Mount Olive, NJ.
93. Veum, T. L. 1996b. Use of microbial phytase in corn-soybean meal and grain sorghum-canola meal diets for growing-finishing swine. *Phytase in Animal Nutrition and Waste Management*. In M. B. Coelho and E. T. Kornegay (Eds.). p 365. BASF Corp., Mount Olive, NJ.
94. Viperman, P. E., E. R. Peo, and P. J. Cunningham. 1974. Effect of dietary calcium, phosphorus and nitrogen balance in swine. *J. Anim. Sci.* 38:758.
95. Walz, O. P., H. J. Ingelmann, and J. Pallauf. 1994. Digestibility and retention of protein and minerals during the fattening of pigs fed diets low in protein and phosphorus with supplementation of amino acids and phytase. In *VI International Symposium on Digestive Physiology in Pigs*. Bad Doberan, Proc., Vol. II:4.
96. Yi, Z., E. T. Kornegay, and D. M. Denbow. 1996a. Supplemental microbial phytase improves zinc utilization in broilers. *Poultry Sci.* 75: 540.
97. Yi, Z., E. T. Kornegay, and D. M. Denbow. 1996b. Effect of microbial phytase on nitrogen and amino acid digestibility and nitrogen retention of turkey poults fed corn-soybean diets. *Poultry Sci.* 75: 979.
98. Yi, Z., E. T. Kornegay, M. D. Lindemann, V. Ravindran, and J. H. Wilson. 1996c. Effectiveness of Natuphos® phytase in improving the bioavailabilities of phosphorus and other nutrients in soybean meal-based semipurified diets for young pigs. *J. Anim. Sci.* 74:1601.
99. Zhu, M., D. Bosch, and E. T. Kornegay. 1996. The potential impact of microbial phytase on poultry and swine manure disposal costs in the United States. II. Swine. *Virginia Tech Anim. and Poultry Sci. Res. Rpt.* 12:63.

Section L: Odor Control

RECOMMENDED STRATEGIES FOR ODOR CONTROL IN CONFINEMENT SWINE OPERATIONS

*Hans Stein¹, Alvaro Garcia², Kent Tjardes¹, Charles Ullery³,
Stephen Pohl³, and Christopher Schmit⁴*

¹Animal and Range Sciences Department, ²Dairy Science Department,
³Agricultural and Biosystems Engineering Department, and
⁴Civil and Environmental Engineering Department,
South Dakota State University, Brookings S.D.

Summary:

Odors coming off a swine facility are generated from three different sources: the unit itself, from the storage facility, or the land on which the manure is applied.

To reduce the total amount of odor generated from a swine facility, odor generation and emission by each of these three sources needs to be reduced. Within each area, several options for odor reduction are available. Practices that have been proven to be effective and that can be immediately implemented are listed in Table 1. Other options are being developed or tested. Research into these practices will reveal whether or not they can be successfully implemented in the future.

Table 1 is organized in four sections covering practices that:

1. reduce odor generation in barns,
2. reduce odor emission from facilities and storage units,
3. increase odor dispersion, and
4. reduce odor emission from manure application.

For each practice, advantages and disadvantages are listed. The effectiveness and the cost of implementing each practice is indicated using odor generation from a standard swine facility as a base line. This unit is assumed to be constructed using state-of-the-art recommendations including deep pits or an uncovered manure storage facility, curtain sidings or mechanical ventilation, and no dietary modifications to reduce odor generation.

To obtain an overall reduction in odors from a facility, reductions need to be made in odor generated by the unit itself, the storage facility, and from land application.

Some practices listed in Table 1 are best management practices (BMP). These are practices with well-documented beneficial effects on sustainability of a production system. Their implementation should be encouraged even without considering their potential for odor reduction.

The cost of each practice is indicated. A "low" cost is assumed to be less than \$0.50 per GF pig produced (\$1.25/Animal Unit); "moderate" is assumed to add \$0.50-\$1.50 per GF pig produced (\$1.25-3.75/Animal Unit), and "high" is assumed to add more than \$1.50 per GF pig produced (\$3.75/Animal Unit) to total production costs, as compared to the base line unit.

Conclusions and Recommendations

A number of practices are available to reduce odor from swine facilities. A reduction in odor coming off a swine facility is achieved only if the odors emitted by the unit itself, from the storage facility, and from the land application of the manure are reduced.

At this time, the following practices are recommended:

1. The odor from the unit itself can be reduced by a combination of dietary practices and the installation of a biofilter.
2. The odor from the storage facility can be reduced by installing an effective lagoon cover. In larger units this may be combined with a manure separator and (or) a methane digester.
3. The odor from the land application of manure can be reduced by injecting the manure into the soil.

Research into odor reduction is ongoing, and many new technologies are being developed. As independent research using these technologies becomes available, some of these technologies may prove to be even more effective than the ones listed in the table. SDSU swine research being conducted at the Southeast Research Farm near Beresford has demonstrated that biofilters reduce odor emissions from confined buildings by 96%.

Table 1: Odor Reduction Practices for Swine Operations

Section 1: Reduce generation of odor						
Practice	Description	Advantages	Disadvantages	Effectiveness	Cost	Comments
a. Low protein diets	Diets are lowered 3-4% in CP compared to NRC rec. Crystalline AA are added to diets so that AA levels follows NRC rec	Avoid overfeeding CP. Fewer problems with enteric diseases in pigs. Reduced N in manure, reduced ammonia emission	Reduced consumption of byproducts and alternative ingredients	Moderate	Low. (Sometimes the cost of LP diets are actually lower than regular diets)	Cost offset by increased productivity and more efficient nutrient use. Should be considered a BMP
b. Low sulfur diets	Diets using no micro-minerals on sulfate form and no excess sulfur containing AA	Reduced production of H ₂ S	Some restrictions apply to the mineral sources that can be used	Moderate	Low	Should be considered a BMP
c. Phase feeding	Diets are changed frequently during the production phases to match the nutrient requirement of the pigs	Overfeeding and underfeeding with nutrients can be reduced	More diets are required on the farm	Low	Low	Should be considered a BMP
d. Precision diet formulation	Diets are formulated based on digestible contents of amino acids and minerals and the net energy content of the diets. Also, the ideal protein concept is used in diet formulation	Diets that more precisely match the requirement of the animals can be formulated. Reduction of excess nutrients in diets and thus in manure	Research is needed to establish digestible contents of nutrients in feed ingredients and the animals requirements for digestible nutrients	Low	Low	At least 3-5 years of research needed before concept can be implemented
e. Pelleting diets	All diets used in the operation are pelleted prior to use	Reduces dust generation and decreases amount of feed wasted in the manure pit	None	Low	Low (\$10/ton for mixing, this cost offset by increased nutrient digestibility)	

Table 1. Odor reduction practices for swine operations (cont.)

Section 2: Decrease Emission of Odor						
Practice	Description	Advantages	Disadvantages	Effectiveness	Cost	Comments
a. Flush systems for manure removal	Removes manure frequently by flushing all the pits	Effective in reducing emission from pit	Increased labor, need for outside storage	Moderate	Moderate	
b. Pit systems w/ reduced manure surface	Sloped bottom of pits make sure manure surface is reduced	Reduces emission from pits	None	Moderate	Moderate	Usually combined with increased flushing
c. Oil spraying	Vegetable oil sprayed in facilities at regular intervals	Bound dust also odors present in the dust	More slicky surface	Moderate	Moderate	Reduces health risk for human workers in barns
d. Biofilters	Air exhausted through a biofilter made from organic material that captures the odors. Clean, odorless air is released.	Very effective. Simple to construct. Environmentally friendly	Building design. Aesthetics	High	Low to moderate	Odor reduced by 96% in SDSU research. Cannot be used with curtain-sided barns
e. Storage additives	Additives added to manure storage facility	Supposed to reduce odor generation	Not a proven technique	Low	High	Questionable technique
f. Rigid manure storage covers	Mechanical cover is applied to the manure storage unit	Very effective	Can be costly	High	High	
g. Flexible manure storage cover	Flexible material applied on top of storage facility. May be textile or plastic membrane or floating clay balls		Can cause problems when agitating manure, support structure may be needed	High	Moderate	Several different materials can be used
h. Biodegradable manure storage cover	Straw is applied on top of storage facilities	Inexpensive	Needs to be filled every three months. More difficult to agitate storage unit	Moderate	Low	Effectiveness highly dependent on how the cover is managed
i. Manure separators	Separates manure into a solid and a liquid fraction	Decreases odor generation from storage	Relatively expensive, only applicable to large operations	Moderate	High	More effective separators are available in Europe
k. Methane digesters	Treat waste with 3 to 10% total solids. Biogas methane production from manure	Manure treatment can decrease odor at application time. Generation of electricity can help pay for treatment costs	Costs: \$250,000 O + M = \$7,500/year Cost effectiveness dependent on contract with electrical company.	High	High	May be combined with manure separators

Table 1. Odor reduction practices for swine operations (cont.)

Section 3: Increase Dispersion of Odor						
Practice	Description	Advantages	Disadvantages	Effectiveness	Cost	Comments
a. Shelterbelts	Create a vegetation barrier for dust and odorous compounds emitted from the building exhaust	Cost. Environment. Aesthetics	Requires planning and time	Low	Low	
b. Windbreak walls	Solid or porous wall constructed 10 to 15 feet from the exhaust fans will cause dust to settle	Rapid implementation	Cost. Aesthetics	Low	Low to moderate	
c. Setback distances	Optimize distance between odor emission sources and urban areas.	Cost.	Not applicable for facilities currently in operation	High	Variable	Effectiveness can be calculated through the OFFSET model (Univ. of Minn.)

Section 4: Land Application of Manure						
Practice	Description	Advantages	Disadvantages	Effectiveness	Cost	Comments
a. Manure injection or incorporation	Manure injected directly into soil. Can be done in pasture or bare soil or into a growing crop	No emission of odors from manure when applied to soil	Takes more horsepower and more sophisticated equipment	Very high	Low	Should be considered a BMP

Section M: Waste Storage Pond Pumping
Plan

SECTION M. MANAGEMENT OF WASTE STORAGE PONDS

Waste Storage ponds are an efficient and practical means to collect and store manure effluent from a confined livestock farm. A properly designed pond must store, at a minimum 180 days of manure effluent including a 25 year 24 hour storm event. Waste storage ponds should never be full and always have sufficient storage for the next precipitation event.

Runoff collected from the livestock farm contains various amounts of manure nutrients, bacteria, and other materials. Every livestock operation is unique when taking into account the amount and intensity of different rainfall events, and number and species of animals.

Livestock operators have difficulty in dealing with the collected wastewater when there are larger than normal amounts of runoff. Operators can find themselves faced with full waste storage ponds and often less than ideal conditions for land applying or otherwise utilizing the wastewater.

Producers who operate a facility with a waste storage pond must be ready to handle emergency situations when the pond may become full or near overflowing. Eliminating pond overflows is a critical factor in reducing pollutants from entering streams and other water bodies.

Following are important recommendations to implement when operating a facility with a waste storage pond:

- Foremost, routinely monitor the level of the pond to assure there is enough storage remaining (plus freeboard) to hold the designed volume of a 25 year 24 hour storm event. This must Pumpdown level should be marked with a permanent depth gauge in the pond. If wastewater is above this line, the operator normally must pump the pond down below this level within 14 pump-able days.
- Plan ahead and develop a pumping plan. Identify specific fields and equipment needs for the pumping plan.
- Consider using cropping practices that will expand the “window of opportunity” for land application during the growing season. Decide on field access alternatives during wet weather conditions.
- Review and follow the Operation & Maintenance (O & M) guidelines provided with your manure management system design and constructions plans.
- Contact the Arkansas Department of Environmental Quality (501-682-7890) within 24 hours concerning a wastewater discharge.

Plan for Pumping Waste Storage Ponds

Operator Name C&H Hog Farms Date 05/25/2012

County Newton Pond ID or Legal Description Waste Storage Pond 1 & 2

- **Method Selected for Land Application of Wastewater**

- Pipeline/Sprinkler System (Permanent): *Waste Storage Pond 2*
- Big Gun Sprinkler (Temporary)
- Drag Hose System
- Tank Wagon: *Waste Storage Pond 1*
- Other (Explain)

- **Pre-Arranged Source of Application Equipment (List all necessary equipment and access to it).**

Type Equip.	Obtain Where
<u>Pump</u>	<u>Proposed to Field 5-9</u>
<u>Pipe</u>	<u>Proposed to Field 5-9</u>
<u>Sprinkler</u>	<u>Proposed to Field 5-9</u>
<u>Vac Tanker</u>	<u>Fields 1-4 and 10-17</u>

- **Fields Available for Land Application of Wastewater in an Emergency**

Legal Description	Landuse	Acres Available	Predom. Soil
<u>Sec. 26, T15N, R20W</u>	<u>Grass</u>	<u>74.3</u>	<u>48</u>

- **Holding Capacity of Ponds at Must Pumpdown Level 2,469,903 gallons**
Bottom of 25-year, 24-hour storage level. Pond is to be pumped within 10 days below level.

- **Holding Capacity of Ponds at High Water Line 3,495,464 gallons**
Top of 25-year, 24-hour storage level (bottom of freeboard)(Includes Concrete Pits).

- **Holding Capacity of Ponds between Freeboard and Must Pumpdown Elevation 35,564 gallons**
Bottom of freeboard- Must Pumpdown Elevation.

- **Application Rates**

The fertilizer value of wastewater in waste storage ponds is variable. Prior to land application, it is recommended to collect a representative sample from the pond and sent to a testing laboratory for analysis. If time does not permit waiting for test results, estimates of the nutrient content can be made from data previously collected at other facilities or from publications.

The land application rate should be calculated based on (1) the nutrient content of the wastewater, (2) current soil tests, (3) crop needs and (4) the water intake capacity (inches/hour) of the soil if an irrigation system is used.

For more information and/or assistance in calculating application rates, contact your local NRCS and Conservation District Office.

Section N: Record Keeping and Land
Application Log Forms

SECTION N. LAND APPLICATION LOG FORMS

The following log forms are enclosed:

1. Manure Source Details
2. Annual Report Form For Permitted Confined Animal Facilities
3. Previous Manure Applications and Nitrogen Credits
4. Calculating Residual/Supplemental Nitrogen Amounts
5. Fertilizer Recommendations and Crop Requirements
6. Determining the Manure Application Rate
7. Animal Waste Land Application Record For Permitted Confined Animal Facilities

Recordkeeping

Keeping records plays a critical role in a manure management system. Records are essential to determine appropriate rates of manure to apply to the land while protecting surface and groundwater resources. It enables operators to make good annual and long-term decisions concerning efficient use of manure. Additionally, records serve to document compliance with regulations or voluntary adoption of best management practices.

Records should be maintained for five years or as otherwise instructed by specific federal and state laws, local county ordinances and/or program requirements.

At a minimum, track manure applications by collecting and keeping records of the following information:

- **Soil test results and recommendations for all fields receiving manure (sampled and tested prior to hauling manure).**
- **Manure test results.**
- **Identity of the fields hauled to (including acres spread on and where in the field).**
- **Calculated "planned" manure application rate per field.**
- **Calculated "actual" manure application rate per field.**
- **Method of manure application.**
- **Date(s) and time(s) of manure application.**

The following additional records are recommended if the goal is to implement a whole farm nutrient budget program:

- **Soil test results and recommendations for the remaining fields receiving nutrients from other sources (i.e. commercial fertilizer).**
- **Form/rates of other nutrient sources applied per field.**
- **Crop planting and harvest dates and yields per field.**

Soil testing on a whole farm basis provides fertility level information on all fields allowing operators to make decisions as to where manure nutrients can best be utilized.

The Manure Nitrogen and Phosphorus Application Worksheets provided with this plan serve as excellent recordkeeping tools to document test results and manure applications.

Manure source details

Storage identification _____

Manure form (solid/liquid) _____

Year	Manure Analysis						Sample ID/Date	Estimated Volume to be Spread ton or gal	Actual Volume Spread ton or gal
	Total N	Organic N	Ammonium N	P2O5	K2O	% Moisture Content			
	lb/ton, or lb/1000 gal								
CALCULATION/ REFERENCE:		(1)-(3)	(1)-(2)						AE-1188
COLUMN:	(1)	(2)	(3)	(4)	(5)	(6)	(7)	(8)	(9)

ARKANSAS DEPARTMENT OF ENVIRONMENTAL QUALITY

ANNUAL REPORT FORM FOR PERMITTED CONFINED ANIMAL FACILITIES

REPORTING PERIOD: _____

PERMITTEE NAME: _____ PERMIT NUMBER: _____

PHONE NUMBER: _____ AFIN NUMBER: _____

FACILITY TYPE AND SIZE: _____
(ie., 200 Cow Dairy, 2,500 Swine Finishing, 80,000 Bird Layer Operation, etc.)

WASTE DISPOSAL SYSTEM CONSISTS OF: _____
(ie., Holding Pond, Holding Pond & Settling Basin, Concrete Holding Tank, etc.)

WASTE APPLICATION METHOD: _____
(ie., Tank Spreader, Irrigation System, etc.)

NO. OF APPLICATION FIELDS: _____

TOTAL AVAILABLE ACREAGE: _____

WASTEWATER SAMPLE LOCATION: _____
(Lagoon During Pumping or Field During Application)

YOU MUST SUBMIT A COPY OF THE **WASTEWATER ANALYSIS** FOR EACH SAMPLE PROVIDED TO THE COOPERATIVE EXTENSION SERVICE OR A PRIVATE LAB. THE WASTEWATER ANALYSIS MUST INCLUDE: pH (su), TOTAL NITROGEN, AMMONIA NITROGEN, TOTAL POTASSIUM, TOTAL PHOSPHORUS, AND PERCENT SOLIDS.

IN ADDITION, YOU MUST SUBMIT A COPY OF THE **SOIL ANALYSIS** FOR EACH FIELD WITH THIS FORM. THE SOIL ANALYSIS MUST INCLUDE: pH (su), POTASSIUM (lbs/ac), PHOSPHORUS (lbs/ac), AND NITRATES (lbs/ac). AT LEAST ONE SOIL ANALYSIS SHOULD BE DONE FOR EACH 30 ACRE TRACT.

PLEASE COMPLETE THE TABLE ON THE BACK FOR THE LAND APPLICATION REPORT. YOU MUST SIGN AND DATE THIS REPORT AND SUBMIT IT TO THE DEPARTMENT PRIOR TO MAY 30th OF EACH YEAR. PLEASE KEEP A COPY OF THIS REPORT, THE SOIL ANALYSIS, AND THE WASTEWATER ANALYSIS FOR YOUR RECORD AT THE FACILITY.

I CERTIFY UNDER PENALTY OF LAW THAT I HAVE EXAMINED AND AM FAMILIAR WITH THE INFORMATION SUBMITTED HEREIN AND BASED ON MY INQUIRY OF THOSE INDIVIDUALS IMMEDIATELY RESPONSIBLE FOR OBTAINING THE INFORMATION, I BELIEVE THE SUBMITTED INFORMATION IS TRUE, ACCURATE AND COMPLETE. I AM AWARE THAT THERE ARE SIGNIFICANT PENALTIES FOR SUBMITTING FALSE INFORMATION.

OWNER OR OPERATOR (Please Print)

SIGNATURE

DATE

Mail complete annual report form and annual application report to:

Arkansas Department of Environmental Quality
Permits Branch, Water Division
5301 Northshore Drive
North Little Rock, AR 72118

Previous manure applications and nitrogen credits.

Date / /

Field	Nitrogen credit from application before last season's crop				Nitrogen credit from application before crop 2 seasons ago				Previous Manure Credit (PMC) lb/a
	Manure N Analysis lb/ton or lb/1000 gal	Application Rate ton/a or 1000 gal/a	% Available (Year 2)	N Credit lb/a	Manure N Analysis lb/ton or lb/1000 gal	Application Rate ton/a or 1000 gal/a	% Available (Year 3)	N Credit lb/a	
CALCULATION/ REFERENCE:	AE-1189 SHEET 1, COL 1	AE-1189 SHEET 2, COL 4	TABLE 2	(1)x(2)x(3)/100	AE-1189 SHEET 1, COL 1	AE-1189 SHEET 2, COL 4	TABLE 2	(5)x(6)x(7)/100	(4)+(8)
COLUMN:	(1)	(2)	(3)	(4)	(5)	(6)	(7)	(8)	(9)

Fertilizer recommendations and crop requirements.

Date / /

Field	Crop	Target Yield	Nitrogen Requirement	Soil Test Nitrogen (STN)	Sampling Date Adjustment (SDA)	Previous Crop Credits (PCC)	Previous Manure Credit (PMC)	Nutrient Requirements		
		bu/a, ton/a or lb/a	lb/a	lb/a	lb/a	lb/a	lb/a	Net N	P2O5	K2O
								lb/a		
CALCULATION/REFERENCE:			SF 882	SF 882	SF 882	SF 882	SHEET 1, COL 9	(3)- [(4)+(5)+6)+(7)]	SF 882 or TABLE 4	SF 882 or TABLE 4
COLUMN:	(1)	(2)	(3)	(4)	(5)	(6)	(7)	(8)	(9)	(10)

Determining the manure application rate.

Date / /

Field	Nutrient Requirement			Estimated Manure Analysis			% Availability			Nutrient Available			Target Manure Application Rate		
	N	P2O5	K2O	N	P2O5	K2O	N	P2O5	K2O	N	P2O5	K2O	N	P2O5	K2O
	lb/a			lb/ton, or lb/1000 gal			%			lb/ton, or lb/1000 gal			ton/a, or lb/1000 gal		
CALCULATION/ REFERENCE:	SHEET 2, COL. 8	SHEET 2, COL. 9	SHEET 2, COL. 10	AE-1189 SHEET 1, COL. 1	AE-1189 SHEET 1, COL. 4	AE-1189 SHEET 1, COL. 5	TABLE 2	TABLE 3	TABLE 3	(4)X(7) /100	(5)X(8) /100	(6)X(9) /100	(1)/(10)	(2)/(11)	(3)/(12)
COLUMN:	(1)	(2)	(3)	(4)	(5)	(6)	(7)	(8)	(9)	(10)	(11)	(12)	(13)	(14)	(15)

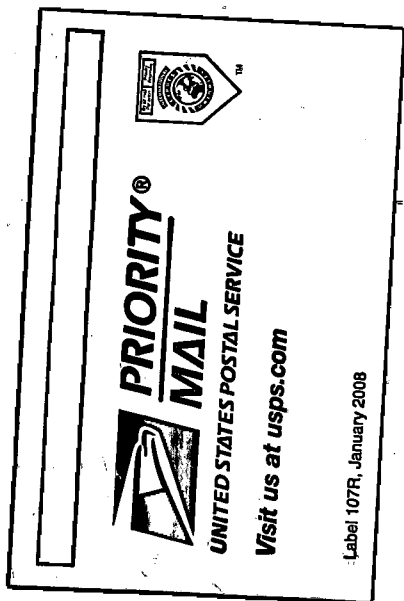

DeHaan, Grabs & Associates, LLC
PO Box 522
Mandan ND 58554



Richard McConnell
Arkansas Dept of Env Quality
5301 Northshore Drive
North Little Rock AR 72118-5317

